



Ground Water Issue

Design Guidelines for Conventional Pump-and-Treat Systems

Robert M. Cohen¹, James W. Mercer¹, Robert M. Greenwald¹, and Milovan S. Beljin²

The RCRA/Superfund Ground-Water Forum is a group of scientists representing EPA's Regional Superfund Offices, committed to the identification and resolution of ground-water issues affecting the remediation of Superfund sites. Design of conventional ground-water extraction and injection (i.e., pump-and-treat) systems has been identified by the Forum as an issue of concern to decision makers. This issue paper focuses on design of conventional ground-water extraction and injection systems used in subsurface remediation.

For further information contact Steve Acree (405) 436-8609 or Randall Ross (405) 436-8611 at the Subsurface Remediation and Protection Division of the National Risk Management Research Laboratory, Ada, Oklahoma.

Introduction

Containment and cleanup of contaminated ground water are among the primary objectives of the CERCLA (Comprehensive Environmental Response, Compensation, and Liability Act; also known as Superfund) and RCRA (Resource Conservation and Recovery Act) remediation programs. Ground-water contamination problems are pervasive in both programs; over 85 percent of CERCLA National Priority List sites and a substantial portion of RCRA facilities have some degree of ground-water contamination (U.S. EPA, 1993a). A common approach to deal with contaminated ground water is to extract the contaminated water and treat it at the surface prior to discharge or reinjection as illustrated in Figure 1. This is referred to as conventional pump-and-treat (P&T) remediation.

Conventional pump-and-treat is an applicable component of many remedial systems. However, such a system will not be appropriate to achieve restoration in portions of many sites due to hydrogeologic and contaminant-related limitations such as

those presented by significant accumulations of DNAPLs (denser-than-water nonaqueous phase liquids) trapped below the water table. Such limitations will directly impact the effectiveness of P&T at many sites and the selection of remedial actions. Detailed discussion of the contaminant transport and fate processes that limit the potential for subsurface restoration using P&T and their characterization is beyond the scope of this document.

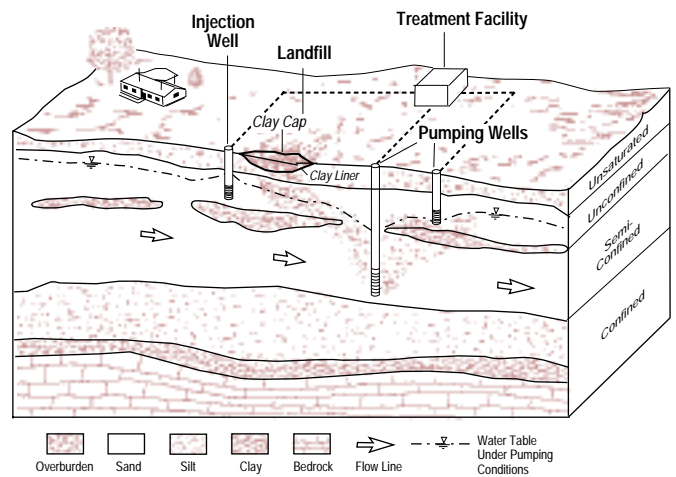

Figure 1. Example of a P&T system (after Mercer et al., 1990).

¹ GeoTrans, Inc., Sterling, VA
² National Risk Management Research Laboratory, Office of Research and Development, U.S. EPA, Ada, OK



Superfund Technology Support Center for Ground Water

National Risk Management Research Laboratory
Subsurface Protection and Remediation Division
Robert S. Kerr Environmental Research Center
Ada, Oklahoma

Technology Innovation Office
Office of Solid Waste and Emergency
Response, US EPA, Washington, DC

Walter W. Kovalick, Jr., Ph.D.
Director

Inadequate design and implementation also may severely impact the performance of a P&T system. Examples of design inadequacies include too few recovery wells, insufficient pumping rates, deficient well locations or completion intervals, and failure to account for complex chemistry of contaminants. Similarly, poor system operation, exemplified by excessive downtime or failure to manipulate pumping schemes to limit ground-water stagnation, will restrict P&T effectiveness. This document provides guidance on designing conventional ground-water P&T systems. Chemical enhancements to P&T and immiscible contaminant recovery methods are addressed elsewhere (e.g., American Petroleum Institute, 1989, 1992; Palmer and Fish, 1992; U.S. EPA, 1992a, 1995; Grubb and Sitar, 1994; NRC, 1994).

P&T Remediation Strategies

In order to determine an appropriate strategy to manage contaminated ground water, it is necessary first to evaluate site conditions and define remediation goals. Historically, the goal of ground-water remediation has been to protect human health and the environment and to restore ground water to beneficial uses where practicable. For ground water that is or may be used for drinking, clean-up goals under CERCLA and RCRA generally are set at drinking water standards such as Maximum Contaminant Levels (MCLs) established under the Safe Drinking Water Act. Other clean-up requirements may be appropriate for ground water that is not used for drinking.

It has long been recognized that chemical transport from contaminant source/release areas, such as abandoned landfills and leaking tanks, contaminates ground water and other media in downgradient areas (e.g., OTA, 1984). As such, a common strategy for managing contaminated ground water has been to remove or contain contaminant sources (e.g., by excavation, construction of physical barriers, and/or pumping) and to address downgradient contamination using P&T technology.

Strategies for managing ground-water contamination (Figure 2) using P&T technology include: (1) hydraulic/physical containment, (2) ground-water quality restoration, and (3) mixed objective strategies. Several innovative technologies, such as air sparging, engineered bioremediation, and permeable treatment walls, can be used in conjunction with P&T, or alone, to address these ground-water remediation objectives. At some sites, natural attenuation processes may limit the need for P&T. The management strategy selected depends on site-specific hydrogeologic and contaminant conditions, and remediation goals.

Hydraulic Containment

P&T systems are frequently designed to hydraulically control the movement of contaminated ground water in order to prevent continued expansion of the contamination zone. At sites where the contaminant source cannot be removed (e.g., a landfill or bedrock with DNAPLs), hydraulic containment is an option to achieve source control. Hydraulic containment of dissolved contaminants by pumping ground water from wells or drains has been demonstrated at numerous sites. The concept is illustrated in Figure 3. Properly controlled fluid injection using wells, drains, or surface application (e.g., along the downgradient periphery of the proposed containment area) and physical containment options (e.g., subsurface barrier walls and surface covers to limit inflow) can enhance hydraulic containment

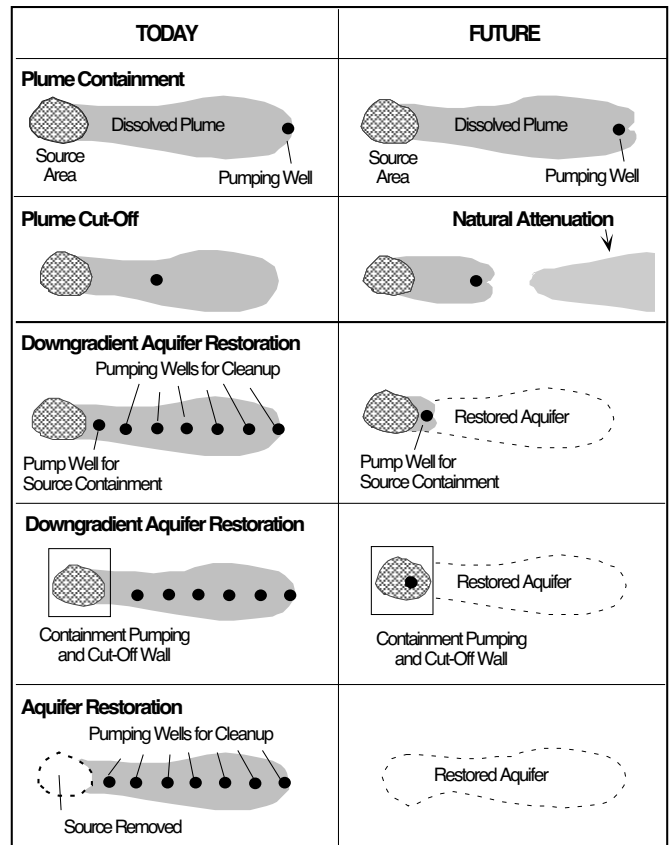

Figure 2. Several ground-water contamination management strategies using P&T technology (after NRC, 1994; Cherry et al., 1992).

systems by reducing the pumping rate required to maintain containment. In many cases, hydraulic containment systems are designed to provide long-term containment of contaminated ground water or source areas at the lowest cost by optimizing well, drain, surface cover, and/or cutoff wall locations and by minimizing pumping rates.

Cleanup/Restoration

For sites where the contaminant source has been removed or contained, it may be possible to clean up the dissolved plume. P&T technology designed for aquifer restoration generally combines hydraulic containment with more aggressive manipulation of ground water (i.e., higher pumping rates) to attain clean-up goals during a finite period. Ground-water cleanup is typically much more difficult to achieve than hydraulic containment. Hydrogeologic and contaminant conditions favorable to cleanup (e.g., degradable dissolved contaminants in uniform, permeable media) are summarized in Figure 4.

Mixed Objective Strategies

At many sites, P&T systems can be used to contain contaminant source areas and attempt restoration of downgradient dissolved plumes (Figure 2). A mixed P&T strategy is appropriate, therefore, at sites where different portions of the contaminated

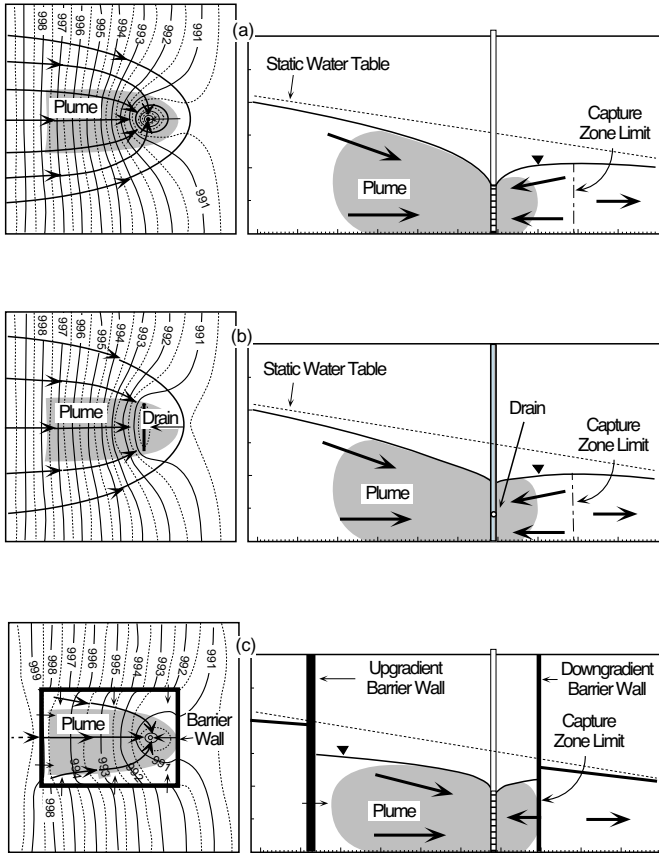

Figure 3. Examples of hydraulic containment in plan view and cross section using an extraction well (a), a drain (b), and a well within a barrier wall (c).

region are amenable to remediation using different methods. At sites contaminated with LNAPLs (lighter-than-water NAPLs), for example, a mixed remedial strategy may include: (1) vacuum-enhanced pumping to recover free product, affect hydraulic containment, and stimulate bioremediation in the LNAPL release area; and (2) restoring downgradient ground water via natural attenuation, P&T, and/or air sparging.

Characterizing Sites for P&T Design

The main goal of site characterization should be to obtain sufficient data to select and design a remedy (NRC, 1994). This is accomplished by investigating: (1) the nature, extent, and distribution of contaminants in source areas and downgradient plumes; (2) potential receptors and risks posed by contaminated ground water; and (3) hydrogeologic and contaminant properties that affect containment, restoration, and system design in different site areas. Categories of data used to formulate a site conceptual model for remedy evaluation are identified in Figure 5. The conceptual model is used to formulate remedial strategies such as restoration and/or containment.

Inadequate site characterization can lead to flawed P&T design and poor system performance. A complete understanding of a contamination site is unobtainable, however, due to subsurface complexities and investigation cost. Thus, characterization

efforts must develop sufficient data to select and design an effective remedy while recognizing that significant uncertainties about subsurface conditions will persist.

Site characterization for remedial design is an extensive subject, key aspects of which are addressed briefly below. Additional information regarding procedures and strategies for investigating contamination sites is provided by U.S. EPA (1988a, 1991a, 1993b), Nielsen (1991), Cohen and Mercer (1993), Sara (1994), CCME (1994), and Boulding (1995).

Using a Phased and Integrated Approach

Due to slow contaminant transport and interphase transfer, many P&T systems will operate for decades to contain and clean up contaminated ground water. Data collected during investigation and remediation should be reviewed periodically to refine the site conceptual model and identify modifications that will improve P&T system performance. Thus, as depicted in Figure 6, a phased and integrated approach should be taken to site characterization and remediation. For example, given significant uncertainty regarding well locations and pumping rates needed to achieve remedial objectives, it may be prudent to initiate pumping at several locations and then determine system expansion requirements based on performance monitoring data. This phased approach to system installation may be more cost effective than grossly overdesigning the system to account for uncertainty in subsurface characterization at many sites.

During the initial phase of site investigation, prior studies and background information are reviewed to identify likely

CONTAMINANT AND HYDROGEOLOGIC CHARACTERISTICS	GENERALIZED RESTORATION DIFFICULTY SCALE	
	— Increasing Difficulty —>	
SITE USE		
Nature of Release	Small volume Short duration Slug release	Large volume Long duration Continual
CONTAMINANT PROPERTIES		
Biotic/Abiotic Decay Potential	High	Low
Volatility	High	Low
Contaminant Sorption Potential	Low	High
CONTAMINANT DISTRIBUTION		
Contaminant Phase	Aqueous, Gaseous	LNAPL → DNAPL
Volume of Contaminated Media	Small	Large
Contaminant Depth	Shallow	Deep
GEOLOGIC CONDITIONS		
Stratigraphy	Simple	Complex
Unconsolidated Media Texture	Coarse-grained	Fine-grained
Degree of Heterogeneity	Low	High
GROUNDWATER FLOW PARAMETERS		
Hydraulic Conductivity	High (>0.01 cm/s)	Low (<0.0001 cm/s)
Temporal Variation	Little	High
Vertical Flow	Little	High downward

Figure 4. Generalized ground-water restoration difficulty scale (modified from U.S. EPA, 1993a).

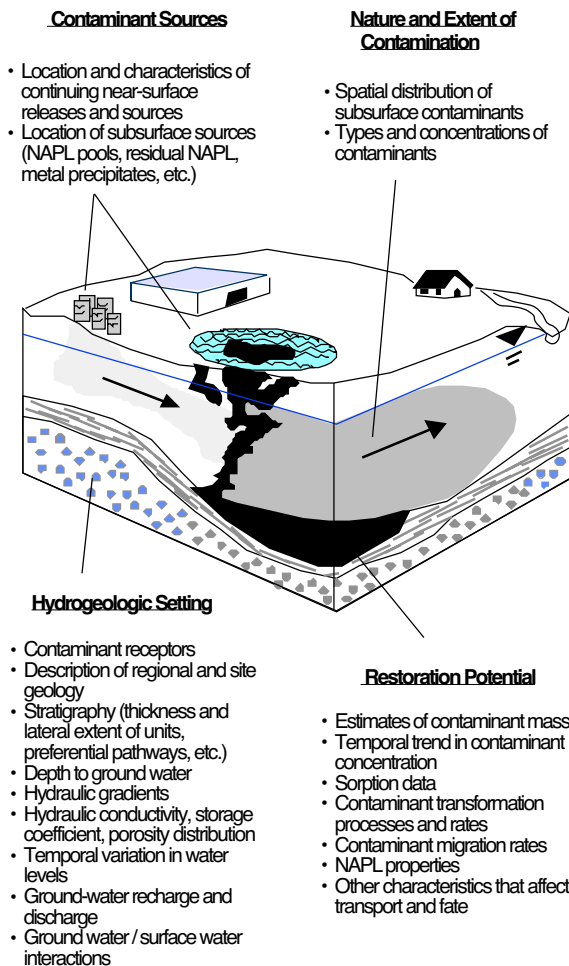

Figure 5. Types of data used to develop a site conceptual model for remedy assessment (modified from U.S. EPA, 1993a).

contaminant sources, transport pathways, and receptors. Based on this initial conceptualization, a data collection program is devised to better define the nature and extent of contamination and provide information (i.e., hydraulic conductivity distribution, aquifer boundary conditions, and initial hydraulic gradients) for remedy design. Contaminant source and downgradient dissolved plume areas should be delineated early during the characterization process to clarify site management strategies. P&T systems can often be designed to contain source and downgradient plume areas based on data acquired during the early and intermediate phases of investigation. Additional studies, including monitoring of actual P&T performance, are usually required, however, to assess the potential to restore ground-water quality in different site areas.

Mathematical models representing aspects of the site conceptual model should be used to evaluate alternative extraction/injection schemes, perform sensitivity analysis, and identify additional data needs. Integrating P&T operation and monitoring data can lead to model refinements and design enhancements.

P&T performance is typically assessed by measuring hydraulic heads and gradients, ground-water flow directions and rates,

pumping rates, pumped water and treatment system effluent quality, and contaminant distributions in ground water and porous media. Guidance on methods for monitoring P&T performance is provided by Cohen et al. (1994). Careful examination of system performance, considering transient effects, is commonly warranted during the first months after start-up, and after subsequent major changes to P&T operation. Remediation, therefore, should be considered part of site characterization, yielding data that may lead to improved P&T system design and operation.

In recognition of inherent uncertainty and the potential for phased remediation, a reasonable degree of flexibility should be incorporated in P&T design to accommodate modifications. This may involve overdesign of certain system components (e.g., pipe or electric wire size), use of modular equipment (e.g., package treatment units), and strategic placement of junction boxes. Overdesign may allow system modifications such as

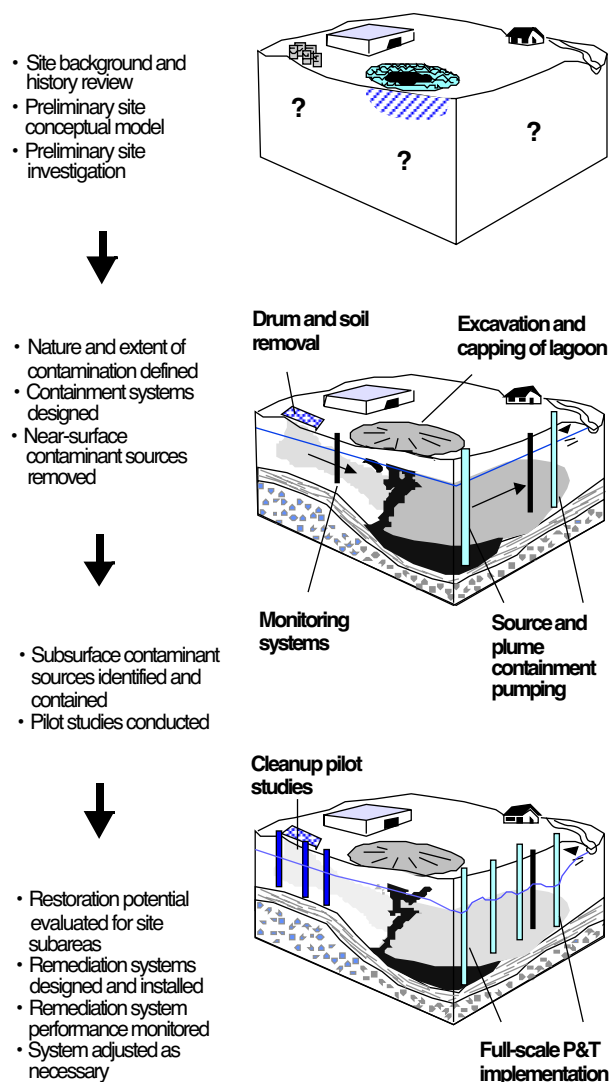

Figure 6. Iterative phases of site characterization and remediation (modified from U.S. EPA, 1993a; NRC, 1994).

incorporation of additional extraction wells or higher flow rates at relatively minimal expense. The degree of overdesign required as a contingency for uncertainties in subsurface conditions will be site specific and largely dependent on the level of site characterization performed prior to design. Estimates of potential ranges of required flowrates may be obtained at many sites during design-stage ground-water flow modeling.

Contaminant Characterization

Contaminant characterization is a key element of remedial evaluations. The nature, distribution, and extent of contamination will influence the selection of remedial actions and specific system designs. Contaminant characterization data needed to select and design a P&T system are listed in Figure 5. Important goals include: (1) delineating contaminant source areas and release characteristics; (2) defining the nature and extent (horizontal and vertical) of contamination; (3) characterizing contaminant transport pathways, processes, and rates; (4) estimating risks associated with contaminant transport; and (5) assessing aquifer restoration potential (see below). Contaminant characterization efforts generally involve document review, indirect and direct field characterization methods (e.g., soil, soil gas analysis and ground-water sampling), and data analysis.

Assessing Potential Limitations to P&T

Monitoring contaminant concentrations in ground water with time at P&T sites often reveals “tailing” and “rebound” phenomena. “Tailing” refers to the progressively slower rate of dissolved contaminant concentration decline observed with continued operation of a P&T system (Figures 7 and 8). The tailing contaminant concentration may exceed clean-up standards. Another problem is that dissolved contaminant concentrations may “rebound” if pumping is discontinued after temporarily attaining a clean-up standard (Figure 7).

If aquifer restoration is a potential remediation goal, then site characterization should investigate the physical and chemical phenomena that cause tailing and rebound. At many sites, most of the contaminant mass is not dissolved in ground water, but is present as NAPL, adsorbed species, and solids. Slow mass transfer of contaminants from these phases to ground water

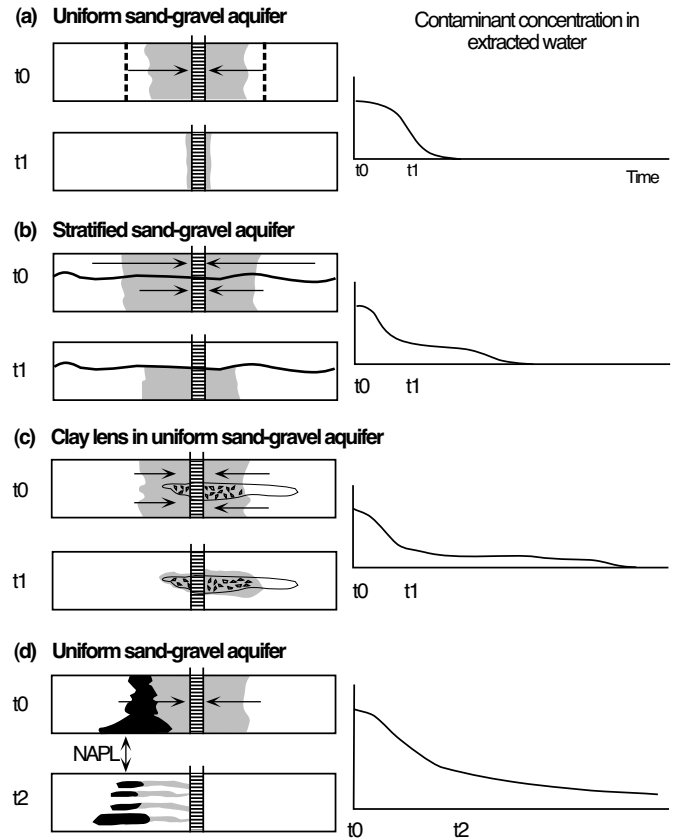

Figure 8. Hypothetical examples of contaminant removal using P&T (modified from Mackay and Cherry, 1989). Black indicates NAPL; stippling indicates contaminant in dissolved and sorbed phases (with uniform initial distribution); and arrows indicate relative ground-water velocity. Ground water is pumped from the well at the same rate for each case. The dotted lines in (a) represent the volume of water that would have to be pumped to flush slightly retarded contaminants from the uniform aquifer.

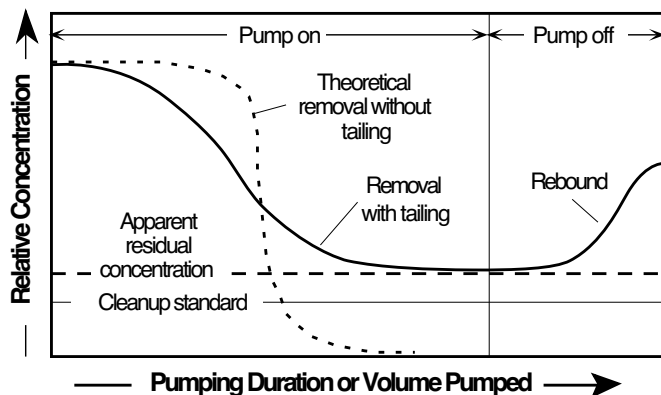

Figure 7. Concentration versus pumping duration or volume showing tailing and rebound effects (modified from Keely, 1989).

during P&T will cause tailing and prolong the clean-up effort. Physical causes of tailing include ground-water velocity and flowpath variations, and the slow diffusion of contaminants from low permeability zones during P&T operation. These phenomena are briefly discussed in Appendix A.

Tailing and rebound patterns associated with different physical and chemical processes are similar. Multiple processes (i.e., dissolution, diffusion, and desorption) will typically be active at a P&T site. Diagnosis of the cause of tailing and rebound, therefore, requires careful consideration of site conditions and usually cannot be made by examining concentration-versus-time data alone. Quantitative development of the conceptual model using analytical or numerical methods may help estimate the relative significance of different processes that cause tailing and rebound. Knowledge of the potential limitations at each site may allow more detailed analyses of the potential effectiveness of different P&T remediation strategies and different system configurations.

Hydrogeologic Characterization

Components of hydrogeologic investigation needed for P&T design are listed in Figure 5. Care must be taken to avoid exacerbating the contamination problem as a result of field work (e.g., inducing unwanted migration via drilling or pumping), or performing investigations not needed for risk or remedy assessment. Characterizing ground-water flow and contaminant transport is particularly challenging in heterogeneous media, especially where contaminants have migrated into fractured rock. Methods for characterizing fractured rock settings include drilling/coring, aquifer tests, packer tests, tracer tests, surface and borehole geophysical surveys, borehole flowmeter surveys, and air photograph fracture trace analysis (Sara, 1994). At the scale of many contaminated sites, complete characterization of fractured rock (and other heterogeneous media) may be economically infeasible (Schmelling and Ross, 1989), and not needed to design an effective P&T system (NRC, 1994). The appropriate characterization methods and level-of-effort must be determined on a site-specific basis.

Long-term aquifer tests and phased-system installations are often cost-effective means for acquiring field-scale hydrogeologic and remedial design data. Aquifer tests should be conducted to acquire field-scale measurements of hydrogeologic properties, such as formation transmissivity and storage coefficient, that are critical to extraction system design. Test results are used to: (1) determine well pumping rates and drawdowns; (2) assess well locations and pumping rates needed for full-scale operation; (3) evaluate the design of well and treatment system components; and (4) estimate capital and O&M costs. Recommended procedures for conducting aquifer tests are described by Osborne (1993) and others.

The number and duration of tests required to obtain sufficient data to design a P&T system depends on many factors, including plume size, the distribution of hydrogeologic units, their hydraulic properties, and hydrogeologic boundary conditions. In general, multiple tests are warranted at large and heterogeneous sites. Test design parameters (including specification of observation well locations, test duration, and pumping rate) can be assessed using well hydraulics solutions, ground-water flow models, and/or by conducting short-term step tests.

Observation wells should be located close enough to the pumping well to ensure adequate responses to pumping stress. Drawdowns will depend on site-specific hydrologic conditions that influence ground-water elevations during the test. Wells should also be located so that data may be used to evaluate heterogeneity and anisotropy, if warranted.

Although reasonable estimates of formation transmissivity can generally be obtained using data acquired during the first several hours of pumping (if observation wells are close to the pumping well), it may be advisable to extend aquifer tests to days or weeks to evaluate capture zones, boundary conditions, and ground-water treatability issues. Slug tests can also be used to augment aquifer test results. However, short-term aquifer and slug tests generally are not as reliable indicators of system performance as long-term aquifer tests.

Disposal options for aquifer test water are subject to site conditions and regulations but may include: discharge to a storm or sanitary sewer, discharge to the ground, discharge to

surface water, reinjection to the subsurface, and transport to an off-site disposal facility. Regulatory agencies should be contacted to determine disposal requirements.

Ground-Water Treatability Studies

Treatability data needed for design of ground-water treatment systems generally should be acquired by conducting chemical analyses and treatability studies on contaminated ground water extracted during aquifer tests. Analysis of water samples obtained at different times during an aquifer test often will provide data regarding the initial range of contaminant concentrations in influent water to the treatment plant. Bench- and pilot-scale treatability studies are valuable means for determining the feasibility of candidate processes for treating contaminated ground water (U.S. EPA, 1989, 1994a). Laboratory bench-scale tests use small quantities of extracted ground water to provide preliminary data on various treatment processes, pretreatment requirements, and potential costs. During pilot-scale tests, skid-mounted or mobile pilot equipment is operated to study the effect of varying system parameters (e.g., flow rate) on treatment results and to identify potential problems, such as chemical precipitation of dissolved iron (Fe) and manganese (Mn) in an air stripper.

Air stripping and granular activated carbon (GAC) units may be used to remove organic compounds from ground water during aquifer tests; ion exchange/adsorption can be used to remove most metals (U.S. EPA, 1996). Air stripping is generally more cost-effective than GAC for treating volatile organic compounds when flow rates exceed 3 gpm (Long, 1993), but may require additional vapor phase treatment.

Potential for Fluid Injection

Artificial fluid injection/recharge is used to enhance hydraulic control and flushing of contamination zones. Treatment plant effluent or public supply water can be injected above or below the water table via wells, trenches, drains, or surface application (sprinkler, furrow, or basin infiltration). The applied water can be amended to stimulate bioremediation or to minimize well and formation clogging problems. Recharge is typically controlled by maintaining the water level in injection wells or drains or by pumping at specified rates. Regulatory agencies should be contacted to determine injection permit requirements. Potential problems with the use of injection include undesired horizontal or vertical contaminant migration due to the increased hydraulic gradients. Sites where injection is to be used should be carefully characterized and monitored to ensure that environmental problems are not exacerbated.

Aspects of site characterization critical to fluid injection design include determination of: (1) site stratigraphy and permeability distribution, (2) hydrogeologic boundary conditions, (3) possible injection rates and resulting hydraulic head and ground-water flow patterns, and (4) the potential for well and formation clogging due to injection.

Hydraulic parameters estimated from analysis of standard aquifer tests are often used to design injection systems. Constant-head, constant-rate, and stepped rate or head injection tests can also be conducted to evaluate hydraulic properties and injection potential using standard aquifer test procedures (Driscoll, 1986; Kruseman and deRidder, 1990). More discrete

techniques (e.g., packer tests, borehole flowmeter surveys) may be desirable to identify high permeability zones. Hydraulic heads and ground-water flow patterns resulting from injection can be examined and predicted using well or drain hydraulics equations and ground-water flow models. Such analysis can also be used to determine potential injection rates, durations, and monitoring locations for injection tests. In addition to helping estimate formation hydraulic properties, injection tests provide information on water compatibility and clogging issues that are critical to injection design.

The most common problem associated with fluid injection is permeability reduction due to clogging of screen openings. This causes a decline in injection rates. Clogging results from physical filtration of solids suspended in injected water, chemical precipitation of dissolved solids, and the excessive growth of microorganisms (also known as biofouling). Less frequently, well or formation damage results from air entrainment, clay swelling, and clay dispersion due to injection. In general, the injection capacity of a system is often oversized by a significant factor (e.g., 1.5 to 2) to account for loss of capacity under operating conditions due to such problems as permeability reduction and the temporary loss of capacity during well maintenance. The optimal degree of overdesign is site specific and will depend on such factors as the rate at which clogging occurs and the cost of maintenance.

The potential for well clogging and mitigative measures can be examined by analysis of the injected fluid and bench scale testing. In general, injection water should contain: (1) no suspended solids to minimize clogging; (2) little or no dissolved oxygen, nutrients, and microbes to minimize biofouling; and (3) low concentrations of constituents that are sensitive to changes in pH, redox, pressure, and temperature conditions (e.g., Fe and Mn) to minimize precipitation. Column permeameter tests can be conducted to examine changes in hydraulic conductivity resulting from injection. Due to the potential significance of many hydrogeologic, physical, and chemical factors, however, fluid injection is best evaluated by conducting extended injection tests during which injection rates and hydraulic heads are monitored carefully. Results of field tests help define formation hydraulic properties, potential injection rates, injection well spacings, mounding response, and clogging potential.

Dissolved or suspended solids may need to be removed from water by aeration, flocculation, and filtration prior to injection. Similarly, nutrients and/or dissolved oxygen may need to be removed to prevent biofouling. Water should be injected below the water table through a pipe to prevent its aeration in the well. Injecting warm water can also promote biofouling. Clogging problems can be minimized by overdesigning injection capacity (e.g., by installing more wells, longer screens, etc.) and implementing a regular well maintenance program.

Extraction and injection rate monitoring and well inspection, using a downhole video camera or other means, can help identify wells in need of treatment or replacement. Periodic rehabilitation of wells or drains (by surging, jetting, chlorination, or acid treatment) may be required to restore declining injection rates (Driscoll, 1986). Chemical incrustation can be addressed by acid treatment, backwashing, mechanical agitation (with a wire brush or surge block), and pumping. Strong oxidizing agents, such as a chlorine solution, can be used in conjunction with backwashing, mechanical agitation, and pumping to treat

wells damaged by slime-producing bacteria. Acidification and chlorination, however, may interfere with interpretation of ground-water chemistry data. Fine particles can be removed (to some extent) using standard well development techniques. Experienced well drillers should be contacted for advice on rehabilitation methods. These potential problems need to be considered when projecting P&T costs. Significant maintenance may be required at many sites to retain desired injection capacity. More detailed discussions of the engineering aspects of water injection are provided by Pyne (1995).

Data Presentation

Complete discussion of methods for characterization and remedial design analyses and supporting data is beyond the scope of this document. In general, such information should be presented graphically and accompanied by supporting calculations and analyses. Tools for electronic storage, manipulation, analysis, and display of data and designs are generally available and often provide a convenient format for storage and access of this information (e.g., database, CAD, and/or GIS programs). Characterization data such as three-dimensional contaminant distribution are best presented on site maps and in representative cross sections. Hydraulic properties and hydraulic head data may also be presented in similar fashion. Pertinent features such as well locations (i.e., monitoring, production, injection), surface water bodies, potential source areas, and relevant structures should be included, as appropriate. Supporting data should be provided in tabular or spreadsheet form and accompany the maps and cross sections.

Capture Zone Analysis for P&T Design

P&T design is refined by performing field tests, modeling alternative injection/extraction schemes, and monitoring system performance. The first step in establishing design criteria, after characterizing pre-remedy ground-water flow patterns and contaminant distributions, is to determine the desired containment and/or restoration area (two-dimensional) and volume (three-dimensional). These should be clearly specified in the remedial design and monitoring plans. After defining the proposed containment area, a capture zone analysis is conducted to design the P&T system and a performance monitoring plan is developed based on the predicted flow field.

The capture zone of an extraction well or drain refers to that portion of the subsurface containing ground water that will ultimately discharge to the well or drain (Figures 3 and 9). It should be noticed that the capture zone of a well is not coincident with its drawdown zone of influence (ZOI) (Figure 9). The extent of the ZOI depends largely on transmissivity and pumping rate under steady-state conditions. However, the shape of the capture zone depends on the natural hydraulic gradient as well as pumping rate and transmissivity. Relatively high natural hydraulic gradients result in narrow capture zones that do not extend far in the downgradient direction. Therefore, some sidegradient and downgradient areas within the ZOI of a recovery well will be beyond its capture zone, and "rules-of-thumb" regarding overlapping drawdown zones should not be used to determine well spacings or pumping rates for P&T design.

In recent years, many mathematical models have been developed or applied to compute capture zones, ground-water pathlines, flushing rates, and associated travel times to extraction

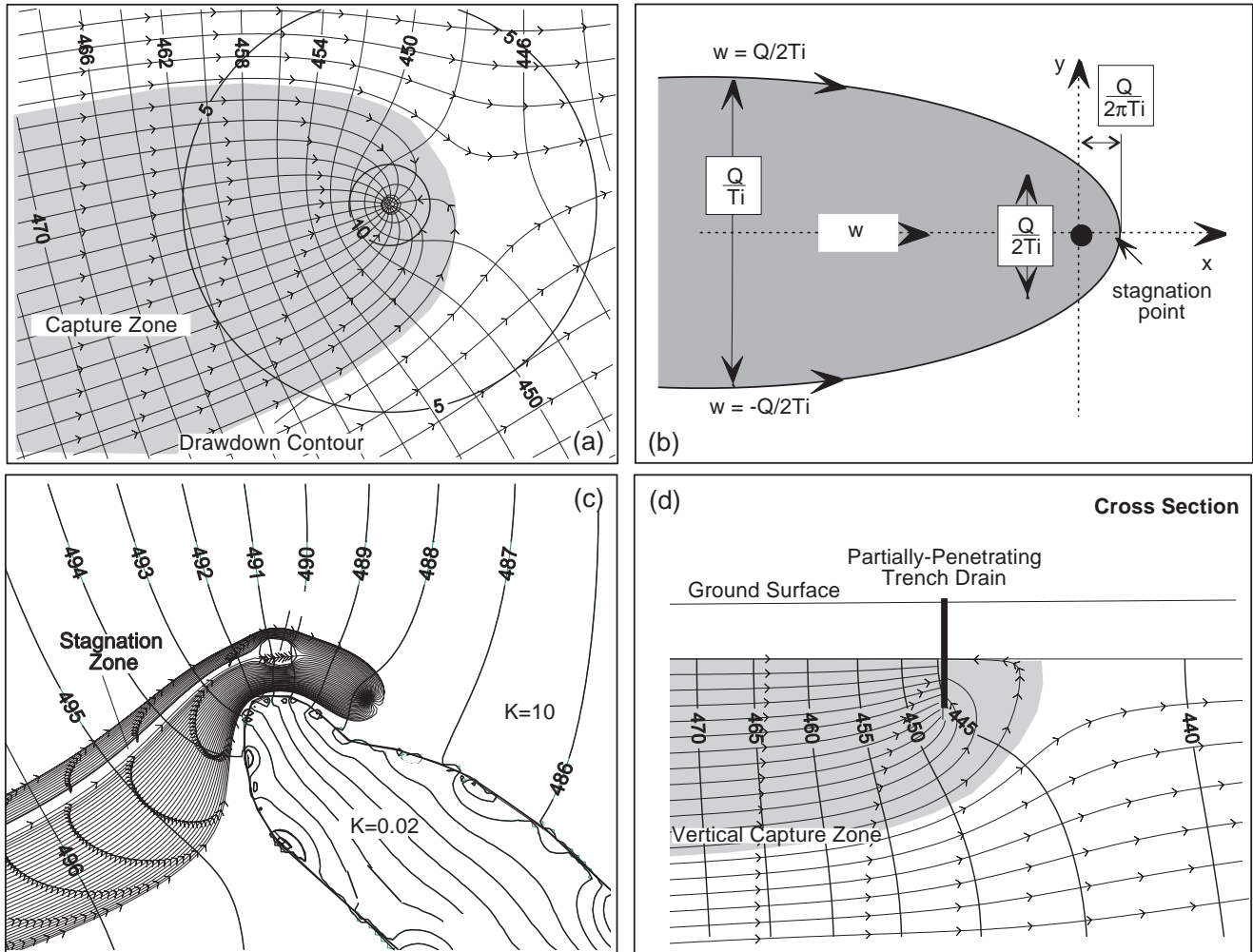

Figure 9. (a) Illustration of drawdown contours (i.e., zone of influence) and the capture zone of a single pumping well in a uniform medium. Equations for the dividing streamlines ($w = Q/2Ti$) that separate the capture zone of a single well from the rest of an isotropic, confined aquifer with a uniform regional hydraulic gradient are given in (b) where T = transmissivity, Q = pumping rate, and i = initial uniform hydraulic gradient. Simplified capture zone analysis methods may provide misleading results when applied to more complex problems, such as those dealing with heterogeneous media, as depicted in (c) where K = relative hydraulic conductivity, and three-dimensional flow (d).

wells or drains (Javandel et al., 1984; Javandel and Tsang, 1986; Shafer, 1987a,b; Newsom and Wilson, 1988; Fitts, 1989,1994; Strack, 1989; Bonn and Rounds, 1990; Bair et al., 1991; Rumbaugh, 1991; Bair and Roadcap, 1992; Blandford et al., 1993; Gorelick et al., 1993; Pollock, 1994; Strack et al., 1994). These models provide insight into flow patterns generated by alternative P&T schemes and the selection of monitoring locations and frequency. Additionally, linear programming methods are being used to optimize P&T design (Ahlfeld and Sawyer, 1990; Gorelick et al., 1993; Hagemeyer et al., 1993) by specifying an objective function subject to various constraints (e.g., minimize pumping rates but maintain inward hydraulic gradients).

Model selection for P&T design analysis depends on the complexity of the site, available data, and the familiarity of the analyst with different codes. In general, the simplest tool applicable to site conditions and the desired degree of uncertainty should be used in design. However, conditions at many sites

will be sufficiently complex that screening level characterizations and design tools will result in significant uncertainty. Regardless of the design tools which are used, capture zone analysis should also be conducted, and well locations and pumping rates optimized, by monitoring hydraulic heads and flow rates during aquifer tests and system operation. Conceptual model refinements gained by monitoring lead to enhanced P&T design and operation. In some cases, these refinements are incorporated in a mathematical model that is used to reevaluate and improve system design.

Capture Zone Analysis Tools

Many types of tools are available for capture zone analysis and system design (Table 1). Graphical methods are useful screening level design tools in many situations. Based on this approach, the simple graphical method shown in Figure 9 can be used to locate the stagnation point and dividing streamlines, and then

Table 1. P&T Design Tools (modified from van der Heijde and Elnawawy, 1993)

<i>Method</i>	<i>Example</i>	<i>Description</i>
<i>Aquifer Tests and Pilot Testing</i>		Controlled and monitored pilot tests are conducted to assist P&T design. Suggested operating procedures for aquifer tests and analytical methods are described by Osborne (1993) and many others. Test results should be used to improve P&T design modeling, where applicable.
<i>Graphical - Capture Zone Type Curves</i>	(Javandel and Tsang, 1986)	A simple graphical method can be used to determine minimum pumping rates and well spacings needed to maintain capture using 1, 2, or 3 pumping wells along a line perpendicular to the regional direction of ground-water flow in a confined aquifer.
<i>Semi-analytical Ground-Water Flow and Pathline Models</i>	WHPA (Blandford et al., 1993) WHAEM (Strack et al., 1994; Haitjema et al., 1994)	These models superposition analytic functions to simulate simple or complex aquifer conditions including wells, line sources, line sinks, recharge, and regional flow (Strack, 1989). Advantages include flexibility, ease of use, speed, accuracy, and no model grid. Generally limited to analysis of 2-D flow problems.
<i>Numerical Models of Ground-Water Flow</i>	MODFLOW (McDonald and Harbaugh, 1988)	Finite-difference (FD) and finite element (FE) ground-water flow models have been developed to simulate 2-D areal or cross-sectional and quasi- or fully- 3-D, steady or transient flow in anisotropic, heterogeneous, layered aquifer systems. These models can handle a variety of complex conditions allowing analysis of simple and complex ground-water flow problems, including P&T design analysis. Various pre- and post-processors are available. In general, more complex and detailed site characterization data are required for simulation of complex problems.
<i>Pathline and Particle Tracking Post-Processors</i>	MODPATH (Pollock, 1994) GPTRAC (Blandford et al., 1993)	These programs use particle tracking to calculate pathlines, capture zones, and travel times based on ground-water flow model output. Programs vary in assumptions and complexity of site conditions that may be simulated (e.g., 2-D or 3-D flow, heterogeneity, anisotropy).
<i>Numerical Models of Ground-water Flow and Contaminant Transport</i>	MT3D (Zheng, 1992) MOC (Konikow and Bredehoeft, 1989)	These models can be used to evaluate aquifer restoration issues such as changes in contaminant mass distribution with time due to P&T operation.
<i>Optimization Models</i>	MODMAN (Greenwald, 1993)	Optimization programs designed to link with ground-water flow models yield answers to questions such as: (1) where should pumping and injection wells be located, and (2) at what rate should water be extracted or injected at each well? The optimal solution maximizes or minimizes a user-defined objective function and satisfies all user-defined constraints. A typical objective may be to maximize the total pumping rate from all wells, while constraints might include upper and lower limits on heads, gradients, or pumping rates. A variety of objectives and constraints are available to the user, allowing many P&T issues to be considered.

Software is available from a variety of sources including the Center for Subsurface Modeling Support at the U.S. EPA's Robert S. Kerr Environmental Research Center in Ada, Oklahoma (405-436-8594).

sketch the capture zone of a single well in a uniform flow field. This analysis is extended by Javandel and Tsang (1986) to determine the minimum uniform pumping rates and well spacings needed to maintain a capture zone between two or three pumping wells along a line perpendicular to the regional direction of ground-water flow. Their capture zone design criteria and type curves can be used for capture zone analysis, but more efficient P&T systems can be designed with nonuniform pump well orientations, spacings, and extraction rates. The extent to which the results of these simple models represent actual conditions depends on the extent to which the assumptions vary from actual site conditions.

More complex tools are often necessary to optimize P&T design and reduce uncertainty. Several semianalytical models employ complex potential theory to calculate stream functions, potential functions, specific discharge distribution, and/or velocity distribution by superimposing the effects of multiple extraction/injection wells using the Thiem equation on an ambient uniform ground-water flow field in a two-dimensional, homogeneous, isotropic, confined, steady-state system (e.g., RESSQC, Blandford et al., 1993). Streamlines, flushing rates, and capture zones associated with irregular well spacings and variable pumping rates can be simulated by these models. Many of these models support reverse and forward particle tracking to trace capture zones and streamlines. For example, reverse particle tracking is implemented in RESSQC to derive steady-state capture zones by releasing particles from the stagnation point(s) of the system and tracking their advective pathlines in the reversed velocity field. Similarly, time-related capture zones (Figure 10) are obtained by tracing the reverse pathlines formed by particles released around each pumping well (Shafer, 1987a; Blandford et al., 1993).

Application of semianalytical models to field problems requires careful evaluation of their limiting assumptions (e.g., isotropic and homogeneous hydraulic conductivity, fully-penetrating wells, no recharge, no vertical flow component, and constant transmissivity). Several analytical models relax these restrictive assumptions by superposition of various functions to treat recharge, layering, heterogeneity, three-dimensional flow, etc. Examples of two-dimensional time-related capture zones determined using TWODAN (Fitts, 1994; 1995) are shown in Figure 10. Given their ease of use and inherent uncertainties regarding the ground-water flow field, the more robust semianalytical models are ideal tools for evaluating alternative injection/extraction well locations and pumping rates at many sites. Where field conditions do not conform sufficiently to model assumptions, the simulation results will be invalid.

Numerical models are generally used to simulate ground-water flow in complex three-dimensional hydrogeologic systems (e.g., MODFLOW, McDonald and Harbaugh, 1988; and SWIFT/486, Ward et al., 1993). For example, the benefits of using partially-penetrating recovery wells to minimize pumping rates and unnecessary vertical spreading of contaminants can be examined using a three-dimensional flow model. Numerical flow model output is processed using reverse or forward particle-tracking software such as MODPATH (Pollock, 1994), GWPATH (Shafer, 1987b), and PATH3D (Zheng, 1990) to assess pathlines and capture zones associated with P&T systems at sites that cannot be adequately modeled using simpler techniques. Solute transport models are primarily run to address aquifer restoration issues such as changes in contaminant mass distribution with time due to P&T operation.

Ground-water flow models can be coupled with linear programming optimization schemes to determine the most effective well placements and pumping rates for hydraulic containment. The optimal solution maximizes or minimizes a user-defined objective function subject to all user-defined constraints. In a P&T system, a typical objective function may be to minimize the pumping rate to reduce cost, while constraints may include specified inward gradients at key locations, and limits on drawdowns, pumping rates, and the number of pumping wells. Gorelick et al. (1993) present a review of the use of optimization techniques in combination with ground-water models for P&T system design. Available codes include AQMAN (Lefkoff and Gorelick, 1987), an optimization code that employs the Trescott et al. (1976) two-dimensional ground-water flow model, and MODMAN (Greenwald, 1993), which adds optimization capability to the three-dimensional USGS MODFLOW model (McDonald and Harbaugh, 1988). A case study of optimization code use to assist P&T design is given by Hagemeyer et al. (1993).

Techniques have been presented in the literature for combining nonlinear optimization methods with contaminant transport simulation models (Gorelick, 1983; Wagner and Gorelick, 1987; Ahlfeld et al., 1988). These techniques are intended to provide solutions to problems formulated in terms of predicted concentrations (e.g., minimize pumping such that TCE is below the required clean-up level within five years at target locations). However, such analysis requires the use of a solute transport model and solution of a relatively difficult nonlinear problem. As a result, computation effort is large and uncertainty in results is high compared to optimization based on ground-water flow. Nonlinear optimization methods using solute transport models have not yet been packaged into commercial software and have rarely been applied to ground-water contamination problems.

Extraction / Injection Scheme Design

For a successful hydraulic containment, contaminants moving with ground water in the desired containment zone must follow pathlines that are captured by the P&T system. An appropriate remedial objective might be to minimize the total cost required to maintain perpetual containment and satisfy regulatory requirements. Given this objective, installing low permeability barriers (Figure 3c) to reduce pumping rates might be cost-effective. At sites with an objective of contaminant mass removal (i.e., where the containment area size may be diminished or P&T discontinued if clean-up goals are met), a more complex cost-effectiveness trade-off exists between minimizing hydraulic containment costs and maximizing contaminant mass removal rates.

Unless natural attenuation mechanisms are being relied upon to limit plume migration, hydraulic containment is generally a prerequisite for aquifer restoration. Restoration P&T design will typically reflect a compromise among objectives that seek to: (1) reduce contaminant concentrations to clean-up standards, (2) maximize mass removal, (3) minimize clean-up time, and (4) minimize cost. Due to the limitations described in Appendix A, P&T for aquifer restoration requires a high degree of performance monitoring and management to identify problem areas and improve system design and operation.

Restoration P&T ground-water flow management involves optimizing well locations, depths, and injection/extraction rates to maintain an effective hydraulic sweep through the

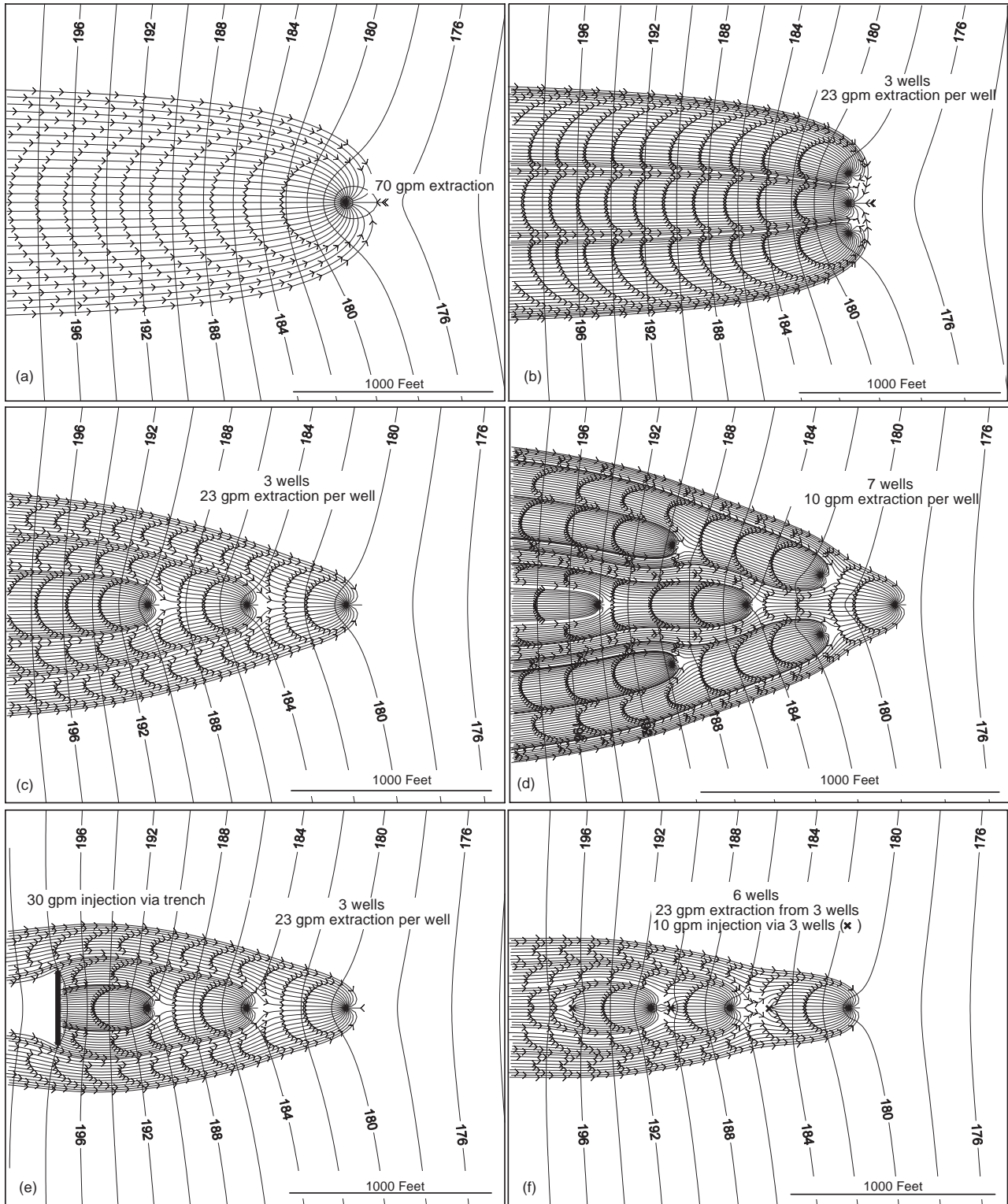

Figure 10. Hydraulic head contours and capture zones simulated using TWODAN (Fitts, 1995) for several extraction/injection schemes in an aquifer with a uniform transmissivity of $1000 \text{ ft}^2/\text{d}$, and an initial hydraulic gradient of 0.01. Pathline time intervals of one year are marked by arrows. Note the stagnation zones that develop downgradient of extraction wells and upgradient of injection wells.

contamination zone, minimize stagnation zones, flush pore volumes through the system, and contain contaminated ground water. Wells are installed in lines and other patterns to achieve these objectives (Figure 10). Horizontal wells and drains are constructed to create ground-water line sinks and mounds, and thereby affect linear hydraulic sweeps.

Pore Volume Flushing

Restoration requires that sufficient ground water be flushed through the contaminated zone to remove both existing dissolved contaminants and those that will continue to desorb from porous media, dissolve from precipitates or NAPL, and/or diffuse from low permeability zones. The sum of these processes and dilution in the flow field yields persistent acceptable ground-water quality at compliance locations.

The volume of ground water within a contamination plume is known as the pore volume (PV), which is defined as

$$PV = \int_A bn \, dA \quad (1)$$

where b is the plume thickness, n is the formation porosity, and A is the area of the plume. If the thickness and porosity are relatively uniform, then

$$PV = BnA \quad (2)$$

where B is the average thickness of the plume.

Assuming linear, reversible, and instantaneous sorption, no NAPL or solid contaminants, and neglecting dispersion, the theoretical number of PVs required to remove a contaminant from a homogeneous aquifer is approximated by the retardation factor, R , which is the ground-water flow velocity relative to velocity of dissolved contaminant movement. An example of the relationship between the number of PVs and R , that also accounts for dispersion, is demonstrated by a numerical model used to evaluate a P&T design at the Chem-Dyne site in Ohio (Ward et al., 1987). Due to simulation of linear sorption, a nearly linear relationship was found to exist between retardation and the duration of pumping (or volume pumped) needed to reach the ground-water clean-up goal. Batch flush models (e.g., U.S. EPA, 1988b; Zheng et al., 1992) often assume linear sorption to calculate the number of PVs required to reach a clean-up concentration, C_{wt} in ground water as a function of the retardation factor, R , and the initial aqueous-phase contaminant concentration, C_{wo} :

$$\text{No. of PVs} = -R \ln (C_{wt} / C_{wo}) \quad (3)$$

Though useful for simple systems, the representation of linear, reversible, and instantaneous sorption in contaminant transport models can lead to significant underestimation of P&T clean-up times. For example, the desorption of most inorganic contaminants (e.g., chromium and arsenic) is nonlinear. In addition, much of the pore space in aquifer materials may not be available for fluid flow. In such situations, flushing is not efficient and removal of a greater number of pore volumes of water will be required.

Kinetic limitations often may prevent sustenance of equilibrium contaminant concentrations in ground water (Bahr, 1989; Brogan,

1991; Haley et al., 1991; Palmer and Fish, 1992). Such effects occur in situations where contaminant mass transfer to flowing ground water is slow relative to ground-water velocity. For example, contaminant mass removal from low permeability materials may be limited by the rate of diffusion from these materials into more permeable flowpaths. In this situation, increasing ground-water velocity and pore volume flushing rates beyond a certain point would provide very little increase in contaminant removal rate. Kinetic limitations to mass transfer are likely to be relatively significant where ground-water velocities are high surrounding injection and extraction wells.

The number of PVs that must be extracted for restoration is a function of the clean-up standard, the initial contaminant distribution, and the chemical/media phenomena that affect cleanup. Screening-level estimates of the number of PVs required for cleanup can be made by modeling and by assessing the trend of contaminant concentration versus the number of PVs removed. At many sites, numerous PVs (i.e., 10 to 100s) will have to be flushed through the contamination zone to attain clean-up standards.

The number of PVs withdrawn per year is a useful measure of the aggressiveness of a P&T operation. Many current systems are designed to remove between 0.3 and 2 PVs annually. For example, less than 2 PVs per year were extracted at 22 of the 24 P&T systems studied by U.S. EPA (1992b) and reviewed by NRC (1994). Low permeability conditions or competing uses for ground water may restrict the ability to pump at higher rates. As noted above, kinetic limitations to mass transfer also may diminish the benefit of higher pumping rates. The potential significance of such limitations should be evaluated prior to installation of aggressive systems designed for relatively high flushing rates. If limiting factors are not present, pumping rates may be increased to hasten cleanup.

The time required to pump one pore volume of ground water from the contaminated zone is a fundamental parameter that should be calculated for P&T systems. NRC (1994), however, determined that the number of PVs withdrawn at P&T sites is rarely reported. Restoration assessments should include estimates of the number of PVs needed for cleanup. However, it must be noted that such analyses generally oversimplify highly complex site conditions. It may often be impracticable to characterize the site in sufficient detail to reduce uncertainty in estimates of restoration time frames to insignificant levels. Uncertainty in these estimates should be considered during remedial evaluations.

Poor P&T design may lead to low system effectiveness and contaminant concentration tailing. Poor design factors include low pumping rates and improper location of pumping wells and completion depths. A simple check on the total pumping rate is to calculate the number of PVs per year. Inadequate location or completion of wells or drains may lead to poor P&T performance even if the total pumping rate is appropriate. For example, wells placed at the containment area perimeter may withdraw a large volume of clean ground water from beyond the plume via flowlines that do not flush the contaminated zone. Similarly, pumping from the entire thickness of a formation in which the contamination is limited vertically will reduce the fraction of water that flushes the contaminated zone. In general, restoration pumping wells or drains should be placed in areas of relatively high contaminant concentration as well as locations suitable for achieving hydraulic containment.

Well placement can be evaluated by: (1) using ground-water flow and transport models; (2) comparing contaminant mass removed to contaminant mass dissolved in ground water; and (3) applying expert knowledge. P&T system modifications should be considered if any of these methods indicate that different pumping locations or rates will improve system effectiveness.

Minimize Ground-Water Stagnation

Ground-water flow patterns need to be managed to minimize stagnation during P&T operation. Stagnation zones develop in areas where the P&T operation produces low hydraulic gradients (e.g., downgradient of a pumping well and upgradient of an injection well) and in low permeability zones regardless of hydraulic gradient. Ground-water flow modeling can be used to assess ground water and solute velocity distributions, travel times, and stagnation zones associated with alternative pumping schemes. During operation, stagnation zones can be identified by measuring hydraulic gradients, tracer movement, ground-water flow rates (e.g., with certain types of downhole flowmeters or in situ probes), and by modeling analysis. Low permeability heterogeneities should be delineated as practicable during the site characterization and P&T operation. Stagnation zones associated with different pumping schemes are evident in Figure 10.

Once identified, the size, magnitude, and duration of stagnation zones can be diminished by changing pumping (extraction and/or injection) schedules, locations, and rates. Again, flow modeling based on field data may be used to estimate optimum pumping locations and rates to limit ground-water stagnation. An adaptive pumping scheme, whereby extraction/injection pumping is modified based on analysis of field data, should result in more expedient cleanup.

Guidance from Modeling Studies

Several modeling studies have been conducted to examine the effectiveness of alternative extraction and injection well schemes with regard to hydraulic containment and ground-water clean-up objectives (e.g., Freeberg et al., 1987; Satkin and Bedient, 1988; Ahlfeld and Sawyer, 1990; Tiedeman and Gorelick, 1993; Marquis, Jr. and Dineen, 1994; Haggerty and Gorelick, 1994). Although the optimum extraction/injection scheme depends on site-specific conditions, objectives, and constraints, consideration should be given to guidance derived from simulation studies of P&T performance.

A conceptual modeling analysis using FTWORK (Faust et al., 1993) of three alternative pumping strategies for an idealized site with a uniform medium, linear equilibrium sorption, a single non-degrading contaminant, and a continuing release is presented in Figure 11. The plume management strategies include: (1) downgradient pumping, (2) source control with downgradient pumping, and (3) source control with mid-plume and downgradient pumping. As shown, downgradient pumping by itself allows and increases the movement of highly contaminated ground water throughout the flowpath between the release area and the downgradient recovery well. This alternative results in expansion of the highly contaminated plume and makes it more difficult to achieve cleanup. The importance of source control is clearly demonstrated by comparing the management alternatives. Source control pumping prevents continued offsite migration and thereby facilitates downgradient cleanup of contaminated ground water.

The combined source control, mid-plume, and downgradient pumping alternative reduces the flowpath and travel time of contaminants to extraction wells and diminishes the impact of processes which cause tailing. As such, with more aggressive P&T, cleanup is achieved more quickly and the volume of ground water that must be pumped for cleanup is less than for the other alternatives.

The effectiveness of seven injection/extraction well schemes shown in Figure 12 at removing a contaminant plume was evaluated by Satkin and Bedient (1988) using the MOC transport model (Konikow and Bredehoeft, 1989). The performance of each scheme was assessed for eight different hydrogeologic conditions, which were simulated by varying maximum drawdown, dispersivity, and regional hydraulic gradient. Effectiveness was judged based on simulated cleanup, flushing rate, and the volume of water requiring treatment. Findings of this study include (Satkin and Bedient, 1988): (1) multiple extraction wells located along the plume axis (the center line scheme) reduce clean-up time by shortening contaminant travel paths and allowing higher pumping rates; (2) the three-spot, double-cell, and doublet schemes were effective under low hydraulic gradient conditions, but require onsite treatment and reinjection; (3) the three-spot pattern outperformed the other schemes for simulations incorporating a high regional hydraulic gradient; and, (4) the center line pattern was effective under all simulated conditions. Andersen et al. (1984) and Satkin and Bedient (1988) showed that the five-spot pattern (Figure 12) may be a relatively inefficient scheme for cleanup.

Brogan (1991) and Gailey and Gorelick (1993) used simulations to demonstrate that the best single recovery well location is somewhat downgradient of a plume's center of mass. The optimum location (requiring the lowest pumping rate) for a single extraction well to remediate a plume within a given time period increases in distance downgradient from the center of contaminant mass with increasing remediation time (Gailey and Gorelick, 1993; Haggerty and Gorelick, 1994). Thus, optimum pumping locations and rates depend on the specified clean-up time frame.

The relative merits of conventional extraction/injection well schemes, in-situ bioremediation, and P&T enhanced by injecting oxygenated water to stimulate biodegradation for containing and cleaning up a hypothetical naphthalene plume in a uniform aquifer were examined by Marquis and Dineen (1994). Nineteen remediation alternatives were modeled using BIOPLUME II (Rifai et al., 1987), a modified version of the MOC code (Konikow and Bredehoeft, 1989) that simulates oxygen transport and oxygen-limited biodegradation. Key findings made by Marquis and Dineen (1994) include the following: (1) ground-water extraction was more effective at preventing offsite migration than bioremediation; (2) P&T enhanced by injecting highly oxygenated water (with 50 mg/L dissolved oxygen) provided the most effective plume control and cleanup; (3) greater contaminant mass reductions occurred when extraction or injection wells were located in the more contaminated portions of the plume; (4) cleanup is hastened by minimizing the distances that contaminants must travel to extraction wells or that dissolved oxygen must travel to reach degradable contaminants; (5) to maximize containment, P&T schemes should be designed to produce convergent flow toward a central extraction location and to minimize divergent flow along the plume periphery; and (6) extraction/injection schemes should be designed to minimize the presence of upgradient and intraplume stagnation areas.

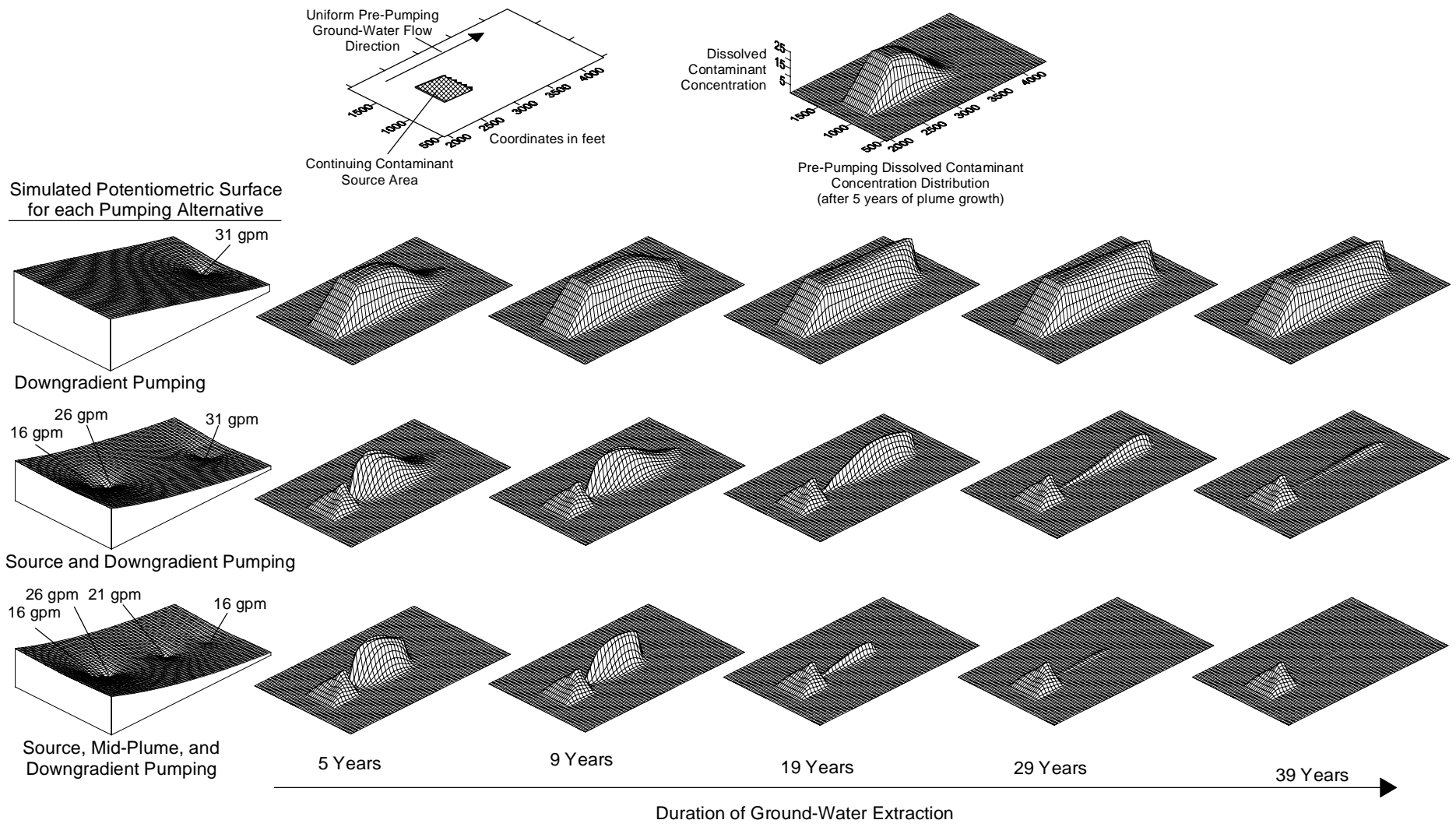

Figure 11. Results of FTWORK (Faust et al., 1993) simulation analysis of three P&T alternatives for an idealized site (with uniform media, linear equilibrium sorption, and a single non-degrading contaminant) showing dissolved contaminant concentrations with time of pumping.

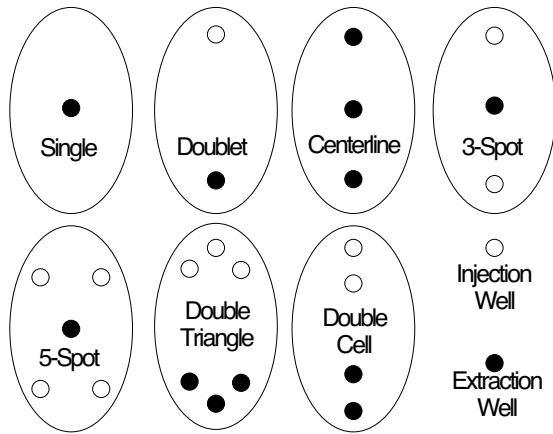

Figure 12. Well schemes evaluated by Satkin and Bedient (1988).

Pulsed Pumping

Pulsed pumping, with alternating pumping and resting periods as illustrated in Figure 13, has been suggested as a means to address tailing, flush stagnation zones by selective well cycling, and increase P&T efficiency (Keely, 1989; Borden and Kao, 1992; Gorelick et al., 1993). Dissolved contaminant concentrations increase due to diffusion, desorption, and dissolution in slower-moving ground water during the resting phase of pulsed pumping. Once pumping is resumed, ground water with higher concentrations is removed, thus increasing the rate of mass removal during active pumping. Due to slow mass transfer from immobile phases to flowing ground water, however, contaminant concentrations decline with continued pumping until the next resting phase begins.

Several simulation studies have been conducted to evaluate the effectiveness of pulsed pumping (Powers et al., 1991; Brogan, 1991; Borden and Kao, 1992; Armstrong et al., 1994; Rabideau and Miller, 1994; and Harvey et al., 1994). Harvey et al. (1994) found that: (1) for equal volumes of ground water extracted, pulsed pumping does not remove more contaminant mass than pumping continuously at the lower equivalent time-averaged rate; (2) if the resting period is too long, pulsed pumping will remove much less mass than pumping continuously at an equivalent time-averaged rate; and, (3) if pulsed and continuous pumping rates are the same, pulsed pumping will take longer to achieve clean-up goals, but will require significantly less time of pump operation. At many sites with significant tailing and rebound, it will be preferable, therefore, to pump continuously at a lower average rate than to initiate pulsed pumping. Cost savings associated with less time of pump operation, however, may make pulsed pumping advantageous.

If used, pulsed pumping schedules can be developed based on pilot tests, modeling analysis, or ongoing performance monitoring of hydraulic heads and contaminant concentrations. The pumping period should be long enough to remove most of the contaminant mass in the mobile ground water. The resting period should not be so long that the dissolved concentration in mobile ground water exceeds 70% to 90% of its equilibrium value. Additional resting becomes inefficient as equilibrium is approached because the rate of mass transfer from immobile to mobile phases is driven by the concentration gradient. Care

must be taken to ensure that the hydraulic containment objective is met during pump rest periods. Further guidance on interpreting field data to designate pulsed pumping parameters is provided by Harvey et al. (1994). Simulation results showing the sensitivity of pulsed pumping performance to rest period duration are shown in Figure 13.

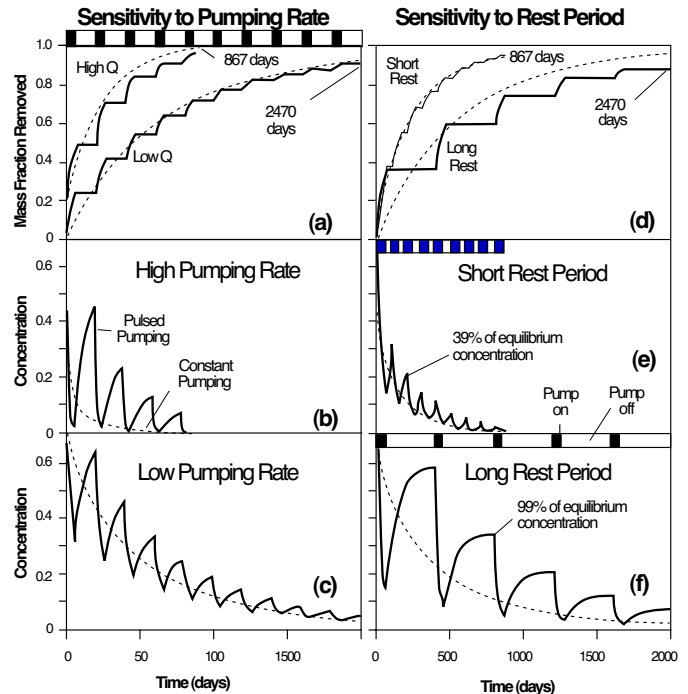

Figure 13. Effects of varying pulsed pumping parameters (after Harvey et al., 1994). The fraction of total mass removed with time is shown in (a) and (d); pumping well concentrations are shown in (b), (c), (e), and (f). Dashed lines represent equivalent constant pumping rates. Black bars at top of figures represent pumping periods and white bars represent rest periods.

Dealing with Multiple Contaminant Plumes

Multiple contaminants that migrate at different velocities in ground water are commonly encountered at contamination sites. Compounds that partition more strongly to the solid phase are transported more slowly, remain closer to source areas, and are more difficult to extract from the subsurface by pumping than the more mobile compounds. Thus, a P&T design that is ideal for a single contaminant plume might perform poorly at a site with multiple contaminants.

Haggerty and Gorelick (1994) used a solute transport model and optimization analysis to examine the ability of five pumping schemes to simultaneously remediate three contaminant plumes that were chromatographically separated during ground-water transport. The simulated problem and alternative extraction schemes are shown in Figure 14.

In the single well scheme, one well is placed along the plume axis at one of the indicated locations. For the other schemes,

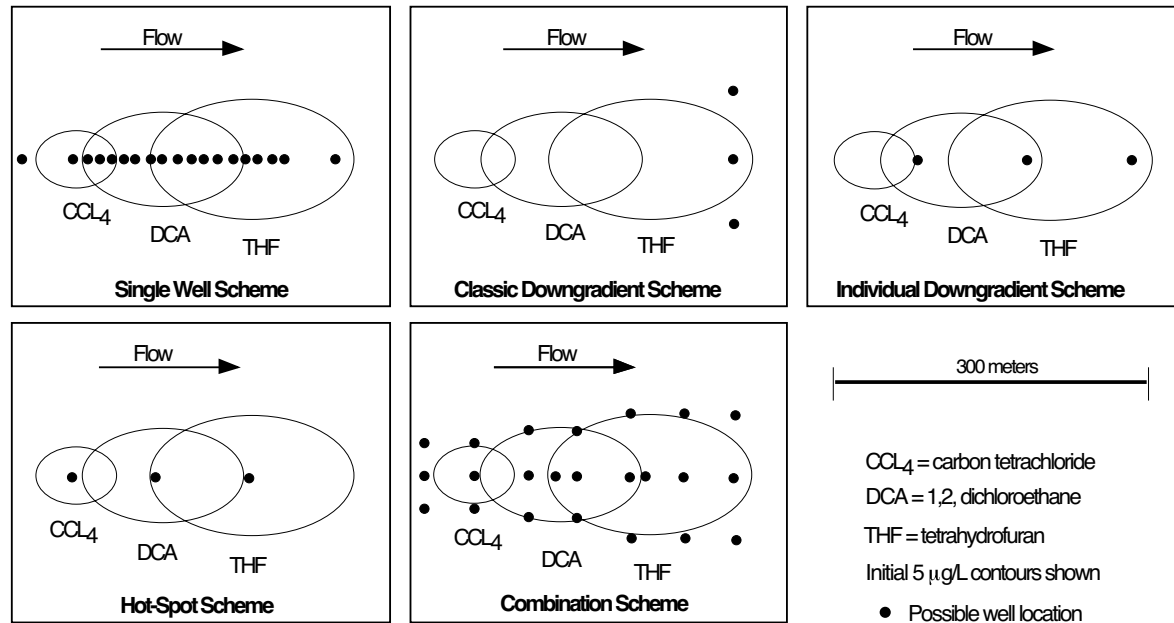

Figure 14. Map view of five pumping schemes studied by Haggerty and Gorelick (1994) overlain on the initial 5 µg/L contours of simulated CCl₄, DCA, and THF plumes. Many of the possible well locations were not used because the optimization analysis determined pumping at some locations to be 0 liters/sec. Only the optimum single well location was used for pumping under the single well scheme (modified from Haggerty and Gorelick, 1994).

wells can be placed at any number of the sites shown. The optimum number, location, and pumping rates of wells in each scheme were determined using the optimization model to achieve cleanup at the lowest possible pumping rate within a specified remediation period. Sensitivity analyses were conducted to examine the influence of mass transfer rate limitations on contaminant mobilization and removal. Findings presented by Haggerty and Gorelick (1994) for each pumping scheme are summarized in Figure 15.

For the smallest mass transfer rate parameter, $\xi = 0.005 \text{ day}^{-1}$, none of the schemes can achieve cleanup within three years regardless of pumping rate due to mass transfer rate limitations. Assuming that the site is cleaned up everywhere with no dilution caused by mixing with uncontaminated ground water, then the minimum remediation time due to mass transfer limitations can be calculated as,

$$t_{min} = - (\rho_b \lambda_k / \xi) \ln (s_k^* / s_k') \quad (4)$$

where ρ_b is the formation bulk density (M/L³), λ_k is the distribution coefficient for compound k (L³/M), ξ is a first-order mass transfer rate parameter (1/T), s_k^* is the immobile domain concentration standard (M/M), and s_k' is the initial maximum immobile concentration of contaminant k found at the site (M/M). Rate-limited mass transfer hinders short-term cleanup, but may have negligible impact on long-term P&T. Desorption or diffusion rate limitations may make it impossible to achieve cleanup within a short time.

For the combination scheme shown in Figure 14, seven or eight wells are optimal to achieve cleanup within three years to sufficiently reduce the distance contaminants must travel within the short remediation period. Ground water is pumped at the

highest rates along the plume axis and in the location of the most retarded compounds to compensate for their low velocities.

The combination scheme essentially reduces to an individual downgradient well design for longer remediation periods. Only two or three wells along the plume axis are needed for cleanup and the ideal well locations approximate those of the individual downgradient scheme (e.g., one well cleans up the most retarded plume and the other cleans up the more mobile, downgradient plumes). The individual downgradient scheme, which requires fewer wells, therefore, is well-suited for longer-term P&T efforts.

For fast cleanup, the hot spot scheme requires less pumping than all but the combination scheme. More pumping, however, is required using the hot spot wells for a 15-year clean-up period compared to the individual downgradient scheme. This is because individual downgradient wells take advantage of the plume migration via slow regional ground-water flow during the longer clean-up period.

The classic downgradient scheme (Figure 14) is the least desirable alternative shown for attaining cleanup because the contaminants must travel completely across the multiplume site to reach the recovery wells. As a result, the more retarded contaminant plumes are smeared to the wells, an excessive volume of ground water must be extracted for cleanup, and short-term cleanup is infeasible. The single recovery well option also has significant drawbacks. It will generally require pumping more ground water and result in more contaminant smearing than all of the other schemes except the classic downgradient design.

A good P&T design must address mobile, weakly-sorbed and slow-moving, highly-sorbed contaminants to be effective at

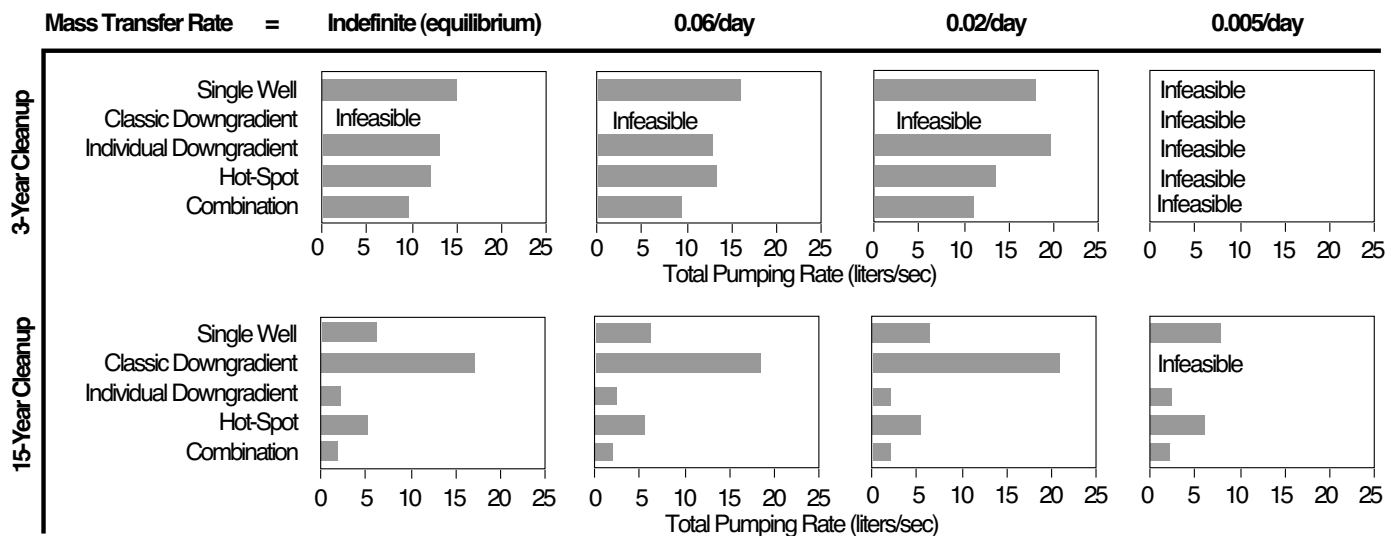

Figure 15. Optimal pumping rates for each well scheme (Figure 14) showing the minimum rate needed to capture and clean up the contaminants for the 3-year and 15-year pumping periods and mass transfer rates ranging from infinite (at equilibrium) to 0.005/day (modified from Haggerty and Gorelick, 1994).

cleanup. Substantial pumping should occur in the upgradient portion of a multiplume site to minimize both the smearing of strongly sorbed contaminants and the total volume of ground water that must be extracted for cleanup.

Other Considerations

Cyclic water-level fluctuations — Ground-water levels near surface water respond to changes in surface water stage. Cyclic stage fluctuations occur in tidal waters and in some streams that are regulated by pumping or discharge control. Where the surface water fluctuates as a harmonic motion, as occurs due to tides, a series of sinusoidal waves is propagated into the aquifer (Ferris, 1963). The amplitude of each transmitted wave decreases and the time lag of a given wave peak increases with distance from the surface water. Hydraulic gradients between contamination sites and nearby tidal water bodies, therefore, increase at low tide and decrease (or may be locally reversed) at high tide. As a result, these cyclic water-level fluctuations tend to enhance ground-water capture during high tide periods and inhibit capture during low tide periods. The impact of cyclic water-level fluctuations can be examined using analytical solutions (Jacob, 1950; Ferris, 1963) or numerical models with highly refined time steps and boundary conditions. At contamination sites that are influenced by cyclic water-level fluctuations, consideration should be given to adopting a variable rate pumping schedule, with higher extraction rates during low stage periods, to provide cost-effective hydraulic containment throughout the surface water stage cycle.

Dewatering — Water flushing will be limited to infiltration rates where P&T operation has lowered the water table and partially dewatered contaminated media. As a result, dissolved contaminant concentrations may rebound when the water table rises after pumping is reduced or terminated. Water can be injected or infiltrated, and pumping locations and rates can be varied, to both minimize this potential problem and increase the rate of flushing. Where injection is not feasible, soil vapor

extraction or other vadose zone remedial measures might be needed to remove contaminant mass above the water table.

Drawdown limitations — Under some conditions, hydraulic containment cannot be maintained unless barrier walls are installed and/or water is injected (or infiltrated) downgradient of, or within, the contaminated zone. Limited aquifer saturated thickness, a relatively high initial hydraulic gradient, a sloping aquifer base, and low permeability are factors that can prevent hydraulic containment using wells or drains (Saroff et al., 1992). Where these conditions exist and hydraulic containment is planned, particular care should be taken during pilot tests and monitoring to assess this limitation.

Fractured and karst media — Fractured and solution-channeled geologic materials often represent highly heterogeneous and anisotropic systems to which techniques developed for characterization and evaluation of porous media are not readily applicable. Characterization techniques in such systems are an area of continuing research and beyond the scope of this document. Contaminant transport and P&T design/operation will be largely controlled by such factors as orientation, density, and connectivity of transmissive fracture systems. Techniques used to evaluate potential capture zones and remedial time frames based on porous-media assumptions often will not be applicable. Evaluations of capture zones will generally be based on site-specific characterization of the fractured or karst system and may involve use of tracer tests, observations during aquifer tests, and other specialized techniques such as borehole flowmeter investigations to define transmissive fracture systems and evaluate connectivity.

Information required for extraction well design will include characterization of transmissive, contaminated areas and intervals in fractured/karst systems and characterization of flow and transport parameters in any overlying porous materials (e.g., overburden, saprolite). At some sites where overburden and fractured rock are contaminated, extraction wells screened/

open across both units may be acceptable with adjustments in filter pack/screen specification for each unit. Conversely, it may be practical to screen wells only in the more transmissive unit to capture contaminants in both units. Such determinations depend on the distribution of hydraulic parameters in each affected unit. Ultimately, pilot testing of wells with careful monitoring generally will be required to evaluate the effectiveness of such systems.

In some situations, rock units may be sufficiently fractured as to approximate porous media behavior (de Marsily, 1986) allowing use of more traditional design evaluations discussed elsewhere in this document. In other situations, contaminants may be moving only in very discrete fracture systems rendering characterization difficult and necessitating careful delineation of dominant fractures and design of wells with very discrete screen/open intervals for optimum operation. The usual design approach in this situation is to locate and screen wells to intersect as many contaminated, transmissive fractures as possible (Gorelick et al., 1993). Testing of each well will be required to determine specific drawdown/flowrate relationships and evaluate potential gradient control.

The optimal well design for each of these situations will depend on the site-specific distribution of contaminants and hydraulic properties of each rock and overburden unit. However, similar design principles apply to fractured systems as to heterogeneous porous media. Design should be based on three-dimensional contaminant distribution and three-dimensional analysis of hydrologic properties of each unit within the system. In general, there still will be a significant degree of uncertainty associated with determinations of flow/transport in fractured/karst systems at most sites due to the impracticability of defining contaminant distribution and transport parameters in sufficient detail using available characterization techniques. A flexible design approach and performance monitoring can be used to minimize the effect of these uncertainties.

Highly permeable and heterogeneous media — In highly permeable media, high pumping rates are usually required to attain demonstrable hydraulic containment. Barrier walls and low-permeability surface covers installed to reduce the rate of pumping needed for containment also facilitate demonstration of inward hydraulic gradients (Figure 3). Hydraulic containment and site characterization can also be enhanced in heterogeneous media by installing barrier drains and walls, particularly if done in a manner that allows subsurface examination during construction.

Horizontal anisotropy — Significant horizontal anisotropy may be present at some sites, particularly where strata are inclined or fractured. The directions of maximum and minimum permeability are usually aligned parallel and perpendicular, respectively, to foliation or fractures. In anisotropic media, the flow of ground water (and contaminants moving with ground water) is offset from the hydraulic gradient in the direction of maximum permeability. Interpretation of hydraulic head data and capture zone analysis must account for anisotropy to evaluate extraction/injection wellfield effectiveness. Various well hydraulics equations (Papadopoulos, 1965; Kruseman and deRidder, 1990) and numerical models can be employed to account for anisotropic conditions during P&T design.

Injection/extraction cells — Recharging upgradient of the contaminant plume and flushing the contaminant toward a downgradient extraction well can be designed to create a

ground-water recirculation cell that isolates the plume from the surrounding ground water (Figure 16). Injection and extraction rates and locations can be adjusted to minimize the volume of ground water requiring treatment, increase flushing rates through the contamination zone (thereby reducing the flushing time), and provide additional containment (Wilson, 1984). If permitted and properly designed, water injection can greatly enhance hydraulic control and contamination zone flushing. Of course, due to water balance considerations (i.e., recharge from the land surface), it is generally not possible to reinject and recapture all of the extracted ground water. Poorly designed and inadequately monitored injection can lead to unintended horizontal and/or vertical contaminant migration.

Partial penetration — Construction of wells that only partially penetrate the aquifer may be desirable or undesirable in different situations. Contaminated ground water emanating from shallow source areas frequently is limited to the upper portion of a hydrogeologic unit. For this case, partially-penetrating recovery wells should be constructed to limit the downward spread of contaminants and the extraction of clean deep ground water. In situations where extraction wells or drains partially penetrate a contaminant plume capture may not extend to the lower limits of the plume. Three-dimensional data (e.g., hydraulic head, hydraulic conductivity distribution, contaminant distribution) are required to evaluate and monitor three-dimensional capture. In such situations, construction of wells or drains that fully penetrate the contaminated interval may reduce uncertainty and costs associated with monitoring vertical capture.

Physical barriers — Physical barriers to ground-water flow (e.g., slurry walls, grout curtains, sheet piling, etc.) reduce inflow into the system and often allow use of lower ground-water extraction and treatment rates to achieve a particular hydraulic head distribution (e.g., inward hydraulic gradient or significant dewatering). Surface caps may also be used to reduce infiltration and further reduce extraction requirements. In addition, use of such barriers and maintenance of an inward hydraulic gradient will generally reduce the complexity of adequately monitoring capture zones.

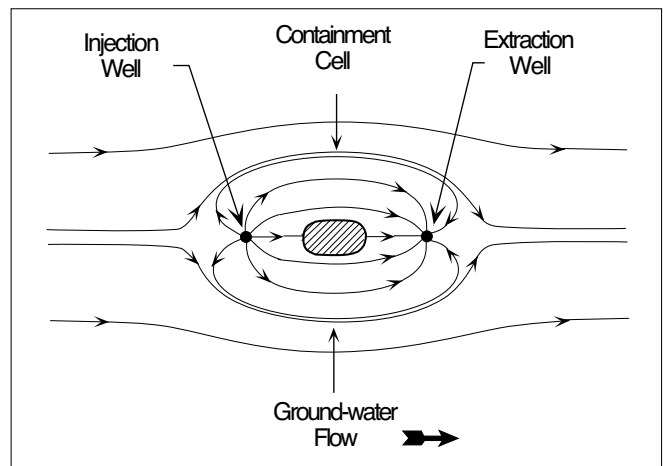

Figure 16. Plan view of a single-cell hydraulic containment, showing flow lines and a hatched contaminant plume (modified from Wilson, 1984).

Situations in which use of physical barriers may be advantageous or cost effective include sites where treatment capacity for extracted ground water is limited, reductions in treatment costs outweigh barrier construction costs, and heterogeneous sites or sites with relatively high pre-design hydraulic gradients where uncertainty in capture zone determinations is high. Additional details regarding design and construction aspects of physical barriers may be found in U.S. EPA (1984), Evans (1991), Grube (1992), and Rumer and Ryan (1995).

Although these features may be used as enhancements to a P&T system, they often will not be appropriate replacements for P&T. Physical barriers without the use of P&T to lower hydraulic head within the enclosure will generally result in increasing hydraulic head within the wall. This may result in leakage over the wall, under the wall, or through relatively minor imperfections in the wall.

Physical constraints — Many ground-water contamination sites are located in developed areas where the presence of roads, buildings, and other structures constrain the placement of P&T components (i.e., wells, pipelines, and treatment plants). Such constraints should be identified early in the design process and incorporated into the analysis of feasible remedies. In some cases, it will be necessary to assess potential for subsidence that may result from pumping.

Surface-water interactions — Streams, rivers, lakes, and other surface water bodies frequently act as discharge boundaries to local and regional ground-water flow systems (and dissolved contaminants migrating therein). A variety of complex leakage and discharge relationships, however, exist spatially and temporally between surface water and ground water. Interaction between ground water and surface water may help or hinder P&T operations. At some sites, P&T design can take advantage of induced infiltration along stream line sinks to enhance hydraulic containment and flushing rates. Elsewhere, it may be desirable to limit streambed leakage (e.g., using physical barriers) to minimize requisite pumping rates or the inflow of surface water that has been contaminated at upstream locations. Consideration should also be given to potential hydraulic benefits of discharging treated ground water at alternative stream locations. Relatively complex interactions between surface water and ground water can best be analyzed by numerical model analysis and monitoring system performance.

Timeliness of remedial action — Research has shown that contaminants that have been in contact with porous media for long times are much more resistant to desorption, extraction, and degradation (Brusseu, 1993). As the residence time of a contaminant plume increases, so do potential contaminant tailing and rebound problems associated with sorption/desorption and matrix diffusion. Old plumes are likely to exhibit significant nonideal behavior, making cleanup difficult. Remedial efforts should be implemented as soon as practicable following a release to limit the difficulty of removing contaminant mass from low permeability zones and sorbed phases.

Well completion interval — Well completion intervals are selected based on site conditions and P&T strategy. Maximum well yield can generally be obtained by screening 80 percent to 90 percent of the thickness of a confined aquifer. In an unconfined formation, the screen should be placed low enough in the contaminated section so that the pumping level is not drawn into the screen. This will prevent aeration of the screen and extend

the service life of the screen and pump. Longer screens may be needed in thick contamination zones and in low permeability formations to achieve an acceptable yield.

An individual well (with zone-dependent screen and sandpack characteristics) may be completed in multiple transmissive zones and hydrogeologic units if such a construction will not exacerbate vertical contaminant migration or prevent the cost-effective cleanup of individual layers. In general, (1) screens should not be constructed to hydraulically connect transmissive zones across an aquitard; (2) it is undesirable to pump ground water directly from uncontaminated intervals; and (3) partially-penetrating recovery wells can be used to limit the downward contaminant spreading and recovery pumping rates at sites where contaminants are limited to the upper portion of a thick hydrogeologic unit. Open-hole bedrock well completions are usually acceptable, but care must be taken to not promote contaminant migration (e.g., by completing an open-hole well across an effective aquitard).

Site characterization activities (such as interval-specific packer-aquifer tests, borehole flowmeter testing, and ground-water sampling) and three-dimensional simulation analysis can be used to help evaluate complicated cost-benefit trade-offs between alternative well designs in vertically heterogeneous media.

P&T Components

Ground-water extraction/injection systems are tailored to site-specific conditions and remediation goals. As a result, system component combinations yield a large variety of P&T configurations. A conceptual process flow diagram for a typical P&T system where volatile organic contaminants are removed from ground water by air stripping (and carbon adsorption polishing, as needed) is shown in Figure 17. Selected P&T system components are described below and in Table 2. Specific guidance regarding component selection and monitoring treatment system discharge compliance with appropriate regulations is beyond the scope of this document. Guidance regarding monitoring system effectiveness with respect to remedial design objectives is provided in Cohen et al. (1994).

Vertical Wells

Vertical wells are integral components of most P&T systems. Extraction wells are intended to capture and remove contaminated ground water; injection wells are used to enhance hydraulic containment and ground-water flushing rates. Basic component considerations include drilling/installation method, well diameter, screen and casing specifications, completion depth interval, and pump specifications. Detailed guidance on well drilling, construction, and development methods is provided by Repa and Kufs (1985), Driscoll (1986), Bureau of Reclamation (1995), and others.

Well yield and efficiency are of prime concern when designing extraction and injection wells. Yield is the rate at which ground water can be pumped under site-specific conditions (e.g., desired drawdown limits). Well losses caused by poor design or construction decrease well efficiency and result in increased drawdown within the well to maintain a particular yield. This is one reason that hydraulic head measurements taken in a pumping well are often poor indicators of hydraulic head in the formation immediately adjacent to the well. Within

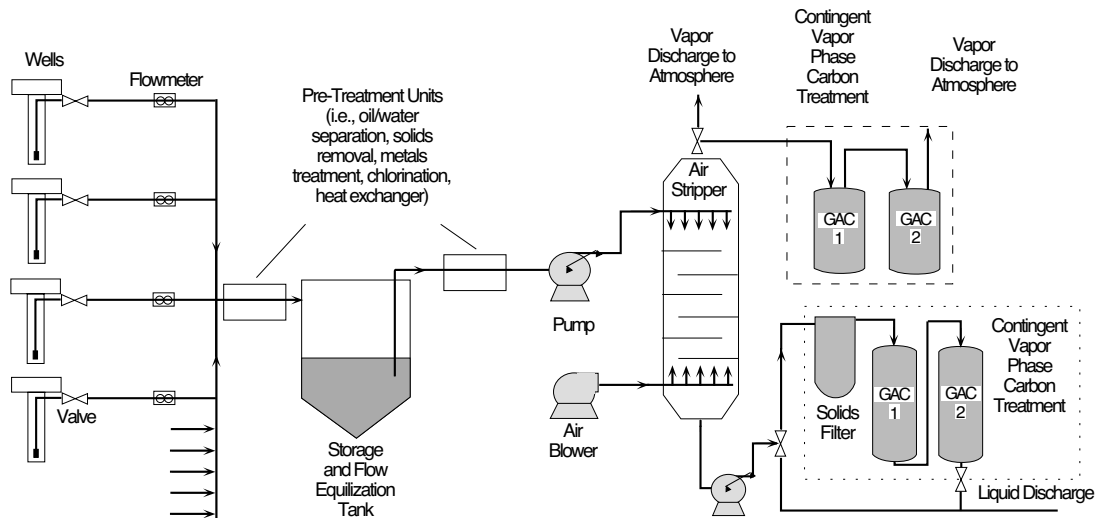

Figure 17. Example conceptual treatment diagram for a P&T system using air-stripping and optional granular activated carbon polishing treatment of liquid and vapor phase effluent from the air stripper.

Table 2. Appurtenant Pump-and-Treat Equipment

Equipment	Description
Piping	Conveys pumped fluids to treatment system and/or point of discharge. Piping materials will dictate if the system may be installed above or below grade with or without secondary containment measures. Piping materials (i.e., steel, HDPE, PVC, etc.) are selected based on chemical compatibility and strength factors.
Flowmeters	Measures flow rate at given time and/or the cumulative throughput in a pipe. Typically installed at each well, at major piping junctions, and after major treatment units. Some designs allow for the instrument to act as an on/off switch or flow regulator. Many different types are available.
Valves	The primary use of valves (i.e., gate, ball, check, butterfly) is to control flow in pipes and to connections in the pipe manifold. Valves may be operated manually or actuated by electrical or magnetic mechanisms. Check valves are used to prevent backflow into the well after pumping has ceased and siphoning from tanks or treatment units. Other uses for valves include sample ports, pressure relief, and air vents.
Level Switches Sensors	Float, optical, ultrasonic, and conductivity switches/sensors are used to determine the level of fluids in a well or tank. Used to actuate or terminate pumping and to indicate or warn operators of rising or falling fluid levels in wells and tanks.
Pressure Switches	Used to shut off pumps after detecting a drop in discharge pressure caused by a loss in suction pressure.
Pressure and Vacuum Indicators	Used to measure the pressure in pipes, across pipe connections, and in sealed tanks and vessels.
Control Panels	Device which provides centralized, global control of P&T system operation and monitors and displays system status. Control panels are typically custom designed for specific applications.
Remote Monitoring, Data Acquisition, & Telemetry Devices	Provides interactive monitoring and control of unattended P&T systems. Allows for real-time data acquisition. Alerts operators to system failures and provides an interface for remote reprogramming of operations. Remote monitoring devices should also be accessible from the Control Panel.
Pull and Junction Boxes	Above and/or below grade installations that allow access to connections in the piping manifold, electric wiring, and system controls. Strategic placement provides flexibility for system expansion.
Pitless Adaptor Unit	Allows for the transfer of extracted ground water from the well to buried piping outside of the well casing.
Well Cover	Available with padlock hasps, with and without a connection to the electrical conduit for submersible pumps.

limits, such parameters as screen diameter, screened interval, and screen open area are specified to optimize yield and maximize efficiency. Increased yield results in minimizing the number of wells required to attain specific system design objectives.

The well diameter must be large enough to accommodate the pump and other downhole instrumentation. The size of the pump required to obtain the desired yield, within the site-specific hydrogeologic limits, will determine the size of the casing. Although several different types of pumps may be selected, standard electric submersible pumps are most commonly used for extracting ground water at contamination sites. A close fit between the pump and casing promotes cooling of the submersible pump motor; but can lead to insertion or removal difficulties. Commonly, the casing diameter is sized two standard pipe sizes larger than the pump. For example, a 4-inch diameter pump is set in a 6-inch diameter well. The well diameter generally should be no less than one pipe size larger than the nominal pump diameter. Except for well point systems, pumping wells are usually at least four inches in diameter. The casing size should also be selected to ensure that the uphole velocity during pumping is <5 ft/sec (Driscoll, 1986) to prevent excessive head losses.

Pump selection depends on the desired pumping rate, well yield, and the total hydraulic head lift required. Designers should consult performance curves and data provided by pump manufacturers. Pneumatic pumps are used in some P&T applications, particularly at sites where providing electrical service is problematic, combustible vapors are present, or excessive drawdown might damage electric submersible pumps. Electric and pneumatic pumps that extract total fluids or separate liquid phases (e.g., LNAPL, water, and DNAPL) are readily available.

Extraction wells may be driven (or jetted) well points, naturally developed wells, or filter-packed wells. Screens and filter packs should be appropriately sized to the native media. Grain-size analyses of unconsolidated formation samples are highly recommended to determine appropriate slot and sandpack sizes. Wells can often be developed with natural packs in areas where the formation materials are permeable and relatively coarse grained. In naturally developed wells, the slot size is chosen so that most fines adjacent to the borehole are pumped through the screen during development. Custom screen design using sections with different slot sizes based on the grain size distribution of the different materials in the screened interval may be useful at sites where the highest possible specific capacity is desired.

Use of an artificial filter pack is advantageous when the geologic materials are highly laminated; highly uniform, fine-grained deposits; or in situations where a small screen slot size (e.g., <0.010 inch) dictated by natural pack criteria would significantly reduce the water transmitting capability of the screen (Driscoll, 1986). Filter pack materials generally are composed of clean, well-rounded, uniform-sized, siliceous grains and designed to retain most of the natural formation materials. The screen slot size is then typically selected to retain 90 percent of the sandpack. Grading of the filter pack is based on the finest-grained layer in the screened interval. Such a design generally does not restrict flow from coarser-grained layers as the hydraulic conductivity of the filter pack is significantly higher than the conductivity of these layers.

Filter packs mechanically retain formation particles. The factor controlling formation retention is the ratio of pack grain size to that of the formation, not pack thickness. Pack thickness recommendations from the literature for production wells range from approximately 3 inches to 8 inches (U.S. EPA, 1975). Pack thickness in the lower end of the recommended range will often be required to allow sufficient development for maximum well efficiency. Two common errors in filter packed wells that lead to low yields are use of a standard filter pack regardless of formation characteristics and use of screens with improper slot sizes for given filter pack characteristics (Driscoll, 1986).

Bedrock wells can be completed as open-holes; but screen and sandpack may be desirable to prevent caving and limit sand pumping. Well development by surging, jetting, backwashing, and pumping improves well efficiency. Driscoll (1986) provides a comprehensive treatise on well design, construction, and development and should be consulted prior to design.

Well screen and casing are frequently constructed of black low-carbon steel, Type 304 or Type 316 stainless steel, and PVC. Although low-carbon steel is frequently used for well casing, serious iron oxidation problems may occur when sodium hypochlorite is used to redevelop the wells. Iron flaking may cause clogging in injection wells. Manufacturers can provide advice on material compatibility with ground water and contaminants regarding the potential for corrosion, incrustation, and chemical attack. Material compatibility guidance is also available in various documents (e.g., Driscoll, 1986; McCaulou et al., 1995). The physical strength of the screen and casing materials is a concern for very deep wells. PVC casing may not be suitable for depths exceeding 300 feet, especially for large-diameter wells. Screens do not need to be as strong as casing because their openings relieve hydrostatic pressure, but must be able to withstand stresses associated with well installation and development. Screens are more susceptible to corrosion failure than steel casing. Whereas casing can suffer substantial corrosion and still function, minor screen corrosion can enlarge slot openings and result in severe sand pumping. This accounts for the use of stainless steel screens in conjunction with mild steel casing. For an economical well installation that resists degradation due to high concentrations of organic chemicals, stainless screen and casing can be threaded to PVC riser above the water table. Properties and dimensions of selected well casing products are highlighted in Table 3.

Generally, well screen diameter is selected to provide sufficient open area so that the velocity of water entering the screen is less than 0.1 ft/s to minimize friction losses, corrosion, and incrustation (Driscoll, 1986). Screen diameter influences well yield but to a lesser extent than does screen length. The potential increase of well yield with increasing screen diameter depends on site-specific conditions. Potential increases in some situations may be relatively insignificant. For example, in relatively conductive material where yields are high, increasing the screen diameter from 6 inches to 12 inches may only result in yield increases of several percent. In materials with low hydraulic conductivity, potential yield increases resulting from increased screen diameter may be significant and should be considered.

Open area of the screen affects entrance velocity and well efficiency. Limited open area limits well development and results in increased drawdown within the well for a specific yield.

Table 3. Properties and Dimensions of Selected Well Casing Products

Casing Material	Size (in.)	OD (in.)	ID (in.)	Wall thickness (in.)	Weight (lb/ft)	Collapse Strength (psi)	Comments
<i>Black Steel Thin Wall Water Well Casing</i>	4	4.500	4.216	0.142	6.60		+ Stronger, more rigid, and less temperature sensitive than PVC.
	6	6.625	6.249	0.188	12.9	1030	+ Much less expensive than stainless steel.
<i>Black Steel Schedule 40</i>	4	4.500	4.026	0.237	10.8		- Rusts easily, providing sorptive and reactive capacity for metals and organic chemicals.
	6	6.625	6.065	0.280	19.0	2286	- Subject to corrosion (given low pH, high dissolved oxygen, H ₂ S presence, >1000 mg/L TDS, >50 mg/L Cl ⁻).
<i>PVC Schedule 40 (PVC 12454)</i>	4	4.500	4.026	0.237	2.0	158	+ Lightweight, easy workability, inexpensive.
	6	6.625	6.065	0.280	3.6	78	+ Completely resistant to galvanic and electrochemical corrosion.
<i>PVC Schedule 80 (PVC 12454)</i>	4	4.500	3.826	0.337	2.8	494	+ High strength-to-weight ratio.
	6	6.625	5.761	0.432	5.4	314	+ Resistant to low concentrations of most organic contaminants.
<i>Stainless Steel Schedule 5</i>	4	4.500	4.334	0.083	3.9	315	- Poor chemical resistance to high concentrations of aromatic hydrocarbons, esters, ketones, and organic solvents.
	6	6.625	6.407	0.109	7.6	129	- Lower strength than steel; may not be suitable for very deep applications.
<i>Stainless Steel Schedule 40</i>	4	4.500	4.026	0.237	10.8	2672	+ Stronger, more rigid, and less temperature sensitive than PVC.
	6	6.625	6.065	0.280	19.0	1942	+ Good chemical resistance to organic chemicals.
							+ Resistant to corrosion and oxidation.
							- Expensive.
							- May corrode if exposed to long-term corrosive conditions.

Open area for different slot configurations (e.g., machine slotted vs. continuous slot) varies significantly. Continuous slot screens have significantly more open area per foot of screen than other slot configurations. Manufacturers should be consulted regarding open area of their screens. If the entrance velocity is calculated to be too high (i.e., > 0.1 ft/s), longer screens with greater open area, or larger diameter screens, where practical, should be considered.

The pump intake generally should not be placed in the well screen. Such placement may result in high screen entrance velocity, increased incrustation or corrosion rates, sand pumping, or dewatering of the screen (Driscoll, 1986). In general, the pump intake position does not greatly affect the relative volumes of water produced by different formation materials in the screened interval. In most situations, this distribution is predominantly controlled by the hydraulic properties (e.g., hydraulic conductivity) of the various materials.

Due to their tendency to clog, injection wells are typically overdesigned in terms of well diameter or screen length to reduce maintenance activities. Rather than using vertical wells, artificial recharge may be better accommodated by surface spreading, infiltration galleries, trenches, or horizontal wells.

These options have greater surface area and are less likely to clog than vertical wells.

Vertical Well Point Systems

Well point systems are comprised of multiple closely spaced wells that are connected via a main pipe header to a suction lift pump. Suction lift systems are limited to pumping shallow ground water at depths of less than approximately 25 feet. Such systems are based on construction dewatering technology. Well point systems are often used at sites where the hydraulic conductivity of aquifer materials is relatively low and large numbers of wells would be required to meet design objectives, particularly hydraulic containment or dewatering objectives. Where applicable, such systems may be more cost-effective than conventional wells. Well point systems are described in more detail in Bureau of Reclamation (1995).

Horizontal and Slant Wells

During recent years, directional drilling rigs from the utility, mining, and petroleum industries have been adapted to install horizontal wells at contaminated sites (Kaback et al., 1989;

Karlsson and Bitto, 1990; Langseth, 1990; Kaback et al., 1991; Morgan, 1992; Conger and Trichel, 1993; WSRC, 1993; U.S. EPA, 1994b; and CCEM, 1995). As of January 1996, more than 370 horizontal wells had been drilled at contamination sites in the United States for ground-water extraction (33%), soil vapor extraction (35%), air sparging (21%) and other purposes (11%) including petroleum recovery, ground-water infiltration, and bioventing (CCEM, 1996). Most of these wells (73%) were installed less than 26 feet deep by utility type contractors.

Horizontal wells can be drilled in soil or rock as continuous holes with surface access at each end or as blind holes (Figure 18). Slant wells are completed in straight angle borings. As shown in Figure 18, slant or horizontal wells can be strategically installed to: (1) allow injection or extraction in inaccessible areas such as beneath buildings, ponds, or landfills; (2) intercept multiple vertical fractures; and (3) provide hydraulic control along the leading edge of a plume or elsewhere by creating hydraulic line sinks (extraction) or pressure ridges (injection) without the need to excavate trenches. Horizontal wells with long screens may be more cost-effective than vertical wells, particularly at sites where contaminated ground water is extensive horizontally, but not vertically. The higher cost of horizontal wells, compared to vertical wells, may be offset by savings derived from more efficient remediation, drilling fewer wells, the purchase of fewer pumps, etc.

Horizontal well construction methods are described by U.S. EPA (1994b), CCEM (1995), and in drilling contractor literature. Continuous holes are typically drilled as inverted arcs from a surface entry point to a surface exit point. Using an adjustable angle, slant rotary drill rig, a pilot boring may be advanced at an angle to the desired subsurface elevation, directed along the completion path using a steerable drill head and a walkover radio-frequency (or other) guidance system, and then angled upward to exit the ground. Following completion of the pilot hole, the boring is cut to the final diameter using reamers. Rock holes may be advanced using a steerable tungsten carbide bit with a downhole air hammer, air rotary, or mud motor assembly. Drilling fluids, consisting of water, air, bentonite slurries, or polymeric solutions, are typically recycled through a closed-loop system to remove cuttings from the borehole. Well screen, casing, risers, filter fabric and/or pre-packed filter media are assembled at the exit end of a continuous hole and pulled into place behind the reamer. Pre-packed stainless steel screens have been selected for wells requiring a filter pack, but less expensive materials, including PVC, HDPE, steel, and fiberglass have also been used for well screen. Similar to conventional water wells, horizontal well screen and filter pack sizes are designed to optimize well yield and limit fine particle entry. Much greater compressive and tensile strength are required of horizontal well materials, however, to prevent failure during emplacement or wellbore collapse. Pre-packed filter materials are used due to the difficulty of placing sand, plugs, and grout in a horizontal well bore. Horizontal wells may be developed by pumping, swab/surging, and jetting. For blind wells, a washover bit and pipe are used to allow horizontal well construction within a temporary casing.

Trench Drain Systems

Trench drain systems are typically constructed perpendicular to the direction of ground-water flow to cut off and contain contaminant migration by creating a continuous hydraulic sink (Figure 19). A trench drain installed along the plume axis,

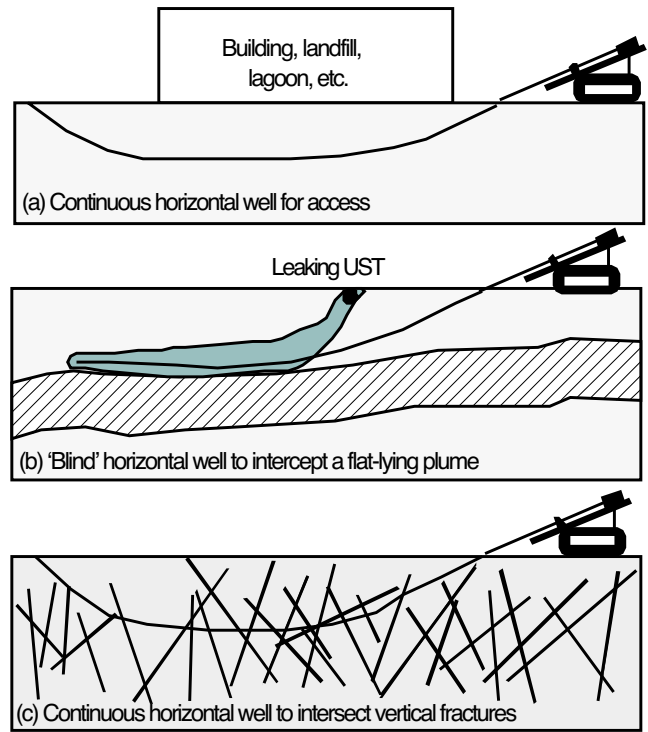

Figure 18. Several applications of horizontal wells (modified from U.S. EPA, 1994b).

however, will provide more effective contaminant mass removal (but may not provide complete containment). Designers should assess the potential for downgradient mounding of ground water transmitted along the length of a drain system, particularly if the drain is not oriented perpendicular to the natural flow direction. It may be appropriate to construct segmented drains to restrict flow along the drain length.

Trench drains are typically constructed using a backhoe to shallow depth in heterogeneous, low permeability media where many wells would be needed to obtain the required yield for capture of a specific area, but may also be suitable in moderate and high permeability soil. Although the depth limit for conventional excavation techniques is about 20 feet, specialized equipment can be used to install trench drains as deep as approximately 70 feet or deeper. The saturated zone of the trench is backfilled with a highly-permeable granular material such as sand or gravel. Geotextile filter fabric is placed around the permeable backfill to prevent fine particles from clogging the drain system. The upper few feet of the trench should be backfilled with low permeability material to reduce infiltration. Ground water that enters the granular backfill flows through the fill, and/or through perforated pipe installed near the trench bottom, to an extraction sump or sumps pumped to maintain a hydraulic sink along the drain.

Consideration should be given to pipe cleanout access and the installation of monitor wells along the drain length. At some locations, it may be advantageous to install an impermeable synthetic membrane on the downgradient side of a cutoff trench to prevent fluid bypass. Trench drain systems can also be used to inject treated or clean water to create pressure ridges and

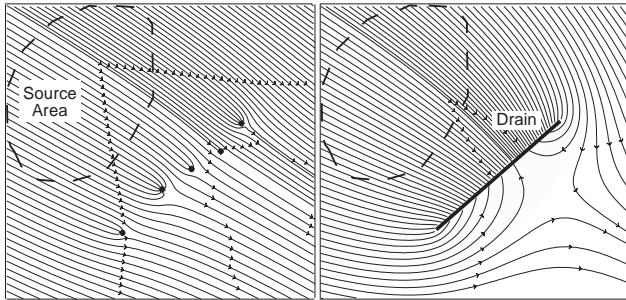

Figure 19. A trench drain constructed perpendicular to the direction of ground-water flow may provide more effective containment than extraction wells (e.g., for shallow contamination in heterogeneous, low-permeability media).

thereby enhance hydraulic containment and flushing rates. Drain depth, spacing, location, and other design criteria can be assessed using the computational tools described in Table 1 and various analytical solutions (Cohen and Miller, 1983).

The cost of excavating drains into bedrock is usually prohibitive. Drain construction also may be impractical due to access restrictions, building stability concerns, and costs associated with excavating large quantities of contaminated materials. Potential excavation stability problems can be addressed by using a trench box or other shoring methods, minimizing both the time that excavated sections are kept open and the length of open sections, and/or by use of guar gum or other gels (U.S. EPA, 1992c). Alternatively, 'one pass' trenching techniques may be applicable. For example, a 'one-pass' trencher can be used to excavate a 12-inch wide trench to a maximum depth of 22 feet, install a HDPE perforated collection pipe, and place granular backfill in a simultaneous operation (Gilbert and Gress, 1987). This method minimizes contaminant exposure during trenching, quantities of contaminated material requiring disposition, and stability problems. Additional information on trench drain systems is provided by Repa and Kufs (1985), Meini et al. (1990), Day (1991), and U.S. EPA (1991b, 1994b).

Treatment Technology Selection

Ground-water treatment technologies rely on physical, chemical, and/or biological processes to reduce contaminant concentrations to acceptable levels. Presumptive treatment technologies include use of: air stripping, granular activated carbon (GAC), chemical/UV oxidation, and aerobic biological reactors for dissolved organic contaminants; chemical precipitation, ion exchange/adsorption, and electrochemical methods for treatment of metals; and a combination of technologies to treat ground water containing both organic and inorganic constituents (U.S. EPA, 1996). Widely-used ground-water treatment technologies that are available as package plants are described in Appendix B.

The evaluation and selection of treatment alternatives for a particular P&T system is based on technical feasibility and costs (capital and operational) of achieving remediation goals. Key parameters that influence treatment design and efficacy include flow rate, ground-water constituents requiring treatment (including naturally occurring dissolved metals that may foul or interfere with a treatment system), influent concentrations, and

discharge requirements. Relationships between these parameters and treatment design are discussed briefly below, and in more detail by AWWA (1990), Nyer (1992), U.S. EPA (1994a), WEF (1994), and Noyes (1994).

The treatment flow rate, influent concentrations, and desired effluent concentrations influence the applicability of potential treatment methods. Flow rate is usually based on a projection of the pumping rate needed to achieve remediation goals. Treatment plant capacity may need to be increased where effluent is reinjected or where aggressive P&T is employed to hasten cleanup. The degree of contaminant concentration reduction required for each constituent is crucial to treatment design. For example, although GAC adsorption may reduce the concentration of a particular contaminant more than air stripping, depending on the discharge requirements, air stripping may be utilized as the sole technology, as pretreatment to GAC, or not at all. The discharge requirements often depend on the final disposal method for the treated water. Options include discharge to surface water, reinjection, discharge to another treatment system, or direct use. Regulations may preclude some options due to effluent concentrations, flow rate, or potential impacts to the ground water. Discharge to an existing treatment system (POTW or industrial treatment system) is generally the least restrictive option, but each system will have specific flow rate and concentration requirements. Effluent discharge to surface water and reinjection below the water table require permits.

The first step in selecting a treatment strategy is to exclude methods that are not implementable based on contaminant type, concentrations, flow rate, and site characteristics. Where multiple contaminants are present, some technologies may be excluded as complete solutions, but considered as a pretreatment or polishing step in a 'treatment train'. Thus, to effectively use air stripping for volatile organic contaminants, it may be necessary to pretreat the influent by chemical precipitation to remove dissolved metals that could foul the stripping unit. Examples of unit processes and sequences in ground-water treatment trains are listed in Table 4. At some sites, it may be beneficial to split ground water that is extracted from different areas into more than one treatment train (e.g., highly contaminated water from a source area may be treated differently than dilute downgradient ground water).

The technically implementable methods are then assessed with regard to effectiveness, relative implementability, and cost. An evaluation of effectiveness should consider the projected rate and duration of flow, the level of treatment required for each constituent, and the reliability of each method. Reliability may be difficult to assess for innovative technologies based on readily available data. In the absence of adequate performance data, treatability and pilot-scale testing should be conducted to yield critical data for use in technology selection, design of full-scale facilities, estimating costs, and identifying potential problems. The time element of treatment can be addressed during pilot studies by appropriate scaling of treatment units, flow rates, and concentrations (e.g., smaller capacity GAC units can be used to determine constituent breakthrough times more quickly). An evaluation of relative implementability should consider technical and administrative aspects, including permits, space limitations, storage and disposal options, availability of equipment, availability of skilled workers to implement the technology, visual impacts, and community relations. Cost estimates should include capital costs, annual costs, and an estimate of treatment duration; and cost comparisons should incorporate a discount rate for future costs and a cash flow analysis.

Treatment strategies should be designed and implemented in a manner that will accommodate changing conditions over the life cycle of a P&T project. At many sites, modifying treatment capacity or methods to match changing influent chemistry or flow rate over time can improve system performance and reduce cost. As with pumping, treatment optimization requires ongoing monitoring.

Proposed designs (e.g., extraction/injection well construction and placement, piping diagrams, treatment system design) should be presented in drawings and accompanied by detailed text discussion with appropriate tables. Discussion should include such topics as materials selection, proposed processes, and installation procedures. Rationale for design choices should also be discussed with supporting calculations presented and supporting data presented or referenced.

Technology Integration

Under favorable conditions (Figure 4), P&T technology can achieve clean-up goals. However, most, if not all, remedial

methods will have difficulty rapidly restoring ground-water quality to meet low concentration standards in the presence of highly sorbing contaminants, NAPL, and heterogeneous media. In these cases, remedial performance may be improved by integrating P&T operation with other clean-up technologies. This integration can occur spatially (e.g., where P&T is applied to the dissolved plume and other technologies are applied to source areas) and temporally (e.g., where multiple technologies are applied in series).

Remedial technology integration has occurred at many sites contaminated with petroleum product LNAPLs. Although mobile LNAPL may be pumped via extraction wells, immobile product will remain in the subsurface. Excavation is a candidate technology to remove shallow LNAPL. Due to their volatility and degradability, many petroleum products, such as gasoline, can also be remediated using SVE and enhanced bioremediation. Alternatively, natural attenuation may be demonstrated to be an effective petroleum contaminant management strategy at some sites.

Table 4. Common Treatment Train Unit Processes¹ and Sequence (modified from U.S. EPA, 1996)

Ground-Water Treatment Train Unit Processes			
<i>Solid or Liquid Separation Technologies</i>	<i>Primary Treatment Technologies</i>	<i>Effluent Polishing Technologies²</i>	<i>Vapor Phase Treatment Technologies³</i>
<ul style="list-style-type: none"> • Oil/grease separation⁴ • Filtration⁵ • Coagulation or flocculation⁵ • Clarification or sedimentation⁵ 	<p>For Organics:</p> <ul style="list-style-type: none"> • Air stripping • Granular activated carbon • Chemical/UV oxidation • Aerobic biological reactors <p>For Metals:</p> <ul style="list-style-type: none"> • Chemical precipitation • Ion exchange/adsorption • Electrochemical methods 	<ul style="list-style-type: none"> • Activated carbon • Ion exchange • Neutralization 	<ul style="list-style-type: none"> • Activated carbon • Catalytic oxidation • Thermal incineration • Acid gas scrubbing • Condensation

General Sequence of Ground-Water Treatment Train Unit Processes		
<i>Sequence</i>	<i>Unit Treatment Process</i>	<i>Treatment Stage</i>
Begin	Equalize inflow	Pre-treatment
	Separate solid particles	Pre-treatment
	Separate oil/grease (NAPLs)	Pre-treatment
	Remove metals	Treatment
	Remove volatile organic contaminants	Treatment
	Remove other organic contaminants	Treatment
	Polish organics ²	Post-treatment
	Polish metals	Post-treatment
End	Adjust pH, if required	Post-treatment

Notes: ¹ Technologies that may be required for treatment residuals, such as spent carbon, are not listed.
² Effluent polishing technologies are used for the final stage of treatment prior to discharge, and can include pH adjustment (neutralization) as well as additional removal of aqueous constituents.
³ Vapor phase contaminants released during water treatment may need to be contained and treated. These include organic contaminants volatilized during air stripping, from biological treatment, or other gases released from chemical oxidation, reduction, or biologic processes (e.g., hydrochloric acid, hydrogen sulfide, methane, etc.).
⁴ Methods for separating oil and/or grease from water include, but are not limited to, gravity separation and dissolved air flotation. These methods can be used to remove NAPLs from extracted water.
⁵ These technologies can be used to remove solid particles at the start of the treatment train or to remove other solids resulting from chemical precipitation, chemical/UV oxidation, or biological treatment.

These same technologies (extraction, excavation, SVE, air sparging and, to a lesser extent, bioremediation) have also been applied to DNAPL source areas where the chemicals have the appropriate properties. Additional technologies are being evaluated for NAPL recovery (i.e., surfactant flushing, steam flushing, alcohol flooding, hot water flooding, and surfactant-enhanced solubilization). Except for excavation, however, there are no proven technologies to remove sufficient DNAPL to fully restore a DNAPL-contaminated aquifer (U.S. EPA, 1992a). Therefore, hydraulic containment will remain an important management option for the DNAPL-contaminated portion of the subsurface.

Away from source areas, bioremediation also can be combined with P&T. Various solutions, including dissolved oxygen and nutrients, can be injected upgradient or within the contaminant plume to enhance biodegradation. At some sites, natural attenuation may be used in conjunction with or following ground-water extraction.

Natural attenuation refers to natural biological, chemical, and physical processes that reduce contaminant concentrations and mass. Also known as intrinsic remediation, it includes destructive chemical transformation processes (radioactive decay, biodegradation, and hydrolysis) and nondestructive partitioning and dilution processes (sorption, volatilization, and dispersion). At many sites, contaminant plume growth is restricted by biodegradation, partitioning, and/or dilution. For example, the limited mobility of many soluble petroleum hydrocarbons, such as BTEX compounds, in ground water due to biodegradation has been particularly well-documented (e.g., Barker et al., 1987).

Natural attenuation processes may be significant factors in contaminant removal and limitations to aqueous-phase contaminant migration at many sites. Field evaluation of such processes and rates is an area of continuing research. Proposed methodologies for evaluating natural attenuation of fuel contaminants are discussed in Wiedemeier et al. (1995) and McAllister and Chiang (1994).

Potentially cost-effective, innovative enhancements and alternatives to P&T (NRC, 1994) are being pilot-tested at many contamination sites. Permeable treatment walls using the funnel-and-gate approach are leading candidate remedial technologies (Starr and Cherry, 1994). These systems are designed to reduce contaminant concentrations in ground water that is passively funneled through a permeable reaction wall, which contains abiotic or biologically reactive media, an air sparge system, or some other enhancement.

Design of Operations and Maintenance

Detailed plans for evaluation of maintenance requirements should be established prior to installation. Establishment of the plan during the design stage allows for incorporation of features to simplify maintenance procedures (e.g., access ports for cleaning distribution piping in infiltration galleries). Maintenance such as pump replacement and well development may be performed on an as needed basis. The required frequency will depend on site conditions and equipment. Equipment manuals may be consulted regarding maintenance requirements for specific system components.

The major causes of decreased well performance include reduction in yield due to incrustation or biofouling of the screen

or adjacent materials, formation plugging by fine-grained materials, corrosion or incrustation resulting in increased water velocity and sand pumping, structural failure of the casing or screen, and pump damage (Driscoll, 1986). Periodic monitoring of total depth, pumping rate, drawdown, specific capacity, and efficiency may be used as indicators of maintenance requirements for extraction or injection wells. Injection wells and galleries are particularly susceptible to blockage or fouling and may require frequent maintenance. Maintenance schedules should be sufficiently frequent so as not to compromise system performance with respect to the established design objectives (e.g., maintain capture, maintain specified pore volume flushing rates). Additional discussion of operation and maintenance issues is provided in Driscoll (1986) and Bureau of Reclamation (1995).

Performance Monitoring

P&T performance is monitored by measuring hydraulic heads and gradients, ground-water flow directions and rates, pumping rates, pumped water and treatment system effluent quality, and contaminant distributions in ground water and porous media. These data are evaluated to interpret P&T capture zones, flushing rates, contaminant transport and removal, and to improve system operation. Detailed guidance on methods for monitoring P&T performance is provided by Cohen et al. (1994).

Restoration progress can be assessed by comparing the rate of contaminant mass removal (e.g., plotted as cumulative mass removed) to estimates of the dissolved and/or total contaminant mass-in-place. If the rate of contaminant mass extracted approximates the rate of dissolved mass-in-place reduction, then the contaminants removed by pumping are primarily derived from the dissolved phase. Conversely, a contaminant source (i.e., NAPL, sorbed contaminant, or a continuing release) is indicated where the mass removal rate greatly exceeds the rate of dissolved mass-in-place reduction. Site hydrogeology and contaminant properties should be evaluated to determine if source removal or containment, or P&T system modifications, could improve P&T performance.

The time needed to remove dissolved mass-in-place can be projected by extrapolating the trend of the mass removal rate curve or the cumulative mass removed curve. Future concentration tailing, however, may extend the extrapolated clean-up time. If the mass removal trend indicates a significantly greater clean-up duration than estimated originally, system modification may be necessary. The effect (or lack of effect) of P&T system modifications will be evidenced by the continuing mass removal rate and cumulative mass removed trends.

Progress inferred from mass removal rates can be misleading, however, where NAPL and solid phase contaminants are present (e.g., the mass removed will exceed the initial estimate of dissolved mass-in-place). Interpretation suffers from the high degree of uncertainty associated with estimating NAPL or solid contaminant mass-in-place. Stabilization of dissolved contaminant concentrations while mass removal continues may be an indication of NAPL or solid phase contaminant presence. Methods for evaluating the potential presence of NAPL are provided by Feenstra et al. (1991), Newell and Ross (1992), and Cohen and Mercer (1993).

Mass removal rates are also subject to misinterpretation where dissolved contaminant concentrations decline rapidly due to:

(1) mass transfer rate limitations to desorption, NAPL or precipitate dissolution, or matrix diffusion; (2) dewatering a portion or all of the contaminated zone; (3) dilution of contaminated ground water with clean ground water flowing to extraction wells from beyond the plume perimeter; or (4) the removal of a slug of highly contaminated ground water. Contaminant concentration rebound will occur if pumping is terminated prematurely in response to these conditions.

The projected restoration or clean-up time is site specific and varies widely depending on contaminant and hydrogeologic conditions and the clean-up concentration goal. Estimating clean-up time is complicated by difficulties in quantifying the initial contaminant mass distribution and processes that limit cleanup. Guidance for estimating ground-water restoration times using batch and continuous flushing models is provided by U.S. EPA (1988b). The batch flushing model is based on a series of consecutive discrete flushing periods during which contaminated water in equilibrium with adsorbed contaminants is displaced from the aquifer pore space by clean water. Values of contaminant concentration in soil and water are calculated after each flush. An example of an analogous method (and corrections) to this batch flushing model are provided by Zheng et al. (1991, 1992). The batch and continuous models assume that: (1) zero-concentration influent water displaces contaminated ground water from the contamination zone by simple advection with no dispersion; (2) the clean ground water equilibrates instantaneously with the remaining adsorbed contaminant mass; (3) the sorption isotherm is linear; and (4) chemical reactions do not affect the sorption process. Care must be taken to avoid relying on misleading estimates of restoration time that may be obtained by using these simplified models. Although more sophisticated modeling techniques are available (i.e., contaminant transport models), their application often suffers from data limitations, resulting in uncertain predictions. Nevertheless, clean-up time analyses are useful for assessing alternative remedial options and determining whether or not clean-up goals are feasible.

Disclaimer

The U.S. Environmental Protection Agency through its Office of Research and Development partially funded and collaborated in the research described here under Contract No. 68-C4-0031 to Dynamac Corporation. It has been subjected to the Agency's peer and administrative review and has been approved for publication as an EPA document. Mention of trade names or commercial products does not constitute endorsement or recommendation for use.

Quality Assurance Statement

All research projects making conclusions or recommendation based on environmentally related measurements and funded by the Environmental Protection Agency are required to participate in the Agency Quality Assurance Program. This project did not involve physical measurements and as such did not require a QA plan.

References

Ahlfeld, D.P., J.M. Mulvey, G.F. Pinder, and E.F. Wood, 1988. Contaminated groundwater remediation design using simulation, optimization and sensitivity theory, 1 Model development, *Water Resources Research*, 24(3):431-442.

Ahlfeld, D.P., and C.S. Sawyer, 1990. Well location in capture zone design using simulation and optimization techniques, *Ground Water*, 28(4):507-512.

Allen, H.E., E.M. Perdue, and D.S. Brown, 1993. *Metals in Groundwater*, Lewis Publishers, Boca Raton, FL.

American Petroleum Institute, 1989. A Guide to the Assessment and Remediation of Underground Petroleum Releases, API Publication No. 1628, Washington, DC.

American Petroleum Institute, 1992. Pump and Treat: The Petroleum Industry Perspective, API Publication No. 4561, Washington, DC.

Armstrong, J.E., E.O. Frind, and R.D. McClellan, 1994. Nonequilibrium mass transfer between vapor, aqueous, and solid phases in unsaturated soils during vapor extraction, *Water Resources Research*, 30(2):355-368.

Andersen, P.F., C.R. Faust, and J.W. Mercer, 1984. Analysis of conceptual design for remedial measures at Lipari Landfill, New Jersey, *Ground Water*, 22:176-190.

AWWA, 1990. *Water Quality and Treatment*, American Water Works Association, McGraw-Hill, Inc., New York, NY.

Bahr, J., 1989. Analysis of nonequilibrium desorption of volatile organics during a field test of aquifer decontamination, *Journal of Contaminant Hydrology*, 4(3):205-222.

Bair, E.S., A.E. Springer, and G.S. Roadcap, 1991. Delineation of travel time-related capture areas of wells using analytical flow models and particle tracking analysis, *Ground Water*, 29(3):387-397.

Bair, E.S., and G.S. Roadcap, 1992. Comparison of flow models used to delineate capture zones of wells: Leaky-confined fractured-carbonate aquifer, *Ground Water*, 30(2):199-211.

Barker, J.F., G.C. Patrick, and D. Major, 1987. Natural attenuation of aromatic hydrocarbons in a shallow sand aquifer, *Ground Water Monitoring Review*, 7(1):64-71.

Bear, J., 1972. *Dynamics of Fluids in Porous Media*, American Elsevier Publishing Co., New York, NY.

Blandford, T.N., P.S. Huyakorn, and Y. Wu, 1993. WHPA - A Modular Semi-Analytical Model for the Delineation of Wellhead Protection Areas, U.S. EPA Office of Drinking Water and Ground Water, Washington, DC.

Bonn, B.A., and S.A. Rounds, 1990. *DREAM — Analytical Ground Water Flow Programs*, Lewis Publishers, Boca Raton, FL.

Borden, R.C., and C.M. Kao, 1992. Evaluation of groundwater extraction for remediation of petroleum-contaminated aquifers, *Water Environ. Res.*, 64(1):2836.

Boulding, J.R., 1995. *Practical Handbook of Soil, Vadose Zone, and Ground-Water Contamination Assessment, Prevention, and Remediation*, Lewis Publishers, Boca Raton, FL.

- Brogan, S.D., 1991. Aquifer Remediation in the Presence of Rate-Limited Sorption, Masters Thesis, Stanford University, Palo Alto, CA.
- Brusseu, M.L., 1993. Complex Mixtures and Groundwater Quality, Environmental Research Brief, EPA/600/S-93/004, U.S. EPA, ORD, R.S. Kerr Environmental Research Laboratory, Ada, OK.
- Bureau of Reclamation, 1995. *Ground Water Manual*, U.S. Government Printing Office, Washington, DC.
- Carlsaw, H.S., and J.C. Jaeger, 1959. *Conduction of Heat in Solids*, Oxford University Press, London, England.
- CCEM, 1995. Horizontal News, Vol. 1, No. 1, Colorado Center for Environmental Management for the Department of Energy Office of Technology Development, Denver, CO.
- CCEM, 1996. Horizontal drilling survey results. Colorado Center for Environmental Management for the Department of Energy Office of Technology Development, Denver, CO.
- CCME, 1994. Subsurface Assessment Handbook for Contaminated Sites, Canadian Council of Ministers of the Environment Report CCME EPC-NCSRP48E.
- Cherry, J.A., S. Feenstra, and D.M. Mackay, 1992. Developing rational goals for in situ remedial technologies, *In: Subsurface Restoration Conference Proceedings, Third International Conference on Ground Water Quality Research*, National Center for Ground Water Research Dallas, TX, June 21-24, 1992.
- Cohen, R.M., and J.W. Mercer, 1993. *DNAPL Site Evaluation*, C.K. Smoley Press, Boca Raton, FL.
- Cohen, R.M., and W.J. Miller, 1983. Use of analytical models for evaluating corrective actions at hazardous waste disposal facilities, *Proceedings of the Third National Symposium on Aquifer Restoration and Ground Water Monitoring*, NWWA, Dublin, OH, pp. 85-97.
- Cohen, R.M., A.H. Vincent, J.W. Mercer, C.R. Faust, and C.P. Spalding, 1994. Methods for Monitoring Pump-and-Treat Performance, EPA/600/R-94/123, U.S. EPA, ORD, R.S. Kerr Environmental Research Laboratory, Ada, OK.
- Conger, R.M., and K. Trichel, 1993. A ground water pumping application for remediation of a chlorinated hydrocarbon plume with horizontal well technology, *Proceedings of the Seventh National Outdoor Action Conference and Exposition*, NGWA, Dublin, OH, pp. 47-61.
- Day, S.R., 1991. Extraction/interception trenches by the bio-polymer slurry drainage trench technique, *Hazardous Materials Control*, Sept/Oct, pp. 27-31.
- de Marsily, G., 1986. *Quantitative Hydrogeology: Groundwater Hydrology for Engineers*, Academic Press, Orlando, FL.
- Domenico, P.A., and F.W. Schwartz, 1990. *Physical and Chemical Hydrogeology*, John Wiley & Sons, New York, NY.
- Driscoll, F.G., 1986. *Ground Water and Wells*, Johnson Division, UOP, St. Paul, MN.
- EPRI, 1989. Techniques to Develop Data for Hydrogeochemical Models, Electric Power Research Institute Report EA-6637, Palo Alto, CA.
- Evans, J.C., 1991. Geotechnics of hazardous waste control systems, Chapter 20, *Foundation Engineering Handbook*, 2nd ed., H.Y. Fang, ed., Van Nostrand-Reinhold Co., New York, NY.
- Faust, C.R., P.N. Sims, C.P. Spalding, P.F. Andersen, B.H. Lester, M.G. Shupe, and A. Harrover, 1993. FTWORK: Groundwater Flow and Solute Transport in Three Dimensions, Version 2.8, GeoTrans, Inc., Sterling, VA.
- Feenstra, S., D.M. Mackay, and J.A. Cherry, 1991. A method for assessing residual NAPL based on organic chemical concentrations in soil samples, *Ground Water Monitoring Review*, 11(2):128-136.
- Felmy, A.R., D.C. Girvin, and E.A. Jenne, 1984. MINTEQ: A Computer Program for Calculating Aqueous Geochemical Equilibria, EPA/600/3-84/032, U.S. EPA, Washington, DC.
- Ferris, J.G., 1963. Cyclic water-level fluctuations as a basis for determining aquifer transmissivity, in *Methods for Determining Permeability, Transmissibility and Drawdown*, U.S. Geological Survey Water-Supply Paper 1536-I, pp. 305-318.
- Fetter, C.W., 1993. *Contaminant Hydrogeology*, Macmillan Publishing Company, New York, NY.
- Fitts, C.R., 1989. Simple analytic functions for modeling three-dimensional flow in layered aquifers, *Water Resources Research*, 25(5):943-948.
- Fitts, C.R., 1994. Well discharge optimization using analytic elements, *Ground Water*, 32(4):547-550.
- Fitts, C.R., 1995. TWODAN manual, Scarborough, ME.
- Freeberg, K.M., P.B. Bedient, and J.A. Connor, 1987. Modeling of TCE contamination and recovery in a shallow sand aquifer, *Ground Water*, 25:70-80.
- Gailey, R.M., and S.M. Gorelick, 1993. Design of optimal, reliable plume capture schemes: Application to the Gloucester landfill ground-water contamination problem, *Ground Water*, 31(1):107-114.
- Gilbert, S.G., and J.J. Gress, 1987. Interceptor trenches for positive ground-water control, *Ground Water Monitoring Review*, 7(2):55-59.
- Gillham, R.W., E.A. Sudicky, J.A. Cherry, and E.O. Frind, 1984. An advective-diffusive concept for solute transport in heterogeneous unconsolidated geologic deposits, *Water Resources Research*, 20(3):369-378.
- Gorelick, S.M., 1983. A review of distributed parameter groundwater management modeling methods, *Water Resources Research*, 19(2):305-319.

- Gorelick, S.M., R.A. Freeze, D. Donohue, and J.F. Keely, 1993. *Groundwater Contamination Optimal Capture and Containment*, Lewis Publishers, Boca Raton, FL.
- Greenwald, R.M., 1993. MODMAN - An Optimization Module for MODFLOW, Version 2.1, Documentation and User's Guide, GeoTrans, Inc., Sterling, VA.
- Grisak, G.E., and J.F. Picketts, 1980. Solute transport through fractured media: 1. The effect of matrix diffusion, *Water Resources Research*, 16:719-730.
- Grube, W.E., Jr., 1992. Slurry trench cut-off walls for environmental pollution control, *Slurry Walls: Design, Construction and Quality Control*, ASTM STP 1129, D.B. Paul, R.R. Davidson, and N.J. Cavalli, eds., American Society for Testing and Materials, Philadelphia, PA.
- Grubb, D.G., and N. Sitar, 1994. Evaluation of Technologies for In-Situ Cleanup of DNAPL Contaminated Sites, EPA/600/R-94/120, U.S. EPA, ORD, R.S. Kerr Environmental Research Laboratory, Ada, OK.
- Hagemeyer, R.T., P.F. Andersen, R.M. Greenwald, and J.L. Clausen, 1993. Evaluation of alternative plume containment designs at the Paducah Gaseous Diffusion Plant Using MODMAN, a well pumpage optimization module for MODFLOW, *Proceedings of the 1993 Ground Water Modeling Conference*, IGWMC, Colorado School of Mines, Golden, CO, pp. 2-42 to 2-51.
- Haggerty, R., and S.M. Gorelick, 1994. Design of multiple contaminant remediation: Sensitivity to rate-limited mass transport, *Water Resources Research*, 30(2):435-446.
- Haitjema, H.M., J. Wittman, V. Kelson, and N. Bauch, 1994. WhAEM: Program Documentation for the Wellhead Analytical Element Model, EPA/600/R-94/210, U.S. EPA, ORD, R.S. Kerr Environmental Research Laboratory, Ada, OK.
- Haley, J.L., B. Hanson, C. Enfield, and J. Glass, 1991. Evaluating the effectiveness of ground water extraction systems, *Ground Water Monitoring Review*, 11(1):119-124.
- Harvey, C.F., R. Haggerty, and S.M. Gorelick, 1994. Aquifer remediation: A method for estimating mass transfer rate coefficients and an evaluation of pulsed pumping, *Water Resources Research*, 30(7):1979-1991.
- Jacob, C.E., 1950. Flow of ground water, in *Engineering Hydraulics*, Rouse, H., ed., John Wiley & Sons, New York, NY, pp. 321-386.
- Javandel, I., C. Doughty, and C.F. Tsang, 1984. *Groundwater Transport: Handbook of Mathematical Models*, American Geophysical Union Water Resources Monograph No. 10, Washington, DC.
- Javandel, I., and C.F. Tsang, 1986. Capture-zone type curves: A tool for aquifer cleanup, *Ground Water*, 24:616-625.
- Kaback, D.S., B.B. Looney, J.C. Corey, L.M. Wright, and J.L. Steele, 1989. Horizontal wells for in situ remediation of ground water and soils, *Proceedings of the Third National Outdoor Action Conference on Aquifer Restoration, Ground Water Monitoring, and Geophysical Methods*, NWWA, Dublin, OH, pp. 121-135.
- Kaback, D.S., B.B. Looney, C.A. Eddy, and T.C. Hazen, 1991. Innovative ground-water and soil remediation: In situ air-stripping using horizontal wells, *Proceedings of the Fifth National Outdoor Action Conference on Aquifer Restoration, Monitoring, and Geophysical Methods*, NWWA, Dublin, OH, pp. 47-58.
- Karlsson, H., and R. Bitto, 1990. New horizontal wellbore system for monitoring and remedial wells, *Proceedings of the 11th National Superfund Conference*, HMCRI, Silver Spring, MD, pp. 357-362.
- Keely, J.F., 1989. Performance Evaluation of Pump-and-Treat Remediations, EPA/540/4-89/005, U.S. EPA, ORD, R.S. Kerr Environmental Research Laboratory, Ada, OK.
- Kharaka, Y.K., W.D. Gunter, P.K. Aggarwal, and E.H. Perkins, 1988. SOLMINEQ.88 - Solution-mineral equilibrium computations., U.S. Geological Survey, Menlo Park, CA.
- Konikow, L.F., and J.D. Bredehoeft, 1989. Computer Model of Two-Dimensional Solute Transport and Dispersion in Ground Water, U.S. Geological Survey, Reston, VA.
- Kruseman, G.P., and N.A. deRidder, 1990. *Analysis and Evaluation of Pumping Test Data*, International Institute of Land Reclamation and Improvement, Bulletin 11, 2nd ed., Wageningen, The Netherlands.
- Langseth, D.E., 1990. Hydraulic performance of horizontal wells, *Proceedings of the 11th National Superfund Conference*, HMCRI, Silver Spring, MD, pp. 398-408.
- Lefkoff, L.J., and S.M. Gorelick, 1987. AQMAN: Linear and Quadratic Programming Matrix Generator Using Two-dimensional Groundwater Flow Simulation for Aquifer Management Modeling, U.S. Geological Survey Water Resources Investigations Report 87-4061.
- Long, G.M., 1993. Clean up hydrocarbon contamination effectively, *Chemical Engineering Progress*, 89(5).
- Mackay, D.M., and J.A. Cherry, 1989. Groundwater contamination: Pump-and-treat remediation, *Environmental Science and Technology*, 23(6):620-636.
- Marquis, Jr., S.A., and D. Dineen, 1994. Comparison between pump and treat, bioremediation, and bioremediation/pump and treat combined: Lessons from computer modeling, *Ground Water Monitoring and Remediation*, 14(2):105-119.
- McAllister, P.M., and C.Y. Chiang, 1994. A practical approach to evaluating natural attenuation of contaminants in ground water, *Ground Water Monitoring and Remediation*, 14(2):161-173.
- McCaulou, D.R., D.G. Jewett, and S.G. Huling, 1995. Nonaqueous Phase Liquids Compatibility with Materials Used in Well Construction, Sampling, and Remediation, EPA/540/S-95/503, Ground Water Issue Paper, U.S. EPA, ORD, R.S. Kerr Environmental Research Laboratory, Ada, OK.
- McDonald, M.G., and A.W. Harbaugh, 1988. A Modular Three-Dimensional Finite-Difference Groundwater Flow Model, U.S. Geological Survey Techniques of Water-Resources Investigations, Book 6, Chapter A1, Reston, VA.

- McKay, L.D., R.W. Gillham, and J.A. Cherry, 1993. Field experiments in a fractured clay till: 2. Solute and colloid transport, *Water Resources Research*, 29:3879-3890.
- Meini, D., M. Ghiasi, R.J. Patterson, N. Ramanujam, and M.P. Tyson, 1990. Extraction of TCE-contaminated ground water by subsurface drains and a pumping well, *Ground Water*, 28(1):17-24.
- Mercer, J.W., D.C. Skipp, and D. Giffin, 1990. Basics of Pump-and-Treat Groundwater Remediation, EPA/600/8-90/003, U.S. EPA, ORD, R.S. Kerr Environmental Research Laboratory, Ada, OK.
- Montgomery, J.H., and L.M. Welkom, 1990. *Groundwater Chemicals Desk Reference*, Lewis Publishers, Boca Raton, FL.
- Morgan, J.H., 1992. Horizontal drilling applications of petroleum technologies for environmental purposes, *Ground Water Monitoring Review*, 12(3):98-101.
- Myrand, D., R.W. Gillham, E.A. Sudicky, S.F. O'Hannesin, and R.L. Johnson, 1992. Diffusion of volatile organic compounds in natural clay deposits: Laboratory tests, *Journal of Contaminant Hydrology*, 10:159-177.
- NRC, 1994. *Alternatives for Ground Water Cleanup*, National Research Council, National Academy Press, Washington, DC.
- Newell, C.J., S.D. Acree, R.R. Ross, and S.G. Huling, 1995. Light Nonaqueous Phase Liquids, EPA/540/S-95/500, U.S. EPA, ORD, R.S. Kerr Environmental Research Laboratory, Ada, OK.
- Newell, C.J., and R.R. Ross, 1992. Estimating potential for occurrence of DNAPL at Superfund sites, U.S. EPA Quick Reference Fact Sheet, U.S. EPA, ORD, R.S. Kerr Environmental Research Laboratory, Ada, OK.
- Newsom, J.M., and J.L. Wilson, 1988. Flow of ground water to a well near a stream — Effect of ambient ground-water flow direction, *Ground Water*, 26(6):703-711.
- Nielsen, D.M., ed., 1991. *Practical Handbook of Ground-Water Monitoring*, Lewis Publishers, Boca Raton, FL.
- Noyes, R., 1994. *Unit Operations in Environmental Engineering*, Noyes Publications, Park Ridge, NJ.
- Nyer, E.K., 1992. *Groundwater Treatment Technology*, Van Nostrand-Reinhold, New York, NY.
- Osborne, P.S., 1993. Suggested Operating Procedures for Aquifer Pumping Tests, Ground Water Issue Paper, EPA/540/S-93/503, U.S. EPA, ORD, R.S. Kerr Environmental Research Laboratory, Ada, OK.
- OTA, 1984. Protecting the Nation's Groundwater from Contamination, U.S. Congressional Office of Technology Assessment, OTA-O-276, Volumes I and II, Washington, DC.
- Palmer, C.D., and W. Fish, 1991. Physicochemical processes: Inorganic contaminants, in Site Characterization for Subsurface Remediation, U.S. EPA Seminar Publication, EPA/925/4-91/026, U.S. EPA, ORD, R.S. Kerr Environmental Research Laboratory, Ada, OK, pp. 179-192.
- Palmer, C.D., and W. Fish, 1992. Chemical Enhancements to Pump-and-Treat Remediation, U.S. EPA Ground Water Issue Paper, EPA/540/S-92/001, U.S. EPA, ORD, R.S. Kerr Environmental Research Laboratory, Ada, OK.
- Pankow, J.F., and J.A. Cherry, eds, 1995. *Dense Chlorinated Solvents and Other DNAPLs in Groundwater: History, Behavior, and Remediation*, Waterloo Press, Waterloo, Ontario, Canada.
- Papadopoulos, S.S., 1965. Nonsteady flow to a well in an infinite anisotropic aquifer, *Proceedings of Symposium International Association of Scientific Hydrology*, Dubrovnik, pp. 21-31.
- Parker, B.L., R.W. Gillham, and J.A. Cherry, 1994. Diffusive disappearance of immiscible phase organic liquids in fractured geologic media, *Ground Water*, 32(5):805-820.
- Parkhurst, D.L., D.C. Thorstenson, and L.N. Plummer, 1980. PHREEQE - A Computer Program for Geochemical Calculations, U.S. Geological Survey Water Resources Investigation 80-96, USGS, Reston, VA.
- Pollock, D.W., 1994. User's Guide for MODPATH, MODPATH-PLOT, Version 3: A Particle Tracking Post-Processing Package for MODFLOW, U.S. Geological Survey Open-File Report 94-464, USGS, Reston, VA.
- Powers, S.E., C.O. Loureiro, L.M. Abriola, and W.J. Weber, Jr., 1991. Theoretical study of the significance of nonequilibrium dissolution of nonaqueous phase liquids in subsurface systems, *Water Resources Research*, 27(4):463-477.
- Pyne, R.D.G., 1995. *Groundwater Recharge and Wells, A Guide to Aquifer Storage Recovery*, Lewis Publishers, Boca Raton, FL.
- Rabideau, A.J., and C.T. Miller, 1994. Two-dimensional modeling of aquifer remediation influenced by sorption nonequilibrium and hydraulic conductivity heterogeneity, *Water Resources Research*, 30(5):1457-1470.
- Repa, E., and C. Kufs, 1985. Leachate Plume Management, EPA/540/2-85/004, U.S. EPA, Hazardous Waste Engineering Research Laboratory, Office of Research and Development, Cincinnati, OH.
- Rifai, H.S., P.B. Bedient, R.C. Borden, and J.F. Haasbeek, 1987. BIOPLUME II - Computer model of two-dimensional contaminant transport under the influence of oxygen limited biodegradation in ground water, Version 1.0, EPA/600/8-88-093, February 1989.
- Rumbaugh, J.O., 1991. Quick Flow: Analytical ground-water flow model, Version 1.0, Geraghty and Miller, Plainview, NY.
- Rumer, R.R. and M.E. Ryan, eds., 1995. *Barrier Containment Technologies for Environmental Remediation Applications*, John Wiley & Sons, Inc., New York, NY.
- Runnells, 1993. Inorganic chemical processes and reactions, in Regional Ground-Water Quality, W.M. Alley, ed., Van Nostrand-Reinhold, New York, pp. 131-153.
- Sara, M.N., 1994. *Standard Handbook for Solid and Hazardous Waste Facility Assessments*, Lewis Publishers, Boca Raton, FL.

- Saroff, S.T., H. He, and G. Powell, 1992. Hydrogeological implications of saprolite aquifer remediation at Fairfax, Virginia, oil spill, *Proceedings of HMCRI's 13th Annual National Conference and Exhibition, Hazardous Materials Control Research Institute, Silver Spring, MD*, pp. 407-412.
- Satkin, R.L., and P.B. Bedient, 1988. Effectiveness of various aquifer restoration schemes under variable hydrogeologic conditions, *Ground Water*, 26(4):488-498.
- Schmelling, S.G., and R.R. Ross, 1989. Contaminant Transport in Fractured Media: Models for Decision Makers, U.S. EPA Ground Water Issue Paper, EPA/540/4-89/004, U.S. EPA, ORD, R.S. Kerr Environmental Research Laboratory, Ada, OK.
- Shafer, J.M., 1987a. Reverse pathline calculation of time-related capture zones in nonuniform flow, *Ground Water*, 25(3):282-289.
- Shafer, J.M., 1987b. GWPATH: Interactive Groundwater Flow Path Analysis, Illinois State Water Survey, Bulletin 69.
- Starr, R.C., and J.A. Cherry, 1994. In situ remediation of contaminated ground water: The funnel-and-gate system, *Ground Water*, 32(3):465-476.
- Strack, O.D.L., 1989. *Groundwater Mechanics*, Prentice Hall, Englewood Cliffs, NJ.
- Strack, O.D.L., E.I. Anderson, M. Bakker, W.C. Olsen, J.C. Panda, R.W. Pennings, and D.R. Steward, 1994. CZAEM User's Guide: Modeling Capture Zones of Ground-Water Using Analytic Elements, EPA/600/R-94/174, Office of Research and Development, Cincinnati, OH.
- Stumm, W., 1992. *Chemistry of the Solid-Water Interface*, John Wiley & Sons, New York, NY.
- Tiedeman, C., and S.M. Gorelick, 1993. Analysis of uncertainty in optimal groundwater contaminant capture design, *Water Resources Research*, 29(7):2139-2153.
- Trescott, P.C., G.F. Pinder, and S.P. Larson, 1976. Finite-Difference Model for Aquifer Simulation in Two Dimensions with Results of Numerical Experiments, U.S. Geological Survey Techniques of Water Resource Investigations Book 7, Chapter C1, USGS, Reston, VA.
- Truesdell, A.H., and B.F. Jones, 1974. WATEQ: A Computer Program for Calculating Chemical Equilibria of Natural Waters, U.S. Geological Survey Journal of Research, 2:233-248.
- U.S. EPA, 1975. Manual of Water Well Construction Practices, EPA-570/9-75/001, Office of Water Supply, Washington, DC.
- U.S. EPA, 1984. Slurry Trench Construction for Pollution Migration Control, EPA-540/2-84/001, U.S. EPA, Municipal Environmental Research Laboratory, Office of Research and Development, Cincinnati, OH.
- U.S. EPA, 1988a. Guidance for Conducting Remedial Investigations and Feasibility Studies under CERCLA, EPA/540/G-89/004, U.S. EPA, Washington, DC.
- U.S. EPA, 1988b. Guidance on Remedial Actions for Contaminated Ground Water at Superfund Sites, EPA/540/G-99/003, OSWER Directive 9283.1-2, U.S. EPA, Washington, DC.
- U.S. EPA, 1989. Guide for Conducting Treatability Studies Under CERCLA, EPA/540/2-89/058, U.S. EPA, Office of Research and Development, Cincinnati, OH.
- U.S. EPA, 1991a. Site Characterization for Subsurface Remediation, Seminar Publication, EPA/625/4-91/026, U.S. EPA, Center for Environmental Research Information, Office of Research and Development, Cincinnati, OH.
- U.S. EPA, 1991b. Handbook — Stabilization Technologies for RCRA Corrective Actions, EPA/625/6-91/026, U.S. EPA, Office of Research and Development, Washington, DC.
- U.S. EPA, 1992a. Dense nonaqueous phase liquids — A workshop summary, Dallas, Texas, April 17-18, 1991, EPA/600/R-92/030, U.S. EPA, ORD, R.S. Kerr Environmental Research Laboratory, Ada, OK.
- U.S. EPA, 1992b. Evaluation of Ground-Water Extraction Remedies, U.S. EPA, Office of Emergency and Remedial Response, Washington, DC.
- U.S. EPA, 1992c. RCRA Corrective Action Stabilization Technologies, EPA/625/R-92/014, U.S. EPA, Office of Research and Development, Washington, DC.
- U.S. EPA, 1993a. Guidance for evaluating the technical impracticability of ground-water restoration, Directive 9234.2-25, Interim Final, U.S. EPA, Office of Solid Waste and Emergency Response, Washington, DC.
- U.S. EPA, 1993b. Subsurface Characterization and Monitoring Techniques, A Desk Reference Guide, Volumes I and II, EPA/625/R-93/003, U.S. EPA, Washington, DC.
- U.S. EPA, 1994a. Manual - Ground-Water and Leachate Treatment Systems, EPA/625/R-94/005, U.S. EPA, Office of Research and Development, Cincinnati, OH.
- U.S. EPA, 1994b. Alternative Methods for Fluid Delivery and Recovery, EPA/625/R-94/003, U.S. EPA, Center for Environmental Research Information, Cincinnati, OH.
- U.S. EPA, 1995. How to Evaluate Alternate Cleanup Technologies for Underground Storage Tank Sites, EPA/510/B-94/003, U.S. EPA, Office of Underground Storage Tanks, Washington, DC.
- U.S. EPA, 1996. Presumptive Response Strategy and Ex-Situ Treatment Technologies for Contaminated Ground Water at CERCLA Sites, U.S. EPA, Office of Solid Waste and Emergency Response, EPA/540/R-96/023.
- van der Heijde, P.K.M., and O.A. Elnawawy, 1993. Compilation of Ground-Water Models, EPA/600/R-93/118, U.S. EPA, ORD, R.S. Kerr Environmental Research Laboratory, Ada, OK.
- Wagner, B.J., and S.M. Gorelick, 1987. Optimal groundwater quality management under parameter uncertainty, *Water Resources Research*, 23(7):1162-1174.

-
- Ward, D.S., D.R. Buss, J.W. Mercer, and S.S. Hughes, 1987. Evaluation of a groundwater corrective action at the Chem-Dyne hazardous waste site using a telescopic mesh refinement modeling approach, *Water Resources Research*, 23(4):603-617.
- Ward, D.S., A.L. Harrover, A.H. Vincent, and B.H. Lester, 1993. Data Input Guide for SWIFT/486, GeoTrans, Inc., Sterling, VA.
- WEF, 1994. Pretreatment of Industrial Wastes, Manual of Practice No. FD-3, Water Environment Federation, Alexandria, VA.
- Wiedemeier, T.H., J.T. Wilson, D.H. Kampbell, R.N. Miller, and J.E. Hansen, 1995. Technical Protocol for Implementing Intrinsic Remediation with Long-Term Monitoring for Natural Attenuation of Fuel Contamination Dissolved in Groundwater, Volume I, Air Force Center for Environmental Excellence, Brooks AFB, San Antonio, TX.
- Wilson, J.L., 1984. Double-cell hydraulic containment of pollutant plumes, *Proceedings of the Fourth National Symposium and Exposition on Aquifer Restoration and Ground Water Monitoring*, NWWA, Dublin, OH, pp. 65-70.
- Wolery, T.J., 1979. Calculations of Chemical Equilibrium between Aqueous Solutions and Minerals: The EQ3/6 Software Package, UCRL-52658, Lawrence Livermore Laboratory, Livermore, CA.
- WSRC, 1993. Summary Report of the Drilling Technologies Tested at the Integrated Demonstration Site, WSRC-TR-93-565, Westinghouse Savannah River Company, Aiken, SC.
- Zheng, C., 1990. PATH3D - A Ground-Water Path and Travel-Time Simulator, Version 2.0, User's Manual, S.S. Papadopoulos and Associates, Bethesda, MD.
- Zheng, C., 1992. MT3D - A Modular Three-Dimensional Transport Model for Simulation of Advection, Dispersion, and Chemical Reactions of Contaminants in Groundwater Systems, S.S. Papadopoulos and Associates, Bethesda, MD.
- Zheng, C., G.D. Bennett, and C.B. Andrews, 1991. Analysis of ground-water remedial alternatives at a Superfund site, *Ground Water*, 29(6):838-848.
- Zheng, C., G.D. Bennett, and C.B. Andrews, 1992. Reply to discussion of analysis of ground-water remedial alternatives at a Superfund site, *Ground Water*, 30(3):440-442.

Appendix A

Limitations for Conventional P&T Technology

Widespread experience with P&T systems during the past 15 years indicates that their ability to reduce and maintain dissolved contaminant concentrations below clean-up standards in reasonable time frames is hindered at many sites due to complex hydrogeologic conditions, contaminant chemistry factors, and inadequate system design (Keely, 1989; Mercer et al., 1990; U.S. EPA, 1993a; NRC, 1994; and Cohen et al. 1994). Hydrogeologic conditions that confound ground-water cleanup include the presence of complex sedimentary deposits, low permeability formations, and fractured bedrock. Chemical processes that cause contaminant concentration tailing and rebound during and after P&T operation, respectively, and thereby impede complete aquifer restoration, include: (1) the presence and slow dissolution of nonaqueous phase liquids (NAPLs); (2) contaminant partitioning between ground water and porous media; and (3) contaminant diffusion into low permeability regions that are inaccessible to flowing ground water. These limitations may render restoration using only conventional P&T technology impracticable at some sites.

NAPL Dissolution

NAPLs that are denser than water (DNAPLs), in particular, exacerbate ground-water restoration efforts. This is due to their prevalence at contamination sites, their complex subsurface migration behavior and distribution, their low aqueous solubility, and limits to DNAPL removal using available technologies (U.S. EPA, 1992a; Grubb and Sitar, 1994; and Pankow and Cherry, 1995). Greater success has been achieved remediating petroleum hydrocarbon LNAPLs using conventional methods and enhanced technologies such as soil vapor extraction, bioremediation, and air sparging.

Subsurface NAPL trapped as ganglia at residual saturation or contained in pools can be a long-term source of ground-water contamination, as illustrated in Figure 8-d, due to its limited aqueous solubility that may greatly exceed drinking water standards. At many sites, NAPL pools will continue to contaminate ground water long after residual fingers and ganglia have dissolved completely (Cohen and Mercer, 1993). If NAPLs are not removed (e.g., by excavation) or contained (as depicted in Figure 2), then tailing and rebound will occur during and after P&T operation, respectively, in and downgradient of the NAPL zone. Above residual saturation, NAPL will flow unless it is immobilized in a stratigraphic trap or by hydrodynamic forces. NAPL movement can greatly expand the subsurface volume where restoration is impractical. A critical element of site characterization, therefore, is to delineate the nature and extent of mobile and residual NAPL so that these source areas can be removed or contained. Detailed guidance on NAPL site characterization is provided by American Petroleum Institute (1989), U.S. EPA (1992a), Cohen and Mercer (1993), and Newell et al. (1995).

Contaminant Sorption and Desorption

Sorption/desorption also cause tailing, concentration rebound, and slow ground-water restoration. As dissolved contaminant concentrations are reduced by P&T operation, contaminants sorbed to subsurface media desorb from the matrix and dissolve in ground water. The volume of ground water that must be passed through a contamination zone to attain clean-up standards increases with contaminant sorption and kinetic limitations to the rate of desorption.

Equilibrium contaminant partitioning between porous media and ground water can be described by the Langmuir or Freundlich isotherms (Figure A-1). For the linear isotherms ($N = 1$) and for limited ranges of C_w (particularly at low concentration) where $N \neq 1$, the Freundlich constant, K_f , can be identified as a soil-water distribution coefficient, K_d :

$$K_d = C_s / C_w \quad (A-1)$$

where C_s and C_w are the equilibrium contaminant concentrations in soil and water, respectively.

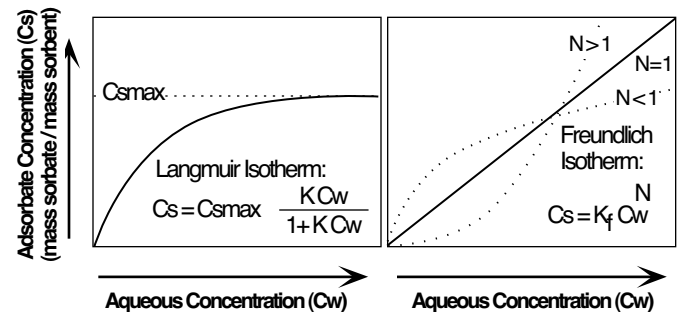

Figure A-1 The Langmuir and Freundlich adsorption isotherms (modified from Palmer and Fish, 1992).

Contaminant K_d values must be characterized to predict ground-water restoration times for different P&T schemes or for natural ground-water flushing. By assuming that sorption is instantaneous, reversible, and linear, K_d values can be used to estimate: (1) the retardation factor, R ,

$$R = 1 + K_d \rho_b / n \quad (A-2)$$

and (2) the equilibrium distribution of contaminant mass between the solid and aqueous phases

$$f_w = C_w V_w / [(C_w V_w) + (C_s M_s)] = V_w / (V_w + K_d M_s) \quad (\text{A-3})$$

where ρ_b is the dry bulk density of the media, n is the media porosity, V_w is the volume of water in the total subject volume, M_s is the mass of solids in the total subject volume, and f_w is the fraction of mass residing in the aqueous phase.

Although the ratio of bulk density to porosity is typically within a range of four to six, K_d values for different contaminants vary over orders-of-magnitude (e.g., Montgomery and Welkom, 1990). Thus, contaminant velocity and P&T restoration time are particularly sensitive to soil-water partitioning (K_d values) of ground-water contaminants.

The nonlinearity of contaminant desorption and difficulty of contaminant removal appear to increase with the duration of contaminant presence in the subsurface (Brusseau, 1993). Thus, old plumes are likely to exhibit significant nonideal behavior. Conversely, ground-water cleanup may be simplified if remedial efforts are undertaken quickly after the occurrence of a contaminant release.

Sorption and retardation values vary between different contaminants at a given site and between different sites for a given contaminant (Mackay and Cherry, 1989). As depicted in Figure 8, desorption and retardation increase the volume of ground water that must be pumped to attain dissolved contaminant concentration reductions. Tailing and rebound effects will be exacerbated where desorption is slow relative to ground-water flow and kinetic limitations prevent sustenance of equilibrium contaminant concentrations in ground water (Bahr, 1989; Brogan, 1991; Haley et al., 1991; and Palmer and Fish, 1992). This concept is illustrated in Figure A-2.

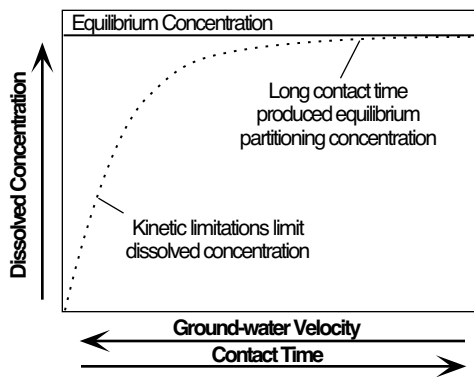

Figure A-2. Relationship between ground-water velocity and the concentration of dissolved contaminants that (a) desorb from porous media, (b) dissolve from precipitates, or (c) dissolve from NAPL (modified from Keely, 1989). Kinetic limitations to dissolution exacerbate tailing.

Solids Dissolution

Important physicochemical processes that affect the solubility, reactivity, mobility, and toxicity of inorganic contaminants include: (1) chemical speciation, (2) oxidation/reduction, (3) dissolution/precipitation, (4) ion exchange and sorption, and (5) particle

transport (Palmer and Fish, 1991). Inorganic contaminants occur in many different chemical forms or "species." Knowing the total concentration of an inorganic element in ground water or soil, as commonly provided by laboratory analysis, may be of little value (alone) in assessing its subsurface behavior. Rather, it is often more important to determine contaminant speciation which depends on several factors including pH, Eh, ion and gas concentrations, and temperature. For example, metal cations combine with different anions to form aqueous complexes that increase the solubility, mobility, and risk associated with potentially toxic metals such as chromium and arsenic.

Given the complex interaction between solid minerals, inorganics, and environmental factors (such as Eh-pH relations), computer codes are used to assess the solubility and geochemical behavior of inorganic species in ground water. Codes used to evaluate mineral solubility, saturation, and chemical speciation include WATEQ (Truesdell and Jones, 1974), SOLMINEQ88 (Kharaka et al., 1988) and mass transfer codes, such as PHREEQE (Parkhurst et al., 1980), EQ3/EQ6 (Wolery, 1979), and MINTEQA (Felmy et al., 1984), that can also be used to deduce equilibrium chemical reactions. Data requirements for these codes typically include field analysis of ground-water samples for pH, temperature, Eh or dissolved oxygen, and alkalinity, and a complete inorganic chemical analysis for all major and minor ions and all metals and anions under investigation.

Besides conducting thorough chemical analyses for speciation studies, investigations should be conducted to delineate inorganic contaminant plumes and estimate plume migration rates. Mineralogical characterization efforts can be used to identify solid phases (e.g., clay minerals and Fe and Mn oxyhydroxides) that control inorganic contaminant partitioning (EPRI, 1989). Sorption-desorption and other tests can be conducted to assess inorganic contaminant partitioning, solubility, and mobility as a function of pH and other factors, and the potential for aquifer restoration. Additional information relevant to assessing inorganic ground-water contamination is given by EPRI (1989), Domenico and Schwartz (1990), Palmer and Fish (1991), Stumm (1992), Fetter (1993), Runnells (1993), and Allen et al. (1993).

Ground-Water Velocity Variation

Tailing and rebound also result from variable travel times associated with different flowpaths taken by contaminants to extraction wells. Ground water at the edge of a capture zone travels a greater distance under a lower hydraulic gradient than ground water closer to the center of the capture zone. Travel times also vary as a function of initial contaminant distribution and hydraulic conductivity differences. If pumping is stopped, rebound will occur wherever the resulting flowpath modification diminishes contaminant dilution. Permeability and contaminant distributions should be characterized to facilitate analysis of ground-water stagnation and velocity variations that would be induced by alternative pumping schemes.

Matrix Diffusion

As contaminants advance through relatively permeable pathways in heterogeneous media, concentration gradients cause diffusion of contaminant mass into the less permeable media and thereby retard solute velocity relative to ground water (Gillham et al., 1984). During a P&T operation, dissolved contaminant concentrations in the relatively permeable zones may be quickly

reduced by advective flushing relative to the less permeable zones. This causes a reversal in the initial concentration gradient and the slow diffusion of contaminants from the low to high permeability media. This slow process can cause long-term tailing and rebound after the termination of pumping.

Matrix diffusion may dictate the time necessary for complete remediation, particularly in heterogeneous and fractured media where transport via preferential pathways results in large concentration gradients (Grisak and Pickens, 1980; McKay et al., 1993; and Parker et al., 1994). For example, consider a sand aquifer with clay lenses that was contaminated for a long time before commencing P&T operation. Advective transport induced by pumping may quickly reduce contaminant concentrations in the sand. Concentrations in the clay lenses, however, will decrease slowly as contaminants slowly diffuse from the clay to the sand. The areal extent of the clay is such that an approximation of one-dimensional diffusion out of each lens can be used to estimate the time needed to reduce contaminant concentrations in the clay. If (C_0) is a uniform initial contaminant concentration in a clay lens of thickness m , and that P&T maintains a very low concentration in the sand, then the time required for diffusion to reduce the average relative contaminant concentration (C/C_0) in a clay lens can be estimated by (Carslaw and Jaeger, 1959, p. 97):

$$\frac{C}{C_0} = \frac{8 C_0}{\pi^2} \sum_{n=0}^{\infty} \frac{1}{(2n + 1)^2} \exp\left(-\frac{D^0}{\alpha R m^2} (2n + 1)^2 \pi^2 t\right) \tag{A-4}$$

where R is the retardation factor, α is tortuosity (typically = 1.6 to 1.3 in granular media; Bear, 1972), D^0 is the free water diffusion coefficient, and t is time. Considering typical free water diffusion coefficients for organic contaminants (1×10^{-5} to 1×10^{-6} cm²/sec), changes in C/C_0 in clay lenses of different thickness are shown as a function of time in Figure A-3, and indicate that matrix diffusion can greatly increase aquifer clean-up time.

The potential for matrix diffusion to cause tailing and rebound can be assessed based on (1) knowledge of the contaminant concentration history in the subsurface, (2) site stratigraphy, (3) chemical analyses conducted on vertical core samples taken from low-permeability matrix material, (4) diffusion modeling, and (5) review of P&T monitoring data. Estimates of water diffusion coefficients for various contaminants and media are available in the literature (Parker et al., 1994) or can be, but rarely are, measured in a laboratory (Myrand et al., 1992).

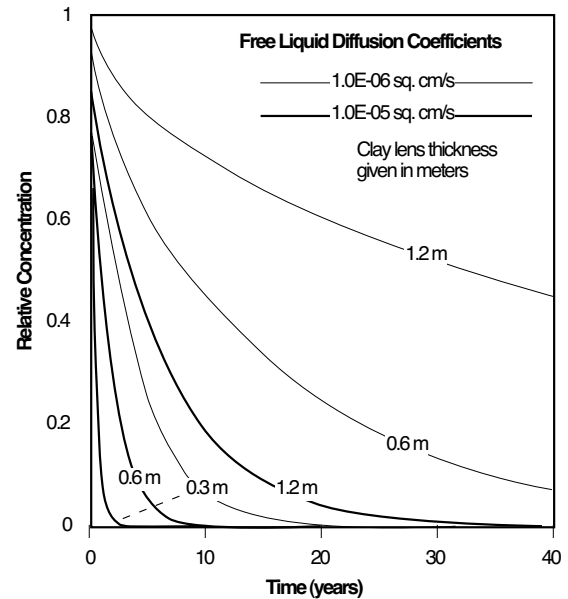

Figure A-3. Changes in average relative contaminant concentration in clay lenses of specified thickness due to diffusion to adjacent clean zones during P&T (based on typical diffusion coefficient and tortuosity values).

Appendix B

Selected Ground-Water Treatment Technologies Available as Package Plants

(modified from U.S. EPA, 1994a; Boulding, 1995)

<i>Method</i>	<i>Process Description</i>	<i>Package Plant Components and Sizes</i> <small>(Dimensions are for overall plant envelope)</small>	<i>Advantages and Limitations</i>
<p><u>Air Stripping</u> Widely used to remove volatile contaminants from ground water.</p>	<p>Volatile contaminants are transferred from water to gas phase by passing air or steam through water in a tall packed tower, shallow tray tower, or stripping lagoons. The air stream containing volatile contaminants may require treatment (e.g., with vapor-phase carbon). Stripping with steam may be cost-effective for water containing a mix of relatively nonvolatile and volatile compounds, particularly at industrial facilities where steam is readily available.</p>	<p>Package plants include tall packed tower or compact low profile diffuser tray units, feed pump, air blower, and effluent pump. Flow meters for influent and air flow are required. An influent throttle valve and blower damper are required to adjust the air/water ratio. Acid or chlorine is used to wash the tower packing (e.g., of Fe precipitates). Heights are for packed tower units.</p> <p style="margin-left: 40px;">1-10 gpm — 4'x4'x20' — 2 HP 10-50 gpm — 6'x8'x25' — 5 HP 50-100 gpm — 7'x10'x30' — 8 HP 100-400 gpm— 8'x12'x40' —20 HP</p>	<p>Effective for VOCs. Equipment is relatively simple. Startup and shutdown can be accomplished quickly. Modular design is well-suited for contaminant P&T. Package systems widely available.</p> <p>Dissolved Fe and Mn can be precipitated and foul the packed media resulting in headloss and reduced system effectiveness. Pretreatment (oxidation, precipitation, sedimentation) of influent may be required. Biological fouling may also occur (requiring cleaning via chlorination or a biocide). Sensitive to pH, temperature, and flow rate. May be cost-prohibitive at temperatures below freezing (may need to heat). May need GAC polishing of water effluent and treatment of air stream.</p>
<p><u>Granular Activated Carbon (GAC) Adsorption</u> Widely used to remove metals, volatile and semi-volatile organics, pesticides, PCBs, etc. from ground water and leachate.</p>	<p>Aqueous contaminants are sorbed to GAC or synthetic resin packed in vessels in parallel or series. Used sorbent is regenerated or replaced. Extent of adsorption depends on strength of molecular attraction, molecular weight of contaminants, type and characteristics of adsorbent, pH, and surface area.</p>	<p>Package systems include 1 to 3 pressure vessels on a skid, inter-connecting piping, a feed pump, optionally a backwash pump, pressure gauges, differential pressure gauges, influent flow meter, backwash flow meter, and control panel. Spent adsorbers are disconnected and sent to regeneration centers or landfills.</p> <p style="margin-left: 40px;">1-10 gpm - 12'x8'x8' - 2 HP 10-50 gpm - 14'x8'x8' - 7 HP 50-100 gpm - 20'x10'x8' - 10 HP 100-200 gpm - 20'x20'x8' - 20 HP</p>	<p>Effective for low solubility organics. Useful for a wide range of contaminants over a broad concentration range. Not adversely affected by toxics.</p> <p>High O&M costs. Intolerant of suspended solids (will clog). Pretreatment required for oil and grease greater than 10 mg/L. Synthetic resins intolerant of strong oxidizing agents.</p>
<p><u>Chemical Precipitation, Flocculation, Sedimentation</u> Widely used to remove metals from contaminated ground water and landfill leachate.</p>	<p>Metals are precipitated to insoluble metal hydroxides, sulfides, carbonates, or other salts by the addition of a chemical (e.g., to raise pH), oxidation, or change in water temperature. Flocculent aids may be added to hasten sedimentation.</p>	<p>Package plants include a rapid-mix tank, flocculation chamber, and settling tank. Inclined plate gravity separation or circular clarifiers are used for settling. Typical equipment includes a rapid mixer, flocculator and drive, feed pump, sludge pump, acid and caustic soda pumps for pH control, and a polymer pump.</p> <p style="margin-left: 40px;">1-10 gpm - 8'x4'x9' - 3 HP 10-50 gpm - 10'x4'x13' - 5 HP 50-100 gpm - 11'x6'x14' - 7 HP</p>	<p>Useful for many contaminated ground-water streams, particularly as a pretreatment step.</p> <p>Effectiveness limited by presence of complexing agents in water. Precipitate sludge may be a hazardous waste.</p>

Appendix B (continued)

<i>Method</i>	<i>Process Description</i>	<i>Package Plant Components and Sizes</i> <i>(Dimensions are for overall plant envelope)</i>	<i>Advantages and Limitations</i>
<u>UV Oxidation</u> Used increasingly to remove organic contaminants from ground water and other wastewaters.	Ultraviolet (UV) oxidation involves adding an oxidant, such as hydrogen peroxide, to contaminated water and then irradiating the solution with UV light. This splits the hydrogen peroxide, producing hydroxyl radicals which react with organic contaminants, causing their breakdown to non-toxic products (e.g., low weight aldehydes, carbon dioxide and water).	An oxidant (hydrogen peroxide) is injected upstream of the reactor vessel and mixed with the contaminated water in line. The fluid then flows sequentially through 1 or more reactors containing UV lamps where treatment occurs. 1x10 kW - 2'x6'x6' 1x30 kW - 4'x4'x8' 4x30 kW - 12'x5'x8'	UV oxidation can treat a broad range of soluble organics and is particularly effective for destroying chloroalkanes such as TCE and vinyl chloride and aromatic compounds such as benzene and toluene. Pretreatment may be needed to remove suspended solids, NAPL, and iron concentrations > 100 mg/L. Treatability studies needed.
<u>Filtration</u> Widely used to remove fine suspended solids from ground water and landfill leachate.	A fixed or moving bed of media traps and removes suspended solids from water passing through the media. Monomedium filters usually contain sand, while multimedia filters include granular anthracite over sand possibly over very fine garnet sand. Filters are used upstream of other treatment processes.	Package filters consist of one or more pressure vessels on a skid. A feed pump, backwash pump, piping, and valves complete the system. 1-10 gpm - 10'x4'x8' - 2 HP 10-50 gpm - 14'x6'x8' - 3 HP 50-100 gpm - 18'x8'x8' - 5 HP 100-250 gpm - 24'x10'x8' - 15 HP	Reliable and effective means of removing low levels of solids. Equipment is readily available and easy to operate and control. Filters clog if suspended solids concentration is high. Backwash water requires further treatment.
<u>Ion Exchange</u> Widely used to remove metal cations, TDS, and anions (e.g., nitrate, sulfate, chromate) from drinking water and for various other applications.	Ion exchange is an adsorption process that uses a resin media to remove dissolved ion contaminants (by exchanging sorption sites held by harmless ions). Cation resins adsorb metals while anion resins adsorb such contaminants as nitrate and sulfate. Systems consist of pressure vessels containing beds of resin pellets and strainers to retain the pellets. The resin bed is regenerated by flushing with acid and/or caustic soda.	Package plants include resin-filled pressure vessels, regeneration chemical tanks, and waste brine storage tanks. Acid and caustic soda solution pumps are provided to regenerate the resin. Resins can be selected that are ion-specific. 1-10 gpm - 8'x3'x6' - 3 HP 10-50 gpm - 14'x5'x8' - 10 HP 50-100 gpm - 17'x6'x10' - 12 HP	Removes a broad range of ionic species. Units are compact and not energy intensive. Must monitor effluent for contaminant breakthrough. High concentrations of Fe and Mn, hardness cations (Ca and Mg), suspended solids, and certain organics will foul ion exchangers. These constituents are often present at much higher concentration than the targeted contaminants. One option is to use ion-specific resins to remove heavy metals in the presence of Ca and Mg.
<u>Reverse Osmosis (RO)</u> Widely used for removing dissolved solids from drinking water and other applications.	RO is a separation process that uses selective semipermeable membranes to remove dissolved solids from water. A high-pressure pump forces the water through a membrane, overcoming the natural osmotic pressure, to divide the water into a dilute (treated) stream and a concentrated (residual brine) stream.	RO package plants include cartridge prefilters, a high-pressure feed pump, RO modules, pressure vessels, and a backpressure valve. 1-10 gpm - 8'x3'x6' - 13 HP 10-50 gpm - 12'x6'x6' - 35 HP 50-100 gpm - 14'x12'x8' - 85 HP	Can reduce both inorganic and organic dissolved solids. Some brine must flow out of the RO module to remove concentrated contaminants. This rejected flow may be 10% to 50% of the feed flow. Units are subject to chemical attack, fouling, and plugging. Pretreatment needs (e.g., to remove Fe, Ca, Mg) may be great.

Appendix B (continued)

Method	Process Description	Package Plant Components and Sizes <i>(Dimensions are for overall plant envelope)</i>	Advantages and Limitations
<p><u>Fluidized Bed Biological Reactor (FBR)</u> Widely used to remove soluble organics (e.g., BTEX, aromatics, halogenated aliphatics, etc.) from ground water, but not landfill leachate.</p>	<p>An aerobic FBR is a fixed-film biological treatment technology using microbes grown on GAC or sand media. Dedicated pumps provide desired fluidization and control the reactor internal flux. Influent enters the reactor bottom. The media bed expands as the biofilm grows thicker and reduces the media density. An internal growth control system intercepts the rising bed at a desired height, removes most biomass from the media, and returns the media to the reactor. Aerobic GAC FBR integrates biological removal with GAC sorption.</p>	<p>Package plants include an enclosed vertical cylindrical vessel, influent pump, air compressor or blower, air diffuser, effluent recycle pump, and media/biomass separation tank. 1-10 gpm - 12'x7'x15' - 7 HP 10-50 gpm - 18'x10'x15' - 10 HP 50-100 gpm - 18'x12'x15' - 12 HP 100-400 gpm - 18'x16'x15' - 40 HP</p>	<p>Expected to have a high process and mechanical reliability. Single or dual reactor design provides on-line flexibility. GAC FBR provides stable performance under fluctuating loading conditions. NAPL may pass through or cover the biofilm surface. Iron levels > 20 mg/L may require pretreatment to avoid plugging. Ca and Mg may cause scaling problems. Not designed for removing suspended solids. GAC FBR is not efficient for low-yield, nonbio-degradable organics because it is often operated as a high loading system with a short retention time.</p>
<p><u>Activated Sludge System</u> Widely used to remove biodegradable organic contaminants and inorganic nutrients (e.g., N and P) from landfill leachate, but not from ground water.</p>	<p>This is a suspended-growth, biological treatment system that uses aerobic microbes to biodegrade organic contaminants. Influent is pumped into an aeration tank, mixed with bacteria, and kept in suspension. In the presence of oxygen, nutrients, organic compounds, and acclimated biomass, organic contaminants are biodegraded. After a treatment period, the fluid and biomass are passed to a settling tank, where cells are separated from treated water. A portion of the settled cells are recycled to the next treatment batch and the remaining sludge is disposed.</p>	<p>Package plants include cylindrical or rectangular aeration tanks and clarifiers, positive displacement blower, air diffusers, sludge recycle pump, sludge waste pump, chemical feed pumps, and control panel. 1-10 gpm - 23'x12'x12' - 5 HP 10-50 gpm - 45'x24'x12' - 15 HP 50-100 gpm - 45'x50'x12' - 25 HP 100-200 gpm - 45'x100'x12' - 47 HP</p>	<p>Effective and reliable if there are no shock loads. Technology is highly developed. Can tolerate higher organic loads than most biological treatment processes. High degree of flexibility. High capital costs. Generates sludge that may be high in metals and refractory organics. Sensitive to high concentrations of heavy metals or toxic organics. Fairly energy intensive. Has difficulty with low concentrations of contaminants, relatively long time needed for organism acclimation. Long detention times for some complex contaminant degradation.</p>
<p><u>Sequencing Batch Reactor (SBR)</u> Widely used to remove biodegradable organics and inorganic nutrients from LF leachate, but not from ground water.</p>	<p>The SBR is a periodically operated, suspended growth, activated sludge process. It is different from the continuous activated sludge process in that the treatment steps are carried out in a single reactor tank in sequential steps.</p>	<p>Package plants include 1 or 2 rectangular or cylindrical SBR tanks, blowers, air diffusers, influent pumps, waste sludge pump, effluent pump, and chemical pumps. A floating decanter removes clear water from the reactor water at the end of the treatment cycle. 1-10 gpm - 20'x10'x12' - 7 HP 10-50 gpm - 30'x15'x14' - 40 HP 50-100 gpm - 40'x20'x14' - 80 HP</p>	<p>See above. By using a single tank, SBR saves land requirements and provides flexibility in changeable time and mode of aeration in each stage.</p>