

**National Conference on  
Urban Storm Water:  
Enhancing Programs  
at the Local Level**

Proceedings  
Chicago, IL  
February 17-20, 2003

Technology Transfer and Support Division  
National Risk Management Research Laboratory  
Office of Research and Development  
U. S. Environmental Protection Agency  
Cincinnati, Ohio 45268



## **NOTICE**

Mention of trade names or commercial products does not constitute endorsement or recommendation for use.

## FOREWORD

The U.S. Environmental Protection Agency is charged by Congress with protecting the Nation's land, air, and water resources. Under a mandate of national environmental laws, the Agency strives to formulate and implement actions leading to a compatible balance between human activities and the ability of natural systems to support and nurture life. To meet this mandate, EPA's research program is providing data and technical support for solving environmental problems today and building a science knowledge base necessary to manage our ecological resources wisely, understand how pollutants affect our health, and prevent or reduce risks in the future.

The National Risk Management Research Laboratory is the Agency's center for investigation of technological and management approaches for reducing risks from threats to human health and the environment. The focus of the Laboratory's research program is on methods for the prevention and control of pollution to air, land, water, and subsurface resources; protection of water quality in public water systems, remediation of contaminated sites and groundwater; and prevention and control of indoor air pollution. The goal of this research is to catalyze development and implementation of innovative, cost-effective environmental technologies; develop scientific and engineering information needed by EPA to support regulatory and policy decisions; and provide technical support and information transfer to ensure effective implementation of environmental regulations and strategies.

This publication has been produced as part of the Laboratory's strategic long-term research plan. It is published and made available by EPA's Office of Research and Development to assist the user community and to link researchers with their clients.

Hugh McKinnon, Acting Director  
National Risk Management Research  
Laboratory

## TABLE OF CONTENTS

Source Area and Regional Storm Water Treatment Practices: Options for Achieving Phase II Retrofit Requirements in Wisconsin .....	1
Management Strategies for Urban Stream Rehabilitation .....	20
Remediation of Stormwater Residuals Decant with Hydrocotyle Ranunculoides .....	29
Inappropriate Discharge Detection and Elimination: What Phase I Communities are Doing to Address the Problem .....	37
Use of the Clean Water State Revolving Fund for Municipal Storm Water Management Programs .....	51
Planning and Assessment of Best Management Practices in the Rouge River Watershed .....	59
The Maryland Stormwater Management Program: A New Approach to Stormwater Design .....	76
Enhancing Storm Water Infiltration to Reduce Water Temperature Downstream .....	85
Local Solutions to Minimizing the Impact of Land Use Change .....	98
Thornton Transitional Reservoir Storm Water Management .....	106
Developing Split-Flow <sup>tm</sup> Stormwater Systems .....	114
Reforest the Bluegrass: Empowerment of the Citizen Watershed Manager .....	123
Storm Water Phase I MS4 Permitting: Writing More Effective, Measurable Permits .....	134
Conservation Design Tools for Stormwater Management .....	142
Using Technical Data and Marketing Research to Change Behavior .....	147
Evaluating Innovative Stormwater Treatment Technologies Under the Environmental Technology Verification (ETV) Program .....	156
Using an Indicators Database to Measure Stormwater Program Effectiveness in Hampton Roads .....	167
Using Incentives and Other Actions to Reduce Watershed Impacts from Existing Development .....	181

## TABLE OF CONTENTS (continued)

Lessons Learned from In-Field Evaluations of Phase I Municipal Storm Water Programs .....	191
EcoRoofs (Greenroofs) - A More Sustainable Infrastructure .....	198
Storm Water Management in the City of Chicago .....	215
Regional Facility vs. On-Site Development Regulations: Increasing Flexibility and Effectiveness in Development Regulation Implementation .....	221
A Regional Approach to Phase II Permitting Encourages Cooperation and Reduces Cost .....	236
Fish Community Response in a Rapidly Suburbanizing Landscape .....	253
Elements of Successful Stormwater Outreach and Education .....	263
A Conservation Plan for Three Watersheds within the Milwaukee Metropolitan Sewerage District (MMSD) .....	272
Critical Components for Successful Planning, Design, Construction and Maintenance of Stormwater Best Management Practices .....	291
Evaluation of NPDES Phase I Municipal Stormwater Monitoring Data .....	306
Funding Phase II Storm Water Programs .....	328
Protecting Water Resources with Higher Density Developments .....	340
Predicting the Impact of Urban Development on Stream Temperature Using a Thermal Urban Runoff Model (TURM) .....	369
Rain Barrels--Truth or Consequences .....	390
The Stranger Amongst Us: Urban Runoff, The Forgotten Local Water Resource .....	395
A Process for Determining Appropriate Impact Indicators for Watershed Projects .....	409
Dual Function Growth Medium and Structural Soil for Use as Porous Pavement .....	416
The Wash Project--Thinking Outside the Culvert .....	427

## TABLE OF CONTENTS (continued)

Necessity and Opportunity: Urban Stormwater Management in Rockville, Maryland .....	440
Re-Inventing Urban Hydrology in British Columbia: Runoff Volume Management for Watershed Protection .....	453
Development of the San Diego Creek Natural Treatment System .....	470
"Sherlocks of Stormwater" Effective Investigation Techniques for Illicit Connection and Discharge Detection .....	489
Low Impact Development Strategies for Rural Communities .....	497
An Assessment and Proposed Classification of Current Construction and Post Construction Structural Best Management Practices (BMPs) .....	502
Overcoming Challenges in Establishing a Regional Public Education and Outreach Partnership .....	518
The WaterShed Partners: An Education Collaboration that Works .....	526
Educating the Las Vegas Community about Storm Water Pollution .....	537
Illicit and Industrial Storm Water Controls: A Municipal Perspective .....	546
A Reassessment of the Expanded EPA/ASCE National BMP Database .....	555
<b>Posters</b>	
EPA's Management Measures Guidance to Control Nonpoint Source Pollution from Urban Areas: It's Time to Develop and Implement Your Storm Water Management Program....Are You Ready? .....	574
Evaluating Innovative Stormwater Treatment Technologies Under the Environmental Technology Verification (ETV) Program .....	580
Managing Storm Water in Wisconsin: A Local Partnership Protects the Kinnickinnic River .....	582
Duluth Streams: Community Partnership for Understanding Urban Stormwater and Water Quality Issues at the Head of the Great Lakes .....	600
Maximum Utility for Minimum Cost: Simple Structural Methods for Stormwater Quality Improvement .....	601

## ABSTRACT

A wide array of effective storm water management and resource protection tools have been developed for urban environments, but their implementation continues to be hampered by a lack of technology transfer opportunities. At the national conference ***Urban Storm Water: Enhancing Programs at the Local Level***, attendees learned about state-of-the-art technologies and implementation programs that have proven success in local communities.

The timing of this Conference coincided well with the implementation of U.S. EPA's Phase II NPDES Storm Water Program. Participants learned about the most effective tools and technologies for meeting these new NPDES permit requirements. Attendees included staff and engineers representing local municipalities, as well as water resource managers, conservation groups, local officials, researchers, educators, and state agency personnel.

Conference sessions featured progressive scientists and researchers, along with managers of successful projects from across the country. Two concurrent sessions—one focusing on tools and technology, the other focusing on program implementation—allowed participants to tailor the Conference experience to fit their personal educational goals.

This Conference was the fifth in a popular series of water quality specialty conferences sponsored by the U.S. Environmental Protection Agency's Region 5 Water Division office. The Chicago Botanic Garden, which is owned by the Forest Preserve District of Cook County and managed by the Chicago Horticultural Society, was pleased to coordinate the conference. Also co-sponsoring the event were the U.S. Environmental Protection Agency's Office of Wastewater Management and Office of Research and Development, as well as Tetra Tech, Inc. The conference was conducted in cooperation with the Center for Watershed Protection. Approximately 350 attendees participated.

Three pre-conference workshops were held on February 17. ***Smart Watersheds: Building Municipal Programs to Restore Urban Watersheds*** provided practical and useful advice on how to implement "smart" watershed programs, which relate to a group of 17 municipal programs that can be integrated together at the watershed level to improve the quality of runoff and habitat in urban streams. The workshop was led by staff from the Center for Watershed Protection. The second pre-conference workshop, ***Countdown to the Phase II Implementation Deadline: Putting the Final Touches on Your Storm Water Permit***, presented details that Phase II municipal programs and construction site operators need to know in order to complete their programs and storm water permit applications. Instructors for this workshop were staff from

Tetra Tech, Inc. The third pre-conference workshop, ***Certified Professional in Storm Water Quality (CPSWQ) Exam Review Course***, provided participants with an understanding the CPSWQ exam's content and format. Instructors for this workshop were from Certified Professional in Erosion and Sediment Control, Inc.



This Conference Proceedings includes many of the papers presented during the conference, and a copy has been provided to each attendee. All papers included were peer reviewed. Additional copies, in either paper or CD-ROM format, are available free of charge from the U.S. Environmental Protection Agency's National Center for Environmental Publications: telephone 800/490-9198, or visit their Web site at <<http://www.epa.gov/ncepihom/>>.

Robert J. Kirschner  
Conference Coordinator,  
Chicago Botanic Garden

## **ACKNOWLEDGMENTS**

The success of the conference and the preparation of this proceedings are due largely to the efforts of the presenters as well as the following individuals:

### **Conference Planning Committee**

Robert J. Kirschner, Conference Coordinator  
Chicago Botanic Garden, Glencoe, IL

Thomas E. Davenport, Project Officer  
U.S. Environmental Protection Agency - Region 5, Chicago, IL

Scott Minamyer, Proceedings Editor  
U.S. Environmental Protection Agency, Cincinnati, OH

Ted Brown, Center for Watershed Protection, Ellicott City, MD  
James H. Collins, Tetra Tech, Inc., Fairfax, VA  
Alyssa Dodd, Penn State University, University Park, PA  
Rod Frederick, U.S. Environmental Protection Agency, Washington, DC  
Ralph Reznick, Michigan Department of Environmental Quality, Lansing, MI  
Eric W. Strecker, GeoSyntec Consultants, Portland, OR

### **Peer Reviewers**

Diana Allen, National Park Service, St. Louis, MO  
Lisa Austin, GeoSyntec Consultants, Portland, OR  
Brian Bohl, Hamilton Soil and Water Conservation District, Cincinnati, OH  
Paul Braasch, Clermont County Office of Environmental Quality, Cincinnati, OH  
Donald Brown, U.S. Environmental Protection Agency, ORD, Cincinnati, OH  
Ted Brown, Center for Watershed Protection, Ellicott City, MD  
Deb Caraco, Center for Watershed Protection, Ellicott City, MD  
Thomas Davenport, U.S. Environmental Protection Agency, Region 5, Chicago, IL  
Jennifer Deaton, Butler Soil and Water Conservation District, Hamilton, OH  
Nancy Ellwood, Mill Creek Watershed Council, Cincinnati, OH  
Chi-Yuan Fan, U.S. Environmental Protection Agency, ORD, Edison, NJ  
Richard Field, U.S. Environmental Protection Agency, ORD, Edison, NJ  
Rod Frederick, U.S. Environmental Protection Agency, OW, Washington, DC  
Todd Hesse, GeoSyntec Consultants, Portland, OR  
Jim Howell, GeoSyntec Consultants, Portland, OR  
Sarah Lehmann, U.S. Environmental Protection Agency, Region 5, Chicago, IL

Marc Leisenring, GeoSyntec Consultants, Portland, OR  
Peter Manganella, GeoSyntec Consultants, Portland, OR  
Nikki McClain, USDA, NRCS, Muncie, IN  
John McManus, Clermont County Office of Environmental Quality, Cincinnati, OH  
Scott Minamy, U.S. Environmental Protection Agency, ORD, Cincinnati, OH  
Nhien Pham, U.S. Environmental Protection Agency, Region 5, Chicago, IL  
Marsha Rolph, Warren County Soil & Water Conservation District, Lebanon, OH  
Joyce Perdek, U.S. Environmental Protection Agency, ORD, Edison, NJ  
Asim Ray, U.S. Environmental Protection Agency, ORD, Edison, NJ  
Steven Roy, GeoSyntec Consultants, Portland, OR  
Michael Royer, U.S. Environmental Protection Agency, ORD, Edison, NJ  
Marcus Quigley, GeoSyntec Consultants, Portland, OR  
Trent Schade, U.S. Environmental Protection Agency, ORD, Cincinnati, OH  
Tom Schueler, Center for Watershed Protection, Ellicott City, MD  
William Shuster, U.S. Environmental Protection Agency, ORD, Cincinnati, OH  
Eric Strecker, GeoSyntec Consultants, Portland, OR  
Mary Stinson, U.S. Environmental Protection Agency, ORD, Edison, NJ  
Anthony Tafuri, U.S. Environmental Protection Agency, ORD, Edison, NJ  
Paul Thomas, U.S. Environmental Protection Agency, Region 5, Chicago, IL  
Ariamalar Selvakumar, U.S. Environmental Protection Agency, ORD, Edison, NJ  
Peter Swenson, U.S. Environmental Protection Agency, Region 5, Chicago, IL  
Jennifer Zielinski, Center for Watershed Protection, Ellicott City, MD

### **Publishing Support**

Jean Dye and Steve Wilson, U.S. Environmental Protection Agency, ORD, Cincinnati, OH

# Source Area and Regional Storm Water Treatment Practices: Options for Achieving Phase II Retrofit Requirements in Wisconsin

Roger Bannerman, Wisconsin Department of Natural Resources, Madison, WI

Greg Fries, City of Madison, Madison, WI

Contributor: Judy Horwath, U.S. Geological Survey; Middleton, WI

## Abstract

A recently calibrated urban runoff model, the Source Loading and Management Model (SLAMM), is used to compare the cost-effectiveness of using source area and regional stormwater treatment practices. The demonstration is done for the totally urbanized Lake Wingra watershed in Madison, Wisconsin. The goal is to retrofit practices that are able to reduce the annual total suspended solids load by 40%. Model results indicate the parking lots and streets are the most important sources of total suspended solids. Practices evaluated for the parking lots include the Delaware Perimeter Sand Filter, Stormceptor, Multi-Chamber Treatment Tank, bioretention, porous pavement, and infiltration trenches. Individually they reduced the solids load to Lake Wingra by 7 to 19%. High efficiency street sweeping is projected to reduce the annual solids load by 17%.

Nine combinations of the source area practices are able to achieve the 40% reduction goal. For example, a 42% reduction in solids load to Lake Wingra is estimated for the combination of high efficiency street sweeping on all the streets and Delaware Perimeter Sand Filters on all the parking lots. Alternatively, the 40% reduction is achieved by using regional detention ponds with a total of 20 acres of permanent pool area. Many of the combinations of source area practices are more cost-effective than the regional practice. Assuming a lifespan of 20 years the annual cost of the source area practices ranges from about \$573,000 to \$1,504,000, while the range for the detention ponds is \$963,000 to \$1,840,000. The least expensive combination of source area practices would only increase the annual stormwater utility bill for the Madison taxpayers by about \$6, while the most likely detention pond alternative will increase the utility bills by about \$18. Cities should consider retrofitting source area practices as a cost-effective way to meet reduction goals for total suspended solids.

## Introduction

A new rule (NR151) to be administrated by the Wisconsin Department of Natural Resources (Department) contains performance standards to reduce the impacts of stormwater for both developing and established urban areas. Over 200 Wisconsin cities will be affected by the rules, because the performance standards will be in their EPA Phase II permits. Standards for the developing areas address problems of construction erosion, post-development suspended solids loads, and sustaining the natural hydrology of the watersheds. These developing areas standards should reduce the risk of any future degradation to our lakes and streams. The Department also hopes to enhance the quality of our degraded urban lakes and streams by requiring some sediment reduction in established urban areas.

Performance standards for the established areas will require the cities to reduce the annual total suspended solids (TSS) loads by 40%. The standard must be achieved by the year 2013. Since the Phase II permits will be issued in 2003, the cities will have two permit cycles to achieve the standard. Ten years seems like a long time, but the cities will need the time to implement the practices. It might take more than two years just for cities to develop their management strategies

The 40% reduction assumes no stormwater treatment practices (STPs) exist in the established urban areas. A city will receive credit for any existing STPs. Since most cities rely on street sweeping and catch basin cleaning for reducing solids loads in older neighborhoods, they will have to add more practices or completely replace their old ones to achieve the 40%. Older style broom street sweepers and catch basin cleaning is not expected to achieve more than a 20% reduction in annual suspended solids loads.

Cities will have the challenge of both determining the benefits of their existing STPs and deciding what additional practices they will need to achieve the goal. At the same time they need to select STPs that have the lowest possible capital and maintenance cost. To meet the challenge the cities will have to use urban runoff models and the latest information available on the effectiveness and cost of STPs.

Our purpose is to demonstrate the types and cost of STPs that will achieve the 40% reduction in the Lake Wingra watershed, which is an established urban area in Madison, Wisconsin. Of special interest to us is to compare the benefits of using source area STPs, such as street sweeping and filtration devices, with regional practices, such as detention ponds. An urban runoff model called Source Loading and Management Model (SLAMM) is used along with literature values for practice effectiveness and cost.

## **A Description of the Lake Wingra Watershed**

A lot of the information needed to complete a stormwater plan is already available for the Lake Wingra watershed. Not only has there been a lot of research completed on the lake itself, but the watershed has also been the object of two planning efforts (Univ. of WI., 1999; Dane County, 1992). Both of the plans identify sedimentation as an important issue for the lake. Both plans say that stormwater is an important source of the suspended solids load to the lake. The priority watershed plan suggests a 30 to 50% reduction in the annual suspended solids load. Neither plan did a comprehensive analysis of the alternative stormwater practices, which means they did not do a detailed comparison of source area and regional practices.

Lake Wingra is a small (325 acres), shallow, highly eutrophic lake, but its location in a highly populated urban area makes it the focus of many recreational activities. Sedimentation problems are bad enough around sewer outfalls to restrict access by boats – even canoes. Heavy weed growth in the lake also reduces the area of the lake used by canoes, sailboats, and sail boarders. Water quality problems contribute to a decline in attendance at the swimming beach, but there is still a lot of use of the beach.

The most recent landuse information is available from the City of Madison. The city has divided the watershed into eight sub-watersheds (Figure 1). Five of the sub-watersheds are highly urbanized, while two of the sub-watersheds (WI-05 and WI-08) are mostly in the University of Wisconsin arboretum. Most of this land is forest and prairie preserve managed by the university. There is almost no new construction in the watershed.

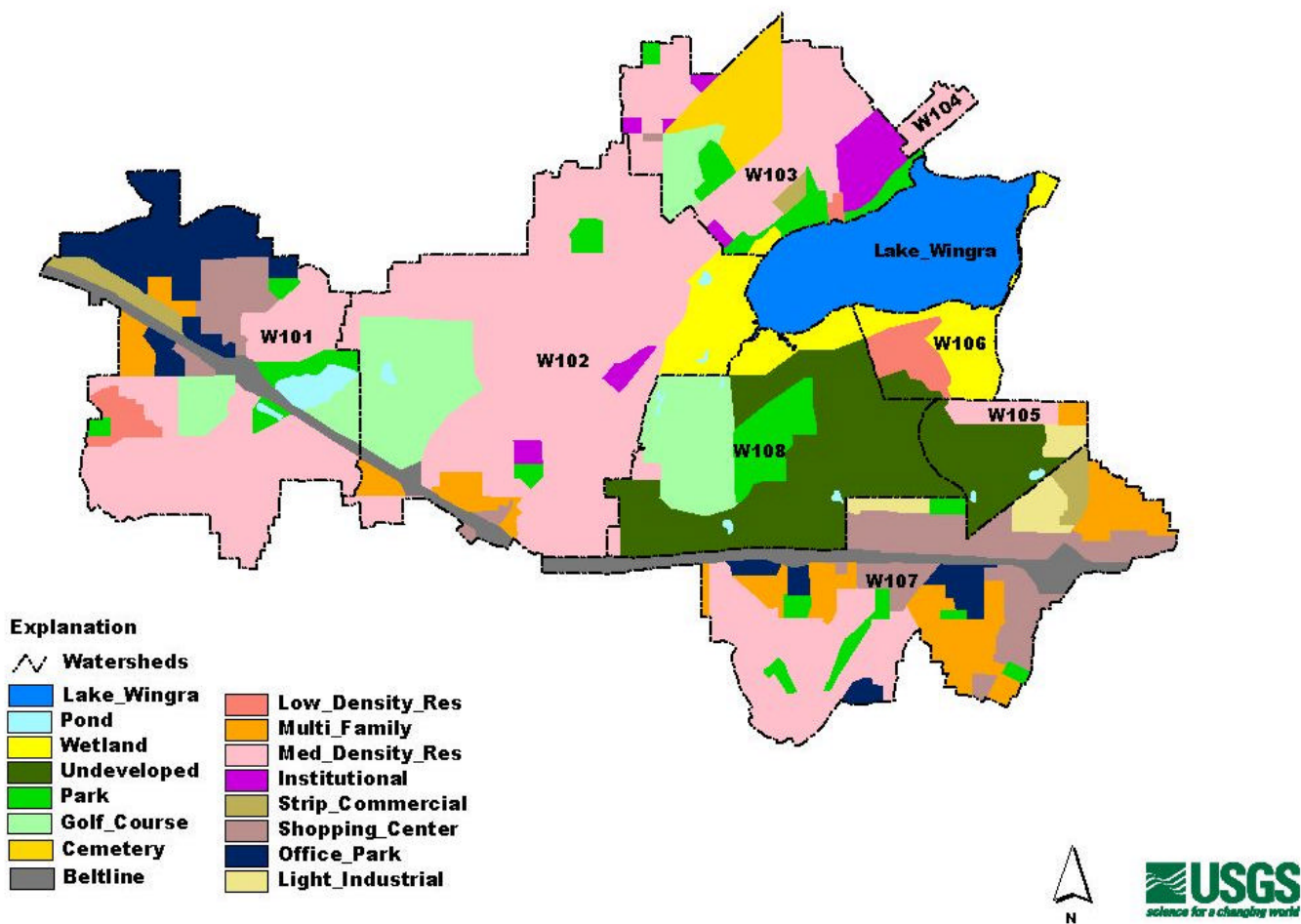
The watershed is about 3947 acres (6.2 square miles) in size (Table 1). This value does not include the area of the lake, the 210 acres of wetlands and 48 acres of ponds in the watershed. Residential is the largest landuse category in the watershed and most of it is medium density residential. Open space is the next largest landuse category at 29%, which includes the University Arboretum, golf courses, city parks, and cemeteries. About 62% of the open space is in the University Arboretum. Together the residential, open space and commercial landuses account for 92% of all the land in the watershed. Most of the commercial landuse is divided equally between shopping centers and office parks. The watershed also includes a freeway, five schools, and some light industrial sites.

**Table 1.** Landuse areas for the eight subwatershed in the Lake Wingra Watershed<sup>1</sup>

Landuse	Acres of landuse by subwatershed <sup>2</sup>								Watershed Total	
	WI-01	WI-02	WI-03	WI-04	WI-05	WI-06	WI-07	WI-08	Ac	%
Residential	418	829	229	31	37	43	371	11	1968	50
Institutional	0	18	63	0	0	0	0	0	81	2
Commercial	256	7	9	0	0	0	256	0	528	13
Industrial	0	0	0	0	14	0	40	0	54	1
Open	88	170	188	0	104	13	41	539	1144	29
Freeway	53	27	0	0	0	0	92	0	172	5
<b>Total</b>	<b>815</b>	<b>1051</b>	<b>489</b>	<b>31</b>	<b>155</b>	<b>56</b>	<b>800</b>	<b>550</b>	<b>3947</b>	<b>100</b>

1. Lake Wingra (325 ac), wetlands (210 ac) and ponds (48) are not included in landuse areas.

2. Most of WI-05 and WI-08 are in the University of Wisconsin Arboretum.



**Figure 1.** Distribution of landuses in the Lake Wingra watershed.

For the purpose of the demonstration, we assumed no pre-existing practices in the Lake Wingra watershed. Consequently, our model runs do not include any pre-existing practices. In fact, the city does street sweeping and there are seven detention ponds in the watershed. Six of the detention ponds are located on

the University Arboretum property. These are seen as small blue dots in Figure 1. The remaining detention pond is on the golf course in WI-01 [Figure 1]. The arboretum built the detention ponds to reduce the erosive effects of the runoff and to protect their wetlands from sedimentation. These practices are helping to reduce the suspended solid load to Lake Wingra. Otherwise much of the runoff from four of the more urbanized sub-watersheds (WI-01, WI-02, WI-05, and WI-07) would flow unchecked down open channels to Lake Wingra.

Also, we do not include sediment loads from bank erosion in our estimate of total sediment loads to Lake Wingra. Severe bank erosion is occurring in several streams tributary to the lake. Bank stabilization projects are necessary to control this source of sediment.

## **Six Steps to Finding the 40% Solution**

Developing a stormwater plan that considers both source area and regional STPs will require more steps than a plan that just considers regional practices. To include the source area practices, more work is needed to identify the sources of the pollutants of concern, more types of STPs need to be evaluated, and more sites in the drainage area must be identified. Although it takes more work to include source area practices, we think a retrofit plan has a better chance of being implemented if it is not limited to regional practices. Source area practices can be incorporated into places that regional practices will simply not fit and they are usually less disruptive to the neighborhood. Previous experience in Wisconsin has demonstrated how unreceptive people can be to being displaced from their parks and homes by regional stormwater treatment practices.

We think the following six steps should be part of any stormwater management plan that includes source area practices. We used these steps to demonstrate the validity of using source area practices in the Lake Wingra watershed. Since we are only trying to demonstrate the relative cost-effectiveness of source area and regional practices, the steps do not include all the activities needed to actually install STPs in the Lake Wingra watershed. For example, a more comprehensive stormwater plan should include collection of site information, such as soil types and location of utilities, sizing of the STPs in each location, and the actual cost of installation at each site.

1. Select and calibrate an urban runoff model.
2. Determine the annual suspended solids loads for each sub-watershed, landuse, and source area in the watershed.
3. Select source area and regional practices to be evaluated for watershed.
4. Determine ability of each practice and combinations of practices to achieve pollutant reduction goal.
5. Identify unit capital and maintenance cost of each practice.
6. Determine cost of each management alternative that achieves pollutant reduction goal.

We think enough information is available now to complete all six steps for any watershed. Cost information about each STP is the hardest to find. Fortunately we could find some conceptual cost data for each practice. Information about the effectiveness of each practice is also very limited (Winer, 2000), but ongoing monitoring efforts, such as the EPA's Environmental Technology Verification effort, should greatly increase our database over the next few years. New monitoring sites are being added to the National Stormwater Best Management Practices (BMP) Database all the time (EPA,1999). We relied on an urban runoff model to help identify the most important sources of the TSS.

We selected the Source Loading and Management Model (SLAMM) to demonstrate the relative benefits of regional and source area practices (Pitt, 2002). We considered other models, such as P8 and SIMTPM, but only SLAMM is designed to easily produce a TSS load for each source area, such as streets and parking lots (Sutherland, 1999 and Walker, 1990). All three models are capable of testing regional practices, but only SLAMM is designed to specifically evaluate the effectiveness of practices on all the source areas.

Source areas are the building blocks for calculating runoff volumes and pollutant loads for the six landuses addressed by SLAMM – residential, commercial, industrial, institutional, open space, and transportation landuses. Examples of the source areas characteristic of each landuse are roofs, parking lots, driveways, sidewalks, streets, small landscaping (lawns), large landscaping, playgrounds, isolated areas, undeveloped areas, and unpaved parking lots. Pollutant loads and runoff volumes calculated for each source area are added together to produce the estimates for each landuse.

Stormwater treatment practices can be applied to each source area, the conveyance system, and/or the end-of-the-pipe. Some of the practices are only applied to source areas, such as street sweeping and porous pavement. Others, such as catch basin cleaning and grass swales, are reserved for the conveyance system. Many of the available practices in SLAMM, such as detention ponds and infiltration devices, are applied to both source area and end-of-the-pipe solutions. A user may select multiple sites and practices or just decide to apply one practice at one location. The model output summarizes the benefits of the practices by source area and landuse.

To make the source area loads as valid as possible, we think it is very important to calibrate SLAMM for all parts of the country. A minimum calibration requires the collection of event related flow and TSS concentration data at the end of a stormsewer pipe. Although most people preparing stormwater plans will not have enough data to calibrate a model, our efforts to calibrate SLAMM should make the model a reasonable choice for preparing stormwater plans in the upper Midwest.

## SLAMM Calibration

To help people prepare stormwater management plans in Wisconsin, we calibrated SLAMM using data collected by the U.S. Geological Survey office in Madison, Wisconsin. Fortunately, they have recently collected source area runoff volumes and TSS concentrations, rain depths for monitored storms, and runoff volumes and TSS concentrations at the stormsewer outfall at six sewersheds in Wisconsin and one in Michigan (Table 2).

**Table 2.** Comparison of measured and predicted TSS loads and runoff volume at eight stormwater study sites.

Site	Landuse Type	TSS		Runoff Volume	
		Number of Events for Calibration	Percent Difference	Number of Storms for Calibration	Percent Difference
Harper <sup>1</sup>	Residential	23	11	55	-27
Monroe <sup>1</sup>	Res/com	32	-52	75	7
Canterbury <sup>1</sup>	Res/com	14	12	55	10
Marquette	Res/com	71	-29	64	19
Superior	Commercial	21	-66	91	-4
West Towne <sup>1</sup>	Commercial	-	N/A	66	31
Syene <sup>1</sup>	Light Industrial	82	19	108	-8
Badger Road <sup>1</sup>	Light Industrial	18	-40	40	-4

1. Sites are near or in Lake Wingra Watershed.



The mostly residential Monroe study site is in the Lake Wingra watershed and four of the study sites are located very near the Wingra watershed (Bannerman and others, 1990 and Waschbusch and others, 1999). These are the Harper, Canterbury, Syene, and Badger Road study sites. The Marquette site is in Michigan (Steur and others, 1997) and the Superior site is northern Wisconsin (Steur and others, 1997). The median number of storms collected for flow is 64, while the median value for the number of water quality storms is 23.

The following is a list of the files we calibrated in SLAMM and the name of the file we use in Wisconsin. These and other files for the model are on the U.S. Geological web page with the URL of <http://wi.water.usgs.gov/slammm/index.html>. Copies of SLAMM are available at WINSLAMM.com.

1. Runoff coefficient: .rsv (WISI01.rsv)
2. Particulate Solids Concentration: psc (WIAVG01)
3. Pollutant Probability Distribution: .ppd (WIGEO01)
4. Particulate Residue Reduction: .ppr (WIPLV01)
5. Street Delivery Parameter: .std (WISTR01)

SLAMM did a good job of matching the total runoff volumes and TSS loads measured at the end of the storm sewer pipe for each study site. The median difference between the predicted and measured runoff volume is 8% and the median difference for the total suspended solids loads is about 29% (Table 2). We are concerned about the differences of around 50% for suspended solids at Monroe, Superior, and Badger Road sites. It appears the model is not accounting for some of the sediment collected by the automatic samplers at these three sites during the largest rainfall events. Over half the difference between the measured and estimated sediment load at the Superior site are caused by the model underestimating the load for the largest rainfall. Estimated sediment loads would be ten percent higher without the effect of the largest rainfall at the Badger Road site. Piles of soil observed at both sites could be the source of sediments the model does not account for during larger events. Estimated and measured runoff volumes are very close for those larger events, so the difference in loads is due to the difference in concentrations.

A 52% difference at Monroe seems to be explained by the unusual amount of deposited sediment observed in the flat part of the storm sewer pipe. Six high intensity storms accounted for most of the error at Monroe Street. The model is not designed to account for the re-suspension of sediment deposited at the bottom of a storm sewer pipe.

## **Sources of Total Suspended Solids in the Lake Wingra Watershed**

After we completed the calibration, we thought SLAMM was ready to help us identify the important sources of TSS in the Wingra watershed. We first ran SLAMM on the eight sub-watersheds with the hope of eliminating some of the sub-watersheds from the rest of the analysis. The city of Madison provided the acres of each landuse in the subwatersheds and the development characteristics we needed for each landuse were obtained from the average development characteristic files on the U.S. Geological Survey web page (<http://wi.water.usgs.gov/slammm/index.html>). Examples of the development characteristics are the acres of each source area, amount of connected imperviousness, and street texture.

We used the average rainfall year file for the Madison area (MSN1981.ran) to run SLAMM for the eight subwatersheds. Four of the sub-watersheds contribute about 92% of the annual suspended solids load for the watershed (Table 3). In an average rainfall year sub-watersheds WI-01, WI-02, WI-03, WI-07 contribute about 457 tons of suspended solids to Lake Wingra. This is about the same as the average load

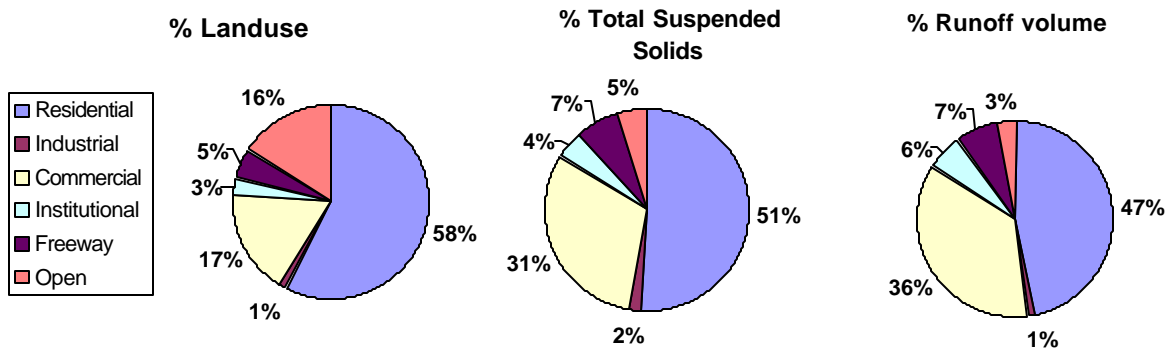
(401 tons) estimated for the watershed when the principle landuse was agricultural (Corsi and others, 1997). It is not a surprise that these four watersheds contribute most of the sediment, since they contain about 95% of all the built-up landuses in the Wingra watershed.

**Table 3.** Annual TSS loads and runoff volume for each subwatershed in the Lake Wingra Watershed

Subwatershed	% of Total Area	TSS (lbs)	TSS, %	Annual runoff volume (ft <sup>3</sup> )	Percent runoff volume
WI-01	21	269,000	27	30,519,000	28
WI-02	27	253,000	26	23,886,000	22
WI-03	12	108,000	11	11,149,000	10
WI-04	1	8,000	1	724,000	1
WI-05	4	19,000	2	2,376,000	2
WI-06	1	8,000	1	663,000	1
WI-07	20	284,000	28	37,314,000	33
WI-08	14	44,000	4	3,114,000	3
Total	100	993,000	100	109,745,000	100

Regional or source area STPs should be implemented in these four critical subwatersheds. If regional STPs were to be installed at the ends of the critical subwatersheds, they would need to have at least a 50% removal efficiency in order to achieve the 40% reduction goal. The output from the model runs used to identify the critical subwatershed can also be summarized to determine landuses with the highest TSS loads. This is the next step in the identification of the most important source areas to control.

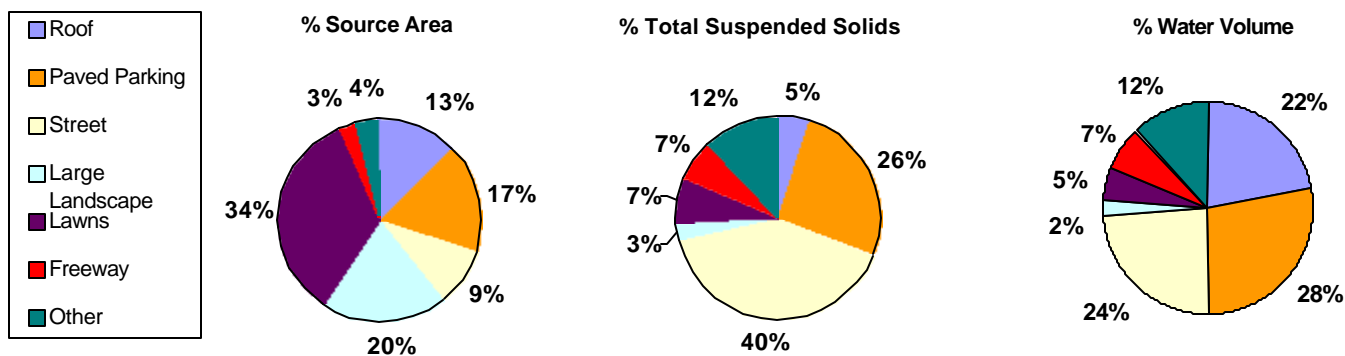
Commercial and residential landuses in the critical subwatersheds contribute about 82% of the annual TSS loads (Figure 2). Residential loads are proportionate to the percent of the area they occupy, while percent of the load contributed by the commercial is almost twice as high as the percent of the area it occupies. This makes the commercial landuse an important target for our management efforts. On the other hand it is less cost effective to treat the open space landuses, since 16% of the area produces only 5% of the load. We did not add industrial landuse to our targeted landuse list, because they represent only 2% of the load. If we assume the institutional and commercial landuses have similar source areas, we can add the 4% TSS load from the institutional landuses to the commercial load for a total of 35%. Source areas within the commercial, institutional, and residential landuses were expected to yield the highest percent of the annual TSS load.



**Figure 2.** Percent area, TSS load, and runoff volume for landuses in four Lake Wingra sub-watersheds.

Parking lots and streets in the four sub-watersheds represent only 26% of the area, but contribute about 66% of the annual suspended solids load (Figure 3). These two source areas are mostly in the commercial, institutional, and residential landuses. Roofs and lawns are a less critical source of suspended solids, because they represent 47% of the area and only produce about 12% of the load. The same is true for large landscaped areas, which includes city parks and golf courses. To be cost-effective our practice selection has to target the streets and parking lots as much as possible.

If we want to evaluate source area STPs that have a removal effectiveness for TSS of less than about 70%, we have to include some of the other source areas in our analysis.



**Figure 3.** Percent area, TSS load, and runoff volume for source areas in four Lake Wingra sub-watersheds.

A 70% control of parking lots and streets would just achieve the 40% (46% control TSS) reduction goal for the Wingra watershed. This is partially because a 100% control of the two source areas results in TSS reduction of 66% for the entire watershed. To give us more choices in our practice selection, we needed to boost the total% of the TSS load we could control. We did this by including other source areas in our analysis, especially freeways, lawns, and roofs.

### **Selection of Stormwater Treatment Practices**

To achieve the goal of the demonstration, it was only necessary to select one regional practice. Several types of source area practices are needed, however, to cover all the types of source areas. Selection of a number of source area practices would allow us to include proprietary and non-proprietary practices with a range of TSS removal values. These could represent a number of treatment processes, such as settling, filtration, and infiltration. Our criteria for selecting regional and source area practices included the availability of good data to verify their effectiveness, some cost information, and hopefully some experience with the practice in Wisconsin.

### ***Regional Practice***

Detention ponds met all our criteria, so they were selected as the regional practice to compare to source area practices. Settling is the main treatment process for the detention ponds. Many studies including one in Wisconsin indicate detention pond can achieve an 80% reduction in annual suspended solids loads (House and others, 1993, Winer, 2000). The regional practice had to have a TSS removal capability of at least 50%

to achieve the 40% reduction goal for the watershed. By using a practice with a TSS removal of 80% the regional practice could be located to serve less the whole drainage area and still achieve the 40% goal (Table 4).

**Table 4.** TSS removal values reported for selected stormwater treatment practices.

Stormwater Treatment Practices	Description of Stormwater Treatment Practices	Abbreviation of Stormwater Treatment Practices	Reported TSS removal, % (1)
Multi Chamber Treatment Tank	Three chambers – grit chamber, settling chamber, and sand/peat filter media chamber with by-pass	MCTT	80
Stormceptor	Vertical single cylindrical chamber using swirl action and settling with built in by-pass	Stormceptor	33
Delaware Perimeter Sand Filter	Underground sand filter using settling chamber followed by sand filter chamber	Delaware Filter	83
High Efficiency Street Sweeping (city street)	Vacuum action pick-up assisted by brooms and/or jets of air	High Sweep	60 <sup>2</sup>
High Efficiency Street Sweeping (freeway)	Vacuum action pick-up assisted by brooms and/or jets of air	High Sweep	45 <sup>3</sup>
Detention Ponds	Holes in the ground with permanent pools designed to settle particles Shallow depressed planted area underlain by a layer of formulated soil (mostly sand) over a layer of gravel. Treatment includes sedimentation, filtration, adsorption, microbial decay, and plant uptake.	Ponds	80
Bioretention		Bioretention	75
Broom Street Sweeper	Broom action pick-up assisted by conveyor belt	Broom Sweep	20 <sup>2</sup>
Porous Pavement	Porous asphalt or interlocking paving blocks providing infiltration	Pavement	95
Infiltration Trench	A lined excavated trench backfilled with gravel. Infiltration followed by filtration in native soils	Trench	NA <sup>4</sup>
Rain Gardens	Shallow depression that's planted with a variety of perennials.	Gardens	75 <sup>5</sup>

1. Percent assumes all devices working at maximum efficiency.
2. Removal efficiency for city streets with sweeping once per week for 30 weeks.
3. Removal efficiency for freeways with sweeping once per week for 30 weeks.
4. TSS removal is probably very high, because reported TP removal is 100%.
5. Assume same as reported bioretention.

Of course, many detention ponds have been installed in Wisconsin. With so many being installed in new development sites, Wisconsin cities have accepted them as a good way to meet their goals for flood control and reduce TSS loads. Very few of them, however, have been retrofitted into existing urban areas. Refitting a detention pond in an existing urban area has the potential to cause a lot of disruption to people living in the neighborhood. In most cases, this alternative will not be politically feasible, except when there is a lot of open land, such as the presence of the arboretum in the Lake Wingra watershed. A stormwater plan prepared for the Lincoln Creek Watershed in the City Milwaukee was promptly rejected

when the groups involved realized the only alternative being offered was to put detention ponds in many of the public parks – 60 ponds altogether.

In estimating costs for ponds, it was assumed that either the land is available and must be purchased at a fair market price or the land is available but the purchase price included the cost of existing buildings (Table 5). Both alternatives assumed a cost for repositioning the existing storm sewer system (Southeastern Regional, 1991). Since the retrofit cost calculations are over ten years old, we applied an annual inflation factor of 3% to building and maintenance of the ponds and we increased the land cost by 10% each year. Retrofit cost of about one to two million dollars for each acre of permanent pool is prohibitive compared to the approximate cost of \$100,000 for each acre pond in a new development.

**Table 5.** Conceptual unit capital and maintenance cost for selected stormwater treatment practices.

Stormwater treatment practice	Unit capital cost, \$	Annual maintenance cost, \$
<b>Source area practices</b>		
MCTT	38,000 / acre of imper. <sup>1</sup>	2,200/practice
Stormceptor	15,000 / acre of imper. <sup>1</sup>	500/practice
Delaware Filter	17,500 / acre of imper. <sup>1</sup>	1,700/practice
Bioretention	20/ft <sup>2</sup> of practice or 44,000/acre of imper. <sup>1</sup>	2/ft
Trench	18/ft <sup>2</sup> of practice or 88/ft of trench	6/ft
Pavement	85,500/acre of practice	290/ac of practice
Broom Sweep	39/curb mile	Included in capital
High Sweep	41/curb mile	Included in capital
Gardens	6/ft <sup>2</sup> of practice	0
<b>Regional Practices</b>		
Ponds (with no land cost)	383,000/acre of pond	3,500/acre of pond
Ponds (with land cost)	980,000/acre of pond	3,500/acre of pond
Ponds (with land cost & buildings)	1,935,000/acre of pond	3,500/acre of pond

1. Imper. = connected imperviousness.

### ***Source Area Practices***

Nine source area practices were selected that best met our criteria (Table 4). The TSS reduction capabilities of the practices have been verified by at least one monitoring study (Winer, 2000, Shoemaker and others, 2000; Bell and others, undated; Young, 1996; National Stormwater, 1999). The TSS removal values include the losses of pollutant load if the practice has a bypass mechanism. Although most of the practices do not have many test results, the available results indicate most of the practices can achieve a high level of suspended solids reduction. All the proprietary and nonproprietary practices that are available should have an efficiency that falls somewhere in the range of efficiencies we used in the demonstration.

The Stormceptor<sup>TM</sup> represents many of source area practices with a moderate level of suspended solids reduction, while the multi-chamber treatment tank (MCTT) represents the practices with a high level of suspended solids reduction. Test results indicate the Stormceptor<sup>TM</sup> should reduce the annual suspended solids load by about 30% (Waschbusch, 1999). Many single chamber practices relying on settling will

probably achieve similar levels of reduction. Many multi-chamber practices that include filtration have a better chance of achieving the 80% reduction in annual suspended solids loads observed for the MCTT (Corsi and others, 1999). Eighty percent is probably near the maximum annual load reduction we can expect for a source area treatment practice, because the practices that have 98% removal efficiencies, such as the MCTT, usually bypass some of the higher flows. It is assumed most devices are designed to bypass some flows for rainfalls greater than about 1.25 inches in 24 hours.

Reported TSS reduction for the old style broom street sweeper is low at 20% (Bannerman, 1983, Sutherland, 1999). Street sweeping has the potential to be a very effective practice, because the source areas that can be swept (parking lots and streets) are the most important sources of TSS. Changes to sweeping schedules and types of machines would be much less disruptive to the public than any other source area practice. New types of street sweepers appear to be more effective (Sutherland, 1999). High efficiency street sweepers should be able to reduce TSS loads from residential streets by at least 60%. These numbers are based on estimates from a calibrated version of the SIMTPM model. The same type of high efficiency street sweepers should be able to reduce the TSS loads from freeways by about 45% (Martinelli, 2002).

The selected source area practices cover a range of treatment processes. Bioretention, MCTT, infiltration trenches (trench), rain gardens (gardens), and the Delaware perimeter sand filter (Delaware filter) all use settling and filtration to remove solids from stormwater. Infiltration also lowers loads by reducing runoff volumes. Infiltration is a key element of trenches, bioretention, gardens, and porous pavement (pavement).

We have experience in Wisconsin with all of the selected source area practices except for bioretention and Delaware sand filters. Personnel communications with cities supporting the source area practices indicate they are mostly happy with their performance. Public works people in Osceola, Wisconsin are telling us they are happy with the performance of their high efficiency street sweeper. Two MCTTs installed in different cities seem to be performing well. We are not aware of any complaints about the several Stormceptors that are installed around Wisconsin. Most of the porous pavement installations seem to be in the form of paver blocks. Some people have observed failures of infiltration trenches. These failures appear to have been caused by clogging during the construction process. Homeowners have reported they are very satisfied with the operation of their rain gardens.

At best, the available cost information can only be used for conceptual purposes (Shoemaker, 2000; Southeastern Regional, 1991) (Table 5). Obviously, the cost will vary with each site depending on factors such as obstacles to installing the practice, cost of the land, and how difficult it is to connect the practice to existing conveyance systems. Existing utilities have already increased the cost of some of our retrofit efforts in Milwaukee. A need to support truck traffic and the presence of underground pipes increased the cost of installing a MCTT in a city maintenance facility. The cost of connecting the existing plumbing to the practices was the major part of the construction cost of installing two source area controls at a freeway site. Conceptual is good enough, though, for a demonstration.

Unit capital and maintenance cost calculation varies from practice to practice (Table 5). Some of the literature provides the cost in terms of the amount of drainage area to the practice, while other cost are determined from the size of the practice. When more than one cost value was available we always selected the higher value. For older cost values we assumed an inflation of 3% each year. Some of the practices share similar costs. For example, the MCTT and bioretention cost about \$40,000 for each acre of imperviousness in the drainage area. Surprisingly, the Delaware filter achieves about the same solids

reduction as the MCTT and bioretention, but only costs about \$17,500 for each acre of imperviousness. This is one reason we included the Delaware filter in our demonstration.

## Location and Sizing of the Practices

Before we could use SLAMM to determine the benefits of installing each type of source area STP, we had to match each practice to the appropriate source area(s). Street sweeping is an obvious match for streets in the three landuses contributing the largest amount of TSS (Table 6). All of the source area practices except street sweeping and rain gardens are applied to parking lots in the commercial and institutional areas. Practices like the MCTT and bioretention are recommended for relatively small drainage areas such as a parking lot. Not enough information is available about treatment levels and cost to include street sweeping

**Table 6.** Sizing information for selected stormwater treatment practices.

Stormwater Treatment Practice	Source area treated	Dimensions each site (ft)	Total area of practice or area of connected impervious draining to practice (ac)	Estimated number of treatment sites
<b>Residential</b>				
Rain Gardens	Lawn & roof	10 x 17 x 0.33	47.6	12,200
Bioretention	All	15 x 30 x 4	27.5	2,666
MCTT	All	1 site/2 ac. of imper.	563 <sup>1</sup>	281
Stormceptor	All	1 site/2 ac. of imper	563 <sup>1</sup>	281
Delaware Filter	Driveway	1 site/driveway	92 <sup>1</sup>	6,100
Broom Sweep	Streets	1/week for 30 weeks	-	4110 <sup>2</sup>
High Sweep	Streets	1/week for 30 weeks	-	4110 <sup>2</sup>
<b>Commercial/Institutional</b>				
Infiltration Trench	Parking lots	5 x 200 x 4	6.2	270
Infiltration Trench	Roofs	5 x 200 x 4	2.2	96
Bioretention	Parking lots	15 x 30 x 4	15.6	1,500
Porous Pavement	Parking lots	-	306	20
MCTT	Parking lot	1 site/ 2 ac imper.	310 <sup>1</sup>	155
Stormceptor	Parking lot	1site/2 ac imper.	310 <sup>1</sup>	155
Delaware Filter	Parking lot	-	310 <sup>1</sup>	55
MCTT	All	1 site /2ac imper.	530 <sup>1</sup>	265
Stormceptor	All	1 site / 2 ac imper.	530 <sup>1</sup>	265
High sweep	Streets	1/week for 30 weeks	-	990 <sup>2</sup>
Broom Sweep	Streets	1/week for 30 weeks	-	990 <sup>2</sup>
<b>Freeway</b>				
Infiltration Trench	All	5 x 200 x 4	1.74	75
MCTT	All	1 site / 2ac. imper.	91	45
Stormceptor	All	1 site / 2 ac. imper.	91	45
High sweep	Freeway	1/week for 30 weeks	-	141 <sup>2</sup>
<b>Regional</b>				
Ponds	All	8.5 ac.	34	4

1. Acres of connected imperviousness.
2. Total curb miles each year.

as a parking lot practice. Together lawns and roofs produce enough of the TSS load (12%) to include them in the analysis of source practices. Residential lawns and roofs are treated with rain gardens and commercial roofs are treated with infiltration trenches.

To understand the maximum possible benefit of using an STP in the three landuses, some of the source area practices are applied to all the source areas in each landuse. By installing MCTTs, Stormceptors, and bioretention systems near or under the streets they should be in a position to treat the runoff coming from all the source areas. It is assumed that some of the water is bypassed for these source area practices. For example, we assumed 2,666 bioretention systems or 27.5 acres of treatment surface area is required to treat all the source areas in residential landuses (Table 6). Each bioretention site would cover a surface area of at least 15 feet wide and 40 feet long and the practice would be installed next to the street in the right of way. It is assumed the people living on the street are responsible for the maintenance of the bioretention plants.

In most cases it seems impractical to assume enough source area practices would be installed in a subwatershed to act as a regional practice. But some examples already exist in this country where cities have installed source area practices in the public right-of-way to control the amount and quality of runoff from all the source areas. Rain gardens are already being installed along residential streets in the Maplewood, Minnesota (Cavett, 2002). They are also being installed as part of street drainage system during street reconstruction projects. Bioretention swales have been installed along a street in Seattle, Washington (<http://www.ci.seattle.wa.us/util/urban creeks/SEAstreets/history.htm>) to treat the runoff from the two year return interval storm. They project that the addition of bioretention swales will not significantly increase the cost of street reconstruction projects.

For the regional practice we assumed that there is one detention pond for each of the four subwatersheds. Since this is a demonstration effort, it is not necessary to match the number of ponds to the number of available sites. It is very likely the total number of ponds would exceed four, if a number of ponds is needed in each subwatershed to overcome the constraints of each site.

Among the selected practices, SLAMM is able to predict the TSS reduction of street sweeping, porous pavement, rain gardens, bioretention systems, infiltration trenches, and detention ponds. Iterations of the model are used to determine the optimum size of rain gardens, porous pavement, bioretention systems and infiltration trenches (Table 6). Reported TSS removal values for the other practices are inserted directly into the model. The model accepts the reported values in the “other” option for source areas, the conveyance system, and the outfall controls.

## **Total Suspended Solids Reductions Estimated for Individual Practices**

Evaluation of the individual source area practices produced only two examples of a practice achieving about a 40% reduction in annual TSS loads to Lake Wingra (Table 7). Bioretention systems and MCTTs located to control all the residential source areas are those two practices. They worked because the residential landuse represents about 50% of the TSS load to Lake Wingra and they have a TSS removal capability of 80%. The other applications of the source area practices are usually treating landuses or source areas that start with less than 40% of the annual TSS load. One exception is streets with 40% of the annual TSS load, but a practice applied to streets would need almost a 100% removal of TSS to achieve the goal. Source area practices will have to be combined to offer more ways for source area practices to achieve a 40% reduction.



Since the ponds are designed to achieve an 80% reduction it is not surprising that the regional practice achieved the TSS reduction goal (Table 7).

**Table 7.** Reduction in annual TSS loads to Lake Wingra for stormwater treatment practices applied to four subwatersheds

Practice	Source area treated	Annual TSS reduction, % <sup>1</sup>
<u>Residential</u>		
Broom Sweep	Streets	4
Delaware Filter	Driveways	7
Gardens	Lawn & roof	9
Stormceptor	All	16
High Sweep	Streets	17
MCTT	All	38
Bioretention	All	41
<u>Commercial/Institutional</u>		
Broom Sweep	Streets	1
Trench	Roofs	2
High Sweep	Streets	5
Stormceptor	Parking lot	7
Stormceptor	All	11
Trench	Parking lot	12
Bioretention	Parking lot	13
MCTT	Parking lot	17
Delaware Filter	Parking lot	19
Pavement	Parking lot	19
MCTT	All	27
<u>Freeways</u>		
Stormceptor	All	1
High Sweep	Freeway	4
MCTT	All	5
Trench	All	6
<u>Regional</u>		
Ponds (with land cost)	All	74

1. Percent of load for all eight subwatersheds, i.e. entire load to Lake Wingra.

Their actual reduction is 74% because we divided the total suspended solids load reductions by the solids loads for the entire watershed, not just the four sub-watersheds where they were applied. Detention ponds could, therefore, be located to serve less of each subwatershed and still meet the TSS reduction goal for the entire watershed.

### Cost Comparisons Between Source Area and Regional Practices

To make a valid comparison between source area practices and regional practices it was important to select configurations of the practices that achieved about a 40% reduction in annual TSS loads. From the analysis of the individual source area practices we discovered it is necessary to try combinations of them to have

more than a couple of alternatives that achieve the 40%. These alternatives could also be more reasonable than applying a source area practice to all the source areas in a landuse, which is needed to achieve a 40% reduction with the MCTT and bioretention. Since detention ponds were determined to achieve a 74% in annual TSS loads to Lake Wingra, it is possible to achieve the 40% reduction by assuming less of each subwatershed drains to each pond. This not only has the effect of reducing the TSS removal by the ponds, but also reduces their costs.

### ***Combinations of Source Area Practices Determined to Achieve 40% Reduction***

To evaluate the benefits of combining the source area practices, the practices were arranged into about 80 combinations. One important consideration is to avoid redundant practices, such as using street sweeping and the MCTT under the street in the same area. After eliminating all the combinations that were lower than 40% or higher than a 45% reduction, we were left with a set of about 15 combinations. We dropped about six more combinations for different reasons. For example, we eliminated all those combinations with trenches on the parking lots because we thought this practice would be hard to implement due to the potentially high cost of pretreatment. Porous pavement is not included because of the potential disruption and cost associated with removing the existing pavement. Nine combinations of source area practices met our criteria for percent TSS reduction and reasonableness (Table 8).

All of the combinations included at least one source area practice in the residential area. To make them more reasonable, MCTTs and bioretention systems were applied to one-half the area. By treating one-half the area the number of bioretention systems required drops from 2,666 to 1333. Rain gardens were designed to treat one-half of the roof and lawn area. High efficiency sweeping is an important part of all the combinations except one. The 40% could not be achieved for the combinations without some kind of source area practice on the parking lots. In every case one of three source area practices (bioretention systems, MCTTs, and Delaware Perimeter Sand Filter) was designed to treat the entire area for each parking lot. Infiltration trenches along the freeway are the most effective freeway practice at a 6% TSS reduction, so they are included in three of the combinations.

### ***Selection of the Most Cost-effective Practices***

The most cost-effective practices will achieve the 40% goal for the least amount of cost. To calculate the cost the capitol cost is added to the maintenance cost assuming the practices have a useful lifespan of 20 years. The twenty year cost for the source area practice combinations ranges from \$11,000,000 to \$30,000,000 (Table 8). The next cheapest combination of source area practices is almost twice the cost of the cheapest one. Five of the combinations have a very similar cost. Making a choice between the combinations with similar cost is more a judgment of which ones are easiest to install.

All of the combinations of source area practices cost less than retrofitting detention ponds if you have to buy the land and the buildings on the land. To create 40 acres (20 acres of permanent pool and 20 acres of space around the pool) of open space in a developed area will probably mean buying some of the land that has buildings on it. In a medium density residential area this is equivalent to about 136 homes. Even if the cost of retrofitting the detention ponds is cheaper than the source area practices, it is unlikely the people living in the neighborhoods would tolerate the condemning of 136 homes to build the detention ponds.

If the conceptual costs for the street sweeping and the Delaware filter are realistic than combining these two practices is the most cost effective approach to reducing the TSS load to Lake Wingra by 40%. Improving

the street sweeping program for all the streets and installing Delaware Perimeter Sand Filters on all the parking lots seems like a reasonable goal for the city. To maximize the benefit of the enhanced sweeping programs the city should also implement alternate side parking restrictions. The city should be able to meet this goal by 2013 as required by NR 151. It will probably be more difficult to meet this time frame for combinations using MCTT, rain gardens, and bioretention systems in the residential areas.

**Table 8.** Cost of combining stormwater treatment practices to achieve a 40 to 45% reduction in annual TSS loads to Lake Wingra.<sup>1</sup>

Practice combinations	Total cost for twenty years <sup>1</sup> (\$)	Annual cost (\$)	Additional utility fee for households in Madison, \$/household/year. <sup>2</sup>
High sweep (All) <sup>3</sup> + Delaware Filter (Lots)	11,460,000	573,000	6
Bioretention (1/2 Res) + Delaware Filter (Lots) + High sweep (Com/Inst)	20,420,000	1,021,000	10
High sweep (Res) + MCTT (Lots) + Trench (Freeway)	19,860,000	993,000	10
MCTT (1/2 Res) + Delaware Filter (Lots) + High sweep (Com/Inst)	21,540,000	1,077,000	10
Gardens (1/2 Res) + High sweep (Res) + Bioretention (Lots) + Trench (Freeway)	25,240,000	1,262,000	12
Gardens (1/2 Res) + High sweep (All) + MCTT (Lots)	26,020,000	1,301,000	13
Bioretention (1/2 Res) + MCTT (Lots) + High sweep (Com/Inst)	27,940,000	1,397,000	14
MCTT (1/2 Res+ Com Lots) + High sweep (Com/Inst)	29,060,000	1,453,000	14
Bioretention (1/2 Res) + Trench (Com/Inst roof) + Bioretention (Lots) + Trench (Freeway) <sup>4</sup>	30,080,000	1,504,000	14
Detention Pond (treat 1/2 of area) <sup>4</sup>	19,260,000	963,000	9
Detention Pond (treat 1/2 of area) <sup>5</sup>	36,800,000	1,840,000	18

<sup>1</sup> Capital and maintenance cost included.

<sup>2</sup> Annual cost divided by 46,553 household paying stormwater utility fee in City of Madison and multiplied by 45% to adjust for percent of total utility revenues paid by homeowners.

<sup>3</sup> Does not include freeways.

<sup>4</sup> Includes cost of land.

<sup>5</sup> Includes cost of land and buildings.

Although the annual cost of the cheapest combination of practices is only about \$600,000, the impact of this cost can only be measured in terms of how much it will cost each tax payer. We are able to do this for the City of Madison because the city has created a stormwater utility district. Each household pays a utility fee of about \$36 a year. If we assume the utility district would use any additional fees to pay a bond back over twenty years, we can calculate the amount of increase to this fee by dividing the annual cost of the practice by the 46,553 households in the city and multiplying the result by 45%. In the City of Madison the households are paying about 45% of the utility fee, while the commercial and institutional property owners are paying the rest. To pay back the cost of the least expensive combination practice combinations would

raise the annual fee to each household by \$6 (Table 8). If the cost of the practices is assessed to just the people living in the Lake Wingra watershed the annual cost of the practices for each household would be approximately 6 times higher than the values in table 8.

The most expensive fee increase would be only \$14 each year. All the source area fees are in the range of the values for the regional practices. Only the taxpayers can answer the question if this too much money to significantly reduce the pollutant load to Lake Wingra, but it seems like a reasonable fee to pay.

## Conclusions

A six step process can be used to determine the most cost effective practices for achieving an annual TSS load reduction of 40% in an established urban area. An important element of the process is the use of an urban runoff model to determine the most important sources of the TSS and the levels of TSS reduction achieved by each management alternative. The steps are valuable for demonstrating the most cost effective management approach, but do not include the steps for selecting the sites, making final design decisions, and determining the actual cost for installing the practices at each site.

The goal of reducing the annual suspended loads by 40% to Lake Wingra can be achieved at what seems to be a reasonable cost to the Madison city taxpayers. A combination of source area practices, such as street sweeping and Delaware Perimeter Sand Filters on parking lots, are the most cost effective practices. Given the potentially high amount of disruption caused by the implementation of regional structural practices, a combination of source area practices also appears to be a more feasible way to achieve the reduction goal. Not only is a combination of source controls possibly more acceptable to the people living in the watershed, but also the annual cost to each household could be as little as six dollars. This is much less than retrofitting detention ponds at eighteen dollars for sites that include the cost of the buildings.

Although the retrofit performance standard in NR 151 is only for TSS, people in Wisconsin recognize there are other problem pollutants in storm water. Levels of heavy metals, polycyclic aromatic hydrocarbons (PAHs), and bacteria in storm water frequently exceed water quality standards (Bannerman and others, 1996). Some of these pollutants will be reduced if the TSS performance standard is achieved. Since SLAMM is designed to estimate loads for metals and PAHs, future reports will evaluate the sources and levels of control possible for other problem pollutants.

Both source area and regional practices will take at least ten years to implement. The source area practices because so many sites need to be installed and the regional practices because so much land must be secured. Combinations of practices that include street sweeping and source area practices on the parking lots have the best chance of meeting the retrofit deadline of 2013.

## REFERENCES

- Bannerman, Roger T., Baun, K., Bohn, M., Hughes, P.E. and Graczyk, D.A. (1983) Evaluation of Urban NPS Pollution Management in Milwaukee County Wisconsin, Vol I. EPA, Water Planning Division, PB84-114164.
- Bannerman, Roger T., Legg, Andrew D., and Greb, Steven R. (1996) Quality of Wisconsin Stormwater, 1989-94, U.S. Geological Survey, Open-File Report 96-458.

Bell, Warren; Stokes, Lucky; Gavan, Lawrence J. and Trong Ngu Nguyen. Undated, *Assessment of the Pollutant Removal Efficiencies of Delaware Sand Filter BMPS*, Alexandria, VA: City of Alexandria, Department of Transportation and Environmental Services.

Cavett, Christopher, 2002, Personal Communication, Maplewood, Minnesota.

Corsi, Steven R., Graczyk, David J., Owens, David W., and Bannerman, Roger T., 1997, Unit-Area Loads of Suspended Sediment, Suspended Solids, and Total Phosphorus from Small Watersheds in Wisconsin, U.S. Geological Survey, Fact Sheet FS-195-97

Corsi, Steven R., Greb, Steven; Bannerman, Roger T. and Robert E. Pitt, 1999, *Evaluation of the Multichambered Treatment Train, a Retrofit Water-Quality Management Practice*. U.S. Geological Survey Open-File Report 99-270. Middleton, WI: U.S. Geological Survey. 24p.

Dane County Regional Planning Commission. 1992. *Yahara Monona Priority Watershed Project Plan*. Madison, WI: Dane County Regional Planning Commission. 141p.

EPA, 1999, *National Stormwater Best Management Practices (BMP) Database. Version 1.0*, 1999. Office of Water, U.S. Environmental Protection Agency, Washington, D.C.

House, Leo B.; Waschbusch, Robert J. and Peter E. Hughes. 1993. *Water Quality of an Urban Wet Detention Pond in Madison, Wisconsin, 1987-88*. U.S. Geological Survey Open-File Report 93-172. Madison, WI: U.S. Geological Survey. 57p.

Martinelli, Thomas J., Waschbusch, R.J., Bannerman, R.T. and Wisner, Ann, 2002. *Pollutant Loading to Stormwater Runoff from Highways: The impact of Freeway Sweeping Program, Wisconsin Department of Transportation*, Research Project ID # 0092-4582.

Pitt, Robert and Voorhees, John. 2002. [winslamm.com](http://winslamm.com)

Shoemaker, Leslie; Lahlou, Mohammed; Doll, Amy and Patricia Cazenias, 2000, *Stormwater Best Management Practices in an Ultra-Urban Setting: Selection and Monitoring*. U.S. Department of Transportation, Federal Highway Administration Publication No. FHWA-EP-00-002, Office of Natural Environment, Federal Highway Administration, Washington, D.C. 287p.

Southeastern Regional Planning Commission, 1991. *Costs of Urban Nonpoint Source Water Pollution Control Measures*. Technical Report 31. Waukesha, WI: Southwestern Wisconsin Regional Planning Commission. 109p.

Steuer, Jeffrey; Selbig, William; Hornewer, Nancy and Jeff Prey, 1997, *Sources of contamination in an Urban Basin in Marquette, Michigan and an Analysis of Concentrations, Loads and Data Quality*. Water Resources Investigations Report 97-4242. Middleton, WI: U.S. Geological Survey. 25p.

Sutherland, Roger C. 1999 *Water Quality Benefits of High Efficiency Sweeping*. Pacific Water Resources, Inc., Beaverton, Oregon.

University of Wisconsin-Madison Water Resources Management 1999 Workshop, 1999, *Lake Wingra Watershed: A New Management Approach*. Madison, WI: UW-Madison Institute for Environmental Studies, 178p.

Walker, William W., 1990. *P8 Urban Catchment Model- Program Documentation*, Concord, Massachusetts.

Waschbusch, R.J., Selbig, W. R. and R. T. Bannerman, 1999. *Sources of Phosphorus in Stormwater and Street Dirt from Two Urban Residential Basins in Madison, Wisconsin, 1994-1995*. Water-Resources Investigations Report 99-4021. Middleton, WI: U.S. Geological Survey. 47p.

Waschbusch, Robert J. 1999. *Evaluation of the Effectiveness of an Urban Stormwater Treatment Unit in Madison, Wisconsin, 1996-1997*. Water Resources Investigations Report 99-4195. Middleton, WI: U.S. Geological Survey. 49p.

Winer, Rebecca, 2000, National Pollutant Removal Performance Database for Stormwater Treatment Practices, Center for Watershed Protection Ellicott City, Maryland

Young, G. Kenneth; Stein, Stuart; Cole, Pamela; Kammer, Traci; Graziano, Frank and Fred Bank. 1996. *Evaluation and Management of Highway Runoff Water Quality*. U.S. Department of Transportation. Federal Highway Administration Publication No. FHWA-PD-96-032. Office of Environment and Planning. Federal Highway Administration, Washington, D.C. 480p.

# MANAGEMENT STRATEGIES FOR URBAN STREAM REHABILITATION

By Derek B. Booth<sup>1,5</sup>, James R. Karr<sup>2,3</sup>, Sally Schauman<sup>4</sup>, Christopher P. Konrad<sup>1,5</sup>, Sarah A. Morley<sup>2</sup>, Marit G. Larson<sup>1,5</sup>, and Stephen J. Burges<sup>1,5</sup>

1. Center for Water and Watershed Studies, 2. School of Aquatic and Fishery Sciences, 3. Department of Zoology, 4. Department of Landscape Architecture, and 5. Department of Civil and Environmental Engineering; all at University of Washington, Seattle, WA 98195 USA.

## Abstract

Physical, hydrological, social, and biological conditions were evaluated at 45 stream sites in the Puget Lowland of western Washington, with watersheds ranging in area between 5 and 69 km<sup>2</sup> and having urban development as their dominant human activity. Using the benthic index of biotic integrity (B-IBI) as our biological indicator, we found a progressive decline in B-IBI with increasing watershed imperviousness but with large site-to-site differences at any given level of imperviousness in the contributing watershed. This variability is greatest at low to moderate levels of development; as development intensity increases, the range of biological conditions narrows. No threshold effects are apparent. Instream biological condition also varied directly with a new stream flow metric, showing significantly better correlations than with imperviousness. We also found a wide range of landscape conditions, some very degrading, in the backyards adjacent to these streams. These data do *not* suggest that the full range of hydrological and other ecological conditions can be replaced in a now-degraded urban channel; thus key management tasks are to identify those watersheds where low urbanization and associated high-quality stream conditions warrant protection, and to develop a new set of management goals for those watersheds whose surrounding development precludes complete ecosystem restoration but in which some recovery might be possible. There is no rational basis to support a common strategy in *all* watersheds, developed and undeveloped alike.

## Introduction

For decades, watershed urbanization has been known to harm aquatic systems. Although the problem has been long articulated, solutions have proven elusive because of the complexity of the problem, the evolution of still-imperfect analytical tools, and socio-economic and political forces with different and often incompatible interests.

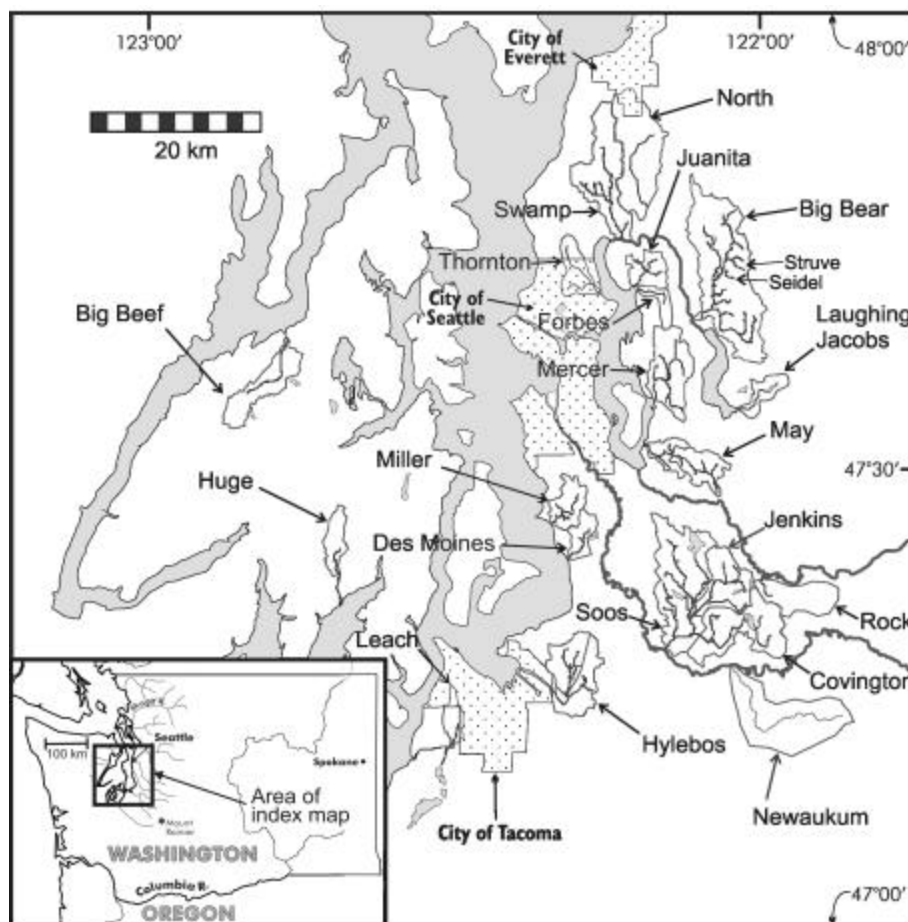
Recent Endangered Species Act (ESA) listings of Puget Sound chinook and bull trout, and the potential for more salmonid listings, have brought new scrutiny to all aspects of the Pacific Northwest's watershed protection and urbanization-mitigation efforts. Such increased attention is forcing a better articulation of the goals, the means, and the justification for mitigating the effects of urban development. It also has highlighted the failure of most stormwater mitigation efforts, not only in the Pacific Northwest but also across the country, where well-publicized successes are overshadowed by progressive degradation of once-healthy streams. This degradation has continued, despite sincere but ineffectual efforts via structural "Best Management Practices" (BMP's), particularly detention ponds, buffer regulations, and rural zoning.

Several factors make Puget Sound ideal for this study. Streams within our study region share relatively uniform soil, climate, and topography, allowing direct comparisons among streams. The region has a wide range of watershed development intensities and ages within a circumscribed area, including minimally

developed areas that serve as reference sites. All study watersheds have (or once had) diverse natural biotas, including anadromous salmonids; some moderately developed watersheds still support regionally valuable biological resources that merit protection and enhancement. Individuals and citizen groups support protection of aquatic resources in general and salmon in particular, and these groups are the focus of a variety of local agency efforts to improve public education and stewardship. Finally, major expenditures in the region are expected over the next decade in the name of “stream enhancement.” Improved knowledge should help direct these outlays to activities most likely to protect the region’s aquatic life (including its iconic endangered salmonids), protect water quality, and thereby maintain cherished components of the region’s quality of life.

## Study Sites and Methods

For this study, we focused on 45 sites selected from 16 second and third-order streams in King, Snohomish, and Kitsap counties (Fig. 1) that share the following physical characteristics: (1) watershed area between 5 and 69 km<sup>2</sup>; (2) local channel gradients between 0.4 and 3.2 percent; (3) soils, elevation, and climate typical of the central Puget Lowland; and (4) urban development as the dominant human activity (except in low-disturbance reference sites).



**Figure 1:** Map of Puget Lowland showing location of study streams and watersheds.



We explored the nature, and the causes, of change to aquatic-system health along a gradient of human activity. We used common measures of land cover (road density and total impervious area percentages) to characterize that “human activity.” Benthic invertebrates were sampled at each site between 1997 and 1999 (Morley, 2000; Morley and Karr, 2002). Substrate data were collected at 19 of the sites, and hydrologic analyses were made at the 18 sites located in close proximity to gauging stations without intervening tributary input (Konrad, 2000). Hydrologic analyses for ten additional lowland streams of similar characteristics, but some with watershed areas up to 171 km<sup>2</sup>, were also conducted. The social assessment had three parts—a survey of stream professionals, an in-depth evaluation of the landscape conditions in backyards adjacent to streams, and an evaluation of the values held by residents.

Although the hydrologic consequences of urban development are well documented at the scale of an individual storm (e.g., Hollis, 1975), consequences over longer periods are less well known. Because we expected the latter effects to be especially important to the biota of streams, we applied a hydrologic statistic to represent the annual distribution of storm and baseflow patterns: namely, the fraction of a year that the daily mean discharge exceeds the annual mean discharge ( $T_{Q_{\text{mean}}}$ ).

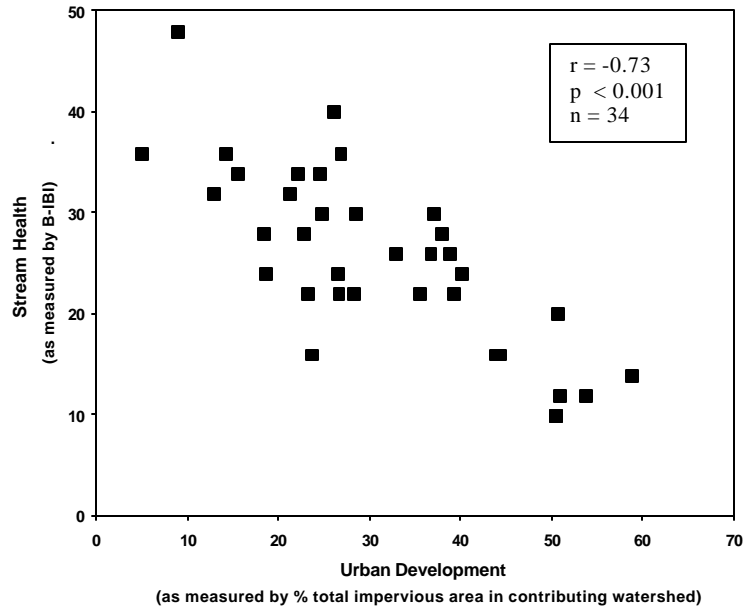
$T_{Q_{\text{mean}}}$  was calculated for each of the 18 streams by first determining the fraction of the year that the daily mean discharge ( $Q_{\text{daily}}$ ) exceeded the annual mean discharge ( $Q_{\text{mean}}$ ) for each year of record for each stream.  $T_{Q_{\text{mean}}}$  was then calculated as the average annual fraction of a year that  $Q_{\text{daily}}$  exceeds  $Q_{\text{mean}}$ , which averages about 30 percent of the time across this range of Puget Lowland streams.

## Results

### *Biological Condition at Multiple Land-Cover Scales*

Relationships between land cover and biological conditions display several trends. As a group, our study sites display a progressive decline in B-IBI (Karr, 1998) with increasing urban development, although large site-to-site differences exist at any given level of imperviousness in the contributing watershed (Fig. 2). This variability is particularly evident at low to moderate levels of development, where almost any degree of biological condition may be associated with a given level of imperviousness (see also Karr and Chu, 2000). As development intensity increases, the range of biological conditions narrows until, in the most urban of our watersheds, conditions are uniformly poor.

Across all study sites, urban land cover (i.e. the combination of “intense,” “grassy,” and “forested” urban categories) correlated approximately equally well with B-IBI at each of three spatial scales: *subbasin* (i.e., the entire watershed area upstream of the sample point;  $r = -0.73$ ,  $p < 0.001$ ), *riparian* (a 200-m-wide buffer on each side of the stream extending the full length of the upstream drainage network;  $r = -0.75$ ,  $p < 0.001$ ), and *local* (a 200-m-wide buffer on each side of the stream extending 1 km upstream;  $r = -0.71$ ,  $p < 0.001$ ) (Morley and Karr, 2002). In our data set, riparian and subbasin land cover closely correlated with each other ( $r = 0.98$ ,  $p < 0.001$ ).

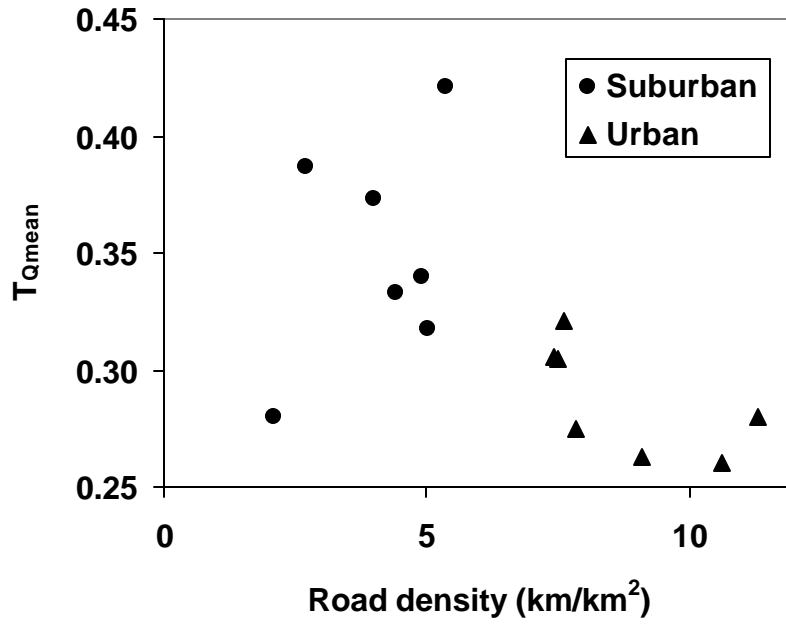


**Figure 2:** Relationship between watershed urbanization and stream health (i.e. biological condition) for our study streams as measured by total impervious area in the watershed upstream of benthic invertebrate sampling sites. Stream health is measured using the benthic index of biological integrity (B-IBI); samples collected 1997, 1998, and 1999.

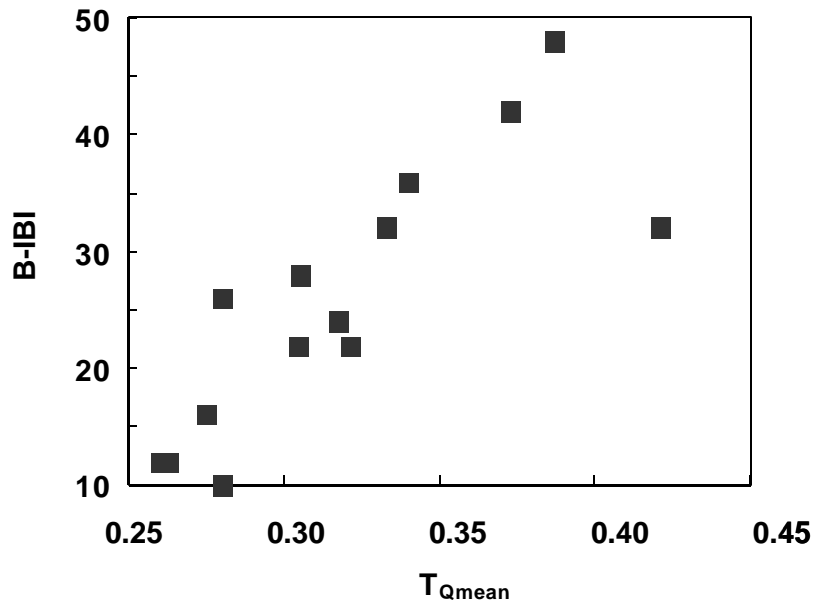
### *Hydrologic Changes*

Hydrologic effects of urban development are evident, even amidst the variability generated by physiographic differences among the basins in the Puget Lowland. In urban streams (road density  $>6$  km/km<sup>2</sup>), the fraction of time that the mean discharge is exceeded ( $T_{Q_{mean}}$ ) generally is less than 30% (and all  $\leq 32\%$ ), while in suburban streams (road density  $<6$  km/km<sup>2</sup>),  $T_{Q_{mean}}$  is generally greater than 30% (and all but one  $\geq 32\%$ ; Fig. 3). For WY 1989 to 1998, the mean value of  $T_{Q_{mean}}$  for 11 urban streams was smaller (0.29) than for 12 suburban streams (0.34). The difference is statistically significant ( $p < 0.01$  using Student's t-test of samples with equal variance). Independent of urban development, however, larger streams typically have more attenuated stream flow patterns than smaller streams and so higher values of  $T_{Q_{mean}}$  (Konrad and Booth, 2002). Thus  $T_{Q_{mean}}$  may only be a reliable indicator of urban development if stream basins are similar in drainage area and other physiographic factors.

The biological conditions of streams varied directly with this stream flow metric (Fig. 4), with significantly better correlations than for simple land-cover metrics (see Fig. 2). Variability in B-IBI is still significant, however, because flow regime is only one factor controlling biotic integrity; for any value of  $T_{Q_{mean}}$ , the B-IBI range is about 10.



**Figure 3:** Fraction of year that mean discharge rate is exceeded ( $T_{Qmean}$ ) as a function of watershed road density.



**Figure 4:** Benthic index of biological integrity (B-IBI) plotted against fraction of time that daily mean discharge rate exceeds annual mean discharge rate ( $T_{Qmean}$ ) for Puget Lowland streams with biological and hydrologic data.

## *Social Assessment*

The social assessment yielded a rich array of results. The most insightful was finding a wide variation in backyard conditions where streams were located. These subject properties ranged from those adjacent to streams, located in watersheds having a county-funded steward who provided extensive public education, to backyards in neighborhoods with little community awareness of the stream at all. In all locations the range of conditions varied from benign neglect to severe, “ecopathic” destruction of the landscape adjacent to the stream. Broad social measures do not explain these differences in behavior, but the influence of these actions on stream health (whether benign or damaging) was locally very significant.

## **Discussion**

Correlations between watershed development and aquatic-system conditions have been investigated for over two decades. Klein (1979) published the first such study, where he reported a rapid decline in biotic diversity where watershed imperviousness much exceeded 10 percent. Steedman (1988) believed that his data showed the consequences of both urban land use and riparian condition on instream biological conditions. Later studies, mainly unpublished but covering a large number of methods and researchers, was compiled by Schueler (1994). Since that time, additional work on this subject has been made by a variety of Pacific Northwest researchers, including May (1996), Booth and Jackson (1997), Karr (1998), and Morley and Karr (2002)

These data have several overall implications:

- “Imperviousness,” although an imperfect measure of human influence, is clearly associated with stream-system decline. A wide *range* of stream conditions, however, can be associated with any given level of imperviousness, particularly at lower levels of development.
- “Thresholds of effect,” articulated in some of the earlier literature (e.g., Klein, 1979; Booth and Reinelt, 1993) exist largely as a function of measurement (im)precision, not an intrinsic characteristic of the system being measured. Crude evaluation tools require that large changes accrue before they can be detected, but lower levels of development may still have consequences that can be revealed by other, more sensitive methods. In particular, biological indicators (e.g., Figure 2) demonstrate a continuum of effects, not a threshold response, resulting from human disturbance (Karr and Chu, 2000).
- Although direct correlation of imperviousness with biological health is overly simplistic, imperviousness is a useful index of human activity in a watershed because it provides a gross measure of the watershed area appropriated by people, and thus it functions as a first-order indicator of human influence on selected processes supporting stream ecosystems. Many of the changes that degrade streams are progressively more likely to occur as human activity increases (Booth et al., 2002). The fraction of impervious area is not a suitable surrogate of stream health, however, because this metric neither captures nor diagnoses all major causes of stream degradation; neither does it provide an adequate guide to effective solutions. In combination with other measures and analyses, however, it can enhance both river protection and restoration.

## Management Implications

Development that minimizes the damage to aquatic resources cannot rely on structural BMP's, because there is no evidence that they can mitigate any but the most egregious consequences of urbanization. Instead, control of watershed land-cover changes, including limits to both imperviousness and clearing, must be incorporated (see also Horner and May, 1999). We anticipate needing *all* of the following elements to maintain the possibility of effective protection:

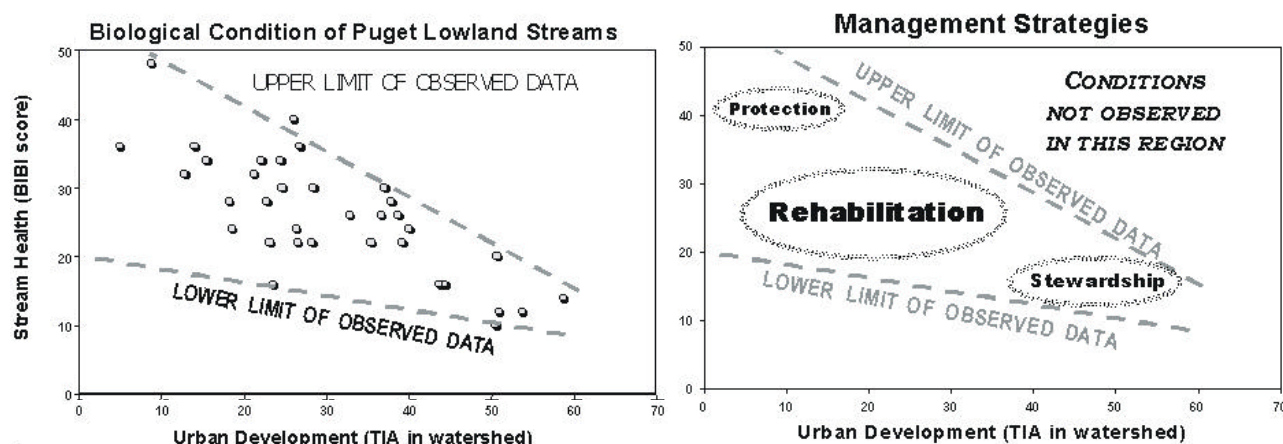
- clustered developments that protect half or more of the natural vegetative cover, preferentially in headwater areas and around streams and wetlands to maintain intact riparian buffers;
- a maximum of 20% total impervious area, and substantially less effective impervious area through the widespread infiltration of stormwater (Konrad and Burges, 2001);
- on-site detention, realistically designed to control flow durations (not just peak discharges);
- riparian buffer and wetland protection zones that minimize road and utility crossings as well as overall clearing;
- no construction on steep or unstable slopes; and
- a program of landowner stewardship that recognizes the unique role of adjacent private property owners in maintaining or degrading stream health.

Past experience suggests that each of these factors is important. However, we still lack empirical data on the response of aquatic resources to such “well-designed” developments. Therefore, these recommendations are based only on extrapolations, model results, and judgement; they have yet to be tested. Where development has already occurred, these conditions clearly *cannot* be met and different management objectives are inescapable: many, perhaps all, streams in already-urban areas cannot be truly protected or restored, and a significant degree of probably irreversible stream degradation is unavoidable in these settings.

Our detailed analysis of one feature, *flow regime*, demonstrates the importance of this particular aspect of the aquatic system. Hydrologic alteration is ubiquitous in all urban watersheds, and flow regime is a key determinant of ecological health and biological condition. Stream conditions are not solely determined by flow regime, however, and flow regime is not solely determined by urban development—intrinsic watershed characteristics (watershed geology, soil permeability and depth, topography, channel network, climate) are also relevant. Thus no single watershed indicator can predict flow regime or the consequences of its change on stream conditions, even a metric that provides ecologically useful measures of the variability of stream flow. A new paradigm that systematically ignored water chemistry or the effects of alteration of stream channels, for example, would be no more defensible than previous regulatory mandates that focused *only* on these parameters.

We cannot find any basis to expect that the full range of hydrological and other ecological conditions can be replaced in a now-degraded urban channel (Fig. 5). The key tasks facing watershed managers, and the public that can support or impede their efforts, are therefore (1) to identify those watersheds where existing low urbanization, and associated high-quality stream conditions, warrant the kinds of development conditions that may protect much of the *existing* quality of these systems; and (2) to develop a new set of management goals for those watersheds whose surrounding development precludes significant ecosystem restoration but in which some recovery might be possible. Where urban development is virtually complete, our results (and common sense) suggest that neither widespread riparian-corridor replanting nor extensive

hydrologic rehabilitation of the watershed are feasible or could achieve great biological improvements. Stream-enhancement efforts can still be important and worthwhile, for both in-stream biota and the people that live in their watersheds. There is no rational basis to support a common strategy in *all* watersheds, developed and undeveloped alike.



**Figure 5:** Management strategies as suggested by the distribution of B-IBI data as a function of the % total impervious area (TIA) in the contributing watersheds of our study. Although management goals are commonly articulated for the upper right-hand corner of these graphs (i.e. high-quality streams in highly urbanized watersheds) we find no evidence, and thus little hope, that this does or can occur.

## Acknowledgments

This work was supported by the United States Environmental Protection Agency and National Science Foundation Water and Watersheds Program, EPA Grant R82-5284-010, for which this paper is a partial summary of the final report (Booth et al, 2001). Additional support for this project came from King County and the Stormwater Technology Consortium of the Center for Urban Water Resources Management (for DBB) and from the Consortium for Risk Evaluation (CRESP) by Department of Energy Cooperative Agreements #DE-FC01-95EW55084 and #DE-FG26-00NT40938 (for JRK). We are grateful to collaborative efforts from David Hartley, Rhett Jackson, Patricia Henshaw, Erin Nelson, and Jenna Leavitt; Wease Bollman and Robert Wisseman for taxonomic consultation; Laura Reed and Kris Rein for field and lab assistance; and Marina Alberti, Kristina Hill, and other members of the University of Washington PRISM project for guidance in matters of GIS.

## References

- Booth, D. B., Hartley, D., and Jackson, C. R. 2002. Forest cover, impervious-surface area, and the mitigation of stormwater impacts. *Journal of the American Water Resources Association* 38: 835-845.
- Booth, D. B., and Jackson, C. R. 1997. Urbanization of aquatic systems—degradation thresholds, stormwater detention, and the limits of mitigation. *Water Resources Bulletin* 33: 1077–1090.

- Booth, D. B., Karr, J. R., Schauman, S., Konrad, C. P., Morley, S. A., Larson, M. G., Henshaw, P., Nelson, E., and Burges, S. J. 2001. Urban stream rehabilitation in the Pacific Northwest. Final report to U. S. EPA, grant no. R82-5284-010, 78 p.
- Booth, D. B., and Reinelt, L. E. 1993. Consequences of urbanization on aquatic systems--Measured effects, degradation thresholds, and corrective strategies. Watersheds '93, Conference sponsored by U. S. Environmental Protection Agency, Alexandria, VA, March 21-24, p. 545-550.
- Hollis, G. E. 1975. The effect of urbanization on floods of different recurrence interval. *Water Resources Research* 11: 431-435.
- Horner, R. R., and May, C. W. 1999. Regional study supports natural land cover protection as leading Best Management Practice for maintaining stream ecological integrity. *In* Comprehensive Stormwater and Aquatic Ecosystem Management, conference papers. New Zealand Water and Wastes Association, 22-26 February 1999, p. 233-247.
- Karr, J. R. 1998. Rivers as sentinels: Using the biology of rivers to guide landscape management. Pages 502-528 in R. J. Naiman and R. E. Bilby, eds. *River Ecology and Management: Lessons from the Pacific Coastal Ecosystems*. Springer, NY.
- Karr, J. R. and Chu, E. W., 2000. Sustaining living rivers. *Hydrobiologia* 422/423: 1-14.
- Klein, R. 1979. Urbanization and stream quality impairment. *Water Resources Bulletin* 15: 948-963.
- Konrad, C.P. 2000. The frequency and extent of hydrologic disturbances in stream in the Puget Lowland, Washington. Ph. D. Dissertation, Department of Civil Engineering, University of Washington, Seattle, Washington, USA.
- Konrad, C. P., and Booth, D. B. 2002. Hydrologic trends resulting from urban development in western Washington streams: U.S. Geological Survey Water-Resources Investigation Report, 02-4040. Department of the Interior, Washington, DC, USA.
- Konrad, C. P., and Burges, S. J. 2001. Hydrologic mitigation using on-site residential storm-water detention. *Journal of Water Resources Planning and Management* 127: 99-107.
- May, C. W. 1996. Assessment of cumulative effects of urbanization on small streams in the Puget Sound Lowland ecoregion: implications for salmonid resource management. Seattle, University of Washington, Department of Civil Engineering, Ph.D. dissertation, 383 p.
- Morley, S. A. 2000. Effects of urbanization on the biological integrity of Puget Sound lowland streams: restoration with a biological focus. Seattle, University of Washington, M.S. Thesis.
- Morley, S. A., and Karr, J. R. 2002. Assessing the biological health of urban streams in the Puget Sound Basin. *Conservation Biology*. In press.
- Schueler, T. R. 1994. The importance of imperviousness. *Watershed Protection Techniques* 1: 100-111.
- Steedman, R. J. 1988. Modification and assessment of an index of biotic integrity to quantify stream quality in Southern Ontario. *Canadian Journal of Fisheries and Aquatic Sciences* 45: 492-501.

# REMEDICATION OF STORMWATER RESIDUALS DECANT WITH HYDROCOTYLE RANUNCULOIDES

Katie Bretsch  
Program Development Assistance  
Portland, Oregon

## Abstract

A stormwater residuals decant treatment regime employing floating marsh pennywort, *Hydrocotyle ranunculoides*, is apparently effective at remediating lead-contaminated suspended solids, 25 microns and less, after one year's experience in Portland, Oregon.

Gravity settling provided by Portland's existing stormwater sediment dewatering facility does not give sufficient pollutant removal, and Portland experienced occasional exceedances of local pretreatment limits for lead. In March of 2001, Portland began a full-scale trial of stormwater residuals decant treatment using marsh pennywort, or *Hydrocotyle ranunculoides*. This free-floating aquatic plant is locally acceptable for aquatic landscaping and needs no special control.

First-year review found this project apparently successful and very inexpensive. Preliminary second-year data continues to show promise and minimal cost.

## Project Context

Portland, Oregon maintains a separate stormwater collection and treatment system, which includes over 15,000 sumps and sedimentation manholes that drain only curbed and guttered urban streets. Over 1,800 metric tons of stormwater residuals are recovered by vacuum eductor truck (Vactor<sup>®</sup>) from these facilities annually. These residuals are contaminated with common urban stormwater pollutants, most prominently TPH, lead and cPAHs. The contaminants are mostly fixed -- adsorbed to the fine soils which dominate these residuals (Bretsch, 2002). On average, fine particles 31.2 microns and less account for 22% of residual solids particle counts.

The residuals are recovered along with substantial amounts of standing stormwater and injected chlorinated tap water. They are discharged onto sloped pads at the City's Inverness Stormwater Sediment Dewatering Facility from vacuum eductor trucks at about 90% water by weight, or pea soup consistency. After dewatering to about 25% water by weight, or dry enough to pass a "paint filter test," the material is removed for thermal remediation and recycling.

Decant off Portland's tennis court size Vactor<sup>®</sup> dumping pads flows through sloped channels with weirs of wood and screen fabric intended to catch the large floatables, then through a system of ductile iron pipe and shallow below-ground sedimentation manholes to a two-celled settling tank made from a section of the old aeration settling basin of an abandoned wastewater treatment plant. An overflow stand pipe in the second cell allows continuous discharge to the City's sanitary sewer system.



This dewatering process yields about 684,000 liters of decant annually. The decant is pretreated prior to discharge into the City's sanitary sewer system in order to protect the City's wastewater system biosolids quality, a critical City objective.

The decant carries ultra-fine suspended solids which are negatively charged and resistant to settling by gravity (Collins, 1999; Ghezzi, M., Collins, J., Moore, J., Bretsch, K., and Hunt, L., 2001). A \$300,000 facility improvement provided additional gravity settling. But, gravity settling alone failed to provide consistent enough pollutant removal at the desired levels of operation. In consequence, dewatering facility decant occasionally exceeded local pretreatment limits for lead of 0.7 mg/L. The City's goal is to consistently meet a 0.2 mg/L limit. In response, the City began plans for a second six-figure facility expansion project to provide additional gravity settling capacity.

Working in cooperation with the Oregon Department of Transportation (ODOT) and the Oregon Department of Environmental Quality (DEQ) under the auspices of the Federal Highway Administration (FHWA) funded ODOT Roadwaste Research Project, Portland also explored methods for achieving better removal of decant solids with the existing facility. Because Portland's stormwater Vactor© waste represents the worst case for stormwater residuals quality in Oregon, finding a best value solution to Portland's Vactor© waste decant pretreatment problem promised to be helpful to roadwaste management agencies elsewhere, as well.

Portland conducted chemical flocculation trials as one alternative, and trial results are documented in the Phase Two Report of the ODOT Roadwaste Research Project (Ghezzi, M., Collins, J., Moore, J., Bretsch, K., and Hunt, L., 2001). Electroflocculation, as demonstrated by Dennis Jurries, PE, of the Oregon DEQ using stormwater with suspended fines from construction site erosion (Jurries, 2000), was also considered. These methods were found practicable, but the projected treatment costs of about US\$0.38 per liter were deemed prohibitive.

Reasoning that only a marginal increase in decant quality was required, that some of the stormwater treatment value provided by plants in a constructed wetland might occur if a large enough planting could be propagated and maintained in the decant tank, that the potential benefits were high and the cost of failure was low, the author initiated a search for suitable aquatic plants.

Voluntary duckweed (*Lemna*) colonies had previously appeared in the tank, but were flushed through the system during rain events. Pennywort was selected for trial because it is free-floating, easily contained, a locally acceptable native, and available. Risks of escape were well considered. Because it propagates by budding, seed distribution by wind or animal life is not a risk.

## **Implementation**

A trial of phytoremediation was begun in May of 2001 by introducing a 19-liter starter bucket of the floating marsh pennywort plant material into the first cell of the decant tank (Figure 1.). *H. ranunculoides* is a native, free floating perennial found throughout the United States (PLANTS Database, 2002). The plant material was gleaned from an ornamental pond maintained on the grounds of the City's Columbia Boulevard Wastewater Treatment Plant.



**Figure 1** Photograph shows pennywort growing in the first cell of Portland's Vactor© waste decant tank. About three months after its initial introduction into the tank, the pennywort has formed a dense colony about 2.5 m square.

Plastic roll screening material with 1.3 cm openings and non-woven filter fabric of the kind used in erosion control were used to confine the plant material in the first cell of the tank.

The plant material thrived and filled out the cell by July of 2001 (Figure 2). So far, the plant material has proven hardy in this implementation. Just as in an ornamental planting, it pales and slows its growth during the winter months, but no substantial winter dieback has occurred. It also pales and slows its growth during the warmest sunny summer months, when decant tank flow is warmed and reduced by evaporation.



**Figure 2.** Photograph shows a dense matt of the vigorous pennywort completely covering the surface of the first cell of Portland's Vactor© waste decant tank in August, 2002.

To further test the technology and compensate for variables such as weather and changes in Vactor<sup>®</sup> cleaning program activity which couldn't be isolated in this trial, additional plant material was introduced into the second cell of the decant tank starting in the Spring of 2002. A full second year review could be conducted in June of 2003.

## Operation

No appreciable additional operating needs or costs were presented by the introduction of plant material into the decant treatment stream during the trial. Thinning of the plant colony may eventually be needed. Replacement may be required if the very rare extended hard freeze that can occur in Portland proves fatal. No additional nutrients or other treatments have been required for the health of the plants. As a public health measure, the tank is treated with Bt (*Bacillus thuringiensis*) to inhibit mosquito hatching at appropriate intervals during the warm season.

At about six month intervals, both cells of the tank are drained, and the mucky settled solids are cleaned from the bottom by Vactor<sup>®</sup> extraction. The cleanings removed from the tank are placed back onto the Vactor<sup>®</sup> dumping pad for dewatering, remediation and recycling.

*H. ranunculoides* plants are available locally in the Portland, Oregon area from commercial nurseries which supply native aquatic plants at about US\$1.00 per plant. The starting colony for one cell in this trial probably consisted of the equivalent of 100 commercial plants.

If thinning or removal of the plant material is required, testing to assess pollutant concentrations in the removed material should be performed. As with any phytoremediation project, disposal of plant materials should be guided by the findings of appropriate testing.

## Monitoring

Accurately measuring the fine, contaminated, negatively-charged colloidal soil particles found suspended in stormwater Vactor<sup>®</sup> waste decant proved by itself to be a challenge. The standard pretreatment screening test for total suspended solids (TSS) proved imperfect, because the filter used to capture solids was found to have a 25-micron pore size. A particle size study found that over 90% of solids in the decant were under 25 microns.

We considered turbidity (NTU) as an alternative indicator, and rejected it because it also reflects other factors which couldn't be controlled in this operational setting, such as color from dissolved substances and non-target particles of organic matter. In the end, we chose total lead (EPA 200.8) as our primary monitoring parameter. Lead is adsorbed preferentially to the fine solids (Collins, 1999); and lead is the contaminant of concern for protection of the City's wastewater processes by decant pretreatment.

The progress of the plant colony was observed and photo-documented. Samples representative of the decant discharges were tested for lead at routine intervals dictated by the City's pretreatment compliance monitoring program. Older and younger plant material was removed from the tank for close visual inspection.

## Discussion

### *Appropriate and Successful Plant*

A perennial native species, *H. ranunculoides* (Figure 3) requires no special substrate or media. While relatives of this plant have been identified as invasive pest species in Britain and elsewhere, *H. ranunculoides* is listed as endangered in Illinois. In the maritime Pacific Northwest, it is considered a desirable native species for ornamental propagation. It presents no obvious risk of escape in the setting under trial. In Portland's trial, it quickly covered the surface area of the tank. It thrived for most of the year, being somewhat discouraged in growth only during the warmest and coolest months. The test site near Portland Airport did not experience a hard freeze during the trial period, however.



**Figure 3.** *H. ranunculoides* plant material shown against graph paper to illustrate form and scale. Depth of highly tangled root mass is about 10 cm. Height of mature stem and leaf is about 20 cm or more above root. Plant colonies form a dense floating matt.

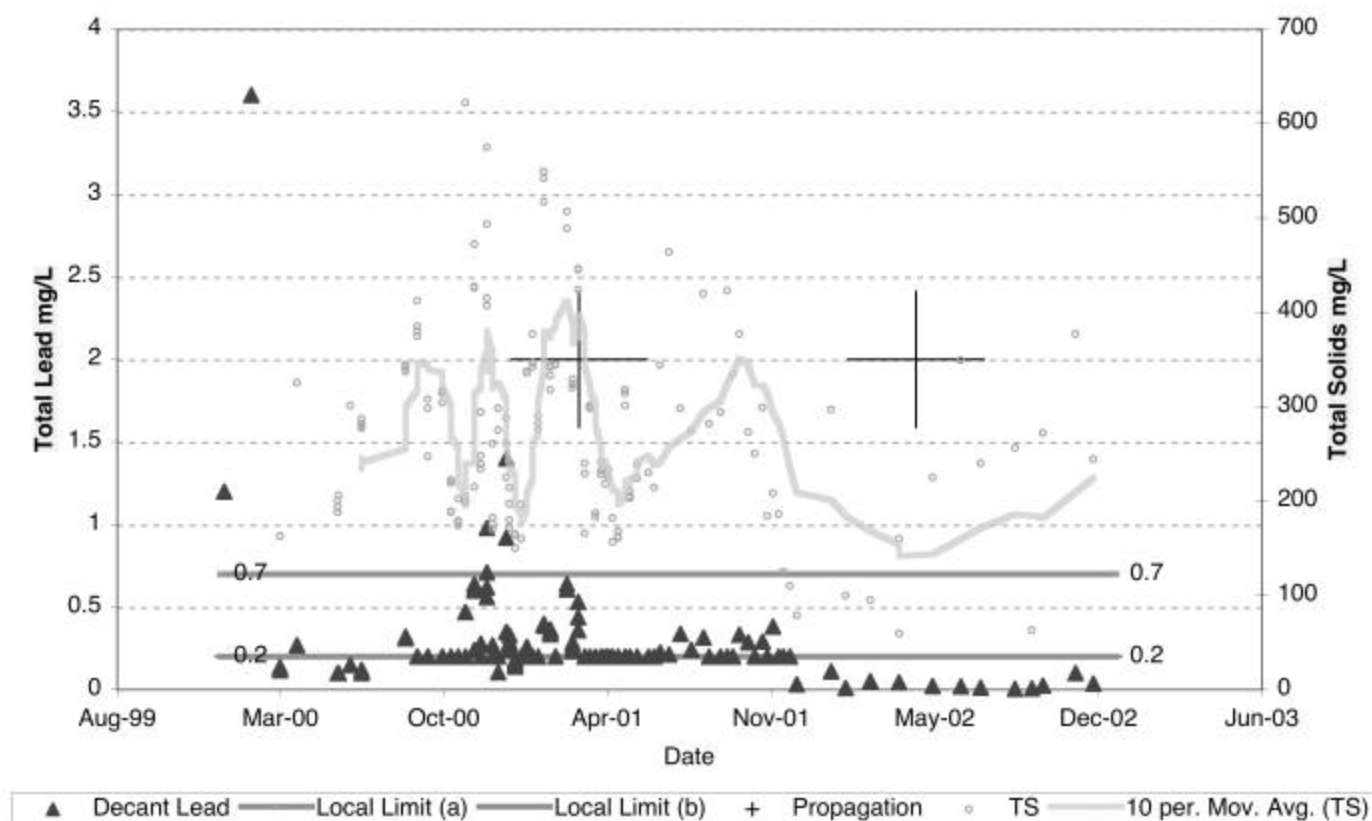
Volunteer blooms of duckweed (*Lemna*) had appeared previously in the decant tank, but had been flushed out by rainfall events. *H. ranunculoides* is far more easily contained. In fact, it provides some containment for duckweed, which appeared as a minor voluntary overgrowth in the second summer. Based on visual observation as well as close handling of removed bucket samples, both the mass and immersed surface of the pennywort, with its heavy, tangled and tough, almost woody root system, broad leaves and long stems, dwarfed that of the duckweed in Portland's trial.

Plant material has not yet been sampled to determine the amount, if any, of metal hyper-accumulation. From an operational perspective, this testing will be critical to establish appropriate management of any plant material wasted from the process

### Apparently Successful Remediation

Operationally valuable improvement in decant lead results and visual observation appear to support the finding that *H. ranunculoides* is effective at remediating wastewater contaminated with lead bound to ultra-fine suspended solids in stormwater Vactor® waste decant. Previously absent flocculation and settling is observable in the tank and is the presumed method of remediation.

**Portland Vac Waste Decant**



**Figure 4.** Graph illustrates Portland’s Vactor® waste decant total lead and total solids results from January, 2000 to December, 2002, in relation to local wastewater pretreatment limits and the dates pennywort was introduced into the decant treatment regime, first in March 2001, and second in May 2002. A stable pattern of lower values has been coincident with the presence of the pennywort.

Decant monitoring for total lead and total solids shows (Figure 4.) that the presence of pennywort in the decant treatment stream has been coincident with an operationally significant and stable pattern of lower values. Prior to the introduction of the pennywort, exceedances of a 0.7 mg/L local limit were a source of concern. None have reoccurred since the introduction of the pennywort. No exceedances of the lower 0.2 mg/L limit have occurred since Fall of 2001.

## ***Minimal Cost***

Because the plant material for this trial was obtained as surplus from an ornamental planting, and the plant has proven both a vigorous grower, and to have no special operational needs in this implementation, the treatment cost observed in this trial is estimated at less than US \$0.01 per liter. Competing commercial technologies would run about 40 times that, based on Portland's previous trials.

## ***Unanswered Questions***

As a field trial, this project was successful enough. However, as a scientific endeavor, this project leaves many important questions unanswered.

Important variables such as changes in Vactor® cleaning program activity and rainfall could not be isolated in this full scale trial. How much remediation value is provided by plants alone in a controlled setting? Are the author's beliefs about the primary remediation mechanism verifiable in the lab? How much filtration is occurring? Fines may be adhering and then sloughing off the root surface; but, if so, this is not observable with the naked eye. Do the plant roots carry a slight positive charge? Will waste plant mass require special management? The author cannot say.

The data is good enough for operational purposes, but poor by scientific standards. The author has received expressions of interest from individuals in the academic community to take these investigations further, and hopes to see these questions answered in the future with their help. The author considers the field trial results presented in this paper preliminary but promising.

## ***Phytofloculation?***

The American Heritage Dictionary defines phytoremediation as, "the use of plants and trees to remove or neutralize contaminants, as in polluted soil or water (American Heritage Dictionary, 2003). In constructed wetlands and other biologically based wastewater treatment regimes, plants are widely recognized to provide treatment value via the natural phenomena of rhizofiltration, nutrient consumption and hyperaccumulation.

The EPA defines flocculation as a "process by which clumps of solids in water or sewage aggregate through biological or chemical action so they can be separated from water or sewage" (EPA, 2003). Based on field observation, the author believes that the plant material provided remediation by *flocculation* of the lead contaminated ultra-fine suspended solids in this trial. Although the exact mechanism of treatment has yet to be clearly established in the lab, the author proposes to call this natural phenomena *phytofloculation*.

## **Thanks**

The author would like to thank Linda Dartsch, PE, Manager of the City of Portland, Environmental Services, Collection Systems Operations and Maintenance Division, for the opportunity to do this trial, Paul Johnson of Portland's Maintenance Bureau for project assistance, Atina Casas of the City's Environmental Services Investigations and Monitoring Division for technical assistance, and the staff and partners of the ODOT Roadwaste Research Project for collegial support.

## References

Bretsch, K., July 2002. Oregon's Vector© Waste Data Reviewed. Paper presented at the Transportation Research Board A1F07 & A3C01 Committees 2002 Summer Workshop, Helena, MT. PDF available from the author.

Collins, J., 1999. Roadwaste: Issues and Options, FHWA-OR-99-05, ODOT, Salem. This report is informally known as the ODOT Roadwaste Research Project Phase 1 Report. PDF available for download from ODOT Research Division web site.

Ghezzi, M., Collins, J., Moore, J., Bretsch, K., and Hunt, L., 2001. ODOT Roadwaste Research Project: Field Trials. Includes reports on filter box, chemical flocculant, and other field trials, and worker safety plans. Available for download from the ODOT Research Division web site.

Houghton Mifflin, 2000. "Phytoremediation." The American Heritage® Dictionary of the English Language, 4th ed. Boston: [www.bartleby.com/61/](http://www.bartleby.com/61/).

Jurries, D., 2000. Personal communication. Jurries is a specialist in erosion control and the chemistry and behavior of suspended sediments for Oregon DEQ. He has demonstrated electroflocculation as a method of removing suspended sediments from construction site runoff. Contact information available via Oregon DEQ's web site.

Moore, J., and Collins, J., 2001. ODOT Roadwaste Research Project: Roadwaste: Guide for District Plans, APWA Draft, ODOT, Salem. Includes recommended ODOT BMPs. Available from the ODOT Research Division web site.

USDA, NRCS, 2002. The PLANTS Database, Version 3.5 (<http://plants.usda.gov>). National Plant Data Center, Baton Rouge, LA 70874-4490 USA.

USEPA, ORD, 2002. "Terms of Environment", Update 30 Dec (<http://www.epa.gov/OCEPAterms/>).

# INAPPROPRIATE DISCHARGE DETECTION AND ELIMINATION WHAT PHASE I COMMUNITIES ARE DOING TO ADDRESS THE PROBLEM

Jennifer Zielinski and Ted Brown  
Center for Watershed Protection  
Ellicott City, Maryland

## Abstract

Inappropriate connections to storm drain systems account for significant annual pollutant loads from urban areas. Inappropriate discharge detection and elimination (IDDE) are important elements of any effective stormwater quality management program. Since 1990, under US EPA's National Pollutant Discharge Elimination System (NPDES) Phase I Storm Water Program, cities and counties with populations of 100,000 or more that operate a municipal separate storm sewer system (MS4) were required to obtain discharge permit coverage. An element of NPDES Phase I, Part I was that regulated MS4s were required to perform discharge characterization by screening outfalls for inappropriate connections to MS4s. NPDES Phase I, Part II required regulated MS4s to demonstrate adequate legal authority to control discharges, prohibit inappropriate discharges, require compliance, and carry out inspections, surveillance and monitoring (EPA, 1996). As a result, 173 cities and 47 counties (Glanton *et al.*, 1992) were required to develop IDDE programs.

In 2001, the Center for Watershed Protection (CWP) and Dr. Robert Pitt from the University of Alabama obtained a multi-year grant from US EPA to research the most cost-effective and efficient techniques that can be employed to identify and correct inappropriate discharges, and write a "Users Guide" geared toward use by NPDES Phase II communities and citizen volunteers. One element of the research is investigating and compiling data and methods that have been employed in pursuit of IDDE by NPDES Phase I MS4s. CWP conducted a survey of 24 NPDES MS4s representing various geographic and climatic regions in the U.S. to research what these communities have been doing on the IDDE front. Surveys requested information about: community characterization; system characterization; IDDE program characterization; legal authority; system mapping; procedures used for inappropriate discharge identification, confirmation, source identification and correction; education and outreach; and other programmatic features or references. This paper presents the findings of the survey and provides inferences that can be drawn about the collected data.

## Introduction

The Center for Watershed Protection (CWP) and Dr. Robert Pitt, University of Alabama, are working under a multi-year grant from the US EPA to research the most cost effective and efficient techniques that can be employed to identify and correct inappropriate discharges, and to develop a "Users Guide" for use by National Pollutant Discharge Elimination System (NPDES) Phase II jurisdictions and citizen volunteers. One element of the research is investigating and compiling data and methods that have been employed in pursuit of inappropriate discharge detection and elimination (IDDE) by NPDES Phase I MS4s.

A survey was developed and submitted to over 50 local jurisdictions representing various geographic and climatic regions in the United States that have implemented IDDE programs. The intent of the survey was to



determine the current state of practices utilized by local governments, and to identify practical, low cost, and effective techniques that have been implemented in the field and laboratory for inappropriate discharge detection and elimination. The survey information will be used in the preparation and development of the Users Guide. This paper summarizes the results of the survey.

## **Design of Survey**

The survey was designed to elicit detailed information on existing IDDE programs and to gain insight on the following topics: (A copy of the survey can be accessed from [www.cwp.org](http://www.cwp.org))

1. Community Characterization
2. System Characterization
3. Inappropriate Discharge Detection Elimination (IDDE) Program Characterization and Cost
4. Legal Authority
5. System Mapping
6. Methods to Identify and Confirm Inappropriate Discharges
7. Inappropriate Discharge Corrections Program
8. Education, Outreach, and Pollution Prevention Programs

The target audience for the survey included jurisdictions that have implemented IDDE programs, primarily those subject to NPDES Phase I requirements. Jurisdictions selected for the survey represent a variety of geographic and climatic regions. The EPA stormwater coordinators for each region of the country were contacted for recommendations on jurisdictions to include in the survey. A variety of jurisdiction sizes were targeted on the basis of population, IDDE program service area, and land use. The ages and reputations of the program were also considered. The survey was sent to 57 jurisdictions, with 24 jurisdictions (42%) from 16 states completing the survey (Figure 1).

Surveys were supplemented by on-site interviews of IDDE program staff in seven jurisdictions: Baltimore City, MD; Baltimore County, MD; Boston, MA; Cambridge, MA; Dayton, OH; Raleigh, NC; and Wayne County, MI, witnessing field operations when possible.

## **Survey Results**

### ***Community Characterization***

Of the 24 jurisdictions that completed the survey, 18 are NPDES Phase I jurisdictions, one was awaiting the issuance of its Phase I permit, two are Phase II jurisdictions, two operate under a Stormwater General Permit, and one is a Special Purpose District servicing both Phase I and Phase II jurisdictions (Table 1). Of the 24 respondents, only 21 have fully implemented IDDE programs. Alexandria and Falls Church, Virginia, are both currently developing programs as part of their NPDES Phase II requirements. Seattle, Washington, currently addresses inappropriate connections via water quality complaints and a routine business inspection program. Seattle's Phase I NPDES permit is currently being updated, and the next permit cycle will require the implementation of a full inappropriate discharge reduction program. Even

though these three jurisdictions have not fully implemented their programs, they have each implemented some elements. Therefore, data reported throughout this paper reflects varying numbers of responses to different survey questions.

Overall, the respondents included five counties, 18 cities, and one Special Purpose District. Land use was varied, but tended towards ultra-urban, urban, and suburban. The population density ranged from 175 to 15,000 people per square mile, with a median of 2,600 people per square mile. The jurisdictions also vary in service area, with ranges from 2 to 498 square miles, and a median of 70 square miles.

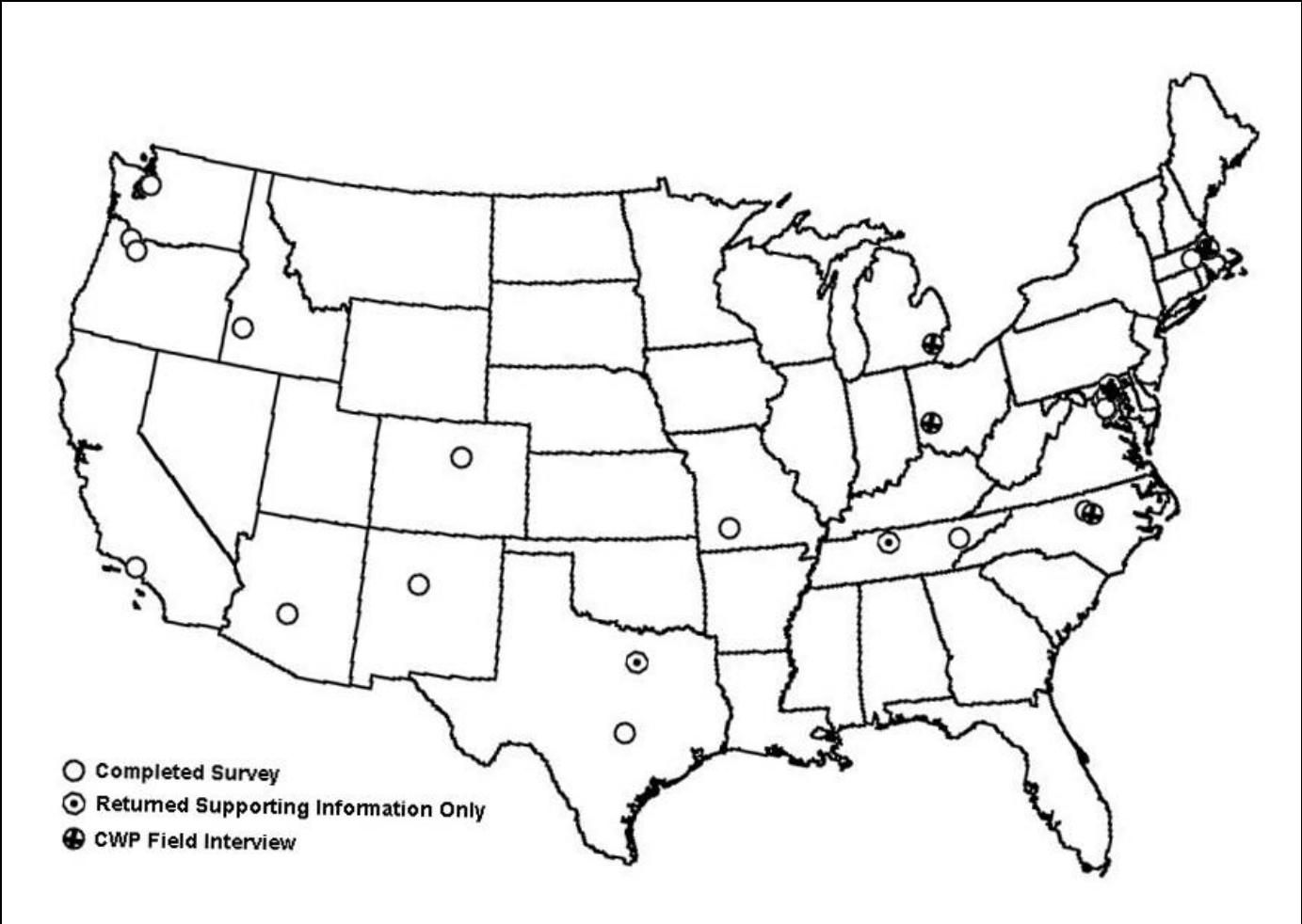


Figure 1: Jurisdictions that Participated in the IDDE Survey

**System Characterization**

To help determine the relative scale of the programs, the survey requested information that would characterize the jurisdictions drainage systems in addition to population density, service area, and land use. Specifically, information on length of storm drain network, number of major outfalls, and the ratio of outfalls to miles of storm drain were compiled (Table 1).

**Table 1:** Characterization of Jurisdictions that Participated in the IDDE Survey

Jurisdiction	Form of Government	NPDES Status	Land Use (%)					Population Density (people/mi <sup>2</sup> )	Service Area (mi <sup>2</sup> )	Total Length of Storm Drainage Network (mi)	# of Major Outfalls	Outfall / Mile of Drainage Network
			Ultra-Urban	Urban	Sub-urban	Rural	Forest/Undev'd					
Ada County Highway District (ACHD), ID	Special Purpose District	Phase I, Phase II	12	23	28	11	26	1,070	69.73	351	65	0.19
Albuquerque, NM	City	Phase I	-	90	-	-	10	2,400	181	582	6	0.01
Alexandria, VA	City	Phase II	100	-	-	-	-	8,000	15.75	N/R	N/R	N/A
Arlington Co., VA	County	Phase I	10	9	47	-	33	7,149	20	400.5	100	0.25
Austin, TX	City	Phase I	1	25	54	20	-	2,745	238	600	250	0.42
Baltimore City, MD	City	Phase I	-	71	-	-	29	7,173	92	726	345	0.48
Boston, MA	City	Phase I	-	85	-	-	15	12,271	48	542	94	0.17
Cambridge, MA	City	Phase II	85	15	-	-	-	15,000	6.25	81	11	0.14
Clackamas Co., OR	County	Phase I	10	15	60	5	10	181	22	N/R	22	N/A
Dayton, OH	City	Phase I	20	50	10	5	15	3,115	52	600	300	0.50
Durham, NC	City	Phase I	4	20	43	5	28	1,950	92	2,690	890	0.33
Falls Church, VA	City	Phase I	10	50	39.5	-	0.5	5,000	2	N/R	N/R	N/A
Howard Co., MD	County	Gen. Permit	15	25	53	6	-	972	255	300	365	1.22
Knoxville, TN	City	Phase I	10	20	55	5	10	1,750	100	324	1,004	3.10
Lakewood, CO	City	Phase I			N/R			3,225	44	N/R	204	N/A
Montgomery Co., MD	County	Phase I	-	30	12	30	28	1,762	496	2,597	7,165	2.76
Phoenix, AZ	City	Phase I	-	30	60	10	-	2,537	473	3,500	322	0.09
Portland, OR	City	Phase I	-	-	-	-	-	3,534	47	562	110	0.20
Raleigh, NC	City	Phase I	5	20	40	10	25	1,800	120	3,200	1400	0.44
Seattle, WA	City	Phase I	100	-	-	-	-	6,706	84	630	200	0.32
Springfield, MO	City	Phase I	5	50	30	-	15	2,000	70	500	6	0.01
Thousand Oaks, CA	City	Phase I	-		33	10	47	2,142	58	N/R	N/R	N/A
Wayne Co., MI	County	Gen. Permit	33	6	41	13	7	175	498	3,265	2,000	0.61
Worcester, MA	City	Phase I			N/R			4,600	37.6	347	250	0.72
<b>Median</b>			<b>10</b>	<b>25</b>	<b>41</b>	<b>10</b>	<b>15</b>	<b>2,600</b>	<b>70</b>	<b>582</b>	<b>250</b>	<b>0.33</b>

Notes: N/A = Not applicable; N/R = Not reported

## Program Characterization

Staff time dedicated to the IDDE programs surveyed ranged from 0.08 to 10 person-years, with a median of 1.5 person-years (Table 2). It was difficult for many of the jurisdictions to quantify actual staff time dedicated to IDDE activities since the responsibilities are spread among many departments, or because the staff who work on IDDE also perform other un-related tasks.

**Table 2:** Staff Time Dedicated to IDDE Program Annually

Jurisdiction	Staff Time (person-years) Dedicated to IDDE Program Annually (n = 21)			Ratio of Field to Total
	Field Staff	Office Staff <sup>1</sup>	Total Staff	
Wayne Co., MI	6	4	10	60%
Baltimore City, MD	6	2.25	8.25	73%
Phoenix, AZ	5	2	7	71%
Knoxville, TN	2	1.5	3.5	57%
BWSC, MA	2	1.25	3.25	62%
Worcester, MA	2	1	3	67%
Durham, NC	2.1	0.5	2.6	81%
ACHD, ID	1	1.5	2.5	40%
Montgomery Co., MD	2	0.5	2.5	80%
Cambridge, MA	1 <sup>2</sup>	0.50	1.50	66%
Albuquerque, NM	Note 3	1.5	1.5	N/A
Austin, TX	1	0.35	1.35	74%
Raleigh, NC	1	0.3	1.3	77%
Thousand Oaks, CA	0.9	0.3	1.2	75%
Springfield, MO	0.5	0.5	1.0	50%
Howard County, MD	N/R	0.6	0.6	N/A
Portland, OR	0.22	0.11	0.33	67%
Clackamas Co., OR	0.1	0.1	0.2	50%
Dayton, OH	0.1	0.05	.15	67%
Arlington Co., VA	0	0.1	0.1	0%
Lakewood, CO	0.04	0.04	0.08	50%
<b>Median</b>	<b>1.0</b>	<b>0.5</b>	<b>1.5</b>	<b>67%</b>

**Notes:**

1. Includes administrative and professional office staff.
2. Additional 1.75 person-years spent by professional consultant performing sampling, inspection work.
3. Field monitoring subcontracted to a consultant.

For similar reasons, it was also difficult for jurisdictions to accurately report the full IDDE program budget, as well as costs associated with different related activities (Table 3). Annual IDDE program expenditure ranged from \$3,500 to \$613,561, with a median of \$121,825.

**Table 3:** Annual IDDE Program Expenditure

Jurisdiction	Staff Total		Office Computer / Software		Field Equipment		Lab Equipment / Testing		Other <sup>1</sup>		Total Annual
	(\$)	(% of total)	(\$)	(% of total)	(\$)	(% of total)	(\$)	(% of total)	(\$)	(% of total)	(\$)
Wayne Co., MI	460,672	75%	3,760	0.6%	319	0.1%	7,500	1%	141,273	23%	613,561
Phoenix, AZ	500,003	84%	-	-	15,665	2.6%	13,840	2%	64,571	11%	593,134
Cambridge, MA	100,200	25%	1,000	0.2%	3,000	0.7%	10,000	2%	297,200	73%	406,400
Baltimore City, MD	298,750	75%	-	-	10,000	2.5%	87,000	22%	-	-	395,750
Albuquerque, NM	110,000	28%	-	-	14,000	3.6%	20,000	5%	250,000	63%	394,000
Worcester, MA	160,000	57%	-	-	-	-	15,000	5%	100,000	36%	280,000
Montgomery Co., MD	200,000	97%	-	-	5,500	2.7%	-	-	-	-	205,500
BWSC, MA <sup>2</sup>	142,000	73%	200	0.1%	1,000	0.5%	500	0%	50,000	26%	193,700
Durham, MA	156,600	89%	2,500	1.4%	3,500	2.0%	8,000	5%	4,600	3%	175,000
ACHD, ID	160,450	100%	-	-	-	-	-	-	-	-	160,450
Thousand Oaks, CA	60,000	72%	-	-	10,000	12.0%	5,000	6%	5,000	6%	83,200
Raleigh, NC	53,000	64%	5,000	6.0%	6,000	7.2%	12,000	14%	7,000	8%	83,000
Springfield, MO	70,000	84%	5,000	6.0%	5,000	6.0%	1,000	1%	2,000	2%	83,000
Austin, TX	67,500	82%	1,000	1.2%	4,000	4.8%	5,000	6%	-	-	82,500
Knoxville, TN	33,000	55%	1,000	1.7%	500	0.8%	15,000	25%	10,000	17%	59,500
Portland, OR	15,000	58%	-	-	-	-	10,000	38%	1,000	4%	26,000
Clackamas Co., OR	16,000	100%	-	-	-	-	-	-	-	-	16,000
Arlington Co., VA	7,000	95%	-	-	50	0.7%	300	4%	-	-	7,350
Lakewood, CO	3,500	57%	300	4.9%	1,600	26.0%	500	8%	250	4%	6,150
Howard Co., MD	3,000	86%	-	-	-	-	500	14%	-	-	3,500
<b>Median</b>	<b>\$85,100</b>	<b>75%</b>	<b>\$1,000</b>	<b>1%</b>	<b>\$4,000</b>	<b>3%</b>	<b>\$8,000</b>	<b>5%</b>	<b>\$10,000</b>	<b>11%</b>	<b>\$121,825</b>

**Notes:**

1. Typical costs included in the "other" category include education, training, travel, consultants, and contractors.
2. The annual budget information provided by BWSC does not include the costs associated with corrections, nor the costs associated with special drainage system studies.

## ***Legal Authority***

Ninety-six percent of the surveyed jurisdictions have some type of regulation that prohibits inappropriate discharges from entering the MS4. Discharge prohibitions typically come under at least one of three regulations:

- 1) A stormwater ordinance that addresses inappropriate discharges to the storm sewer system or receiving waters;
- 2) A plumbing code that addresses illegal connections to the storm sewer system; or
- 3) A health code that regulates the discharge of harmful substances to the storm sewer system or receiving waters.

Most jurisdictions surveyed have the legal authority necessary to inspect private properties for illegal discharges, but based on our interviews, few seem to have found it necessary to invoke that authority. Communities noted that owners are usually cooperative with respect to property inspections by jurisdictions investigating inappropriate discharges, and that achieving compliance is not usually problematic.

## ***Mapping Capabilities***

Over 80% of the jurisdictions surveyed utilize Geographic Information Systems (GIS) to track outfalls and record site data. Despite the convenience and power of the digital maps, many communities still relied on supplemental information provided on paper maps, particularly where information transfer to the GIS was not complete or was unverified. Based on interviews with select jurisdictions, preferences for paper or digital mapping varied. For instance, Baltimore City field crews expressed a preference for paper mapping, which they felt to be easier to interpret than printouts from the digital mapping system. In addition, for areas where sewer mapping either does not exist, they have often turned to historic topographical maps to determine possible pre-development stream locations.

A primary use of mapping in an IDDE program is to prioritize areas for outfall screening or dye testing. In addition, it is useful for tracking areas that have been investigated versus those that still need to be investigated. Table 4 displays the IDDE program mapping elements that surveyed jurisdictions use.

Based on interviews, other key areas that are useful to map include:

- Certain industries by SIC code
- Historic complaints
- Sanitary and storm sewers in close or in common manholes
- “Gaps” in sanitary mapping
- Licensed businesses, SIC codes, industrial permittees
- Areas with businesses with night hours (e.g., bars and restaurants)

**Table 4:** Common IDDE Program Mapping Elements

<b>Elements Mapped by Jurisdictions</b>	<b>% of Jurisdictions Responding (n = 24)</b>
Storm sewers	96%
Waters of the US receiving discharges from outfalls	83%
Outfalls	79%
Open channels (conveyance channels)	71%
Land use	67%
Sanitary sewers	63%
Industrial discharge permit holders	33%
Building connections to storm sewers	25%
Connections to adjacent systems / communities	25%
Building connections to sanitary sewers	21%
Watershed, outfall drainage area boundaries	13%
Hotspot areas	13%

### ***Methods to Identify and Confirm Potential Inappropriate Discharges***

Table 5 displays the procedures utilized by the surveyed jurisdictions to determine the presence of a suspected inappropriate discharge. Most of the jurisdictions used several different methods and there was no apparent trend based on geographical location. The top three procedures selected were: 1) pollution reporting hotline (86%); 2) regular inspection of outfalls by jurisdiction (76%); and 3) water quality monitoring of receiving waters (71%).

Some of the jurisdictions found that the initial outfall screening conducted was very successful at identifying chronic problems, but that the following screening was less useful. For sporadic discharges, jurisdictions are relying more heavily on telephone hotlines and cross-training inspection and maintenance staff than on monitoring or field screening.

**Table 5:** Investigative Procedure(s) Used to Determine the Presence of a Suspected Inappropriate Discharge to a MS4 or Receiving Water

<b>Investigative Procedure</b>	<b>% of Respondents (n = 21)</b>
Pollution reporting hotline for citizens to call	86%
Regular inspection of outfalls by jurisdiction	76%
Water quality monitoring of receiving waters	71%
Regular inspection of storm sewers	62%
Regular inspection of sanitary sewers	48%
Dye- or smoke-testing of buildings in problem areas	48%
Sporadic outfall inspection by watershed/citizen organization	38%
Regular outfall inspection by watershed/citizen organization	24%

Sporadic inspection of outfalls by jurisdiction	24%
Dye- or smoke-testing of buildings at the time of sale	5%
Water quality monitoring of discharge waters	5%
Septic system inspection at time of sale	5%

### Sources of Discharges Typically Found

Common sources of discharge found by jurisdictions responding to the survey are displayed in Table 6. While certain sources are random and may occur anywhere, such as illegal dumping, other sources can often be associated with specific factors within a community or subwatershed. These include:

- Land use (e.g., industrial discharges, restaurant grease, failing septic systems)
- Type and age of sewer system (e.g., pump station failures, inflow/ infiltration, SSOs)
- Historic plumbing codes (e.g., connection of floor drains to storm sewers)
- Recreational facilities (e.g., chlorine from swimming pool discharges, sewage from marina pumpouts)

No significant relationship was apparent relating sources of discharge to geographic location.

**Table 6:** Sources of Inappropriate Discharges Typically Found

Sources of Inappropriate Discharge	% of Respondents (n = 21)
Illegal dumping practices	95%
Broken sanitary sewer line	81%
Cross-connections	71%
Connection of floor drains to storm sewer	62%
Sanitary sewer overflows	52%
Inflow / infiltration	48%
Straight pipe sewer discharge	38%
Failing septic systems	33%
Improper disposal of wastes from recreational vehicles	33%
Pump station failure	14%

### Outfall Monitoring

All but two of the jurisdictions surveyed conduct some sort of outfall monitoring program. Most conduct outfall monitoring on a regular basis, per NPDES Phase I requirements.

Jurisdictions reported that beyond initial outfall screening, continued outfall monitoring was less useful in finding intermittent or one-time discharges. For instance, Wayne County, MI, noted that outfall monitoring is not the most effective method for identifying inappropriate connections due to the potential for dilution, the periodic nature of some discharges, and the time delay between discharge into the system and discharge from the outfall. This is supported by survey results that indicate the periodic nature of discharges is the biggest impediment to identifying inappropriate discharges.

Jurisdictions seem to place a heavy reliance on physical indicators of discharges, as opposed to chemical outfall screening, even in light of a 30% false positive identification rate (Lalor, 1993). The most common approach to outfall screening involves conducting a visual inspection of the outfall and a qualitative



assessment of any flow present, including observation of water color, odor, turbidity, floatables, and sedimentation. In some cases, if the flow is suspected to be inappropriate, a follow-up grab sample is taken for quantitative analysis. Many jurisdictions bypass the quantitative tests and immediately move upstream to find the source of the discharge.

### **In-Stream Monitoring**

Some jurisdictions utilize in-stream monitoring to enhance or supplement outfall monitoring. In-stream monitoring is used to identify trends that may lead toward characterization of inappropriate discharges. The City of Raleigh, NC has conducted baseline monitoring on nine streams for basic parameters, some of which are used to detect sewer leaks including fluoride, fecal coliform, ammonia, sodium, and conductivity. Deviation from the baseline for these parameters observed during regular in-stream monitoring prompts further investigation of possible inappropriate discharges. Baltimore City conducts weekly screening of receiving waters using a hydrolab or equivalent and field test kits for ammonia. When a threshold value is exceeded, sampling continues upstream until the source is located. To address chronic problems, a monthly sampling program is conducted using an extensive variety of laboratory-analyzed chemical parameters at approximately 40 receiving water stations. When long-term medians exceed a certain percentile based on the entire database, investigations are conducted by sampling further upstream in the storm drain network.

### **Citizen Hotlines**

Citizen hotlines are a common method for indicating the presence of a suspected inappropriate discharge. Nineteen (90 %) of the surveyed jurisdictions have pollution reporting hotlines, and 18 of these track the number of complaints that have been received and corrected to help determine IDDE program success. Montgomery County, MD, noted that the success of their IDDE program is directly related to their water quality outreach, complaint, and enforcement system, not to their outfall-screening program. On average, County staff identify and correct about six inappropriate discharges per year as a result of regular screening. By contrast, over 185 inappropriate discharges are corrected each year as a direct result of citizen complaints and calls to the hotline.

Public education and labeling of outfalls and other storm drain infrastructure is an important element of establishing a successful citizen hotline. Boston Water and Sewer Commission (BWSC) has labeled outfalls along the Charles River so that citizens can identify outfalls from the water. Dayton has labeled outfalls along the City's popular riverfront, and recommends labeling catch basins and manhole covers.

### **Tracers and Methods Used**

The majority of surveyed jurisdictions utilize tracers to confirm the presence of a suspected inappropriate discharge (Table 7). Emphasis is on quick and simple tests that do not require extensive and time-consuming laboratory analysis. Qualitative physical parameters are the most widely used tracers, including color, odor, deposits and stains, temperature and presence of floatable matter. When chemical tracers are used, communities tend to focus on a single parameter such as bacteria, ammonia, or detergents so that field and lab equipment costs are controlled. However, using only one parameter as a tracer can leave unanswered questions about other sources of inappropriate discharges. This uncertainty can be reduced somewhat when sampling is conducted in conjunction with land use data analysis. In addition, there are

certain situations where a single source is known to dominate the inappropriate discharges to a watershed and a single tracer is warranted. For example, Baltimore, MD, has chronic sewage infrastructure problems and makes the assumption that sewage is the likely dominant inappropriate discharge in many of its subwatersheds. Consequently, Baltimore often uses ammonia as a sole tracer to track inappropriate discharges.

**Table 7:** Tracer Parameters Used to Confirm the Existence of Inappropriate Discharges

Tracer Parameter	Physical or Chemical	% of Respondents (n = 21)
Color	P	95%
Odor	P	95%
Deposits and stains	P	90%
Floatable matter	P	86%
pH	C <sup>1</sup>	86%
Temperature	P	86%
Chlorine	C	76%
Turbidity	P	76%
Changes in flow	P	62%
Specific conductivity	C	62%
Vegetation change	P	62%
Ammonia / ammonium	C	52%
Structural damage	P	52%
Surfactants	C	48%
Fecal coliform	C	33%
Fluoride	C	33%
Copper	C	29%
Florescence	C	24%
Phenols	C	14%
Potassium	C	14%
Detergents	C	10%
Dissolved oxygen	C	10%
Grease / oil	P	10%
Hardness	C	10%

<sup>1</sup> Some chemical parameters can be measured in the field with probes or test strips. These methods are often not as sensitive as those that would be used in a laboratory analysis.

### ***Inappropriate Discharge Corrections Program***

Some jurisdictions simply bear the cost of inappropriate connection repairs and bill the owners after the repairs have been completed. Ada County, ID and Raleigh, NC use this method as a last resort to gain compliance. Worcester, MA pays half of repair costs and bills the owner for the remainder.

Most jurisdictions reported that diplomacy, trust, reasoning and education are the primary people skills required to successfully perform their jobs effectively. Diplomacy and trust are important when trying to gain access to private property for plumbing inspections and dye testing. Reasoning and education are necessary when explaining to property owners that a problem exists on their property when trying to get the owners to make required connections. The bottom line is that different tactics and approaches work to gain compliance from different people. Wayne County, MI mentioned that the publicity surrounding the Rouge River Project helped open doors for them, because property owners had heard enough about programs to clean the river prior to having IDDE inspectors knock on their doors.

## ***Education, Outreach, and Pollution Prevention Programs***

Nineteen of the IDDE programs surveyed include some type of education and outreach elements. Of these, all target residents, 75% target the commercial sector, 63% target the industrial sector, and 50% target the government sector. In some cases, educational messages relating to inappropriate discharges are incorporated into campaigns developed for other departments or programs within the jurisdiction. Other jurisdictions run very targeted IDDE education programs.

### **Resident Education**

For jurisdictions that rely heavily on citizen hotlines as a means of identifying potential inappropriate discharges, residential education is an important program component. Some common forms of residential education identified through the surveys include storm drain stenciling or marking; signage at outfalls; educational brochures or newsletters in utility bills; and promotion of citizen hotlines.

### **Schoolchildren Education**

Some communities such as Dayton, OH and Phoenix, AZ have educational programs geared towards schoolchildren. Dayton's inappropriate discharges education is part of a larger schoolchildren educational effort that includes regular visits to schools and the "Children's Water Festival." This one-day event for 3,000 students from the 4th-6th grade levels offers a series of presentations, games, experiments, and exhibits on groundwater, surface water, conservation, land use, and other water related topics. Phoenix noted that the school presentations made to third and fourth graders are an effective part of their stormwater program. City stormwater inspectors give presentations to the children and distribute Storm Drain Dan coloring books, pencils, erasers, rulers (all bearing the City's stormwater logo and phone number) and Storm Drain Dan dolls. They have found this to be particularly helpful in lower income neighborhoods where school supplies are in high demand. The children are reported to be enthusiastic and motivated to keep the environment clean.

### **Commercial and Industrial Education**

In most cases, jurisdictions have developed targeted commercial or industrial education programs based on specific local problems, land uses, or "hot spot" activities likely to contribute specific types of problems. For example, several jurisdictions have developed educational programs regarding grease handling and disposal at restaurants. Clackamas County, OR has developed educational brochures for contractors regarding concrete and mortar management. Both land use mapping and a historical record of problems and complaints help jurisdictions to identify areas to focus on in these types of educational campaigns, which tend to be accomplished through one-on-one contact as opposed to mass distribution of educational materials used for residential education.

## **Public Employee Education**

Several jurisdictions identified cross training of public employees as an important means of identifying potential inappropriate discharges. For example, Wayne County, MI currently trains field crews of the Division of Public Works, County Drains, and Recreation and Parks on inappropriate discharge detection to increase both awareness and the number of “eyes” looking for problems. Effective training typically includes presentations, videos, and problem-solving activities.

## **Conclusions**

Several conclusions were developed from the surveys and interviews regarding IDDE program development. Typically, 67% of program staff time is dedicated field staff. As program staffing increased, this ratio stayed fairly consistent. Also, several program directors noted that experienced field staff are a valuable asset, while several others noted that the lack of staff expertise and experience is a top problem in identifying inappropriate discharges. Accurate mapping resources can improve the efficiency of a program in the identification of outfalls and prioritization of problem areas. The wide range of program budgets can be attributed to the methods used by the programs to identify potential inappropriate discharges. The five programs with the highest annual expenditures dedicate significant portions of their budgets to support intensive outfall screening, continuous in-stream monitoring, and targeted area investigations. Their budgets support larger field staffs or consultants who conduct these investigations; the purchase of more sophisticated lab and field equipment; and targeted educational programs. IDDE programs have invoked legal authority using one or more of three mechanisms: 1) a stormwater ordinance that prohibits illicit discharges to the drainage network; 2) a plumbing code that prohibits illegal connections to the drainage network; or 3) a health code that regulates the discharge of harmful substances to the drainage network.

Drawing from these conclusions, there are several program development challenges that will likely be faced by NPDES Phase II communities and potential ways to alleviate them. The range of responses with regard to program characterization questions indicates a defined need for relatively simple guidance for performing inappropriate discharge investigations. The guidance should provide programmatic recommendations as well as recommendations for field methods and anticipated costs. A lack of staffing resources may prove to be a significant hindrance to implementing a successful IDDE program. Phase I communities rely heavily on the expertise of their field staff – expertise that has been largely developed as the programs were being developed. Methods or approaches recommended for Phase II communities should be less dependent on professional judgment. Many communities do not have current mapping. Focus should be placed on mapping storm sewers, open drainage channels, waters of the US, outfalls, and land use. This will provide field staff the minimum data necessary to conduct field investigations, and will serve as a basis for prioritizing field investigations.

Outfall screening can require significant staff and equipment resources. An efficient approach that examines a limited number of parameters at each outfall is necessary. In addition, more effective and reliable tracers and associated analytical techniques are needed to reduce the uncertainty (i.e., number of false negatives and false positives). When examining equipment needs, Phase II programs should communicate with other jurisdictional programs that utilize the same types of field equipment and examine the possibility of sharing

purchase expenses. Model ordinance language should be provided to Phase II communities to ensure that all potential sources of inappropriate discharges are prohibited; and that the community is provided with the necessary legal authority to inspect private properties and to enforce corrections. Effective IDDE programs need to have a balanced approach involving field screening, hotspot targeting, hotlines, public education, and municipal employee cross-training.

## **Acknowledgements**

The authors would like to express our sincere appreciation to the communities and individuals that took the time to complete the survey. Without the detailed feedback that we received, it would not be possible to generate the necessary conclusions about the current state of the practice or develop a clear understanding about the areas where uniform guidance is needed. In addition, several of the project team members were instrumental in developing and compiling the survey, including: Deb Caraco, Stephanie Linebaugh, Dan O’Leary and Tom Schueler of the Center for Watershed Protection and Dr. Bob Pitt of the University of Alabama. Lastly, Mr. Bryan Rittenhouse of USEPA Office of Water has provided valuable project support as project officer.

## **References**

- Glanton, T., M. Garret and B. Goloby. 1992. The Illicit Connection: EPA Storm Water Regulations Field Screening Program and the City of Houston’s Successful Screening System. *Water Environment and Technology* (September 1992): 60-68.
- Lalor, M. 1993. Assessment of Non-Stormwater Discharges to Storm Drainage Systems in Residential and Commercial Land Use Areas. Ph.D. thesis. Department of Environmental and Water Resources Engineering. Vanderbilt University. Nashville, TN.
- US EPA. 1996. Overview of the Storm Water Program (EPA833-R-96-008). US EPA Office of Water. Washington, DC. June 1996.

# USE OF THE CLEAN WATER STATE REVOLVING FUND FOR MUNICIPAL STORM WATER MANAGEMENT PROGRAMS

Amy Butler and Jim Collins  
Tetra Tech, Inc.  
Fairfax, Va

Sandra Perrin  
U.S. EPA  
Washington, DC

## The Need for Funding

Many municipalities have funded traditional storm water management activities through their general revenue sources. Traditionally, storm water management was thought of as minimizing street flooding and reducing property damage caused by peak runoff flows. Controlling the water quality aspects of urban runoff is a much more recent addition to the perceived municipal storm water management responsibility. With few exceptions, incorporating water *quality* controls in tandem with the traditional *quantity* management has occurred through the regulatory process. Therefore, municipalities typically consider the quality component of storm water management to be a new and separate mandate. Some municipalities recognized the link between storm water quantity and quality and took the initiative to establish comprehensive storm water management programs to address both issues. More often than not, however, municipalities began managing storm water quality and quantity together in response to regulations implementing the National Pollutant Discharge Elimination System (NPDES) permit program for storm water.

Subsequent to the 1987 amendments to the Clean Water Act (CWA), EPA published regulations establishing Phase I of the NPDES Storm Water Program in 1990. Under Phase I, EPA required NPDES permit coverage for discharges of storm water associated with industrial activity, discharges of storm water from construction sites greater than 5 acres in size, and storm water discharges from medium and large municipal separate storm sewer systems (MS4s) located in incorporated places or counties that serve populations of 100,000 or more. The Phase II Final Rule, also a result of the 1987 CWA Amendments, was published in the *Federal Register* on December 8, 1999. The Phase II rule requires NPDES permit coverage for storm water discharges from construction sites that disturb between 1 and 5 acres and from small MS4s, defined as those systems serving areas populations less than 100,000 to a lower limit based on the U.S. Census Bureau's definition of an urbanized area.

## Costs of Municipal Storm Water Management Programs

Every four years, EPA conducts an assessment of the water quality and human health protection financial needs for wastewater collection and treatment systems, storm water management programs, and nonpoint source projects. This effort is the Clean Watersheds Needs Survey (CWNS), which is a joint effort between states and EPA. During the Construction Grants Program the CWNS only included project-specific costs

for traditional wastewater collection and treatment system needs. Over the last 10 years, however, the survey has expanded to include nonpoint source, estuary management, and storm water management projects. The storm water management projects typically included in the CWNS are the capital costs of developing and implementing municipal storm water management programs under the NPDES. Very few Phase I MS4s had provided sufficiently detailed planning information to serve as project-specific documentation for their needs in the last two surveys, thus the assessment of storm water management program costs and needs relied primarily on modeling. The modeling approach used in the 1996 CWNS for estimating Phase I MS4 needs assumed the use of regionally-targeted best management practices (BMPs) for the major program areas based on hydrologic regions and variation in soil characteristics. Beginning with the 2000 Clean Watersheds Needs Survey (CWNS 2000), several states made significant progress in obtaining documentation for eligible storm water management program (SWMP) elements from the operation of MS4s.

EPA was not required to conduct an analysis of the estimated cost expected to be incurred by municipalities when developing their SWMPs and otherwise implementing the 1990 Storm Water Phase I regulations. The 1996 CWNS estimate for municipal storm water management program elements (i.e., facilities) was \$7.4 billion, but this value was recognized as an underestimation. Table 1.1 provides a list of cost estimates that were identified in the Phase I storm water modeling for the 1996 CWNS. These costs largely represent one-time costs such as the cost to develop ordinances or the cost for initial training of municipal staff. Because such expenditures are generally discrete and predictable, as are structural BMPs, they are examples of items ideally suited to being included in the CWNS.

**Table 1.1.** Cost Estimates used in the Phase I storm water modeling for the 1996 CWNS.

<b>Institutional Source Controls</b>	<b>Costs</b>
Site Plan Review	\$10,000 per municipality for initial training
Inspection and Enforcement of Sediment and Erosion Control Plans at Construction Sites	\$10,000 per municipality for initial training
Proper Storage, Use and Disposal of Fertilizers, Pesticides, and Herbicides	\$10,000 per municipality for initial training
Used Oil Collection and Recycling Program	\$30,000 per municipality for an ordinance and development of regulations
Solid Waste Management/Litter Control Ordinance	\$15,000 per municipality to pass an ordinance
Pet Waste Removal/'Pooper Scooper' Ordinance	\$15,000 per municipality to pass an ordinance
<b>Non structural Source Controls</b>	<b>Costs</b>
Enhanced Litter Control	Cost to place additional trash receptacles - \$100.00 each (must be multiplied by the number of acres served by enhanced litter control)

Source: USEPA, 1997

EPA estimated costs to Phase II municipalities to be between \$848 million and \$981 million. The costs to MS4s are based on an annual per household cost of compliance. The individual household cost was

calculated based on two different approaches. First, EPA used a survey of Phase II storm water program costs developed by the National Association of Flood and Stormwater Management Agencies (NAFSMA). The NAFSMA Phase II Survey was sent to more than 1,500 communities potentially impacted by Phase II, with 121 communities responding. The communities were asked to report actual costs to implement any of the six minimum control measures (or equivalent) that they are currently implementing. Not all communities responded to each measure, and public involvement costs were not included (however, EPA believed that cities included public involvement costs with public education costs). Table 1.2 presents the average and percentile costs for five Phase II minimum control measures as estimated by the NAFSMA survey (USEPA, 1999).

**Table 1.2.** Average and Percentile Costs for Five Phase II Minimum Control Measures (Per Household Costs, 1998 Dollars)

	<b>Public Education/ Outreach</b>	<b>Illicit Discharges</b>	<b>Erosion/ Sediment Control</b>	<b>Development</b>	<b>Municipal Runoff<sup>1</sup></b>	<b>Totals: All Categories</b>
Mean Cost	\$0.91	\$1.78	\$1.84	\$2.64	\$1.75	\$8.93
Minimum	\$0	\$0.03	\$0.09	\$0.07	\$0.01	\$0.19
25%	\$0.08	\$0.20	\$0.30	\$0.37	\$0.14	\$1.09
50%	\$0.37	\$0.75	\$1.08	\$1.24	\$0.52	\$3.96
75%	\$1.01	\$2.65	\$2.10	\$2.79	\$1.63	\$10.17
95%	\$3.04	\$5.61	\$7.92	\$10.68	\$9.08	\$36.34
Maximum	\$5.97	\$5.95	\$13.10	\$17.47	\$12.19	\$54.68

Source: USEPA, 1999

<sup>1</sup> A single outlier was removed because it was 15 times the mean cost for all municipalities.

The NAFSMA survey found an average annual household cost for Phase II of \$9.16 (the table above lists \$8.93, and the difference is due to the addition of administrative costs of the program, including recordkeeping and reporting requirements of the rule).

EPA also looked at an alternative approach for estimating Phase II costs. Thirty-five Phase I MS4s were evaluated, with 26 providing adequate cost data. Smaller Phase I MS4s were selected in order to be comparable to Phase II communities. The average annual household costs to implement a program similar to the six minimum measures for these Phase I municipalities was \$9.08.

With the continual expansion of water quality protection initiatives in storm water management, municipalities are constantly faced with finding new and creative methods of funding projects. Additionally, as more Phase II communities develop their storm water management programs, traditional sources of funding will be less available, leaving storm water program managers with the need to find alternative ways to fund multiple projects.



## **Sources of Funding**

Municipalities, counties, states, and private citizens have relied on a variety of sources of funding for storm water management projects. Largely, these have included storm water utilities, tax revenue, grants, loans, and fees. The Clean Water State Revolving Fund (CWSRF) program is one that is traditionally underutilized for funding storm water management programs. The CWSRF program was established in the 1987 amendments to the CWA under title VI. In these amendments, Congress instructed EPA to replace the Federal Construction Grant Program with the CWSRF program. Since its inception over ten years ago, all fifty states and Puerto Rico use the CWSRF Program. Using a formula determined by Congress in the 1987 CWA amendments, EPA grants each state an allotment of funds; the states then match up to 20 percent of the federal grant to set up their CWSRF program. The program acts as a revolving fund to provide independent and permanent sources of low interest loans for all types of water pollution control activities. It is a unique system that relies on the continuous awarding and repaying of the loans to provide a permanent funding source for water quality protection projects (USEPA, 2001). Communities, non-profit organizations, municipalities, counties, individuals, and citizens are all eligible to apply for CWSRF loans. To date, it has awarded more than \$34.3 billion, using more than 10,900 low interest loans (USEPA, 2002a).

Congress designed the CWSRF program to give each state the utmost flexibility in providing financial assistance. States can choose the types of assistance programs (e.g., loans, refinancing, purchasing, or guaranteeing local debt and purchasing bond insurance) and set the loan terms, interest rates, and repayment methods (EPA, 2002b). In addition to giving each state the authority to determine how to distribute funds, Congress awarded states complete flexibility in determining the types of projects eligible for funding. Over the years CWSRF monies have funded nonpoint source projects, wetland and estuary protection, storm water management programs, and traditional wastewater collection and treatment system projects. (USEPA, 2001).

Nationally, the CWSRF loan average interest is 2.4 percent (individual state loan interests vary), with repayment terms up to 20 years. Projects using CWSRF loans at this interest rate are funded using 23 percent less money than projects using the current market rate (USEPA, 2002a). CWSRF loans can be used to partially or wholly fund a project. To apply for a CWSRF loan, a public or private entity submits an application with the state-required information about the project. Most applications require a description of the problem and information about how the project will be implemented (e.g., specifics on the water quality and public health benefits, usually expressed in dollars per unit, the start and completion dates, as well as the cost disbursement plan). States use the application forms to rank the projects and create a list of priority projects that are eligible for CWSRF loans. These lists typically are called the project priority lists (PPL) or intended use plans (IUP). A state will fund the projects on the PPL or IUP as money is available. Depending on a state's program, projects that are not funded in one year might be transferred to the next year.

## **Typical Storm Water Management Projects Funded with CWSRF**

Restrictions on the types of projects eligible for CWSRF money are determined by the state, however, as a general rule, projects should have a water quality or public health benefit. CWSRF loans can be used for funding the capital costs for developing and implementing municipal storm water programs as required by

an NPDES permit. This can include the costs for design, construction, and implementation of erosion and sediment control and storm water BMPs and development of a storm water management program; operation and maintenance costs are not funded by the CWSRF.

Since the expansion of the CWSRF program to include storm water and NPS projects, the number of projects funded with CWSRF loans has expanded. The increase was not apparent in the 1996 CWNS because needs for SWMP were mostly derived from modeling; however, the CWNS 2000 reported the increase because better data were available. Despite the increase, the number of loans for storm water management is still considerably less than the number of traditional wastewater collection and treatment loans. For example, the CWNS 2000 reports 20 states with municipal storm water management program needs, where as all 48 participating states had wastewater collection and treatment system needs. The projects that are submitted to the CWNS 2000 must be CWSRF eligible; the projects do not require funding by CWSRF. Only 5 states appeared to have used CWSRF loans to meet their storm water management program costs: Maryland, Florida, New Jersey, Colorado, and Nebraska. (USEPA, 2002c). The CWNS 2000 has strict data requirements that can prohibit some storm water management projects from being classified as storm water management needs. Projects that have a storm water management component that are not associated with an MS4 permit program are categorized as a nonpoint source (NPS) project in the CWNS 2000. Twenty-three states submitted needs for NPS projects; of these 23 states only 8 states (New York, New Jersey, North Dakota, Florida, Connecticut, Colorado, Wisconsin, and Maryland) appeared to have used CWSRF loans to meet their storm water management costs (USEPA, 2002c).

Below are examples of storm water management projects in the State of Maryland that were funded using CWSRF loans.

### ***Baltimore County, Maryland***

In 2000 Baltimore County developed a watershed management plan to identify storm water pollutants and storm water management retrofits for the three watersheds as part of their NPDES permit. The plan identified storm water management retrofits for 9 areas. The projects were designed to help control unmanaged storm water runoff in a fully developed watershed and to improve water quality. The County submitted a CWSRF loan application to the state for assistance with financing these projects. The CWSRF loan applications called for developing feasibility analyses, enhancing existing storm water facilities, designing extended detention ponds with shallow marshes, restoring stream channels, enhancing aquatic and riparian habitats, and retrofitting storm drain outfalls. Baltimore County applied for loans to cover approximately two-thirds of the engineering and construction costs; the county would pay the remaining one-third (USEPA, 2002d).

### ***Howard County, Maryland***

In 1999 Howard County conducted an assessment of all the publicly owned storm water management facilities in the Patapsco River Watershed. The County's NPDES permit required the County to determine the viability of its storm water management facilities. The study identified and ranked the facilities that were candidates for retrofitting. The county used the results of the study to apply for CWSRF loan

assistance with the retrofits. Six individual projects were identified and submitted as separate loan applications. Each project requested funds for reconstructing of sediment ponds, redesigning ponds to include shallow marshes and extended detention ponds, retrofitting ponds to include water quality management in addition to quantity control, removing concrete channels, adding forebays, implementing stream restoration projects, and planting riparian and aquatic vegetation. As with Baltimore County, the requested CWSRF loans covered approximately two-thirds of the engineering and construction costs; the county and other stakeholders (e.g., homeowners associations) covered the remaining one-third (USEPA, 2002d).

Below are several examples of storm water management projects that could have been funded partially or wholly using CWSRF loans.

### ***Suffolk County, New York***

In Suffolk County, New York, several projects were developed to prevent and contain road runoff from entering Long Island Sound. The county applied for 12 grants to construct several recharge basins and sediment traps to receive highway runoff and remove pollutants. The basins were designed to contain the 10-year design storm and the sediment traps were designed to intercept the first flush of runoff. For each grant, the county matched the amount of the state funds requested. In this case, if grant money was not available or if the county could not match the grant fund, the county could have applied to the state CWSRF program for a loan (USEPA, 2002d).

### ***Malabar, Florida***

The Town of Malabar is a Phase II community that is approximately 20 percent developed. Its storm water management system consists of swales and ditches, storm water pipes, baffle boxes, drain gutters, and outfall structures. In low lying areas the town experiences flooding of ditches, clogged drains, eroding stream channels, and discharges of pollutants into the Indian River Lagoon. Storm water management needs for this town include development and implementation of a Master Plan, construction of swales along streets, retrofitting of outfall structures, and addition of outfall structures. Although the town has developed a storm water utility fund, because the storm water system needs major upgrades, more funding will be needed beyond what the utility can provide. In this case, the town can apply for loans for both planning and engineering costs necessary to begin construction, in addition to the actual construction costs. The town has approximately 2,500 people, which allows the town to qualify for CWSRF benefits associated with a small community (USEPA, 2002d). For small communities, the state sets aside 15 percent of all the CWSRF loan funds (FLDEP, 2002).

### ***Guadalupe, Arizona***

The town of Guadalupe, in Maricopa County, will be constructing several retention basins along a canal and an outfall system to control storm water runoff. The canal has a history of ponding and flooding the nearby homes. The storm water collection system upgrades will contain the storm water runoff, prevent flooding, and remove pollutants. This is a good example of combining traditional flood control designs with

water quality protection techniques in the arid west. Maricopa County will be funding this initiative using tax money because the town of Guadalupe is not able to contribute financially. The CWSRF program could have been a viable alternative because the town of Guadalupe could have applied for loans directly (USEPA, 2002d).

## ***Missouri***

Across the State of Missouri there are several urban NPS projects that involved storm water management to prevent erosion and flooding. Examples of projects to be completed included, installation of rip-rap and/or grouted rock, retaining walls, culverts, natural bank stabilization, berms, gabions, detention ponds, inlets, and new storm sewers. The projects were submitted to the CWNS as needs for a particular sewershed. These types of projects are all candidates for CWSRF loans for NPS pollution control. If the projects could be directly linked to an MS4 storm water management program, then the CWSRF loans would fall under the storm water management category (USEPA, 2002d).

## **Conclusion**

Despite the fact that the CWSRF program has been available to fund storm water management programs at the local level for more than ten years, it is still a highly underutilized source of funding for this pollution source in most states. As storm water programs continue to evolve and communities, municipalities, and states begin to focus on the water quality benefits of storm water BMPs, finding creative financing mechanisms will become even more of a challenge. Using the CWSRF to fund part if not all of a project has already been demonstrated to be a practical mechanism for investing in elements of Phase I SWMPs. Phase I municipalities should continue to use the CWSRF loans as a viable source of funds as retrofits and upgrades are required. Consideration of using this funding source more widely should be strongly encouraged for Phase II municipalities. Additionally, communities that cannot show a link between a specific storm water management project and their MS4 storm water management program, should also consider the potential of CWSRF funding by describing their project as an NPS pollution control project.

Interested municipalities should investigate their state's PPL or IUPs for information about projects that are most important in their state. These lists can serve as an example of the types of projects that the state approves for CWSRF loans. It appears that in some instances, states are failing to adequately get the word out about the availability of the revolving loan funds for storm water projects. However, in other states, the impediments to using this funding sources for storm water projects is due more to competition from projects that address other water pollution sources, which are in many cases traditional wastewater collection and treatment systems.

## **References**

Florida Department of Environmental Protection (FLDEP). 2002. Florida Department of Environmental Protection, Water Facilities Funding. Last updated 02/20/02. URL: <http://www.dep.state.fl.us/water/wff/faq.htm>

USEPA. 1999. Economic Analysis of the Final Phase II Storm Water Rule. U.S. Environmental Protection Agency, Washington, D.C.

USEPA. 2001. Financing America's Clean Water Since 1987, A report of Progress and Innovation. EPA-832-R-00-011. U.S. Environmental Protection Agency, Office of Water, Washington, D.C.

USEPA. 2002a. Clean Water State Revolving Fund. Last updated on Tuesday, July 9<sup>th</sup>, 2002. URL: <http://www.epa.gov/OWM/cwfinance/cwsrf/index.htm>

USEPA. 2002b. Clean Water State Revolving Fund, How the Program Works, Last updated on Wednesday, July 10<sup>th</sup>, 2002. URL: <http://www.epa.gov/OWM/cwfinance/cwsrf/basics.htm>

USEPA. 2002c. Draft Clean Watersheds Needs Survey 2000, Report to Congress. U.S. Environmental Protection Agency, Washington, D.C. Unpublished report.

USEPA. 2002d. Supplemental Information Submitted in Conjunction with the CWNS 2000. U.S. Environmental Protection Agency, Washington, D.C. Unpublished data.

# **PLANNING AND ASSESSMENT OF BEST MANAGEMENT PRACTICES IN THE ROUGE RIVER WATERSHED**

Kelly A. Cave, Director, Division of Watershed Management  
Wayne County Department of Environment  
Detroit, Michigan

Carl R. Johnson, Senior Vice President  
Camp Dresser & McKee  
Detroit, Michigan

## **ABSTRACT**

The Rouge River National Wet Weather Demonstration Project in Wayne County, Michigan, has developed an approach to linking the performance of best management practices (BMPs) to receiving water impacts. The approach considers the various stages of the entire BMP process, including design, implementation, and a system of performance measurements at each stage.

## **INTRODUCTION**

In the management of watersheds, measuring progress is an untamed frontier of professional practice. Watersheds present us with situations that defy accurate measurement. Consider the following contrasts between measurements for point source controls versus measurements for watershed management.

- While pollution controls for point sources typically involve large engineered facilities that can be equipped with sophisticated systems for measuring the quality of influent and effluent, watershed management entails numerous and geographically scattered projects making it more difficult to measure influent and effluent cost-effectively.
- While point source controls provide accountability to one single unit of governmental or business organization, watershed management often depends on the individual actions of tens or hundreds of organizations, each working with an individual set of priorities and budget limitations.
- While point source controls involve one particular technology, such as secondary treatment, or a bundled set of technologies, such as storage and treatment, watershed management may involve a detention basin in one area, a wetland with nutrient uptake in another, a street sweeping effort in yet another area. Each technology has its own set of measurement requirements and differing hydrologic factors.
- While point source controls typically are implemented with the ability to enforce compliance, watershed management involves numerous efforts for water quality protection that often are beyond the bounds of regulation, and therefore rely on voluntary efforts. Voluntary efforts by local units of government must compete with mandatory efforts for budgetary resources, and this makes it more difficult to achieve standard design criteria.

It is against this backdrop that the Rouge River National Wet Weather Demonstration Project (Rouge Project) sets out to link the performance of best management practices (BMPs) for wet weather pollution control to improvements in water quality in the Rouge River watershed. While there is abundant information on the technical performance of many BMPs in controlled settings for scientific or engineering performance analysis, there is much less information on the performance of BMPs in real urban watershed applications. The Rouge Project is filling this information gap by constructing and measuring the cumulative performance of BMPs in complex urban watershed settings.

In the context of this paper, the term “best management practices, or BMPs” is used as a generic term to mean any technology – either structural or non-structural – for the control of flows or pollutants that adversely impact a receiving stream. This paper examines the array of mechanisms that the Rouge Project has created to link and measure the performance of BMPs to water quality and ecosystem health improvements. The array of mechanisms considers all of the complex factors in watershed management which complicate the measurement process – dispersed geographic distribution of BMPs, multiple project owners, a wide variety of pollution control technologies, and the voluntary nature of many activities. The linking mechanisms used in the Rouge Project take into account the whole process of BMP development, from setting design criteria, to project implementation and post-construction monitoring, and watershed-wide assessments of progress.

## **PROJECT BACKGROUND**

The Rouge Project, initiated in 1992 by the Wayne County, Michigan Department of Environment, has learned a great deal on what it takes to restore an urban waterway to its beneficial uses. The project is partially funded by Congressional appropriations managed by the U.S. Environmental Protection Agency (EPA). As an indicator of the project’s success, continuous grants have been awarded to Wayne County each year since 1993. Some of the project funding is spent on watershed-wide activities such as sampling and monitoring, but the majority of the funding is passed to local communities and nonprofit groups for watershed management activities such as design and construction of pollution controls.

The Rouge River Watershed is largely urbanized, spans approximately 438 square miles, and is home to over 1.4 million people in 48 communities and 3 counties. The Rouge Project initially concentrated efforts on the control of combined sewer overflows (CSOs). The early objective of the project singled out the control of CSOs as a means to improve water quality in the river. However, as the project unfolded, the monitoring showed that other sources of pollution needed to be controlled before full restoration of the river would be achieved throughout the watershed. In fact, the data showed that even if all of the CSO discharges were totally eliminated, the waters still would not meet water quality standards. Based upon what was learned, the Rouge Project has taken a wide-angle lens view of pollution sources. The project now has a holistic approach to consider the impacts from all sources of pollution and use impairments of receiving waters. The project is therefore proceeding on parallel paths, controlling CSOs, while pursuing the watershed approach to address storm water management, flow management, non point sources, failing on-site sewage disposal systems, habitat and riparian restoration, and the development of new recreational opportunities.

One of the primary goals of the Rouge Project is to guide state and federal regulatory policy in wet weather pollution control. The chief way that the project guides policy is by demonstrating the implementation of BMPs for an urban river system, and by demonstrating workable governmental processes that support the implementation of watershed restoration. Critical to both the technology design and to the processes of

government is the ability to measure individual BMP performance and to measure the cumulative beneficial impacts of all efforts in the watershed.

The Rouge Project distinguishes itself among other watershed efforts by not relying on a single point of institutional accountability. The federal, state, county, and municipal units of government are in agreement that watershed management is the ultimate responsibility of each local municipality. The municipalities collaborate with each other, and they have formed alliances in seven subwatershed groups that range in size from about 20 square miles to over 80 square miles. The municipalities also support watershed-wide activities for monitoring, geographic information systems (GIS), technical information sharing, public involvement and grant administration. The Rouge Project has included a large number of voluntary activities, particularly in the arena of storm water management, where mandatory federal regulations will not take effect until 2002, and state policy has been through a voluntary General Permit since 1997.

## **THE SERIES OF STAGES**

The Rouge Project uses a series of stages to link BMP performance to receiving water impacts. The project has found that it is necessary to proactively build the links so that useful measurements and conclusions can be obtained.

There are five stages that span the BMP process:

- Design criteria for BMPs,
- Assessment of water quality needs by subwatershed,
- Promotion of the implementation of the most effective BMPs in each subwatershed,
- Standard protocols for receiving water quality measurements, and
- Watershed wide monitoring program and data assessment.

Each of the stages has three principal components:

- A technical basis developed from engineering analysis;
- A basis of authority, which typically is a process of government, such as an ordinance, adaptation of existing regulation, new regulation, or as simple as a peer-supported voluntary guideline; and
- A physical measurement of the effectiveness of the stage, such as a performance monitoring program, a watershed monitoring program, or other type of assessment.

All three components are necessary. The technical basis provides the functional fit of the BMP into the engineered watershed ecosystem. An authority is needed to provide a reason and motivation for the BMP to be implemented in the context of other public needs – education, safety, transportation, etc. The measurement component is the way to test the success of implementation and assess the need for further action.

The concept of looking at the entire BMP process is important, because of: 1) the relatively long time span for BMP implementation; 2) the complexities of multiple parties responsible for implementation; and 3) the evolving learning curve of watershed management technologies.



The concept of a subwatershed is also important in the establishment of links between BMP performance and receiving water impacts. Subwatersheds allow us to tackle the larger problems of a watershed in a series of smaller bites. For example, a subwatershed that is a headwater area allows the suite of BMP solutions to focus on headwater protection, which may not require dealing with the complications of CSO controls typical in downstream areas of the Rouge watershed. The subwatershed provides a smaller geographic area, a smaller range of technical solutions, a smaller list of objectives, and a small group of stakeholders – overall, a more manageable problem to tackle. The delineation of subwatersheds may therefore be an important step in the BMP process. A discussion of the locally controlled subwatershed delineation process in the Rouge River watershed is given by Cave, et al., 1998.

## **DESIGN CRITERIA FOR BMPS**

The first link between BMP performance and receiving water quality improvement comes at the beginning of the staged BMP process – that being the design criteria of the project.

### ***Technical Basis***

The Rouge Project has developed design criteria, or facilitated the development thereof, for a number of efforts to standardize design criteria for BMPS. Examples include:

- Development of a guide for planning and estimating costs for BMPS that is tailored to metropolitan Detroit applications. This guide presents a “public works director” view of design criteria and cost estimates for 23 categories of BMPS. Figure 1 shows an example entry from this guide. (Ferguson, et al., 2001)
- New design standards for storm water management in Wayne County which establish peak discharge rates, restrict activities in flood plains, and set forth provisions for operation and maintenance of storm water facilities. (WCDOE, 2000)
- Development of design criteria for demonstration size CSO storage and treatment basins. These criteria established a “demonstration” basin size to capture 0.17 inches of runoff compared to the state regulatory agency presumptive size of 0.35 inches of runoff. (Alsaigh, 1994)
- Water quality models for evaluation of river impacts. These tools are primarily used in work with the state regulatory agency (MDEQ) for CSO basin sizing and with performance evaluation of the basins and storm water detention pond operation. The water quality models utilize the US EPA SWMM and WASP models, and are configured for both dynamic and steady state simulations.

Wayne County has invested in a program of technology transfer to disseminate the design criteria that the Rouge Project develops. The technology transfer program includes an educationally acclaimed website ([www.rougeriver.com](http://www.rougeriver.com)), training programs and publications that are for audiences in the Rouge watershed and in other watersheds. The Rouge Project also offers a technical extension service for communities in the Rouge River watershed.

Type:	Non-Structural, Urban Source Control BMP.
Description:	Periodic inspection of on-site sewage disposal systems (OSDS) and regular pumping of septic tanks will prevent, detect and control spills, leaks, overflow and seepage from on-site sewage disposal systems.
Function:	Prevents premature failure of on-site sewage disposal systems and detects problems that will minimize pollution.
Application:	Maintenance practice.
Site Requirements:	Availability of a plan showing the location of the on-site sewage disposal systems.
Effectiveness:	Pumping of septic tanks on a regular basis and inspection of the on-site sewage disposal system can prevent premature failure and detect problems so that repairs can be less costly. An inspection of the on-site sewage disposal system is recommended every 5 years. Health Departments recommend a 3-year cleaning cycle for septic tanks.
Who Does It?	Can be done by municipal staff or by county health agency.
Design Requirements:	Risers on septic tanks make location, inspection and pumping easier. Pumping must be done by a Licensed Septage Waste Servicer. A Registered Sanitarian should perform inspections or a person certified as a septic system evaluator by the local health department or NSF International.
Basis for Cost:	Cost of regular inspections of on-site sewage disposal systems. Assumes 20 percent of a community's septic tanks are inspected each year so that a five-year cycle is maintained. Time for inspection usually takes 1 to 3 hours, but can take much longer if the location is not well defined. Cost per septic tank for pumping and proper disposal of the contents
Who Pays For It?	Paid for by municipality
Cost (\$)	Inspection: \$100/hour, 3 hours per site including reporting and travel time. (This time can be substantially more if the on-site sewage disposal system is difficult to locate.) Pumping: \$100-\$150/septic tank including disposal

**FIGURE 1 - SEPTIC SYSTEM MAINTENANCE**

(Excerpt From "Cost Estimating Guidelines: Best Management Practices And Engineered Controls", Rouge River National Wet Weather Demonstration Project)

***Authority***

Technical criteria need to have a basis of authority to assure that BMPs are implemented in accordance with the technical standards. The Rouge Project has been successful in taking its design criteria and working these into ordinances, regulations, model ordinances, etc. For example, the project implemented new storm water management standards for Wayne County in October 2000 (WCDOE, 2000). Key features of these standards include:

- Storm water outlet design, and sizing and location of the outlet with regard to stream capacity
- For drainage areas of 5 acres or more, the runoff rate must not exceed 0.15 cfs per acre for a 100-year storm; for less than 5 acres, the runoff rate must not exceed 0.15 cfs per acre for a 10-year storm

- Storm water runoff should conform to natural drainage patterns where feasible
- Storm water management systems should not generally be constructed within the 100-year flood plain; work within the flood plain has restrictions and requires compensatory storage and riparian habitat mitigation.

Another example of bringing technical criteria into law is the State of Michigan Wetlands Mitigation Bank. The Rouge Project worked with the State of Michigan Department of Environmental Quality to develop a wetlands banking system (State of Michigan, 1998). Units of government can apply for membership in the bank, and Wayne County was successful in becoming a member. The program establishes criteria for design, construction and maintenance of wetlands. At this time, over 10 acres of wetland are built or under construction for the bank.

A final example of the authority for promoting design criteria is in the CSO control program for 157 overflow points in the Rouge River. The authority was based on a court-ordered compromise under the US EPA and Michigan Department of Environmental Quality NPDES (National Pollutant Discharge Elimination System) program. The compromise ordered a phased approach to CSO control. Phase I required the elimination of raw sewage and the protection of public health for approximately 40 percent of the combined sewer area. The Phase 1 control plan was based on the technical design criteria (capture 0.17 inches of runoff) developed by the Rouge Project noted earlier. Under Phase I, six communities separated their sewers and eight communities constructed basins to evaluate varying sizes and control technologies of CSO basins.

### ***Measurement***

The third component in the design criteria stage is that of measurement. Design criteria are first established with computer models, engineering analyses, or results from other locations. The criteria need to be tested and examined, and ultimately refined based on the actual implementation in the watershed. The Wayne County Storm Water Management Program also requires post-construction monitoring, and we will learn from these new data. The Michigan Wetlands Banking Program requires 5 years of biological and water quality monitoring.

The CSO Phase 1 program has completed an extensive program of monitoring to determine if the demonstration size basins had met the water quality standards. A work group of staff from the Michigan Department of Environmental Quality, the NPDES permitted communities, and from the Rouge Project evaluated 2-years of measurements of basin influent and effluent and receiving water quality data. The Michigan Department of Environmental Quality has certified 6 of the 9 basins to date, and the design criteria that were established are being used to plan the next phase of controls.

## **ASSESS WATER QUALITY NEEDS BY SUBWATERSHEDS**

In the previous examples, CSO locations were known and locations for wetlands banking sites were governed by land use opportunity. What happens when there is a watershed sector suffering from eutrophication in an impoundment, stream bank erosion, and high wet weather bacteria?

This the second stage of the BMP process when the issue is not the design criteria, but the questions are: what is the type of technical solution, and at what scale should it be applied? What are the most appropriate BMPs for the specific environmental needs?

## ***Technical Basis***

The technical works at this stage is to thoroughly and systematically analyze the needs of each part of the watershed. In the Rouge Project, this stage was completed through a series of subwatershed management plans. The subwatersheds can be classified in three categories: those in headwaters where issues involve preservation, open space is relatively plentiful, and development ordinances can be useful; those at the most downstream and developed reaches, where the land is fully developed, and the issues are restoration and redevelopment; and those in growing suburban areas, which have a mix of issues from the other areas.

The seven subwatershed management plans for the Rouge watershed specify a series of BMPs to be implemented over the next 5 years (Rouge Subwatershed Advisory Groups (7), 2001). General goals for the period after 5 years were established, and these goals will be formulated into more specific BMP implementation after the first 5 years of progress are complete. The BMPs have been identified through a collaborative planning process involving the local units of government and Counties responsible for performing the work, the general public, and the state regulatory agency. Over 900 BMPs have been identified for implementation by 38 communities and agencies in the watershed.

## ***Authority***

The subwatershed management plans were developed and implemented as part of the Michigan Storm Water General Permit of 1997 (State of Michigan, 1997). The US EPA has accepted the General Permit as meeting criteria for EPA's national Phase II storm water program, which takes effect in 2002. In tailoring the General Permit to the needs of the Rouge watershed, the Project has attempted to incorporate watershed planning components from other of water resource management programs, including:

- **TMDL Program:** Various segments of the Rouge River are listed on the federal Clean Water Act Section 303(d) list for various parameters. The Total Maximum Daily Loads (TMDLs) for these segments are not scheduled for completion until approximately 2005. The river will require multiple TMDLs (approximately 15) that may result in conflicting implementation strategies in the watershed as a whole. Under the USEPA's proposed TMDL regulations, use of the watershed approach is encouraged, an approach already being implemented in the Rouge Project.
- **Water Quality Trading Program:** The State of Michigan is in the process of completing its Water Quality Trading Program rules. Through this program, the trading of nutrients in impaired water bodies (for which TMDLs have not yet been developed) can only occur where an approved watershed management plan has been developed. Unlike other "approvable" watershed plans, the watershed management plan for the trading program must include a "cap" and allocations.

As described earlier, the seven subwatershed advisory groups in the Rouge Watershed have developed watershed management plans as required under the Michigan General Permit. Obviously it is desirable to develop only one "comprehensive watershed management plan" that will meet stakeholder goals and objectives as well as all applicable program requirements any other programs that emerge. Therefore, the Rouge Project subwatershed management plans have a goal of being comprehensive watershed management plans that will meet objectives of multiple programs. By doing so, both the watershed communities and regulatory agencies will save time, money and effort by having one plan that fulfills multiple objectives. In

addition, these comprehensive plans will provide much needed certainty to the communities, counties and other stakeholders in planning for watershed management activities and expenditures.

## ***Measurement***

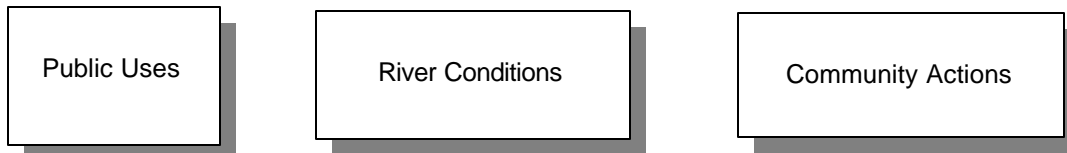
The Michigan General Permit requires that each subwatershed management plan include a description of the measures that will be used to gauge progress on meeting the goals of the plan. As Rouge Project representatives met with the Michigan Department of Environmental Quality to examine the requirements for measurement, we determined that the MDEQ would be satisfied with rather general forms of measurement. As a result, the Rouge Project established an overall architecture for the measurement program, and key elements of the program are noted below:

- The BMPs identified by the stakeholders should be designed to address all known causes of water quality standards violations
- Each BMP is “scored” relative to its potential ability to improve major designated uses of the receiving water, including fish propagation, partial human body contact, boating, and aesthetic enjoyment
- Measurements of the effectiveness will be made based on in-stream flow and water quality monitoring stations, along with biological surveys
- The performance standards and budgeting assumptions for all the actions have been standardized throughout the watershed to help assure that the implementation approach for various BMPs is relatively standard
- At the end of the 5-year period, the water quality results achieved will be assessed, along with the costs and other implementation issues
- A subsequent 5-year program of BMPs will be developed through the upcoming federal Phase II storm water program

Now that subwatershed communities are planning local actions to improve Rouge River water quality, the potential of these actions to solve condition and use problems are being evaluated. Figure 2 shows the structure for developing an action score for each BMP. The effect rating for actions can be combined with condition and use ratings, as shown below, to produce an overall “action score” which is location-specific. Logically, the highest score should represent a case where the most appropriate action has the greatest beneficial effect on the worst river condition and use problems. Rating values have been assigned accordingly. Action scoring of this type is necessarily based on “expert opinion”, not hard data; but the score numbers should provide a useful scale for comparing the likely benefits of applying different actions to different problems in different watershed situations.

The effectiveness of community actions is highly dependent on where and when actions occur, and how well they address river quality problems. In general, the most beneficial actions are those, which have the most *direct* effects. Other less beneficial actions have *indirect* or only *potential* effects. Some actions may be highly effective in one location or season and ineffective in another. Moreover, an action may improve one kind of river condition or use, and have no effect or even undesirable effects on others. In short, the effectiveness (or cost-effectiveness) of community actions can be evaluated only in the context of local river conditions and public uses.

The effects of community actions on Rouge quality can best be measured at monitoring stations where historical conditions are known. Prior data for river quality indicators at these stations provide a yardstick for monitoring future trends in condition or use quality. The data provide a basis for gauging the long-term



ARE AFFECTED BY... → ← AFFECT...

Use Category	Use Quality	Rating Value
1. Fishing	• Full	1
2. Canoeing & Boating	• Limited	2
3. Wading & Swimming	• Restricted	3
4. Aesthetics		

Condition Indicators	Condition Quality	Rating Value
1. DO	• Good	1
2. Flow	• Fair	2
3. Bacteria	• Poor	3
4. Aquatic Life		
5. Stream Habitat		

Community Actions	Effect Quality	Rating Value
1. BMPs	• Direct Effect	3
2. Etc.	• Indirect effect	2
	• Potential effect	1
	• No effect	0

Use Rating (1-3)	X	Condition Rating (1-3)	X	Effect Rating (3-0)	=	Action Score (0-27)
------------------	---	------------------------	---	---------------------	---	---------------------

**FIGURE 2 - ROUGE RIVER NATIONAL WET WEATHER DEMONSTRATION PROJECT: BMP ACTION SCORING SYSTEM**

effectiveness of community actions as well. Site-specific ratings of various actions can help communities to design local programs, which yield the greatest returns for their money and effort.

## PROMOTING THE IMPLEMENTATION OF THE MOST EFFECTIVE BMPS

As we come to the third stage of the whole BMP process, the design criteria have been established and the plan is in place for what BMPs are needed, where, and at what scale. The next challenge is implementation

-- how do we implement the plan and build the projects that best fit the environmental needs and meet the design criteria?

Successful implementation is difficult in watershed management because there is seldom one agency with funding and authority to perform all the work. In addition, implementation often relies partially on voluntary efforts. Consequently, there are no guarantees that design criteria will be used or that BMPs will be implemented in accordance with a desired schedule. The Rouge Project has relied again on its three-part formula of a sound technical basis, an authority, and a measurement system to make progress with implementation.

### ***Technical Basis***

The Rouge Project has developed a program management approach to promote the implementation or construction of BMPs that meet the design criteria and are in accordance with the plans. The most powerful tool that the Rouge Project has for implementation is a source of funding. The US EPA demonstration grant funds are primarily used for sponsoring projects by stakeholders in the watershed. Over 93% of all the grant funding received has been given as “subgrants” to communities for the design and construction of CSO, storm water, and non point source BMPs.

The subgrants are offered on a competitive process to communities, agencies and non-governmental organizations in the Rouge watershed that meet minimum qualifications. Since October 1997, the project has issued “Notices of Grant Availability” at approximately six-month intervals. The regularity of these grant notices is designed to facilitate the funding of projects by the grantee communities and agencies. The funding is a maximum of 50% on a reimbursement basis, so each grant recipient needs to encumber local matching funds for their projects, which can take six or more months.

The Notices of Grant Availability specify requirements for proposals from communities and establish a date for submittal and project evaluation criteria. The Notices also identify the types of activities that will be eligible for funding, and these activities have included:

- wetlands creation or restoration
- habitat and recreational opportunities
- storm water management
- on-site sewage disposal system management
- illicit discharge elimination
- public education on storm water
- geographic information system implementation
- other projects that implement the subwatershed management plans.

Figure 3 shows the evaluation criteria that have been used in recent competitive proposal selection. A technical review team comprised of representatives of the County and other independent agencies performs the proposal evaluation.

CRITERIA	WEIGHT
1. Consistency with the watershed management goals of the subwatershed management plan and the Rouge River restoration and its national demonstration goals. Higher scores will be given to those projects that most directly improve water quality.	30
2. Consistency with the community's or agency's Certificate of Coverage for the Storm Water General Permit and subsequent subwatershed management plan and storm water pollution prevention initiative	15
3. Availability of other funding sources. If other sources are available, scoring will be lower.	10
4. Performance of the community in timely execution and progress and expense reporting of projects under previous interagency agreements.	20
5. Cooperative approaches with other communities or agencies.	10
6. Cost-effectiveness and timely schedule of the proposed project.	10
7. Clarity of the proposal and conformance to the submittal requirements.	5

**FIGURE 3 - TYPICAL CRITERIA FOR PROPOSAL EVALUATION, ROUGE RIVER NATIONAL WET WEATHER DEMONSTRATION PROJECT**

### *Authority*

In this stage, the authority for the implementation effort rests with the Steering Committee of the Rouge River Watershed. This is a group representative of the counties, municipalities, subwatersheds, regulatory agencies and other parties with oversight over the project. It is a group of peer communities that governs by consensus. The Steering Committee reviews the notices of grant availability and the evaluation criteria, and then reviews and ratifies the selection process. The Steering Committee is an ad hoc group without legal authority, but it operates on a consensus basis. In 2002, the communities of the Rouge watershed began planning discussions to form a Local Management Assembly to replace the Steering Committee with a more formal organization having limited legal authority through inter-governmental agreements.

### *Measurement*

In this stage of the whole BMP process, the most useful measurement is BMP implementability. Such measures should address any barriers to implementation, what would be done differently next time, and what lessons were learned. The project is seeking practical advice that is in the language of the local community public works department director.

Each subgrantee is required to submit a report that summarizes the implementation of the BMP project. The following are examples of reporting on the BMP implementation:

- Erosion Controls at Construction Sites – compared fabrics, fences, and hay; found hay most versatile
- Catch Basin Cleaning – found 3-year frequency optimal in terms of cost and effectiveness in maintaining catch basin functionality



- Stream Bank Stabilization - improved designs for bioengineered stabilization, as well as traditional stone bank protection; developed training for municipalities in stabilization design and construction practice
- Public Education Projects – resulted in surveys that measured public opinion (Powell, et al., 2000)

## **STANDARD PROTOCOLS FOR RECEIVING WATER MEASUREMENTS**

The next stage in the whole BMP process is the use of standard protocols for field measurement. Once there are BMPs built according to design criteria and fulfilling watershed protection needs, then uniformity in measuring receiving water measurements is required.

### ***Technical Basis***

The Rouge Project has spent considerable effort in analyzing ecosystem health and receiving water quality, and then determining the key parameters to be measured.

Historically, the Rouge River has been damaged by industrialization and suburban expansion. The river's name reflects the inherent problem of erosion of the river's red clay soil banks even from the early days of French settlers 300 years ago. Since industrialization, public health agencies measured oils and greases and toxics such as mercury and PCBs in the sediments. The Rouge Project began a major annual monitoring program in 1993. Those surveys have shown the following pollutants to be the main problems in the Rouge:

- Dissolved oxygen deficits, particularly downstream of combined sewer overflows, but also upstream in impoundments and reaches of the river affected by sanitary discharges
- Extremes of flow – either due to increasing impervious areas and flash flooding, or due to extremely low flow
- Pathogens from combined sewers, leaking septic systems, sanitary sewer overflows, and illicit connections to storm drains
- Nutrients from lawn fertilizers and sanitary discharges

Metals and toxics have generally not been a problem, except in the sediments of the most downstream portion of the river. There are also some hot spots of sediment contamination, and one lake that had been contaminated with PCB in the sediments. This lake was dredged in 1997 and 1998, and it is an example of an easily measured BMP. The removal of the contamination could be measured, the bottom dredged deeper and fish stocked. Water quality measurements have confirmed the viability of the new fishery and new recreational uses of the lake. There is now more recreation, fishing, boating, and a triathlon celebrating its second year in 2001.

## ***Authority***

The Rouge Project has established definitive standards for measurement. Because it is a federally funded demonstration project, the protocols for all measurements are established in accordance with quality assurance and control standards established by the US Environmental Protection Agency. The US EPA provides grant funding for a portion of the sampling cost. The project has demonstrated the effectiveness of a variety of sampling and modeling techniques and has published the information on the Rougeriver.com web site. By using the web site, communities that need to develop less extensive sampling programs can benefit from the experience of the Rouge project.

A Field Sampling Plan (FSP) Preparation Guide has been developed. This guidance document serves as a template for the preparation of site-specific FSPs. The FSP Preparation Guide also serves as a review checklist for quality control reviews to ensure that the appropriate level of detail is provided in the FSP.

Activities that are undertaken routinely in a consistent manner are documented in Standard Operating Procedures (SOPs). SOPs are available for laboratory methods (e.g., the 5-day Biochemical Oxygen Demand Determination) and field sampling (e.g., sediment coring) techniques.

Each laboratory under contract to Wayne County is responsible for implementing a quality assurance program specifically designed for laboratory activities. As part of this program, laboratories must document and update SOPs regularly in their Quality Assurance Program Plans (QAPP). The Rouge Project maintains on file current copies of all subcontract laboratory QAPPs. Only EPA approved analytical methods are used for analyses of samples collected as part of the Rouge Project. For those activities, which require modification of existing SOPs or development of new SOPs, internal review and approval will be sought from EPA prior to their use.

## ***Measurement***

An example of the detail that the program has achieved is given by the evaluation of the Cedar Lake detention pond shown in Figure 4. In this example, rainfall, influent and effluent data were analyzed concurrently as part of the detailed examination of the wet detention pond.

## **WATERSHEDWIDE MONITORING PROGRAM AND DATA ASSESSMENT**

The preceding stage of the entire BMP process yields an important end product -- a comprehensive means of measuring the collective contribution of many BMPs to the progress of water quality improvement. The Rouge Project has successfully monitored the watershed since 1994 through a system of 7 continuous flow and dissolved oxygen gages and dozens of dry weather grab sampling sites. Special studies have been conducted on an annual basis to develop more information on phosphorus loadings from fertilizer, sediment oxygen demands, time of travel, impoundment reaeration, and total residual chlorine, among other issues. As an example of a low cost method of evaluating ecosystem health, frog and toad surveys have been conducted for the last three years in headwater areas. These surveys, which have brought out an increasing number of public volunteers each year, provide useful information with the added benefit of bringing people to the resource which will hopefully assist with pollution prevention through increased awareness.

Figure #B1

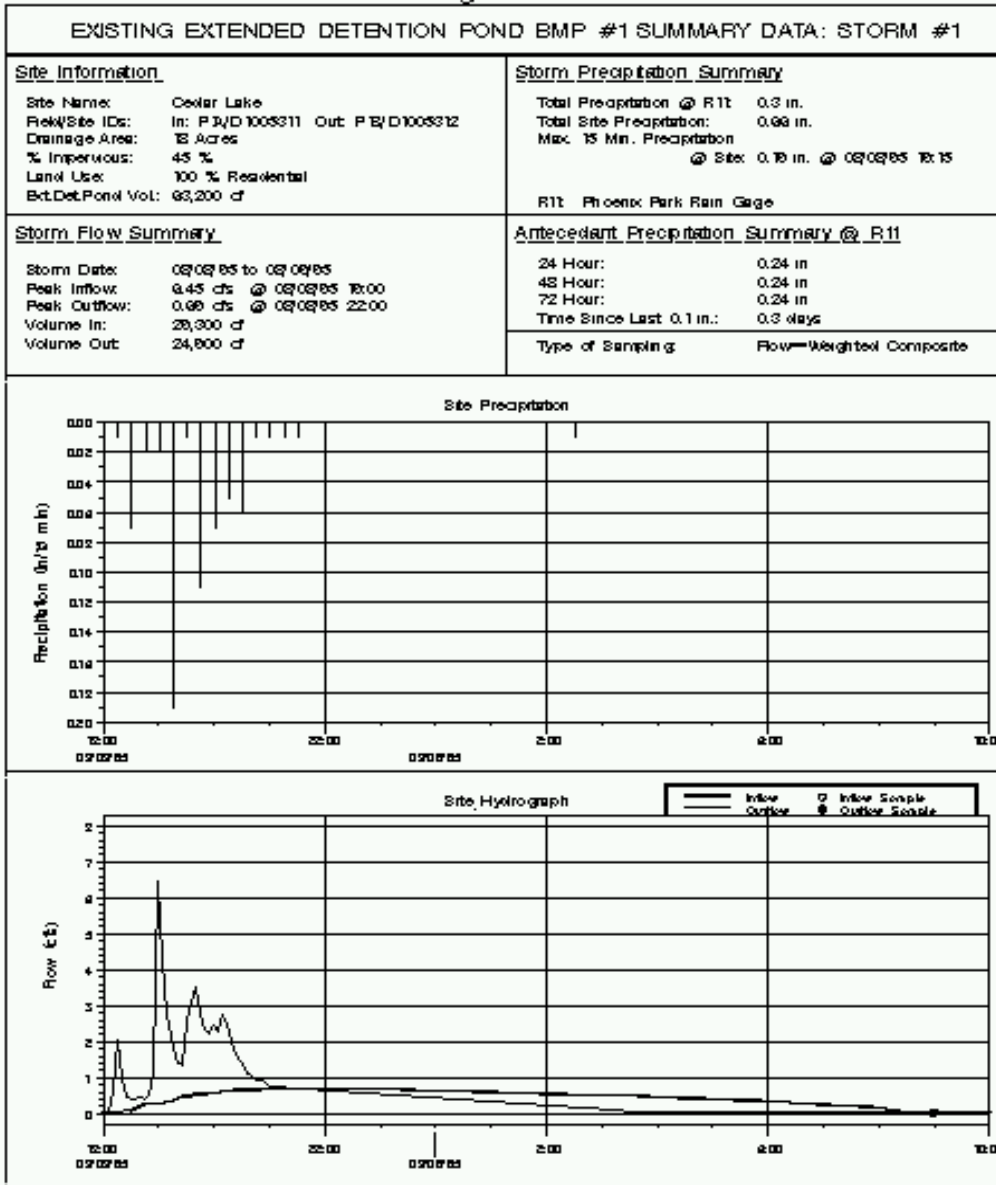


FIGURE 4 – MEASUREMENT OF CEDAR LAKE BMP PERFORMANCE

Through its annual surveys, the Rouge Project has been able to document a continuing improvement in dissolved oxygen downstream of the now controlled CSO discharges. The annual surveys also provide a basis for further investigation and correction of other pollution sources. Among the benchmarks that future annual surveys will consider are the following:

Flow variability

- Restrict peak flow rates at critical points
- Do not allow critical reach to meet the peak more than 10% of the time

## Nutrients

- Phosphorus limited not more than 0.05 mg/l total phosphorus

## Soil Erosion and Sedimentation

- Settleable solids or suspended solids not present in concentrations that interfere with designated uses

## Dry Weather Total Suspended Solids

- Based on achieving desired aesthetic use, maintain or achieve TSS below 80 mg/l in dry weather

## Loss of Natural Features

- Benchmark compared to status in year 2000

## Passive and Active Recreation

- Dissolved oxygen standard 4 mg/l or 5 mg/l, depending on the location
- Bacteria standards

## **SUMMARY**

The annual assessment of water quality completes the stages of the whole BMP process that the Rouge Project uses to measure the performance of BMPs with respect receiving water impacts. In the year 2000, the annual assessment showed that the Rouge River met the dissolved oxygen standards 94% of the time in its most downstream reaches. Only six years ago, the river was only meeting the dissolved oxygen standards in these reaches about 30% of the time, or less. Wildlife are responding, with ever increasing numbers and varieties of fish, birds, macroinvertebrates, and other species.

The staged approach to BMP performance allows the Rouge Project to measure, and continually improve each step of the watershed management process. This approach has allowed the Rouge Project to meet its two main goals; first, to make great progress in restoration in the Rouge watershed; and second, to share practical and transferable results with other watersheds and demonstrate the implementation of wet weather pollution control policy.

## **ACKNOWLEDGMENTS**

This paper represents a summary of select elements from the ongoing efforts of many individuals and organizations who are involved in the restoration of the Rouge River. The authors also gratefully acknowledge the assistance of Ms. Charlotte Nichols for her assistance in the preparation of this manuscript.

The Rouge River National Wet Weather Demonstration Project is funded, in part by the United States Environmental Protection Agency (EPA) Grants #X995743-02 to 07. The views expressed by individual authors are their own and do not necessarily reflect those of the EPA. Mention of trade names, products or services does not convey, and should not be interpreted as conveying, official EPA approval, endorsement,

or recommendation.

## REFERENCES

- Alsaigh, R., 1994. CSO Facilities Design Parameter Report. Rouge River National Wet Weather Demonstration Project, Report CSO-TR02.00.
- Cave, K. A. and J. D. Bails, October 1998. Implementing a Model Watershed Approach Through A State General Storm Water NPDES Permit, Proceedings of WEFTEC 98, Water Environment Federation.
- Ferguson, T., R. Gignac, M. Stoffan, A. Ibrahim, and J. Aldrich, May 1997. Cost Estimating Guidelines: Best Management Practices and Engineering Controls. Rouge River National Wet Weather Demonstration Project, Supplemental Report NPS-SR10.00. Updated as NPS TR25.00, May 2001.
- Lower 1 Rouge River Subwatershed Advisory Group, May 2001. Lower 1 Rouge River Subwatershed Management Plan, Rouge River National Wet Weather Demonstration Project.
- Lower 2 Rouge River Subwatershed Advisory Group, May 2001. Lower 2 Rouge River Subwatershed Management Plan, Rouge River National Wet Weather Demonstration Project.
- Main 1-2 Rouge River Subwatershed Advisory Group, May 2001. Main 1-2 Rouge River Subwatershed Management Plan, Rouge River National Wet Weather Demonstration Project.
- Main 3-4 Rouge River Subwatershed Advisory Group, May 2001. Main 3-4 Rouge River Subwatershed Management Plan, Rouge River National Wet Weather Demonstration Project.
- Middle 1 Rouge River Subwatershed Advisory Group, May 2001. Middle 1 Rouge River Subwatershed Management Plan, Rouge River National Wet Weather Demonstration Project.
- Middle 3 Rouge River Subwatershed Advisory Group, May 2001. Middle 3 Rouge River Subwatershed Management Plan, Rouge River National Wet Weather Demonstration Project.
- Powell, J, and J. Bails, February 2000. Measuring the Soft Stuff - Evaluating Public Involvement in Urban Watershed. Proceedings WEF Watershed 2000.
- Rouge River National Wet Weather Demonstration Project, May 2001. Common Appendix for Rouge Subwatershed Management Plans Submitted in fulfillment of the MDEQ Stormwater General Permit, Rouge River National Wet Weather Demonstration Project.
- State of Michigan, Department of Environmental Quality, July 30, 1997. National Pollutant Discharge Elimination System, General Wastewater Discharge Permit, Storm Water Discharges from Separate Storm Water Drainage Systems, Permit No. MIG610000.
- State of Michigan, Department of Environmental Quality, 1998. Wetlands Banking Regulations.
- Upper Rouge River Subwatershed Advisory Group, May 2001. Upper Rouge River Subwatershed Management Plan, Rouge River National Wet Weather Demonstration Project.

Wayne County, Michigan, Department of Environment, October 19, 2000. Storm Water Management Program (Version 1.0).

**KEY WORDS**

BMP (Best Management Practice)

Stormwater

Watershed

Receiving Waters

Wetlands

Water Quality

Wet Weather

Environmental Regulations

# THE MARYLAND STORMWATER MANAGEMENT PROGRAM A NEW APPROACH TO STORMWATER DESIGN

Stewart R. Comstock, P.E. & Charles Wallis, P.E.  
Maryland Department of the Environment  
Baltimore, Maryland

Maryland's original stormwater management program was developed as part of the Chesapeake Bay Initiatives in 1984. At that time, the prevailing attitude was that controlling flooding caused by increases in new development would maintain the quality of receiving streams. Thus, the original Code of Maryland Regulations (COMAR) specifying stormwater management was slanted towards flood control. Much experience has been gained in years since Maryland implemented the original program.

Recently, additional emphasis has been directed on controlling the quality of runoff from land use changed by urbanization and the quantity of this runoff to reduce stream channel erosion. Recognizing that the State's stormwater management program had not changed in over a decade, the Maryland Department of the Environment (MDE) proposed modifications to the COMAR in July 2000. The primary goals of the proposed regulations were to refocus the overall objectives for controlling runoff from new development and promote environmentally sustainable techniques. To that end, MDE developed the **2000 Maryland Stormwater Design Manual, Volumes I & II** (MDE, 2000) to establish stormwater design criteria and provide specific procedures for local jurisdictional use in improving existing programs for nonpoint source pollution control within the Chesapeake Bay and its tributaries as well as coastal bays. As such, the Design Manual would serve as the primary source of stormwater management information for the development community and regulatory agencies throughout the State.

In the beginning, MDE developed the Design Manual to address three goals to: (1) protect the waters of the State from the adverse impacts urban stormwater, (2) provide design guidance on effective structural and nonstructural best management practices (BMPs) for new development sites, and (3) improve the quality of BMPs that are constructed in the State. While drafting the Design Manual, MDE recognized that the project was evolving into a more comprehensive approach to stormwater design. Included in this approach was better guidance for total site design and incentives for environmentally sustainable or "green" development techniques. The projected outcome of this new approach would be site designs that more closely mimic natural processes and reduce reliance on the use of structural management techniques to treat stormwater runoff.

As a final product, the Design Manual shows great promise in accomplishing the goals and objectives established in the beginning and during this project. The adopted manual serves as a primary source of stormwater design information for the development community and regulatory agencies in both Maryland and in many other areas.

# 1. Introduction

Maryland's current stormwater management program was established in 1984 when the prevailing attitude was that if the flooding caused by increases in runoff volume from new development was controlled, the quality of receiving streams could be sustained. Hence, the original Code of Maryland Regulations (COMAR) specifying stormwater management design requirements were slanted toward flood control. Specifically, new development was required to reduce post-construction flows of the two and ten-year design storms to pre-development levels. This policy, known as peak management, was thought to address stream channel erosion concerns as well as provide adequate flood control in receiving waters. Although a general definition of water quality management was included in the original regulations, specific guidelines and design criteria were absent from the State's original stormwater management program.

More recently, more emphasis has been placed on controlling the quality of runoff from land use changed by urbanization and the quantity of this runoff to prevent stream channel erosion. Recognizing that Maryland's stormwater management program had not changed since its inception, the Maryland Department of the Environment (MDE) proposed modifications to COMAR in 1993 to refocus the overall objectives of Maryland's efforts toward controlling new development runoff. The goals of these modifications included the control of more frequent storm events, prevention of stream channel erosion, limiting the number of stormwater management waivers, and providing incentives to developers to design projects in an environmentally friendly way. MDE solicited and received an enormous amount of recommendations from numerous organizations and individuals including State and local government officials, developers, design engineers, and environmental groups. While there was general agreement that the State's stormwater management program needed revision, there was a huge disparity in the comments regarding how the program ought to be revised. One common suggestion was that COMAR should set general policy and that specific design requirements should be compiled in a single, separate guidance document. Consequently, MDE commenced work on the development of a stormwater management design manual in 1995.

Maryland's stormwater management program has been considered one of the more advanced of its kind. However, the original program's focus on flood control and its reliance on a preference list for best management practice (BMP) selection hampered MDE's goals to more effectively control nonpoint source pollution, reduce stream channel erosion, and promote innovative stormwater design. The **2000 Maryland Stormwater Design Manual, Volumes I & II** was developed with three distinct goals to; 1) protect the waters of the State from adverse impacts of urban stormwater runoff, 2) provide design guidance on the most effective structural and non-structural BMPs for development sites, and 3) improve the quality of BMPs that are constructed in the State, specifically with respect to their performance, longevity, safety, maintenance, community acceptance, and environmental benefit. On October 2, 2000, the Maryland Department of the Environment (MDE) adopted new stormwater regulations including the Design Manual. Recognizing the demand for environmentally sustainable or "green" design, these regulations represent a more comprehensive approach to stormwater design. Included in this approach are better guidance for total site design and incentives for nonstructural BMPs. The anticipated outcomes of this program are projects designed to more closely mimic natural processes.

While going a long way in promoting sustainable development, the State's stormwater management program is not the only set of rules that govern development. There are several State and local programs (e.g., Critical Areas, Forest Conservation, Wetlands Protection) that promote natural resource conservation. There are also local zoning regulations that govern land development. Although the goal of these diverse



programs is to protect the environment, there are instances where green development practices are discouraged and older, less sustainable standards are required.

It is difficult to accommodate the requirements of the full spectrum of resource protection programs. However, the Design Manual recognizes the importance of each and encourages these principles during project design. Accordingly, the State’s approach to stormwater design may be summarized as a three-step process: avoidance, minimization, and mitigation. The first step, avoidance, is not just resource protection, but also includes avoiding development practices such as large-scale clearing and mass grading, structural fill, and suburban sprawl that have negative impacts on local hydrology. Any reduction in imperviousness or a site’s footprint significantly reduces the amount of stormwater runoff. The second step is minimization. After all options for avoiding impacts are expended, the designer should incorporate practices that either replace or disconnect impervious surfaces. For example, using green roof technology, permeable pavements, or promoting sheet flow will also reduce runoff. After all options to avoid or minimize have been exhausted, the remaining runoff must be treated using structural practices to mitigate water quality and channel stability impacts.

## **2. The 2000 Maryland Stormwater Design Manual**

### **2.1 *Volume I***

The first volume of the design manual presents the basic technical information for designing stormwater management in Maryland. Its five chapters present background material on the importance of controlling stormwater runoff, general performance standards for stormwater management, basic stormwater design objectives, minimum design criteria for BMP design, guidance for selecting and locating BMPs, and an innovative system of “credits” for environmentally sensitive design techniques. The information contained in these chapters provides for meeting the three goals of the design manual.

#### **2.1.1 Chapter 1 - Introduction**

A basic understanding of the impacts of stormwater runoff on watersheds is critical before any stormwater design criteria can be established. Chapter 1 provides fundamental information on the effects of stormwater runoff on water quality, groundwater recharge, stream channel habitat, overbank flooding, and flood plain expansion. This information is critical if innovative stormwater designs are to be successful.

Chapter 1 also establishes twelve general performance standards for stormwater design and provides guidance on how to use the manual. The chapter concludes with a brief description of new stormwater design requirements and a list of all symbols and acronyms used within the manual.

#### **2.1.2 Chapter 2 – Basic Stormwater Design Criteria**

The first goal of the stormwater design manual is to protect the waters of the State from adverse impacts associated with urban runoff. Chapter 2 presents a unified approach to sizing stormwater BMPs for meeting this goal. This approach consists of five criteria (see Table 1) that are designed to meet pollutant removal goals, maintain groundwater recharge, reduce channel erosion, prevent overbank flooding, and pass extreme floods. Of these criteria, the water quality ( $WQ_v$ ), recharge ( $Re_v$ ) and channel protection ( $Cp_v$ ) volumes are determined by soils, amount of imperviousness, proposed design and/or layout, and implementation of nonstructural practices. This simplifies calculations, reduces error and/or abuse, and provides direct incentives to reduce impervious areas.

Another important feature of these three volumetric criteria is the relation to natural hydrologic processes. Explicitly, the  $Re_v$  criterion is designed to promote groundwater recharge and interflow. Likewise, the rationale for the  $Cp_v$  criterion is that runoff will be stored and released in such a gradual manner that critical erosive velocities during bankfull and near bankfull events will seldom be exceeded in downstream channels. While the  $WQ_v$  is the storage volume needed to capture and treat the runoff from 90% of the average annual rainfall, it also provides management at a critical level (1/3 bankfull elevation) within stream channels. When considered together, these three criteria capture and treat the runoff from at least 95% of the average annual rainfall (see Figure 1) and mimic natural recharge and channel forming processes.

Chapter 2 also introduces five groups of structural BMPs and a group of non-structural BMPs that may be used to meet pollutant removal and groundwater recharge goals. Lastly, this chapter designates certain land uses as “stormwater hotspots” which may restrict the use of certain BMPs and may require pollution prevention plans.

**Table 1.** Summary of Unified Stormwater Sizing Criteria

<b>Sizing Criteria</b>	<b>Description</b>
<b>Water Quality Volume (WQ<sub>v</sub>) (acre-feet)</b>	$WQ_v = [(P)(R_v)(A)]/12$ P = 1.0" in Eastern Zone and 0.9" in Western Zone $R_v = 0.05 + 0.009(I)$ where I is percent impervious cover A = Area in acres
<b>Recharge Volume (Re<sub>v</sub>) (acre-feet)</b>	$Re_v = [(S)(R_v)(A)]/12$ S = Soil Specific Recharge Factor Re <sub>v</sub> is a sub-volume of WQ <sub>v</sub>
<b>Channel Protection Storage Volume (Cp<sub>v</sub>)</b>	Cp <sub>v</sub> = 24 hour extended-detention of the post-developed one-year 24 hour storm event.  Cp <sub>v</sub> is not required on the Eastern Shore of Maryland
<b>Overbank Flood Protection Volume (Q<sub>px</sub>)</b>	Local review authorities may require that the peak discharge from the ten-year storm event be controlled to the pre-development rate (Q <sub>p10</sub> ). No control of the two-year storm event (Q <sub>p2</sub> ) is required.  For Eastern Shore, provide peak discharge control for the two-year storm event (Q <sub>p2</sub> ). No control of the ten-year storm event (Q <sub>p10</sub> ) is required.
<b>Extreme Flood Volume (Q<sub>t</sub>)</b>	Consult with the appropriate local reviewing authority. Normally no control is needed if development is excluded from the 100-year flood plain and downstream conveyance is adequate.

### 2.1.2.1. Unified Stormwater Sizing Criteria – Water Quality Volume (WQ<sub>v</sub>)

The Water Quality Volume (denoted as the WQ<sub>v</sub>) is the storage needed to capture and treat the runoff from 90% of the average annual rainfall (COMAR 26.17.02). In numerical terms, it is equivalent to an inch of rainfall multiplied by the volumetric runoff coefficient (R<sub>v</sub>) and site area. Treatment of the WQ<sub>v</sub> shall be provided at all developments where stormwater management is required. A minimum WQ<sub>v</sub> of 0.2 inches per acre shall be met at sites or drainage areas that have less than 15% impervious cover. Drainage areas having no impervious cover and no proposed disturbance during development may be excluded from the WQ<sub>v</sub> calculations.

### 2.1.2.2. Unified Stormwater Sizing Criteria – Recharge Volume Requirements ( $Re_v$ )

The criteria for maintaining recharge is based on the average annual recharge rate of the hydrologic soil group(s) present at a site as determined from the United States Department of Agriculture (USDA), Natural Resources Conservation Service (NRCS) Soil Surveys or from detailed soil investigations. More specifically, each specific recharge factor ( $S$ ) is based on the USDA average annual recharge volume per soil type divided by the annual rainfall in Maryland (42 inches per year) and multiplied by 90% (Table 2). This keeps the recharge volume calculation consistent with the  $WQ_v$  methodology.

Table 2. Soil Specific Recharge Factors ( $S$ )

Hydrologic Soil Group	USDA Average Annual Recharge Volume*	Soil Specific Recharge Factor ( $S$ )
A	18 inches/year	0.38
B	12 inches/year	0.26
C	6 inches/year	0.13
D	3 inches/year	0.07

\*Rawls, Brakensiek & Saxton, 1982

The recharge volume is considered part of the total  $WQ_v$  that must be addressed at a site and can be achieved either by nonstructural techniques (e.g., buffers, disconnection of runoff), structural practices (e.g., infiltration, bioretention), or a combination of both. Like  $WQ_v$ , drainage areas having no impervious cover and proposed disturbance may be excluded from recharge calculations.  $Re_v$  and  $WQ_v$  are inclusive. If  $Re_v$  is treated upstream of  $WQ_v$ , then  $Re_v$  may be subtracted from the  $WQ_v$  when sizing water quality treatment.

The intent of the recharge requirement is to maintain existing groundwater recharge at development sites. This helps to preserve water table elevations thereby maintaining the hydrology of streams and wetlands

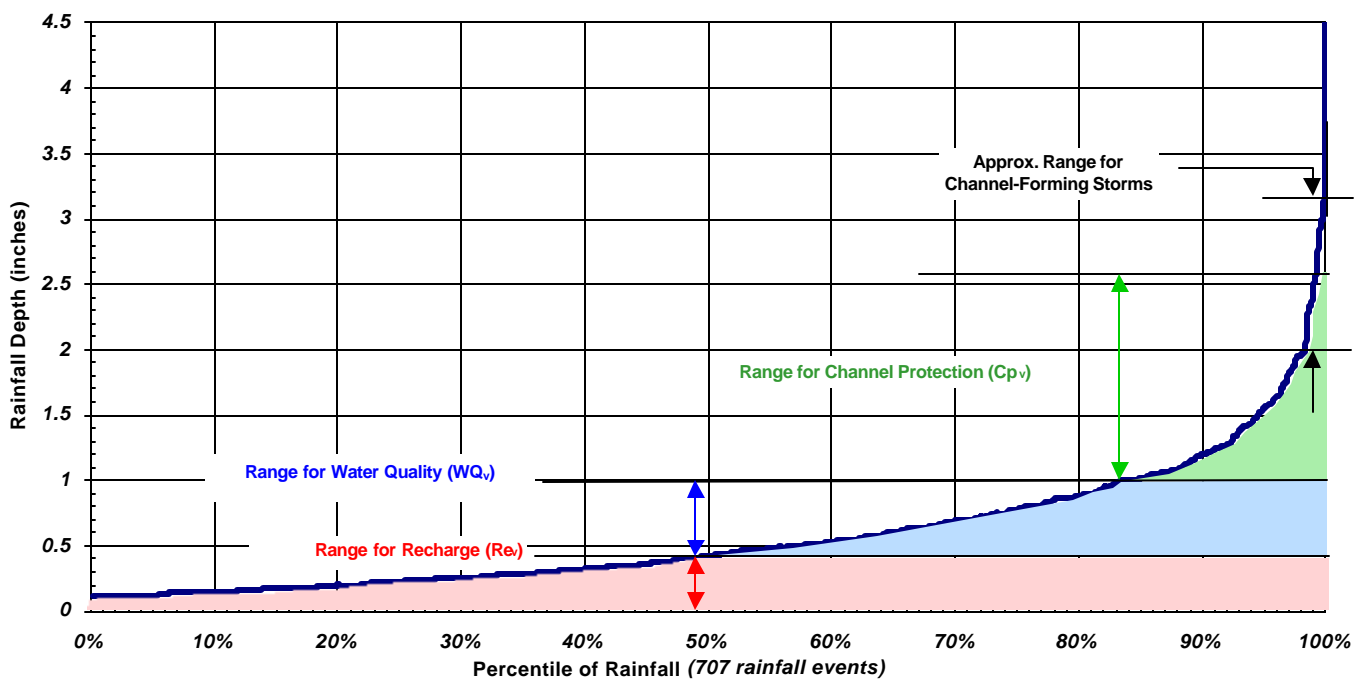


Figure 1. Rainfall events captured and treated by the recharge ( $Re_v$ ), water quality ( $WQ_v$ ) and channel protection ( $Cp_v$ ) volumes using 1980 to 1990 rainfall frequency records for Baltimore City

during dry weather. The volume of recharge that occurs on a site depends on slope, soil type, vegetative cover, precipitation, and evapo-transpiration. Sites with natural ground cover such as forest or meadow have higher recharge rates, less runoff, and greater transpiration losses under most conditions. Because development increases impervious surfaces, a net decrease in recharge is inevitable.

**2.1.2.3. Unified Sizing Criteria - Channel Protection Volume ( $C_{p_v}$ )**

The primary purpose of the Channel Protection Storage Volume ( $C_{p_v}$ ) requirement is to protect stream channels from excessive erosion caused by the increase in runoff from new development. The rationale for this criterion is that runoff from the one year design storm will be stored and released in such a gradual manner that critical erosive velocities during bankfull and near-bankfull events will rarely be exceeded in downstream channels. The method for determining the  $C_{p_v}$  requirement is based on the “Design Procedures for Stormwater Management Extended Detention Structures” (MDE, 1987) and is detailed in Appendix D.11 of the Design Manual. The  $C_{p_v}$  requirement does not apply to direct discharges to tidal waters or developments located on Maryland’s Eastern Shore.

**2.1.3. Chapter 3 – Performance Criteria for Urban BMP Design** The secondary and tertiary goals of the design manual are to provide design guidance and improve the quality of BMPs that are constructed in the State. Chapter 3 promotes these goals by outlining performance criteria for five groups of structural stormwater BMPs for water quality treatment (see Figure 2). These performance criteria are designed to ensure that each BMP group is capable of meeting the State’s goal of an 80% reduction of total suspended solids (TSS) from urban stormwater runoff. This allows prospective designers to choose from a variety of BMPs that best fit individual site needs and still meet the State’s pollutant removal goals. Each set of BMP performance criteria is based on six factors that address general feasibility, conveyance criteria, pretreatment needs, BMP geometry, environmental and landscaping requirements, and maintenance concerns.

---

<p>Stormwater Ponds</p> <ul style="list-style-type: none"> <li>• Micropool Extended-Detention (ED) Ponds</li> <li>• Wet Ponds</li> <li>• Wet ED Ponds</li> <li>• Multiple Pond Systems</li> <li>• “Pocket “ Ponds</li> </ul> <p>Stormwater Wetlands</p> <ul style="list-style-type: none"> <li>• Shallow Wetland</li> <li>• ED Shallow Wetland</li> <li>• Pond/Wetland System</li> <li>• “Pocket” Wetland</li> </ul> <p>Stormwater Infiltration</p> <ul style="list-style-type: none"> <li>• Infiltration Trench</li> <li>• Infiltration Basin</li> </ul>	<p>Stormwater Filtering Systems</p> <ul style="list-style-type: none"> <li>• Surface Sand Filters</li> <li>• Underground Sand Filters</li> <li>• Perimeter Sand Filters</li> <li>• Organic Filters</li> <li>• Pocket Sand Filters</li> <li>• Bioretention</li> </ul> <p>Open Channel Systems</p> <ul style="list-style-type: none"> <li>• Dry Swale</li> <li>• Wet Swale</li> </ul>
---	---

---

**Figure 2.** Structural BMPs that may be used for “stand alone” water quality treatment in Maryland

**2.1.3. Chapter 4 –Selecting and Locating the Most Effective BMP System**

In conjunction with the previous chapter, Chapter 4 promotes the secondary and tertiary goals of the manual by outlining a process for selecting the best BMP or group of BMPs for a development site. The chapter

also provides guidance on factors to consider when locating BMPs at a given site. This process is used to filter those BMPs that can meet the pollutant removal targets for  $WQ_v$  and guides designers through six steps that screen for watershed factors, terrain factors, stormwater treatment suitability, physical feasibility factors, community and environmental factors, and locational / permitting factors. These factors, when used progressively, allow designers to select BMPs that are most suitable for the various physiographic regions within the State as well as for specific site and design characteristics such as land use or wildlife habitat enhancement.

### 2.1.5. Chapter 5 – Stormwater Credits

One of the major programmatic changes promoted by the Design Manual is the notion that stormwater management should not rely solely on the use of structural BMPs but should integrate stormwater into the overall site design process. Chapter 5 supports this philosophical change by advancing a series of nonstructural design practices that can reduce the generation runoff from a site thereby reducing the size and cost of structural BMPs. Additionally, these practices provide partial removal of many pollutants. To promote greater use, these non-structural practices have been classified into six sub-groups (see Table 3.) with an associated “credit” provided for designers utilizing these progressive techniques.

**Table 3.** Stormwater Credits for Innovative Site Design

<b>Stormwater Credit</b>	<b>Description</b>
<b>Natural Area Conservation</b>	Conservation of natural areas such as forest, non-tidal wetlands, or other sensitive areas in a protected easement thereby retaining their pre-development hydrologic and water quality characteristics. Using this credit, a designer may subtract conservation areas from total site area when computing $WQ_v$ . Additionally, the post-development curve number (CN) for these areas may be assumed to be forest in good condition.
<b>Disconnection of Rooftop Runoff</b>	Credit is given when rooftop runoff is disconnected and then directed over a pervious area where it may either infiltrate into the soil or filter over it. Credit is typically obtained by grading the site to promote overland flow or by providing bioretention on single-family residential lots. If a rooftop area is adequately disconnected, the impervious area may be deducted from the total impervious cover. Additionally, the post-development CNs for disconnected rooftop areas may be assumed to be forest in good condition.
<b>Disconnection of Non-Rooftop Runoff.</b>	Credit is given for practices that disconnect surface impervious cover by directing it to pervious areas where it is either infiltrated or filtered through the soil. As with rooftop runoff, the impervious area may be deducted from the total impervious cover thereby reducing the required $WQ_v$ .
<b>Stream Buffer Credit</b>	Credit is given when a stream buffer effectively treats stormwater runoff. Effective treatment constitutes capturing runoff from pervious and impervious areas adjacent to the buffer and treating the runoff through overland flow across a grass or forested area. Areas treated in this manner may be deducted from total site area in calculating $WQ_v$ and may contribute to meeting requirements for groundwater recharge.
<b>Grass Channel (Open Section Roads)</b>	Credit may be given when open grass channels are used to reduce the volume of runoff and pollutants during smaller storms. Use of grass channels will automatically meet the minimum groundwater recharge requirement. If designed according to listed criteria, these channels may meet water quality criteria for certain types of residential development.
<b>Environmentally Sensitive Rural Development</b>	Credit is given when a group of environmental site design techniques are applied to low density or rural residential development. This credit eliminates the need for structural practices to treat both $Re_v$ and $WQ_v$ . The designer must still address $Cp_v$ and $Q_{px}$ requirements for all roadway and connected impervious surfaces.

## 2.2 *Volume II – Technical Appendices*

The second volume of the design manual was crafted to support the technical requirements of the first without duplicating information that is readily available from other resources. This paring of support information was necessary to prevent the design manual from becoming unusable because of repetitive information. The decision to include information in this volume was based primarily on availability in existing documents, or the relevance to information within Volume I. After sifting through the massive amount of support information related to stormwater design, four appendices were drafted that contain the minimum information required for the design manual to be self sufficient yet not overly large. These appendices contain information such as landscaping guidance (App. A) and BMP construction specifications (App. B.), as well as step-by-step design examples for each structural BMP group (App. C) and an assortment of tools (App. D) that assist in the design of various stormwater systems. This collection of information is either unavailable in outside sources or intrinsically valuable to the proper design of stormwater management.

## 3. Conclusions

The Environment Article Title 4, Subtitle 2, Annotated Code of Maryland states that “...the management of stormwater runoff is necessary to reduce stream channel erosion, pollution, siltation and sedimentation, and local flooding, all of which have adverse impacts on the water and land resources of Maryland.” The program designed in the early 1980’s to address this finding of the General Assembly concentrated primarily on controlling runoff increases associated with new development. Over the last 18 years, tens of thousands of BMPs have been constructed in order to curb flooding caused by urbanization. Although implementation has not changed, our stormwater management knowledge and experience has continued to evolve since Maryland enacted its stormwater statute. With the experience gained comes the identification of improvements that are needed to fulfill the original intent of this essential water pollution control program.

Conventional development and construction processes are increasingly identified as destructive to the environment, encroaching upon natural areas such as wetlands, stream systems, and forests. These activities also alter local hydrology. Trees and meadow grasses that intercept and absorb rainfall are removed and natural depressions that temporarily pond water are graded to a uniform slope. Cleared and graded sites are often compacted, contributing to the rapid conversion of rainfall into runoff. Impervious surfaces impede groundwater recharge. Pollutants accumulated on these surfaces quickly wash off and are delivered to receiving waters. While stormwater runoff from developed areas adversely impacts water quality, channel stability, and disrupts aquatic life, using environmentally sustainable site design techniques may reduce these impacts.

On October 2, 2000, the Maryland Department of the Environment (MDE) adopted stormwater regulations including the **2000 Maryland Stormwater Design Manual, Vol. I & II** (the Design Manual). Recognizing the demand for environmentally sustainable or “green” development, these regulations represent a more comprehensive approach to stormwater design. Included in this approach are better guidance for total site design and incentives for nonstructural BMPs. The projected outcome of this new program is hoped to be designs that more closely mimic existing hydrology.

While going a long way in promoting sustainable development, the State’s stormwater management program is not the only set of rules that govern development. There are several State and local programs

(e.g., Critical Areas, Forest Conservation, Wetlands Protection) that promote natural resource conservation. There is also the local zoning regulations that govern land development. Although the goal of these diverse programs is to protect the environment, there are instances where green development practices are discouraged and older, less sustainable standards are required.

It is difficult to accommodate the requirements of the full spectrum of resource protection programs. However, the Design Manual recognizes the importance of each and encourages these principles during project design. Accordingly, the State's approach to stormwater design may be summarized as a three-step process: avoidance, minimization, and mitigation. The first step, avoidance, is not just resource protection, but also includes avoiding development practices such as large-scale clearing and mass grading, structural fill, and suburban sprawl that have negative impacts on local hydrology. Any reduction in imperviousness or a site's footprint significantly reduces the amount of stormwater runoff. The second step is minimization. After all options for avoiding impacts are expended, the designer should incorporate practices that either replace or disconnect impervious surfaces. For example, using green roof technology, permeable pavements, or promoting sheet flow will also reduce runoff. After all options to avoid or minimize have been exhausted, the remaining runoff must be treated using structural practices to mitigate water quality and channel stability impacts.

Maryland's stormwater management program is one of many State and local programs that regulate land development. However, the three-step philosophy inherent in the Design Manual incorporates many of these other programs in its approach. This philosophy refocuses design from the structural management of runoff as an afterthought to the mimicking of natural processes as part of a total site design.

The Design Manual could never have been produced without the talents, experience, and hard work of the many people involved in the project. The Maryland Department of the Environment, Water Management Administration would like to acknowledge those individuals who helped in this process. In particular, Tom Schueler, Richard Claytor and the staff of the Center for Watershed Protection as well as their project team partners, Environmental Quality Resources, Inc. and Loiederman Associates, Inc. for their dedication and efforts. Thanks are also extended to the members of the Stormwater Management Regulations Committee whose insightful comments and local perspective were helpful in improving the manual. Finally, the staff of MDE/WMA's Nonpoint Source Program for the patience and support necessary to complete the project successfully.

#### **4. References**

MDE, 1987

Design Procedures for Stormwater Management Extended Detention Structures  
Report to Water Resources Administration, 1987

Rawls, W.J., Brakensiek, D.L., and Saxton, K.E., 1982  
"Estimation of Soil Properties"

Transactions of the American Society of Agricultural Engineers, Vol. 25, No. 5, pp.1316-1320, 1982

Schueler, T., Claytor, R. et al, 2000.

2000 Maryland Stormwater Design Manual, Volumes I & II  
Maryland Department of the Environment, April 2000.

## **ENHANCING STORM WATER INFILTRATION TO REDUCE WATER TEMPERATURE DOWNSTREAM**

Joseph M. Dorava, Vierbicher Associates, Inc.  
Aircardo Roa Espinosa, Dane County Land Conservation Department  
Ken Johnson, Wisconsin Department of Natural Resources  
Daryl Severson, City of Sun Prairie

A substantial storm water management project was recently completed in the city of Sun Prairie, about ten miles east of Madison, Wisconsin. The primary goal of this project was to protect the water quality of Token Creek, one of the last remaining cold-water trout streams in south central Wisconsin.

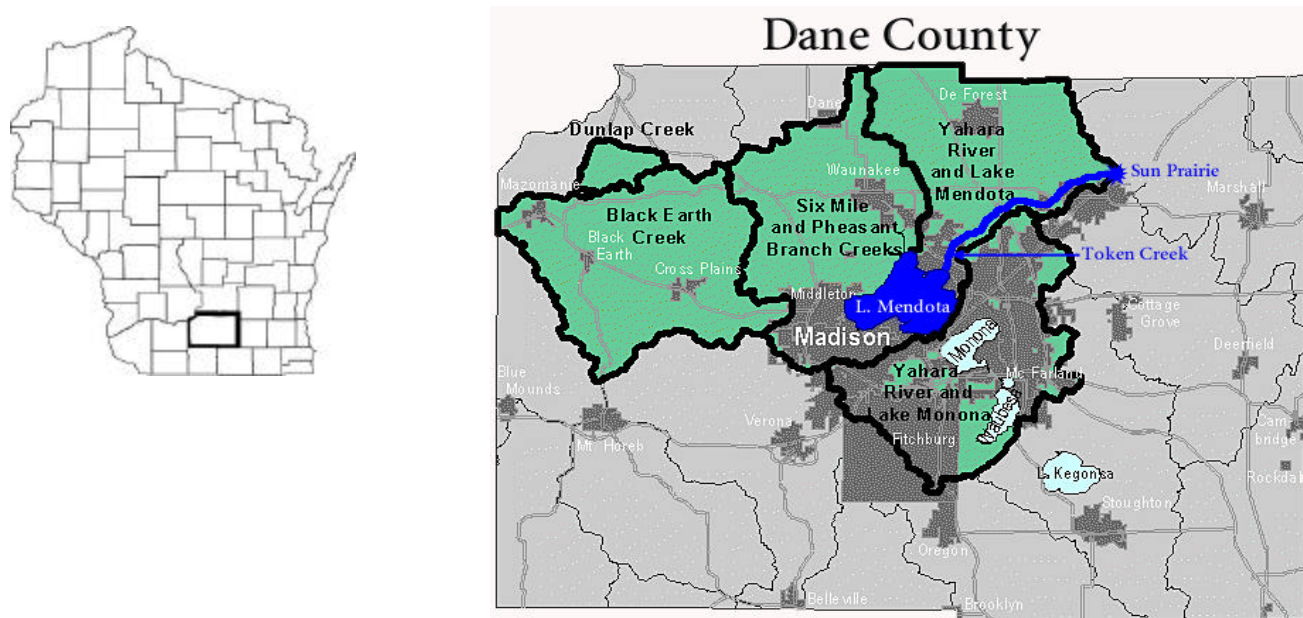
Reducing the downstream movement of sediment and preventing excessive heating of the runoff were two challenges faced in this project. A team of engineers and scientists from the city of Sun Prairie, the Wisconsin Department of Natural Resources, Dane County's Land Conservation Department, and Vierbicher Associates, Inc., joined forces to meet the goals of this project. This team designed and built a series of stone-filled gabion weirs to filter sediment, and they engineered a stone-lined channel to infiltrate runoff into the ground.

State funding earmarked for the reduction of non-point source pollution supported this project. The outcome being a system which treats storm water runoff from more than 492 acres of new residential development. Enhanced infiltration provided by the stone-lined channel is designed to reduce stream water temperatures by moving the surface runoff under ground. The gabion weirs are designed to remove sediment from the streamflow by trapping large particles and filtering smaller ones. The capability of this storm water treatment system to reduce stream temperature was designed with a site-specific thermal model. The substantial accumulation of sediment upstream from the gabions indicates the systems ability to treat storm water runoff. The system's design and functionality, along with its aesthetic appearance in a densely developed subdivision, demonstrate its success in suburban Sun Prairie. Because infiltration is becoming more important as a storm water management practice, this treatment strategy may have applications wherever development occurs.



## Introduction

The Token Creek Watershed is a 27 square-mile sub basin of the Yahara-Lake Mendota Priority Watershed in south central Wisconsin, on the northeast side of Madison, immediately adjacent to the city of Sun Prairie (Figure 1). This watershed supported a native brook trout fishery prior to European settlement (Sorge, 1996). Today, natural springs, which discharge more than 4000 gallons per minute of 50-degree Fahrenheit water to Token Creek, continue to support a cold-water fishery (University of Wisconsin, 1997, Wisconsin Department of Natural Resources Unpublished Data). Development around the city of Madison and especially the outlying areas near Sun Prairie is increasing. The result is increased pressure to build near wildlife habitat areas and watersheds that support such fisheries. The challenge then is to create development that is compatible with the surrounding environment and to develop in ways that minimize degradation of natural resources.



**Figure 1.** Location of Dane County, Wisconsin, and Token Creek in the Yahara River and Lake Mendota Priority Watershed. The proximity of Token Creek to the growing cities of Madison and Sun Prairie increases the demand for development in the watershed. The importance of the cold-water fishery in Token Creek and the priority designation of downstream lakes create a regulatory agency emphasis on protecting water quality. Map modified from Dane County, <http://www.co.dane.wi.us/landcopnservation/pwshed.htm>.

## Background

Regulatory agencies realize the importance of the natural resources and they understand the value of limiting sediment inflow and water temperature increases to an urbanizing stream that also supports a cold-water fishery. As a result, proposed developments in the Token Creek Watershed are closely scrutinized for their contributions of non-point source pollution. In addition, there is a regulatory emphasis placed on managing water temperature increases and there are no concise compliance standards, documented best management practices (BMPs), or design manuals to rely upon or use as targets. Therefore, biologists and engineers commonly use professional judgement, personal experience, and modeling to predict the outcome of various management practices.

In the case of Token Creek, where there were benefits to protecting the creek for, the participants were quite cooperative. For example, the developer for the residential subdivision generously donated land along Token Creek tributary drainageways to the city of Sun Prairie so it could be managed in the public interest. The developer realized benefits from protecting Token Creek if home site and property values are higher as a result of the attractive storm water management features in the dedicated public lands and a viable cold-water fishery downstream. Furthermore, the city of Sun Prairie will benefit from an increased tax base of the higher home values. Regulatory agencies also benefit because enhanced protection of the natural resources is one of their primary directives.

### ***Purpose and Scope***

Token Creek is part of the Yahara-Mendota designated Priority Watershed Project, which aims to reduce sediment and nutrient flows into Lake Mendota. This designation and the creek's high value as a cold-water fishery, prompted the State of Wisconsin's Department of Natural Resources, (WiDNR) to award a Non-Point Source Pollution Abatement Program cost-share grant to the city of Sun Prairie to design and install BMPs in the Token Creek Watershed. In support of the Priority Watershed Program, Dane County's Land Conservation Department is working with the agricultural industry to ensure that agricultural BMPs are installed throughout the watershed to reduce sediment inflows to the lake. The Land Conservation Department is also developing a model to predict the effects of land-use change on water temperature and to predict the change in water temperature derived from various land-management practices. The resources at Dane County and the WiDNR assisted the city of Sun Prairie and their engineering consultant, Vierbicher Associates Inc., with the design of BMPs to reduce the movement of sediment and heated runoff to Token Creek.

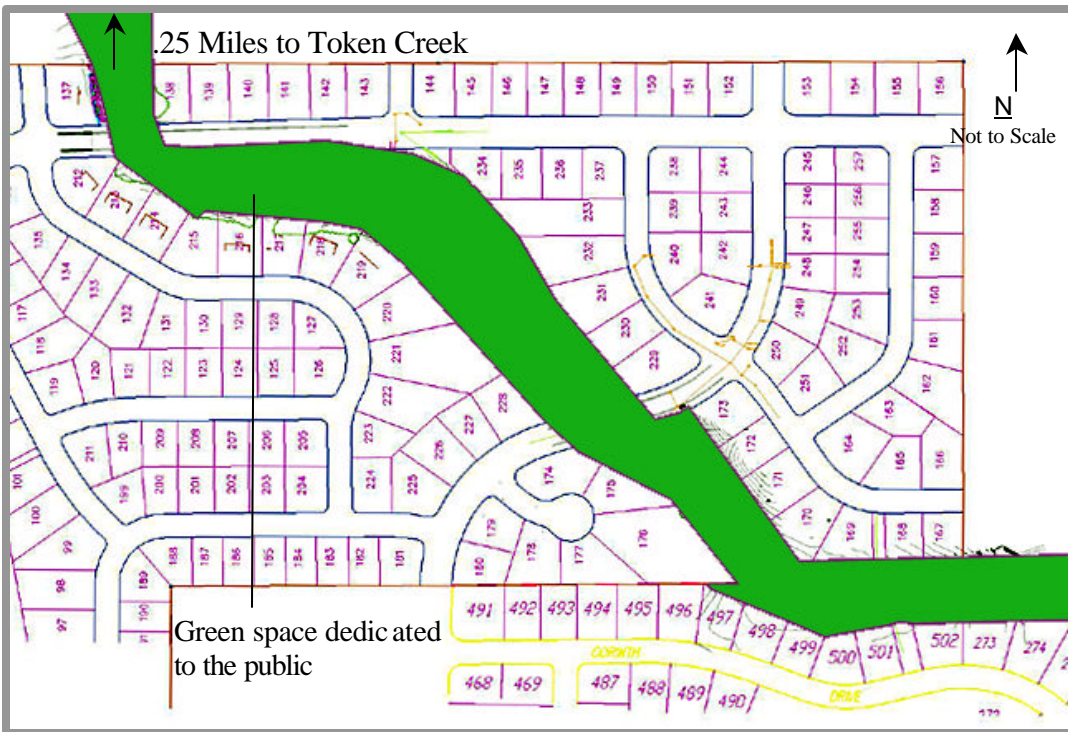
The cost-share grant from WiDNR supported design and construction of BMPs in a proposed 492-acre residential subdivision along a tributary to Token Creek. Dane County provided design recommendations based on their experience with agricultural practices in the area and results of detailed temperature modeling. Vierbicher Associates provided engineering design and construction plans. The city of Sun Prairie supervised design and construction of the project and the WiDNR and Dane County provided regulatory agency oversight. The two primary goals of the project:

- To protect the water quality of Token Creek (primarily by controlling sediment inflow and water-temperature increases)
- To provide BMPs that are attractive and improve property values

The purpose of this paper is to describe the Token Creek Water Quality Control Project and the design process used to select BMPs for this project. Primarily because the project provides an introduction to relatively new storm water management techniques (rock-filled gabion dams and rock-lined channel storm water infiltration), and a new engineering tool (water temperature modeling). These new techniques and tools provide protection against non-point source pollution, in addition to mitigating thermal impacts from storm water runoff. Both the project's design process, including the new engineering techniques and tools and the project's unique BMPs, should have broad applications in urban storm water management. The project also provides valuable examples of cooperation between adjacent city governments, regulatory and funding agencies, and design professionals.

## BMP Selection

The proposed 492-acre single-family development was planned to include about 15 acres of green space along the tributary drainageways to Token Creek and the remaining land converted to approximately 0.25-acre residential lots (Figure 2). Each lot was planned to contain a 3-bedroom home (2,500 square feet) and a 2-car garage (480 square feet). This lot configuration results in about 4,400 square feet of total impervious surface if an allowance of 900 square feet is made for roads and 520 square feet is allowed for driveways, and sidewalks. The result of this development is an alteration of land use from 100 percent open-pastureland and forest to about 34 percent impervious area.



**Figure 2.** Proposed single-family residential development in the watershed of a tributary to Token Creek. Of the approximately 492-acres proposed for development, 15-acres will be dedicated to the public as green space and the remaining land will be subdivided into approximate 0.25-acre lots.

The result of this type of land-use conversion typically is an increase in runoff and a substantial increase in peak discharge, severe streambank erosion, and degradation of water quality including elevated water temperatures. Common BMPs available to address these concerns would include storm water detention ponds, streambank reinforcement, and created wetlands. Principal concerns with these common BMPs as a result of a cold-water fishery less than 0.25 miles downstream include storing and ponding water that would potentially increase the water temperature and unsightly wetland areas that might attract mosquitoes. The city of Sun Prairie as the supervisor of design and construction and the regulatory agencies within their review capacity both understood the need to closely coordinate this project. Early in the design process consultations with regulatory agency staff resulted in considerable efficiencies in the design. For example, in headwater areas where wetlands prevail along the drainageway, consideration of the need to infiltrate runoff and preserve wetlands resulted in agreement on selection of an erosion control mat for stream bank stabilization instead of rock lining. In addition, the agreement between engineers and regulators to place rock dams near planned or existing roadway and bike path embankments minimized the disturbance to the

site by concentrating fill materials and provided for easy maintenance of the storm water management system. The common acceptance of the need to mitigate water temperature increases in Token Creek among designers and reviewers brought together a team of engineers and scientists that otherwise would be working independently. The design process, techniques, and tools this team used to complete this one project are now complementary items in new countywide storm water management and erosion control ordinances, Statewide model ordinances, and the daily practice of the individual engineers and scientists involved in the project. One of the most important new engineering tools is the application of a temperature model developed during the project.

### ***Temperature Modeling***

A Temperature Urban Runoff Model (TURM) was developed and tested in Dane County, Wisconsin, to predict the thermal impact of proposed development projects (Arrington et al., 2002, Roa-Espinosa, 2003). A number of sample model runs are presented here to help understand how several variables interact to result in the stream temperatures predicted by the model. Three of the important variables that determine stream temperature as a result of a storm are:

- the percentage of impervious area of the parcel,
- the parcel area and
- the baseflow of the stream that the parcel drains into.

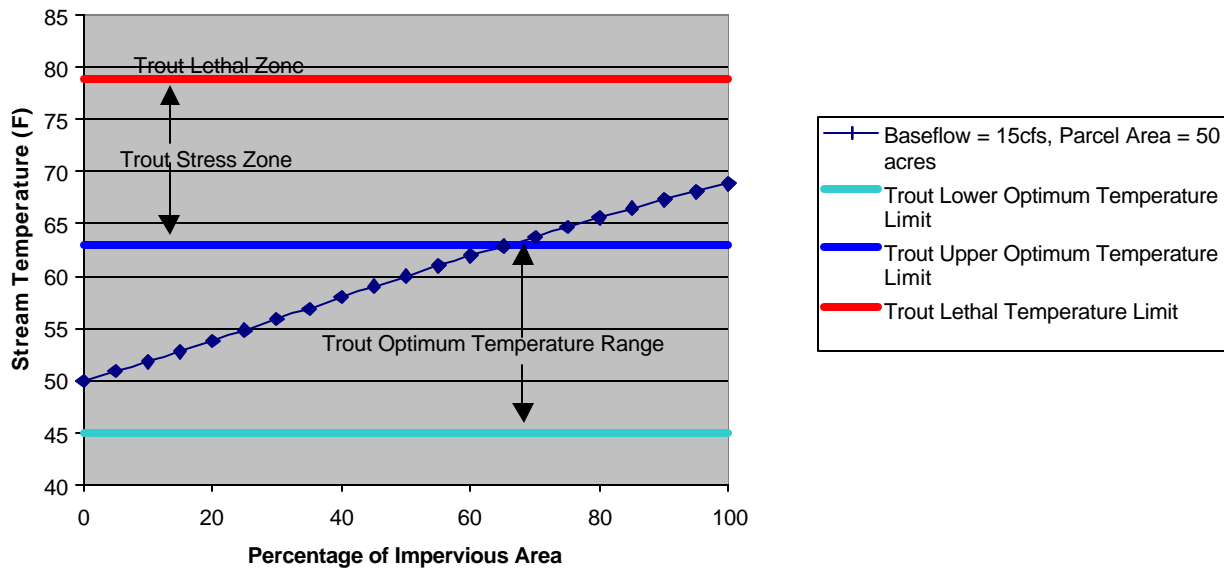
### **Percentage of Impervious Area and Water Temperature**

Impervious surfaces, such as pavement or asphalt, increase stream temperature for two reasons. First, impervious surfaces absorb solar radiation, which raises their surface temperature. When it storms, some of this heat is transferred to the water that falls on these surfaces as precipitation. Second, impervious surfaces reduce infiltration, which increases the runoff volume from these surfaces. (Pervious surfaces, like grass or other vegetation, allow some of the precipitation that falls on them to infiltrate into the soil.) As the percentage of impervious area of a parcel increases, more of the total runoff from the parcel comes from the heated runoff contributed by the impervious surfaces. Therefore, as percentage impervious area increases, the temperature of the water runoff from the parcel increases and the temperature of the stream that the runoff enters increases as well.

Because there are some significant seasonal variations in storms and their effect on water temperature the model uses a typical summer rainstorm event in Dane County to predict water temperature changes. The assumed storm and local environmental conditions accompanying the storm event are described in Table 1.

**Table 1.** Typical storm and environmental conditions assumed for mid-summer storms in Dane County, Wisconsin from TURM predictions.

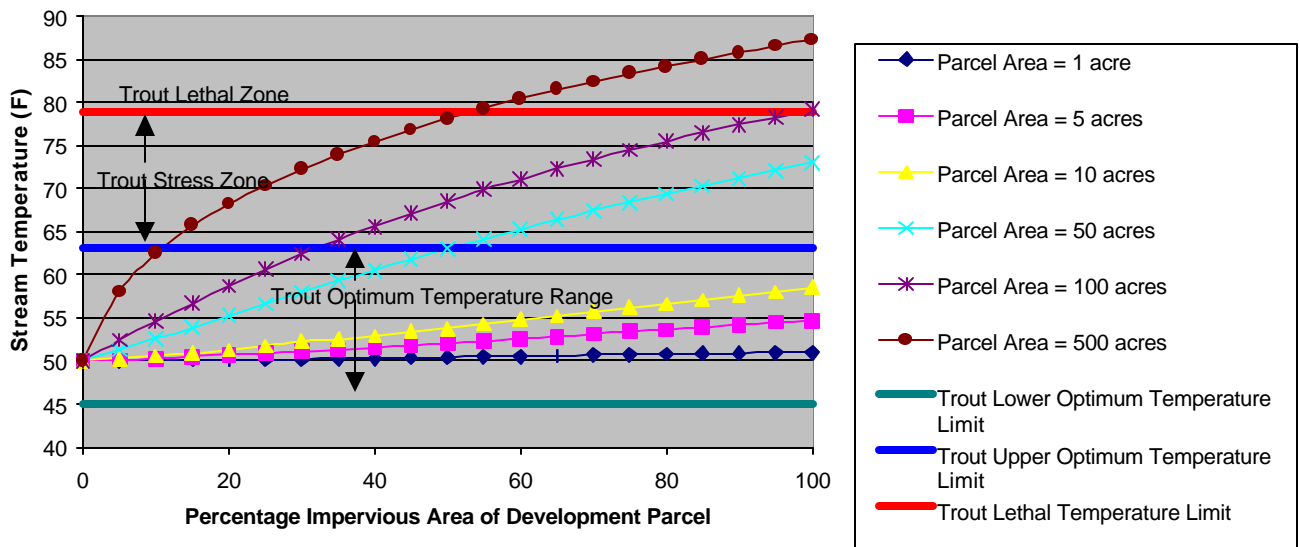
rainfall depth	0.5	inches
rainfall duration	4	hours
hour of day rain start (between 1 and 24 hours)	14	
Time of concentration (Tc)	0.100	hours
wind speed	10.2	ft/s
rain temperature (during storm)	73.7	F
Initial temp. of impervious surface	93.6	F
Air temperature	80.0	F
Relative humidity	80.0%	



**Figure 3.** There is an increasing trend in stream temperature with increasing percentage impervious area for a given parcel area and baseflow. Baseflow is given in cubic feet per second (cfs).

**Parcel Area and Water Temperature**

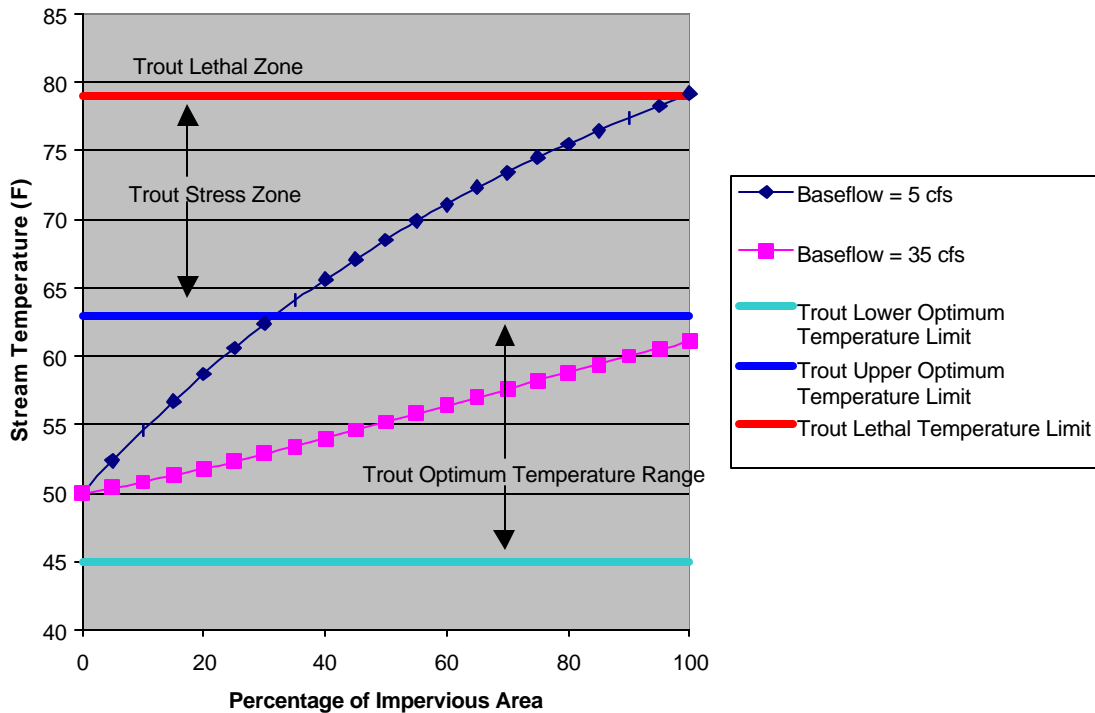
In general, at a given percentage of imperviousness, the larger the parcel area, the more runoff it contributes to the stream. More heated runoff means greater stream temperature increases resulting from a storm.



**Figure 4.** For a given percentage of impervious area and a given baseflow, the greater the parcel area, the greater the stream temperature.

### Baseflow and Water Temperature

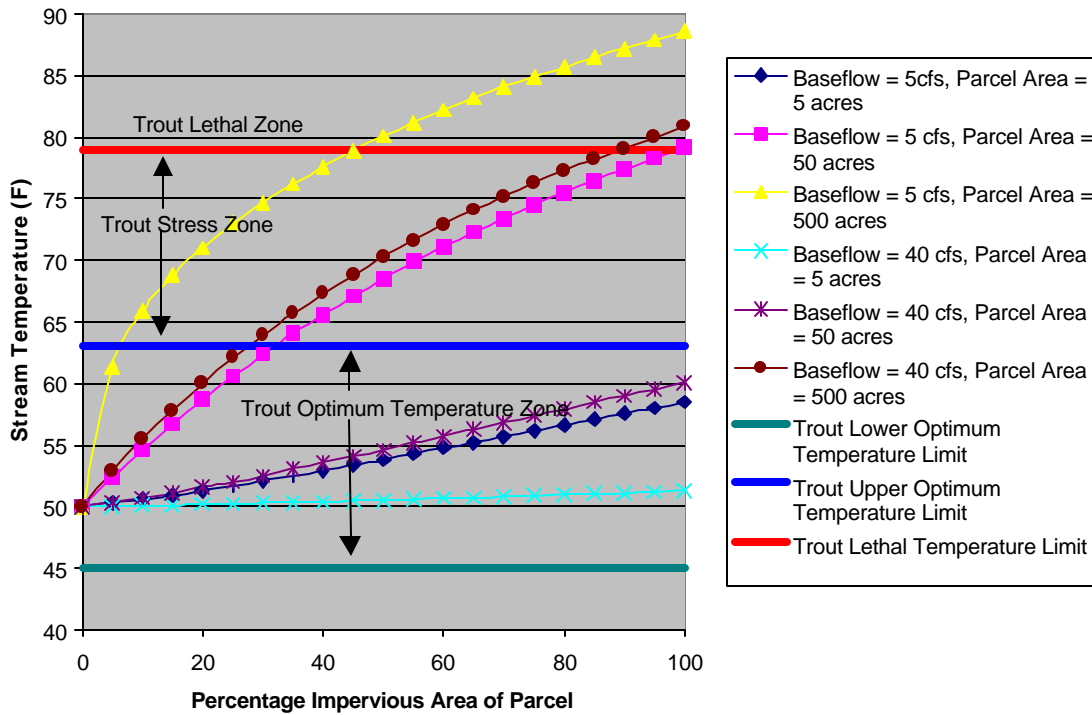
Baseflow is the flow rate (volume of water per unit time) of a stream before a storm. Typically small baseflow is found on small streams and tributaries, whereas large baseflow is found on larger streams. Stream temperature resulting from a storm is a mixture of the initial stream temperature and the runoff temperature. At a given volume of heated runoff (determined from the parcel area and the percentage imperviousness) there is a greater stream temperature increase in a stream with a small baseflow than a stream with a large baseflow. This is because the runoff volume is a greater proportion of the stream volume in a small baseflow stream than a large baseflow stream.



**Figure 5.** For a given parcel area and a given percentage of imperviousness, higher stream temperatures are found in streams with smaller baseflow and lower stream temperatures are found in streams with larger baseflow. Baseflow is given in cubic feet per second (cfs).

### Watershed Characteristics and Water Temperature

Understanding the inter-relation between watershed characteristics and water temperature elucidates opportunities to manage development or mitigate the effects of development in a watershed (Figure 6). For this developing tributary watershed to Token Creek, which generally has a larger parcel area (492-acres) and a lower base flow about (9 cubic feet per second), mitigating increases in stream temperature and reducing the movement of sediment to the creek were common goals of the developer, the city, and the regulatory and funding agencies. Because additional single-family housing is in high demand in this area mitigating the potential harmful effects of development was more desirable than reducing the size or number of housing units developed.



**Figure 6.** The relative trends of how stream temperature varies with percentage impervious area for different combinations of parcel areas and baseflow. For small parcels and large baseflow, there is little thermal impact to the stream, regardless of the percentage of impervious area. On the other hand, large parcels that drain into a stream with a small baseflow cause a substantial stream temperature increase, even at relatively low percentages of imperviousness. Baseflow is given in cubic feet per second (cfs).

A 21.6-degree F increase in stream temperature is predicted to result from the proposed development in this Token Creek Tributary watershed by the TURM (Table 2). The resulting water temperature of 71.6 degrees F is above the stress zone for trout and, thus, is undesirable. Therefore some temperature mitigating management practices are necessary.



**Table 2.** For a given rainfall event a temperature increase of 21.6 degree F is predicted to result from the proposed development in this tributary to Token Creek.

## Temperature Urban Runoff Model POST-DEVELOPMENT

Units:

**Required Inputs:**

% Connected imperviousness in watershed	<input type="text" value="34%"/>	
Watershed area	<input type="text" value="492.00"/>	acres
Base flow in stream	<input type="text" value="9.0"/>	cfs
Existing stream temp.	<input type="text" value="50.0"/>	°F

**Outputs:**

Temp. of runoff from development	<input type="text" value="93.8"/>	F
Difference between runoff and stream temp.	<input type="text" value="43.8"/>	F
Temp. of stream after development	<input type="text" value="71.6"/>	F
Increase in stream temp.	<input type="text" value="21.6"/>	F

The model runs described here represent the relative thermal impact of various development scenarios if heated runoff has little opportunity to cool before entering a stream. The combinations of percentage of impervious area, parcel area, and baseflow do not necessarily have the impact shown above if temperature reduction practices are used to mitigate the thermal impacts of development. The two basic principles behind thermal reduction practices are to slow down heated runoff on its way to the stream (to give it time to cool) and to increase infiltration of heated runoff (to reduce the volume of heated water that reaches the stream). Some useful temperature reduction practices include rock cribs, thermal swales, and retention/infiltration area.

In this development a treatment train was proposed where storm water runoff was collected in the streets and developed lots and directed to the existing drainageway. In the most headwater areas where the drainageway was poorly defined, an erosion mat was used to stabilize the channel and rock-check dams slowed the water and enhanced infiltration (Figure 7).



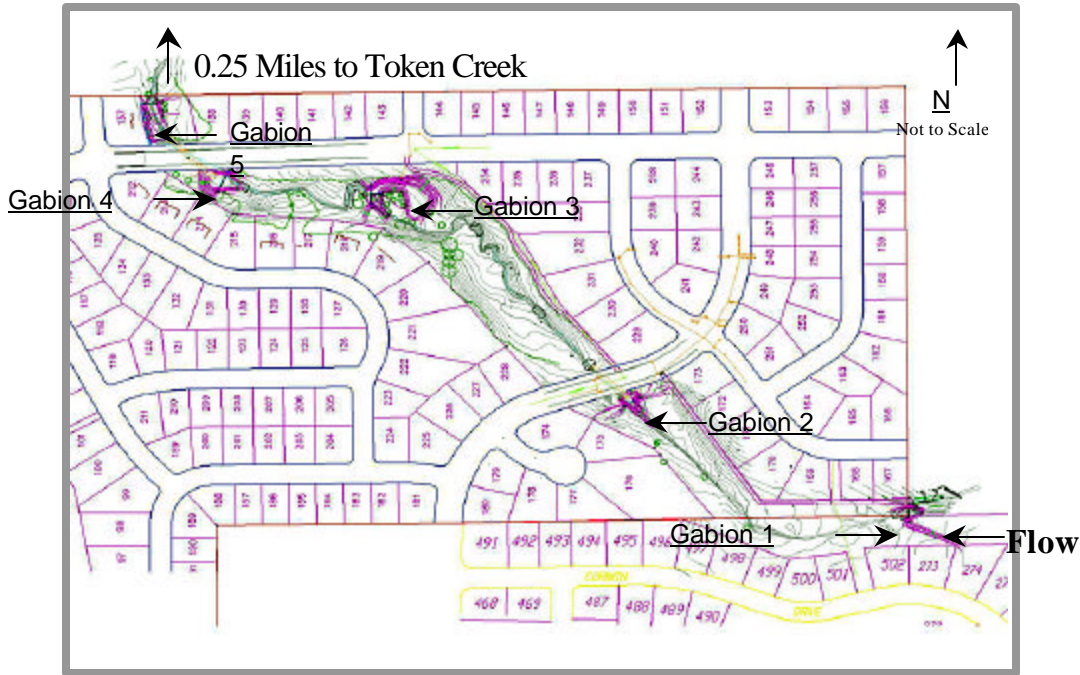
**Figure 7.** Erosion control matting and a rock check dam combine to reduce stream channel erosion and enhance storm water infiltration in developed headwater areas.

In areas where runoff is concentrated into a defined channel, a rock lining was used in the channel to protect the streambank from erosion, to dissipate heat by contact, and to more rapidly infiltrate the runoff below the surface (Figure 8). Rock-filled gabion dams were installed along the drainageway where flow was restricted by a roadway or bike path embankment. These rock dam sites were also used for maintenance access as considerable debris and sediment accumulated upstream from these structures (Figure 8).



**Figure 8.** A rock lined channel provided rapid infiltration of runoff, substantial heat dissipation, and near complete control of channel erosion. Rock-filled gabion dams located near channel restrictions provided easily accessible maintenance sites. Sediment and debris that accumulated upstream from the dams could be readily removed in these areas. The rock dams filtered large sediment and debris, slowed the flow of water, and dissipated heat.

The treatment train strategy implemented in the Token Creek Water Quality Project included a total of 3,055 feet of channel reinforcement and five gabion-dam structures (Figure 9). TURM predicted an increase in water temperature of only 10.7 degrees F as a result of the planned development following installation of the storm water BMPs (Table 3).



**Figure 9.** A storm water treatment train that included five gabion dams and 3,055 feet of channel reinforcement was installed along this tributary to Token Creek to mitigate water temperature increases and reduce stream bank erosion.

**Table 3.** TURM predicted the water temperature in Token Creek would be 60.7 degrees F following the development of a 492-acre single-family residential area once BMP's designed to mitigate for water temperature increases were in place. The increase in water temperature of 10.7 degrees F relates back to the 9-cfs baseflow from the springs that had a temperature of 50 degrees F.

## Temperature Urban Runoff Model POST-DEVELOPMENT

### Temperature Reduction Practices:

<input checked="" type="checkbox"/> stone bed/basin	40000 cubic feet, 6 inch stone
Temperature outletting practices:	<input style="width: 80px;" type="text" value="66.5"/> °F
Temperature of stream after practices	<input style="width: 80px;" type="text" value="60.7"/> °F
Increase in stream temp. after practices	<input style="width: 80px;" type="text" value="10.7"/> °F

## Conclusions

The Token Creek Water Quality Control Project positively affected the water quality of the creek. The project also demonstrated the success of close working relationships among designers, regulatory and funding agencies, and contractors. Everyone, including the developer, supported the project's emphasis on mitigating thermal impacts and controlling the downstream movement of sediment. The rapid and profitable sales of homes in the subdivision demonstrate the project's acceptance by the public. The lack of streambank erosion and the accumulation of debris and sediment upstream from the rock-filled gabion dams indicate adequate performance of the project's erosion control features. Although not supported by a post-construction monitoring program at this site, a healthy cold-water fishery downstream in Token Creek indicates the relatively new TURM may be providing useful guidance to designers. Although specifically developed for Dane County Wisconsin, this temperature model, the temperature mitigating BMP's, and the design process used on this project may have applications much wider than the local area. More details of the TURM are also presented in these proceedings (Roa-Espinosa, 2003). Additional documentation of the TURM and guidance for its use can be found on the Dane County WWW page at "<http://www.co.dane.wi.us/landconservation/thmodelpg.htm>". Additional examples of similar BMP's and projects are also available by contacting any of the authors.

## References Cited

Arrington, K.E., Roa, A., and Norman, J., 2002. Understanding Thermal Impact, A GIS Web Tool For Users (unpublished www document) <http://www.co.dane.wi.us/landconservation/thmodelpg.htm>

Dane County Land Conservation, 2002. (Unpublished www document) <http://www.co.dane.wi.us/landcopnservation/pwshed.htm>

Roa-Espinosa, Aircardo, 2003. Predicting the Impact of Urban Development on Stream Temperature Using TURM (Temperature Urban Runoff Model): A National Conference, Urban Storm Water: Enhancing Programs at the Local Level, Chicago, Illinois, 2003, Proceedings, Environmental Protection Agency

Sorge, M. 1996. Lake Mendota Priority Watershed Resource Appraisal Report, Wisconsin Department of Natural Resources

University of Wisconsin, 1997. Water Resources Atlas Token Creek, A Water Resources Management Study: Institute for Environmental Studies, University of Wisconsin, Madison, Wisconsin, 140 p.

# LOCAL SOLUTIONS TO MINIMIZING THE IMPACT OF LAND USE CHANGE

Kyle Dreyfuss-Wells  
Chagrin River Watershed Partners, Inc.  
Willoughby, Ohio

## Abstract

This presentation introduces the Chagrin River Watershed Partners, Inc., (CRWP) discusses why local decision makers joined the organization, and presents recommendations for minimizing the impact of land use change. The paper concludes with a discussion of CRWP's implementation of these recommendations through two active program areas - assisting member communities with zoning regulations for riparian setbacks and compliance with USEPA's Phase II NPDES Storm Water Program. The paper provides examples of how local communities in the Chagrin River watershed have implemented CRWP's recommendations and are using their required compliance with Phase II as an opportunity to address issues of local importance.

## Chagrin River Watershed Partners

### *Formation & Membership*

CRWP is a non-profit educational and technical organization formed by watershed communities to address concerns over flooding, erosion, and water quality problems. Since its formation in 1996, CRWP has grown to represent 30 townships, counties, cities, and park districts, approximately 80% of the Chagrin River watershed. Each community selects a trustee to CRWP, either a council member, mayor, or township trustee. These individuals form our Board of Trustees and direct our member services and watershed studies. With its unique structure, CRWP works directly with elected officials and their engineers, law directors, and other professional advisors.

Communities joined CRWP due to concerns over rising infrastructure costs and threats to public and private property created by the loss of natural resource functions and subsequent increases in flooding, erosion, and water quality problems.

CRWP's structure enables the organization to work directly with communities to update comprehensive plans, zoning ordinances, and other programs guiding land development, and to introduce innovative practices that prevent or minimize flooding, erosion, and water quality problems. Building on its relationships with communities, CRWP is also uniquely positioned to assist members with their NPDES Phase II compliance.

### *The Watershed*

The Chagrin River watershed drains approximately 265 square miles northeast of Cleveland, Ohio. The Chagrin watershed, like most of Northeast Ohio, was shaped by glacial activity. Many areas of the watershed, particularly along its steep hillsides and stream banks contain loose sand and gravel that naturally erode at a high rate. Other areas of the watershed have clay soils that do not easily absorb water, allowing much of the rainfall and snowmelt to

runoff quickly. As a result of this glacial past, the Chagrin River watershed has varied topography and naturally high rates of both flooding and erosion.

The Chagrin, a Lake Erie tributary, is recognized statewide as a high quality resource with State Scenic River designation from the Ohio Department of Natural Resources (ODNR) on all of its five (5) branches. Several of the Chagrin's tributary streams support Coldwater Habitat (CWH) aquatic life use designations from the Ohio Environmental Protection Agency (Ohio EPA). CWH use designation applies to waters that support assemblages of coldwater organisms. The portions of the Chagrin supporting CWH are primarily small tributaries of the Main Stem and the Aurora Branch, several of which support breeding populations of Ohio Brook Trout (*Salvelinus fontinalis*). CWH is considered among the highest quality aquatic habitat in Ohio and the Chagrin River watershed is unique for the extent of this high quality habitat so close to a major urban area. (Ohio EPA, 1997)

Other portions of the Chagrin River are designated as Warmwater Habitat (WWH). WWH use designation defines a typical warmwater assemblage of aquatic organisms. WWH is the principal restoration target for the majority of water resource management efforts in Ohio and waters with this designation are considered to be in generally good health. (Ohio EPA, 1997)

Ohio EPA's most recent sampling data on the Chagrin in 1994, 1995, and 1996 places the River on the Agency's 303(d) list of impaired streams (Ohio EPA, 2002). A Total Maximum Daily Load (TMDL) study of the Chagrin is scheduled for 2006. This sampling data also indicates that many reaches of the Chagrin are not meeting their CWH or WWH aquatic life use designations. The principal causes of impairment and non-attainment in the Chagrin are hydromodification, sedimentation, and pollution from urban storm water runoff; nutrient enrichment from failing home sewage treatment systems and suburban lawn care; sedimentation from streambank erosion and poorly controlled construction sites; riparian encroachment from land use changes, and the filling and draining of wetlands. In 2002 CRWP completed a study of wetland loss in the watershed, estimating both historic and current wetland acreage using available digital data. Our initial estimates place wetland loss at approximately 80%. Adequate restoration and mitigation for the assimilative capacity of these lost wetlands has not been completed within the watershed.

### ***Problems Causing Local Decision Makers to Act***

Land use and the problems associated with unmanaged development form the common theme among the watershed problems highlight above. Development increases both the flow and velocity of storm water runoff and, with the exception of nutrient pollution due to home sewage treatment systems, the water quality problems of the Chagrin River watershed are due to increases in water quantity. The current land use practices in the Chagrin have caused a variety of flooding, erosion, and water quality problems. These concerns are seen in Ohio EPA's sampling data as well as in watershed wide and localized flooding and erosion. These problems cost local governments and residents as they must clean up from flooding, rebuild threatened or damage roads and bridges, and protect homes and infrastructure from flooding and eroding streams.

Current land use practices cause flooding, erosion, and water quality problems in two ways, both of which are linked to increases in water quantity. Traditional land use planning, the guide for a community's long-term development, does not account for the amount and functions of floodplains, wetlands, and open spaces that naturally control water quality and quantity. As a result, communities and developers are not aware of these

resources and they are lost when land is developed. Traditional land use practices then compound this loss of natural resource functions by increasing impervious cover. Impervious cover includes roads, rooftops, driveways, lawns, and other surfaces that do not absorb storm water, and impervious cover increases both the volume and velocity of storm water runoff. The result of these two impacts of current land use practices is that as the cause of the flooding, erosion, and water quality problems - impervious cover - grows, the ability of floodplains, wetlands, and open spaces to control these problems declines.

***Our Recommendations for Solving Problems in the Watershed***

Faced with a high quality natural resource experiencing the stresses of land use change but not yet in need of significant remediation, the communities in the Chagrin River watershed have a unique opportunity to implement innovative, prevention focused solutions to minimize the impacts of development. To assist member communities in capturing this opportunity, CRWP has developed a series of recommendations on minimizing the impacts of development. These recommendations are based on the following three (3) principles:

**1. Natural resources provide services:** Wetlands, riparian areas, and other natural resources provide flood control, erosion control, and water quality protection services. Table 1 summarizes the services provided by wetlands and riparian areas.

**Table 1: Health & Safety Benefits of Wetlands and Riparian Areas.**

Wetlands	Riparian Areas
<b>Reduce peak flood flows:</b> by storing flood waters and maintaining stream flow patterns.	<b>Reduce flood impacts:</b> by absorbing peak flows, slowing the velocity of flood waters, and regulating base flow.
<b>Minimize streambank erosion:</b> by reducing runoff volume and velocity.	<b>Stabilize stream banks:</b> to reduce bank erosion and the downstream transport of sediments eroded from stream banks.
<b>Protect ground water quality:</b> by filtering pollutants from storm water runoff.	<b>Reduce pollutants in watercourses:</b> by filtering, settling, and transforming pollutants in runoff before they enter watercourses.
<b>Recharge groundwater reserves:</b> by allowing water to filter into the ground.	
<b>Maintain surface water quality:</b> by minimizing sediment pollution from streambank erosion, and trapping sediments, chemicals, salts, and other pollutants from flood waters and storm water runoff.	

**2. Prevention is cheaper than remediation:** Preventive steps to maintain the services of natural resources cost less than remedial actions to recreate these services.

**3. Local governments have a role:** Actions to maintain these services are matters of public health and safety and are within local government authorities.

Building on these principles, we recommend that each member community have the following:

**Comprehensive planning:** Regular planning that incorporates natural resource management and catalogs natural resource health and safety benefits.

**Riparian and wetland setbacks:** Limits on soil-disturbing activities around wetlands and streams. To support the implementation of this recommendation we have model ordinances for wetland setbacks and riparian setbacks.

**Erosion and sediment control:** Regulations to minimize erosion on construction sites with strong inspection, enforcement, and maintenance requirements. To support the implementation of this recommendation, we worked with the local soil and water conservation districts to develop a model erosion and sediment control ordinance.

**Storm water management:** Policies and ordinances that require and provide incentives for nonstructural practices. To support the implementation of this recommendation, we have developed a model storm water management ordinance that encourages the use of nonstructural storm water management activities.

**Options and incentives:** Programs to encourage alternative site designs to reduce impervious cover and the creation of storm water runoff.

**Assistance and acquisition:** Provide tools to interested landowners on natural resource management and acquisition of critical areas.

In reviewing these recommendations, it is important to note that the specific tools used by a community to prevent or solve natural resource management problems vary with a community's level of development. Less developed communities have a wider range of preventive measures, such as wetland and riparian setbacks, available to them than communities in more developed areas of the Chagrin River watershed. As the amount of impervious cover increases in a community, solving problems requires more costly retrofit solutions. In areas where land use is intense, communities can expect to spend hundreds of thousands of dollars to solve flooding and erosion problems and to restore the services of natural resources.

Much of our work is focused on assisting members to implement the above recommendations. To date, these recommendations have been implemented as follows:

**Comprehensive planning:** The Village of Moreland Hills, Russell Township, and the City of Aurora have included natural resource inventories in their comprehensive planning efforts.

**Riparian and wetland setbacks:** The Cities of Aurora and Kirtland, the Villages of Hunting Valley and Chagrin Falls, and Russell Township have adopted riparian and wetland setback zoning regulations. The Village of Gates Mills, Bainbridge Township, and Lake County are considering such regulations.

**Erosion and sediment control:** The City of Kirtland and Lake County have adopted CRWP's model for improved erosion and sediment control.



**Storm water management:** Russell Township and the Village of South Russell have adopted alternative site design criteria including limitations on impervious cover and provisions for natural landscaping in common open spaces.

**Acquisition:** The Villages of Chagrin Falls, Hunting Valley, Gates Mills, the Cities of Eastlake and Kirtland, and the Townships of Bainbridge and Russell have active land acquisition programs for permanent open space.

The remainder of this paper details our efforts to promote one of these recommendations, riparian setbacks, and highlights the linkages between our recommendations and compliance with the Six Minimum Control Measures of the NPDES Phase II Storm Water Regulation.

### ***Riparian Setbacks***

Riparian refers to the streamside area, or the floodplain, of a watercourse. If appropriately sized, riparian areas can provide flood control, erosion control, and water quality protection services. These services come from the ability of riparian areas to slow storm water flow, and slowly release this flow to watercourses. The protection of riparian areas is important to maintain these services. There are several ways that communities can maintain riparian areas, including:

**Direct landowner assistance:** Working with interested landowners on the proper maintenance of their backyard streams is important to maintaining riparian functions on developed parcels. The Chagrin River watershed is fortunate to be served by excellent soil and water conservation districts as well as various state agencies available to assist interested landowners. This approach, however, only reaches interested landowners and does not provide communities with a mechanism to ensure riparian functions are maintained.

**Land acquisition:** As mentioned above, many Chagrin River watershed communities have chosen to acquire, either through conservation easements or direct purchases, critical riparian lands. The Chagrin River watershed benefits from the highly sophisticated work of the Chagrin River Land Conservancy to assist communities with land acquisition. While this approach provides direct community control over riparian functions, it is neither realistic nor desirable for a community to keep all land as open space.

**Zoning:** Communities may also maintain riparian area functions through land use controls in their zoning codes that limit development within certain distances of watercourses. CRWP has focused its efforts in this area and developed a model riparian setback ordinance tailored to the specific concerns of member communities. The details of this model are presented below.

### ***Model Riparian Setback Ordinance***

Riparian protection has historically been a contentious issue in Ohio, raising concerns over impacts on private property rights. CRWP addressed these concerns in the components of the model ordinance, including:

**Whereas clauses:** The whereas clauses of an ordinance establish the rationale for a community's adoption of a zoning control. The whereas clauses of the riparian setback model emphasize the public health and safety rationale for riparian protection including the flood control and erosion control services of riparian areas. The whereas

clauses also highlight the technical nature of the specific setback widths and their link to the best professional judgment of natural resource management professionals.

**Minimum setback widths:** Working with professional staff from Ohio EPA, ODNR, and other agencies, as well as reviewing national literature on riparian widths, CRWP developed minimum setback widths based on drainage area. These widths range from 300 feet on either side of a watercourse to 25 feet on either side and are expanded for the 100-year floodplain as well as riparian wetlands.

**Variations:** The riparian setback model ordinance contains variance language specific to riparian areas. Most important in the variance language is the guidance to communities to implement riparian setbacks while ensuring, to the extent possible, that lots remain buildable and that subdivision lot yields are maintained. This is done by granting a community's planning commission the flexibility to adjust all setbacks on a parcel - front yard, side yard, rear yard, and riparian - to enable a landowner to build while staying as far as possible from a watercourse. A community's ability to require these type of negotiations would be limited without the riparian setback as part of its zoning code.

### ***Riparian Setbacks in Northeast Ohio***

With the development and refinement of the model riparian setback ordinance, CRWP has been successful in working with member communities to implement the model. As summarized above, five (5) member communities have riparian protection and two (2) others are considering adoption. CRWP has also assisted communities outside the watershed as our model ordinance is increasingly seen as the state standard. This assistance resulted in the first countywide application of riparian setbacks in Summit County, Ohio.

### ***NPDES Phase II Member Assistance Program***

The majority of CRWP's member communities are in the Urbanized Area of Cleveland, Ohio and designated under the Phase II Storm Water Regulations. These communities must develop a Storm Water Management Program by March 10, 2003. The Phase II rule highlights Six Minimum Control Measures that communities must address in their Storm Water Management Programs, including public education and outreach on storm water impacts; public involvement and participation; illicit discharge detection and elimination; construction site storm water runoff control; post construction storm water management on new development and redevelopment; and pollution prevention for community operations.

The minimum control measures of Phase II, particularly requirements for post construction storm water control, are consistent with and closely parallel CRWP's recommendations to member communities for minimizing the impacts of development. As a result, Phase II represents a unique opportunity for CRWP to provide direct member technical assistance while promoting our recommendations. In response to this member need, CRWP developed its

Phase II Member Assistance Program. Under this program we are providing services to designated members both in developing and implementing their Storm Water Management Programs. These services are summarized in Table 2.

**Table 2: CRWP Phase II Member Assistance Program**

<b>Developing a Storm Water Management Program</b>	<b>Implementing a Storm Water Management Program</b>
<p><b>Ohio EPA updates and resolution of member concerns:</b> CRWP updates members on the latest developments in Ohio EPA’s implementation of Phase II and works with the Agency to address member questions and concerns.</p>	<p><b>Workshops and Training:</b> Since its formation, CRWP has been a leader in the watershed by providing educational workshops on the latest developments in storm water management. CRWP will continue this focus during the first Phase II permit term with workshops addressing different aspects of implementing structural and nonstructural storm water management practices in Ohio.</p>
<p><b>Coordination of Phase II service providers:</b> Soil and water conservation districts, health departments, and solid waste management authorities currently provide services, or have the expertise to provide services, necessary for Phase II designated communities to implement successful Storm Water Management Programs. CRWP works with these service providers to determine what specific services these organizations will offer and how they will be delivered to communities.</p>	<p><b>Model Ordinances:</b> Several of the Phase II Minimum Control Measures require communities to implement regulatory mechanisms. CRWP will provide members with model ordinances compliant with Ohio EPA’s requirements under each of these measures and will assist in tailoring these to specific member concerns. As mentioned above, we already have models for minimum control measures 4 and 5 with models for erosion and sediment control and riparian and wetland setbacks.</p>
<p><b>Assistance in drafting Storm Water Management Programs:</b> CRWP assists communities in drafting their Storm Water Management Programs in several ways. We have developed a series of worksheets to help communities inventory their current programs and areas where additional activities may be necessary for Phase II. We have also developed a Storm Water Management Program outline and a list of recommended best management practices. Finally, we developed a draft Storm Water Management Program based on Ohio EPA’s General NPDES Phase II permit. This draft program provides an easily tailored format for members.</p>	<p><b>Educational Services:</b> CRWP will work with other service providers to offer print ready copy for newsletters, web sites, and other outlets on various aspects of watershed and storm water management. Our staff will also be available to participate in community meetings on storm water topics.</p>

CRWP has been uniquely positioned to assist members in complying with Phase II. Since its formation, CRWP has worked to increase understanding about the impact of impervious cover on both storm water quantity and quality. Our recommendations to member communities emphasize the central theme that it is more cost effective to minimize the creation of storm water through innovative land use practices, than to attempt to solve storm water problems

once they are created. Phase II, while seen by many communities as a burdensome regulation, is being tailored by our member communities to address their concerns of flooding, erosion, and water quality problems caused by increases in storm water flow.

## ***References***

Ohio Environmental Protection Agency, 2002. Ohio 2002 Integrated Water Quality Monitoring and Assessment Report Prepared to Fulfill the Requirements of Sections 305(b) and 303(d) of the Clean Water Act. Division of Surface Water, Columbus, Ohio.

Ohio Environmental Protection Agency, 1997. 1995 Biological and Water Quality Study of the Chagrin River and Selected Tributaries – Cuyahoga, Geauga, Lake and Portage Counties, Ohio. Ohio EPA Technical Report MAS/1996-12-6. Division of Surface Water, Monitoring and Assessment Section, Columbus, Ohio.

For More Information on the Chagrin River Watershed Partners, Inc. please contact  
Kyle Dreyfuss- Wells  
Executive Director  
P.O. Box 229  
Willoughby, Ohio 44096-0229  
(440) 975-3870  
[kdw@crwp.org](mailto:kdw@crwp.org)

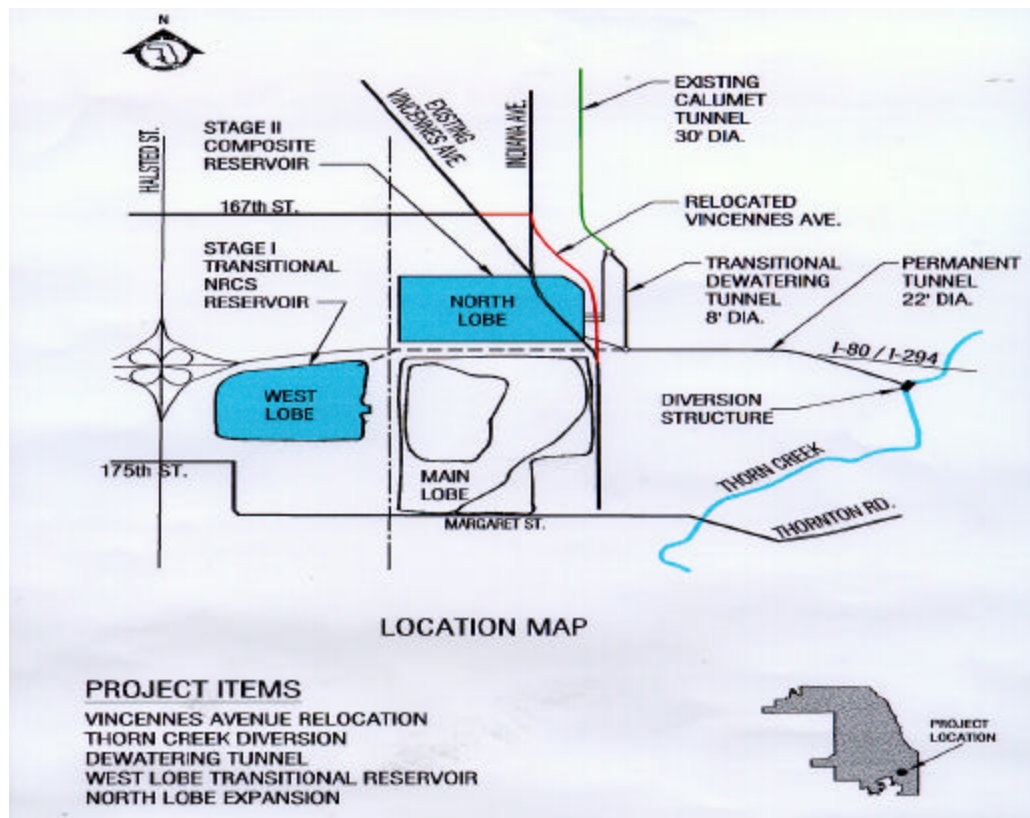
# THORNTON TRANSITIONAL RESERVOIR STORM WATER MANAGEMENT

Didi G. Duma<sup>1</sup> and G. Nicholas Textor<sup>2</sup>  
Consoer Townsend Envirodyne Engineers, Inc.  
Chicago, Illinois

## INTRODUCTION

Consoer Townsend Envirodyne Engineers, Inc (CTE) has completed the design of a multidisciplinary project for the Metropolitan Water Reclamation District of Greater Chicago (MWRDGC). The project will divert more than 80% of the 100-yr peak discharge of Thorn Creek (i.e. 6200 cfs) into an existing quarry located south of I-80/I-294 between Halsted Street and Indiana Avenue, in Thornton, Illinois (Figure 1). The project will be used in connection with the Tunnel and Reservoir Plan (TARP), shown schematically in Figure 2, one of the most important flood control and water pollution prevention projects in the Chicago Metropolitan area. The major goals of TARP are:

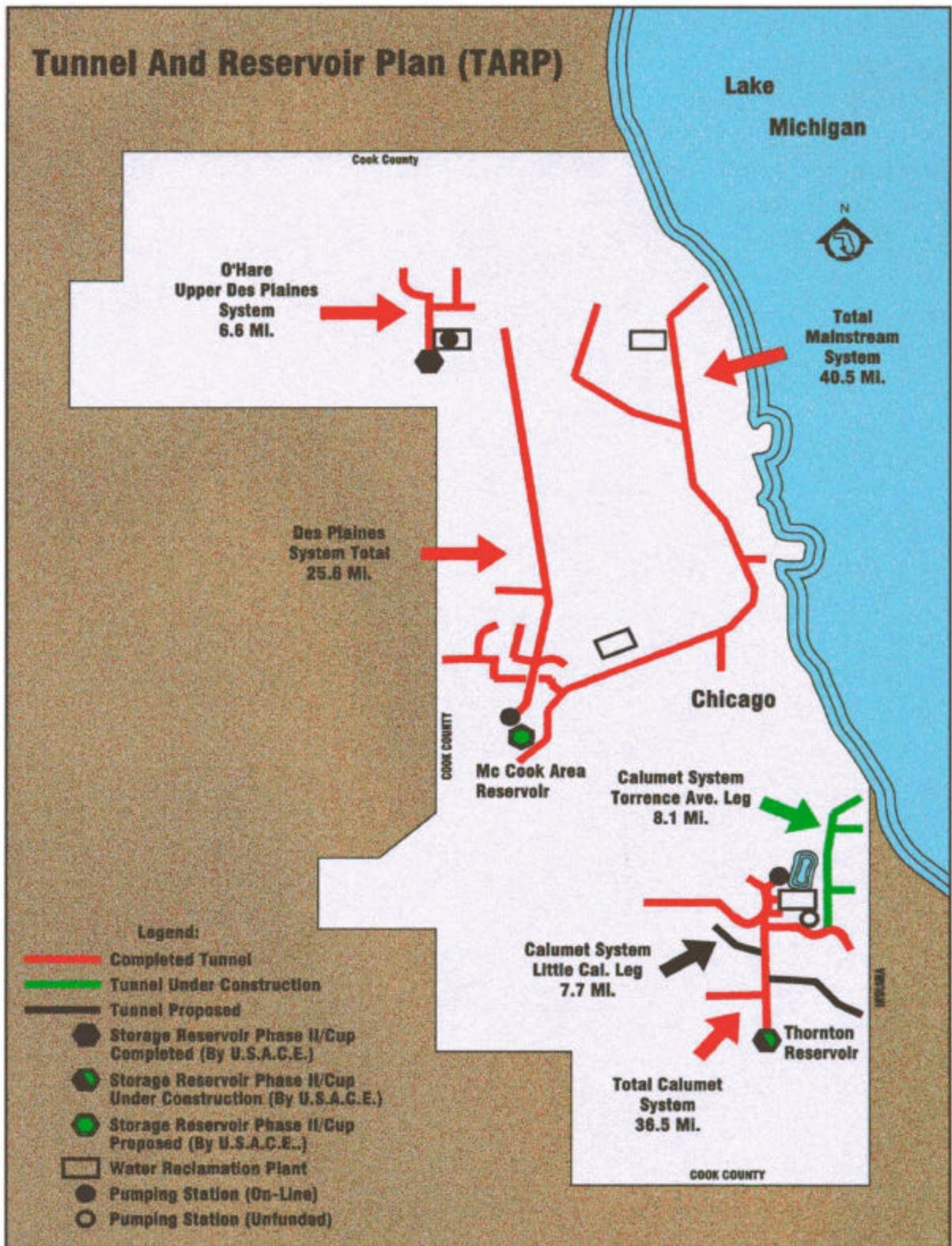
- Prevent flooding in Chicago Metropolitan area and the backflows into Lake Michigan
- Reduce or eliminate pollution of the various waterways in the area caused by combined sewer overflow
- Comply with the Federal and State environmental laws
- Accomplish results in the most cost effective manner



**Figure 1.** Thornton Reservoir Project (in final phase)

<sup>1</sup> Didi Duma, Ph.D., Senior Project Manager, Consoer Townsend Envirodyne Engineers, Inc

<sup>2</sup> Nick Textor, P.E., M.S., V-P, Head of Environmental Resources Department, Consoer Townsend Envirodyne Engineers, Inc.



**Figure 2.** General schematics of Tunnel and Reservoir Plan (TARP) for stormwater management and water quality improvement in Chicago metropolitan area. Thornton Reservoir is the southern component of the TARP system

The TARP system consists mainly of two principal components:

- a. The tunnels, which are associated primarily with water pollution control since they will convey the water stored in various reservoirs to the Water Reclamation Plants for cleaning and water quality improvement.
- b. The reservoirs, which are associated primarily with the flood control in the Chicago Metropolitan area since they will store significant stormwater volumes during major flood events that will be slowly released after the flood peaks will recede.

The Thornton Transitional Reservoir is a first stage of the Thornton Composite Reservoir since it will use only the West Lobe of the Thornton Quarry. After the mining of North Lobe of the Quarry will be closed, the project will include and the North Lobe as part of the Thornton Composite Reservoir, the most southern component of the TARP system.

Thornton Transitional Reservoir will provide flood control in the Little Calumet River Watershed and will detain only stormwater. The project consists of several important components:

- The diversion structure that will divert over 80% of the 100-year peak discharge of Thorn Creek into a connection tunnel with variable width.
- The connection tunnel will convey the diverted water to an approximately 300 feet deep drop shaft, with a 24 foot diameter, that has at the lower end a deaeration chamber (L = 200 ft, W = 32 ft and H = 60 ft).
- The deaeration chamber that is connected to the 22 foot diameter diversion tunnel along I-80/I-294.
- The 22 foot diameter diversion tunnel that will convey the diverted water to the West Lobe of the Thornton Quarry, which will act as a storage reservoir during big flood events.
- The 8 foot diameter dewatering tunnel that will convey by gravity, the water stored in the quarry to the Calumet Water Reclamation Plant (CWRP) via the existing Calumet tunnel.

The design of these complex-function structures was accomplished using sophisticated 2-D hydraulic computation models, and advanced structural design methods. Details of this project and its overall positive effect on water quality are given in this paper.

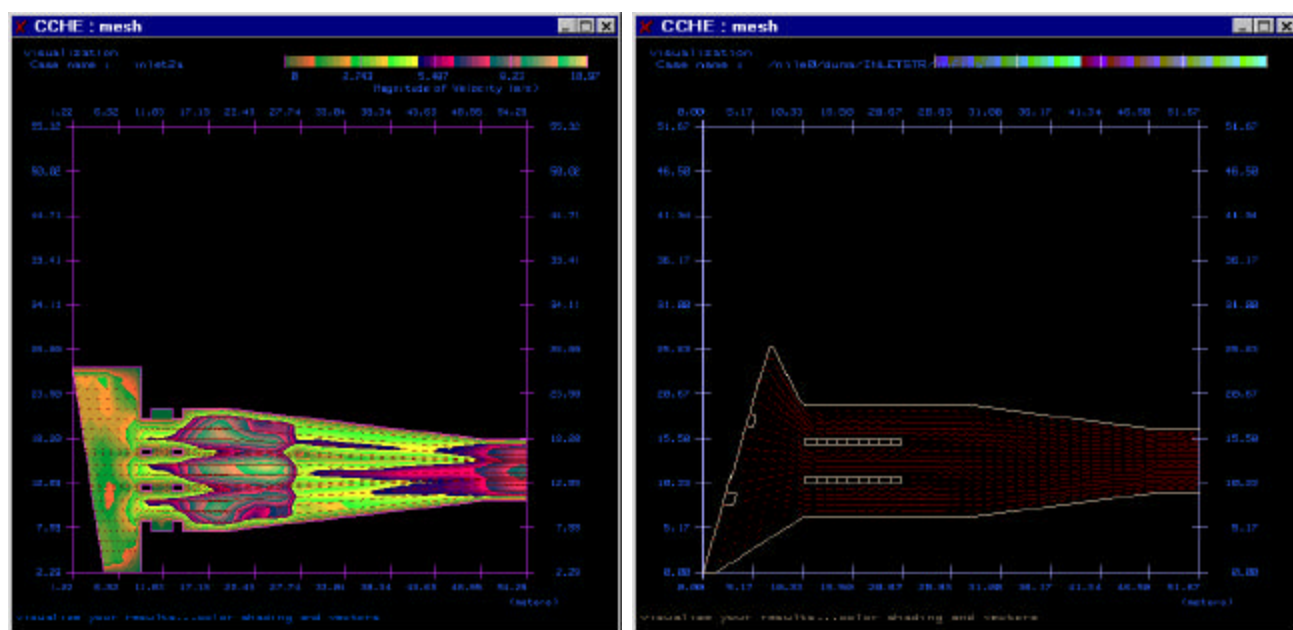
## **DIVERSION STRUCTURE AT THORN CREEK**

The existing flow conditions on Thorn Creek are mainly influenced by the water levels at its confluence with the Little Calumet River. Flow conditions along the channel reach in the area of the proposed diversion structure are characterized by relatively flat slopes and low flow velocities. In the proposed conditions, more than 80% of the 100-yr peak discharge of Thorn Creek will be diverted into the diversion structure. Significant flow regime changes on Thorn Creek would occur during a 100-yr flood event, as compared to the existing flow conditions, that mainly would consist of:

- a. Decrease of water surface elevations of about 6.3 to 6.6 feet at the diversion structure, due to the reduction of the 100-yr peak discharge from 7400 cfs for existing conditions, to 1500 cfs under project conditions.
- b. Increase of the longitudinal water surface slope along Thorn Creek, upstream of the diversion structure intake, from an average of 0.027% in existing conditions, to about 4.13% for the project conditions, with a peak diverted discharge of 6200 cfs.

Due to these changes of flow conditions, the flow velocity during the 100-yr flood event, along the Thorn Creek reach upstream of the diversion structure, would increase from approximately 3.0 ft/s under existing conditions, to approximately 12 - 14 ft/s under proposed conditions. In these conditions, some channel erosion could develop, in time, along the upstream reach of the creek, the extent of which would depend on the sediment characteristics of the channel bed.

The diversion structure at Thorn Creek was designed using a sophisticated 2-D computation model (CCHE2D) developed at the University of Mississippi [1]. The model was used to determine the optimum configuration of the diversion intake and the connection tunnel (Figures 3a and 3b) in order to convey the diverted storm water to the 300 feet deep drop shaft. The CCHE2D computation model is a depth-integrated two-dimensional hydrodynamic model that can be used for numerical simulation of steady and unsteady flows in rivers, basins and estuaries. This advanced computation model can accept a “cold start” (i.e. zero flow velocity field) as well as a “hot start” (i.e. with flow velocity field obtained from previous calculations) as initial conditions. It also accepts a “dry bed” condition for starting computations, which is an advanced feature as compared to other similar computation models.



**Figure 3.** Initial (a) and final (b) configuration of the intake/diversion structure and the connection tunnel to the drop shaft.

The diversion intake is designed to convey discharges up to 6700 cfs, which is 500 cfs more than the required design discharge of 6200 cfs. A sediment barrier wall (weir) of 83 feet in length, with top elevation above the normal water elevation in the creek, of 585.50 feet relative to National Geodesic Vertical Datum (NGVD) or 6.00 feet relative to Chicago City Datum (CCD)<sup>3</sup>, in order to prevent potentially heavy bedload sediment from Thorn Creek entering into the structure.

<sup>3</sup> Elevation “0” CCD was approximated as 579.50 feet NGVD. The exact value is 579.48 NGVD.



The intake bay area, downstream of the entrance weir is at elevation 574.90 feet (NGVD) or - 4.6 feet (CCD) with a 2% bottom slope toward the gates. Three 12' x 12' sluice gates will control the flow into the connection tunnel to the drop shaft. The gates will be operated manually from the gatehouse, located on the top of structure, or remotely from the Calumet Water Reclamation Treatment Plant. The gatehouse floor elevation is above the existing condition 100-yr flood elevation. Due to the steep rise of the creek bank at this location, it was possible to locate the diversion structure in such way that most of the structure is underground; hence the natural esthetics of the area will not be adversely impacted. The intake structure is equipped with stop log supports to isolate the gates for routine maintenance and repair.

Since the structure is located in a Forest Preserve the stormwater could carry floating debris during floods. In order to prevent such debris from entering the structure, a curved alignment of 12" diameter pipes, at 3 feet center apart, was provided in front of the structure. This protection screen follows the existing curvature of the bank, so that the natural configuration of the channel will not be adversely impacted. In order to prevent intentional or accidental access into the diversion structure, a grate with 6" openings was provided at the entrance of the intake bay, on the top of the sediment barrier wall (weir). This feature prevents also pedestrians or animals from falling into the structure. An access road with a wider parking and maneuvering area ensures the access for service vehicles to clean up the collected debris in front of the structure and for periodic maintenance.

## **THE CONNECTION TUNNEL AND THE DROP SHAFT**

As previously mentioned, the diverted water from Thorn Creek is conveyed through a connection tunnel with variable width into a 22 foot diameter drop shaft, approximately 300 feet deep, that has at the lower end a huge deaeration chamber (200 ft x 32 ft x 60 ft), connected to the 22 foot diversion tunnel that ends in the West Lobe of Thornton Quarry.

The CCHE2D computation model was used to analyze the flow pattern inside of diversion structure and the connection tunnel, and to design the optimum configuration of the entire structure. Based on the CCHE2D numerical modeling, the connection tunnel will be 12 feet in height with a tapered width, of 48 feet at the control gates to 24 feet at the drop shaft entrance. The longitudinal slope of the tunnel is 7% on a length of about 110 feet downstream of the gates. The downstream end of the tunnel, at the junction with the drop shaft, is rounded in order to ensure a proper hydraulic transition. As recommended by the U. S. Army - Corps of Engineers, the radius of rounding should be 1.5 Ht (where Ht - is the tunnel height). Therefore, for Ht = 12 feet, a rounded transition with a radius of 20 feet was designed at the downstream edge of the connection tunnel.

The maximum discharge capacity of the connection tunnel is 6700 cfs for a free flow condition. The flow in the connection channel is supercritical (i.e.  $Fr > 1.0$ ), with flow velocities ranging from 15 ft/s, just downstream of the control gates, to 30 - 40 ft/s at the downstream end of the tunnel. The nappe for the design discharge, at the downstream end of the connection tunnel to the drop shaft will hit the drop shaft wall at an angle of about 25 to 29 degrees, hence no special construction measures were needed to protect the wall. The water impact point would be approximately elevation 527.00 feet NGVD (i.e. elevation - 52.5 feet CCD) which is 20 feet below the downstream edge of the connection tunnel.

## THE DIVERSION TUNNEL

The deaeration chamber at the lower end of the drop shaft (that will prevent the air entertained in the drop shaft from entering into the tunnel) is connected to a 22 feet diameter diversion tunnel machine bored in rock, along interstate I-80/I-294, approximately 300 feet below the surface of ground. In the first stage of the project, the diverted Thorn Creek stormwater will be conveyed to the West Lobe of the quarry. The diversion tunnel has a double function: diversion of Thorn Creek stormwater into the quarry, and draining the reservoir to the Calumet Water Reclamation Treatment Plant (CWRP) through the Calumet (TARP) tunnel. To accomplish the dewatering, an 8 foot diameter drain tunnel, connected to the main diversion tunnel just east of Vincennes Avenue, will convey gravitationally the water stored from the West Lobe reservoir to the CWRP. The dewatering tunnel empties to a valve shaft with two 42" hydraulically operated cone valves to regulate the discharge of water to the CWRP and to prevent back flow of combined sanitary and stormwater flow from the Calumet TARP System.

## THE RESERVOIR AND WATER QUALITY ENHANCEMENT

The Thornton Transitional Reservoir will occupy only the West Lobe of the quarry, as a first stage of the final project of Thornton Composite Reservoir. The reservoir will provide flood storage of the 3.1 billion gallons of water from Thorn Creek during floods. After the peak flood stages in Thorn Creek and Calumet River will recede, the reservoir will be gravitationally dewatered through the Calumet TARP System to the Calumet Water Reclamation Plant (CWRP). After dewatering, sediment and other debris that were settled in the reservoir will be disposed to off-site. Therefore, the Thornton Transitional Reservoir project has a double role: flood protection and water quality improvement for an area of approximately 300 square miles, which includes parts of the City of Chicago and its southern suburbs.

## SEDIMENT TRANSPORT AND BANK PROTECTION

The flow regime and the sediment transport on Thorn Creek during floods exceeding 1500 cfs would be significantly impacted by the operation of the diversion structure. A sediment transport analysis for the Thorn Creek reaches adjacent to the proposed diversion structure was performed using the results of the CCHE2D hydraulic computation model (Figure 4), and the results of the grain size analysis of the sediment samples collected from the channel.

The total sediment load ( $g_s$ ) on Thorn Creek for the proposed conditions was estimated using the relation proposed by Grade – Albertson [2], which appears to give the most reasonable results:

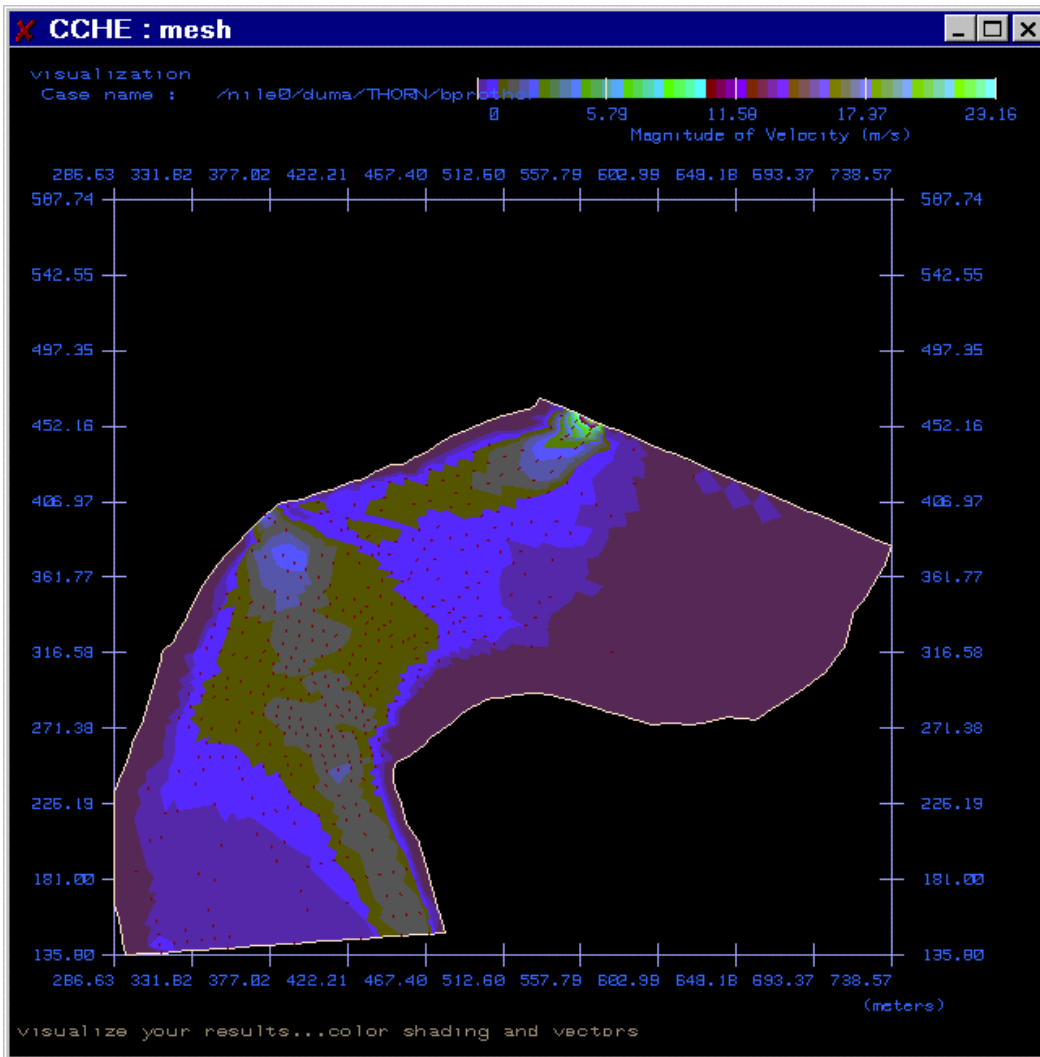
$$g_s = (1.36 V^4 n^3) / \{ [v(10^5)]^3 (D_{50})^{3/2} H \}$$

where

- V – is the flow velocity
- $D_{50}$  – is the median sediment size
- H – is the water depth
- n – is the roughness coefficient
- v – is the settlement velocity for the sediment

The numerical simulations performed using the CCHE2D computation model were compared with analytical calculations. The results showed good agreement. Figure 4 presents the flow velocity distribution in the Thorn Creek reach influenced by the diversion structure operation

Based upon the results of the analysis, the sediment transport on Thorn Creek could be significantly influenced during the operation of the diversion structure. However, the sediment transport analysis was done considering that the design discharge lasts until equilibrium conditions for sediment transport occur. Since the time duration for the entire 100-yr flood on Thorn Creek is generally only two days, the equilibrium sediment transport conditions will be reached only for a very short time interval. Therefore, the sediment transport on Thorn Creek could be less affected than predicted by the sediment transport analysis. However, a program to monitor channel stability and sediment transport upstream and downstream of the diversion structure will be implemented after completion of project.



**Figure 4.** Flow velocity distribution in Thorn Creek (CCHE2D numerical simulation)

In addition, erosion control measures for bank protection upstream and downstream of the proposed diversion structure were provided.

## CONCLUSIONS

The project is now under construction (Figure 5), and will be completed at the beginning of 2003. As part of TARP system, Thornton Transitional Reservoir will contribute to mitigation of the flooding potential, and will improve the water quality of the natural waterways in the Chicago Metropolitan area.



**Figure 5.** Diversion structure at Thorn Creek during construction

## REFERENCES

1. Yafei Jia and Sam S.Y. Wang: “*CCHE2D – A Two-Dimensional Hydrodynamic and Sediment Transport Model for Unsteady Open Flows Over Loose Bed*”, National Center for Computational Hydroscience and Engineering, Technical Report No. CCHE-TR-97-2, September 1997
2. Garde, R. J., Albertson, M. L.: “*The Total Sediment Load of Streams*”, Journal of the Hydraulics Division, ASCE, Paper 1856, November 1958, pp 59-79

# DEVELOPING SPLIT-FLOW™ STORMWATER SYSTEMS

Stuart Patton Echols, PhD  
Assistant Professor, Division of Resource Management  
West Virginia University, Morgantown, WV 26506-6108

## Abstract

There are significant problems with urban stormwater management practices using current detention, infiltration and bioretention methods. The main problem with current detention methods is that they do not meet current environmental protection goals because they fail to adequately address stormwater volume and quality. The main problem with current infiltration and bioretention methods is that they do not meet flood control goals because they fail to adequately address stormwater peak flow rates when rainfall events occur in which the peak flow rate does not correlate with the specific design storm. What is needed is a site-based urban stormwater management strategy that will meet both our environmental and flood control goals. This paper introduces a newly developed stormwater management strategy that provides a practical, comprehensive and integrated approach to preserving predevelopment stormwater flow rates, quality, volumes, frequency, and duration. This new strategy is based on site-based systems that treat non-point pollution and split runoff into relative portions based on existing hydrological conditions.

## Introduction

In the past, different stormwater management systems have been designed to reduce downstream flooding, reduce non-point source pollution, recharge groundwater, and prevent stream degradation. The split-flow strategy is one system designed to do all these things by preserving the predevelopment site hydrology. The result is a management strategy that separates out and retains or infiltrates precisely the runoff volume created by development while the natural runoff that existed before development is cleaned and discharged downstream. As flash flows are maintained at predevelopment levels and first flush is captured on site, the reduction in downstream degradation should be quite substantial. A complete explanation of the development, design and application of the split-flow stormwater management strategy can be found in *Split-Flow Method: Introduction of a New Stormwater Strategy*, in *Stormwater*, July/Aug., Echols, S. (2002) or online at [http://www.forester.net/sw\\_0207\\_split.html](http://www.forester.net/sw_0207_split.html).

This paper will summarize:

1. What are distributed split-flow systems?
2. What are the benefits to be gained through their application?
3. When can distributed split-flow systems be best utilized?
4. What are the hydrological calculations needed to design these systems?
5. How can these systems be used to meet current stormwater regulations?
6. What are the best methods for integrating these systems into site design?
7. How can these systems help guide evolving stormwater policy?

## What are distributed split-flow systems?

The basic premise of split-flow stormwater systems is that rainfall can be divided into three portions specific to any given design storm based on existing conditions for evapotranspiration, infiltration and natural runoff volumes and that these portions can be filtered, distributed and redirected respectively into bioretention, recharge and downstream discharge. The traditional objective of stormwater management systems has been to control the peak flow rate for specific design storms. However, the primary objective of split-flow systems is preserving the predevelopment hydrological conditions by retaining and or infiltrating the total

volume difference created by development and thereby controlling peak flow rates for all design storms. The first two objectives are to lengthen the time of concentration and control the first flush by emulating the reduction in runoff adsorbed in the predevelopment initial abstraction. This reduction in runoff is most easily emulated using existing bioretention techniques sized to capture the first flush. The basic methods of designing bioretention systems as a water quality practice using plants and soils to remove stormwater pollutants are outlined in the Prince George’s County Government published the *Design Manual for Use of Bioretention in Stormwater Management* prepared by Engineering Technologies Associates, Inc., and Biohabitats, Inc., and subsequent publication explaining Low Impact Development methods including the *Low-Impact Development Manual* (2000) developed by Prince Georges County, Maryland Department of Environmental Resources under the direction of Larry Coffman. In Split-Flow systems, runoff is first directed to a bioretention facility where the designated first flush volume of contaminated stormwater is retained by mulch, soil and plant material. Such bioretention facilities can be designed as separate off-line facilities to assure that the first flush pollutants is not re-suspended and released downstream. Excess runoff greater than the designated first flush is filtered through the bioretention facility and directed into proportional splitters where it is divided into diversion and bypass volumes based on specific predevelopment infiltration and runoff rates. The double weir splits the runoff so that the portion of post development hydrograph created by buildings and impervious surfaces is diverted into distributed infiltration facilities and the pre-existing runoff flows are routed downstream. This method most closely recreates the pre-development hydrograph for the design storm as shown in figure 1.

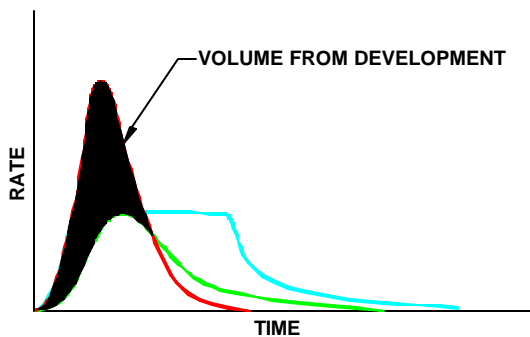


Figure 1 – Runoff volume caused by development above pre-development peak flows.

To infiltrate the total difference in volume for all design storms using a double weir and distributed infiltration facilities, one weir would be designed to emulate the predevelopment runoff while the second weir would be designed to emulate increase in runoff caused by site development. This concept is easily conceptualized as a level curb with two Vee-notch weirs sized for the bypass and diversion flow rates as shown in figure 2.

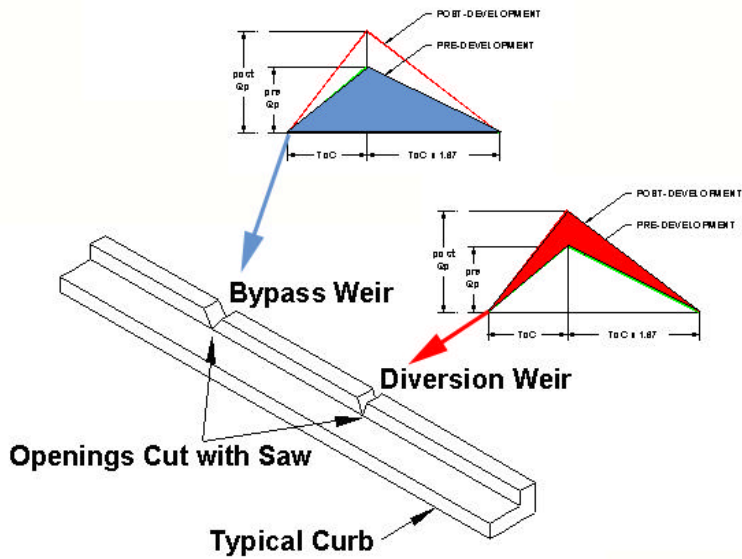


Figure 2 - Level roadside curb with two Vee-notch cuts of different size corresponding to conceptual hydrographs for small and large flows.

As water backs up against the curb, it is split into two volumes proportional to the weir openings as it passes through the curb. The proportional flow splitter apparatus can also be comprised of a drop-inlet or other water conveyance device with two Vee-notch weirs designed in specific proportions to the predevelopment rates of stormwater infiltration and runoff. The diversion volume is directed into distributed infiltration facilities and the bypass volume is cleaned and directed to an existing drainage outlet.

### What are the benefits to be gained through the application of distributed split-flow systems?

Stormwater management, as it is often practiced, satisfies the single purpose of storing runoff and releasing it at flow rates that do not exceed the pre-development peak flow rates. This is generally intended as a local flood control practice. The process is most often accomplished by detention structures designed to hold the increase in runoff, and outfall structures designed to release water at specified discharge rates. This practice, however, fails to address issues such as: (1) downstream flooding from combined detained flows; (2) groundwater and stream base flow depletion; (3) decreased wildlife habitat; and (4) non-point source pollution. This current concept of stormwater management by delayed discharge is flawed because the combined effect of different detention facilities often causes downstream flooding while simultaneously depleting groundwater and stream base flow. Stormwater management strategies that include some form of infiltration can satisfy the goals of mitigating effects of impervious surfaces and maintaining pre-development runoff characteristics. As a result, on-site infiltration currently offers the greatest opportunity for solving our urban runoff and non-point source pollution problems.

The most logical and practical system of responsible stormwater management is to sustain the natural flow rate and volume of stormwater runoff by duplicating pre-development runoff hydrographs in post-development conditions. In theory, pre-development runoff conditions can be duplicated after development using existing infiltration based Best Management Practices (BMPs) such as porous pavement, dry wells, infiltration trenches, basins, etc. However, on-site infiltration is not widely accepted in current practice as a viable stormwater management concept because of short-sighted past infiltration practices. Therefore, urban runoff problems continue to be addressed by designing stormwater detention systems. Adaptations of these traditional stormwater management strategies have had limited success in protecting aquatic

environments, because they are simple modifications of techniques intended to control peak flow rates and are not intended to address issues of ecological protection. An alternative stormwater management strategy is needed that will approach stormwater as an environmental resource and be compatible with land development practices.

There are multiple stormwater management benefits to be gained through the application of such an alternative stormwater management strategy including:

1. reducing on-site and downstream flooding
2. reducing flooding caused by combining detained runoff
3. reducing site and regional stormwater systems cost
4. reducing duration of peak storm flows
5. reducing soil erosion, downstream scouring and silting
6. reducing non-point source and thermal pollution
7. replenishing groundwater
8. restoring downstream base flow and wildlife habitats
9. enhancing esthetics and recreational opportunities
10. improving safety by elimination of detention basins

### **When can distributed split-flow systems be best utilized?**

Preliminary studies still under way show that split-flow systems can be designed to fit on sites with an impervious surface coverage of up to 80%. These systems can often be designed to fit within the space used for existing detention basins. This would, however, not meet the goal of distributing recharge throughout a site. The more distributed a system is, the more it costs because of increased piping to convey bypass flow to a discharge point and less efficient use of infiltration facilities compared to clustering them in one location. This highlights a need for design standards to help assure that split-flow systems will be used to preserve a site's natural hydrology and not simply used to create more land for building on each site. Sites using split-flow systems need to incorporate open space immediately down slope from impervious areas. These sites should also be designed with open space distributed throughout the development. Ideally, developments can be designed such that most paved surfaces are built with porous material and the split-flow systems are only needed to control runoff from buildings. The split-flow strategy's decentralized design also creates additional design flexibility, as suitable locations for large stormwater facilities become a low priority. An additional advantage of the split-flow strategy is that once calculations are complete, split-flow systems are simple to design because each impervious area can be designed separately. There is no need to run routing models commonly used to size detention systems as long as the split-flow facilities do not overflow into each other. Providing an overflow drainage system to existing discharge outlets prevents the potential for the facilities to overflow into each other. This ability to design each stormwater facility separately allows simple revisions if development plans are changed or phased. Even years later as residents add more impervious areas such as additions, out buildings, or surfaces, split-flow facilities can be added to maintain the predevelopment hydrology. Simple regulations need to be written that specify the size of split-flow facilities based on square footage of new impervious areas created by landowners. This would even allow easy retrofits to restore a site's natural hydrology years after a development is completed.

### **What are the hydrological calculations needed to design these systems?**

The bypass weir is sized for pre-development peak flow rate and the diversion weir is sized for the difference in pre and post development peak flow rate. Using a chart such as the Vee-notch weir nomograph shown in figure 3, each weir can be sized based on identical head and different flow rates.



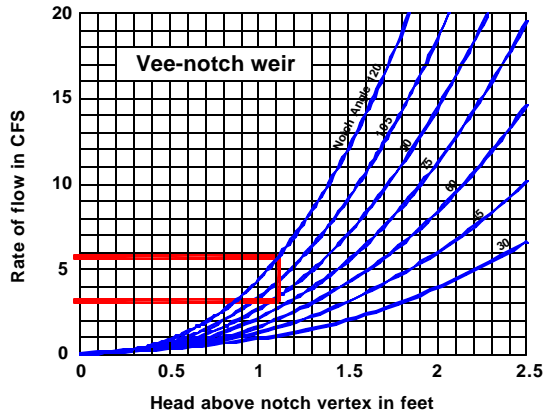


Figure 3 - Vee-notch weir nomograph showing flow rate, hydraulic head, and corresponding Vee-notch weir angles.

For example, if the pre-development peak runoff rate is 5.6cfs and the post-development peak runoff rate is 8.5cfs, the bypass weir would be sized for 5.6cfs and the diversion weir would be sized for 2.9cfs. Using the Vee-notch weir nomograph, the bypass weir angle could be 120 degrees and the diversion weir angle could be 90 degrees as long as the weirs are constructed at the same elevation.

The total volume difference between pre- and post-development design storms can be calculated with the equation:

$$(\text{post } Q_p \times \text{ToC} \times 80.1) - (\text{pre } Q_p \times \text{ToC} \times 80.1)$$

while the total volume for the bypass can be calculated with the equation:

$$\text{pre } Q_p \times \text{ToC} \times 80.1.$$

However, the key to success with a stormwater management system based on this strategy is to install proportional flow splitters for each impervious surface and distribute the flow from the diversion weir into individual infiltration facilities. This requires that the flow splitters be designed to divide the runoff from each of these surfaces into portions that emulate the predevelopment runoff flows and the difference in predevelopment and post development flow for each individual surface which will not be the same as the ratios for the entire drainage area. This is done by sizing each individual pair of Vee-notch weir angles for the proportional flow splitters based on the predevelopment runoff and the increase in runoff caused by each individual impervious surface. The volume of runoff that needs to be infiltrated for each individual impervious surface can be calculated with the equation:

$$\text{Volume} = \text{individual impervious surface area} \times \frac{((\text{post } Q_p \times \text{ToC} \times 80.1) - (\text{pre } Q_p \times \text{ToC} \times 80.1))}{\text{total on-site impervious surface area}}$$

This volume should be based on the largest design storm chosen according to the acceptable level of flood risk for the site design. This allows the stormwater management system for each impervious area to be designed independently based on unique site conditions.

### How can these systems be used to meet current stormwater regulations?

Traditional stormwater management regulations require peak flow rates be maintained at predevelopment levels. New regulations also regulate total maximum daily loads for non-point source water pollution. A

few regulations address some level of runoff volume reduction but do not require runoff volumes be maintained at predevelopment levels. Split-flow systems, however, are based on the premise that we can recreate predevelopment runoff rates, volume and quality in urban development and that preserving the existing hydrology is a better way to manage stormwater. This is a change from traditional stormwater management practices designed to accommodate development by disposing of runoff as quickly as feasible. Many stormwater regulations currently place runoff in the category of flood hazard planning based on the view that stormwater is a useless and unwanted byproduct of development that should be collected and removed as quickly as possible. This is accomplished through systems of inlets, pipes, and basins that decrease infiltration, stream baseflow, groundwater recharge, and degrade water quality. However, stormwater can also be viewed as a renewable natural resource that sustains our streams, replenishes our lakes, and recharges our ground water supplies. This renewable public resource is owned by all of us, a result of a natural process, used as an economic resource, and has an enormous impact on the quality of other ecosystems. As a public resource, it's positive and negative economic externalities need to be acknowledged. If sites are properly designed, this resource can be managed to prevent flooding as well as safeguard our lakes, streams and groundwater. If site are not properly designed, this resource will flood downstream properties and destroy aquatic ecosystems. Hence, a basic goal of this alternative stormwater management strategy is to meet our environmental goals and work within our land development needs by: (1) not increasing down stream flow rates, (2) reducing non-point source water pollution, (3) recharging at predevelopment rates, and (4) not polluting our ground water. In theory, if runoff volumes were maintained throughout the site at predevelopment levels, peak flow rates would also remain at predevelopment levels. It could, however, be difficult at this time to convince local stormwater regulators that controlling runoff volume will control peak runoff rates. Further studies using in ground testing will be needed to show how these systems will perform under actual development conditions.

**What are the best methods for integrating these systems into site design?**

The crucial element for success with the split-flow stormwater management strategy is to install small flow splitters for individual paved surface and distribute the runoff into multiple small-distributed infiltration facilities. This is best done by sizing each proportional flow splitter on the increase in runoff caused by each impervious surface. For example, a building erected on land with a runoff coefficient of 70 would require the weir angles designed for 7 cfs and 4 cfs. This would result in one weir having a 90° Vee-notch angle while the other weir would have a 60° Vee-notch angle. These flow splitters can then be distributed throughout the site in existing open space or landscape islands as shown in figure 4.

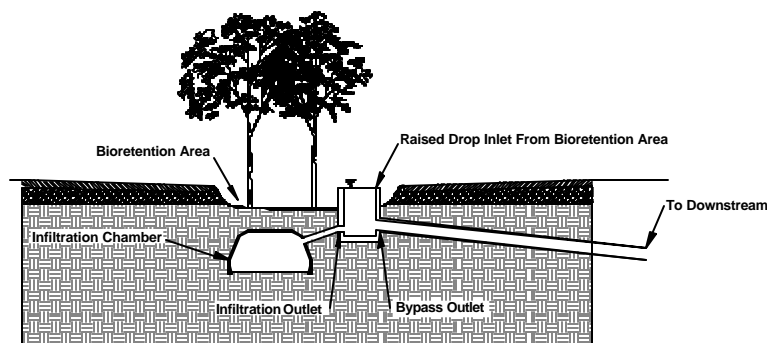


Figure 4 – Example split-flow facility: depressed landscape island in parking lot with bioretention area, raised drop-inlet flow-splitter, underground infiltration chamber for diversion flow and bypass to downstream outlet.

This ratio could be used in all the flow splitters used for impervious surfaces on site to control the peak flow rates for the entire development. Similar ratios can be derived for other runoff coefficients or other runoff methods. An advantage of the split-flow strategy is that the volume to be infiltrated is precisely the same as the excess runoff created by the development and not any larger as in other infiltration and bioretention methods. This is especially important on sites with clay soils where very little water recharges naturally. The proportional flow splitter would assure that the same volume and no more would need to be infiltrated into the ground after development in order to control the peak flow rates. A second advantage of this strategy is that the volume to be infiltrated is adjusted by the flow splitters for each storm and not based on a specific design storm. However, without adequate distribution on site the system will not work because there must be sufficient soil area for the diversion volume to be able to infiltrate in a reasonable time. Therefore, many small split-flow facilities need to be placed throughout a site as shown in figure 5.

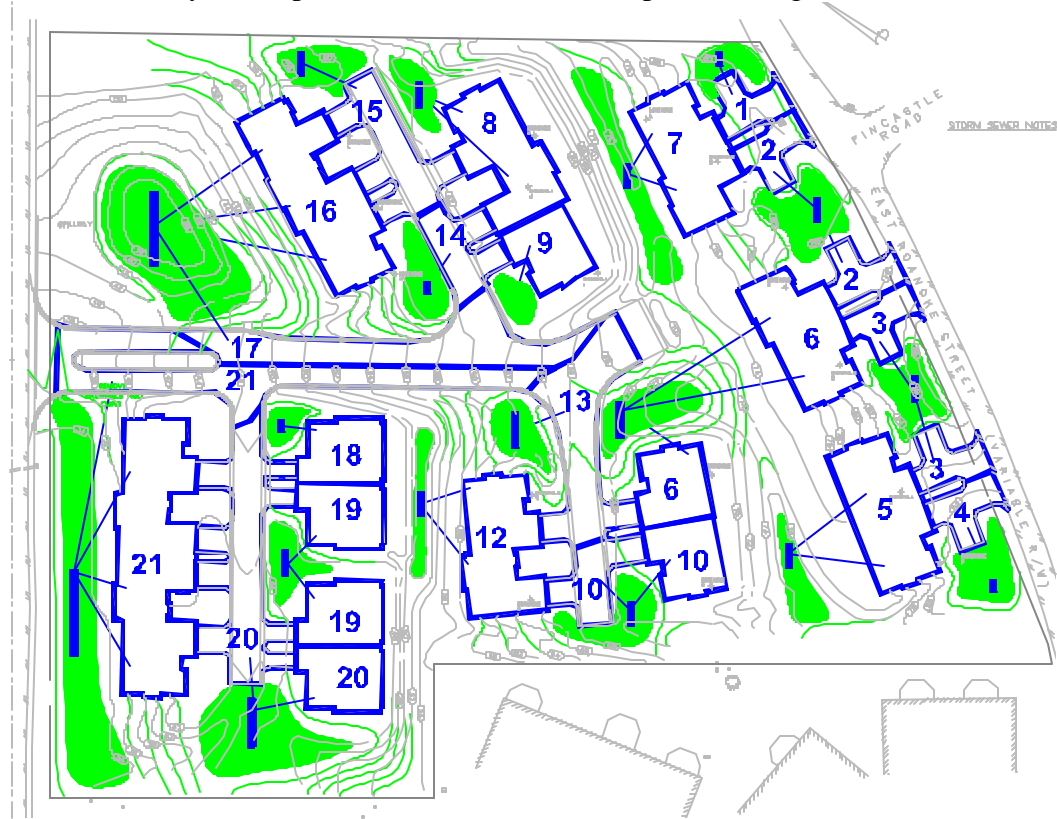


Figure 5 – Example plan with location of Split-Flow facilities. Impervious surfaces are outlined in blue. The underground infiltration chambers are shown as small blue rectangles while above ground bioretention facilities are shown in green. Thin blue lines show which impervious areas and buildings are directed to which split-flow facilities.

This concept will succeed in controlling peak flow rates where other infiltration and bioretention strategies have not because the amount of stormwater to be infiltrated in each facility is carefully controlled and it is never concentrated in large quantities. The stormwater management system will still control the peak flow rates by distributing and infiltrating the difference in volume over the entire site.

**How can these systems help guide evolving stormwater policy?**

Many communities have implemented stormwater utilities to pay for building storm sewers and runoff treatment facilities. Some communities base their fees on impervious surface areas for each property.

Many of these communities also allow reasonable reduction in fees based on reduction in volume, which will hopefully encourage more environmentally responsible stormwater management practices. If a builder installs a system to control the runoff rate and volume and can demonstrate there is no change in the existing hydrology, the fee could be waived. This can provide an incentive for developers to install environmentally responsible stormwater management systems if the costs are reasonable. A preliminary study shows that split-flow systems would likely cost the same or less to build than detention systems. Split-flow systems would provide non-point source pollution and flood control benefits to the community, as well as lower the owner's annual operation cost by eliminating the annual stormwater utility fees. As a result, the split-flow strategy can provide a reasonable financial alternative to existing detention practices, which could become a financial incentive for developers to install more environmentally responsible stormwater management systems. Maintenance costs should be the same as existing bioretention systems, however, further research is needed.

The split-flow strategy intends to preserve the predevelopment site hydrology by duplicating year-round natural infiltration volumes. Water balance studies indicate that spring flooding results when the ground is saturated from winter precipitation stored in the soil and the soil's water absorption capacity is greatly reduced causing increased runoff. The split-flow strategy would emulate these conditions and therefore likely infiltrate less precipitation during the spring flooding season. Detention systems, on the other hand, are not designed for, or affected by, soil infiltration capacity, which changes during the year. In effect, split-flow systems could reintroduce local stream flooding that may have been prevented with detention. As a result, a question arises regarding the conflict between the wisdom of restoring natural processes, which could include local spring flooding, versus installing detention systems that could artificially control local spring flooding but destroy aquatic ecosystems. Conversely, development has also been shown to cause increased year-round flooding and multiple detention systems can combine and elevate these floods depending on how the basins' outflows combine downstream. As stated, the split-flow strategy is based on the premise that preserving the natural hydrology is a better way to manage stormwater. However, the land development industry has historically operated under the strategy that we should modify natural systems to accommodate development rather than modify development practices to accommodate natural systems. Changing these basic beliefs and operation procedures will likely require numerous long-term demonstration studies.

## **Conclusion**

The goal of this paper is not to claim excellence of one stormwater management method over another but rather to contribute an additional management option that hopefully can start to change our stormwater management expectations. The intent is to demonstrate that a viable stormwater management strategy can be derived from the premise that preserving the natural hydrology is a better way to manage stormwater and that modifying land development practices to accommodate natural systems can be more effective than modifying natural systems to accommodate land development practices.

The split-flow strategy, however, is still a theory that needs in-ground testing to discover what problems will result in the design and construction processes. For example, including construction erosion and sediment control measures on sites with split-flow systems will create additional design challenges. Current design and construction practices incorporate temporary sediment basins in the location of future detention facilities. These temporary sediment basins are then converted to detention basins when construction is completed. However, split-flow systems do not need detention basins. Therefore, other erosion and sediment control solutions will be needed during construction. Possible solutions include: use alternative prevention and control methods that do not require sediment basins, build temporary sediment basins that can be converted

into bioretention facilities when construction is completed, or build temporary sediment basins elsewhere on site that can be removed after construction is completed. Regardless of what methods are used for erosion and sediment control, the split-flow systems should not be activated until the site is completely stabilized. Additional research will be needed as other site design and construction implications arise.

Preliminary research shows that split-flow systems can be comparable in construction cost to detention systems depending on the complexity of the stormwater designs. Findings show that split-flow infiltration practices can often be used to lower the cost of on-site stormwater management and provide a higher level of environmental protection. Findings also indicate that non-point source water pollution reduction objectives currently achieved by other infiltration and bioretention strategies could be more cost effective construction using the split-flow strategy. Notable implications that need to be addressed with further development of the split-flow strategy include: stormwater policy, site design and construction practices, runoff modeling and environmental concerns.

Coffman, L. (2000). Low-impact development manual. Prince Georges County, Maryland Department of Environmental Resources.

Echols, S.P. 2002. Split-flow method: Introduction of a new stormwater strategy. *Stormwater -The Journal for Surface Water Quality Professionals*, 3(5): 16-32.

# ***Reforest the Bluegrass***

## **Empowerment of the Citizen Watershed Manager**

H. David Gabbard, P.E.  
Division of Engineering  
Lexington-Fayette Urban County Government  
Lexington, Kentucky 40507-1310

Angela Poe  
Bluegrass PRIDE  
Lexington, Kentucky 40591

### **Abstract**

In 1992, the National Pollutant Discharge Elimination System permitting program of the Clean Water Act sought to address non-point source pollution from stormwater discharges. Lexington, Kentucky, was a Phase I city that was required to file for a permit under this program. The permit required the Lexington-Fayette Urban County Government (LFUCG) to assess the environmental damage to its water resources and develop urban stormwater pollution prevention programs using best management practices (BMPs) to the maximum extent practicable (MEP).

The assessments showed that aquatic life had been greatly affected by the alteration of stream corridors. From the filling of floodplains and the alteration of stream morphology to the clearing of streambanks of unwanted vegetation, human activities had greatly diminished optimal habitat conditions. It was determined that one of the most effective BMPs to reverse the affects of these activities was to restore riparian forest cover to the stream channels. However, two centuries of agricultural uses of the land has left an aesthetic, “The Bluegrass Aesthetic,” in which citizens expect creeks to be *seen* and *heard*. Rolling hills are covered with carefully mowed non-native bluegrass and fescue; streambanks are mowed down to the water’s edge; and trees dot the landscape in various places – but do line fencerows and driveways.

Because of the “Bluegrass Aesthetic,” citizens regard urban streams as mostly open, stormwater ditches and that it is the government’s responsibility to keep them clean. Most property owners have applied the “Bluegrass Aesthetic” to every lawn – mowing or weed-eating down to the water’s edge. Furthermore, the little remaining Fayette County riparian forests contain a dense understory of invasive bush honeysuckle. Because of community concerns regarding the concealing of illicit activity, many forested stands with bush honeysuckle have been removed.

The final constraint was that the LFUCG Division of Engineering did not have a stormwater budget that would allow for large public works projects to address major riparian planting programs. However, even if the DOE had the budget for such projects, it would have to overcome negative public perceptions regarding early successional growth.

The solution was to create the *Reforest the Bluegrass* program in the spring of 1999. This is a Public Works program that empowers citizens to protect their own water resources. By using citizens to plant the forests, there is a sense of ownership of the project and that support is critical in the early stages of forest growth – when the project looks “weedy” and contrary to the “Bluegrass Aesthetic.” Furthermore, it educates and trains citizens why to plant trees to protect their properties along streams or “ditches” (there are 560 miles of blueline streams in Fayette County).

The success of the *Reforest the Bluegrass* program has been phenomenal! Since April 1999, 3,975 volunteers have been trained as urban watershed managers in eight different events. They have planted over 108,000 trees in 140 floodplain acres. The LFUCG has spent approximately \$85,000 of local taxpayer dollars and other \$50,000 has been raised via donations or grants. If the project had been contracted out (as some first suggested), the project would have cost over \$650,000!

## **Introduction**

The creation for the *Reforest the Bluegrass* program is founded in the need for the LFUCG to comply with various components of the Clean Water Act. The LFUCG has been monitoring the conditions of the waters of Fayette County since it was first required to apply for a stormwater discharge permit in 1992. This permit serves the purposes of qualifying and quantifying urban sources of non-point source pollution conveyed by stormwater runoff. Other non-point sources in Fayette County are comprised of agricultural sources from tobacco farming, cattle grazing, and the equine industry.

*Reforest the Bluegrass* addresses three important goals facing large urban communities:

- An NPDES municipal stormwater discharge permit to control urban, non-point source pollution;
- Restoration of streams listed on the 303(d) lists of each state; and
- Changing the landscaping habits of citizens to protect water resources and value riparian forests.

### ***Goal: Urban Non-point Source Pollution Control – Municipal Stormwater Permit***

A stormwater discharge permit is required as part of the Water Quality Act of 1987. Medium sized cities with populations greater than 100,000 and less than 250,000 which had municipal separate storm sewer systems (MS4s) were required to apply for permits as a phased approach to the management of water quality within the United States. Earlier legislation and programs (1972 Clean Water Act and the National Pollutant Discharge Elimination System (NPDES)) focused on removing point sources of water pollution. The 1987 stormwater permitting requirements were designed to manage non-point source water pollution from various industrial and municipal activities.

The NPDES Stormwater Discharge Permit for the LFUCG required an assessment of the environmental damage to Fayette County water resources and develop urban stormwater pollution prevention programs using best management practices (BMPs) to the maximum extent practicable (MEP). During the assessment of the urban watershed, the following problems were identified:

1. Floodplains have been filled and developed utilizing past engineering designs that forced more flow through narrower channels thus altering and reducing the benthic macroinvertebrate habitat;
2. Tree canopy over the streams has been either eliminated, consisted of invasive bush honeysuckle; or was comprised of ornamental shrubs and trees in single rows;
3. There have been problems associated with dense communities of algae dominating the streams. Because of the high phosphorus content of the soil, the concentrations of phosphorus in the stormwater runoff quickly trigger algal growth (background phosphorus concentrations are 0.2~0.3 mg/L). Where there is full sunlight, in most places, algal mats form quickly and in abundance. However, anywhere there is tree canopy, the stream is void of algae;
4. Lexington is situated on a hill. Six 11-digit HUCs (watersheds) drain from the central part of the city out to the county line. Because all urban streams are small headwater streams, the impacts of thermal pollution, heavy metals, and dissolved oxygen-robbing algal mats have resulted in frequent fish kills and poor aquatic insect communities; and
5. The destabilized streambanks and shallow soil depths (to bedrock) have resulted in streams eroding and widening their bank widths.

In creating a watershed management program, the LFUCG would have to:

- Apply Best Management Practices (BMPs) to the Maximum Extent Practicable (MEP);
- Seek intra and inter-governmental cooperation;
- Involve public education and involvement; and
- Seek ways to reduce the use of lawn care chemicals and their impacts.

As a stormwater management program, *Reforest the Bluegrass*, addresses each of these requirements. Riparian reforestation is a BMP for water quality enhancement and requires a great deal of agency cooperation for large scale planning and implementation. Furthermore, by training citizens to perform the work, they are educated as to the necessity of riparian forests and vegetated stream buffers. As a result, these citizens are beginning to change their lawn care habits to protect the quality of water of Fayette County.

### ***Goal: Restoration of Impaired Streams of the 303(d) List***

During the first three years, site selection was based upon the 303(d) listing of each of the major stream systems within Fayette County. The “303(d) list” is a compilation of stream segments determined by each state for which a Total Maximum Daily Load pollution allocation model is necessary for pollution control. Streams are listed based upon whether or not they meet designated uses – are the waters fishable and swimmable. The criteria, which determine the fishability or swimability of a given waterbody, are based upon water quality and biological assessments.

For Fayette County, stream use assessments are based mostly upon data collected as part of the requirements for the stormwater discharge permit. The data collection has been performed for the LFUCG by Commonwealth Technology, Incorporated (CTI, now Tetra Tech, Inc.). The primary indicators of stormwater pollution problems that have been found are:



- Presence of fecal coliform in streams and storm sewer outfalls;
- Fair to poor aquatic communities; and
- High nutrient and organic enrichment.

Dry and wet weather water chemistry samples indicate high levels of fecal coliforms in most streams. Biological community monitoring indicates that streams in the urban service area generally do not fully support aquatic life. Habitat evaluations indicate inadequate instream and riparian habitat to support aquatic life at some sites; at other sites, habitat is adequate but aquatic life is still poor.

As previously mentioned, nutrient enrichment is a problem because of the high phosphorus concentrations that occur naturally in the central Kentucky region. Only 7% of the streams of the United States are limestone-based systems. And of those, central Kentucky is an oddity because the upper limestone layer has a high phosphorus content. Groundwater in the area has a phosphorus concentration of 0.2~0.3 mg/L, two to three times higher than the 0.1 mg/L concentration that triggers algal blooms elsewhere in the country.

### 303(d) List of Waters for TMDL Development

For the initial selection of reforestation sites, the 1998 303(d) listed streams were examined for Fayette County:

#### First Priority (Does not support one or more designated uses, KDEP 1998):

	<u>Impaired Use</u>	<u>Pollutants of Concern</u>
Unnamed Tributary to Baughman's Fork	Aquatic Life	Organic Enrichment/Low DO Nutrients
Cane Run	Aquatic Life Swimmable	Organic Enrichment/Low DO Pathogens
Town Branch	Aquatic Life Swimmable	Organic Enrichment/Low DO Nutrients Pathogens
Wolf Run	Swimmable	Pathogens

#### Second Priority (Partially supports designated use)

	<u>Impaired Use</u>	<u>Pollutants of Concern</u>
West Hickman	Aquatic Life	Habitat Alteration Siltation

## ***Goal: Alteration of Human Habitat Habits***

Over 200 hundred years ago, the central Kentucky plateau region was a savannah covered in mostly buffalo clover and cane breaks. However, along the stream corridors were dense hardwood forests –oak-hickory forests. With the settlement of the area, the cane breaks and dense riparian forests were cleared for livestock grazing and cropland. Furthermore, it was discovered that the rich soils from the weathering of limestone layers prevalent in this region resulted in exceptional land upon which to graze and raise thoroughbred racing horses. With these types of agricultural uses for the land, trees were relegated to fencerows and driveways. Also, forests were left in hard-to-reach or unfarmable areas. After over a hundred years of this change in land cover, the “Bluegrass Aesthetic” was born – rolling hills, mowed fields of non-native Bluegrass, and a few trees dotting the landscape.

Almost all modern property owners have applied the “Bluegrass Aesthetic” to their lawns – mowing or weed-eating down to the water’s edge with a few trees here and there. Citizens have viewed urban streams as open ditches and that it is the government’s responsibility to keep them clean. Furthermore, the limited existing Fayette County riparian forests contain a dense understory of invasive, non-native bush honeysuckle. These areas have been used for concealing illicit activity and the Parks and Recreation Department and neighborhood associations have previously thinned out these areas to make them safer and more aesthetically pleasing. Therefore, any education in regards to the use of riparian buffers must address the impacts of the modern, chemically-addicted lawn.

It should also be noted that as part of any NPDES stormwater discharge permit, the permittee is required by the Clean Water Act to create educational programming to alter the lawn care practices of the urban area to reduce the use of fertilizers and pesticides. Therefore, riparian buffer education and implementation by citizens is a positive way to affect meaningful change without a lot of effort put into informing citizens what they are doing wrong.

## ***Reforest the Bluegrass – The Early Years***

*RTB 1999*

With the consideration of all the aforementioned goals, discussions began with the LFUCG Division of Parks and Recreation as to a suitable area to begin work. The reason the Parks department was approached was that it was the only division of the LFUCG that owned and maintained long stretches of stream corridors. It was determined that the first year’s event would be performed along a “ribbon park” which had been donated to the LFUCG as part of a commercial development. The University of Kentucky was converting agricultural land, Cold Stream Research Farm, into a commercial “research park” along three miles of Cane Run Creek in northeastern Lexington. Because the floodplains were undevelopable, the University gave the floodplain areas to the LFUCG as greenspace with the condition that it is for passive recreation: trails, meadow areas, riparian forests, etc.

A local landscape architecture firm, John Carman and Associates, was hired by Parks and Recreation to create the design. Even though the design showed a riparian buffer strip along the three miles of stream corridors, no one had ever planted that many trees before and Parks did not have a budget to purchase the trees. Up until that time, all trees which were planted on Park property were saplings or greater in size. Therefore it was considered impracticable to plant forests of large caliper trees – but it was nice to look at

on paper. It was decided that the Cold Steam Park would be a good proving ground for the project. After all, this land had not been open to the public previously so if our project failed, no one would really notice.

Even though early planning was chaotic and there was still an on-going discussion as to whether or not to involve the public (the Urban Forester wanted to hire migrant workers to plant the seedlings – the Environmental Engineer wanted the “public outreach” component for his stormwater management program), the project became an overnight success! During two weeks in April 1999, over 1,200 volunteers assisted in the installation of 45 acres of floodplain forests. 25,000 tree seedlings were planted along three miles of First Priority streams in Lexington’s effort to systematic restore riparian forests along all 560 miles of streams within its borders.

## ***RTB 2000 & RTB 2001***

During the following two years, another 45,000 trees were planted by training over 2,000 citizens to plant riparian forests. The site for these projects were in Masterson Station Park which has two tributaries to the Town Branch, another First Priority watershed in Fayette County. The park is the largest in Fayette County, 770 acres of rolling hills and denuded streambanks.

## ***Reforest The Bluegrass 2002 – “I think we got it right this time...”***

*RTB 2002*, April 6, was by far the best event yet – crystal blue skies (high of 49°F); well-trained group leaders; over 900 volunteers (planters and staff) showed up to plant 15,975 trees; and there was plenty of t-shirts, food, and supplies. The event also took place down inside two, large regional detention basins that were installed as a part of a commercial development. The detention basins and the land surrounding them were deeded over to the LFUCG as park area. Therefore, the connection between the creation of an urban forest and the control of stormwater pollution was clear for the first time.

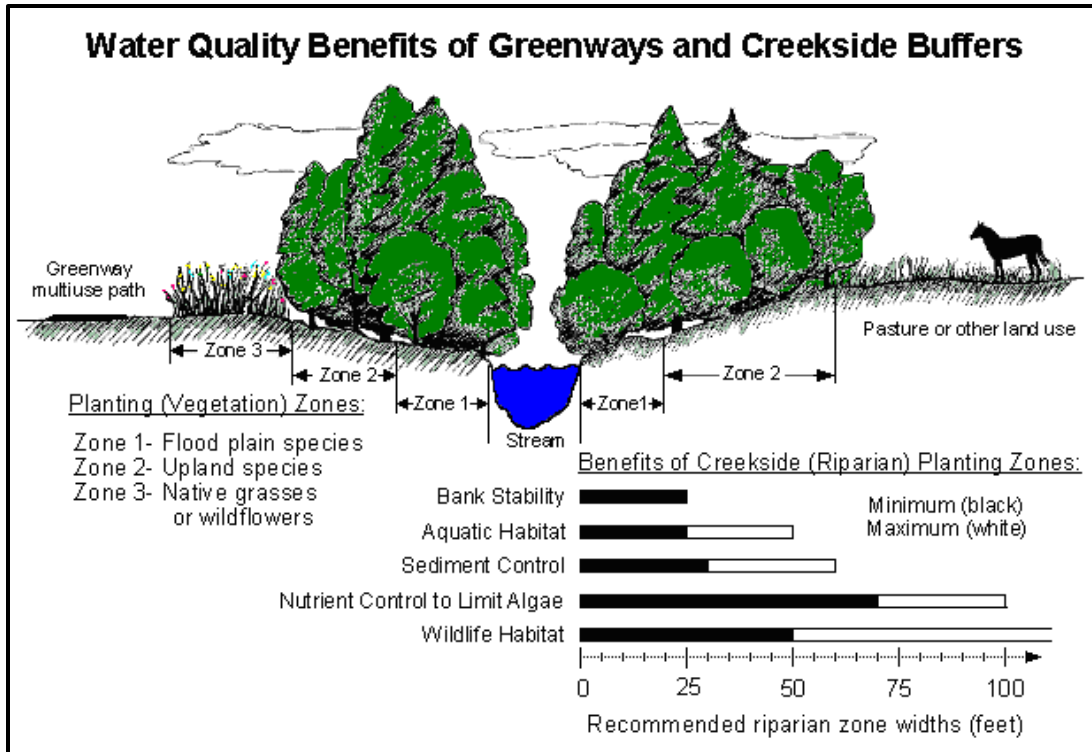
## **Project Design**

*Reforest the Bluegrass* uses the wealth of knowledge and experience gained by the use of riparian, streamside, buffer systems. This “system” is nothing more than examining and mimicking the beneficial controls applied by nature to protect and preserve stream corridors. The buffer system approach uses the beneficial qualities of native vegetation to achieve desired goals of resource management.

In Figure 1, the buffer system consists of using three different kinds of vegetation to achieve the desired results. For bank stability and aquatic habitat enhancement, tree or shrub species that can tolerate a moist environment are selected. These are planted along the stream and in the floodplain. For nutrient control, optimal wildlife habitat, and slope stability, tree and shrub species are selected that prefer average to dry soil conditions. Finally, to control nutrients even more, a zone of wildflowers or native grasses (or both) are planted along the outer perimeter of the forested zone.

With this information, species are selected that will enhance the biota of the localized planting. Also, species selected are strongly influenced by their availability through the National Tree Trust. As the largest sponsor of the *Reforest the Bluegrass* (\$19,800.00 worth of *donated* trees for *RTB 2002* alone), if “they’ve got it, we’re gettin’ it!” Of course, some trees, like conifers, are not native to the area and therefore are

disregarded. However, the National Tree Trust has been the largest supplier of trees. Additional tree species that are not on the list of the Tree Trust are ordered through the Kentucky Department of Forestry.



**Figure 1.** Riparian Buffer Management System, RiMS (Source: Schultz, NREM Dept. Iowa State University)

Table 1 contains a current list of tree species used (although some were not available for this past year’s event). The *Recommended Planting Zones* refers to the previous discussion on buffer systems and the appropriate zones for different species. “W” means “wet” and these trees are suitable to plant in areas where the ground may be inundated for extended periods during the year. “1” is for trees that are suitable to be planted in “Zone 1,” the floodplain zone. These trees will experience somewhat frequent flooding and the soils are generally moist to wet. “2” is for trees that are suitable for “Zone 2.” Zone 2 trees do not tolerate root systems that are inundated with water. They prefer average to dry soil moisture conditions. “3” refers to trees suitable for “Zone 3.” Zone 3 are areas that can become dry; tops of hills, south facing slopes, next to parking areas or commercial zones, etc.

## Project Implementation

### *Project Coordination*

Reforest the Bluegrass is a cooperative effort of the LFUCG Divisions of Engineering (Stormwater), Parks and Recreation, and Planning (Urban Forestry). The project also uses engineering, forestry, and ecological experts from academia and natural resources agencies to design and layout the project. Tree seedlings of various species, native to the inner Bluegrass physiographic region, are donated by the National Tree Trust. Seedlings are mixed together in bags that are sorted by planting design areas. Dots are spray painted on the restoration site at a recommended spacing and bags of trees are color-coordinated with the dots on the

ground (green dots for floodplain species, pink dots for upland species, etc). During the planning stages of the event, many community organizations and businesses assist with project organization and implementation. These organizations include Bluegrass PRIDE, Fayette County Conservation District and Extension Office, First Link of the Bluegrass, Inc., Kentucky-American Water Company, Kentucky Division of Forestry, Kentucky Utilities, Kentucky Waterways Alliance, League of Women Voters, Lexmark International, and the University of Kentucky Department of Forestry. {Each year, Kentucky-American Water Company has donated \$5,000 to the project. Sponsors who contribute \$5,000 or more per year are called, “Friends of the Forest.”}

**Table 1.** Current tree species selected for the *Reforest the Bluegrass* project.

Common Name	Scientific Name	Recommended Planting Zones	RTB 2002 No. of trees ordered
Allegheny Serviceberry	<i>Amelanchier laevis</i>	1~2	900
Bald Cypress	<i>Taxodium distichum</i>	W	1,000
Blackgum	<i>Nyssa sylvatica</i>	W~1	1,000
Black Locust	<i>Robinia pseudoacacia</i>	2~3	500
Black Walnut	<i>Juglans nigra</i>	1	
Bur Oak	<i>Quercus macrocarpa</i>	2~3	1,000
Buttonbush	<i>Cephalanthus occidentalis</i>	W~1	
Eastern Redbud	<i>Cercis canadensis</i>	2~3	1,500
Green Ash	<i>Fraxinus pennsylvanica</i>	W~1	1,500
Hackberry	<i>Celtis occidentalis</i>	2~3	1,000
Kentucky Coffee Tree	<i>Gymnocladus dioica</i>	2~3	
Northern Red Oak	<i>Quercus velutina</i>	2	1,000
Paw Paw	<i>Asimina triloba</i>	2~3	1,300
Pecan	<i>Carya illinoensis</i>	1~2	
Persimmon	<i>Diospyros virginiana</i>	2~3	
Red Maple	<i>Acer rubrum</i>	1~2	1,000
Sassafras	<i>Sassafras albidum</i>	2~3	800
Shagbark Hickory	<i>Carya ovata</i>	1	
Shellbark Hickory	<i>Carya lacinosa</i>	1	
Shingle Oak	<i>Quercus imbricaria</i>	2~3	1,000
Shumard Oak	<i>Quercus shumardii</i>	2~3	1,000
Silky Dogwood	<i>Cornus amomum</i>	2	2,000
Spicebush	<i>Lindera denzoin</i>	1~2	2,000
Superior Cottonwood	<i>Populus deltoides</i>	1	1,000
Sugar Maple	<i>Acer saccharum</i>	1~2	800
Sweet Gum	<i>Liquidambar styraciflua</i>	W~1	1,000
Sycamore	<i>Plantanus occidentalis</i>	W~1	1,500
Tulip Poplar	<i>Liriodendron tulipifera</i>	1~2	1,500
White Ash	<i>Fraxinus americanus</i>	2~3	1,000
White Oak	<i>Quercus alba</i>	1~2	1,000
Wild Plum	<i>Prunus americana</i>	2	1,000

## ***Volunteer Coordination***

On the day of the planting event, volunteers are escorted into the field by Group Leaders who teach each citizen about the value of riparian forests in urban water pollution removal, the reduction of greenhouse-gases and the urban heat-island effect, and the enhancement of wildlife diversity. The volunteers are taught to use dibble bars to plant seedlings and then protect them from competitive vegetation using the tree mats. Once the group is finished planting the trees, about 20 per person, the volunteers are treated to a free t-shirt, pizza lunch, musical entertainment, the building of bird houses, and educational displays by various community organizations. Once the planting has occurred at each site, the areas are deemed as “no mow” zones, surveyed for specie survival rates, and monitored and controlled for animal browsing and impacts by invasive species.

## ***Volunteer Education***

*Reforest the Bluegrass* cannot be considered successful, no matter how many trees are put into the ground, unless there is a successful educational component. *Reforest the Bluegrass* is the perfect situation in which to foster an understanding of environmental issues that will lead to long-term positive environmental behavior. Through *Reforest the Bluegrass* there is an opportunity to expand the action and awareness components inherent in a reforestation project to a deeper understanding of watershed management on both a personal and community level. At the event, volunteers are treated not only to entertainment and food, but they have many opportunities to learn more about why they are participating in the event and what a difference their time and efforts are going to make for Lexington’s future.

## **Themes**

Communities have different environmental perspectives that should be taken into account when identifying educational themes for an event. For *Reforest the Bluegrass*, it was important for participants to obtain a historical sense of central Kentucky’s landscape and to develop a basic understanding of urban stormwater management. As previously mentioned, citizens need to be shown that the “Bluegrass Aesthetic” is not natural to the area and in fact, creates the environmental damage that citizens and elected officials are constantly complaining about – eroded stream channels, odorous, decaying algae clogging the creeks, disease carrying animals and insects, and loss of “quality of life.”

## **The Educational Process**

Understanding of the educational themes must be cultivated throughout the event process-before, during and after the planting. Citizens must be shown that it is through their own personal responsibility that they can achieve a desirable environment.

### ***Pre-Event***

Starting the educational process before the day of the event not only increases the amount learned by participants but it also helps in recruiting. If people understand why these trees need to be planted it gives them additional motivation to help.

It is important to utilize local TV and radio stations as well as local papers. Traditionally, one month prior to the event, a press conference is held. The Mayor, Vice-Mayor, major sponsors, lead organizing agencies, and other groups of importance are invited to participate. The one year that a press conference was not held, the week before *Reforest the Bluegrass*, an insert is put in the local paper. This insert contains the event location and time, a rain date, registration information, and suggestions on what to wear and bring. It also contains basic information on watersheds, stormwater management, and riparian areas, all applied to local waterways. It would be advisable to both hold the press conference and print the insert. Various TV and radio interviews are given in the weeks leading up to the event, in which information similar to that in the insert is shared.

### ***At the Event***

On the day of the planting event, volunteers are escorted into the field by Group Leaders who teach each participant basic information on the value of riparian forests in urban water pollution removal; the reduction of greenhouse gases; the urban heat-island effect; and the enhancement of wildlife diversity. The volunteers are taught to use dibble bars to plant seedlings and then protect them from competitive vegetation using the tree mats. The newly reforested area is not a pretty site. In fact, it looks like a field full of weeds and litter. Therefore, it is important to help volunteers appreciate the need for the forest successional process in order to create a population that is willing to tolerate, even defend, this young forest.

Once the group is finished planting trees, they are directed to a common area where there is food, entertainment, and educational booths. Various organizations from throughout the central Kentucky are asked to participate by bringing displays that will allow people to learn more about protecting and restoring our environment, particularly waterways. Groups that regularly participate in the *RTB* outreach area include: Bluegrass PRIDE, the Fayette County Conservation District, Wild Ones, Tree Guide, and environmental groups from the University of Kentucky. Each year the list expands. There is traditionally an erosion demonstration, a display board on riparian forests, an exhibit that labels and discusses the properties of the Reforest the Bluegrass tree species, and information on wildlife habitat. For *RTB* 2001 and 2002, there was a booth that offered children the opportunity to build birdhouses. During *RTB* 2002, one of the booths passed out grocery sacks so volunteers could pick up the litter that was prevalent on the site. Over 200 bags worth of litter was collected. This cleanup offered young children another activity in which they could participate.

In the outreach area, it is important to inform the adults, but it is also important to have booths targeting age groups that are too young to plant seedlings. Many families participate in *RTB*, so it is imperative to involve the entire family. If it is a successful family outing, it is likely that families will become annual participants.

A highlight of the 2002 event was the ceremonial planting of a Princeton elm, celebrating the planting of 100,000 *RTB* trees. The Mayor, Vice-Mayor, major sponsors, and other important local figures were invited to participate in this planting, which was covered by the local media. The tree is labeled with a plaque that explains its purpose and lists the "Friends of the Forest."

### ***Post-Event***

Now that an engaged population of volunteers has been empowered, it is important to encourage them to remember the lessons of the day and to present them with opportunities in which they can continue to be good stewards of their local environment. As people leave *Reforest the Bluegrass*, they are given a tulip

poplar, the state tree, to take home and plant. The participants are given a dichotomous tree key that aids in the identification of all species planted that day to encourage them to revisit the site. The volunteers also leave with a pamphlet that contains basic watershed and nonpoint source pollution information and details ways that they can continue their involvement in improving local waterways through adopting a stream, testing water quality, planting more trees, or labeling storm drains. Making a reforestation program an annual event is also a wonderful follow up. Many of the *Reforest the Bluegrass* volunteers are repeat participants.

## Conclusion

In just four years and eight events (four large, four small):

3,975 citizens trained!

108,000 trees planted!

140 floodplain forests restored!

\$85,000 local taxpayer money appropriated!

Over \$50,000 in donations raised!

The LFUCG *Reforest the Bluegrass* has captured the essence of the Clean Water Act. It has not only begun to restore the environment but it has done so through cultural change. It is a Public Works restoration project implemented by citizens. It is a successful long-term project because community leaders now understand that it is not just a “tree planting,” but a project which will increase the standard of living and community goodwill. The project leaders and the citizens who become “empowered watershed managers” realize they are a part of a monumental change in community values – to take personal responsibility for the environmental health of their community for today and for the future.

## References

1998 303(d) List of Waters of Kentucky, Kentucky Department for Environmental Protection, Division of Water, June 22, 1998.

Commonwealth Technology (CTI), 1998. Lexington-Fayette Urban County Government Stormwater Manual.

Commonwealth Technology (CTI), 1999. *Preliminary Engineering Report for Stormwater Management*. Lexington-Fayette Urban County Government.

Peter Schultz, Riparian Buffer Management System, Natural Resources and Environmental Management Department, Iowa State University, <http://www.buffer.forestry.iastate.edu/>.



# **STORM WATER PHASE I MS4 PERMITTING: WRITING MORE EFFECTIVE, MEASURABLE PERMITS**

Laura Gentile and John Tinger  
U.S. EPA Region IX  
San Francisco, CA

John Kosco, Wes Ganter, and James Collins  
Tetra Tech, Inc.  
Fairfax, VA

## **Abstract**

Approximately 1,000 municipal separate storm sewer systems (MS4s) are permitted under Phase I of EPA's storm water program. These Phase I MS4 permits require MS4s to reduce the discharge of pollutants to the maximum extent practicable and prohibit illicit discharges to the MS4. Permit writers have discretion to write permits specific to each MS4, or group of MS4s, resulting in a wide variety of permit requirements. When these permit requirements are not specific, determining compliance with the permit can become difficult.

The storm water Phase II program requires Phase II MS4s to include "measurable goals" in their program for each BMP. Phase I storm water MS4 permits are beginning to include these measurable goals allowing the permitting authority to assess whether each permittee is in compliance. Specific examples of MS4 permits with 'enforceable' permit language are presented and discussed.

## **Introduction**

On November 16, 1990, the U.S. Environmental Protection Agency (EPA) published regulations (the 'Phase I rule') requiring National Pollutant Discharge Elimination System (NPDES) permits for certain industrial, construction and municipal sources of storm water runoff and fundamentally changing the way storm water runoff is regulated at the state and federal levels. Approximately 1,000 MS4s ('municipal separate storm sewer systems'), consisting primarily of city and county government agencies responsible for storm water, have been permitted under the Phase I regulations. The Phase I MS4 regulations generally require MS4s to reduce discharges of pollutants to the maximum extent practicable and to prohibit illicit discharges to the MS4. Specific elements in a Phase I Municipal Storm Water Management Program include public education, public agency or municipal maintenance activities, new development, construction, industrial/commercial facilities, illicit discharges and improper disposal, monitoring and reporting.

Most Phase I MS4 permits have been individual NPDES permits, often issued to multiple co-permittees. Individual permits are written specifically to address the activities, pollutant sources, and discharges of the covered co-permittees.

Phase II of the storm water program, established in 1999, extends NPDES storm water permit coverage to include municipalities within urbanized areas. Phase II permits, to be issued beginning in March 2003, will in most cases be general permits issued to a broad range of permittees.

## **Storm Water Phase I Regulations**

The Phase I storm water rule defines “municipal separate storm sewer” at 40 CFR 122.26(b)(8) to include any conveyance or system of conveyances that is owned or operated by a state or local government entity and is designed for collecting and conveying storm water which is not part of a Publicly Owned Treatment Works (i.e., not a combined sewer). The Phase I MS4 regulations apply to MS4s serving populations of 100,000 or more. Some MS4s with populations under 100,000 can be designated for Phase I permit coverage. In addition to larger cities and counties, many state Departments of Transportation were also permitted under Phase I.

Phase I MS4 permits are required to establish controls to the maximum extent practicable (MEP) and effectively prohibit non-storm water discharges to the MS4. MEP has not been defined by EPA, but is intended to be flexible to allow the development of site-specific permit conditions based on the best professional judgment of the permit writer.

The Phase I regulations required a two-part application process for Large and Medium MS4s (40 CFR 122.26(d)). The regulations only specified application requirements, not permit requirements. Therefore, permitting authorities have various interpretations as to what should be required in an MS4 permit.

The Part 1 application required information regarding existing programs and the means available to the MS4 to control pollutants in its storm water discharges. In addition, Part 1 required field screening of major outfalls to detect illicit connections. Part 2 of the permit application required a limited amount of representative quantitative data and a description of proposed storm water management plans. The purpose of the two-part application process was to develop information that would build successful MS4 storm water programs and allow the permit writer to make informed decisions with regard to developing permit conditions.

State and EPA permit writers used the information contained in these Part 1 and Part 2 permit applications to write the individual NPDES permits. NPDES permits are issued for 5-year permit terms, with most of the first round MS4 permits containing fairly general requirements. In many cases, these permits simply require the permittees to implement the storm water management plan contained in the Part 2 application. Subsequent MS4 permits, particularly many implemented in California, are more specific and include more detailed requirements.

### **Permit examples: Unenforceable language**

NPDES permitting authorities must be able to determine compliance with individual permits. In traditional wastewater NPDES permits, this is a relatively simple process of verifying wastewater sampling results with permit discharge limits. MS4 permits are BMP-based, therefore determining compliance with the MS4 permit is more difficult. The examples presented below illustrate MS4 permit language that is vague and therefore difficult for an NPDES permitting authority to determine compliance. Without specific, measurable elements, almost any activity an MS4 takes could be deemed to be in compliance with the permit.

The permittee and permitting authority names have been removed, and the specific problems associated with determining compliance with this permit language are discussed.

### ***Example 1***

Permit Language:

The permittee shall demonstrate compliance with this Order through the timely implementation of control measures and other actions to reduce pollutants in discharges to the maximum extent practicable in accordance with their SWMP...”

This permit does not define what “timely implementation” is, allowing the permittee to determine what is timely. Timely implementation could be up to 5 years in the view of the permittee, or within 6 months in the view of the permitting authority. In addition, “other actions” are mentioned in the permit, but never described. If the permit is going to require “other actions,” then these actions should be specifically described in the permit.

### ***Example 2***

Permit Language:

“Structural controls for water quality improvements are considered for inclusion in site drainage plans, storm drain projects, and flood control projects where applicable.”

A permit should not require the permittee to “consider” an action; it should require the permittee to take an action. Also, “where applicable” leads to additional interpretation problems. If there are only certain circumstances where this permit provision should be applied, then those circumstances should be spelled out in the permit.

### ***Example 3***

Minimum best management practices (BMPs) include: standard plans and specifications, maintenance of storm drain systems, street sweeping, litter control, spill response, and hazardous material disposal.

This permit language lists a series of BMPs, but doesn’t specify where, how much, or how often the BMPs must be employed. For example, how often should the MS4 conduct street sweeping and how many miles need to be swept in order to be in compliance with the permit? The permit language above does not specify this.

### ***Example 4***

The permittee shall control pollutants in storm water discharges to the maximum extent practicable, and to demonstrate compliance with this requirement, the permittee shall implement in its entirety the proposed storm water management program (SWMP) described in ...

This permit requirement repeats the regulation language to control discharges to the “maximum extent practicable” without specifying exactly how that will be achieved. Implementation of a storm water management program (again, unspecified in the permit) is assumed to meet this standard. Unless the SWMP describes the activities and set specific performance expectations for those activities, compliance will be difficult to determine.

## **Permit Examples: Enforceable permit language**

The most difficult aspect of writing MS4 storm water permits is drafting permit language whereby compliance can be easily determined.

The following sections provide examples of permit language that provides more measurable permit language where compliance can be more easily determined.

*Construction Inspections Example:*

From the Orange County Municipal Storm Water NPDES Permit: (Board Order No. R8-2002-0010, NPDES Permit No. CAS618030)

Each permittee shall conduct construction site inspections for compliance with its ordinances (grading, Water Quality Management Plans, etc.) and local permits (construction, grading, etc.). Inspections shall include a review of erosion control and BMP implementation plans and an evaluation of the effectiveness and maintenance of the BMPs identified. Inspection frequency will, at a minimum, include the following:

- a. During the wet season (i.e., October 1 through April 30 of each year), all high priority sites are to be inspected, in their entirety, once a month. All medium priority sites are to be inspected at least twice during the wet season. All low priority sites are to be inspected at least once during the wet season. When BMPs or BMP maintenance is deemed inadequate or out of compliance, an inspection frequency of once every week will be maintained until BMPs and BMP maintenance are brought into compliance. During the 2001-2002 wet season, prior to the development of the inventory database, all construction sites must be visited at least twice. If a site is deemed out of compliance, an inspection frequency adequate to bring the site into compliance must be maintained;
- b. During the dry season (i.e., May 1 through September 30 of each year), all construction sites shall be inspected at a frequency sufficient to ensure that sediment and other pollutants are properly controlled and that unauthorized, non-storm water discharges are prevented; and,
- c. Information including, at a minimum, inspection dates, inspectors present and the results of the inspection, must be maintained in the database identified in Section VIII.1 or must be linked to that database. A copy of this database must be provided to the Regional Board with each annual report.

This permit language describes what needs to be conducted (inspections), when (October 1 through April 30) and how often (once a month). This ensures that both the permitting authority and the permittee understand what needs to happen to ensure compliance.

*Construction Training Example:*

From the Municipality of Anchorage and the Alaska Department of Transportation and Public Facilities NPDES permit: (NPDES permit No. AKS 05255-8)

“Permittee shall develop a training program for construction site operators and developers...within 24 months of the effective date of this permit. Permittee shall ensure that such training is provided at a minimum of once per year...”

This permit language specifies the action (a training program), a deadline for achieving the action (within 24 months), and a frequency for continuing performance (once a year).

*Illicit Discharge Example:*

From the City of Long Beach Municipal Storm Water NPDES Permit” (Board Order No. 99-060, NPDES Permit No. CAS004003)

“The Permittee shall inspect those portions of the storm drain system consisting of storm drain pipes 36 inches in diameter or greater, for illicit connections within 5 years after the permit is adopted.”

This permit provision specifies the minimum pipe size expected to be inspected and specifies that the permittee has up to five years to complete this task. Interim deadlines could also have been set here by, for example, requiring that at least 50% of these pipe are inspected within 3 years.

*Public Education Example:*

From the City of Stockton and County of San Joaquin Municipal Storm Water NPDES Permit: (Board Order No. R5-2002-0181, NPDES Permit No. CAS083470)

At least three times during the life of the permit, Permittees shall send information on problems caused by storm water runoff and potential solutions to each household within the service area.

Both a timeframe (life of the permit, or 5 years) and a target number (each household within the service area) are specified along with a quantity (three times) in this public education example.

*Industrial storm water inspection example:*

From the Orange County Municipal Storm Water NPDES Permit: (Board Order No. R8-2002-0010, NPDES Permit No. CAS618030)

“After July 1, 2003, all high priority sites are to be inspected at least once a year; all medium priority sites are to be inspected at least once every two years; and all low priority sites are to be inspected at least once per permit cycle.”

This permit language sets specific inspection frequencies for high, medium and low priority industrial facilities. In order to be effective, the permit must also specify, or provide a clear expectation, of the types of facilities that should fall into each priority category.

*Municipal Maintenance Example:*

From the City of Long Beach Municipal Storm Water NPDES Permit: (Board Order No. 99-060, NPDES Permit No. CAS004003)

Catch basin maintenance, under Permittee’s jurisdiction, shall include:

- a. All catch basins will be cleaned out and inspected one time between May 1 and September 30 of each year; and,
- b. All catch basins that are at least 40% full of trash and debris between October 1 and April 30, shall be cleaned-out.

This permit provision sets the amount expected (all catch basins), the time frame (May 1 to September 30), and the frequency (each year). It also establishes a performance expectation for when a catch basin should be cleaned.

*New Development – Maintenance example:*

From the Los Angeles Region Municipal Storm Water NPDES Permit: (Board Order No. 01-182, NPDES Permit No. CAS004001)

“Maintenance Agreement and Transfer

Each Permittee shall require that all developments subject to SUSMP and site specific plan requirements provide verification of maintenance provisions for Structural and Treatment Control

BMPs, including but not limited to legal agreements, covenants, CEQA mitigation requirements, and or conditional use permits. Verification at a minimum shall include:

- a) The developer's signed statement accepting responsibility for maintenance until the responsibility is legally transferred; and either
- b) A signed statement from the public entity assuming responsibility for Structural or Treatment Control BMP maintenance and that it meets all local agency design standards; or
- c) Written conditions in the sales or lease agreement, which requires the recipient to assume responsibility for maintenance and conduct a maintenance inspection at least once a year; or
- d) Written text in project conditions, covenants and restrictions (CCRs) for residential properties assigning maintenance responsibilities to the Home Owners Association for maintenance of the Structural and Treatment Control BMPs; or
- e) Any other legally enforceable agreement that assigns responsibility for the maintenance of post-construction Structural or Treatment Control BMPs.”

In this example, SUSMP stands for Standard Urban Storm Water Mitigation Plan and is a relatively new requirement in California MS4 permits to address post-construction storm water impacts. CEQA is the California Environmental Quality Act that requires environmental review of certain projects.

These permits provide more specifics, including set frequencies, deadlines, and detailed expectations for the permittees. This allows both the permittees and the permitting authority to determine compliance.

## **Effective MS4 Permit Writing**

NPDES MS4 permits and MS4 stormwater management programs must contain quantifiable, measurable elements so that compliance can be determined. Storm water permits vary significantly in their level of detail. For example, some third-term permits issued in California contain very specific, measurable elements which are clear for permittees to implement and relatively straightforward for the state to determine compliance. For nonspecific permits that simply require the MS4 to “implement a storm water management plan,” compliance becomes more difficult. More importantly, the permit does not specify, or measure, the level of effort expected, so MS4s do not have a clear target to achieve.

The storm water Phase II regulations require small MS4s to develop “measurable goals” for each BMP in their programs. These measurable goals are intended to provide quantifiable targets for the MS4s to achieve in the implementation of BMPs. Although a similar requirement does not specifically exist for Phase I, permits and programs developed under Phase I should also contain these measurable goals. This provides a level of certainty to the MS4 that they are successfully implementing the permit and allows the state to more easily evaluate compliance.

Some MS4 permits in California include specific, measurable requirements that make determining compliance easier. Also, the City and County of Sacramento have developed stormwater plans that are clear, well-written, and begin to address the issue of measurable goals which are called ‘minimum performance standards’ and ‘performance and effectiveness measures’, respectively, in each plan (City of Sacramento, 2000 and County of Sacramento, 2000).

In order to be measurable, each permit requirement should specify:

- *What* needs to happen
- *Who* needs to do it
- *How much* they need to do
- *When* they need to get it done
- *Where* it is to be done

For each permit requirement, “*what*” is usually the BMP or activity required, “*who*” in most cases is implied as all the permittees (although in some cases the permitting authority may need to specify exactly who the require applies to), “*how much*” is the performance standard the permittee is expected to meet (how many inspections), “*when*” is a specific time (or a set frequency) when the BMP or activity should be complete, and “*where*” is the specific location or area (if necessary). Without these specifics, it is almost impossible for the permitting authority to determine compliance with a vague MS4 permit.

Writing more specific, measurable permits will take more time and resources than writing less specific ones. For Phase I MS4 permits, which are in some cases entering their 3<sup>rd</sup> round of MS4 permits, these more specific permits are becoming a necessity. States are finding that both the regulated community and the public are demanding more accountability, which the specific, measurable permits provide.

## Conclusions

With over 1,000 large cities, counties, and other governmental organizations under storm water Phase I MS4 permits, a significant amount of money is being spent implementing these programs. Unless the permits are written with specific, measurable requirements, determining compliance with permits is often difficult, if not impossible.

Permit writers can develop these specific, measurable permit requirements by building upon existing storm water permit programs and ensuring that permit elements address:

- *What* needs to happen
- *Who* needs to do it
- *How much* they need to do
- *When* they need to get it done
- *Where* it is to be done

As Phase II MS4s begin the process of identifying measurable goals for each of the BMPs in their program, permits issued to the larger, more mature Phase I MS4 programs should include these same measurable elements.

## References

City of Long Beach Municipal Storm Water NPDES Permit (Board Order No. 99-060, NPDES Permit No. CAS004003) issued July 1999 by the California Regional Water Quality Control Board, Region 4.

City of Sacramento, 2000. *Stormwater Quality Improvement Plan*, Draft.

City of Stockton and County of San Joaquin Municipal Storm Water NPDES Permit (Board Order No. R5-2002-0181, NPDES Permit No. CAS083470) issued October 2002 by the California Regional Water Quality Control Board, Region 5.

County of Sacramento, 2000. Stormwater Quality Improvement Plan for County of Sacramento and Cities of Citrus Heights, Elk Grove, Folsom, and Galt. Draft.

Los Angeles Region Municipal Storm Water NPDES Permit (Board Order No. 01-182, NPDES Permit No. CAS004001) issued December 2001 by the California Regional Water Quality Control Board, Region 4.

Municipality of Anchorage and Alaska Department of Transportation and Public Facilities (NPDES permit No. AKS 05255-8) issued January 1999 by the U.S. Environmental Protection Agency, Region X.

Orange County Municipal Storm Water NPDES Permit (Board Order No. R8-2002-0010, NPDES Permit No. CAS618030) issued January 2002 by the California Regional Water Quality Control Board, Region 8.



# CONSERVATION DESIGN TOOLS FOR STORMWATER MANAGEMENT

Randell K. Greer, P.E.

Delaware Department of Natural Resources and Environmental Control  
Dover, DE

## Abstract

The release of Delaware's "*Conservation Design for Stormwater Management*" document in 1997 provided guidance to land use planners and civil site design consultants in the application of conservation design principles to meet regulatory stormwater management requirements. Proof of concept in this document relied on traditional techniques based on NRCS methodology, such as "*Technical Release No. 55*", to verify the results. However, this was a cumbersome approach, since these methods do not easily model Best Management Practices (BMPs) such as biofiltration swales, bioretention practices and riparian buffers. It became apparent that new tools would have to be developed to model these practices so that prospective developers were given full credit for their implementation. As a result, the Delaware Department of Natural Resources and Environmental Control (DNREC) with assistance from outside contractors, have developed two design tools for use with this so-called "Green Technology" approach to stormwater management. The Delaware Urban Run-off Management Model (DURMM) accounts for both disconnection of impervious area as well as the "run-on" process to derive both the volume and rate of run-off from a given site. A decision tool is also being developed based on USDA's Riparian Ecosystem Management Model (REMM) for designing riparian buffers in an urban environment for both quantity and quality control of stormwater runoff. This decision tool is still under development. Therefore, this paper will focus on the development of DURMM and how it will be used to fulfill the Delaware regulatory requirements for stormwater management. It is also felt that both these tools have application outside the State of Delaware, with the caveat that the local regulatory authority conducts proper testing and verification.

## Background

The State of Delaware has had a Sediment & Stormwater Law in effect since 1990. While the law and subsequent regulations were instrumental in mitigating many of the negative impacts associated with urbanization, it soon became clear that traditional approaches were leading to an over dependence on structural practices. If this trend were to continue, the operation and maintenance requirements for these structural practices would become a tremendous burden for the entities responsible for them. In 1996, the Delaware Department of Natural Resources and Environmental Control partnered with the Brandywine Conservancy to develop a manual for a new approach to stormwater management. The goal would be to mimic the natural hydrology of a site as much as possible without relying on structural practices. This new approach to stormwater management was referred to as "Conservation Design".

The "Conservation Design for Stormwater Management" document was released in September, 1997. It provided background information on the hydrologic impacts associated with urbanization and explains how making better use of the existing physical features of a site can minimize the increases in stormwater runoff that often accompanies land development. This can be accomplished by altering the building program, minimizing impervious surfaces and

disconnecting those impervious surfaces wherever possible. Where additional management is required to meet regulatory requirements, the emphasis is on non-structural measures, or “Green Technology BMPs”, such as vegetated swales, biofiltration practices, terraforming, riparian buffers, etc.

Proof of concept for the Conservation Design approach was provided through six case studies of actual development projects throughout the State. The traditional development plans were conceptually redesigned utilizing the Conservation Design principles, while maintaining the original density and unit counts. Stormwater management computations were also completed to ensure full compliance with the existing regulations. These computations were based on traditional NRCS methodology. Although the results confirmed the benefits, it proved to be a rather tedious process. It was clear that an improved methodology would be necessary to take full advantage of this approach. With the assistance of several outside contractors, the DNREC has developed two design tools, the Delaware Urban Runoff Management Model (DURMM) and the Urban Riparian Buffer Design Decision Tool, that will hopefully fill this need.

## **Delaware Urban Runoff Management Model (DURMM)**

Traditional structural BMPs such as stormwater ponds and wetlands can be effective in controlling peak flows from a site. However, current regulatory requirements in the State of Delaware do not address the frequent storms that erode stream banks, and do little or nothing to promote recharge. Furthermore, structural BMPs can contribute to downstream flooding when discharges from separate on-site structural BMPs overlap. Structural BMPs can be effective in pollutant removal; but since they generally omit recharge, consume space, and require extensive maintenance, they are less appropriate for the task. There is an emerging body of research indicating that these BMPs contribute to elevated stream temperatures, and discharge algae laden effluent, which can substantially degrade the benthic community in the receiving stream [Delaware Department of Natural Resources and Environmental Control and B. Lucas, 2002].

As a result, many progressive agencies are promoting a less structural approach, designed to intercept runoff from rooftops, parking lots and roads as close as possible to its source, and direct it into recharge/filtration facilities incorporated into the overall site design and runoff conveyance system. Nonstructural BMPs thus include impervious area disconnection, conveyance of runoff through swales and biofiltration swales, filter strips, terraces, bioretention facilities, and infiltration facilities. However, while these BMPs may seem less significant than structural BMPs, the procedures for their proper design require the same hydrologic and hydraulic methods used in designing structural BMPs. Otherwise, realistic estimates of effectiveness are difficult to quantify. These so-called “Green Technology BMPs”, form the basis of DURMM at the site engineering level.

The BMPs addressed in DURMM and pertinent aspects of their design and performance are briefly summarized below:

**Source Area Disconnection-** Disconnecting flow from impervious surfaces so it discharges onto adjacent pervious areas provides additional infiltration and potential for some pollutant removal.

**Filter Strips-** This BMP provides for runoff to be spread uniformly over a filtering surface of vegetation, which can provide substantial treatment if not overloaded by sediment and runoff.

**BioFiltration Swales/Grassed Swales-** Research shows that overland conveyance through properly designed swales can be very effective in removing Total Suspended Solids (TSS) and adsorbed metals, although less effective in terms of nutrients. While swales are not thought to be capable of quantity management, designs incorporating check dams can provide substantial attenuation of peak flows.

**Terraces-** Terraces are essentially swales extending across slopes to intercept runoff and increase the potential for infiltration. Terraces are similar to swales in terms of runoff responses and pollutant removal with the exception that flow exfiltrates laterally.

**Bioretention Structures-** These landscaped pocket depressions incorporated into the urban landscape can provide substantial filtering and nutrient transformations before runoff is discharged into the conveyance system. Ongoing research suggests that this BMP can be designed to have substantial nitrogen removal capabilities, unlike most other BMPs. [Delaware Department of Natural Resources and Environmental Control and B. Lucas, 2002].

**Infiltration Practices-** Most non-structural BMPs incorporate infiltration as part of the treatment process. Specific infiltration facilities include trenches, basins and dry wells. Infiltration trenches located in swales provide additional wetted surface area and storage volume, and often they can be designed to penetrate shallow impermeable soil profiles to recharge deeper soil horizons.

Unfortunately, while there is great interest in using nonstructural BMPs, there are few rigorous procedures available for the engineering and regulatory community to utilize in designing them. Many regulatory programs use a straightforward runoff volume approach, in which the increase in small storm runoff volume due to land development is to be treated and/or retained on site. However, this approach typically assumes a constant runoff volume in proportion to rainfall amount, and does not route runoff through nonstructural BMPs. Instead, simplified volume/outflow equations are specified, without knowing precisely how they work during storm events. When this approach leads to overdesign, it may be beneficial if the original reduction targets are inadequate, otherwise it causes unnecessary expense. Where it leads to underdesign, the hydrological impacts are not adequately mitigated.

DNREC has partnered with a private consultant, Mr. William Lucas of Integrated Land Management, Inc., to create DURMM to provide a more rigorous hydrological design tool for nonstructural BMPs. A spreadsheet program is provided that incorporates modified TR-20 storm hydrology to project the hydrological response from contributing source areas. It segregates directly connected runoff from that which flows overland. It provides routines that account for the reductions in peak flow due to overland conveyance. In this way, it is possible to more precisely determine the actual volume and peak rate reductions over the duration of a 24 hour storm event, and through the following days. This is particularly important for calculating total infiltration, and designing proper stream bank erosion controls. Furthermore, since the design community is already familiar with TR-20 input variables, the same input data parameters required for design of flood controls can be used for design of quality treatment, streambank protection, and conveyance runoff events.

The process of BMP design involves a spreadsheet file for each source subarea and its BMP. Discrete combinations of hydrological soil group and land cover are averaged to generate composite Curve Numbers (CN)

for the pervious and impervious portions of each source area. Impervious areas are calculated separately, and routed according to the extent of their linkage with adjacent pervious surfaces. The resulting runoff hydrograph from the source area worksheet is imported into the BMP hydraulic design worksheet. Pollutant loading is calculated by applying typical event mean concentrations (EMCs) to the runoff volume allocated to each type of pervious and impervious surfaces.

Site design parameters of infiltration rates, surface and subsurface stage/storage, and outflow controls are entered into the BMP worksheet. The worksheet routes the source area hydrograph through the BMP based upon the input parameters. The resulting output displays peak flows, flow duration and infiltration volume for each storm event.

By segregating subarea loads according to the type and extent of land cover, the discrete source area approach used in the hydrologic calculations refines accuracy in estimating total pollutant loads. Pollutant removal by the BMP is based upon physical parameters such as slope, pretreatment volume, hydraulic residence time, surface/volume ratio, filter media type, and underlying infiltration characteristics. Given these factors, pollutant load reduction is calculated by algorithms relating input concentrations and decay transformations to estimated mass removal for each pollutant of concern.

The reported pollutant removal effectiveness of BMPs can be highly variable. However, by incorporating hydrologic and hydraulic parameters in runoff routing, and addressing the various removal processes as discrete algorithms within a BMP, more accurate estimates of removal rates are possible. Some variability in projected removal rates is acceptable in any event, since hydrological changes are recognized as perhaps the primary impact of runoff. Furthermore, polluted runoff from the most frequent storms that causes the greatest stress can often be eliminated by the infiltration components of nonstructural BMPs.

## **Conclusions**

The Delaware Urban Runoff Management Model (DURMM) was developed to facilitate the adoption of so-called "Green Technology BMPs" in the land development process. This tool is based on rigorous, physically-based methodologies. Yet at the same time, it has advantages in ease of use over the traditional models now being used for stormwater management analysis. It is hoped that the additional development of the riparian buffer decision tool based on the REMM will provide designers with two powerful, quantitative tools that will further encourage the use of Conservation Design techniques.

The DNREC is currently embarking on an extensive outreach and education effort with the design community to introduce this tool and familiarize them with its mechanics. It is anticipated that this effort will allow designers to become proficient with its use within a year's time.

## **References**

Delaware Department of Natural Resources and Environmental Control and The Brandywine Conservancy, 1997. "Conservation Design for Stormwater Management". Dover, DE.

Delaware Department of Natural Resources and Environmental Control and B. Lucas, 2002. "Delaware Urban Runoff Management Model: A Technical Manual for Designing Green Technology BMPs to Minimize Stormwater Impacts From Land Development". Dover, DE

Delaware Department of Natural Resources and Environmental Control and B. Lucas, 2002. "Delaware Urban Runoff Management Model: A Users Manual for Designing Green Technology BMPs to Minimize Stormwater Impacts From Land Development". Dover, DE

# USING TECHNICAL DATA AND MARKETING RESEARCH TO CHANGE BEHAVIOR

Stephen Groner  
S. Groner Associates, Inc.  
Long Beach, CA

## Abstract

The City of Los Angeles is faced with the task of educating over three million residents regarding the various pollutants effecting water quality. With limited resources, the City is challenged with effectively reaching and influencing the greatest number of residents who have the greatest impact on improving water quality.

To develop this program, S. Groner Associates, Inc. (SGA) was hired by the City to develop and implement a strategic social marketing plan based on technical data and marketing research. The goal of the plan was to target audiences who have the greatest impact on water quality. With those key groups in mind, outreach efforts were developed based on the specific audiences' attitudes, styles, and behaviors. This would focus resources most cost effectively on efforts with the greatest chance to influence behavior change and thus prevent pollution.

In developing the plan, we used technical data analysis and existing market research information to determine the following:

- ◆ activities posing the greatest threat to water quality
- ◆ activities/behaviors most influenced by public education
- ◆ audiences engaged in those activities
- ◆ psychographics of the audience (i.e., attitudes, characteristics and styles of the audiences)
- ◆ methods to reach our audiences to increase the influence of the outreach

These key points served as the foundation for developing outreach efforts as well as the emphasis, style, and tone of our communication pieces.

This presentation reviews the role of market research and data analysis in developing a social marketing plan, in addition to designing marketing materials and implementing the outreach efforts. We will also illustrate how incorporating new marketing data helped gage the outreach's successes and areas for further refinement.

## Building a Foundation for the Marketing Plan

Effective outreach requires developing a solid information base about behaviors you want to change. The information ascertained assists in determining how and who to target in order to maximize the impact on improved water quality.

This information is highly effective when developing a social marketing plan for stormwater pollution. Building the marketing plan's foundation, however, is still very difficult because of the complexity of stormwater. By its very definition, stormwater pollution or non-point pollution is not one single source, but a complex collection of problems to target. In turn, developing a marketing plan for stormwater pollution is

not just about developing one plan to address one issue. It requires a multi-pronged campaign that attacks the various causes of stormwater pollution. The plan must be composed of several focused marketing strategy's each addressing the most problematic pollutants/behaviors.

Because of the issue's complexity, understanding the limits of your resources and strategically focusing your outreach to maximize impact is essential. In determining our outreach, we used both technical data and existing market research information to strategically lay out our direction for public education. This process included the following steps:

- Determine the pollutants/activities posing the greatest threat to water quality
- Determine what corresponding activities/behavior are best influenced through public education
- Identify the audiences engaged in those activities/behaviors
- Understand the psychographics of the audiences (i.e., attitudes, characteristics and styles of the audiences)
- Understand the motivators that will best influence our audiences

Any effective marketing plan or outreach effort must be designed with an intimate understanding of the audience that you are targeting. Many times, there is a misconception that because the issue is important people will automatically listen to it. But the message is competing for attention with thousands of other messages that bombard residents everyday; everything from ads selling cars and beer, to other social marketing ads like recycling campaigns, anti-smoking campaigns, or drug prevention campaigns. In the end, if the outreach piece is generic and does not in some way connect with a specific audience and compel them to listen, they won't.

This paper lays out the methodology used to develop a solid social marketing plan and introduces the City of Los Angeles' public education program as an example of this type of strategic planning's success.

### **Prioritizing Pollutants**

The first step in targeting outreach is determining the pollutants that pose the greatest threat to water quality. This effort requires an analysis of water quality data and reconciling this information across watersheds if the jurisdiction covers more than one watershed.

In conducting this technical research for the City of Los Angeles, we worked with GeoSyntec Consultants, Inc. to evaluate and analyze water quality data from the City and County of Los Angeles. The City of Los Angeles lies within three primary watersheds and a multitude of subwatersheds. The three primary watersheds all have broad similarities of a mostly urban environment. However, at the subwatershed level, there were vast differences in the environment.

After results were evaluated, five pollutants were selected for the campaign:

- Bacteria/Pathogens
- Pesticides
- PAH's
- Nutrients
- Trash and Debris

## **Prioritizing Activities to Target**

Prioritizing activities requires balancing technical information about pollutants with an understanding of which pollutants are most effectively targeted through public education.

Based on this, we looked at activities that produce pollutants and prioritized which activities could most effectively be targeted. The following criteria served as a guideline for prioritization:

- How pervasive the activity is across the target area
- How active or passive is the polluting activity
- How effective behavioral BMPs are vs. structural BMPs
- How complex or simple the solutions are to implement and
- Where possible evaluate the proportion of pollution the activity contributes to the total pollutant load

Ideally, this process begins with analyzing pollutant source data. However, given the nature of stormwater/non-point source pollution, this information may not be available for most jurisdictions, so there is a need for best judgment.

In addition, the area and process of evaluation, be it individual watershed, across a jurisdiction, or across a regional area, must be determined. This issue is important for obvious environmental science reasons as well as strategic marketing reasons. For example, a pollutant or activity in one watershed may be prioritized differently if evaluated in different areas because of the watershed's maximum sustainable load. But from a marketing perspective, this determination will be critical in determining what outreach methods are most effective and available in the area to reach the target audience. For example in some areas billboard advertisements or newspaper advertisement may target the area and activity well, while in other areas an activity may be best targeted through point of purchase advertising.

Applying the above criteria helped prioritize the activities as the following:

- **Bacteria/Pathogens**
  - *Leaks from sewer systems – low*
  - *Improper BMPs at Restaurants – medium*
  - *Owners picking up after their dogs – high*
  - *Improper BMPs by horse owners – low region wide - high in certain subwatersheds*
  - *Proper maintenance by septic system owners – low region wide - medium in certain subwatersheds*
- **Pesticides**
  - *Residential users - high*
  - *Commercial users - low*
  - *Government users – medium*



- **PAH's**
  - o *Vehicle leaks – low*
  - o *Improper BMPs at auto repair shops/gas stations – medium*
  - o *Improper disposal of vehicle fluids by residents – high*
  
- **Nutrients**
  - o *Fertilizer application by residents – high*
  - o *Proper maintenance by septic system owners – low region wide - high in certain subwatersheds*
  
- **Trash/Debris**
  - o *Active littering by residents - high*
  - o *Litter from uncovered trash containers – low*
  - o *Litter from uncovered commercial vehicles - low*

## **Identifying Audiences**

In selecting a target audience, the program's developmental focus shifts from the technical field to the marketing arena. Marketing research is key to identifying which audiences, or in marketing terms "segments of the population," are engaged in the problematic behavior. The next step is discovering common characteristics among the audience and developing a focused message that is tailored to their interest and motivations.

The best way of collecting this information is to conduct surveys of residents. The survey would incorporate questions to ascertain what types of residents are engaged in the improper behavior. Cross referencing the results with psychographic information (i.e., attitudes, behaviors, lifestyles, which "segments of the populations"), helps target how to best address the issue and change behavior.

This approach, however, can be expensive. Depending on the campaign's size, less expensive and simplified research can yield similar information. One effective method is matching up behavior with a consumer market. For example, when targeting people who improperly dispose of their oil, you can target people who buy oil and identify them as consumers at auto parts stores. While this will not narrow your audience down to only those who are illegally dumping their oil, it serves as a solid starting point for further refinement. Later, a simple intercept survey conducted at auto parts stores can help better assess the audience and hone strategies to target the audience.

Another cost-effective way to understand your audience is through the use of the US Census Bureau's Web site. The Census Bureau's site gives demographic and socio-economic information broken down by city, zip code, and census tract. The site allows you to import the data to spreadsheets or even use a Web based GIS software program to map the data. This information is extremely valuable in targeting an activity that may focus in on a specific area. One example would be targeting homeowners in a specific area. From the website, you could identify homeownership rates and then correlate that to other demographic and socio-economic information such as income levels, languages most commonly spoken, ethnic background, employment rates, etc.

## **Understanding Psychographics**

Once the target audience is identified, the next step is understanding the "psychographics" of the audience (their attitudes, interests, and styles). This information provides insight into the audience's thoughts and is

an essential step in designing effective outreach. Without outreach efforts/messages that connect directly to a group's sensibilities, interests, or concerns, changing a habit is almost impossible.

Obtaining an audience's psychographic information is more difficult than merely identifying the audience. To gather information regarding attitudes, marketing surveys are critical. The surveys gather relevant information by correlating residents' interests and priorities with their activities and behaviors. The resulting information helps isolate key issues and motivators relevant to the audience.

Depending on survey results regarding a target audience's priorities and motivators, an issue could be positioned in various ways. For example, the issue of pesticide use could be presented with three different focuses depending on the audiences' psychographics:

- 1) as an environmental issue (chemicals impact on the watershed),
- 2) as a "dollars and cents" issue (addressing the source is cheaper than treating the problem), or
- 3) as a family/child safety issue (safety concerns of children playing on a lawn with chemicals).

Understanding the psychographics of the target audience, simplifies choosing the most meaningful and effective message.

If creating and/or performing a survey is not possible, relevant information based on a similar issues or audiences can be frequently found in marketing surveys completed by other organizations. In researching segmentation information for the City of Los Angeles, SGA based its information on three previously completed marketing research surveys that could be analyzed for information relevant to the City's demographics characteristics: two were conducted by the County of Los Angeles (one on stormwater issues and one focused on do-it-yourselfers) and one conducted by the State (on residential used oil recycling).

The resulting information gave SGA a full picture of various target audiences and helped differentiate our messages based on each particular audience. Based on the results from our marketing research and technical data, we identified and prioritized our three main target audiences:

### ***1) Neat Neighbors -***

**Description - Younger families with children who want to do the right thing but needed a little coaxing**

**Motivators to change – Concern about children, concerned about the neighborhood, interested in doing what's good for the environment**

**Activities/Behaviors – Picking up after pets, pesticide and fertilizer use**

### ***2) Fix-it Foul-ups -***

**Description - Middle class homeowners who are do-it-yourselfers**

**Motivators to change – Put family first, want to follow rules, not interested in the environment**

**Activities/Behaviors – Pesticide and fertilizer use**

### ***3) Rubbish Rebels -***

**Description - Younger males who are just getting out on their own**

**Motivators to change – Concern with their image and peer's perception of them; following rules is not "cool"**

## Activities/Behaviors – Littering and used oil disposal

### Strategic Outreach

The last element is determining the best outreach efforts to effectively reach the target audiences. The goal is to identify outreach efforts that strategically delivers the message and increases the message's influence on their behavior. SGA looked at three elements in evaluating the outreach strategy:

- 1) How timely is the message in relation to the activity
- 2) How well placed is the message to reach the target audience
- 3) How well delivered is the message to catch the attention of the audience

These three elements help compare potential outreach methods in terms of the ability to reach and influence the audience. The first element addresses the issue that people receive information all the time, but unless it is delivered at a relevant time, the audience may not focus their attention and note the information. A good example of this is giving out information on pet care when one gets a pet. The timing is perfect because the owner is excited about the pet and is open to learning about them. Delivering the pet message at this time also increases the likelihood of changing behavior because the owner has not developed bad habits yet.

The second element addresses the quality and focus of outreach aimed at the target audience. For example, an ad in a newspaper regarding pesticide use may reach a large number of residents but may not be strategically placed, and therefore, does not effectively reach the target audience. However, an ad placed in the weekly "Home and Gardening" section of the newspaper would be far more effective because it was strategically placed in an area relevant to the specific readers of that section.

The third element addresses how effectively the outreach method catches the audience's attention. For example, a small logo placed on a banner for an event may not be noticed next to a dozen other logos. However, a well placed booth at an event with a staff member actively approaching the target audience (as opposed to waiting for them to approach the booth) can be far more effective.

Examples of how these evaluations helped in developing strategic outreach methods to address high priority activities for the City are the following:

#### *Picking Up After Your Pet*

- **Material placement at animal shelters and inclusion with pet adoption materials**
- **Participation a pet adoption events held by animal shelters**
- **Point of purchase displays at pet stores**
- **Material placement at veterinary clinics**

In this effort, we partnered with animal shelters. This allowed us to deliver our message to residents who were planning on adopting new pets. We accomplished this by placing our information in animal shelters' adoption package- an item given to all new pet owners. To reach the same audience, we also set up a booth and distributed



information at pet adoption events. This outreach strategically accomplished three goals:

- 1) ensured our information would be received by the new pet owner,
- 2) allowed us to get our information to the owner at a point in time when they are most interested in learning about the new pet and
- 3) delivered the information to the owner before they developed bad habits regarding their pet’s care.

In addition to animal shelters and pet events, pet stores and veterinary clinics were utilized as key venues for outreach. Materials were strategically placed in immediate view of our target audience at a time when they were thinking about their pet (i.e., shopping for their pet or bringing the pet in for medical attention).

### ***Pesticide and Fertilizer Use***

- **Partnership with home improvement stores**
  - o Develop point of purchase displays
  - o Conduct staff training to enable employees to answer questions
  
- **Placed radio ads on a local weekend gardening show**

This effort entailed partnering with the major home improvement chains (Home Depot, Lowe’s, OSH) and obtaining pro bono placement of materials on the shelves where pesticide and fertilizer products are sold. This put the information in the audience’s direct view at the point in time when they were deciding what product (toxic or non-toxic) to purchase. We then trained store staff on the issues concerning urban runoff and pollution prevention issues. The result gave us credible advocates for our message right on the “frontlines.”

Along with that effort, we sponsored a local weekend talk show about gardening. This effort was strategic in two ways:

- 1) it was targeted directly at residents most likely to use fertilizers and pesticides and,
- 2) the program aired on the weekend, a time when residents are likely to be engage in their gardening or lawn care activities.



## *Used Oil Recycling*

- **Partnerships with car clubs**
- **Strategic radio advertising**
- **Partnerships with auto parts stores**

In this effort, we faced the challenge of reaching an audience that did not want to be reached; younger males who didn't care about the environment or recycling their oil.



To reach this audience, we focused less on the message and more on the campaign's image as well as the person delivering the message. In reaching the audience, the messages were delivered through peers and at familiar venues. For example, booths were set up at lowrider car shows, but rather than staffing the booth ourselves, SGA teamed up with lowrider car clubs. The car clubs then brought their cars and distributed our message. This gave the campaign credibility with our audience, helped build a brand image for the campaign and made the campaign "peer to peer."

Another part of this effort was placing ads on radio stations our audience identified with. Based on the marketing research, we were able to identify the radio stations our audience listened to most. We then placed ads on their weekend program, which allowed us to air our ads around the time when do-it-yourselfers change their oil.

The last effort was to place materials in auto parts stores. SGA did this by placing floor graphics in front of the oil products shelf, posters in storefront windows, and counter cards by the cash register. This effort ensured that our message reached those buying new oil and hit them when they were focused on their vehicle.

## **Results/Evaluation**

Determining the effectiveness of outreach is a critical element in any public education campaign. Obtaining results and feedback allows you to refine your outreach efforts and tweak your strategy to improve your efforts. However, in tackling outreach on stormwater pollution, certain targets may be extremely difficult to obtain good information on, while other activities may be straightforward. The key is to set up several feedback points. While none may be perfect, the goal is to collect enough data to determine a trend and give a sense of the program's effectiveness.

This was exactly the case in the City's campaign. In evaluating our outreach on used oil, SGA had two solid methods of obtaining feedback. The methods were 1) surveying auto parts stores regarding how much used

oil they were collecting and 2) tracking the number of calls to the environmental hotline asking for information on used oil recycling. In both cases, our numbers went up.

- 1) Used oil collection – 9% increase over the previous year
- 2) Call to the hotline – 120% increase over the previous year

In evaluating pesticide/fertilizer and pet outreach, we could only rely on indirect methods.

For outreach targeting pesticides and fertilizers, we evaluated participation at household hazardous waste collection events and conducted qualitative quizzes during employee training classes. The results from collection events showed over a 10% increase in volume collected, however the training classes showed only an adequate retention of information (based on trainer’s judgment no actual data collected). The feedback on the training classes, while not positive, proved helpful. SGA concluded from the information that shorter periods between training classes are needed to address employee attrition and bring new employees up to speed on the program.

In our outreach to target pets, we focused our evaluation on surveying pet owners at adoption events. At this point, we have no clear feedback yet. Our goal is to build up a database of information regarding the habits of pet owners and then determine if habits change over time. Currently, we are still developing our baseline.

## **Conclusion**

Overall, there are a multitude of outreach efforts that can be implemented, however, most programs have very limited resources as well as the tough challenge of trying to change someone’s behavior. Many consumer marketing campaigns have huge budgets completely dedicated to marketing and advertising a simple message such as switching brands. Our challenge is marketing an issue and in sighting a behavioral change that may be inconvenient. This challenge is increased when combined with a lack of resources. Therefore, developing a smart social marketing plan is imperative to successfully implement outreach.

Additionally, developing a social marketing plan helps guide and direct a strategic public education campaign. Given the complexity of stormwater pollution, it is an invaluable tool in analyzing all the potential options/directions for the campaign. To effectively maximize limited resources, strategic planning using technical data to target the activities combined with the use of marketing research, is critical. These two pieces of information (the data and research) help ensure that the outreach is targeted at the highest priorities and that limited efforts can be as effective as possible. In the end, the more information gathered about pollution, behaviors, and your audience, the better your chances of success.

# EVALUATING INNOVATIVE STORMWATER TREATMENT TECHNOLOGIES UNDER THE ENVIRONMENTAL TECHNOLOGY VERIFICATION (ETV) PROGRAM

Author: Donna B. Hackett, NSF International  
Co-Authors: John Schenk, NSF International  
and Mary Stinson, USEPA/NRMRL

NSF International and USEPA/NRMRL  
Ann Arbor, MI and Edison, NJ respectively

## Abstract

Assessing, controlling, and treating combined-sewer overflows (CSO), sanitary sewer overflows (SSO), and urban stormwater runoff have become priorities for communities. Improved and cost effective treatment technologies are needed to reduce the adverse impacts that wet weather flows can have on surface water quality.

In October of 1995, the U.S. Environmental Protection Agency (EPA) created a program to facilitate the deployment of such innovative technologies through performance verification and information dissemination. The goal of the Environmental Technology Verification (ETV) Program is to further environmental protection by substantially accelerating the acceptance and use of innovative commercially available treatment technologies. The ETV Program is intended to assist and inform the stakeholders involved in the design, distribution, permitting and purchase of environmental technologies.

Since potential adverse effects on surface water quality from wet weather flow sources has been targeted as a major environmental concern, the Wet-Weather Flow (WWF) Technologies Pilot was created as one of the 12 pilots formed under this ETV Program. Through a cooperative agreement, US EPA and NSF International have partnered to conduct this Pilot. Objective, quality-assured performance data will be made available to all parties in the WWF technology marketplace in the form of a Verification Report and Statement. These will be published on the Web sites, <http://www.nsf.org/etv> and <http://www.epa.gov/etv>.

This paper will focus on one of the five areas selected as a high priority within the WWF pilot, stormwater treatment. The stormwater treatment devices or systems being evaluated are designed to intercept and thereby reduce pollutants before they can adversely affect surface water quality. Their function is to serve as an effective Best Management Practice (BMP) to assist end users in complying with meeting NPDES Phase II stormwater compliance permits and other regulatory requirements for protecting surface runoff quality. Based on their operating principles, there are three basic types of BMP devices that are being verified: in-line filtration devices, hydrodynamic separators, and in-drain filtration devices.

An overview of the generic protocol prepared for use as a template for site-specific test plan preparation will be presented. The names of applied vendors, the names and operating principles of their devices, performance measures included in their test plans, and test site locations will be presented. The field-testing organization that developed the test plan and performed the testing for each device will also be identified. In conclusion, the testing process and available data will be discussed.

## PROTOCOL OVERVIEW

As an initial step in the verification process, the process of developing a protocol was embarked upon with the guidance of a six-member technology panel of experts in this field. The chairman of this panel is Roger Bannerman from the Wisconsin DNR. Other members include Michael Bloom from PBS&J, Stan Ciuba from WA Dept. of Ecology, Jeff Dennis from Maine DEP, Tom Maguire from MA DEP, and Rod Frederick from the EPA, Office of Water. The protocol was prepared under contract with Earth Tech, Inc., and peer reviewed by Dale Scherger of Scherger and Associates. This protocol serves as a generic template for preparation of site-specific test plans.

Both the technology panel and Dale's review deemed the protocol to be generally acceptable, with expectations that modifications and improvements would be made as test plans are drafted.

The latest version of the protocol for stormwater source area treatment devices is Draft 4.1, March 2002, and is available on both the NSF International and EPA ETV web sites. This document has evolved from several earlier versions of the original protocol.

The main elements of the protocol are as follows:

- Minimum 15 qualified sampling events required
- Automatic composite sampling (except HC/micro) - Minimum 5 subsamples
- Pollutant list based on vendors claims - Core list by pollutant category:
  - Solids (TSS, TDS, Settleable Solids)
  - Nutrients (P, TKN, Nitrate, Nitrite, Ammonium)
  - Heavy metals (Zn, Pb, Cu, Cd)
  - Petroleum/ Hydrocarbons (TPH, PAH series)
  - Microbiological/Bacteria (Fecal Coliform, E.coli)

Technology panel recommendations that were added in this latest version (Draft 4.1) after a technology panel meeting in November of 2001 include:

- Adding a requirement of suspended sediment concentration as a measure of solids load
- in addition to TSS, including sand/silt split
- Provision of additional guidelines on proper use of automated samplers and sample splitting
- Permitting, but not mandating, analysis of captured sediment/pollutants
- Improving guidance on sampling and lab Quality Assurance

Additional technology panel recommendations still under discussion from November's meeting include:

- Providing guidelines for characterizing trash & debris removal, but not establishing
- removal efficiency quantification procedures
- Adding language about collaborating with other protocol developers, and sharing 3<sup>rd</sup>
- party credible data generated
- Revisiting some target detection limits and comparing them to other protocols.



## **Stormwater BMP Vendor Applications**

The stormwater treatment devices being evaluated under the ETV program are designed to reduce the level of one or more constituents of concern in stormwater drainage from a site. These parameters include sediment or particulates, nutrients, heavy metals, petroleum hydrocarbons, and bacteria. The test plan created for a specific device being verified at a given location contains the manufacturers' removal claims relative to any number of these constituents.

To date, twelve vendors have applied for verification of their devices. These devices can be divided into three categories based on their operating principles: In-line Filtration Devices, Hydrodynamic Separators, and In-drain Filtration Devices.

### ***In-line Filtration Systems***

As the name of this category implies, these types of BMP devices employ some type of filtration media as the mechanism for removal of stormwater constituents in an in-line device. There are three vendors who have signed up for verification under this category:

1. Zeta Technology, Inc. (Arkal Filtration System)
2. Stormwater Management Inc. (StormGate, StormFilter, StormScreen, and Catch Basin StormFilter)
3. Aquashield, Inc.(Aqua-Swirl Concentrator and Aqua-Filter)

### **Arkal Filtration System**

The Arkal Filtration System manufactured by Zeta Technology, Inc. is a pressurized stormwater filtration system that was tested at St. Mary's Hospital in Green Bay, WI. Testing was completed September 17<sup>th</sup>, 2002 after fifteen events were captured.

This system consists of two filtration systems. The first filtration process consists of four "towers" of commercial disk filters, each disk filter containing a set of grooved rings. The size of the grooves determines the particle size that will be removed from the stormwater down to a 25-micron minimum size. Disk size for testing purposes was set up with 50-micron rings. Automatic backwash occurs when the pressure differential across the filter rings exceeds a pre-set level. The redundant system allows for simultaneous filtration with three towers, while the fourth tower is in a backwash mode. This allows for uninterrupted filtration. The backwash water is temporarily stored in a backwash tank and then discharged to a sanitary sewer at the end of the runoff period. The filtered stormwater is sent to a second filtration stage.

This second stage consists of a series of five sealed sand filter tanks that receive the water filtered from the disk filters through a manifold distribution system. The sand filter tanks have an automatic backwash cycle when the pressure differential across the sand filter exceeds a pre-set level. Like the first filtration system, this second system is also redundant. The tanks are sealed to maintain a pressurized flow system. Overflow from the back wash tank discharges back into the holding tank, and at the end of a runoff event, the backwash tank is discharged to a sanitary sewer. The filtered stormwater is discharged to the storm sewer system.

The sand filter is designed to remove 90% of particles greater than a 5-micron size. Because of this specific claim, particle size analysis was performed in addition to suspended solids analysis. Sample locations included the influent and effluent and the by-pass, which occurs during larger runoff events.

Other pollutant constituents were selected in addition to manufacturers' claims. These were selected to give watershed managers information to solve water quality problems in their area. These include but are not limited to all the parameters included in the ETV Stormwater Protocol. Additional parameters include COD and a nutrient series.

The field-testing organizations involved at this site included Earth Tech Inc., U.S. Geological Survey (USGS), and the Wisconsin DNR.

### **Stormwater Management, Inc. System**

Stormwater Management, Inc. (SMI, Inc.) has a system being tested under the ETV program in Griffin, Ga. with Integrated Science and Engineering, Inc. as the Field Testing Organization (FTO). This system consists of a StormGate, a StormFilter, and a StormScreen.

#### ***StormGate***

A diversion baffle or hydraulic transistor called "the StormGate" by SMI, Inc. is incorporated into this system. It is designed to divert a certain amount of flow to either the StormFilter or the StormScreen, the other two components of the SMI, Inc. system. Stormwater on the east side of Fifth Street at the test site will flow through a StormGate to divert 10 cfs to the StormScreen device. The StormGate will divert any flows exceeding 10 cfs. The StormGate located on the west side of Fifth Street will divert 0.79 cfs to the StormFilter. Flows exceeding 0.79cfs will be diverted back to the storm drain line.

#### ***StormFilter***

The StormFilter portion of the system is composed of filter cartridges housed in a steel vault at a St. Clair Shores, MI ETV test site. This system uses perlite filter media in the filter cartridges. The filter systems are installed inline with the storm drain lines. The system works by percolating stormwater through the perlite filter media. This filter media is designed to trap particulates and adsorb materials such as suspended solids, petroleum hydrocarbons, and particulate bound removal such as particulate bound phosphorus, nitrogen, and metals.

The typical unit configuration consists of an inlet bay, flow spreader, cartridge bay, an overflow baffle and outlet bay. The outlet bay serves as a grit chamber and provides for flow transition into the cartridge bay. The flow spreader provides for the trapping of floatables, oils and surface scum. Water enters the cartridge bay through the flow spreader and starts to pond. When the water ponds, it infiltrates through the filtration media and into the center tube, and begins to raise the float. Once the ponding submerges the cartridges, the float will pull loose from the lower float seal and generate a siphon effect, which greatly increases the flow potential across the filter media. The siphon effect continues until the water is drawn down to the scrubbing regulator portion of the hood, at which time air bubbles are entrained and the siphon is lost. As the bubbles are entrained across the surface of the cartridge, scouring of the solids deposited on the outer screen of the

filter occurs, which acts as a self-cleaning mechanism. Water will continue to drain gravitationally until the float reseats itself and resets the system.

The anticipated removal efficiencies of the StormFilter are between 50 to 70% of TSS, 40 to 45% of Total Phosphorus, and little to no change in Dissolved Phosphorus. Also anticipated are 30% removal of Total Kjeldhal Nitrogen, 40% removal of Total Zinc, and 20 to 40% removal of Dissolved Zinc and Dissolved Copper. All parameters listed in the Stormwater protocol will be tested for in the influent to the device and the effluent from the device.

### ***StormScreen***

The StormScreen portion of the system is a device that incorporates screening technology with patented, self-cleaning, siphon-actuated, radial flow cartridges. This system is designed to treat high flow rates through fine screening of the influent, and is intended to target trash and debris and larger suspended solids. The system configuration consists of 20 cartridges which are activated by buoyant forces lifting an internal float and opening the lower float seal that draws polluted influent via a siphon, ensuring a constant operating flow rate as well as even flow distribution over the entire cartridge surface. Polluted stormwater is treated by settling as water enters the vault and by being drawn through the small openings of the StormScreen cartridges.

This system was installed in Griffin, GA in August of 2002 with ISE, Inc. as the FTO.

### **Catch Basin StormFilter**

The Catch Basin StormFilter is manufactured by Stormwater Management, Inc. (SMI, Inc.), and is a passive, flow-through stormwater filtration system. It is engineered to replace the standard catch basin, and consists of a concrete or steel vault that houses rechargeable cartridges filled with a variety of filtration media. In the Catch Basin StormFilter, polluted runoff enters the system through a traffic-bearing grate into the primary settling chamber where heavier solids drop to a sump. The runoff water containing the lighter solids and dissolved pollutants is then directed under a baffle into the cartridge chamber where the StormFilter cartridges are housed. The StormFilter works by passing this water through the media-filled cartridges, which are intended to trap particulates and adsorb pollutants such as dissolved metals, nutrients, and hydrocarbons. This catch basin device can be customized to site-specific conditions by using different filter media to remove the desired levels of sediments, soluble phosphorus, nitrates, soluble metals, and oil and grease.

A Catch Basin StormFilter unit designed using CSF<sup>®</sup> leaf media is being tested under the ETV program. To create this media, Stormwater Management composts leaves into mature stable humus. This humus is then processed into organic granular media created used to remove TSS, oil and grease, and soluble media. CSF (Compost Stormwater Filter), a registered trademark type of media from SMI, Inc., that is a specific gradation of media. It is a level of media retained by a certain sieve size.

The manufacturer states that there are three primary pollutant removal mechanisms performed by the media:

1. Mechanical filtration to remove sediments and associated total phosphorus
2. Chemical processes to remove soluble metals including lead, copper, and zinc
3. Adsorption processes to remove oil and grease

This Catch Basin StormFilter comprised of four cartridges housed in a steel vault was installed in August at a site in St. Clair Shores, MI. Environmental Consulting and Technology, Inc. (ECT, INC.), the selected FTO, will evaluate this unit.

The performance claims from SMI, Inc. literature indicate that suspended solids removal during testing may reach 95%, depending on particle size distribution and influent concentration. Heavy metals removal rates from 65% to 95% may also be anticipated due to the cation exchange mechanism provided by the humic substances in the CSF leaf media. The high organic content of this CSF media facilitates removal of oil and grease as well as some other organic compounds. The system is optimized for oil and grease removal when loadings are less than 25mg/l. Under these conditions, removal rates may be expected to reach 85%.

### ***Aqua-Filter Stormwater System***

The final vendor that has applied for ETV verification of a filtration device is Aquashield, Inc. Their filtration device submitted for verification is known as the “Aqua-Filter Stormwater Filtration System.” It is an in-line stormwater filtration system capable of treating large flow rates. Each Aqua-Filter system is custom engineered for the site and utilizes a unique “treatment train” approach which includes a Swirl Concentrator designed for pre-treatment followed by a filtration chamber designed to remove fine sediments, water-borne hydrocarbons, and nutrients such as phosphorus and nitrogen. The Swirl Concentrator portion of the system is a hydrodynamic separator designed to remove TSS (coarse/fine sediment) and free floating oil and debris.

The filtration chamber that follows the Swirl Concentrator in the treatment train contains a cellulose filter media designed for polishing of the stormwater before discharge. There are no moving parts in the system. The manufacturer claims that previous test results indicate a 90-95% removal rate of dissolved petroleum and oils. The patented filter media changes from tan to black when it needs to be removed. High Density Polypropylene is used in lieu of concrete, making the Aqua-Filter System relatively lightweight and chemically resistant.

Field-testing of this unit under the ETV program has not been initiated to date.

### ***Hydrodynamic Separators***

A second classification of stormwater treatment devices is generally referred to as “hydrodynamic separators.” Basically, a hydrodynamic separator is some type of cylindrical vessel in which a flow stream is introduced tangentially to induce a swirling flow pattern. This causes settleable solids to be accumulated and stored in a manner and a location that will prevent re-suspension of previously captured particulates.

There are five vendors that have applied whose operating principles fit this hydrodynamic separation classification. These include: Baysaver, Inc. with the Baysaver, Practical Best Management (PBM) with the Crystal Stream Oil/Grit Separator, Vortech, Inc. with the Vortechs System, CDS Technologies, Inc. with the Continuous Deflection Separator (CDS) device, and Hydro International with the Downstream Defender.

## **Baysaver**

The Baysaver Separation System is designed for use as an in-line separation system for the removal of sediments and floatable particles. Separation within the unit occurs as a result of density differences between stormwater and materials being carried by the stormwater. Materials with a specific gravity greater than one are removed as a result of sedimentation, while materials with a specific gravity less than one are removed by floatation. Molecules such as hydrocarbons adsorb to particles that separate out in both the primary and storage manholes. Flow through the BaySaver unit is controlled by the use of a trapezoidal weir that allows the Baysaver Separation System to dictate the volume of water being treated in the storage manhole.

The Baysaver Separation system is comprised of two precast manholes and a High Density Polyethylene Baysaver Separator Unit. The primary manhole is set in-line with the storm drainpipe, and the storage manhole is offset to either side. According to the manufacturer, the two manholes, which must be watertight, provide the retention time and storage capacity necessary to remove the target pollutants from the influent water. The Baysaver Separator Unit is designed to act as a flow control, diverting the influent water to the flow path that will result in the most efficient pollutant removal.

The primary manhole is designed to remove coarse sediments from the influent water and retain them in an eight-foot deep sump. A portion of the influent flow is skimmed from the surface of the primary manhole by the Baysaver Separator Unit and conveyed to the storage manhole. This water enters the off-line storage manhole at an elevation below the water surface and above the floor of the structure, allowing both floatation and sedimentation to occur. The fine sediments and floatables that are entrained in this water remain retained in the manhole.

The Baysaver Separator Unit is designed to limit the flow through the storage manhole by allowing excess water to pass directly from the primary manhole to the outfall. During high intensity storms, the Baysaver Separator Unit Draws water from the center of the primary manhole, approximately four feet below the water surface, and discharges it to the outfall. Simultaneously, it continues to skim the surface water and treat it through the storage manhole. Extremely high flows are conveyed by the separator unit to the bypass, and bypass the storage manhole completely.

The storage manhole is designed to store oils, fine sediments, and floatables off-line; the internal bypass is designed to minimize the risk of resuspension and discharge of contaminants. The system is also designed to minimize the volume of water that must be removed during routine maintenance, resulting in lower disposal fee.

Baysaver, Inc. reported that their Baysaver Separation System will provide a net removal efficiency ranging between 60 to 80% removal of Total Suspended Solids and will also remove a significant portion of free oils that enter the system.

The Baysaver, Inc. System was installed at a site in Griffin, GA in August of 2002, and testing is on-going.

## **Crystal Stream Oil/Grit Separator**

Practical Best Management (PBM) of Georgia, Inc manufactures the Crystal Stream Oil/Grit Separator. It is a limited space BMP device that utilizes settlement as the primary constituent removal method; as velocity slows, sediment and grit carried by the stormwater collect in the bottom of the device. It contains a separate oil chamber designed such that motor oils and other fluids that float on water are skimmed and captured in this reservoir for recovery. A trash rack on the top of the device is intended to capture Styrofoam cups and cigarette butts. The unit is purported by PBM, Inc. to capture over 99% of petroleum products and nearly 95% of silt and grit, also entraining many chemicals and heavy metals.

This device was installed and is in the process of being tested at a site in Griffin, GA ISE, Inc. is serving as the FTO.

## **Vortechs System**

Vortech, Inc manufactures the Vortechs System. It is a design that combines swirl-concentrator and flow –control technologies to ensure effective capture of sediment and oils, and prevent resuspension of trapped pollutants even at flow rates up to 25 cfs.

The Vortechs System consists of a Grit Chamber, an Oil Chamber and Baffle Wall, and Flow Control Chamber. In the grit chamber, a swirling motion created by the tangential inlet directs settleable solids toward the center of the chamber. Sediment is captured in the flow path and settles back into the chamber after a storm event is over. The Oil Chamber has a center baffle that is designed to trap floatables in the oil chamber even during cleanout. In the flow control chamber, the weir and orifice flow controls raise the level and volume in the system as the flow rate increases, and gradually drains the system as the flow rate subsides.

The Vortechs System is being tested at a site in Milwaukee, WI. EarthTech, Inc. in conjunction with the WI DNR and USGS is serving as the FTO.

## **Downstream Defender**

HydroInternational manufactures the Downstream Defender. The Downstream Defender is a dynamic separator designed to remove floatables, sediment and free oil from stormwater runoff. Raw liquid is introduced tangentially into the side of the of the cylinder and spirals down the perimeter allowing heavier particles to settle out by gravity and the drag forces on the wall and base of the vessel.

The base of the unit is at a 30 Degree angle. As the flow rotates about the vertical axis, solids are directed at the base of the facility where they are stored in the collection facility. The internal components are designed to direct the main flow away from the perimeter and back up the middle of the vessel as a narrower spiraling column rotating at a slower velocity than the outer downward flow. A dip plate is suspended from the underside of a component support frame. The dip plate locates [better word?] the shear zone and establishes a zone between it and the outer wall for floatables, oil, and grease. According to the manufacturer, the flow that reaches the top of the vessel should be virtually free of solids and is discharged through the outlet pipe. A sump vac procedure is used to remove floatables and solids.

Testing has not begun to date on the Downstream Defender; the test site has yet to be determined.

## **CDS Technology**

CDS Technology markets the CDS device that is designed to divert the portion of the stormwater containing the majority pollutants (i.e. first flush) into the screen chamber. This water is treated and then returned to the stormwater system. Flows in excess of the CDS treatment flow bypass the screen chamber. Captured solids are permanently retained within the CDS screen and sump. Floating solids are kept in continuous motion on the water surface while heavier materials go into the sump. CDS units use a continuously cleaning screen. The screen is designed to remove neutrally buoyant particles that are captured by typical baffled systems.

A test site for the CDS unit is yet to be determined.

## ***In-drain Filtration Systems***

In-drain filtration systems are catch basin inserts designed to remove various pollutants by means of some type of filtration media. There are five different catch-basin inserts that we are verifying in the ETV program. These are the Ultra Urban Filter with Smart Sponge from AbTech Industries, Inc., the Ultra-Drain Guard Oil and Sediment Plus from UltraTech International, Inc., the Hydro-Kleen™ Filtration System from Hydrocompliance Management, Inc., Drain Pac from DrainWorks, Inc., and the Flo-Gard Plus manufactured by Kristar Enterprises, Inc.

### **UltraUrban Filter**

AbTech Industries, Inc. manufactures this BMP Device. The Ultra Urban Filter with Smart Sponge is an in-drain insert designed to remove sediment, hydrocarbons, and debris from stormwater. The Ultra Urban Filter Series DI2020 is made of high strength corrugated plastic designed to “drop-in” existing stormwater catch basins. It is used in storm drains that experience oil and grease pollution accompanied by sediment and debris.

The filter is designed such that trash and sediment accumulate in the internal basket while oil and grease are captured in the filtration media. According to the manufacturer, oil is bonded with the SmartSponge so that it will not leach back into the environment.

It was installed in August of 2002 at a test site in Griffin, GA and is being evaluated by ISE, Inc. as the FTO.

### **Ultra-Drain Guard Oil and Sediment Plus**

UltraTech International, Inc. manufactures this “Catch Basin Insert” device. It is designed to capture oil, grease, trash, and sediment from stormwater runoff before it enters the storm drain system. It is installed in a catch basin and is suspended by the grate itself. Stormwater runoff enters the Ultra-Drain Guard Oil and Sediment Plus and is directed toward the pouch by a skirt made of a non-woven [?] polypropylene, needle-punched, geotextile material. The fabric itself is designed to filter pollutants as the runoff passes over and flows through the material. In addition, each Ultra-Drain Guard Oil and Sediment Plus is equipped with several “filter strips” made of “X-TEX,” a unique filter material made of recycled synthetic fibers. The manufacturer claims that this material is extremely effective in the capture and removal of hydrocarbons and other pollutants from stormwater. These filter strips are intended to maximize oil and hydrocarbon removal.

The Ultra-Drain Guard Oil and Sediment Plus are designed with “ByPass Ports” to prevent flooding and ponding from occurring. One unit is said to be capable of filtering out and containing a minimum of forty pounds of oil, sediment, debris, and floatables.

The Ultra-Drain Guard Oil and Sediment Plus was installed in a site in Griffin, GA. in August of 2002. ISE, Inc. is serving as the FTO, and testing is ongoing.

## **HydroKleen**

Hydro Compliance Management, Inc., of Ann Arbor, Michigan (Hydro Compliance), manufactures and markets the Hydro-Kleen™ Filtration System. The Hydro-Kleen™ is a stormwater catch basin insert designed to trap hydrocarbons, metals, sediments, and other contaminants contained in stormwater and other surface runoff. The Hydro-Kleen™ contains a multi-chamber system that combines pre-settling sediment removal with dual media filtration. The system is designed to filter hydrocarbons and other contaminants while alleviating concerns with water flow. The Hydro-Kleen™ Filtration System is promoted as a structural BMP to assist end users in complying with meeting NPDES Phase II stormwater compliance permit and other regulatory requirements for protecting surface water runoff quality.

The Hydro-Kleen™ Filtration System is a patented multi-media filtration design combined with pre-settling sedimentation containment and overflow by-pass protection for ‘hot spot’ applications. Each unit is custom manufactured for retrofit or specification to fit a specific catch basin or drain invert size. Units are placed into drains by removing the grate/cover, inserting the unit onto the grate lip, and replacing the cover. Water flow enters the unit and is directed into a pre-settling sedimentation chamber that collects heavy sediments and debris passing through the grate. Water then passes through transition inlets at the top of the sediment chamber into the filtration chamber. The primary media, Sorb-44, is intended to remove hydrocarbons through adsorption. The secondary media is a blend of activated carbon (AC-10) that is intended to remove any remaining hydrocarbons, as well as a variety of other organics, metals, and other contaminants from the runoff. Water then passes through the of the bottom treatment chamber into the catch basin.

Units are designed to trap contaminants contained in the ‘first flush’ from storm events while allowing overflow protection to eliminate flooding during heavy wet weather events. To accomplish this, the filtration chamber is designed to handle 40 – 50 gpm through the media chamber, effectively handling up to ½ in. of rain per hour in a properly designed drain. Higher flows from high intensity wet weather events are diverted to by-pass outlets that are designed to move whatever flows the drain is designed to handle. This is intended to prevent flooding or ponding on the surface while capturing contaminant loadings from impervious surfaces.

The Hydro-Kleen System is being tested under two different protocols. Laboratory testing is being done under the protocol for in-drain devices developed under the Source Water Protection Pilot in Ann Arbor at NSF International. Field-testing is being conducted at a site in St. Clair Shores, MI under the Stormwater Source Area Treatment Device Protocol.

## **DrainPac**

DrainWorks, Inc manufactures DrainPac. It basically consists of three types of parts: a metal support bracket, flexible polymer support structure, and a replaceable bag filter. DrainPac is designed to trap or collect sediment, oil and debris from drain inlets.



A test site and testing organization has yet to be determined.

### **Flo-Gard Plus**

Flo-Gard Plus is manufactured by Kristar Enterprises, Inc. It is a catch basin filtration system designed to be effective in the removal of sediment, trash and debris. It features a stainless steel outer basket, a filter liner, and an HDPE adapter ring to allow for use in a wide range of design applications. It also offers a dual bypass feature, an initial “filtering” high flow bypass and an “ultimate” high flow bypass. In both bypass modes, pollutants remain trapped in the system.

This device is not being tested yet, since the site has yet to be determined.

### **Summary**

This is a snapshot of the Stormwater Technology Area of the ETV Program, as it exists in September of 2002. Twelve vendors have applied for verification with thirteen different devices submitted for verification testing. Testing of the Arkal Filtration System has been recently completed in Green Bay, WI. Testing is on-going for the Vortechs System in Milwaukee, WI under the direction of EarthTech, Inc. as the FTO, and in conjunction with the Wisconsin DNR and US Geological Survey (USGS). Testing is also underway for the Hydro-Kleen Filtration System and the Catch Basin StormFilter from SMI, Inc. in St. Clair Shores, MI with ECT, Inc. as the FTO. In Griffin, GA, with ISE, Inc. as the FTO, verification testing is on-going for the Crystal Stream Oil/Grit Separator from PBM of GA, the StormGate, StormFilter, and StormScreen from the Stormwater Management Inc. (SMI), and the Baysaver Separation System from Baysaver, Inc. Ultra-Urban Filter from AbTech Industries, and the Ultra-Drain Guard Oil and Sediment Plus unit from UltraTech International, Inc. are also being tested in Griffin with ISE, Inc. as the FTO. Five devices that have not begun testing include: the FloGuard Plus from Kristar, Aqua-Filter Stormwater System from Aquashield, the CDS Device from CDS Technologies, the DrainPac from DrainWorks, and the Downstream Defender from HydroInternational, Inc.

As mentioned, our protocol is constantly evolving as test plans are developed and finalized. A current copy of the protocol can be found either on the EPA or NSF ETV web sites, <http://www.nsf.org/etv> and <http://www.epa.gov/etv>. Also, verification results in the form of Verification Reports and Statements for the testing that has been completed to date can be found on these web sites.

# USING AN INDICATORS DATABASE TO MEASURE STORMWATER PROGRAM EFFECTIVENESS IN HAMPTON ROADS

Julia B. Hillegass  
Hampton Roads Planning District Commission  
Chesapeake, Virginia

## Abstract

The Hampton Roads Planning District Commission (HRPDC) has been working with the region's sixteen localities to develop a regional stormwater management program since 1996. The program focuses on activities that support the permit compliance efforts of the six communities with Virginia Pollutant Discharge Elimination System (VPDES) Stormwater System Permits, technical assistance to the region's non-permitted communities and regional education and training to support all of the communities. A set of regional stormwater management goals that guide the regional program has been developed. Adopted by the HRPDC, they are:

- Manage stormwater quantity and quality to the maximum extent practicable (MEP)
  - Implement Best Management Practices (BMPs) and retrofit flood control projects to provide water quality benefits.
  - Support site planning and plan review activities.
  - Manage pesticide, herbicide and fertilizer applications.
- Implement public information activities to increase citizen awareness and support for the program.
- Meet the following needs of citizens:
  - Address flooding and drainage problems.
  - Maintain the stormwater infrastructure.
  - Protect waterways.
  - Provide the appropriate funding for the program.
- Implement cost-effective and flexible program components.
- Satisfy VPDES stormwater permit requirements:
  - Enhance erosion and sedimentation control.
  - Manage illicit discharges, spill response and remediation.

The Regional Stormwater Management Committee determined that a major technical study should be undertaken cooperatively to support the stormwater programs of the six permitted localities and should include the following components:

1. Analyze stormwater discharge sampling data to develop event mean concentrations (EMC) by city and by land use.
2. Develop stormwater pollutant loads for watersheds in the six cities based on the EMC using a geographic information system.
3. Develop a consolidated regional monitoring program for the six cities for consideration by the Department of Environmental Quality (DEQ) in the VPDES stormwater permit reapplication process. Develop recommendations on indicators of stormwater management program effectiveness.

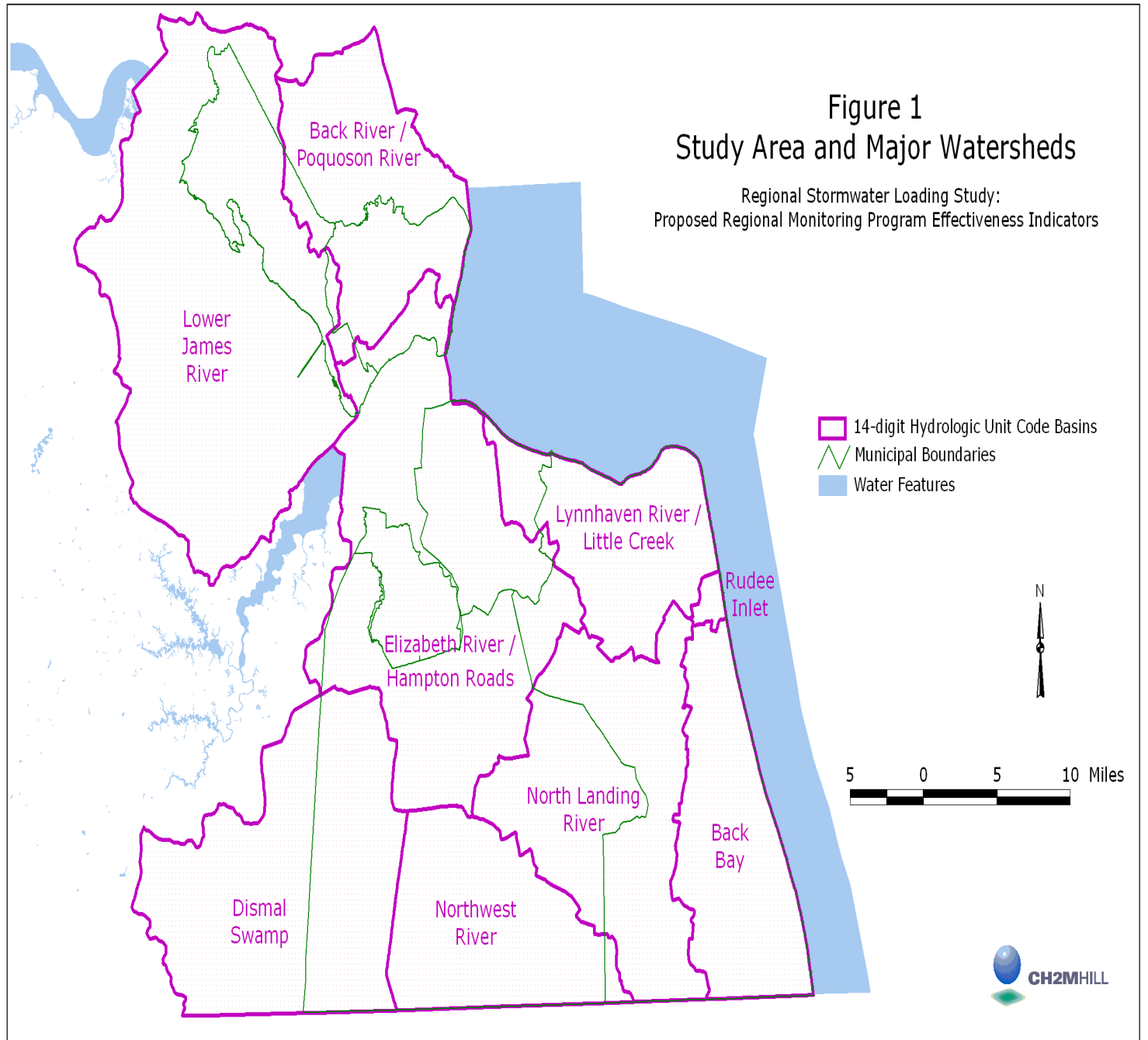
The Regional Loading Study recommended the use of a series of Program Effectiveness Indicators, rather than continued traditional chemical water quality monitoring. The HRPDC staff developed a proposed modification to the monitoring component of each locality's municipal separate storm sewer system (MS4) Permit, outlining the Regional Stormwater Management Program Goals that are to be met through the local stormwater programs and how the Indicators would be used to measure progress toward those goals. Ten indicators were developed to measure the overall success of local programs. The proposed Permit Modification was submitted by each of the permitted localities and was incorporated by DEQ into the reissued VPDES Stormwater Permits.

## **Background**

During their first separate storm sewer system (MS4) Virginia Pollutant Discharge Elimination System (VPDES) permit term, the Cities of Chesapeake, Hampton, Newport News, Norfolk, Portsmouth, and Virginia Beach were required to monitor the chemical constituents from selected outfalls. Based on the collected monitoring data, the local governments were required to calculate Event Mean Concentrations (EMCs) of pollutants discharged from their monitored stormwater outfalls. A study was commissioned by the affected local governments to determine the efficacy of this method of monitoring. A map of the study area with major watersheds is included as Figure 1. The consultant on the project was charged with the following:

1. Analyze stormwater discharge sampling data to develop event mean concentrations (EMC) by city and by land use.
2. Develop stormwater pollutant loads for watersheds in the six cities based on the EMC using a geographic information system.
3. Develop a consolidated regional monitoring program for the six cities for consideration by DEQ in the VPDES stormwater permit reapplication process. Develop recommendations on indicators of stormwater management program effectiveness.

Figure 1 : Study Area and Major Watersheds Map

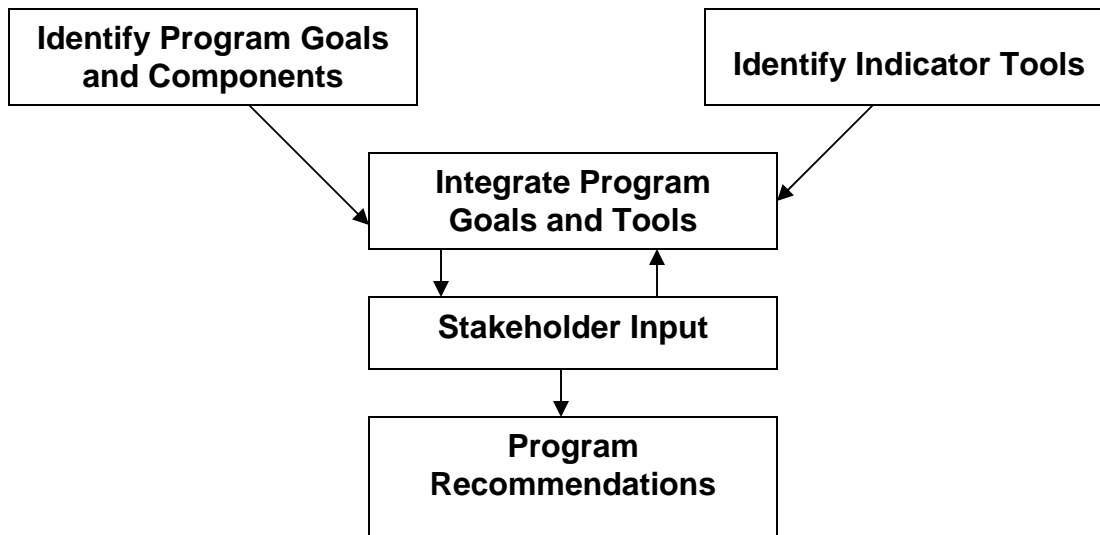


### ***Process and Objectives***

The process for developing the regional stormwater program and effectiveness indicators is shown in Figure 2 and is described below:

- The consultant conducted a literature search of regional monitoring programs and alternative program effectiveness indicators.
- The consultant facilitated discussion of the development of regionally consistent stormwater monitoring program goals, prioritizing potential indicators to be used in a regional program, either to complement or replace the required chemical monitoring under the then existing VPDES permits. The goal setting and prioritization was conducted over a series of workshops from October 1998 to February 1999.
- The consultant performed an analysis of existing VPDES permit data to determine:
  - Whether chemical monitoring can be replaced by other effectiveness indicators, by comparing local data to the Nationwide Urban Runoff Program (NURP) data.
  - If monitoring cannot be replaced, determine whether monitoring sites and land use types can be consolidated based on representative data across cities and land use as compared with NURP data.

An important objective of the new program was to effectively communicate the successes of the municipal stormwater programs to the public and elected officials, with greater emphasis on social and programmatic indicators. A second objective was to develop a more cost-effective approach to stormwater monitoring in the Hampton Roads region that will both satisfy the permit requirements and measure the effectiveness of local stormwater programs.



**Figure 2:** The Process

When compared to EMCs from other urban areas studied during the Nationwide Urban Runoff Program (NURP), calculations indicated that the level of pollutants carried by stormwater in Hampton Roads is typical of other urban areas and, in many cases, lower.

The Stormwater Management Program Effectiveness Indicator Tracking Program was developed to help the region’s local governments assess their achievement of common stormwater management goals developed by the Hampton Roads Regional Stormwater Management Program. These goals are:

- Manage stormwater quantity and quality to the maximum extent practicable (MEP).
  - ❑ Implement BMPs and retrofit flood control projects to provide water quality benefits
  - ❑ Support site planning and plan review activities.
  - ❑ Manage pesticide, herbicide, and fertilizer applications.
- Implement public information activities to increase citizen awareness and support for the program.
- Meet the following needs of citizens:
  - ❑ Address flooding and drainage problems.
  - ❑ Maintain stormwater infrastructure.
  - ❑ Protect waterways.
  - ❑ Provide appropriate funding for the program.
- Implement cost-effective and flexible program components.
- Satisfy VPDES stormwater permit requirements.
  - ❑ Enhance erosion and sedimentation control.
  - ❑ Manage illicit discharges, spill response, and remediation.

## The Indicators Program

A variety of program effectiveness indicators were selected during the series of workshops. These indicators encompass all aspects of local stormwater programs in Hampton Roads and were selected based upon technical, practical and programmatic considerations. To capture data representative of the activities in stormwater programs, the indicators were divided into strategic indicator groups. An indicator was defined as a measurable feature that provides managerially and scientifically useful evidence of stormwater and ecosystem quality or reliable evidence of trends in stormwater quality and program effectiveness. The Tracking Program stores the indicator data in a Microsoft Access database. The indicators that are recorded in the database can be grouped into one of four categories as illustrated in Table 1 below:

**Table 1: Database Indicators**

<b>Indicator Group</b>	<b>Indicator</b>
Water Quality	Pollutant Loadings
Physical & Hydrological	Greenlands Program
Programmatic	Investigative Monitoring BMP Implementation Flooding and Drainage Control Flooding and Drainage Projects Erosion and Sediment Control Permitting and Compliance Operations and Maintenance
Socioeconomic	Public Information Programs Environmental Knowledge Website visits Publications Distributed Media Restoration Activities Cleanup Activities

While the chemical monitoring program was useful in determining that the stormwater runoff in Hampton Roads is comparable to other urban areas, it was not useful in communicating the effectiveness of local stormwater management programs. The high variability of the data, due to natural factors such as rainfall, makes it very difficult to detect any actual increasing or decreasing trends in pollutant levels carried by stormwater runoff. In addition, the chemical monitoring program could not account for actions taken by local stormwater programs to reduce flooding and drainage problems. Due to these shortcomings, the permitted local governments of Hampton Roads proposed modifying their MS4 VPDES permits to replace the chemical monitoring requirement with a Stormwater Management Program Effectiveness Indicator Tracking Program for the second permit term. Initial data collection began in 2000 to provide examples of the types of data that would be collected in future years, should the Tracking Program be allowed in the permit renewal process. Data can be queried and illustrated by locality and regionally, in the form of

summary tables and graphs. The Virginia Department of Environmental Quality accepted the proposed Tracking Program in lieu of chemical monitoring and modified the MS4 VPDES permits accordingly when they were reissued in April 2001.

## ***Description of Indicators***

### **Water Quality Nutrient Loadings**

CH2MHill estimated Stormwater pollutant loads for each of the local governments in Hampton Roads permitted through the Virginia Pollutant Discharge Elimination System Program. The estimated pollutant loads are documented in a series of Technical Memoranda contained in each locality's annual report.

### **Greenlands**

Greenlands are lands that are permanently protected from development or lands that are restored to a more natural state during redevelopment. They provide a water quality benefit by reducing the imperviousness of the watershed. Such lands may include parklands, refuges, wetlands, and lands protected by conservation easement. The database is structured to maintain the number of acres of greenlands to assess progress toward reducing the potential watershed imperviousness and nonpoint source pollution loads.

### **BMP Implementation**

Stormwater best management practices (BMPs) help to minimize flooding and water quality impacts associated with development. Experience has shown that over time, lack of maintenance has caused BMPs to lose their effectiveness. In addition, older developed areas lack BMPs or the designs of the BMPs that have been installed do not include water quality protection measures. To measure the success of BMPs in flood and water quality protection, the database is structured to include information on:

- The number and types of BMPs installed or retrofitted for water quality
- The number of developed acres served by BMPs, grouped by land use
- Inspection and maintenance activities

This information will eventually allow the estimation of pollutant removal by BMPs and the ascertainment of whether BMPs are functioning properly.

### **Erosion and Sediment Control**

Every local government in the Commonwealth of Virginia is required to administer an Erosion and Sediment Control Program. The Erosion and Sediment Control Law requires that land disturbing activities exceeding 10,000 square feet submit an Erosion and Sediment Control Plan and meet minimum standards. Under the Chesapeake Bay Preservation Act, the threshold is decreased to 2,500 square feet in a Chesapeake Bay Preservation Area. The minimum standards specify practices that reduce the amount of sediment leaving a construction site and minimize downstream flooding and streambank erosion. The level of enforcement and compliance limits the effectiveness of local erosion and sediment control programs. To monitor the extent of land-disturbing activities, the database is designed to include information on the number of approved erosion and sediment control plans and disturbed acreage. The number of inspections and enforcement actions are also included to evaluate enforcement and the level of compliance with the local erosion and sediment control regulations.

### **Flooding and Drainage Responses**

Calls and complaints received from citizens can be an indicator of the performance of a stormwater program. Responsiveness of a stormwater program, in the form of inspections and resulting maintenance



activities, to citizen inquiries can also be an indicator of effective administration of the stormwater program. The database is structured to collect data on the number of citizen calls and responses.

### **Flooding and Drainage Projects**

An important function of a local stormwater program is to correct flooding and water quality problems. Projects to address these needs may be included in local Capital Improvement Projects. Corrective actions may involve retrofitting areas, installing BMPs, or restoration activities. To help determine whether a stormwater program is actively performing this important function, the database is designed to include the number and cost of flooding and drainage projects.

### **Investigative Monitoring**

Hazardous material spills, wastewater cross connections, and other illicit discharges can represent a significant source of pollution. Implementing an effective illicit discharge/connection management program to control these sources can result in considerable improvements to water quality. The database is structured to allow the collection of information on investigative and corrective actions, to assess whether an illicit discharge/connection program is being effectively implemented. These actions include screening inspections and measures taken to locate and eliminate illicit discharges/connections.

### **Operations and Maintenance**

Operation and maintenance activities are crucial to a stormwater conveyance system's ability to reduce flooding and minimize the amount of pollutants that are discharged into the region's waterways. Operation and maintenance activities include street sweeping and cleaning and repairing both catch basins and drainage facilities. By monitoring these activities, the proper functioning of the stormwater system can be assessed, and the amount of sediment that was prevented from being discharged by the stormwater system can be estimated.

### **Permitting and Compliance**

Development increases the amount of runoff and pollution in a watershed. In an effort to monitor development activity, the number of approved site and subdivision plans, and their associated developed or redeveloped acres are maintained in the database.

### **Public Information Programs**

Informing individuals about stormwater issues and measures they can take to reduce pollution is important to gaining public support of a stormwater program. It also helps protect water quality. The database maintains information on public education and outreach activities to help assess whether a stormwater program is adequately carrying out this function. The parameters that are examined include: number of publications produced and distributed, public outreach activities, media campaigns, riparian restoration activities by citizens, stream cleanup activities, and web site hits. Where appropriate, citizens are surveyed regarding their knowledge levels before and after an informational effort.

## The Database

### *The Main Menu*

The database opens up to the Main Menu with several selection options. The upper portion of the menu lists each of the effectiveness indicators. When an indicator is selected, a data entry form for that particular indicator is displayed.

The bottom portion of the menu consists of administrative functions. The “Edit Lookup Tables” button opens a form that allows the input of additional Activity Types, BMP Types, Green Areas, Municipalities, Pollutants, Spot Types, Topics and Watersheds. The “Import/Export Data” button opens a form that will allow each of the indicators to be exported in a text or Excel format, as well as import an indicator that has already been exported in a text format by using this tool. The Main Menu is illustrated in Figure 3.



**Figure 3:** Database Main Menu

### *Indicator Tools Menus*

Data entry forms are set up for each indicator to facilitate the data-gathering task. Few of the permitted localities have all of the tracked information in one department. The Tracking Program allows data entry to be conducted by several departments, compiled by the respective locality, and then compiled for the region. Many localities are able to use the data gathered in reporting on other related program efforts such as Erosion and Sediment Control and the Chesapeake Bay Preservation Act.

Features unique to the Tracking Program include the ability to query for reporting by region, watershed or locality. Data can also be entered in the datasheet view, which allows for full functionality of all of the

associated pull-down menus. The Tracking Program also allows for different time intervals of data collection, such as monthly, quarterly or annually, ensuring flexibility for the different local programs.

Localities can also customize specific reporting areas to more accurately capture local program efforts by utilizing the Edit Lookup Tables function of the database. Existing lookup values can be added, deleted or modified based on local program needs.

An Import/Export Data function allows electronic compilation and transfer of data between and among local departments, as well as to and from the HRPDC staff. The data can be exported and manipulated in Excel or exported to text to send a final version. Filenames are automatically assigned by concatenating the municipality with the table name and current date. When importing data, automatic integrity checks will be activated which prevent duplicate reporting, while allowing the user to upload the remaining records.

### Sample Reports

Figure 4 and Figure 5 show examples of reports for Pollutant Concentrations (EMCs) and Pollutant Loading data.

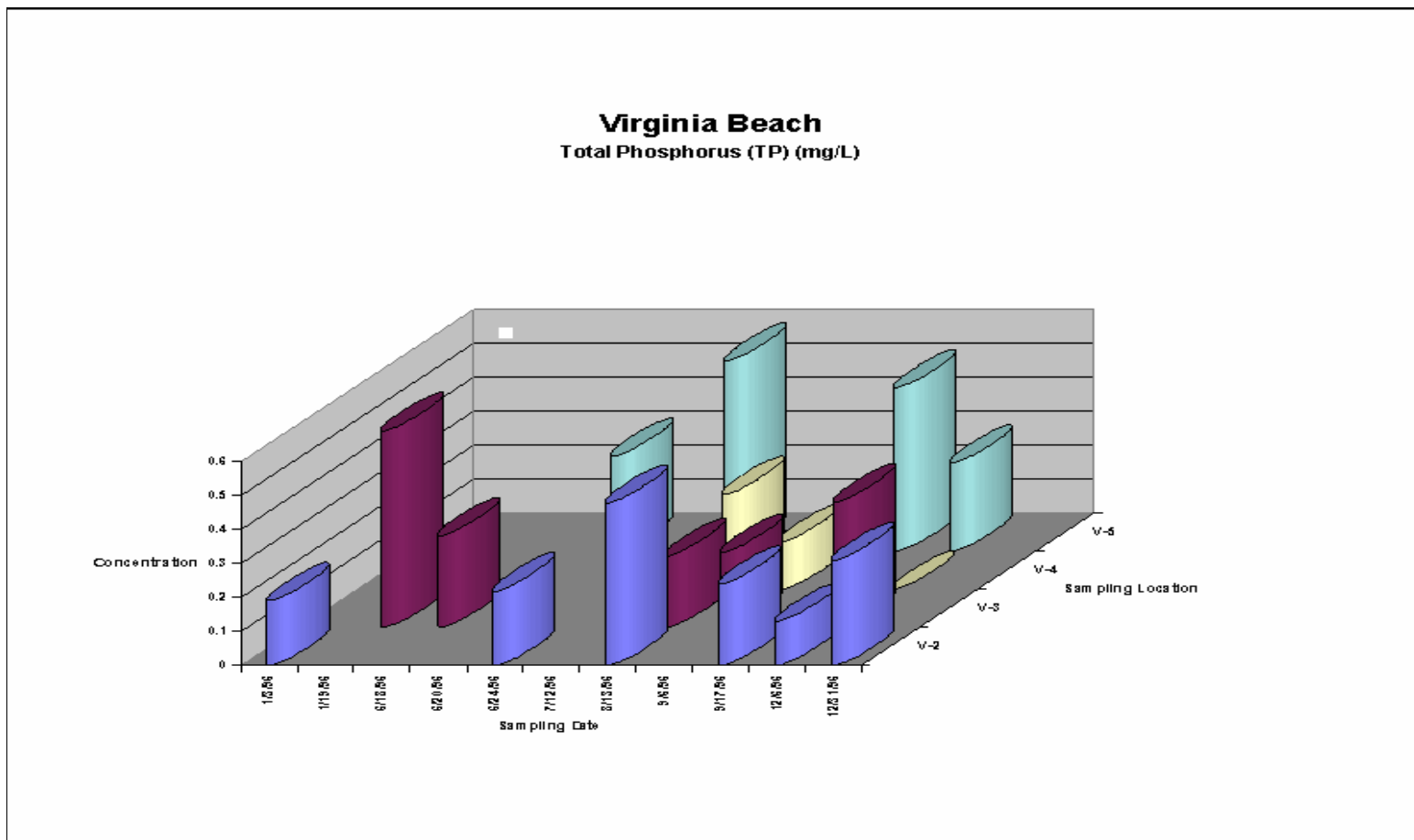
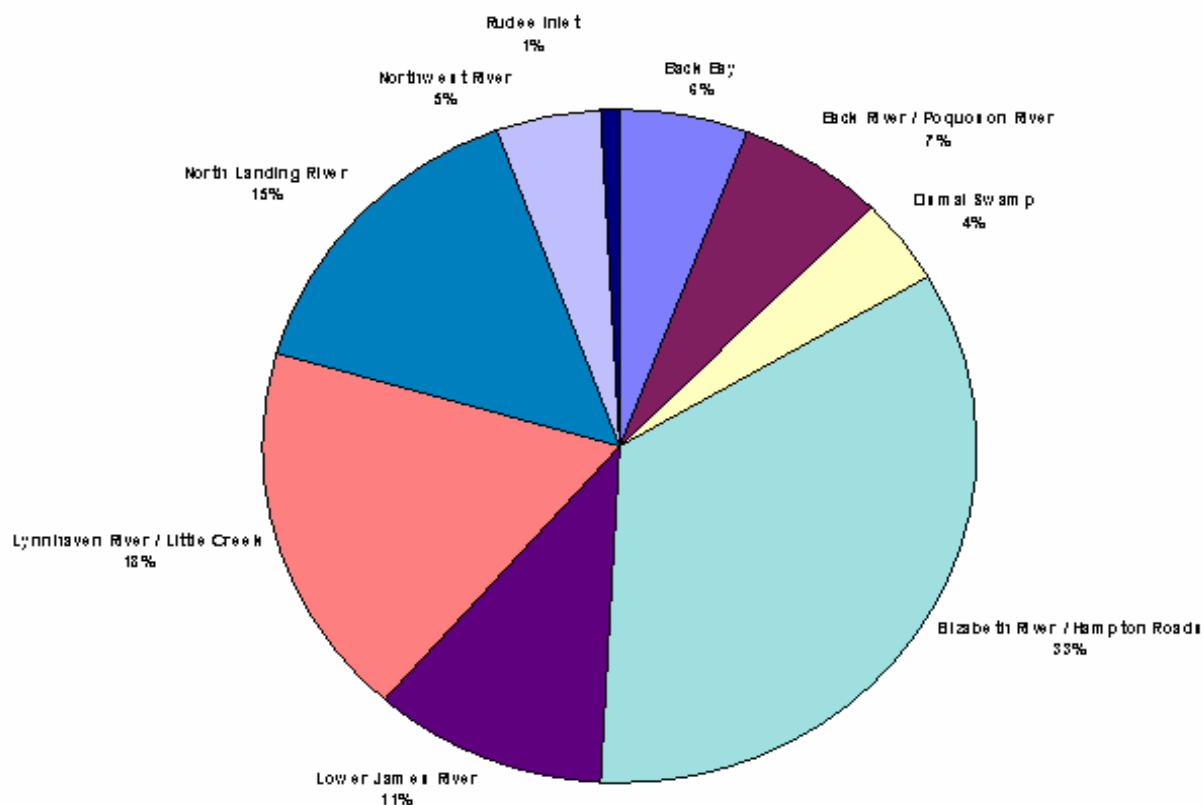


Figure 4: Pollutant Concentration Data for Virginia Beach

**Total Phosphorus (TP) Load (310,616 lb/yr)**  
**Distribution Between Major Watersheds in Study Area**  
**For the Year: 1999**



**Figure 5:** Total Phosphorus Load Distribution by Major Study Area Watersheds

A variety of reports can be generated from the myriad of data collected. Data can be sorted by locality, watershed, activity type, watershed within a specific locality, or summarized for the entire Hampton Roads region. Some examples of those tables and charts follow:

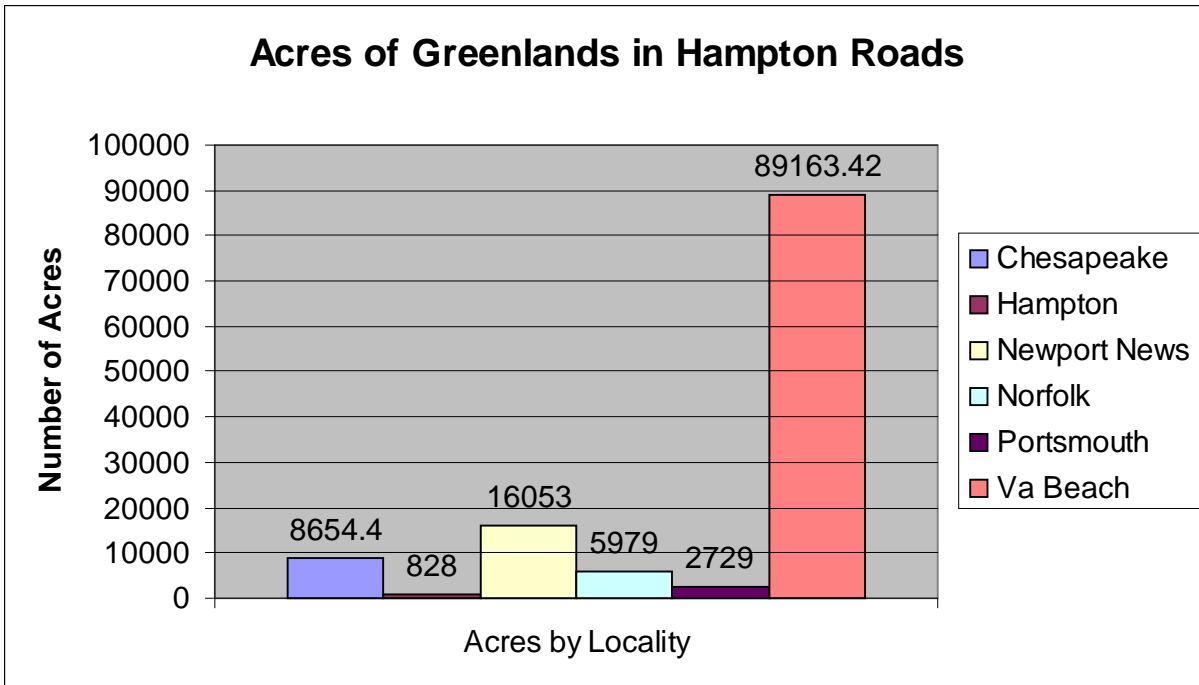


Figure 6: Acres of Greenland Areas in Hampton Roads

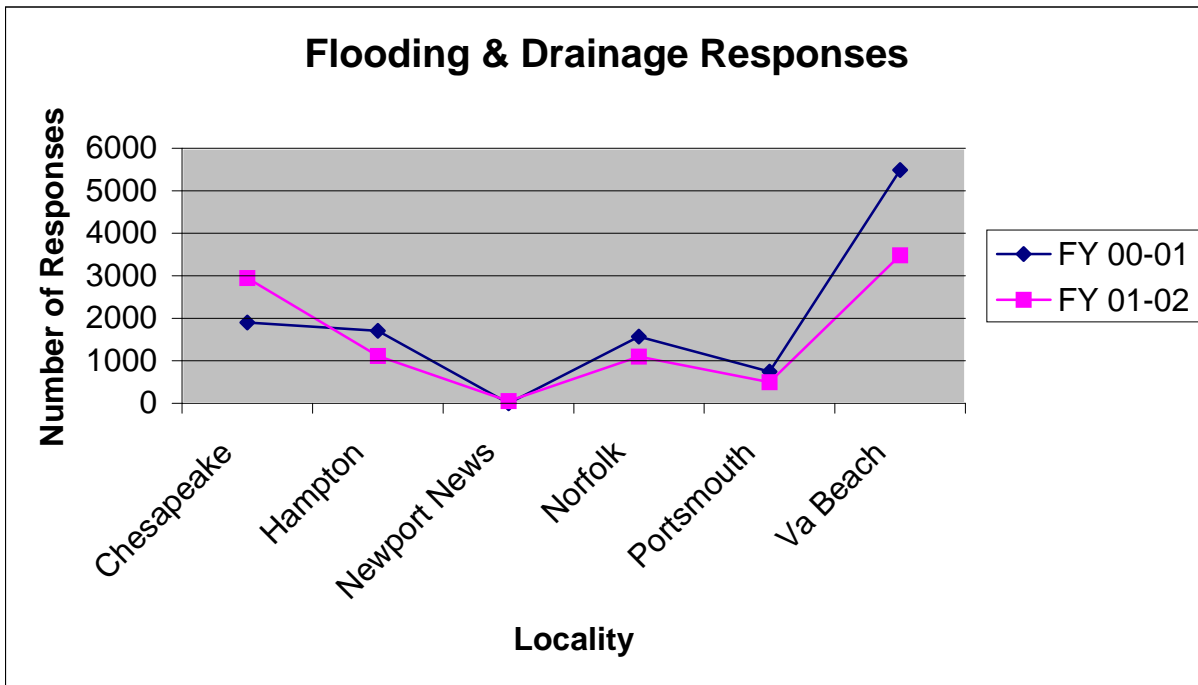


Figure 7: Flooding and Drainage Responses by Fiscal Year per Locality

**Table 2: Miles of Drainage Facilities Serviced**

<b>Miles of Drainage Facilities Serviced</b>		
	<b>FY 00-01</b>	<b>FY 01-02</b>
<b>Chesapeake</b>	<b>933</b>	<b>97.41</b>
<b>Hampton</b>	<b>405</b>	<b>325</b>
<b>Newport News</b>	<b>13880</b>	<b>242</b>
<b>Norfolk</b>	<b>11.14</b>	<b>199.9</b>
<b>Portsmouth</b>	<b>109</b>	<b>504</b>
<b>Va Beach</b>	<b>9</b>	<b>92</b>

**Table 3: Street Sweeping Miles and Tons Recovered**

<b>Street Sweeping FY 01-02</b>		
	<b>Miles</b>	<b>Tons</b>
<b>Chesapeake</b>	<b>6218.85</b>	<b>870</b>
<b>Hampton</b>	<b>715</b>	<b>2663</b>
<b>Newport News</b>	<b>12004</b>	<b>9378</b>
<b>Norfolk</b>	<b>50700</b>	<b>7245</b>
<b>Portsmouth</b>	<b>17073</b>	<b>653</b>
<b>Va Beach</b>	<b>10350</b>	<b>15646</b>

These various indicator groups, while not complete unto themselves, can together give a better indication of the success of an overall storm water management program. The data is also helpful to local governments in evaluating annual budgets; compiling long-term budget and program priorities for permit renewal; and having hard data to share with citizens and elected officials. A challenge of the tracking program has been keeping the data input consistent between and among localities, as often several staff members will be responsible for entering various pieces of the data for their locality. The goal of the reports is not to compare program weaknesses between localities, but rather to more effectively gauge local efforts and spending in relation to program accomplishments.

## **Conclusion**

Trial data was submitted to DEQ prior to formal permit renewal applications being submitted. During that time, work sessions were also held with the committee to gauge the usefulness and efficiency of the Indicator Tracking Program and to look at data management areas that needed enhancements or refinements. Local government and HRPDC staff responsible for technical and educational efforts participated in these sessions. Since inception, the tracking program has undergone several updates. This will be the first full permitted program year for reporting the data gathered by the Tracking Program for the Phase I communities.

In the recently enacted federal Phase II Stormwater Regulations, the U.S. Environmental Protection Agency recognizes the shortcomings of chemical monitoring. Rather than conduct a chemical monitoring program, Phase II communities are required to track the implementation of stormwater management measures. These management measures include public education and outreach, public involvement, illicit discharge detection and elimination, construction site runoff, post-construction runoff, and pollution prevention/good housekeeping activities. The Phase II Regulations recognize that this kind of tracking system provides a better measure of program effectiveness than chemical monitoring of stormwater outfalls. This is great justification of what was proposed for Phase I communities.

The Stormwater Management Program Effectiveness Indicator Tracking Program is similar to the tracking system required by the Phase II Stormwater Regulations. It is expected that the Stormwater Management Program Effectiveness Indicator Tracking Program will also be used by the local governments of Hampton

Roads affected by the Phase II Regulations to satisfy their permit requirements. This may require further enhancement of the program to assist smaller localities with data gathering tasks.

We anticipate further update to the database, as well as a series of training sessions for local users. While the tracking program allows the HRPDC to generate consist reports for all participating localities, challenges remain in getting data input that is consistent between and among localities.

In addition, the basic Tracking Program has been submitted as a suggested beginning model for discussions regarding consolidated tracking and reporting tasks that are typically required by various state agencies to meet program requirements.

## **References**

CH2MHill, 1999. Regional Stormwater Loading Study, Proposed Regional Monitoring Program and Program Effectiveness Indicators.

CH2MHill, 2000. Proposed Regional Monitoring Program, Stormwater Effectiveness Indicators, Database User's Guide Version 1.

Hampton Roads Planning District Commission, 2002. Indicators of Stormwater Effectiveness Fiscal Year 2000-2001.

# **USING INCENTIVES AND OTHER ACTIONS TO REDUCE WATERSHED IMPACTS FROM EXISTING DEVELOPMENT.**

Dawn Hottenroth, RS, CPESC  
City of Portland Bureau of Environmental Services  
[www.cleanrivers-pdx.org](http://www.cleanrivers-pdx.org)  
Portland, Oregon

## **Abstract**

Local jurisdictions must find new ways to mitigate impacts from urban development. Urban development creates a variety of negative impacts within watersheds. Impacts relating to the flow rate, volume and water quality of urban stormwater runoff are varied and sometimes difficult to remediate. While most local communities are beginning to implement post-development stormwater management requirements, many communities struggle to address impacts from existing development. Many local communities can have 80-90% of their land area already built out, which limits the overall effectiveness of new and redevelopment stormwater management requirements. Local businesses and citizens can either harm or help keep local waterways clean. They can also mitigate impacts from existing development. A combination of educational, technical assistance, and incentive programs can be used to change the behavior of businesses and citizens. Whether it is saving money, protecting the environment for future generations, gaining recognition or some other motivator for change, local jurisdictions need to create a menu of programs and incentives to gain the participation of citizens in protecting the environment. Portland, Oregon has made great strides at limiting impacts to local watersheds through creative programs such as Downspout Disconnection, Stewardship Grants, and Clean River Incentive and Discount Programs. These and other programs are leading the way to addressing and hopefully minimizing negative impacts from existing urban development.

## **Background**

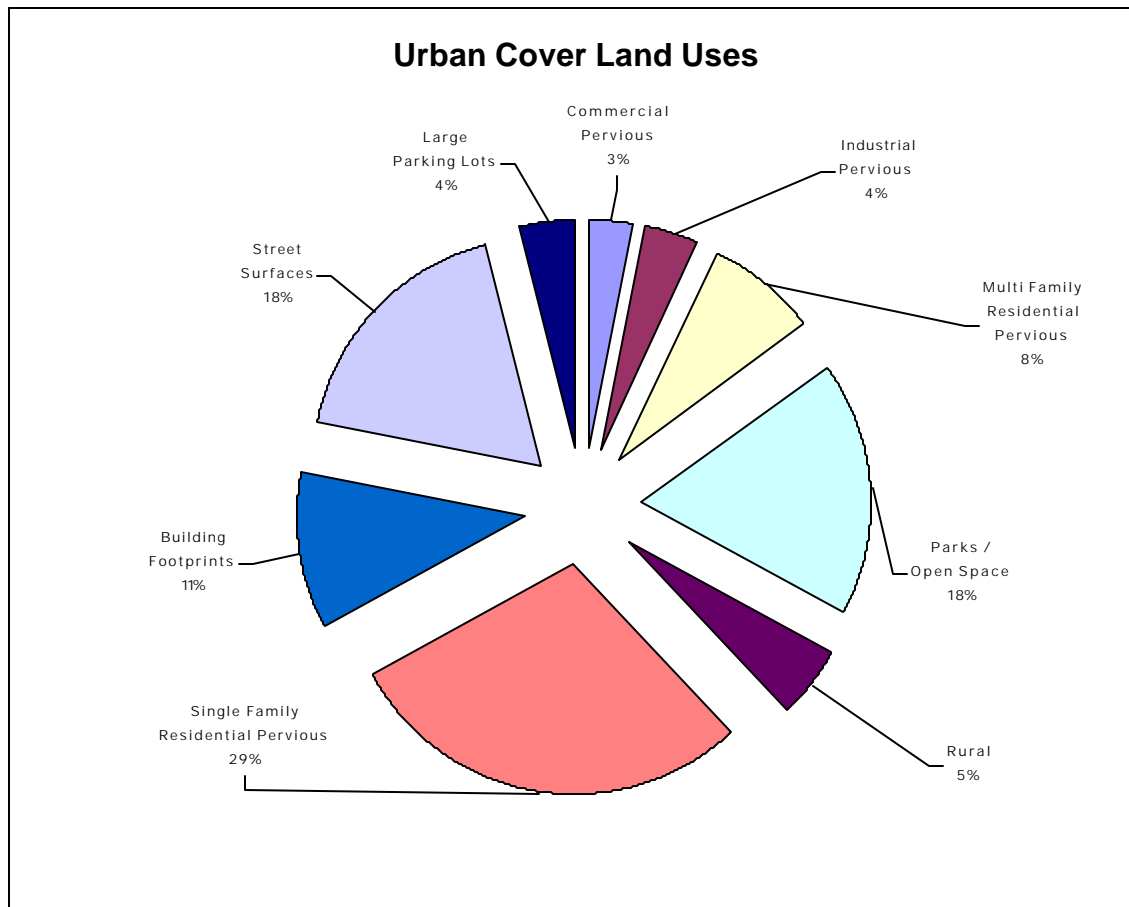
Portland, Oregon is located on the northern border of the state, at the confluence of the Columbia and Willamette Rivers. Portland is home to 510,000 citizens in an area of approximately 130 square miles. There are approximately 4,000 miles of street that are drained by 800 miles of combined sewer, 400 miles of storm sewer, 129 miles of drainage ditch and over 9,000 public drainage sumps. The City of Portland, Bureau of Environmental Services (BES) operates and maintains these storm drainage systems, two sewer treatment plants, and implements water quality improvement / watershed health program efforts. The City of Portland has a Phase 1 NPDES Municipal Stormwater Permit and was recognized in 1996 as the best stormwater permit program in the nation.

Portland is located at the bottom of the Willamette River watershed – one of the few south-to-north draining rivers in the United States. The Portland urban services boundary contains four major sub-watershed drainage systems and a large number of smaller drainageways that discharge directly to the Willamette River. Almost all of those drainages are listed by the State as not meeting their designated beneficial uses. There is an EPA designated Superfund site in the Willamette channel at Portland Harbor – between river miles 9 and 4 south of the Columbia River confluence.

Portland is home to a variety of state- and federal-listed threatened and endangered species. Perhaps the most significant are the three species of salmonids that have been listed in the Willamette watershed over the last three years. These fish species are directly impacted by citizen behavior and the runoff from existing development<sup>1</sup>.



Impervious surfaces from existing development account for approximately 33% of Portland’s total land area or just over 43 square miles of paved and other hard surfaces (see Figure No.1 below for land coverage breakdown). Of the 33% of the urban area that is impervious, 22% is paved areas that support car usage. Pervious housing areas only account for 37% and 7% pervious industrial and commercial areas. Open space and rural land use areas make up the remaining 23% of total land coverage<sup>2</sup>.



(Figure No. 1) City of Portland, Environmental Services GIS Zoning Layer. Information built from local zoning ordinances and the Metropolitan Service District 2040 Urban Growth Boundary Framework Plan.

**Problem**

Impervious surfaces have a variety of negative impacts on local watersheds. Besides significantly altering the natural water cycle, some of the most recognized specific impacts are:

- Decreased vegetative cover and stream shading. Damaged riparian zones provide minimal habitat and stormwater management functions.
- Increased stormwater volume and flow rate that contributes to streambank erosion, stream channelization, and flooding.
- Heat absorption by stormwater runoff that flows over impervious surfaces, resulting in increased surface water temperatures.

- Pollutant and sediment conveyance from impervious surfaces into surface water bodies, impairing water quality, fish habitat and spawning grounds.
- Low summer stream flows from lack of infiltration into groundwater recharge areas.

Multiple studies from across the nation, endorsed by the National Marine Fisheries Service (NMFS) and U.S. Fish and Wildlife Service (USFS), conclude that watershed degradation begins to occur when impervious surfaces exceed 10% of the area within a drainage basin. The goal of any stormwater management program aimed at addressing impacts from existing development should be to mitigate impacts to those that could be expected from a 10% impervious area coverage watershed. By instituting actions to transform a high impervious area drainage basin into a basin with only 10% *effective* impervious area, watershed degradation can be kept to a minimum. *Effective* impervious area is a term used to describe the portion of a site that discharges directly to a receiving system without any mitigation of impacts from interception, filtration, infiltration or other site practices.

So how does a local jurisdiction effectively reduce impacts to those of a 10% impervious area coverage basin? A mixture of education, technical assistance and incentive programs can make great strides to reaching this goal.

### **Portland's Program**

Portland has had an active watershed planning and education program in place since 1991. The first step of any program to address existing development impacts should be education. Many local jurisdictions already have in place foundational components to support educational programs. The City of Portland has multiple outreach and educational programs that strive to attain the following goals:

- ***To educate residents and businesses of the City that they are part of a natural watershed.*** All programs and outreach in the City are announced under their specific watershed areas – Johnson Creek, Tryon Creek, Fanno Creek, the Columbia Slough or the Willamette River.
- ***To educate residents and business about the final destination their stormwater runoff and sanitary drainage flows.*** In the City approximately one third of the urban services area discharges stormwater to each of the following locations: the combined sewer to the treatment plant; to the separate sewer, which mostly drains directly to local stream systems; and into underground aquifers through public sumps and private drywells.
- ***To educate citizens and businesses about how their every day behaviors impact the environment and what changes in behavior they can make to lessen those impacts.*** Usually programs include tips on changing behavior and/or onsite actions that help citizens protect clean rivers. Examples include washing cars over lawns to limit runoff of pollutants, planting trees to intercept rainfall and limit runoff, and use of native plant specific to limit horticultural chemical use and the potential for resulting polluted runoff.
- ***To create active citizenry and advocates for stormwater improvements within the City.*** These advocates then take on neighborhood projects, support program implementation or help fight for program funding. Many times stormwater program advocates come from related environmental programs such as the Audubon Society, Sierra Club, and watershed councils.

Portland's educational programs include a variety of standard activities such as brochures, billing inserts, and speakers bureaus, as well as a few unique programs. Many of Portland's programs are developed and implemented in partnership with other local agencies, such as:

***Environmental Services Educational Program*** – The City has two staff people dedicated to presenting programs for Portland school students K-12. Their curriculum includes education to support the goals above through humorous and entertaining assembly programs and classroom presentations. These educators also partner with schools to have students implement hands-on activities such as tree planting, stormwater management facility construction, or monitoring projects on or near school grounds. This program is funded through stormwater utility fees and reaches approximately 27,000 students every year.

***Regional Coalition for Clean Rivers and Streams*** – This regional awareness programs strives to present basic messages in the tri-county area in Portland. Working with nine other local stormwater agencies, the program runs multi-media campaigns throughout the region encouraging all regional citizens not to pollute. This program is funded through stormwater utility fees and reaches 1.4 million people a year.

***Naturescaping for Clean Rivers*** -This program was developed and is implemented by the City of Portland and the East Multnomah Soil and Water Conservation District. Targeting lawn and yard water, pesticide and fertilizer use, this program offers free workshops for local residents about the benefits and ease of using native plants in their landscape. What is especially unique about this program is the advice of a landscape architect in addressing specific property design questions. This program is funded through stormwater utility fees and reaches around 400 people a year.

Most local jurisdictions know that more than education is needed to motivate people to make behavior changes. What else is needed to motivate people to change? Primarily two things – giving citizens enough information to know what to do and making doing the right thing easy and/or financially beneficial.

### **Explaining What to Do – Technical Assistance**

Portland has a complex menu of options on what we want people to do to lessen their impacts on local watersheds. Most actions fall into two broad categories – changing behaviors, like driving a car less, and retrofitting a site for onsite stormwater management, through planting a tree or disconnecting downspouts. Usually the behavior changes that the City promotes to lessen impacts on the local watershed also meet objectives of other programs. For instance, driving your car less reduces the amount of oil drips, car exhaust deposits, brake and tire wear particulates that end up on street surfaces, and are ultimately discharged to local waterways during storms. Having fewer cars on the road can also help limit air pollution and congestion on local roadways. Most suggested behavioral changes either limit the amount of pollution or the total volume and/or flow rate of stormwater runoff. Water quality related actions primarily focus on preventing or limiting pollution coming in contact with stormwater runoff. Volume control actions focus on infiltrating stormwater onsite or otherwise mimicking the natural flow regime for the watershed area. Because behavior changes that reduce volume or pollutants in stormwater have multiple benefits, there are great opportunities to partner with other agency programs on these multi-objective pollution prevention messages. BES looks to our educational programs to suggest behavior changes and make referrals to other agency programs for specific implementation details.

Onsite stormwater management changes are a bit more complex. It can be very difficult to present solutions in a way that can convince the average person to institute change. Many local programs simply suggest a concept or idea but fail to provide enough implementation information to make a site retrofit possible. For

example, the simplest stormwater retrofit programs (including Portland's) suggest that people "just plant a tree." Seems simple enough, but what type of tree should they plant and where? Many city codes dictate the "what" and "where" of an action. Property owners may be unaware of these regulations or have troublesome site-specific constraints that seem to be barriers to implementing retrofits. Most citizens, whether at their home or business, need additional help in mitigating impacts or changing behaviors. Ideally, there would be a city staff person available to answer any request at any time and assist owners through every step of the retrofit process. Yet, realistically, face-to-face assistance is not usually possible due to limited staff and financial resources. So we look to surrogates – whether through detailed instruction materials, in-depth workshops or short onsite visits.

One of the best places to look for detailed guidance on site retrofits is the new and redevelopment stormwater facility requirements manual. Even though existing development is not likely to be required to retrofit, they should still strive to manage stormwater to the same level as new and redeveloping properties. In reality, specific site constraints usually limit the extent of area available for retrofits, thus limiting the extent of onsite stormwater management.

Portland's Stormwater Management Manual (SWMM) provides a great deal of guidance on facility selection, facility sizing, plant selection, and maintenance activities. There are a number of City programs encouraging on-site retrofits that make great use of information in the SWMM. One particular element of the SWMM that is especially useful is the sizing form. During the last 2 years, the SWMM has undergone its second revision with the specific goal of making stormwater facility design as easy as possible. One element of that effort was the creating of a sizing matrix for simple facility design. The matrix – SIM form (Figure No. 2) – from this new development manual can be used as a great guidance document for sizing retrofit facilities for existing development. The SWMM is available at [www.cleanriverspdx.org/tech\\_resources/2002\\_swmm.htm](http://www.cleanriverspdx.org/tech_resources/2002_swmm.htm) in its entirety.

Form SIM: Simplified Approach for Stormwater Management				
The city has produced this form to assist with a quick and simple approach to manage stormwater quality, flow rate, and volume on projects. Facilities sized with this form are presumed to comply with stormwater quality and flow control requirements.				
New or Redeveloped Impervious Site Area		<input type="text"/>	Box 1	
		Column 1	Column 2	Column 3
<b>INSTRUCTIONS</b>		<b>Impervious Area Managed = Facility Surface Area</b>		
1. Enter square footage of new or redeveloped impervious site area in Box 1 at the top of this form.	<b>Impervious Area Reduction Technique</b>			
	1) Eco-Roof / Roof Garden	<input type="text"/>	sf	
	2) Contained Planter Box	<input type="text"/>	sf	
	3) Tree Credit (See Next Page)	<input type="text"/>	sf	
2. Select impervious area reduction techniques from rows 1-3 to reduce the site's resulting stormwater management requirement. Tree credit can be calculated using the tree credit worksheet on the next page.	Note: Porous Pavement areas do not need to be included in Box 1			
3. Select desired stormwater management facilities from rows 4-12. In Column 1, enter the square footage of impervious area that each facility will manage.	<b>Stormwater Management Facility</b>	<b>Impervious Area Managed</b>	<b>Sizing Factor</b>	<b>Facility Surface Area</b>
	4) Infiltration Planter Box	<input type="text"/>	sf x 0.06 =	<input type="text"/> sf
	5) Flow-Through Planter Box	<input type="text"/>	sf x 0.06 =	<input type="text"/> sf
	6) Vegetated Swale	<input type="text"/>	sf x 0.09 =	<input type="text"/> sf
	7) Grassy Swale	<input type="text"/>	sf x 0.1 =	<input type="text"/> sf
	8) Vegetated Filter Strip	<input type="text"/>	sf x 0.2 =	<input type="text"/> sf
	9) Vegetated Infil. Basin	<input type="text"/>	sf x 0.09 =	<input type="text"/> sf
	10) Sand Filter	<input type="text"/>	sf x 0.06 =	<input type="text"/> sf
	11) East Side Soakage Trench	<input type="text"/>	sf x 0.06 =	<input type="text"/> sf
	12) West Side Soakage Trench	<input type="text"/>	sf x 0.08 =	<input type="text"/> sf
4. Multiply each impervious area from Column 1 by the corresponding sizing factor in Column 2, and enter the result in Column 3. This is the facility surface area needed to manage runoff from the impervious area.				
5. Total Column 1 (Rows 1-12) and enter the resulting "Impervious Area Managed" in Box 2.	<b>Total Impervious Area Managed</b>		<input type="text"/>	Box 2
6. Subtract Box 2 from Box 1 and enter the result in Box 3. If this number is less than 500 square feet, stormwater quality and quantity requirements have been met. Submit this form with the application for permit.	<b>Box 1 - Box 2</b>		<input type="text"/>	Box 3
7. If Box 3 is greater than 500 square feet, add square footage or facilities to Column 1 and recalculate, or use additional facilities from Chapter 3.0 of the Stormwater Management Manual to manage stormwater from these remaining surfaces.				

(Figure No. 2) Simplified Sizing Form from the 2002 Revision of the City of Portland Stormwater Management Manual.

This sizing form is unique because it incorporates not only sizing for water quality treatment but also sizing for flow control and detention as well. When seeking to retrofit existing development – guidance pieces from your new and redevelopment stormwater facility requirements manual can be very useful.

Portland has a number of programs geared toward assisting property owners to retrofit their sites to do onsite stormwater management. The majority of homes in Portland are currently piped into a combined or separate storm sewer. Onsite stormwater management facilities can help mitigate a site's effective impervious area and better mimic the natural hydrologic water cycle. Here's a highlight of some of Portland's most successful programs:

**Downspout Disconnection (for residential properties)** – Driven by the need to remove water from the combined sewer system to reduce overflows, in 1996 the City of Portland created the Downspout

Disconnection Program. This program targets properties in north, northeast and southeast Portland to disconnect roof downspouts onto lawns and flowerbeds. Property owners may also use onsite stormwater management facilities such as drywells and soakage trenches. This program is very unique in its approach. BES developed an interagency agreement with the City’s Plumbing division to work directly with homeowners to disconnect downspouts without the homeowner having to get a plumbing permit for the alterations to their building’s drainage system. BES staff developed safety criteria for allowable disconnections and set up a monitoring and inspection program to assure disconnections were completed safely. To implement, a target area of Combined Sewer Overflow (CSO) basins is selected and Disconnection Program staff go to work. An aggressive marketing and door-to-door canvassing campaign begins, to get voluntary agreement from property owners to complete the disconnection. Owners then elect to complete the disconnection themselves and receive a \$53 per downspout incentive, or to have the City complete the disconnection for them free of charge. The City disconnections are completed either by volunteer groups (such as scouting troops, neighborhood groups, and students) or by emerging or minority small business contractors. Volunteer groups receive a stipend for each downspout they disconnect. Contractors are chosen through a City bid process. The City then inspects the work of the volunteers, City contractors, homeowner or plumber the homeowner may have hired, to assure disconnections are made safely. If the goal for the target amount of roof area removed is not met in a basin, a mandatory version of the program can be implemented. Other stormwater management messages are delivered under this program – such as planting trees for homeowners who have disconnected. The City has disconnected downspouts at almost 17,000 homes over the last six and a half years, and has collected data on prior disconnections at an additional 20,000 homes. The program is funded primarily by a mixture of capital and operating funds due to this ability to remove enough stormwater from the CSO system, that collection pipes may be able to be downsized providing significant pipe construction cost savings.



**(Figure No. 3) Typical Residential Downspout Disconnection**

***Sustainable Site Development*** – This program grew from the early pilot project efforts to comply with the NPDES Municipal Stormwater Permit. The program offers technical assistance and design guidance for retrofit and developing properties. This free assistance might sway a property owner to use a swale instead of a pipe to convey parking lot runoff. City staff usually makes the initial contact from a referral of the watershed planning staff or through a land use or building plan review. This program has had some good initial success due to early contact and the ability to provide some design details to developers. The program primarily involves investment of staff time only and supports approximately 20 projects a year.

***Stewardship Program*** – This is a joint program of the City of Portland, Portland State University and Americorps program. The Stewardship program staff members assist individual property owners with revegetation and onsite stormwater management projects. Students assist property owners in developing site designs, identifying and applying for appropriate local, state and federal permits, and identifying volunteers or other resources to implement the project. Students are assigned to specific watershed programs within the City and often coordinate and complete projects with local watershed councils. Stewardship Program staff and grants are funded through stormwater utility fees and work with about 10 projects per year.

### **Providing Motivation – Recognition and Incentives**

Although we have taught the citizens of Portland about their impacts on local watershed and given them some guidance and technical assistance on how to change behavior and retrofit their properties, most people still need more motivation to make a change. Individual motivations can be varied across a broad spectrum – but two common motivations are recognition and money. The City has developed a number of programs that rely on recognition and/or other incentives to drive change in our citizenry. Here are some program highlights:

***Ecological Business Program*** – Interviews of local NE Portland Businesses in 1995 demonstrated a desire of business owners not to be characterized as the “environmental bad guys.” Many business owners strive to do the most environmentally friendly thing, and the number of bad actors from an environmental standpoint is usually a small percentage of the businesses out there. So, rather than relying on the few business horror stories as the only case studies reported by the media, businesses asked the City to develop a program to highlight “environmentally friendly” businesses. The City took this request to heart. The City already had a partnership with six other local and state agencies to produce educational materials in a coordinated matter. The partnership, called the Pollution Prevention Outreach (P2O) Team, already produced successful used oil disposal and paint waste outreach materials that were helpful to businesses. So the P2O team developed the Ecological Business Program. “Eco-biz” was the first multi-media and multi-jurisdictional business recognition program in the nation. Local regulatory staff with air, water quality, wastewater, hazardous waste, solid waste, stormwater, energy and water-use backgrounds developed a certification and recognition program to highlight environmentally friendly businesses in the Portland region. The program is business sector-based. Eco-biz started with automotive service shops and is now working on a Landscape Contractor program. Along the way, Dental and Print Shop programs similar to Eco-biz have been developed in the region. Eco-biz partners work with local business trade groups to develop environmentally friendly best management practices, a program certification checklist and recognition materials for program participants. After a certification visit, participating shops receive a shop display package, press coverage, listing on the program web site ([www.ecobiz.org](http://www.ecobiz.org)), and general promotion on the radio and at public events. This program is funded by several agencies through grants, agency staff time and minimal advertising and printing budgets (< \$10,000). Over 40 automotive shops are certified

since the program launched in September of 1999. Those shops on average have implemented 89% of all the recommended environmental actions – including stormwater improvements from redirecting wash waters away from storm systems and providing secondary containment for liquid storage and working areas. An evaluation report completed in September of 2000 found the average ecobiz shop generated 5 cubic feet less cardboard and paper, 2.5 cubic feet less of metal scrap and 4 less batteries to the solid waste system per month.



**(Figure No. 4) Ecological Business Automotive Services Program Logo**

***Stewardship Grants*** – One aspect of the Stewardship Program is the Stewardship Grants Program. BES funds a small number of low cost grants (<\$5,000) for community-based projects in the City. Grants have been used to pay for streambank restoration projects, downspout disconnections, stormwater facility retrofits and naturescaping. Applicants can be either public or private entities and a number of the grants have gone to school projects – including one native plant greenhouse. Grants are awarded every May and must be completed by the following summer. Applications stressing partnership with other community groups or showing inclusion of other investment or funding sources are prioritized for grant award. In the grant year of 2001, \$46,374 was awarded yielding \$242,683 worth of project investment. Projects resulted in planting over 10,000 trees and restoration of over 8,800 lineal feet of streambank. Projects are recognized each year in an annual report prepared by BES. Grants are funded by Stormwater utility fees.

***Clean River Incentive and Discount Program (CRID)*** – This incentive program will provide financial incentives to property owners who manage stormwater on their site. The program is currently delayed due to the installation of a failing billing system. Once the billing system is repaired, the program should be instituted. The main goal of the CRID is to drive property owners to retrofit through provision of a discount on their monthly stormwater utility charge. The CRID was developed in the summer and fall of 2000 as a method of rate reform for the citizens of Portland. City sewer rates are rising at approximately 9% a year to fund the billion-dollar CSO program. The CRID actually alters the breakdown of the stormwater utility rate. Previously, properties paid one rate based on the amount of impervious surface on their property. In January 2001, the Portland City Council instituted a two-part rate –35% of the charge for providing drainage services to the property and 65% of the charge to provide drainage services to the public right of way that served the property. Not only did the charge breakdown reinforce that street drainage is an issue the City must deal with, it also allowed a portion of the rate to be discounted for properties providing



onsite stormwater management. So with 35% of the stormwater rate up for a potential discount, some properties could be incented to make retrofit changes. The CRID has a simplified discount program for residential properties based on volume control, and a more complex commercial property program that requires water quality and flow control for the full discount. Surface vegetated facilities were ranked higher than subsurface facilities for the eligible portion of the discount. BES was working on a prorated discount funding program to help pay for the initial capital outlay when the City's new water and sewer billing system started to fail.

## **Conclusions**

The City of Portland has successfully developed a number of educational, technical assistance, recognition and incentive based programs to encourage our citizens to help limit their impacts on local watersheds. While these efforts may be noteworthy, they are not sufficient to address existing development watershed impacts all by themselves. Some tasks for mitigating urban area impacts are the City's alone. So the City will continue to build regional stormwater management facilities, improve our operations and maintenance practices on City streets and sewers and protect and enhance riparian resource areas. But we will be looking to develop additional programs to enlist the aid of Portland's citizens to limit our impacts on local watersheds. While new programs may have staffing and other limited resources available for implementation, there will be no lack in drive from City staff and our local environmental advocates to reach for that 10% effective impervious area target.

## **References**

1. *City of Portland Bureau of Environmental Services Draft Biological Assessment of the Effects of Stormwater Management Activities on Thirteen ESUs of Chinook, Sockeye, and Chum Salmon, Steelhead, and Cutthroat Trout*, Beak & CH2M Hill, July 2000.
2. *City of Portland Zoning Codes and Metro Service District 2040 Land Use Plan Framework*, City of Portland Bureau of Environmental Services Graphical Information System Zoning Layer, October 2002 (updated quarterly)
3. *Program Evaluation: Automotive Ecological Business Program*, Valle & Nielson (BES Intern Program), September 2000

# LESSONS LEARNED FROM IN-FIELD EVALUATIONS OF PHASE I MUNICIPAL STORM WATER PROGRAMS

John Kosco, Wes Ganter, and James Collins  
Tetra Tech, Inc.  
Fairfax, VA

Laura Gentile and John Tinger  
U.S. EPA Region IX  
San Francisco, CA

## Abstract

Tetra Tech is assisting EPA in the evaluation of a number of storm water Phase I MS4 permit programs in California and selected other States. These evaluations consist of two components: a programmatic review of individual city and county programs implementing permit requirements and an on-site/in-field verification of these program elements. This in-field verification allows EPA and the State to assess whether a program is actually being implemented as described 'on paper.' The overall goals of these evaluations are to complete a baseline assessment of each program area, determine compliance with permit requirements and the stormwater management plan, collect information for permit reissuance, and determine how municipalities measure program effectiveness. In addition, the 'lessons learned' from these evaluations can be directly applied by many of the Phase II jurisdictions, which will begin permit coverage in March 2003.

## Introduction

On November 16, 1990, the U.S. Environmental Protection Agency (EPA) published regulations (the 'Phase I rule') requiring National Pollutant Discharge Elimination System (NPDES) permits for certain industrial, construction and municipal sources of storm water runoff fundamentally changing the way storm water runoff is regulated at the State and Federal levels. Approximately 1,000 MS4s ('municipal separate storm sewer systems'), consisting primarily of City and County government agencies responsible for storm water, have been permitted under the Phase I regulations. The Phase I MS4 regulations generally require MS4s to reduce discharges of pollutants to the maximum extent practicable and to prohibit illicit discharges to the MS4. Specific elements in a Phase I Municipal Storm Water Management Program include public education, public agency or municipal maintenance activities, new development, construction, industrial/commercial facilities, illicit discharges and improper disposal, monitoring and reporting.

Phase II of the storm water program, established in 1999, extends the coverage to include municipalities within urbanized areas and all construction disturbing at least one acre. Permits for these Phase II sources, which will include over 5,000 additional MS4s, are scheduled to become effective on March 10, 2003. Phase II Municipal Storm Water Management Programs are required to address public education, public involvement, illicit discharges, construction, new development, and municipal operations.

Although many Phase I MS4 permits are in their second or third permit cycle, EPA has not yet completed a comprehensive compliance assessment of these MS4 permits. A General Accounting Office report published in June 2001 (GAO, 2001) found that neither the overall costs of implementing the storm water

program nor the program's effectiveness had been determined. This GAO report followed an EPA report on the Phase I storm water regulations (EPA, 2000) that found many effective Phase I program components, but admitted that EPA did not have a system in place to comprehensively measure the success of the Phase I program on a national scale.

## **Storm Water Phase I MS4 Evaluations**

EPA Region IX hired Tetra Tech, Inc. in 2001 to begin a series of MS4 evaluations in the State of California to assess the compliance status of individual storm water Phase I MS4 permittees. In order to assess on-the-ground implementation of the programs, these program evaluations are conducted on-site. The on-site evaluation consists of two components: a programmatic review of individual MS4 programs implementing permit requirements and an in-field verification of these program elements. This in-field verification allows EPA and the State to assess whether a program is actually being implemented as described 'on paper.'

The project goals of the on-site MS4 evaluations include obtaining an overall picture of MS4 compliance, documenting effective elements of existing Phase I programs, identifying methods to improve MS4 program reporting, and developing a guidance document to assist State and/or EPA inspectors in conducting future MS4 evaluations.

Determining compliance with MS4 permits is in many cases subjective. Unlike some other environmental programs such as the pretreatment program, there is no checklist, list of BMPs, or objective criteria that all MS4s need to meet. In addition, EPA has not defined 'maximum extent practicable' or MEP which is the regulatory standard that MS4s must meet. This leaves it up to individual permit writers to define for each MS4 permit. Therefore, the MS4 inspectors have been using their best professional judgment and experience to identify program elements that are 'effective' or 'deficient.'

The MS4 on-site evaluations conducted to date have typically consisted of a 3-4 day on-site review. This on-site review has been conducted on a single MS4, and has also included multiple co-permittee MS4s evaluated with up to three investigators. For each of the MS4s evaluated, a number of staff from multiple departments were typically involved. Typical departments involved in the MS4 evaluations included public works, transportation, planning, development, and parks/recreation. As of December 2002, 14 MS4 evaluations have been conducted in EPA Region IX, covering 41 separate permittees.

The MS4 inspectors typically do not review or make recommendations on financial resources. Where a program element is clearly not being implemented to the maximum extent practicable – for example, when compliance with local construction erosion and sediment control requirements is poor due to lack of inspections – that will be noted as a deficiency. The MS4 inspectors will suggest improvements to the program so resources can be used for effectively, but responding to those suggestions or how to resolve the identified deficiencies is up to each individual MS4.

A wide variety of storm water permits, storm water management programs, and compliance with those permits and programs were found during the evaluations. However, some common trends were observed as indicated in the following sections. The trends and evaluation findings are grouped into the broad categories of program management/planning, implementation, and evaluation.

## **Program Management/Planning Findings**

A clear, well-written permit and plan are critical for successful implementation of a storm water management program. This requires the permitting authority to describe the required actions clearly in a permit and the permittee to clearly articulate how it will meet these requirements in a storm water plan. The Phase I MS4 evaluations conducted by Tetra Tech have found that the more advanced storm water programs generally have more detailed, well-written permits and plans. Several findings common to most of the programs evaluated are described below.

### **NPDES MS4 permits and MS4 stormwater management programs need to contain quantifiable, measurable elements so compliance can be determined.**

Storm water permits vary significantly in their level of detail. Some third-term permits issued in California contain very specific, measurable elements which are clear for the permittee to implement and relatively straightforward for the State to determine compliance. For nonspecific permits that simply require the MS4 to “implement a storm water management plan,” determining compliance becomes more difficult. More importantly, the permit does not specify, or measure, the level of effort expected, so MS4s do not have a clear target to achieve.

The storm water Phase II regulations require small MS4s to develop “measurable goals” for each BMP in their program. These measurable goals are intended to provide a quantifiable target for the MS4s to achieve in the implementation of that BMP. Although a similar requirement does not specifically exist for Phase I, permits and programs developed under Phase I should begin to include these measurable goals. For example, the permit and program should specify the number of industrial inspections expected per year and the number of catch basins that should be inspected and cleaned. This provides a level of certainty to the MS4 that they are successfully implementing the permit and allows the State to more easily evaluate compliance.

Some MS4 permits in California are including specific, measurable requirements that make determining compliance easier. Also, the City and County of Sacramento have developed stormwater plans that are clear, well-written, and begin to address the issue of measurable goals which are called ‘minimum performance standards’ and ‘performance and effectiveness measures’, respectively, in each plan (City of Sacramento, 2000 and County of Sacramento, 2000).

### **Programs are not designed to specifically address pollutants of concern.**

The primary goal of programs under the Clean Water Act is to achieve fishable, swimmable waters by meeting water quality standards. Many MS4 programs are not designed to address the specific pollutants of concern already identified in their watershed. Where pollutants of concern have been identified, MS4 programs should be modified to include BMPs and programs that specifically target a reduction in these pollutants.

Some Phase I programs in California are developing plans to address identified pollutants of concern in their community, including those pollutants identified on the State’s Section 303(d) list. Pollutants of concern can also be identified from local studies or watershed research. Several programs, including programs in Alameda County and Sacramento County, have developed strategies to more specifically target and reduce pollutants of concern. For example, Sacramento County is developing a series of Target Pollutant Reduction strategies to focus some program resources on pollutants that cause or are likely to cause impairments in local receiving waters. Target pollutants for the Sacramento area include diazinon,

chlorpyrifos, coliform/pathogens, copper, and lead. Sacramento County still implements baseline activities, but uses the target pollutant reduction strategies to ensure activities are developed to address specific pollutants.

**Combining resources and expertise into a committee can save MS4s time and money.**

Many MS4s that have been permitted together have joined resources in a committee structure. This sharing of resources and experience can help all participating MS4s by more efficiently developing public education materials, guidance, standard forms and other materials for all of the MS4s to use. Also, for smaller MS4s with more limited budgets, the committee structure provides assistance these MS4s may not have been able to otherwise obtain, such as use of a centralized database for entering and managing reporting information. Examples of storm water management committees can be found in several California counties, including Alameda, Sacramento, Ventura, San Diego, and Los Angeles.

## **Implementation Findings**

As the stormwater Phase I program is implemented and matures, Phase I MS4s are continuing to struggle with the implementation of several common aspects of the program. On-the-ground activities such as inspections of construction sites and industrial facilities appear to be a common problem, while other programs like public education and municipal maintenance are often more advanced. Below are several of the common findings associated with implementation of the storm water Phase I program.

**Compliance with local construction site erosion and sediment controls is a challenge for all MS4s.**

Storm water Phase I regulations require MS4s to develop a local program to control construction site runoff. Many MS4s, however, find this program a challenge to implement. The frequency of inspections at construction sites required to ensure proper installation and maintenance of erosion and sediment control BMPs is often lacking. Some MS4s count all inspector visits to construction sites, even inspectors who have nothing to do with erosion and sediment controls. Also, some MS4s have different requirements for public and private construction sites. All of these factors can contribute to a program that is ineffective in preventing erosion and sediment control problems at construction sites.

Tetra Tech has found that successful programs often have dedicated erosion and sediment control inspectors for local construction projects. These inspectors are involved in not only inspections, but also participate in the plan review process so they are aware of what erosion and sediment controls and post-construction BMPs the construction sites are required to implement. Also, these inspectors have adequate enforcement mechanisms such as stop work authority or the ability to fine contractors to ensure compliance.

**Local MS4 industrial and construction inspectors are often unaware of State permit requirements.**

The State of California, like all states, has issued statewide general permits for controlling storm water runoff from industrial facilities and construction activity. Within Phase I areas, however, industrial facilities and construction operators also need to comply with the local MS4 program to address industrial or construction runoff. Many local inspectors, although they are trained in the local requirements, are often unaware of the requirements contained in the statewide permit. In some cases this is intentional, as the MS4 does not want the responsibility of enforcing the statewide permit requirements. However, MS4s can provide a valuable service to their local construction and industrial facilities by explaining the difference between the two sets of requirements, and what these facilities need to do to comply with the statewide requirements.

Some programs avoid this problem by simply adopting the statewide permit requirement for a stormwater pollution prevention plan (SWPPP) as their own requirement. This ensures that local construction operators only need to develop one plan to comply with both local and state stormwater requirements, and local construction inspectors only need to know one set of requirements.

**Pretreatment inspectors, if available, can efficiently conduct industrial stormwater inspections.**

The pretreatment program is a well-established program with existing staff trained in water quality practices and enforcement techniques. Some MS4s have expanded the role of pretreatment inspectors to also conduct industrial stormwater inspections. Many of these industrial facilities are already included in the pretreatment program, therefore the on-site inspector simply needs to also include several stormwater elements in their inspections. For MS4s with an existing pretreatment program, this expansion of pretreatment inspector duties to include stormwater inspections effectively implements the program without creating a separate inspection program. Of course, this approach may not be as effective in areas where the sanitary sewer system does not fully coincide with the storm drainage system (e.g., areas on septic systems).

**Many MS4s fail to identify and eliminate dry weather discharges.**

A separate storm drain system is designed to carry only storm water runoff. Dry weather, therefore, presents MS4s an excellent opportunity to identify and eliminate non-stormwater discharges to their storm drain system. The evaluations have found that many MS4s, however, fail to identify and eliminate dry weather discharges. These MS4s either fail to look for any discharges during dry weather, or assume that all dry weather discharges are attributable to landscape irrigation, groundwater infiltration, or some other uncontaminated source.

**Municipal maintenance and spill response programs are often more advanced than other program areas.**

Due to the need to minimize episodes of flooding, MS4s often have effective maintenance programs of their storm drain systems. The municipal maintenance staff are often well trained, equipped, and have detailed records of their maintenance activities. Also, other related programs such as street sweeping, which are often initiated for different reasons (e.g., aesthetics), also have significant stormwater benefits. In addition, for obvious public safety reasons, many MS4s have effective spill response programs.

**Many MS4s have extensive public education programs.**

Public education programs are often an ‘easy’ and ‘fun’ program for MS4s to implement. Many MS4s have been very innovative in finding new methods to reach target audiences. This includes websites, classroom educational programs, radio and TV commercials, mascots, and public involvement programs such as storm drain stenciling programs. Some MS4s have also taken surveys of their residents to determine the overall level of awareness and effectiveness of their public education programs.

## **Evaluation Findings**

As EPA found with its 2000 Report to Congress (EPA, 2000), evaluating the effectiveness of the stormwater program is a difficult task. However, successful programs are developing local measures by which progress or effectiveness can be evaluated, including the use of environmental indicators. Tetra Tech found that many programs share common problems in terms of program evaluation, as described in the findings below.

**MS4 programs are not evaluating their data and are therefore not modifying programs in response to trends in this data.**

EPA envisioned the storm water program to be an iterative process. Storm water permits, and programs, should evaluate what is working and be able to make modifications in response to changing conditions. Many programs, however, are not collecting the data, such as monitoring or other performance and effectiveness data, necessary to determine needed changes.

At a minimum, programs should complete a comprehensive outcome evaluation at the end of each permit term, and should complete an annual process evaluation at the end of each year with the submittal of the annual report. This will ensure that programs are responsive to changing priorities and needs.

**MS4 programs should develop different methods to evaluate the effectiveness of their programs.**

All Phase I MS4s collect monitoring data, but few programs are collecting enough water quality data to show statistically significant changes. Other evaluation techniques, such as environmental indicators, should be considered by these programs as a way to characterize water quality conditions and provide a benchmark for evaluating the success of the stormwater management program. These indicators (Claytor and Brown, 1996) should include a mixture of programmatic indicators, physical and hydrological indicators, biological indicators, social indicators, programmatic indicators and site indicators. Examples include toxicity testing as a water quality indicator and the number of illicit connections identified/corrected as a programmatic indicator. These indicators are important due to the difficulty and expense in documenting water quality improvements solely from water quality monitoring data. Environmental indicators can also be used to ascertain that high quality waters are being maintained or provide an early warning of when their beneficial uses are at risk of being degraded.

**Annual reports provide useful information, but are not always good indicators of program effectiveness.**

The on-site evaluations have revealed that, although annual reports *can* indicate the success of a program, poor programs can hide behind well-written annual reports and some aspects of effective programs can be hidden or missing from annual reports. Because there is not a standardized reporting process for all Phase I MS4s, this allows each MS4 to choose the type of information it wants to present. A knowledgeable report writer can selectively report certain information, such as the total number of municipal inspectors visiting a construction site instead of the number of inspectors specifically evaluating stormwater controls.

The absence of a standardized report could become especially important as the 5,000+ stormwater Phase II MS4s begin to submit annual reports. A consistent reporting format will allow states to compare information collected from MS4s and will also allow EPA to compare reporting results across states.

**Compliance with a permit may not always indicate that a program is successful in protecting water quality.**

There is a significant variability in the requirements within the Phase I MS4 permits, even within the State of California. This variability, along with the iterative nature of stormwater permitting, allows MS4s to operate under different guidelines, and implement different programs. A program's success should be tied not only to meeting permit requirements, but also to meeting water quality goals.

## Conclusions

Before the storm water Phase I program, most municipal storm water programs were primarily designed to address water quantity issues (e.g. minimize flooding). The storm water Phase I program is beginning to mature and learn from mistakes in the past, however a significant amount of work remains in developing guidance or programs to document these lessons. Improved reporting, monitoring, and evaluation techniques are needed, but will likely only be implemented in many programs through changes in NPDES permit requirements.

## References

U.S. General Accounting Office (GAO), 2001. *Water Quality: Better Data and Evaluation of Urban Runoff Programs Needed to Assess Effectiveness*. GAO-01-679. Washington, DC.

U.S. Environmental Protection Agency, 2000. *Report to Congress on the Phase I Storm Water Regulations*. EPA 833-R-00-001. Washington, DC.

Claytor, R. and W. Brown, 1996. *Environmental Indicators to Assess Stormwater Control Programs and Practices*, Center for Watershed Protection, Ellicott City, Maryland.

City of Sacramento, 2000. *Stormwater Quality Improvement Plan*, Draft Version.

County of Sacramento, 2000. *Stormwater Quality Improvement Plan for County of Sacramento and Cities of Citrus Heights, Elk Grove, Folsom, and Galt*. Draft.



# ECOROOFS (GREENROOFS) – A MORE SUSTAINABLE INFRASTRUCTURE

Tom Liptan<sup>1</sup> and Eric Strecker<sup>2</sup>

<sup>1</sup>City of Portland, Bureau of Environmental Services, 1120 SW 5th Ave., Portland, Oregon 97204 Ph.503 823 7267 [TomL@BES.ci.portland.or.us](mailto:TomL@BES.ci.portland.or.us)

<sup>2</sup>GeoSyntec Consultants, 838 SW First Avenue, Suite 430, Portland, Oregon 97204, Ph. 504-222-9518, [estrecker@geosyntec.com](mailto:estrecker@geosyntec.com)

## Abstract

All cities have two primary impervious elements; rooftops and pavement. These usually represent an extensive network of imperviousness and make up about 45% of the surface area of a city at full build out. The results of this imperviousness have been documented in a number of papers, but the main environmental effects include increased destabilization of streams and increased runoff pollutant loadings and concentrations. To address stormwater concerns and to provide other environmental benefits, the City of Portland has developed a program to encourage the use of EcoRoofs (vegetated roofs). This paper will present the overall City program, including a discussion of the incentives and assistance the City provides to encourage development projects to employ green roofs. The paper will review some of the installations that have occurred and discuss some of the practical lessons that have been learned regarding green roofs.

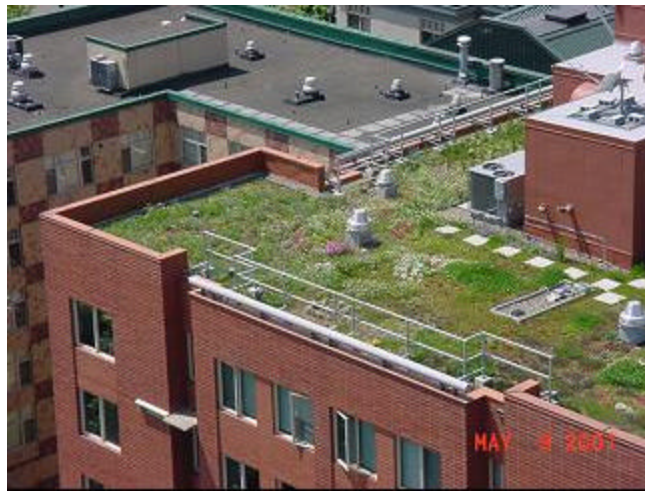
The City has also been monitoring runoff from several EcoRoofs in an attempt to ascertain the water quantity and quality performance of the roofs in slowing down or eliminating runoff, as well as associated pollutant loads and concentrations. The monitoring has included the installation of rooftop rain gages and flow measurement devices. Water quality samples are also collected. One roof has had two different depths of soil layers (2" and 4") employed with separate flow monitoring gages for each. The paper presents hydrological results for selected storm events on a seasonal basis, as well as initial water quality results.

## Introduction

The elements of urban development are similar throughout the United States. Homes, apartments, commercial and industrial sites and the supporting transportation systems cover the land in varying densities. Large areas of impervious surface in the form of rooftops and pavement have been placed on the land, wetlands, and even creeks. However, the ideal conditions for salmon, and other wildlife of the Pacific Northwest are predominately an evergreen (coniferous) forest and its associated functions with clean cool rivers and streams. The results of this imperviousness have been documented in a number of papers, but the main environmental effects include increased destabilization of streams and increased runoff pollutant loadings and concentrations (May et. al., 1997). Since these impervious urban elements are essential to human communities, what can be done to mitigate their negative impacts? In Portland, we are implementing new design techniques, which include EcoRoofs (living vegetated roof ecosystems), pervious pavements, landscape planters and swales, infiltration gardens, watergardens, vertical landscaping, and trees. The techniques are applicable to new and re-development, and to retrofitting existing development. The focus of this paper is on the 'EcoRoof' and its potential for reducing the impacts of urbanization.

## ***What is an EcoRoof?***

An EcoRoof is a living vegetated ecosystem of lightweight soil and self-sustaining vegetation. It is biologically ‘alive’ and as such provides a protective cover on the building by using the natural elements of sun, wind, and rain to sustain itself. This protective cover allows the waterproof membrane to last for as long as 30-40 years or more. The EcoRoof requires little maintenance and provides an aesthetic alternative, with economic and ecological attributes not found in a conventional roof. The main components include a waterproof membrane or material that prevents water from entering the building; drainage material such as geotextile webbing that allows water to flow to the drains when the substrate is saturated; and soil or substrate (growing medium) as light as 6 pounds per square foot (psf). To date in Portland, the lightest weight substrate used is at Hamilton Apartments at 10 psf saturated, at a 3-inch depth. Selection of vegetation or plant materials can range from mosses, lichens and ferns, to sedums and other succulents, to grasses, herbs and ground covers. Irrigation requirements are very much affected by the plants selection. Sedums and succulents appear to be the mainstay of least water dependent plants, based on experience in Portland. Figure 1 shows the Hamilton Apartments EcoRoof.



**Figure 1.** Aerial view of a vegetated EcoRoof on Hamilton Apartments in downtown Portland.

A traditional Roof Garden (see example in Figure 2, left photo) by comparison usually requires more substantial structural building upgrade and is made up of heavy soils and vegetation, often including trees, and requires significantly more irrigation and maintenance. Roof gardens may cover only a small percentage of the roof surface and usually have paved terraces for people to use. Although they do provide some benefits not found with the use of conventional roofs, they do not provide the benefits as an EcoRoof. They also are generally much more expensive to build and maintain than conventional roofs. EcoRoofs are more comparable in cost to standard roofs.

Another type of vegetated roof is an ag-roof (see example in Figure 2, right photo). Some building owners are finding it advantageous to grow crops on their rooftops. One such Portlander harvests hundreds of pounds of tomatoes each week.

The City of Portland decided to use the term ‘EcoRoof’ to describe their “green” roof program for several reasons. First, the western United States including most of Oregon and Washington has dry warmer seasons and may not receive precipitation for many months. Native plants although more self-sustaining often do

not remain “green.” Thus a “not green” or brown roof does not imply that the vegetation has died, thus the prefix eco (for ecosystem) was chosen as being more descriptive of what the roofs are intended to achieve. . Another reason was the many references to the economic value, especially the longer life, thus eco also refers to the economic benefits.



**Figure 2.** An aerial view of a typical Roof Garden in downtown Portland and Doug Christie and Cameron Hyde atop Doug’s ag-roof in Portland with crops shown.

### ***What Do EcoRoofs Do?***

Based upon an evaluation of hydrological, energy, and other principals and monitoring data produced thus far in Portland, EcoRoofs appear to be able to address many environmental and economic issues. The City’s original interest was stormwater management, but has since broadened to consideration of other EcoRoof attributes. Precipitation that lands on an EcoRoof acts in the following ways. Portions of it are intercepted by vegetation and then evaporate; portions are absorbed in the soil; portions in the soil are taken into the vegetation and then transpire; some water evaporates from the soil; and excess amounts flow through the soil and become runoff. These characteristics are highly affected by seasonal conditions. Interception, evaporation, and transpiration act to prevent runoff and can be lumped into one term, rainfall retention. This portion of the rain never turns into runoff. One of the primary objectives of the monitoring program has been to assess the effectiveness of EcoRoofs in reducing the volume of runoff. Some water quality monitoring has also been performed to assess the potential for reduced as well as added pollutants in the runoff that does occur. Finally, the hydrology and water quality results have been employed to assess potential reductions in pollutant loads. Table 1 provides a comparison of EcoRoofs environmental and other characteristics to conventional roofs. Note that the conventional roof is often the cause of the problem being addressed.

### ***The Portland EcoRoof Experience***

Portland has a total area of 135 square miles. Although rooftops constitute only one type of surfacing, they represent about 40% of all impervious surfaces in the city. At full build-out based on current zoning, rooftops are likely to cover more than 25 square miles of the city. However, if zoning densities increase over the coming decades the city roof area could be much larger.

**Table 1.** A Comparison of Environmental and Other Characteristics of EcoRoofs and Conventional roofs.

Subject	EcoRoof	Conventional Roof
<b>Stormwater</b>		
<b>Volume retention</b>	10-35% during wet season, 65-100% during dry season	None
<b>Peak flow mitigation</b>	All storms reduced runoff peaks	None
<b>Temperature mitigation</b>	All storms	None
<b>Improved water quality</b>	Retains atmospheric deposition and retards roof material degradation, reduced volumes reduce pollutant loadings	No
<b>Air quality</b>	Filters air, prevents temperature increases, stores carbon	None
<b>Energy Conservation</b>	Insulates buildings, reduces Urban Heat Island impacts	None
<b>Vegetation</b>	Allows seasonal evapotranspiration; provides photosynthesis, oxygen, carbon water balance	None
<b>Green Space</b>	Replaces green space lost to building footprint:, although not equal to a forest	None
<b>Zoning floor area bonus</b>	3 ft <sup>2</sup> added floor area ratio (FAR) for each EcoRoof ft <sup>2</sup> when building cover over 60%	None
<b>City Drainage fee reduction</b>	To be determined, may be up to 45%	None
<b>Approved as stormwater management</b>	For all current city requirements	No
<b>Habitat</b>	For insects and birds	None
<b>Livability</b>	Buffers noise, eliminates glare, alternative aesthetic, offers passive recreation	None
<b>Costs</b>	Highly variable from \$5-\$12 ft <sup>2</sup> new construction and \$7 - \$20 ft <sup>2</sup> retrofits	Highly variable from \$2-\$10 ft <sup>2</sup> new construction and \$4 -\$15 ft <sup>2</sup> retrofits
<b>Cost off-sets</b>	Reduced stormwater facilities, energy savings, higher rental value, increase property values, reduced need for insulation materials, reduces waste to landfill, creates jobs and industry	None
<b>Durability</b>	Waterproof membrane protected from solar and temperature exposure lasts more than 36 years, membrane protected from O&M staff damage	Little protection, exposure to elements, lasts less than 20 years

In 1991 the city of Portland was required by US Environmental Protection Agency and the Oregon Department of Environmental Quality to begin more aggressive programs to reduce pollutants in

stormwater discharges and abate combined sewer overflows. Both of these problems have as their common cause urbanization. The traditional solutions that Portland began to implement, included the use of end-of-pipe treatment such as ponds to treat stormwater flows and large pipes and underground storage systems to address combined sewerage overflows. The City did embark on a program to “Start at the Source” using such techniques as roof drain disconnect programs in combined areas of the City. Portland first began to consider EcoRoofs in 1995 . The technique seemed to fit the concept of creating something that would be more like nature, absorbing and then slowly releasing moisture through evapotranspiration and low flows, thus providing precipitation retention and stormwater management. The City began to ask if this could be a way to reduce or control CSOs and reduce the erosive scouring forces of runoff in streams. Many people in the city were intrigued with the possibilities and investigative efforts began in earnest.

### ***Milestones in Portland’s EcoRoof Program***

The following presents a brief summary of the milestones in the development and implementation of the City’s EcoRoof program:

- 1996 -- First EcoRoof installed on a residential garage, stormwater monitoring was conducted for 27 months from 1997 -1999
- 1997 – Bureau of Environmental Services (BES) and Portland General Electric (PGE) assisted Portland State University planning students with a study on roof gardens. A report was produced.
- 1997 - BES built a small EcoRoof shelter at the Portland Home and Garden Show. Survey of over 600 visitors was 75% favorable.
- 1998 -- BES and PGE provide grant funding of a 300 ft<sup>2</sup> EcoRoof installation on an apartment building. This would be the first use of BES Community Watershed Stewardship Program grants for an EcoRoof.
- 1998 -- BES begins to offer limited technical assistance to developers who consider EcoRoofs.
- 1999 -- A city worker is interviewed on the NRP ‘Living on Earth’ show and receives encouraging phone calls from around the country.
- 1999 -- Almost simultaneously two projects, with different owners, request BES assistance to install EcoRoofs.
- July, 1999 -- The EcoRoof is officially recognized as a stormwater management technique and is included in the city’s Stormwater Management Manual.
- September, 1999 -- Hamilton Apartments EcoRoofs are completed.
- March 2000 -- Buckman Terrace mixed-use building EcoRoofs are completed.
- Early 2001 -- BES began measuring precipitation and runoff at the Hamilton. However the efforts were plagued with technical problems. In December, 2001, problems are corrected. Subsequent flow data not only supports the monitoring results of the garage data, but also shows better performance.

- 2001 -- BES begins work on a drainage fee discount for installation of EcoRoofs or other green approaches. (This work has been delayed and the discount is not expected to be available till 2004).
- 2001 -- Two small EcoRoof shelters are completed at nature areas.
- March, 2001 -- The city zoning code is amended to include EcoRoofs as a floor area bonus option. Property owners can add up to 3 ft<sup>2</sup> of floor area for every ft<sup>2</sup> of EcoRoof if the EcoRoof covers at least 60% of the rooftop. Less area is granted if the % coverage is less than 60%.
- 2001 -- BES offers potentially \$30,000 grants for EcoRoofs (or other green techniques) in a portion of the combined sewer area. Two roof retrofits were considered and one is approved for funding.
- 2001 -- Mosaic Condominiums apply for EcoRoof bonus and get enough ft<sup>2</sup> to add six additional condominiums to the building.
- September, 2001 -- Ecotrust building EcoRoof completed.
- October, 2001-- BES and the City's Office of Sustainable Development convene a City EcoRoof Forum. An overwhelming majority of attendees supported the EcoRoofs concept. Three major issues are identified: need more cost-comparative information, need incentives at the early stages, and need technical assistance.
- December, 2001 -- BES installs an EcoRoof on a portion of the it's wastewater treatment plant.
- 2002 -- BES completes an EcoRoof Question and Answer brochure and posts it on its web site.
- July 2002 -- Fire Station #12 EcoRoof is constructed.
- 2002 -- Mosaic condos begin construction.

## **Portland EcoRoof Monitoring**

The City of Portland has been active in implementing monitoring programs to assess the effectiveness of the EcoRoof in reducing impacts to downstream receiving waters as well as reducing CSO impacts. This section presents a brief overview of the two monitoring projects that the City has been conducting.

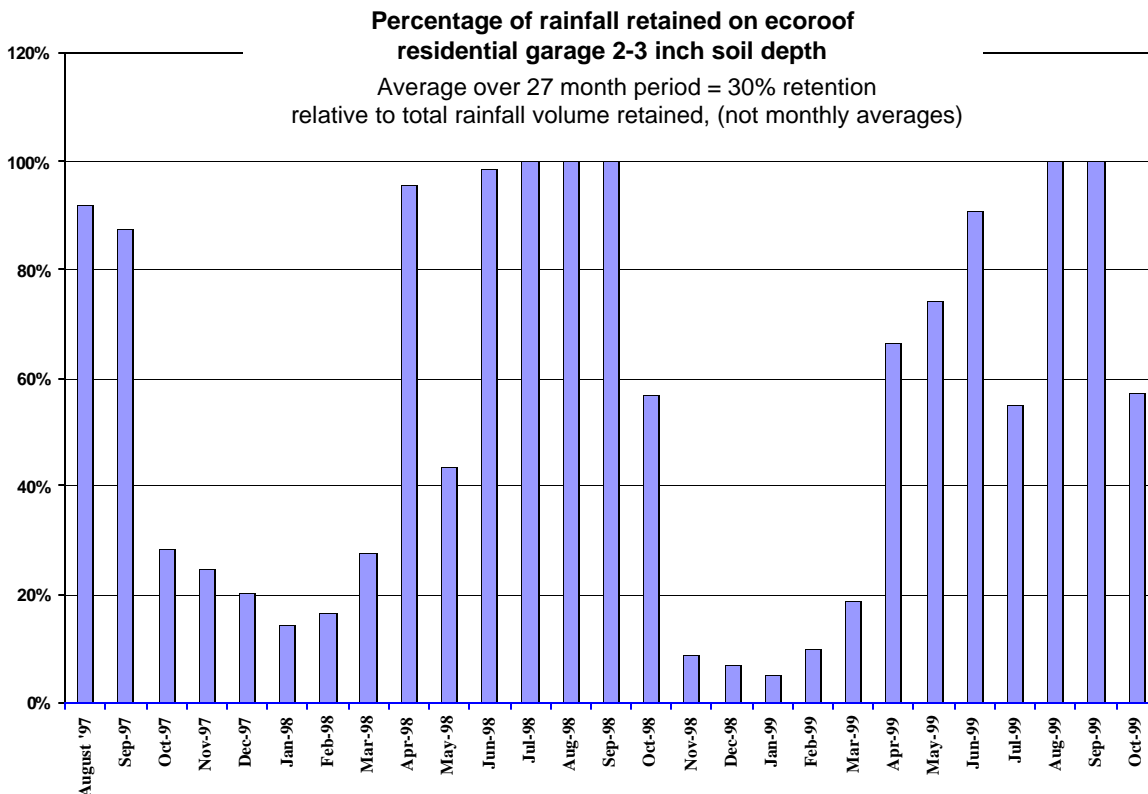
### ***Residential Garage EcoRoof Monitoring***

An EcoRoof was installed on a structure shown (Figure 3) in October 1996 . The building structure was upgraded and a waterproof membrane was applied over the existing composite rollout shingles. Two to three inches of topsoil and compost mix were applied and planted with seven species of sedum. Grass has also grown on its own with what appears to be four predominate species. The EcoRoof is 180 ft<sup>2</sup> and has about a 7% slope toward the east. About half of the roof has full solar exposure and the other half is partially shaded. Figure 3 shows the EcoRoof in late spring 2002.

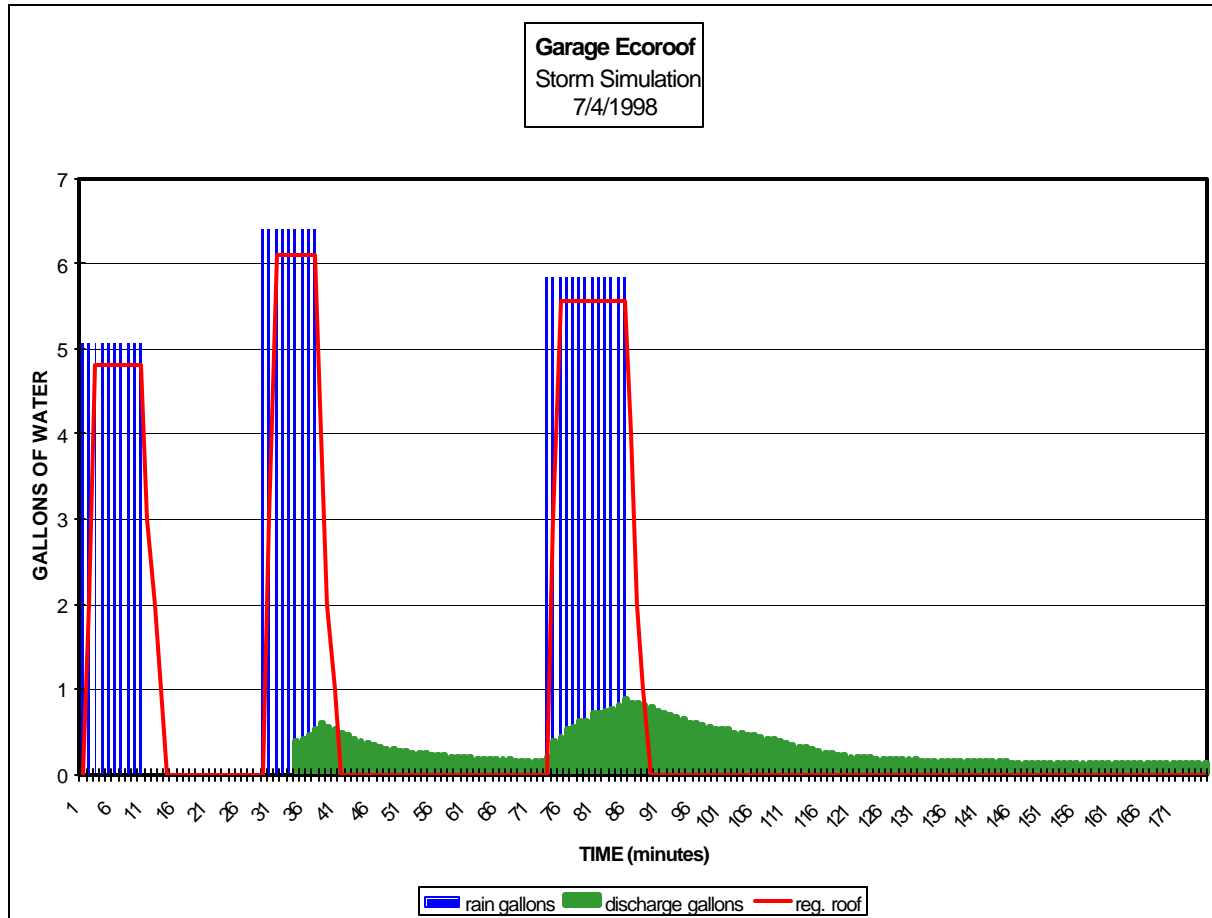


**Figure 3.** View of a residential garage EcoRoof that was monitored for a two-year period.

BES monitored rainfall retention of the garage EcoRoof from August of 1997 until October of 1999. A rain gage was installed on the EcoRoof and the roof downspout was connected to two tanks with a total capacity of 78 gallons. A spreadsheet was created to record the rainfall, runoff and retention. The rain gage and tanks were checked every morning and evening during storm events. Any flow in the tanks represented runoff and the difference between rainfall and runoff was the retention. Figure 4 shows the precipitation retention for the 27-month period. Figure 5 show the results of a rainfall simulation test to identify how peak flows might be attenuated. In the test, a large volume of water was applied to the roof and then the recorded runoff was compared to this volume. Water was applied with a garden hose and before each application the flow from the hose was measured and recorded.



**Figure 4.** Chart showing the month-by-month percentage of rainfall retained on a residential garage roof in Portland.



**Figure 5.** Chart showing gallons of water introduced to a residential EcoRoof and the much lower number of gallons that ran off, as well as much lower peak flows.

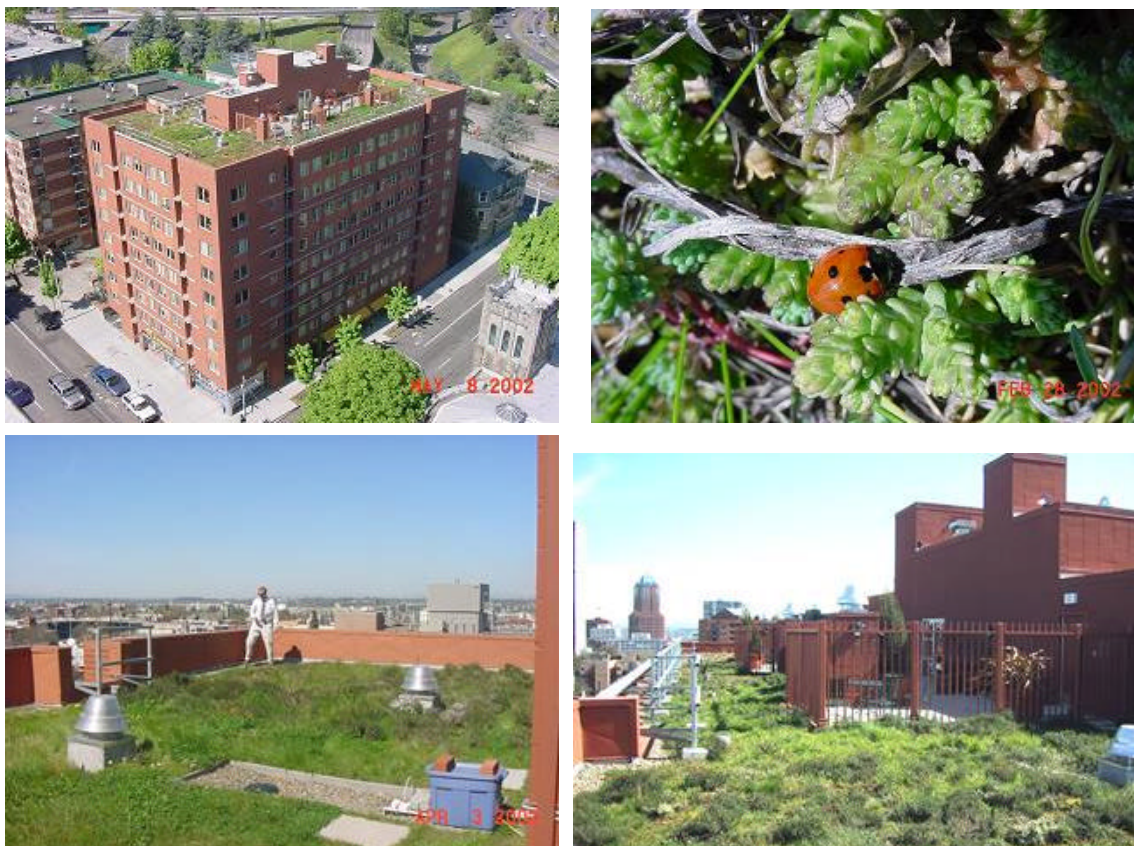
The percentage of retention on this roof on a monthly basis during the study period, has ranged from <10% in Jan 1999, with 11 in. of rainfall and up to 100% in the dry season months. For the rainfall volume for the two-year period, the average annual retention was about 28%. Rainfall during this two-year period was 99 in. or 33% more than the average two-year total of 74 in. Higher than average rainfall and the fact that the EcoRoof is partially shaded in spring, fall and winter would have reduced evaporation and thus reduce the retention performance. The simulated storm demonstrated how the EcoRoof could attenuate a large storm under dry season conditions. The most sensitive stream conditions often occur when a larger warm weather storm occurs.

### ***Hamilton Apartments EcoRoofs Monitoring***

The Hamilton Apartment Building (Figure 1) in downtown Portland is the site of a more comprehensive monitoring effort by the City. The Housing Authority of Portland, in cooperation with the City of Portland's Bureau of Environmental Services (BES), built the Hamilton Apartments Building EcoRoofs in the autumn of 1999. Over 75 species of plants were installed in an identical arrangement on each side of the building. Three different mechanisms were used to plant the vegetation, plugs, hydroseed, and mats. The idea was to gain some understanding of which plants would do the best and what type of planting would provide the best growth and coverage. An irrigation system was installed. BES is testing to determine



characteristics of planting methods, measurement of runoff flows and precipitation, and viability of soil and vegetation. Insects and birds are also being monitored to a very limited extent. Garland Co. waterproof membrane and planting design was used on this project. Figure 6 shows various views of the EcoRoofs.



**Figure 6.** Photographs of the Hamilton EcoRoof, including an aerial photo from above, a close-up of vegetation and a ladybug, and two pictures of the roof from the roof; one showing the area of the roof where access is restricted and the other including the patio area behind a fence.

There are two drains on the building: an east drain has a 3,848 ft<sup>2</sup> catchment with 2,620 ft<sup>2</sup> of EcoRoof area and the west drain has a 3,690 ft<sup>2</sup> catchment with 2,520 ft<sup>2</sup> of EcoRoof area. All other surfaces are vents, parapet walls, gravel, and terrace paved areas. All monitoring is relative to these other surface contributions and implies that a 100% EcoRoof would have improved precipitation management. The conventional roof runoff has been disconnected from the EcoRoofs, but the terrace areas drain to each of the EcoRoof drains through the substrate. In both cases, the catchments are about 75% EcoRoof and 25 % hard surfaces.

The drainage from the EcoRoof was split in half for research purposes. The west half has a four to five inch soil which weighs 20-25 lbs/ft<sup>2</sup> and the east half has a two-three inch soil weighing 7-10 lbs/ft<sup>2</sup> when saturated. The east soil is composed of digested fiber, encapsulated styrofoam, perlite, peat moss and compost. The west soil consists of digested fiber, compost, perlite and topsoil. Figure 7 shows the chemical composition of the two substrates utilized. In general, the Westside soil mixture appears to have higher concentrations of heavy metals and nutrients. As rain falls and soaks into the soil it flows to the roof drains located at each end of the building where a monitoring station collects flow data prior to entering the piped system. There is an additional roof drain with a two-inch collar in case the monitoring equipment or the main roof drain was to become plugged.

**Figure 7 Hamilton EcoRoof Substrate (soil) Composition**

Parameter	Extractant	Method Number	Unit	Eastside	Westside	Ratio
Total As		EPA 200.9	mg/kg	4.54	2.19	0.5
Total Cu		EPA 200.7	mg/kg	17.5	30.3	1.7
Total Pb		EPA 200.9	mg/kg	5.57	64.9	11.7
Total Zn		EPA 200.7	mg/kg	48.2	146.1	3.0
Extractable As	DTPA	EPA 200.9	mg/kg	0.01	0.09	9.0
Extractable Cu	DTPA	EPA 200.7	mg/kg	1.25	6.08	4.9
Extractable Pb	DTPA	EPA 200.9	mg/kg	0.26	2.43	9.3
Extractable Zn	DTPA	EPA 200.7	mg/kg	4.9	64.8	13.2
Extractable NO <sub>3</sub> -N	1 N KCl	SM 4500-NO <sub>3</sub> F	mg/kg	253.6	798.3	3.1
Extractable NH <sub>4</sub> -N	1 N KCl	SM 4500-NH <sub>4</sub>	mg/kg	2.7	28.6	10.6
TKN		EPA 351.4	mg/kg	1897	12802	6.7
Total Phosphorus		EPA 200.7	mg/kg	958	2508	2.6
Extractable PO <sub>4</sub> -P	0.5 N NaHCO <sub>3</sub>	SM 4500 P E	mg/kg	100	325	3.3

## Equipment

Flow monitoring equipment includes a small 60-degree, V-trapezoidal Plasti-Fab flume, and a hydraulic bubbler-type flow meter, which measures the water level in the flume as shown in Figure 8 . The flumes were custom made to attach to the two main drainage points. This data is instantaneously transmitted to the BES Lab where it is converted and stored on the BES computer network.

BES has been testing another type of flow monitoring equipment. It is a small mobile Sigma flow meter, Model 950, configured with a bubbler-type level sensor. It appears very small flow levels can be captured with this type of meter. Data is stored in a mobile data logger. Figure 8 shows a BES staff installing the added equipment. Figure 8 also shows the flume with the bubbler tubes, one connected to the data logger and the other connected to a transducer that telemetrically sends flow and rainfall data directly to the lab.

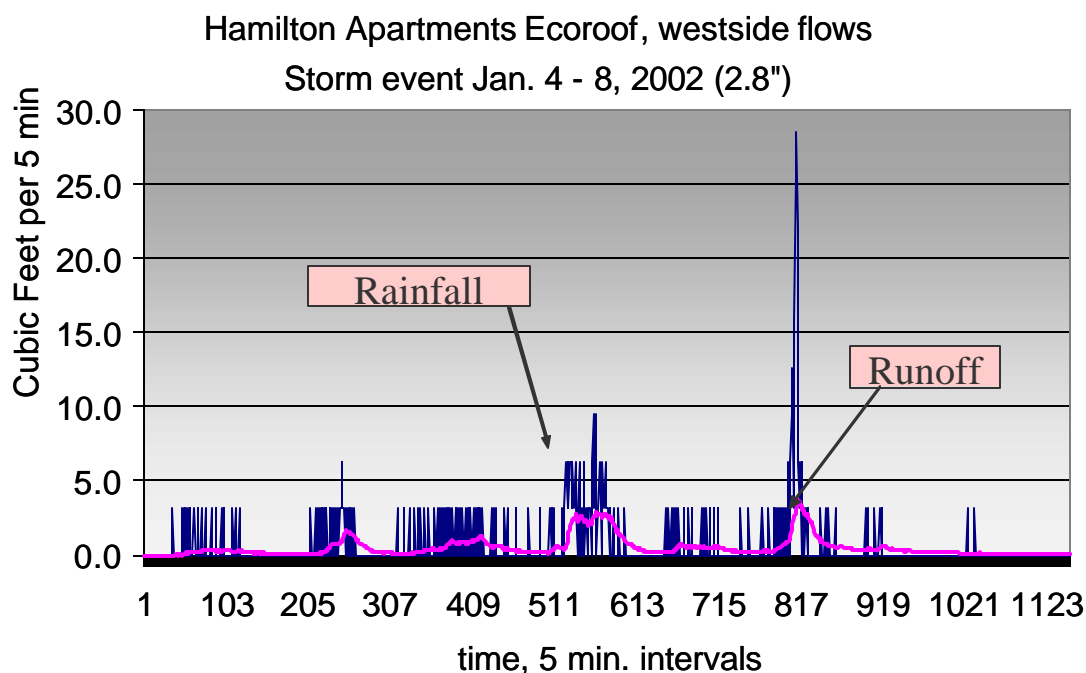
A rain gauge was installed on the building to ensure that accurate rain data is collected for the site. This data is collected and stored, then accessed via computer on the city network.



**Figure 8 .** Two photographs of one of the monitoring stations. One shows the data logger and bubbler with the flume and the second is a close-up of the flume.

## Flow Monitoring

Initially BES had a lot of problems with the flow meters, but has since corrected these problems and added the two new meters. Currently each drain has two meters and both are showing comparable results. All data collected since December, 2001 is considered good. The graphs represent 75 % EcoRoof and 25 % impervious. Figure 9 shows the runoff associated with the long duration winter storm event and the slow release water that cannot be retained in the saturated substrate. Note the mitigation of the peak intensities of the event. Figure 10 shows the almost complete retention of a typical Portland summer storm. The estimated runoff from a conventional roof surface would be very similar to the rainfall lines as the rainfall would almost immediately turn to runoff as the rain occurs. An almost ¾ in. storm was mostly retained on a roof with 4 in. of soil.



**Figure 9.** A chart of measured Hamilton Apartment EcoRoof Westside (2 in. soils) rainfall versus runoff, in units of cubic feet per 5 minutes versus 5-minute time increments showing the reduction in runoff volumes and peaks for a winter storm.

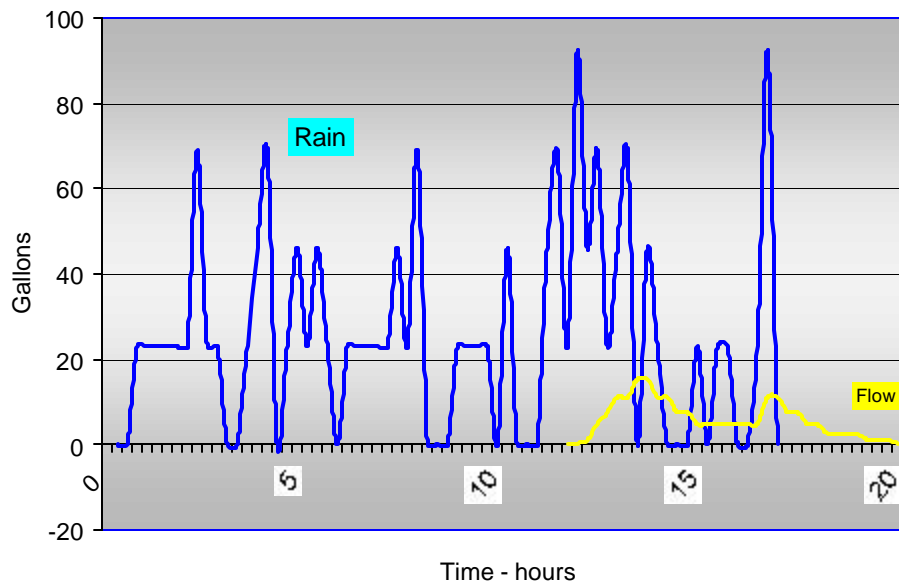
## Water Quality Monitoring

To date, five storms have been monitored for water quality. The results are encouraging, but also show how attention to substrate chemical composition may be needed (see Figure 7) depending on the receiving water system.

### *Sampling Procedures*

BES Field Operations staff performed sample collection and field parameter readings. The BES Laboratory section performed the analytical testing. The minimum storm criteria for water quality analysis for this project was 0.25 inches of rain in 24 hours to ensure runoff volumes are sufficient. Grab samples were collected at the middle to latter part of the storms. The water quality grab samples were collected at the termination of the flumes using a decontaminated stainless steel bailer or the sample container directly.

## Hamilton Ecoroof westside rainfall and runoff June 28-29, 2002 storm event 0.73“



**Figure 10 .** Measured Hamilton Apartment EcoRoof Westside (4 in. soils) rainfall versus runoff in units of gallons-per-hour versus time in hourly increments, showing the significant reduction in runoff volumes and peaks for a summer storm.

### Analytical Parameters

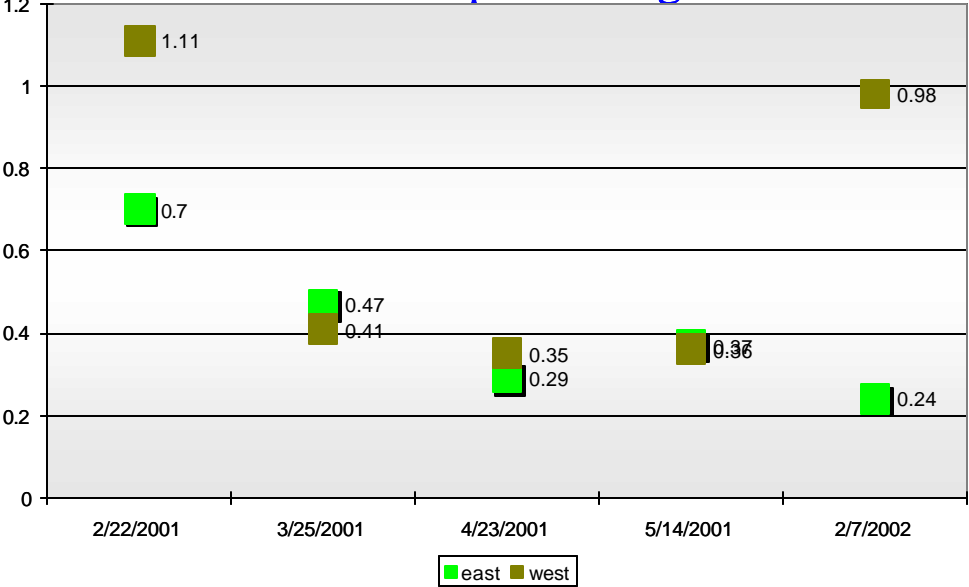
Samples were analyzed in the field for dissolved oxygen, pH, specific conductance, and temperature using portable field meters. Samples were submitted to the laboratory for analysis of ammonia-nitrogen, biochemical oxygen demand, chemical oxygen demand, color, total and dissolved metals (arsenic, cadmium, copper, lead, silver, and zinc), *Escherichia coli*, orthophosphate-phosphorus, total phosphorus, and total suspended and dissolved solids.

Figures 11 and 12 show constituents such as Total Phosphorous and Ortho-phosphorous at concentrations above receiving water standards. Note the difference between Eastside and Westside flow concentrations and the substrate chemical composition shown in Figure 7. It appeared that over time phosphorus levels might be coming down, but there was a spike in one of the samples in the last storm. We believe that the phosphorus issue can be corrected by being careful to specify a substrate, which would not allow excessive amounts of TP to release from the soil or in fact one that might tend to retain phosphorus. Another issue is the contribution of certain constituents from the terrace area. Numerous activities occur with lots of food, drinks, fireworks, dogs and many other pollutant sources. Obviously these sources may affect some of the characteristics of the water quality due to human and other impacts. One important lesson to date is that these sources should be addressed in monitoring studies, either by conducting studies where they do not exist or by education efforts. This is the only EcoRoof the City is monitoring for water quality at this time; others will be monitored in the future.

Another important characteristic is the EcoRoof affect on loadings. As shown above, many storm events, especially the warm season storms, significantly reduce flow volumes, thus reducing loadings. And in many cases the flow is zero with zero concentrations, particularly during the drier times of year.

Figure 13 shows dissolved copper concentrations which, based on water hardness, are usually below in-stream standards. Again attention to substrate ingredients and materials to be used on the roof can affect these parameters. For example, the roofing industry uses lots of galvanized metals, copper and lead. It is unknown whether the wood was treated with copper, a potential source for copper on the Hamilton building was treated lumber the landscape contractor used for edging material. However, as pointed out above, the copper loadings would be much reduced as compared to a traditional roof. One option that should be evaluated in reducing pollution from all roofs is the types of roofing materials that are allowed. Several projects in Southern California (Crystal Cove, Newport Beach for example) have restrictions on copper and zinc containing materials being used for roofs, gutters, and downspouts.

## Hamilton Ecoroofs Total Phosphorus mg/L

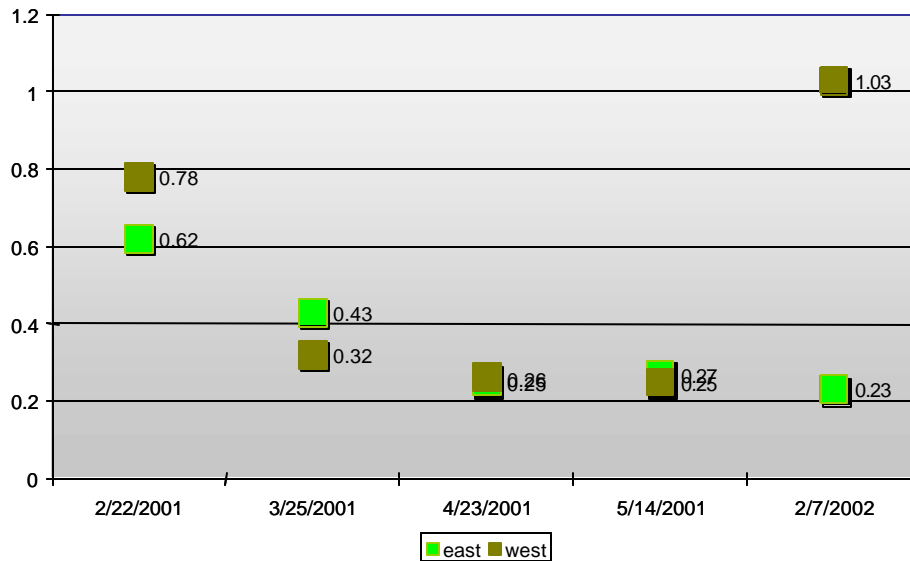


**Figure 11.** A chart of showing the total phosphorus concentrations measured in roof runoff from both the east and west roof areas. There is a decreasing trend in phosphorus concentrations with the exception of the west roof's last sample.

### What else have we learned?

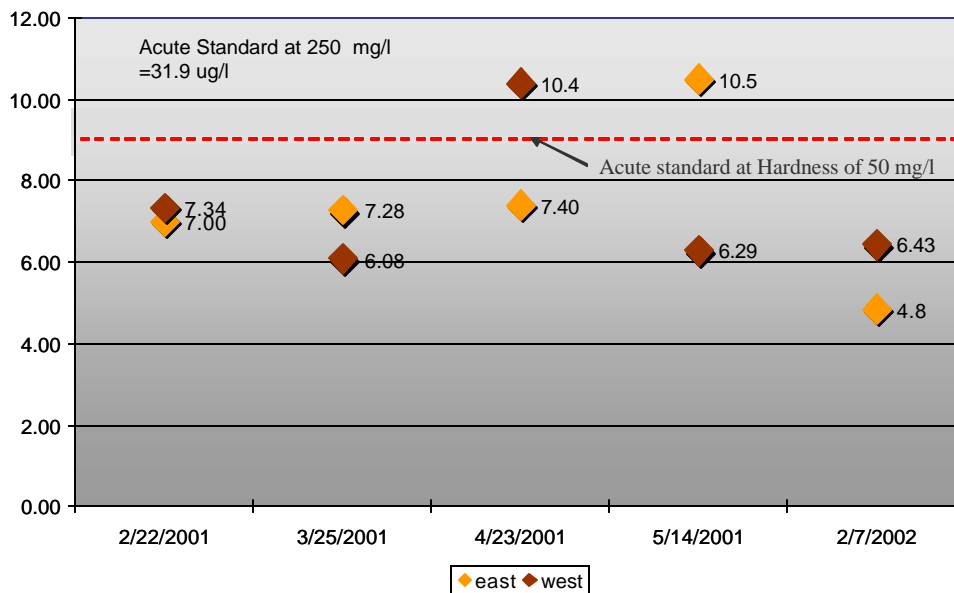
Almost an inch of soil was lost to wind erosion, especially on the east side. The initial planting did not provide good vegetative cover in all areas, which could have protected against this erosion. Depending on the initial planting scheme, cover crops such as common clover may provide excellent soil coverage. Water from air conditioning condensate is a possible source of free, non-potable water for irrigation. Condensate flows were significant during the hottest part of the summer, with flows measured at 12 oz.-per minute in the afternoon and 6 oz.-per minute in the late evening. This might prove to be a free source of irrigation water, if considered during the design phase. Mosses have populated certain areas of exposed soil and helped reduce wind and soil erosion. Lightweight soils must be fully covered to prevent erosion. The eastside is now only about 2 in. thick and the west side is about 4 in. thick. A small colony of ladybugs has been observed in the south half of the eastside and numerous other insects. Hummingbirds, blue jays, crows, swallows, pigeons, sparrows, and signs of hawks or owls have been observed.

## Hamilton Ecoroofs orthophosphate phosphorus mg/L



**Figure 12.** A chart of showing the orthophosphate concentrations measured in roof runoff from both the east and west roof areas. There is a decreasing trend in phosphorus concentrations with the exception of the west roof's last sample.

## Hamilton Ecoroofs Dissolved Copper ug/L



**Figure 13.** A chart of showing the dissolved copper concentrations measured in roof runoff from both the east and west roof areas. Most samples (8 of 10) were below acute water quality criteria at a hardness of 50 mg/l.

## ***Soil and Vegetation Monitoring***

As a part of our monitoring the city is photo documenting the EcoRoof vegetation on a regular basis in addition to documenting changes and problems with the soil. The vegetation has gone through seasonal changes yet has continued to grow and cover the soil. Some problems have included volunteer grasses, plants and clover. The volunteer plants alone are not a large problem since in most cases they will not live through the summer without irrigation.

## **Air Temperature**

In addition to stormwater monitoring discussed above, some energy-related measurements have been conducted. For example, the City has been comparing inside and outside temperatures of the garage EcoRoof and found that EcoRoofs appear to provide cooling benefits. There is no insulation on the garage except for the EcoRoof.

## **Demonstrations and Incentives**

The BES has provided incremental funding for three projects to date, but not the residential garage. Funds are obtained from BES sewer and stormwater revenues. The rationale for public funds being used is that these projects will help the City determine the stormwater and CSO management values of EcoRoofs. In addition, the City now allows builders to exceed building height restrictions with the implementation of a EcoRoof. In addition, there is a stewardship grant program which, to date, has provided funding for four projects. In the future, credits on stormwater utility fees will also likely be put in place. Finally, the EcoRoof can be used to meet or partially meet stormwater treatment requirements.

## **Other Lessons – Buckman Terrace**

Buckman Terrace is a redevelopment project by Prendergast Associates. The project was designed in 1998 and opened in 2000. This is a 0.8-acre site with 150 apartment units, with all below-building parking and a 1,500 ft<sup>2</sup> commercial section in a 4-story structure. The building also has car sharing and numerous other environmental attributes.

The entire building has a roof area of approximately 25,000 ft<sup>2</sup> and is constructed with sufficient structural capacity to hold an EcoRoof. As a test, EcoRoofs were placed on two sections. Figure 14 shows the main EcoRoof, which comprises over 1,500 ft<sup>2</sup> of commercial space that has full solar exposure. An additional 750 ft<sup>2</sup> of impervious roof area drains onto this south facing EcoRoof. Figure 15 shows the entrance EcoRoof, which is also planted with sword fern, licorice fern and white stonecrop. It is on the eastside and is in the shade of a north-facing wall. Both were planted in March 2000. The main EcoRoof was planted with two species of Oregon sedum, various wildflowers, native grasses and a few licorice ferns. Grasses and wildflowers were planted from seed and mulch was hand broadcast to protect against wind erosion. An irrigation system has not been installed for either EcoRoof. The soil profile is 4 in. deep and 20 lbs ft<sup>2</sup> when saturated. American Hydrotech waterproof membrane and reservoir drain system was used. BES staff specified the soil mix and vegetation.

While the grasses and wildflowers achieved a graceful, flowing appearance, they are reminiscent of an Eastern Oregon or Midwestern American prairie. Since residents who would rather have a “greener look,”

for the EcoRoof, the roof is going to be replanted. The Fire Department was also concerned about the dry grasses, which is an important issue for EcoRoofs without irrigation systems.

During the warm season, storm event runoff was visually observed to be very low or non-existent. The EcoRoof has capacity to hold much of the additional flow from the other roofs. During winter storms, runoff occurs often, but it is detained and released slowly. Many of the plants survived or re-seeded themselves with only one hand-watering. Although no maintenance was conducted this last year, it appears the grasses will need to be mowed at least once a year.



**Figure 14.** Two photographs of the Buckman Terrace EcoRoof showing uses of grasses and wildflowers.



**Figure 15.** Buckman Terrace EcoRoof at the building entry with protection from north facing wall



## **Summary**

In initial sampling, EcoRoofs have been shown to significantly reduce runoff volumes, especially in spring, summer, and fall. They also help to slow runoff during winter periods.

In addition it appears that water quality could be significantly improved via loadings (volume) reduction as well as pollutant removal/avoidance. Additional monitoring data on EcoRoof water quality will be conducted by the city to assess the benefits of concentration reductions, and the loading reductions from reducing runoff amounts. There is a need to be strategic about the selection of soils/growing media to use on EcoRoofs as some soils may contain higher levels of pollutants. In addition other roof materials, such as treated woods need to be avoided.

Developers in Portland are gaining confidence in the value of EcoRoofs, as more and more builders gain experience with EcoRoof design and construction. The City allows developers to meet or partially meet their stormwater treatment requirements with an EcoRoof. In dense urban situations, this has become more and more attractive to developers. In addition the City allows taller buildings as an incentive. In the future, there will be a potential reduction in stormwater fees via a reduced fee for those sites with EcoRoofs. One of the primary reasons that developers are embracing the program is the City's technical and permitting assistance provided by the Bureau of Environmental Services.

As with any stormwater management measure, good design and maintenance are keys to their success. It is expected that, due to virtual elimination of sun energy on roof surfaces and resulting degradation of roof materials, that EcoRoofs will be likely found to last much longer than many traditional roof materials. As with any roof, good construction techniques are important. The City is undertaking economic analyses of life cycle costs and benefits of EcoRoofs to be able to further demonstrate their value and effectiveness to developers and the community at large.

## **Reference**

May, C.R., R. Horner, J. Karr, B. Mar, and E. Welsh. 1997. Effects of Urbanization on Small Streams In the Puget Sound Lowland Ecoregion. In: Watershed Protection Techniques, 2(4): 483-494.

# **Storm Water Management in the City of Chicago**

Suzanne Malec

City of Chicago Department of Environment

Chicago, Illinois

## **Abstract**

The City of Chicago owes its very existence to its location at the confluence of the Chicago River and Lake Michigan. Lake Michigan provides the City with an abundant water supply while the Chicago River serves as a highway to move goods and services critical to the City's growth. Chicago has built a historic legacy in protecting these valuable water resources. To protect its water supply, engineers in the 1900s constructed the Chicago Sanitary and Ship Canal to reverse the Chicago River's natural flow from eastward to westward, steering human and industrial waste away from Lake Michigan. In 1972, Chicago pioneered the use of deep tunnels to capture, convey, and store combined sewage during storms for later treatment.

Today, Chicago is taking a new comprehensive approach toward further improving the quality of its surface waters. Rather than through large scale engineering projects, the approach centers on simple storm water Best Management Practices (BMPs) at the source level to reduce the negative impacts of storm water runoff. Through various model projects, the City aims to demonstrate the efficacy of various BMP approaches, promote public acceptance and usage, and encourage modification of local ordinances to allow wide-spread usage of BMPs.

## **History of Storm Water Management**

In 1885 a severe rainstorm caused sewage-contaminated river water to flow into Lake Michigan, contaminating the City's drinking water. This disaster led to a cholera and typhoid outbreak that killed over 90,000 people. Repeated outbreaks of epidemic diseases compelled the City to find a way to stop the flow of polluted water into Lake Michigan. The Metropolitan Sanitary District of Greater Chicago was created in 1889 to safeguard the city's drinking water and determine an acceptable way to dispose of waste.

In 1900, the sewer overflow problem was solved by a massive engineering effort. Engineers constructed the Chicago Sanitary and Ship Canal to reverse the Chicago River's natural flow from eastward to westward, thereby steering human and industrial waste away from Lake Michigan. Now the river flows into the DesPlaines River, the Mississippi River and, eventually, the Gulf of Mexico. Locks regulate the elevation of the river and prevent Lake Michigan from draining freely (City of Chicago, 2000).

While this solution protected the Lake, it did not reduce the pollution level in the Chicago River. Rainfalls of as little as 1/3 inch overloaded local sewer systems and caused combined sewer overflows (CSOs) - a mixture of storm water runoff and raw sewage, into the waterway. Hundreds of CSOs are located along the waterway. CSOs still polluted the waterways and, with the heaviest rainstorms, raised flood stages to levels resulting in river backflows into Lake Michigan, causing beach closures. Major underlying causes of the problem were lack of an adequate floodwater outlet and increasing urban growth.

In 1972, the Metropolitan Water Reclamation District of Greater Chicago (formerly Metropolitan Sanitary

District of Greater Chicago) started construction of a large scale, multi-purpose Tunnel and Reservoir Program (TARP), comprised of deep rock tunnels and surface reservoirs that capture, convey, and store combined sewage during storms until it can be transferred to existing treatment plants when capacity becomes available.

In 1974, prior to TARP, only 10 fish species were found in the Calumet and Chicago River systems. With improvements in wastewater treatment technology, the species count rose to 33 by the early 1980s. In 1984, the first TARP tunnel projects came online, reducing the frequency and volume of combined sewer overflows. Subsequently, the species count rose gradually to 54 by 1990, and had reached 63 by 2000. This steady climb over the years is due in part to additional segments of the TARP tunnels coming online, further improvements in treatment plant performance, and supplemental aeration of the waterways (EPA Region V, 2002).

Today, increased residential and commercial development is occurring along the banks of Chicago waterways. The waterways are no longer considered just navigational canals, but are seen to be amenities or center pieces of urban life. The public's interest in the river has grown, as evidenced by the increasing numbers of paddlers, walkers, bikers, and even jet skiers on the river. Fishing on the river has also grown in popularity. Fish consumption advisories still remain in place, however, and large portions of the rivers are not safe for full body contact. Additional work remains to be done.

## **Current Storm Water Management Approach**

The City is taking a new comprehensive approach toward further improving the quality of its surface waters. Rather than through large scale engineering projects, the approach centers on implementing and promoting demonstration projects that utilize simple storm water Best Management Practices (BMPs) at the source level. The goals of these BMPs are to reduce the quantity and improve the quality of urban storm water runoff.

### **Common Storm Water BMP Techniques**

Storm water pollutants includes such substances as solids, metals, oil and greases, and road salt. BMPs commonly employed in Chicago's model projects to treat storm water runoff include vegetated swales, infiltration trenches or basins, detention basins, mechanical filtration/sediment and oil grease traps, roof top gardens, and cisterns that capture runoff for gray water use. A brief description of some of these BMPs are described below.

Vegetated Swales - In vegetated swale designs, storm water is conveyed through a vegetated swale instead of a storm sewer. Swales increase storm water infiltration potential and storage. Swales also remove pollutants via settling, vegetative filtering, and to some extent infiltration through the soil. Sediments need to be periodically removed from vegetated swales, and the vegetation mowed and replanted as needed (NIPC 1995).

Infiltration Trench or Basin - In an infiltration trench or basin, storm water runs through a swale or into a basin that has a porous bottom (sand or gravel), causing storm water to infiltrate into the ground. As the storm water percolates through the ground, contaminated particles are trapped within the soil and the

resulting treated water migrates to the groundwater. Water quality benefits are derived from the removal of contaminants that are sorbed onto soil particles and decreased flows into the river. Sediment will tend to clog systems unless the systems are routinely maintained. The condition of the trench should be periodically checked and the accumulated sediment removed. After years of operation, the stone in the trench may need to be removed and cleaned and the filter fabric replaced (NIPC 1995).

Detention Basin - In a detention basin, storm water enters a basin that has a structure to control outflow. The water quality benefits result from attenuation of flows by slowing the velocity of water and removal of solids by settling due to lower water velocities. Effectiveness is greatest for suspended sediments such as heavy metals. Lower effectiveness is expected for soluble constituents and nutrients. Oil and grease typically pass through, unless the detention basin is planted with vegetation in a manner that leaves no open water flow paths from one end to the other. Sediments need to be removed periodically, and vegetation should be mowed and replanted periodically (NIPC 1995).

Sediment and Oil and Grease Traps - In sediment and oil and grease traps, storm water runs through a structural device that has a chamber that traps oil, grease, and sediment. The solids need to be removed periodically. The advantage of this design is that oil, grease, and sediment are trapped at a location that is easily accessible to maintenance crews. Water entering the chamber could pass over and under a series of baffles. Baffles at the bottom of the chamber could trap sediment, and baffles at the top could trap oil and grease.

Rain Gardens (bioretention cells) - Rain gardens have native plant amenity features and provide for the infiltration of excess rain water from impervious surfaces. Native plants have root systems that are deeper than typical turf grasses, and provide greater absorptive capacity not only into the plant but also into the soil. Rain gardens are not meant to treat heavily polluted runoff, nor are they designed to absorb maximum rainfall. Instead, they are designed to mitigate local and downstream flooding problems by providing space for excess runoff to be absorbed into the soil or to slow the velocity of the runoff as it passes through the remainder of the storm sewer infrastructure.

## **Model Projects**

Working together, City departments have conducted specific model projects at the municipal, residential, commercial/industrial, and public infrastructure levels. Each project utilizes one or more of the aforementioned BMP techniques. Through these model projects, the City aims to demonstrate the efficacy of various BMP approaches, promote public acceptance and usage, and encourage modification of local ordinances to allow wide-spread usage. Some examples of model projects conducted by Chicago are described below.

### **Municipal Facility Projects**

City Hall Rooftop Garden - The City Hall rooftop garden encompasses 20,000 square feet of planted area and includes more than 150 species of native plants. The roof system was designed to carry 1-inch of precipitation. Aside from the storm water benefits, green roofs lower ambient air temperatures in the summer, provide better insulation which reduces energy demands, and provides animal or insect habitat. The project was selected for a pilot to study the benefits of green roof systems. The project also includes the

development of prototypical guidelines and specifications that can be used elsewhere, and conduction of a study quantifying the environmental benefits of green roof systems. Lessons learned from the project were incorporated into the City's A Guide to Rooftop Gardens booklet. The booklet is targeted to the general public to promote construction of green roofs in the City.

Chicago Center for Green Technology - This city building was renovated to serve as a model for an energy-efficient and environmentally friendly design. The City expects to receive a Platinum Certification under the U.S. Green Building Council's Leadership in Energy and Environmental Design (LEED) Program. Storm water BMPs employed at the site include a functional green roof system, cisterns (capturing up to 12,000 gallons of roof runoff), sheetflow of parking lot runoff to vegetated swales, and a storm water detention area.

### **Residential Projects**

Downspout Disconnection Campaign - Individual residents are being encouraged to disconnect their downspouts, blocking their sewer connection and redirecting the rainwater from their roofs to adjacent landscaped areas. This reduces runoff flow to the combined sewer system, promote groundwater recharge while supporting local green spaces. During summer 2002, the City canvassed flood prone areas of the city, distributing door hangers and brochures to houses which were considered appropriate for downspout disconnection. The City will be promoting the use of rain barrels in conjunction with the downspout disconnection campaign. Gutters could be drained into rain barrels, storing rain water for later irrigation use.

Model Rain Gardens - Model rain gardens are being built in City parkways to absorb additional rainwater during heavy rain periods. Including French drains installed below ground level and plants that can withstand extreme wet and dry conditions, twelve such gardens have been installed in a flood-prone area. These rain gardens were installed to receive runoff from sidewalks and roof areas. Large rain gardens are being planned for the future that will be connected to curb cuts to absorb additional capacity from roads.

### **Commercial/Industrial Projects**

Ford Centerpoint Supplier Park - Ford Motor Company operates a car-manufacturing plant in the Calumet area. Ford is currently finalizing plans to build a supplier park adjacent to their existing facility. This development, which will eventually consist of 1.7 million square feet on 150 acres of land, has the potential to exemplify how industry and environment can co-exist. The purpose of the development is to reduce transportation costs and pollution from long ground delivery distances, and provide a just-in-time manufacturing source of materials for the plant.

A range of innovative, conservation-minded options will be implemented to improve water quality, decrease heavy runoff to the creek, and prevent pollution. First, the development will utilize a separate storm water and sanitary sewer system. All storm water runoff from rooftops and parking lots will be routed into vegetated swales. Swales will contain native vegetation that filters the water as it is conveyed. Storm water runoff from public streets that will be constructed to accommodate the development will drain into roadside swales through curb cuts. Although the swales will be privately owned, a drainage easement will be granted to the City.

The swales will empty into vegetated detention basins for treatment, then be conveyed to a wetlands area and finally into Indian Creek. This design will slow the pace of movement of water into the creek, removing harmful contaminants and decreasing the erosion often caused by major storm events. The entire campus will be planted with shortgrass prairie, tallgrass prairie, and native trees.

### **Public Infrastructure Projects**

130<sup>th</sup> and Torrence Intersection - The City is reconstructing the intersection of 130<sup>th</sup> and Torrence Avenue. As part of this project, both streets will be depressed. Storm water from a rain event will be collected in an underground chamber and then pumped to the Calumet River. The City is considering a variety of treatment options for the storm water before its discharge to the river. These options involve selecting the right combination of BMPs in series that will treat the runoff most effectively and at the least cost. The options include a treatment train of sediment, oil, and grease traps, followed by vegetated swales, infiltration trenches, and a wetland detention basin. The most efficient system is expected to remove 98% of total solids, 88 % of oils and greases, and 40% of the road salt from the runoff (Tetra Tech 2002).

South Lake Shore Drive Project - South Lake Shore Drive is an important part of the City's transportation system. It is an essential commuter link between the downtown area and the City's south side. Heavy traffic and seasonal weather contrasts have led to crumbling road conditions on the drive. The City of Chicago, Illinois Department of Transportation, and the Federal Highway Administration are investing \$162 million to reconstruct more than 6 miles of the roadway. More than 14 acres of green space enhancements will be included in the reconstruction efforts, including new median landscaping, trees, shrubs, perennials, and ornamental grasses.

City engineers also looked at better management of storm water runoff from the drive to protect the water quality in Lake Michigan. Prior to the reconstruction, storm water from the road was directly discharged to the lake. In contrast, all the storm water runoff in the newer North Lake Shore Drive is directed to the City's sewer system. Unfortunately, this sometimes overwhelms the system, causing sewage to backup onto the drive.

As an alternative, City engineers are utilizing a system that directs only the first flush of the South Lake Shore Drive runoff to the sewers. Remaining flow, which will be generally cleaner, will be discharged to the lake. Diversion of the first flush helps reduce the flow into the City's combined sewer system and thereby improve the quality of the runoff discharged into the lake. Once the reconstruction is completed, the City will monitor water quality in the outfalls to see if modifications to the system are needed.

Infiltration Alley - In the Fall of 2001, the City reconstructed an asphalt alley using a permeable system. The new alley has eliminated formerly chronic local flooding without using the sewer system and reduced the "heat island" effect by eliminating dark, heat-absorbing surfaces.

The City used Gravelpave2<sup>TM</sup>, a porous gravel structure, manufactured by Invisible Structures, that contains gravel and provides heavy load bearing support, unlimited traffic volume, and indefinite parking duration. In one 40 in. x 40 in. section of the structure, there are 144 rings made of highly durable plastic, each 2 inches in diameter and 1 inch high and held together underneath by a geo-fabric layer. The section below is a 10-inch thick, compacted aggregate base course consisting of a 2/3 stone and 1/3 sand mixture. The new system can handle up to 3" of rainfall per hour, allowing rainwater to soak into the ground and thereby

reducing polluted run-off and flooding. The system is suitable for traffic, including residential and service vehicles.

*Rain Blocker Program* - Rain Blocker is Chicago's program of installing "vortex" type restrictors in sewer inlets to regulate the rate of storm water runoff entering the sewer system. The system is designed to keep sewers flowing at capacity without backing up. The excess water remains on the street longer instead of backing up in basements or causing CSOs.

## **Summary**

Of course, no one project provides all of the answers. Rather, a combination of the above model projects, implemented on a City-wide and case by case basis, could reverse current trends of urban infrastructure, and thereby dramatically improve water quality.

## **Next Steps**

In the coming year, the City will continue to implement model projects that demonstrate effective management of storm water without requiring additional cost over more traditional methods. The City is also working with the Northeastern Illinois Planning Commission in preparing an urban BMP booklet designed specifically to educate and engage landowners in thoughtful, proactive storm water management approaches. A variety of educational and regulatory programs are also being considered, in addition to monitoring programs to assess the efficiency and replicability of our model projects.

## **References**

City of Chicago website "<http://www.cityofchicago.org/Environment/Rivertour/>"

Environmental Protection Agency Region V, September 2002 "Chicago Area Rivers Restoration Initiative" EPA proposal to the Urban Rivers Initiative.

Northeastern Illinois Planning Commission, August 1995 "Best Management Practice Guidebook for Urban Development.

Tetra Tech EMI June 2002 "Calumet Region Green Infrastructure NPS Demonstration Project" Section 319(h) Grant Proposal.

# REGIONAL FACILITY VS. ON-SITE DEVELOPMENT REGULATIONS: INCREASING FLEXIBILITY AND EFFECTIVENESS IN DEVELOPMENT REGULATION IMPLEMENTATION

Miranda Maupin  
and Theresa Wagner<sup>1</sup>  
City of Seattle  
Seattle, Washington

## Abstract

Development regulations can sometimes be challenging to implement in ultra urban environments due to limited space, high land value, and the expense of retrofitting existing infrastructure. In addition, development patterns may not always correspond to high priority surface water management zones. Development-driven basin planning combined with regional detention and water quality facilities can be tools for locating surface water management investments strategically to protect aquatic resources while creating livable communities. This presentation highlights policy, legal, finance and technical issues and opportunities associated with a Seattle case study. The case study will help prompt discussion regarding the effectiveness of this strategy as a tool for surface water managers in urban jurisdictions to meet multiple interests and put limited stormwater management dollars to effective use.

## A. Introduction

For purposes of discussion, this paper defines an off-site mitigation program as a program offered by a municipality that allows developers to meet on-site development requirements relating to stormwater by compensating the municipality to provide equivalent mitigation in an off-site public facility. Under this scenario, the municipality clearly assumes additional risk and responsibilities, and even perhaps additional costs, so why would a municipality consider such a program? Municipalities might consider offering an off-site mitigation program if:

- The municipality has planning, capital or performance stormwater management obligations, as well as authority to regulate development, and
- On-site stormwater management is required for new development or redevelopment projects, and
- Cost, environmental performance or community benefits can be gained by meeting the on-site requirements off site.

A survey of 26 local jurisdictions in Washington State revealed that jurisdictions are quite interested in understanding how to implement a program, and 9 jurisdictions have even implemented elements of a program. However, no jurisdiction had as yet developed a systematic, programmatic approach that addresses the key issues. This paper presents a discussion of the following issues organized around three areas of responsibility: municipal drainage management, NPDES permit compliance, and development regulation authority.

---

<sup>1</sup> Ms. Maupin is a Senior Planner with Seattle Public Utilities of the City of Seattle. Ms. Wagner is a Senior Assistant City Attorney with the Seattle City Attorney's Office. April Mills, as an intern with Seattle Public Utilities, contributed research and analysis that assisted in the development of this paper. This paper represents solely the views of the authors and not of the City of Seattle or any of its elected officials or departments.



**Table 1 - Key Issues Associated with Implementing an Off-Site Mitigation Program**

Issues	Key Question(s)
<b>Municipal Drainage Management</b>	
✓ On-site vs. Off-Site	<p>When could a municipality consider offering an off-site mitigation program for on-site development requirements?</p> <p>What are the technical trade-offs for a municipality between on-site mitigation and off-site mitigation of development impacts to stormwater?</p> <p>Why might a municipality consider offering an off-site mitigation program for on-site development requirements?</p>
✓ Development vs. Retrofit	<p>Would municipally -constructed facilities address only mitigation triggered by development, or would the facility address existing runoff?</p>
✓ Funding Options and Authority	<p>What are the funding option(s) and associated authority necessary?</p>
✓ Off-Site Mitigation Fee Structure	<p>How would a fee for off-site mitigation be calculated? How important is it for a municipality to recover the full cost of the facility through fees?</p>
<b>NPDES Permit Compliance</b>	
✓ NPDES Permit Requirements and Regulatory Authority	<p>Does the jurisdiction's NPDES municipal stormwater permit require the jurisdiction to regulate development to mitigate stormwater impacts? Does the jurisdiction have legal authority, and leeway under its NPDES permit, to allow off-site mitigation?</p> <p>What legal risks should be evaluated when considering an off-site mitigation program?</p>
✓ Point of Compliance	<p>How is the municipality's point of compliance determined for evaluating performance?</p>
✓ Environmental Protection	<p>How is the regional facility determined equally or more protective than on-site projects?</p>
✓ Timing	<p>What is the timing of development and regional facility construction? What if the development occurs before the regional facility is constructed—leaving a window of time during which runoff is uncontrolled?</p>
<b>Development Regulation Authority</b>	
✓ Applicability	<p>How is applicability established for the program? To which developments is an off-site option made available? How are developments handled that are not upstream of a planned or constructed facility?</p>

In the next section, this paper will provide a Seattle context, including the regulatory background, some local drivers that invite further examination of off-site mitigation in Seattle, and a case study overview. The following section of the paper will provide discussion of the key issues associated with off-site mitigation, using the Seattle case study as an example to walk through the policy and legal implications of the issues identified. Finally, the paper concludes with some thoughts on when regional off-site mitigation makes sense and ideas for how these opportunities fit into the traditional basin planning framework.

## **B. Background, Context and Case Study**

### ***Seattle Context***

The Greater Seattle Area is Washington's largest urban center covering 60 square miles and a population over 3 million and growing. Over the past 30 years, the region has grown nearly twice as fast as the national average. The City of Seattle, itself, is just over 500,000 and fully developed with very few remaining parcels that have not yet been developed. Known as the 'Emerald City,' Seattle is surrounded by water and mountains on all sides. Functioning almost like an island, Seattle drains to the Puget Sound to the West, Lake Washington to the East, the Duwamish River to the South, and Lake Union in the middle.

As a local government, the City of Seattle is multifaceted. In addition to possessing local police powers and regulatory authority for land use and development, the City includes utility departments: Seattle Public Utilities (providing drainage, wastewater, drinking water, and solid waste utility services) and Seattle City Light (providing electric service). Seattle is characterized by a complex drainage infrastructure, administered by Seattle Public Utilities. Nearly 1/3 of the City is the traditional combined system conveying both stormwater and wastewater to the regional wastewater treatment facility operated by the County, with the City's combined sewer overflows regulated by Washington State under a CSO NPDES permit. The remainder of the City is regulated under the municipal separate storm sewer system ("MS4") NPDES permit draining to the surrounding water bodies through more than 200 drainage basins. These basins range in size up to 7,000 acres, though half of the basins are less than 100 acres in size and drain through piped infrastructure directly to large receiving water bodies. About one-third of the jurisdiction drains via informal "ditch and culvert" conveyance system to creeks and then to the surrounding water bodies.

Politically, Seattle has generally tried to encourage development within the City particularly in downtown and the urban villages designated for additional growth under the City's comprehensive planning. This development is with few exceptions redevelopment—that is replacing existing impervious surface with greater density. As the city densifies, demands have increased for public transit, affordable housing, and pedestrian oriented retail with a number of civic scale projects in planning, design or construction. Seattle's urban character is strongly influenced by its neighborhoods with a priority in recent years to coordinate City improvements, including infrastructure, open space and pedestrian amenities, around neighborhood plans. Seattle residents tend to support environmental values, with a particular interest in protecting and enhancing the urban creeks, as demonstrated through several community-initiated watershed action plans.

### ***Regulatory Context***

Since 1995, six Washington entities have been covered by watershed-based general NPDES Phase I MS4 permits issued by the Washington State Department of Ecology ("Ecology"): City of Seattle (with one co-permittee), City of Tacoma, King County, Pierce County, Snohomish County, and the Washington State Department of Transportation; Clark County's permit differs slightly.

The 1995 MS4 permits required each municipality to create a stormwater management program ("SWMP") which had to be approved by Ecology by a certain date during the permit term. The permits required adoption of development regulations, source control efforts, enforcement of Stormwater Code pollutant prohibitions, coordination with other jurisdictions, education, planning and reporting. The permits also required compliance with state water quality standards but provided that "development and implementation of approved stormwater management programs represent ongoing efforts towards meeting those standards

on an approved compliance schedule . . . .” The permits required each Phase I local jurisdiction to adopt a set of ordinances regulating the stormwater impacts of new development and redevelopment, during and after construction. Less typically, the SWMPs and ordinances were required to be approved by Ecology as being “equivalent” to the 1992 state stormwater management manual guidance issued by the state. The manual addresses both flow and quality of stormwater discharges from developed sites. Municipalities have had varying experiences obtaining timely Ecology approval of the SWMPs and of development ordinances. Ecology staff expressed frustration at the staff time required for individual municipal review, and municipalities chafed at the mandate to use local regulatory powers subject to Ecology approval.

Ecology’s 1995 MS4 Phase I permits still cover the seven jurisdictions, and Ecology has set the reissuance effort aside for the time being in favor of other stormwater priorities. The state has not yet determined how it would permit ports, drainage districts, or other entities that may fit the Phase I description, and Phase II jurisdictions have not yet come under permit. Therefore, a patchwork of mandatory stormwater development regulation exists in Washington State, with only the largest local jurisdictions currently required by NPDES MS4 permits to regulate development in a certain manner.

In addition to Clean Water Act regulation, western Washington has been challenged since 1999 with responding to threatened species listings of the Puget Sound chinook and of bull trout. The listings have prompted independent action by the City and other local governments to preserve these aquatic species. Ecology has voiced both a desire to tighten its regulation of MS4s and a fear of liability under the Endangered Species Act for failing to regulate strictly enough.

The next Phase I MS4 permit may test the boundaries of regulation for municipal stormwater. Issues will likely include whether the permit will require (1) compliance with water quality standards at MS4 outfalls or at private development sites, (2) restoration of water quality or habitat within a defined period of time, (3) stormwater planning with specified products which could form the basis for future permits, (4) land use planning according to stormwater priorities, or (5) more rigorous local regulation and enforcement, possibly requiring retrofitting or requiring municipalities to ensure compliance by private parties.

Seattle’s on-site Stormwater, Grading and Drainage Control Code (“Code”) development requirements are found in the Seattle Municipal Code, Chapters 22.800-22.808, enacted by the City Council and in associated rules adopted by City departments under administrative authority. (See <http://www.cityofseattle.net/dclu/codes/sgdccode.htm>) In 2000, the City successfully and amicably negotiated to obtain Ecology’s approval of certain required elements, including on-site detention for sites with 5,000 square feet of new and replaced impervious surface and on-site water quality treatment for sites with 5,000 square feet of new, or one acre of new and replaced pollution generating impervious surface.<sup>2</sup>

Ecology has approved three options in the Code or rules for approving an alternative to on-site requirements—each with provisions to demonstrate that a proposed alternative is equally protective of the environment. Ecology agrees that the City may change its development requirements generally through basin planning, “provided the level of protection for human health, safety and welfare, the environment, and public or private property will equal or exceed that which would otherwise be achieved.” Ecology has also approved the City’s process of granting an exception to a stormwater requirement on a project-by-project basis “if the [City] determines that it is likely to be equally protective of public health, safety and welfare,

---

<sup>2</sup> Pollution generating impervious surface includes areas subject to vehicular use, roofs that include zinc material, and landscaped areas.

the environment, and public and private property as the requirement from which an exception is sought.” And finally, Ecology approved the option to meet on-site water quality requirements off-site if there is a City-approved integrated drainage control plan, which is “a drainage control plan that substitutes water quality treatment from one or more projects through the design of and installation of offsite facilities within a basin draining to the same receiving water body,” accompanied by specific applicant contributions and a construction start date within five years. The City has not yet asked Ecology to approve the option of off-site flow control through an integrated drainage control plan.

### ***Case Study Overview: Urban Center Re-development in Creek Watershed***

A number of proposed civic-scale developments in Seattle, including large low-income housing projects, several major transportation projects, and a few urban center developments, are worth considering for an integrated drainage plan approach with off-site drainage facilities. One of the case studies being considered is an urban center located in Seattle’s largest creek watershed, (7,000-acres, 11 sq. miles) which drains to Lake Washington. The watershed fabric consists primarily of single-family neighborhoods (with over 75,000 residents) intersected by several commercial arterials and a major interstate highway. The creek demonstrates characteristically urban hydrologic patterns, with flashy uncontrolled storm flows and low summer base flows. Flowing primarily through residential backyards, existing development is more often within the 100 foot riparian corridor than not, and the banks are often reinforced to protect these buildings. Despite encroachment and relatively poor benthic health, the creek hosts native vegetation and several fish species, and the community has expressed interest in protecting and enhancing the creek by organizing a community-initiated watershed action plan process among other efforts. The development regulations described earlier are one tool for improving creek health. However, development patterns tend to be slow and dispersed throughout the watershed save for a few areas, such as the urban center, expected to experience more intense growth. For example, over a three-year period, 86 development permits were issued in the watershed. Only 16 of these projects were large enough to trigger Ecology thresholds for development requirements and totaled 4 acres out of the 7,000 acre watershed.

Although the urban center is currently fully developed, the center is expected to redevelop dramatically over the next ten to twenty years with several civic projects, a large retail development and a major transit hub. The community has developed a neighborhood plan expressing a vision of additional quality open space, pedestrian-oriented streets, and civic center amenities including a library and community center. Much of the area was developed prior to the current stormwater development requirements and thus drainage flows directly to the creek without treatment or flow control.

In anticipation of this growth, the City is considering developing an integrated drainage plan to address the drainage issues associated with the projected development at a sub-basin scale rather than a project-by-project approach. The plan could help identify one or more sites to locate City-owned and City-operated regional stormwater detention and treatment facilities within the sub-basin. Preliminary technical analysis indicates a 2.5-acre site could potentially manage over 30 acres of drainage. The facilities could provide management for both existing runoff from impervious areas not expected to redevelop, and runoff that will be subject to development requirements. Thus, this project could be designed to accommodate future partners that may use the facility to meet their stormwater treatment requirements. A partnership approach could replace the need for numerous small, underground facilities with one larger facility that could provide additional public amenities, such as landscaped open space with a trail extending the current creek trail system and native landscaping.

## **C. Discussion of Key Issues**

The discussion of key issues is organized around three areas of jurisdictional responsibility: Municipal drainage management, NPDES permit compliance, and development regulation authority. In addition, the issues have been organized around a series of questions in the order a municipality might face them if considering whether to offer an off-site mitigation program.

### ***Municipal Drainage Management***

#### ***✓ On-site vs. Off-Site***

#### **When could a municipality consider offering an off-site mitigation program for on-site development requirements?**

To successfully implement an off-site mitigation program, a municipality must possess both (1) sufficient police power authority to plan for and regulate development -- typical of a local government -- and (2) authority and responsibility for the quality and quantity of storm drainage, including compliance with any NPDES municipal stormwater permit -- typical of a drainage or stormwater utility. Seattle has this confluence of authority and responsibility, but this is not the case in many other local jurisdictions, where local regulatory authority and drainage system authority are split between entities. Furthermore, options for building and financing regional facilities are typically determined by state law, which may also constrain the options for a municipality to receive funds in connection with approving construction or development. Jurisdictions that lack complete authority may consider working with other jurisdictions by agreement, undertaking joint projects, or seeking legislation to enhance authority.

#### **What are the technical trade-offs for a municipality between on-site mitigation and off-site mitigation of development impacts to stormwater?**

The technical advantages and disadvantages of off-site mitigation vary under different situations. The table below outlines a general checklist of pros and cons.

**Table 2 - Pros and Cons of an Off-Site Mitigation Program**

	<b>Advantages</b>	<b>Disadvantages</b>
<b>Performance</b>	Off-site location may allow more space intensive, but superior performing technologies such as constructed wetlands or bioswales.	If soil permits, infiltration technologies can perform best if decentralized throughout the basin— performance relies on sound maintenance practices.
<b>Planning</b>	Municipality has an opportunity to strategically locate investments to address priority water body or known water quality issues	The municipality must take on the responsibility of determining where to site a facility based on priorities and opportunities. Large regional facilities may be difficult to site in urban areas.
<b>Funding</b>	Partnering may open up additional revenue sources to fund more effective regional facility.	Partnering may complicate facility financing and not fully fund the facility.
<b>Maintenance</b>	The municipality allocates staff to maintenance of a few public facilities, rather than to review, inspection and enforcement of multiple private facilities. Increased assurance of maintenance over time.	Maintenance responsibilities are shifted to the municipality, including disposal of hazardous waste material.
<b>Liability</b>		The municipality takes on the responsibility for managing the risk associated with changing the location and party responsible for implementing water quality requirements. Innovative local regulation or funding may draw legal challenge or present permit compliance issues.
<b>Community</b>	In facility siting and design, municipality can assist in implementing community development plans for open space, aquatic health and urban centers.	Community disagreement about use of public resources and siting.

**Why might a municipality consider offering an off-site mitigation program for on-site development requirements?**

Given the trade-offs outlined above, regional off-site mitigation is not advantageous in all circumstances.

Under what circumstances should a utility consider an off-site program?

In general if the off-site program can offer environmental, cost or community benefits that outweigh the disadvantages, then an off-site approach should be considered.

**Environmental**—If analysis suggests that stormwater investments would be more effective located more strategically -- either to address a more critical water quality issue, or to protect a higher priority water body. In addition to flexibility in location, a municipality may have the opportunity to use a more effective technology such as a biologically-oriented system that enhances treatment through plants and micro-organisms.

**Cost**—Seattle, for example, has responsibility under its NPDES MS4 permit for reviewing, permitting, inspecting and enforcing maintenance practices for privately developed stormwater facilities. These responsibilities require staff time and associated resources and are likely to increase under future MS4

permits. Municipalities might consider consolidating these costs in an off-site mitigation program if the programmatic costs of administering on-site requirements over time outweigh the costs of the design, construction and maintenance of a publicly owned structural facility. In some cases the municipality already owns land for potential facilities that could substantially influence cost evaluations.

Community Goals--More often municipalities are being asked to play a role in the shaping of communities. Growth management plans or other long-term development plans typically specify areas targeted for future higher density development and other areas designated as green space to provide parks and protect environmental resources. Municipalities can play a role in directing stormwater improvement, by transferring investments from areas targeted for density to areas specified through regulation or community goals for higher levels of environmental protection. In addition, municipalities can often integrate open space goals into facility design to meet multiple goals in limited space.

In the Seattle case study, an off-site approach could fulfill both environmental and community goals. A regional facility would be expected to provide better technology, target more critical flows and ensure better maintenance over time. If no off-site program were available, high land value in the area would likely drive developers to use multiple underground vaults to address stormwater requirements on site. In contrast, a regional facility could offer constructed wetland technology with a downstream bioswale on a site located at the mouth of the drainage basin discharging to the creek. In addition to a superior technology, a municipality could have more confidence in the ability of its staff to maintain a single public facility, than in the municipality's ability effectively to enforce maintenance practices on multiple private underground facilities. The site's location, at the mouth of the basin just prior to discharging to the creek, provides maximum flexibility in determining what area might be routed to the facility for treatment, thus allowing the municipality to prioritize and mitigate drainage areas with higher pollutant potential.

Community goals can be served by integrating open space amenities with existing creek trail systems and providing greater flexibility to implement desired development projects within the confines of limited space.

Cost is a determining factor, and it will vary greatly from site to site. A regional facility can be funded in several ways, depending on the options available to a municipality or utility under state law. A regional facility should not be expected to be funded entirely by private development, even if it provides some service to redevelopment. This is true because, as in Seattle's case, the facility will likely address some existing flows in addition to the developed sites. Also, municipal staff resources would be spent on design, construction and maintenance.

### ✓ *Development vs. Retrofit*

#### **Would municipally-constructed facilities address only mitigation triggered by development, or would the facility address existing runoff?**

This decision will vary for each scenario and may be influenced by the following factors:

- size of the site in relation to the drainage area,
- the water quality characteristics of the drainage area,
- the relative ease of directing flows to the site, and
- how the site fits in the municipality's priorities for retrofitting.

If the site is large enough to accommodate additional flows, and the drainage is relatively easy to direct to the site, the municipality might consider combining off-site mitigation with mitigation of existing development. Much of the cost of capital facilities is in the design, permitting and grading— and increasing the size of one facility is often much less expensive than creating a separate facility. The municipality may also have an interest in demonstrating a broader general public drainage benefit of the facility is funded in part by drainage rates.

In the Seattle case study, some portion of the facility would likely address existing runoff providing public benefits beyond enhanced development mitigation. The appropriate portion will vary by project and be determined through technical analysis at the sub-basin level.

### ✓ *Funding Options and Authority*

#### **What are the funding option(s) and associated authority necessary?**

Several options may be available for funding an off-site regional drainage facility. The available options will depend on existing municipal or utility authority. In some cases, funding options may be combined. Legal advice is essential in planning municipal action, and sorting through the range of legal authority available to a municipality can present a significant challenge.

A municipality might choose to build and fund a regional facility using general municipal revenue or drainage-specific funds:

- Use general municipal revenue, not associated with drainage rates or development options.
- Use general drainage utility rates. Costs could be spread over a larger service base.
- Create differential drainage utility rates reflecting the drainage service provided in geographical areas. Increases could be targeted to areas receiving or needing more intensive service.
- Create drainage utility connection fees for users of a new facility. After a facility is built using municipal authority and funds, drainage utility fees are charged to new users of the regional facility.

Each of these regional facility funding choices would leave legal and policy questions for a municipality such as Seattle that currently requires on-site drainage facilities for redevelopment, as a result of its MS4 permit:

- Must developers still build on-site facilities, as required by the local development ordinance and the NPDES MS4 permit issued to the City?
- If not, is it fair or legal to impose a general fee increase to build facilities that in part benefit private development, without charging extra to the benefited properties?
- For funding, what difference does it make whether or not a development's actual drainage is managed at a regional facility?
- If on-site detention/treatment requirements for new development will be fulfilled off site by using capacity at a regional facility, can the local on-site drainage requirements be lifted? If so, how? What can or should the developers be charged for off-site regional drainage service?
- What legal authority is present, both to create a different fee for a developer (which could be a drainage rate question) and to allow a developer to meet its drainage regulation obligation off-site rather than on-site (which could relate to municipal responsibilities as a regulator of development and an NPDES MS4 permittee)?



An appealing option for funding at least part of a regional facility might be to create a fee for off-site mitigation that developers could pay to fund off-site municipally-owned regional drainage service, instead of requiring the developers to build on-site detention or treatment structures.

- Create a development-related alternative to pay a fee to obtain drainage service at the regional facility rather than on site.

Utility rates or general utility funds could be used to build over-sized regional facilities. A municipality could make excess capacity available to developers for a fee, to satisfy developers' on-site requirements. Arrangements might be voluntary or mandatory, for a determined geographical area. Legal authority must be established. In such a case, state law may explicitly permit developers to contribute to the cost of a regional municipal facility, on a mandatory or voluntary basis. On the other hand, state law may limit or prohibit this arrangement, or its mandatory nature.

In some limited cases, there may also be an opportunity for developers to agree among themselves to build a privately-funded off-site facility.

- An agreement among parties to provide service off site, independent of municipal rates or fees.

In issuing development permits, the municipality as a regulator would have to determine whether the on-site facility requirement would be met by the regional facility. The facility might be independently operated, or the municipality might later choose to acquire the facility.

### ✓ *Off-Site Mitigation Fee Structure*

#### **How would a fee for off-site mitigation be calculated? How important is it for a municipality to recover the full cost of the facility through fees?**

What are the options for structuring fees paid to a municipality for providing off-site mitigation at a municipally-owned regional facility? Again, legal authority may determine the calculation methods available for utility fees or development-related fees, but here are some options to consider in setting a fee:

- Based on cost of off-site facility:
  - Pro-rata portion of the actual off-site facility cost based on capacity
    - based on estimated runoff
    - based on acreage or square footage of impervious surface
  - Standardized fee per unit runoff reflecting average current cost of off-site facility construction
- Based on estimated cost of building facility on-site.

In some cases it may be wise to balance the on-site costs against the off-site costs, considering the options available to a developer. For instance, if participation in a regional facility is an option to providing on-site detention or treatment, the fee structure may affect the willingness of developers to participate in an off-site option. A municipality should recognize that the full cost of a regional facility is unlikely to be recovered from development-related contributions.

## ***Environmental Permit Compliance***

### **✓ *NPDES Permit Requirements and Regulatory Authority***

**Does the jurisdiction’s NPDES municipal stormwater permit require the jurisdiction to regulate development to mitigate stormwater impacts? Does the jurisdiction have legal authority, and leeway under its NPDES permit, to allow off-site mitigation?**

The degree of legal authority municipalities have to mitigate stormwater development requirements off site may range from explicit direction to explicit prohibitions. Each municipality should consider not only its police power, utility and other state law authority, but also any requirements of its NPDES MS4 permit. Each municipality will have to evaluate the appropriate level of authority and permit obligations, and the associated level of risk, as well as the likely perspective of the NPDES permit issuing authority. The following scenarios provide an example of the range of authority level and associated risks:

- Explicitly authorized
- Generally authorized
- Not Addressed
- Explicitly not permitted

In the Seattle case study, the City’s NPDES MS4 permit requires the City to impose on-site detention and treatment requirements for certain new development and redevelopment. The City’s Code was required to be, and was, approved by Ecology as equivalent to Ecology’s guidance. Ecology’s model of regulation is site by site, but there is some leeway for modifying on-site requirements with sufficient justification. Both Ecology’s manual of model development regulations and the City’s Code identify basin planning as a means for jurisdictions to alter development requirements within the basin, but neither specifically mentions off-site mitigation. Ecology has authorized the City to make off-site accommodations for treatment requirements based on a City-approved integrated drainage control plan for construction that begins in five years, but this has not yet been extended to detention. The City will need to determine what is necessary and sufficient for basin planning and will need to justify an off-site mitigation program in a way that is consistent with both the MS4 permit and the City’s authority and needs.

### **What legal risks should be evaluated when considering an off-site mitigation program?**

An off-site mitigation program can be legally risky or unexpectedly expensive. A municipality’s authority to implement the program may be questioned. A municipality may incur liability if it agrees to construct a regional facility but is eventually unable to construct it, due to permitting or other complications. If the facility was intended to replace on-site drainage control, then stormwater that would have been detained or treated on site could go entirely unmanaged, and the developers’ potential contribution to regional stormwater control could be lost. Depending on NPDES MS4 permit conditions, the municipality might be obligated to site the facility elsewhere or might be out of compliance. Under some funding mechanisms and state law, the municipality might be obligated to refund monies not used within a certain time, losing the financial means to complete the project. For instance, given permit constraints, funding uncertainties, and changing priorities, even five years can be an ambitious timeframe for public facility construction.

## ✓ *Point of Compliance*

### **How is the municipality's point of compliance determined for evaluating performance?**

For purposes of this discussion, point of compliance is the point at which the development requirement must be met through equivalent mitigation. Theoretically point of compliance could be any of the following scenarios, but these scenarios differ in risk level and relationship to the regulated drainage area.

- Site discharge point
- Point between site and discharge to receiving water body
- Discharge point to the receiving water body
- Receiving water body

A municipality must define “receiving water body” for this purpose. If “receiving water body” means water of the state, including a small creek, then off-site mitigation locations upstream of a discharge are limited. If, on the other hand, “receiving water body” means only specified larger streams, rivers, or lakes, then a greater number of off-site locations may be available.

One option is to evaluate performance at the receiving water body, or at the discharge point to the receiving water body. Ecology has approved the option in Seattle to meet on-site water quality treatment requirements from one or more development projects through off-site facilities within a basin draining to the same receiving water body. This language defines point of compliance as the receiving water body. This approach is more suitable for addressing water quality in major water bodies, than for addressing flow control in creeks. For example, if off-site flow control is provided in a separate basin draining to a creek at a point lower in the system than the basin with the development project, then technically an opportunity to improve the flow regime in the reach between the sub-basins has been missed. Locating a regional facility downstream of a participating development site would result in missed protection of the portion of the stream between the development site and the regional facility. This makes a case for evaluating performance for creeks at the basin's discharge point to the water body, not in the water body itself.

A municipality will likely want to retain maximum flexibility for siting regional facilities, to site facilities at points of opportunity and where they will have the greatest impact. To this end, an important consideration for funding, development regulation, and permit compliance is whether or not the off-site facility will provide drainage service for the exact same stormwater that would have been managed on site under local development regulations. If the same water will be managed, it will be simpler and less risky to link development requirements and funding from partners to an off-site municipal facility. Funding options that do not rely on development-related fees or partnering present even less risk.

Available legal authority will determine to what extent funds related to a development site can be used for an off-site mitigation facility that does not detain or treat the same stormwater. For instance, it may be that connection charges are authorized only for developments directly served by a facility; in such a case, access to the facility capacity would need to be consistent with authority. A fee could spur a legal challenge if it is seen, on one hand, as opportunistically charging development for general municipal services provided elsewhere or, on the other hand, giving benefit to development at unfair public expense.

As to permit compliance, the NPDES permitting agency will likely have an opinion about whether detention or treatment services should be moved from the site of new development, and whether flow from the development should be allowed to go unmanaged. The agency may support municipal spending on regional facilities but hesitate to approve transferring drainage management from one subbasin to another. Depending on the permit's terms and the agency's involvement with local regulations, the agency may even

view an off-site mitigation program as noncompliance, so a municipality should work proactively with the agency to smooth out disagreements.

Even if the permitting agency agrees that off-site mitigation meets the MS4 permit obligations, the municipality should consider whether it is willing in the long term to take on detention or treatment functions regionally that would otherwise be the obligation of site developers. Typically, municipal regulation holds site operators responsible for discharge from their sites. If a problem is detected downstream in the MS4, upstream dischargers can be held accountable. An off-site mitigation program could alter this dynamic. If an MS4 permit requires that municipal stormwater complies with water quality standards before discharge to waters of the state, an off-site mitigation program could shift to the public, part of a private site-related water quality obligation.

### ✓ *Environmental Protection*

#### **How is the regional facility determined equally or more protective than on-site projects?**

There are several options for evaluating the equivalency of on-site and off-site approaches, which is a key inquiry to justify off-site vs. on-site detention or treatment in basin planning or in issuing a development permit.

- Equivalent impervious surface (or pollution-generating surface)
- Equivalent volume of water

In addition to these one-to-one evaluations, greater effectiveness can be achieved by using a superior technology than would be used on-site, and by treating areas contributing higher pollutant levels within the sub-basin. Although prior to development the effectiveness of these two scenarios cannot be measured, a simple model using information from previous research studies can be used to estimate the proposed reductions under the two scenarios.

In general consolidating maintenance and providing bio-filtration features can be more protective of the environment than multiple underground vaults because the effectiveness of WQ facilities is very dependent on the frequency and quality of maintenance. By leveraging development and rate investments to treat both existing runoff and runoff from a development, a regional project can be more protective.

### ✓ *Timing*

#### **What is the timing of development and regional facility construction? What if the development occurs before the regional facility is constructed—leaving a window of time that during which runoff is uncontrolled?**

The least risk and most environmentally protective option is for the jurisdiction to first build the facility and then offer off-site credit for future development projects. However, there may be partnership opportunities where development occurs before a facility is identified or built; if those potential partners need development permits before the option of regional stormwater management becomes available, opportunity may be lost as partners opt for on-site facilities.

On the other hand if the municipality sizes and constructs a facility “on speculation,” and the future development does not occur, or developers choose not to buy excess capacity in the facility under a voluntary arrangement, then this capacity is an avoidable ratepayer cost.

There may be regulatory risk as well. A NPDES permit issuing agency may generally support off-site mitigation in theory, recognizing the greater efficiency that may be possible. However, the permit issuer and the municipality may have different perspectives if an off-site mitigation plan involves a delay in providing detention or treatment for an area, as compared to what would be provided at the time of new development under local on-site requirements. Such a delay may also create complications in issuing development permits, where the on-site conditions cannot be fulfilled off site in the same time frame. Municipalities may need to negotiate with the NPDES permitting authority to retain maximum flexibility in timing. Local law may need to explicitly allow a developer a calculated delay in detention or treatment, if it there is a firm commitment to provide the same off site.

## ***Development Regulation Authority***

### **✓ *Applicability***

**How is applicability established for the program? To which developments is an off-site option made available? How are developments handled that are not upstream of a planned or constructed facility?**

Typical development regulation criteria include:

- project size— Municipalities may only want to administer projects above a certain size threshold where there will be more mitigation per transaction. On the other hand, municipalities may decide that they can save administration costs by consolidating the review, inspection and enforcement of smaller facilities into a single regional facility. In this case project size may not be a criteria.
- amount of pollution-generating surfaces— Municipalities may want to target land uses that are known to contribute higher pollutant levels. On the other hand, municipalities may want to target “cleaner” development projects to transfer the investment to areas contributing higher pollutant levels. (For example, trading on-site residential development mitigation for a high turn-over commercial parking lot that is currently un-treated.)
- drainage destination (to a creek or specific water body)— Depending on the utility’s regulatory flexibility and sophistication in prioritizing water bodies, the municipality may want to trade all mitigation in one basin for treatment in another. However, depending on the specific situation, this approach can undermine the development regulation by raising questions regarding the direct impact of the requirement.

Additional application criteria for a municipally-administered program may include whether project is located:

- within a priority drainage basin— The municipality may have designated specific basins for program implementation, and only development in these basins would be applicable for the program. Basins may be chosen through a prioritization process, through a growth management planning process, or a combination of both.
- upstream of planned or constructed facilities— Development projects may be in the designated basin, but not directly upstream of a planned or constructed facility. In this case, the municipality must decide whether the drainage from the development project must flow through the facility to

meet off-site mitigation, or whether an equivalent amount and quality of stormwater can be mitigated within the basin prior to discharging to the receiving water body. Associated issues are raised in the discussion of point of compliance, above.

Finally, the jurisdiction must decide how much capacity to provide and whether applicability will need to be capped at a specific threshold and perhaps a timeframe. Capping the facility capacity ensures the municipality will not have to site, design and build another facility if development continues beyond projections. Ideally a facility would be sited and designed to compliment the development plan for the area. The program should outline a template that ensures consistency, but allows for unique opportunities based on the project location, circumstances and management goals for receiving water body.

The legal issues in determining applicability are similar to those discussed with in relation to the point of compliance. Legal authority may limit the geographical boundaries for an off-site mitigation program. For some funding mechanisms, it may be essential that flow from the development actually be detained or treated by the regional facility in order to support a fee. In order to remove on-site detention or treatment requirements, it may be necessary to justify that the alternative is equally protective of public health, safety, and welfare, the environment, and public and private property. This may be a challenge if a regional facility provides benefits at a location far away. In other cases, using fees for off-site mitigation not directly related to a site can complicate development regulation in the future. For instance, if a development requirement is lifted upon payment of a fee but flow from that specific site is not detained or treated, what happens if the property is redeveloped later? A municipality should consider its overall strategy for off-site mitigation and deal with as many issues as possible when the program is established, to provide a predictable basis for future development.

#### **D. Conclusion**

Off-site mitigation programs have the potential to shift development-required investments to address high surface water priorities identified through basin planning. However, this type of program is not applicable or appropriate to all municipalities, and even in appropriate situations, the approach shifts responsibility and liability to the municipality. This paper has attempted to outline the municipal drainage management, NPDES permit compliance and development regulations issues associated with offering an off-site mitigation program. This paper is intended to prompt discussion regarding the effectiveness of this strategy as a tool for surface water managers in urban jurisdictions to meet multiple interests and put limited stormwater management dollars to effective use.

# **A REGIONAL APPROACH TO PHASE II PERMITTING ENCOURAGES COOPERATION AND REDUCES COST**

Steve McKinley, PE  
Water Resources Program Manager FMSM Engineers

John F. Damico, MBA President  
Environmental Rate Consultants, Inc.

Patrick T. Karney, PE, DEE Director  
Metropolitan Sewer District of Greater Cincinnati

## **Abstract**

The communities in Hamilton County, Ohio are working together to integrate the EPA Phase II Storm Water Permit by developing a financial plan and a legal organization (Ohio Revised Code [ORC] 6117) to manage storm water on a regional basis. This approach will lead to an efficient and effective permit process; encourage regional cooperation; and lower costs through the economies of scale. In many cases communities are not able to afford the additional financial burden of the permit nor do they have the resources to perform the requirements of the storm water permits. The villages and small townships have expressed that they do not have the resources to develop and implement the permit requirements. If there is no regional authority many of these small communities will be in violation of the NPDES Phase II Storm Water Regulations.

This paper will describe a successful consensus building process used by a number of diverse municipalities working together to address and develop solutions to the water resource problems. They are not alone; hundreds of communities throughout Ohio and the United States are struggling to deal with these very same problems. This has been a complex effort of more than a year of data gathering, consensus building, policy development and regional decision making. There is too much data and information to describe all of the tasks and events that have taken place in this effort. Therefore we will focus on the process used to achieve regional cooperation and how it effected the NPDES Phase II Permit development. We will also look at how regional groups working together can use economies of scale and provide a cost savings to many communities in the region.

## **Introduction**

Hamilton County is located in southwestern Ohio and consists of 49 communities including the City of Cincinnati (also a Phase II community). Its suburbs, townships, and villages are all contained within three major watersheds: the Great Miami, Little Miami, & Mill Creek. All but one community (a small township) must comply with the Phase II Storm Water Regulations.

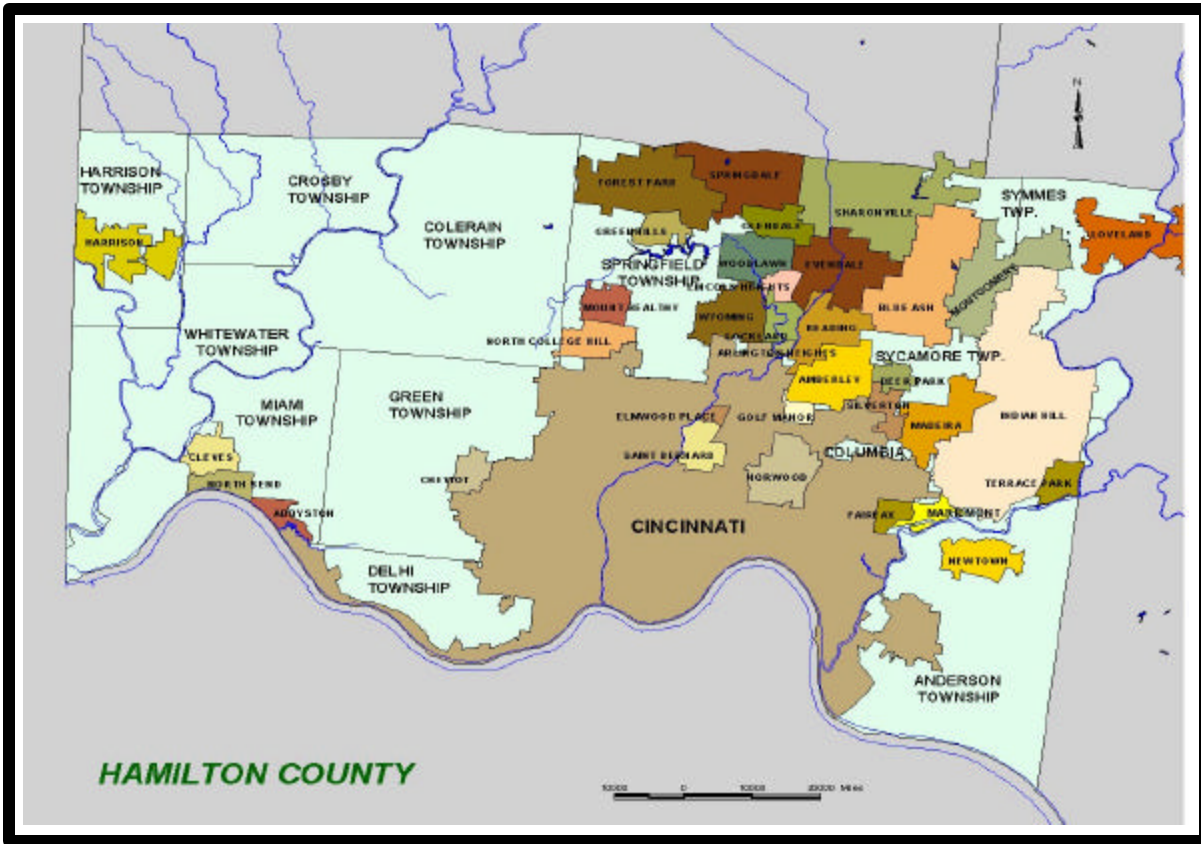
This paper will describe the following.

- Creation of a legal organization within the guidelines of an ORC 6117 to guide the Hamilton County Regional Program.
- The financial aspects of funding such an organization.

- Economy of scale cost savings as a result of joining a regional organization and participating in a regional NPDES Phase II Permit.

### More Than a Queen City

The City of Cincinnati has traditionally been referred to as the Queen City, a truly midwestern city located in southwest Ohio. But while this is the way this area is known, there is much more to southwest Ohio than just the City of Cincinnati. There is Hamilton County, home to a population of more than 845,000 people. Hamilton County is situated in the extreme southwestern corner of the State of Ohio and covers an area of 414 square miles. Within the County are 49 municipalities, including 21 cities, 16 villages and 12 townships. Hamilton County is the third largest in the State in terms of population.



**Figure No. 1. Hamilton County Map of Municipalities Including Cities, Villages and Townships**

Three major watersheds that encompasses rural, suburban, and intense urban land uses cover the County. These include the Little Miami River Watershed, Great Miami River Watershed, and the Mill Creek Watershed. The Mill Creek Watershed is the smallest of the three watersheds and, except for a small area in neighboring Butler County, is entirely contained within Hamilton County. Its drainage area contains the most intense urban development (.Hedeen, S., 1994. The Mill Creek – An Unnatural History of an Urban Stream).

Most of the urban and suburban communities are located in this watershed along with the area's industrial complex. There are also more than 160-combined sewer overflows (CSO's) in this watershed. Because of



the complexity of these problems the Rivers Unlimited Mill Creek Restoration Project (RUMCRP) and the Mill Creek Watershed Council were formed to educate and address the water quality concerns of Mill Creek. Both groups have been a part of the Steering Committee and have provided great contributions to this process.

Each of the communities is important because they represent the growth and the vitality taking place in the Cincinnati Metropolitan area. They also contribute to the problems of flooding and water pollution. While this alone should be the reason for cooperation, EPA has provided another reason for communities to work together through the NPDES Phase II Storm Water Permit.

## **The Storm Water Study**

The Hamilton County Storm Water Study was initiated by the Board of County Commissioners (through the Metropolitan Sewer District of Greater Cincinnati) to address storm water quantity (flooding) and quality (Phase II NPDES) concerns. The specific purpose of this "Study" is to assist local governments throughout Hamilton County, either individually or collectively, to address both the storm water quantity and the NPDES Phase II water quality permit issues and regulations. These USEPA storm water regulations will require all but one of the Hamilton County governments to obtain an NPDES Phase II permit by March 10, 2003. These permits require that each local government develop a Storm Water Management Plan (SWMP) to address six (6) minimum control measures. Implementation of these minimum control measures is intended to improve the quality of the region's rivers and streams.

Today, one of the most serious problems facing Hamilton County elected officials is storm water management (Mill Creek Watershed Council, Summer 2002. "Voice of the Mill Creek"). Every local government in Hamilton County has experienced varying degrees of storm water problems such as street and basement flooding, street closures, stream bank erosion, clogged storm drains, sewer backups and unmaintained detention basins, to name a few. Less frequent, but in many cases more severe, are extreme rainfall events that wash out roads, flood homes and businesses, and in some cases result in injury or death.



**Rescue workers along Sycamore Creek  
July 18, 2001**



**Erosion Damage along Polk Run  
from storm of July 17— 18, 2001**

Now, all of the Hamilton County elected officials must address the requirements of the unfunded USEPA NPDES Phase II Storm Water Permit Program. The NPDES Phase II Storm Water Permit Program will require most local governments to take action to improve water quality in rivers and streams in their areas. Communities will also be required to reduce the pollution load coming from their storm sewers and drainage ditches.

In July 2001, as a result of the torrential rainfall and ensuing devastating flood, the Storm Water Study shifted its primary focus from establishing a regional Phase II permit application to include a means of addressing some of the regional flooding and erosion control problems identified after that flood (Mill Creek Watershed Council, Spring 2002. "Voice of the Mill Creek"). During the course of this Study, nearly 500 "Areas of Concerns" were identified. These "Areas of Concern" included flooding problems, erosion problems, drainage problems and water quality problems. Additionally, The Hamilton County Department of Public Works identified over 2,900 buildings that were located in floodplain areas, within the unincorporated area of the County. A very preliminary estimate of the potential capital requirements would exceed \$500 million, including:

- \$250 million for capital projects to address the local government's "Areas of Concern".
- \$50 million as the local share of the potential costs to remove or mitigate structures in the 100-year floodplain.
- \$200 million as the local cost for the flood control component of the Mill Creek Tunnel Project.

As a result of these mandated water quality regulations and on-going water quantity problems, the Hamilton County Board of County Commissioners have begun to "encourage regional cooperation" by initiating a regional watershed based approach that will formulate and develop solutions for solving these problems. In order to address these complex issues and begin the process of solving the water resource problems in Hamilton County, a plan for regional cooperation was developed that included all of the communities. The plan involved a series of community interactions that educate, inform, and provide a forum for interaction

and consensus building. The plan also involved the formulation of a mission and series of goals that serve as a foundation for regional cooperation.

## **Encourage Regional Cooperation**

A kick-off meeting for the study was held on March 29, 2001. A Steering Committee was established with representatives from County Departments, Local Governments, Regional Agencies and area Universities. The Steering Committee has met monthly since April 2001, with an average of 40 to 45 people attending each meeting. The purpose of this Steering Committee was to develop issues and policies for the Executive Committee and to be a technical advisor to the Consulting Team. The Executive Committee was a small group of elected officials that crafted the regional organization and set policy. The Consulting Team developed and presented a series of "Issue Papers" to assist the Steering Committee in evaluating alternatives and developing solutions to the quality and quantity problems facing the region.

There are many elements that go into the encouragement and development of regional cooperation. For this project, a combination of planned and unexpected elements has come together to build the success we have enjoyed to this point. The following discussion is a brief summary of the following critical success elements:

- Planned Interactions
- Champions
- Mission and Goals
- Building Consensus

### ***Planned Interactions***

It was clear from the very beginning that good community relationships and trust would be needed to develop regional cooperation. To accomplish this trust and relationship, four distinct types of community interaction were planned to get as much interaction with community staff, management, and elected officials as possible. These four types of interaction are as follows:

- Individual Interviews with Local Governments
- Steering Committee
- Executive Committee
- Regional Workshops

### **Individual Interviews with Local Governments**

The Project Team met individually with each local government (a total of more than 50 meetings) throughout Hamilton County. The purpose of these face-to-face meetings was two-fold. The first goal was

to determine a current level of service for storm water in the regional service area. The Level of Service are those activities and functions that a community performs to address the storm water issues in a community. For this study, the Level of Service for storm water includes the Administrative, Engineering & Technical, Environmental & Regulatory, Operation & Maintenance, and Capital Improvement functions that support a community's storm water management. We accomplished this in Hamilton County by identifying each local government's problem areas (Areas of Concern) and obtaining copies of any existing ordinances, regulations, and other pertinent information. Secondly, these meetings provided the Project Team with an opportunity to begin building a relationship with communities located throughout the County, and to convey the process and purpose of the project. This also helped the Project Team to provide each community with a consistent message concerning impending NPDES Phase II Permit Program. Each community was invited to participate in the Steering Committee process that will build relationships and trust throughout the region, and most importantly provide a means for making decisions about how the County will address the NPDES Phase II Permit Program.

### **Steering Committee**

The Steering Committee consisted of a wide range of financial and non-financial stakeholder groups including: community staff and management, several elected officials, county department representatives, watershed and environmental groups, university representatives and others. The Steering Committee has met each month since April 2001. All communities were invited to participate in the Steering Committee process but not all of the communities attended the meetings. There has been a regular attendance of 40 to 45 at each of the monthly meetings. The purpose of this group was to discuss the details of each of the issues of regional cooperation, continue the consensus building process started during the individual face-to-face local meetings, and to conclude with recommendations that would be carried forward to the Executive Committee comprised of elected officials. Issues such as the following were addressed by the Steering Committee:

- Is there a need for a regional group?
- What is an NPDES Phase II Permit?
- What legal authority is available to form a regional district?
- What is the level of service?
- How much will a regional district cost?



## **Storm Water Study Steering Committee**

### **Executive Committee**

The Executive Committee is a much smaller group of 10 members comprised of elected officials from selected communities, the Township Trustees Association, the Municipal League, the Board of County Commissioners, and the Metropolitan Sewer District of Greater Cincinnati. The purpose of the Executive Committee is to consider the recommendations from the Steering Committee, create a legal organization that will encourage regional cooperation, finalize and establish policy, define the storm water level of service, and set rates and charges. The Executive Committee will make final decisions based on local ratepayer interests.

### **Regional Workshops**

Regional Workshops are an attempt to bring together as many of the community leaders (elected officials) as possible to build consensus for the policies developed in by the Steering Committee and by the Executive Committee. Thus far, only one workshop has been conducted. It was an important workshop because it fueled the consensus to develop a small regional district to address the NPDES Phase II Permit.

### ***Champions***

Regional cooperation cannot occur without leadership. The Hamilton County Regional Storm Water Program is no exception to that rule. The success that we have experienced to date has come largely from the leadership of a group of concerned and passionate people. There are a number of people who could be singled out from the Steering Committee and Executive Committee, and there are also those who have paved the way (i.e., the City of Cincinnati Storm Water Utility, the City of Forest Park Storm Water Utility, and the Mill Creek Watershed Council) for this project. There are however, those whose exceptional leadership grants them the title of “Champion.” Hamilton County Commissioner John Dowlin; Mr. Pat

Karney, Director of the Metropolitan Sewer District of Greater Cincinnati; and Mr. Bill Brashaw, County Engineer for Hamilton County, Ohio; have given their time, talent, and passion without reservation to the pursuit of regional cooperation. Without their influence and support there would be no regional project. A Champion is not created or named as a part of some defined process; they arise as a result of the understanding of the vision and the sense of mission that can be accomplished by an effort. The Champions in Hamilton County saw the vision of a regional district and responded with passion to provide the leadership necessary to develop the Hamilton County Regional Storm Water Program.

## ***Mission and Goals***

Every successful endeavor must be planned with an understanding of the direction and destination of the effort. In our initial meetings with the Steering Committee, a mission statement along with a series of goals was developed to establish a foundation and guide for our entire process. The mission statement and goals developed by the Steering Committee are listed below.

### **Mission Statement**

Determine the most effective organizational / management / legal structure available in the State of Ohio, to position Hamilton County and the local governments within the County, to address the NPDES Phase II Storm Water permit regulations, and efficiently and effectively manage storm water on a watershed basis.

### **Goals**

#### ***Water Quality***

Develop a water quality program that will initially meet the requirements of the EPA NPDES Phase II Storm Water Program and over the first five years of the program assist communities to move to comprehensive water quality improvements throughout the district boundary.

#### ***Water Quantity***

Develop a water program that will initially complement the EPA NPDES Phase II Storm Water Permit requirements and over the first five years of the program move to a comprehensive floodplain and drainage program.

#### ***Institutional / Organization***

Create a legal organization to manage storm water on a regional basis utilizing Ohio Revised Code 6117 or Ohio Revised Code 6119.

#### ***Environmental***

Develop an environmental program that meets the requirements of the EPA NPDES Phase II Storm Water Program and over the first five years of the program move to a comprehensive environmental program that recognizes storm water as a valued community natural resource that needs to be preserved and protected.

## ***Finance***

Establish a district-wide dedicated source of funding that supports the institutional goals of the program, is fair and equitable, and creates both a short-term and long-term rate structure.

## ***Public Involvement / Education***

Create a Public Involvement / Education program that meets the requirements of the EPA NPDES Phase II Storm Water Program and over the first five years of the program move to a comprehensive Public Involvement / Education that includes all stakeholders and takes a watershed approach to help citizens preserve and protect the environment.

## ***Watershed***

Implement a watershed approach throughout the district boundaries. (Note that the district boundary is Hamilton County, Ohio, but there are portions of three watersheds within Hamilton County and the communities want to take a "Watershed Approach" to the management of the district).

## ***Building Consensus***

Building and achieving consensus with a large group was a real challenge. Some of these challenges included: keeping the members' interests high, to motivate them to return to future meetings, to achieve consensus, to communicate complex issues at a level that everyone comprehends, and to address personal and political agendas. Techniques that were implemented and used for this process are as follows:

- Define Consensus – The group ultimately defined consensus as – "I can accept and live with this action or solution." This definition does not necessarily provide the optimum solution for all members but does provide a solution that everyone can live with as a region.
- Mission and Goals – We referred back to this foundational building block many times throughout the process, which kept us on track and on target with our overall agenda.
- Agendas – An agenda was sent out before every meeting so everyone could attend the meeting and have meaningful input in the process and topic of the day. We also sent meeting summaries to each community after each meeting.
- Issue Papers – Key issues, policies, and topics were written in a "white paper" format called issue papers. This contained important research, history, or regulatory information as well as alternatives and recommendations.
- E-Mail & Internet – Communication with this many people is critical. We were able to use e-mail (almost everyone had e-mail and internet access) for day-to-day communication and a project web site was created on the Metropolitan Sewer District's Internet site. All of the presentations, issue papers, agendas, meeting summaries and maps were placed on this web page.
- Variety of Materials and Presentation Methods – There was an attempt to make every meeting interesting and informative by using a diversity of materials and techniques to present the meeting

material. PowerPoint, presentation boards, Arc-View GIS demos and facilitated interaction were all used in the meetings. In one of the meetings a written survey was used to gather information and opinion.

- Sergeant-at-Arms was selected from among the Steering Committee to keep order and focus.

## **Efficient and Effective Permit Process**

Today, there is a new emphasis on dealing with storm water quality. Since enactment of the Clean Water Act by Congress in 1972, local governments and industries in Ohio have spent hundreds of millions of dollars to upgrade, expand or rebuild their wastewater treatment plants. The net result of this massive capital program has been significantly improved effluents from wastewater plants with corresponding improvements in the quality of receiving streams. As these treatment plants have improved however, it has become apparent that there are other sources of pollutants to our rivers and streams that are adversely affecting their quality and impacting aquatic life. These sources include agricultural runoff (fertilizers, pesticides), hydro modification (channelization, stream maintenance), mining, urban runoff, land disposal, construction site runoff and failing septic systems.

To address these sources of pollution, USEPA initiated the National Pollution Discharge Elimination System (NPDES) storm water programs. The Phase I program required that major cities with populations greater than 100,000, which had separate storm sewer systems (does not include combined sanitary sewer and/or sanitary sewer systems) must obtain a permit from Ohio EPA by May 1993. In Ohio, only Columbus, Akron, Dayton and Toledo were required to obtain a Phase I permit. The other major cities meeting the population criteria were excluded from these regulations and fall under separate but related combined sewer system regulations.

On December 8, 1999 USEPA adopted regulations that will require many of the remaining cities, villages, urban townships and counties to obtain NPDES Phase II storm water permits. Currently Ohio EPA estimates over 480 local governments across Ohio will be required to obtain a Phase II storm water permit. All affected entities must obtain permit coverage by March 10, 2003. These local governments will be required to develop a storm water management program (the permit is a storm water quality plan for the community) that implements six minimum control measures. The following is a brief description of the Six Minimum Control Measures.

### ***Six Minimum Control Measures***

#### **1. Public Education and Outreach**

Distributing educational materials and performing outreach to inform citizens about the impacts polluted storm water runoff discharges can have on water quality.

#### **2. Public Involvement / Participation**

Providing opportunities for citizens to participate in program development and implementation, including effectively publicizing public hearings and/or encouraging citizen representatives on a storm water management panel.



### **3. Illicit Discharge Detection and Elimination**

Developing and implementing a plan to detect and eliminate illicit discharges to the storm sewer system (includes developing a storm water system map and informing the community about the hazards associated with illegal discharges and improper disposal of wastes).

### **4. Construction Site Runoff**

Developing, implementing and enforcing an erosion and sediment control program for construction activities that disturb one or more acres of land.

### **5. Post-Construction Management**

Develop, implement and enforce a program to address the discharges of post construction storm water runoff from new development. Controls could include protection of sensitive areas (wetlands), or the use of structural Best Management Practices (BMP's).

### **6. Pollution Prevention /Good House Keeping**

Develop and implement a program to prevent or reduce pollutant runoff from municipal operations. The program must include municipal staff training on pollution prevention measures and techniques (e.g., regular street sweeping, reduction in the use of pesticides or street salt, or frequent catch basin cleaning).

## ***Hamilton County Phase II Storm Water Permit***

Hamilton County, Ohio is addressing the EPA Phase II Storm Water Permit as a regional multi-community permit. This means that each community will be a co-permittee to a regional permit that is submitted by the ORC 6117 Regional Sewer District. This Regional Sewer District will perform the "regional tasks" as defined by the permit. The local communities will perform the "local tasks" as defined by the permit. The District will also monitor, develop, and submit the permit document as well as the required annual reports. A copy of one of the interim permit implementation plans is a separate document attached to the end of this paper.

The first part of the study included the development of the permit through the facilitated Steering Committee process. Various permit tasks and levels of service were reviewed by the Steering Committee and a draft permit implementation plan was crafted by the Steering Committee.

The second part of the Study involved the preparation of many of the items required under EPA's Six Minimum Control Measures. Items such as brochures, ordinances, and manuals are being developed in draft form. The District will implement these items. However, the individual communities that participated in the development process can use these materials even if they do not join the District. The products that are being developed are shown in the table below:

**Table No. 1. NPDES Phase II Storm Water Permit Products for the Hamilton County Storm Water Study**

---

<b>1. Public Education</b> <ul style="list-style-type: none"><li>• Brochures &amp; Fact Sheets</li><li>• PowerPoint Slide Presentation</li><li>• Library of Materials</li><li>• Educational Programs</li><li>• Press Information</li></ul>	<b>4. Construction Site Runoff</b> <ul style="list-style-type: none"><li>• Erosion &amp; Sediment Control Ordinance</li><li>• Enforcement Plan</li><li>• Site Review Procedures</li><li>• Proposed Sanctions</li></ul>
<b>2. Public Participation</b> <ul style="list-style-type: none"><li>• Speakers Materials</li><li>• Citizen Watch Group</li><li>• Information Council</li><li>• Hotline</li></ul>	<b>5. Post Construction/Runoff Control</b> <ul style="list-style-type: none"><li>• Model Storm Water Ordinance</li><li>• Draft BMP Manual</li><li>• Inspection Program</li></ul>
<b>3. Illicit Discharge Detection &amp; Elimination</b> <ul style="list-style-type: none"><li>• System Map</li><li>• Illicit Discharge Ordinance</li><li>• Detection Plan</li></ul>	<b>6. Pollution Prevention / Good Housekeeping</b> <ul style="list-style-type: none"><li>• Model Management Plan</li><li>• Facility Management Plan</li></ul>

---

## Funding Legal Organizations

As previously discussed, Hamilton County will use a regional organization to cooperate in the development of a regional NPDES Phase II Storm Water Permit and reduce the cost of development and implementation to the communities. In order for this to be accomplished a legal framework must be available to create the regional district. Two years ago the Ohio State Legislature crafted and passed House Bill 549 that modified ORC 6117 to include Storm Water (along with Water and Sanitary Sewer) and to allow for the collection of fees and charges to operate and maintain the storm water system. This is important because it allows counties in the State of Ohio and all of the communities within the counties to form a regional district that can assess and collect fees and charges to manage storm water similar to an incorporated city.

The Steering Committee made the decision to designate ORC 6117 "County Sewer District" to be the most appropriate legal management structure to address regional storm water management issues throughout Hamilton County. Once this decision was made, the process of selecting the appropriate size and scope of a regional storm water organization was considered.

This process was accomplished by reviewing four "example" programs with different levels of service and the related level of responsibilities for a given cost of service that the new organization would provide. For example, the "*small*" regional storm water organization will only address the NPDES Phase II permit requirements for each of the member communities. No other storm water services will be performed by the small organization. Each local jurisdiction will remain in complete control of managing their respective storm water programs including water quantity. They would also be responsible for local aspects of the Phase II permit such as construction site sediment control, street sweeping, etc.

The "*medium*" regional storm water organization will address the NPDES Phase II permit requirements for each of the member communities (the small organization service level) as described above, as well as a capital improvement program that will address flooding and drainage issues on a regional watershed basis. Staff will coordinate the planning, design, and management of regional capital projects. Capital projects would only be constructed for regional areas of concern. The district will not perform maintenance. The capital program will be designed to address flooding concerns.

The "large/comprehensive" storm water program is an all-inclusive regional and local water quality, water quantity, and floodplain management organization. This metropolitan storm water district would operate, maintain, provide capital construction, and regulate all storm water activities for the district service area. For the most part member communities would give up control of storm water activities. *It should be noted that the limits of local control would be based on the terms of the district's plan of operation and/or agreement with local communities.* The district would perform all planning, design, construction management, plan review, administration, customer service, and billing services.

The program examples met the mission and goals developed by the Steering Committee. Even the low level of service will meet the initial goals of the program. For example, the low level of service option will develop the NPDES Permit and Implementation Plan for the regional district. No other storm water activities will be performed as a part of this level of service. While this "low-end" program meets the mission and goals established by the Steering Committee the extended time-dependent (5-years) portion of the goals are not addressed by this level of service. This does not mean that this level of service will not accomplish the program mission and goals; however, it does mean that the program will be limited to a minimal level of service for a reasonable cost of service.

After careful consideration by the Steering Committee, consensus was achieved and a decision was made to create a small organization with the purpose of administering and coordinating the regional permit and will perform all roles responsibilities and activities associated with the NPDES Phase II program as will be organized as follows:

- Five employees (senior engineer, planner, engineer, GIS specialist and public information specialist)
- Overhead charge of \$12,000 annually
- A 6.2% administrative overhead charge to the County's general fund
- Mapping performed by District in the amount of \$600,000 annually
- At the end of the first five-year permit term, additional staff would be hired for erosion and sediment control and illicit discharge enforcement
- Inflationary cost factors of 2.75% for salaries and 2.90% for benefits
- Other expense cost escalation factors (3%)
- Any known costs that may be experienced by the District over the next five years

The following is a five-year average of the annual costs for the regional organization that will comply with the NPDES Phase II regulations:

**Table No. 2. Hamilton County Regional Storm Water Program Five-Year Cash Flow Analysis** (McKinley, S. (FMSM), Damico J. (ERC), and J. Rozelle (FMSM), 2001-2002. Hamilton County Storm Water Program Issue Papers No. 1-8).

	<b>5 Yr Ave.</b>
<b>Salaries and Fringe Benefits:</b>	
Salaries:	\$264,100
Fringe Benefits:	\$100,700
 Total Salaries and Fringes * :	 <u>\$364,800</u>
<b>Other Expenditures:</b>	
Rent:	\$76,500
Furnishings & Office Equipment:	\$21,200
Overhead:	\$12,700
Accounting Payroll/ General Fund Chg:	\$100,900
Supplies/Materials:	\$21,200
NPDES Phase II Permit Costs:	\$10,600
Public Education Outreach:	\$114,100
MSD Startup Cost Annual Payment:	\$204,000
Print Brochures:	\$10,000
Develop and Maintain Website:	\$6,000
Storm Drain Labeling:	\$10,000
Watershed Signage:	\$5,000
Hotline:	\$10,000
Household Septic System Mgmt:	\$30,000
Sensitive Areas Plan:	\$20,000
Pilot BMP Program:	\$30,000
Dry Weather Screening:	\$15,000
Mapping:	\$637,100
 Total Other Expenditures * :	 <u>\$1,334,300</u>
 <b>Total Expenditures * :</b>	 <u><b>\$1,699,100</b></u>

\* rounded to the nearest \$100

The final cost associated with the small organization and level of service using a five-year average as defined above, will be in the amount of \$1,699,100. This figure equates into approximately \$4.20 per parcel (per household) per year, which meets the financial goal of this regional group to not exceed an initial cost of \$5.00 per household per year for each individual ratepayer developed as part of the strategic planning process. It should be noted that inspection and maintenance issues are the responsibility of the local communities. There is an option for the inspection and maintenance as well as other activities to be added to the district in the future. This increase in level of service must also include an increase in cost of service and the storm water fee.

## Lower Costs Through Regional Cooperation

The National Association of Storm Water Management Agencies (NAFSMA) conducted a survey of communities required to obtain an NPDES Phase I permit (NAFSMA, 1999 "Survey of Storm Water Phase II Communities"). The survey determined that members had expended, on the average, \$ 650,000 per community for the permit application process alone. These costs are based on all Phase I communities complying with the regulations on their own.

Examples of several Phase I communities that have already initiated programs to comply with the NPDES Storm Water Regulations as follows:

**Table No. 3. Examples of Phase I Communities with NPDES Storm Water Regulation Compliance Programs** (NAFSMA - 1996. "Survey of Local Storm Water Utilities").

City	Annual Cost	Cost / Capita
Dayton OH	\$ 3.3 M	\$ 19.86
Louisville, KY	\$ 5.0 M	\$ 7.21
Akron, OH	\$ 5.0 M	\$ 23.04
Toledo, OH	\$ 3.2 M	\$ 10.20

USEPA estimates (based on the NAFSMA Study - "Survey of Storm Water Phase II Communities".) that the annual cost to administer the Phase II program will be cost \$1,525 per municipality for annual reporting and an additional \$9.16 per household per year for all other variable costs. Using this methodology, if all communities within Hamilton County comply individually and ignore a regional approach, it would cost approximately \$3,041,975 (\$74,725 annual reporting + \$2,967,250 variable costs) annually. This compares to the five-year average discussed above, where, if all of the communities join together and develop regionally, the costs to comply with the permit are estimated to in the amount of approximately \$1,699,100 annually, and \$4.20 per parcel (per household) per year. This equates into a cost reduction and economies of scale savings in the amount of approximately \$1,399,300 per year for the entire region and a cost savings to the individual ratepayer of approximately 44% per parcel (per household) per year when compared to the EPA cost of complying estimates. The cost savings assumes that the individual communities have at least minimal storm water programs for quantity and quality and that the local share of the program can be implemented with little or no additional cost. Within Hamilton County there are programs that meet and exceed these minimum requirements and those that do not meet these minimum requirements.

The cost savings can best be expressed using several examples. The first example that is already being implemented is the labeling or marking of storm water catch basins and inlets. If purchased in small numbers (> 20,000 markers) the cost is as much as \$10.00 for each marker. The Mill Creek Watershed Council (with the cooperation of the communities) through the regional efforts is able to purchase markers in large amounts at a little over \$2.00 per marker. The Regional District is planning to provide funding to groups like the Mill Creek Watershed Council to manage programs like the Storm Drain Marking effort.

The second example involves the development of the three ordinances that are required. It is estimated that the cost to develop one of these ordinances is approximately \$10,000, assuming only a moderate amount of

public input and revision. The cost of ordinance development for all 50 Hamilton County would be \$500,000 if each community did it on their own. Another way to look at this is, even if it costs twice as much (\$20,000) to develop an ordinance, the cost per community (if all fifty were to join the District) would be \$400 per community.

The last example is difficult to estimate cost savings at this time. The NPDES Phase II Permit requires all permitted communities to map their storm water system and outfalls. This is one of the most difficult and expensive portions of the permit. For many of the small villages, townships, and cities the development of a storm water map is out of the question, they cannot afford to prepare the map. Their only hope of complying with this part of the regulation is to share the cost of mapping with other communities through the regional district.

## Next Steps

**IV – Steering Committee Recommendations** ( McKinley, S. (FMSM), Damico J. (ERC), and J. Rozelle (FMSM), 2001-2002. Hamilton County Storm Water Program Issue Papers No. 1-8.)

The Steering Committee has developed the following recommendations to the Executive Committee:

- 1) A County-wide Storm Water District should be established to administer the NPDES Phase II Permit.
- 2) The District should initially be staffed with five FTE's including a Senior Storm Water Engineer, Engineer, Public Information Specialist, Planner and GIS Technician.
- 3) The BMP's proposed in the amended Implementation Plan Matrix, including the mapping component, should be used as the basis for the preparation of the Storm Water Management Plan (SWMP).
- 4) Consider implementing a two-tiered rate for mapping costs/requirements to be determined based on standards.
- 5) Initially, the goal should be to establish a storm water fee that does not exceed \$5.00 per household per year, excluding billing and collection costs.
- 6) For those local governments that wish to pass on the storm water fees to individual property owners, an agreement between the County and the local government should so state; and the costs of billing services and fee, *including the cost of collection*, will have to be added to the storm water fee.

## References

- 1) Hedeem, S., and the Rivers Unlimited Mill Creek Restoration Project, 1994. The Mill Creek – An Unnatural History of an Urban Stream.
- 2) McKinley, S. (FMSM), Damico J. (ERC), and J. Rozelle (FMSM), 2001-2002. Hamilton County Storm Water Program Issue Papers No. 1-8.

- 3) Mill Creek Watershed Council, Spring 2002. "Voice of the Mill Creek".
- 4) Mill Creek Watershed Council, Summer 2002. "Voice of the Mill Creek".
- 5) NAFSMA – The National Association of Flood and Stormwater Management Agencies, July 1999. "Survey of Stormwater Phase II Communities".
- 6) NAFSMA – The National Association of Flood and Stormwater Management Agencies, 1996. "Survey of Local Storm Water Utilities".

# **Fish Community Response in a Rapidly Suburbanizing Landscape**

Robert J. Miltner  
Ecological Assessment  
Ohio Environmental Protection Agency  
Groveport, Ohio 43125

Dale White  
Ecological Modeling  
Ohio Environmental Protection Agency  
Columbus, Ohio 43216-1049

Chris Yoder  
Midwest Biodiversity Institute and  
Center for Applied Bioassessment and Biocriteria  
Columbus, Ohio 43221-0561

## **Abstract**

Stream biotic integrity in Ohio shows measurable declines when the amount of urban land use, measured as impervious surfaces, first exceeds 5.3%, and declines below basic Clean Water Act goals when urban land use exceeds 25%. Declining biological integrity was noted in Rocky Fork of Big Walnut, a stream with a rapidly urbanizing watershed in the Columbus metropolitan area, at levels of total urban land use as low as 4%, suggesting that poorly regulated construction practices constitute the first step toward declining stream health in suburbanizing landscapes. The pervasiveness of this finding was evaluated in several streams in the periphery of the Columbus metropolitan area by comparing measures of stream health sampled in 1996 and again in 2002. No declines in biological integrity or numbers of sensitive species were noted between time periods. The rate of urbanization in the surrounding watersheds was less in these streams than in Rocky Fork, and construction site environmental practices were more noticeable than in Rocky Fork. This paper discusses the implications of these findings with respect to current storm water and construction best management practices.

## **Introduction**

Biological integrity in Ohio streams declines along a gradient of urban land use, measured as impervious cover (Yoder et al. 2000, Miltner et al. in review). This finding is from IBI scores for streams draining urban and suburban landscapes in the major metropolitan areas of Ohio paired with an estimate of the percent impervious land cover in the watershed upstream from a sampling point. Yoder et al. (2000) observed in these data that both the number of sensitive species and IBI scores declined with increasing amounts of impervious surfaces; however, declines in the number of sensitive fish species were detectable at lower levels of impervious cover than IBI scores.

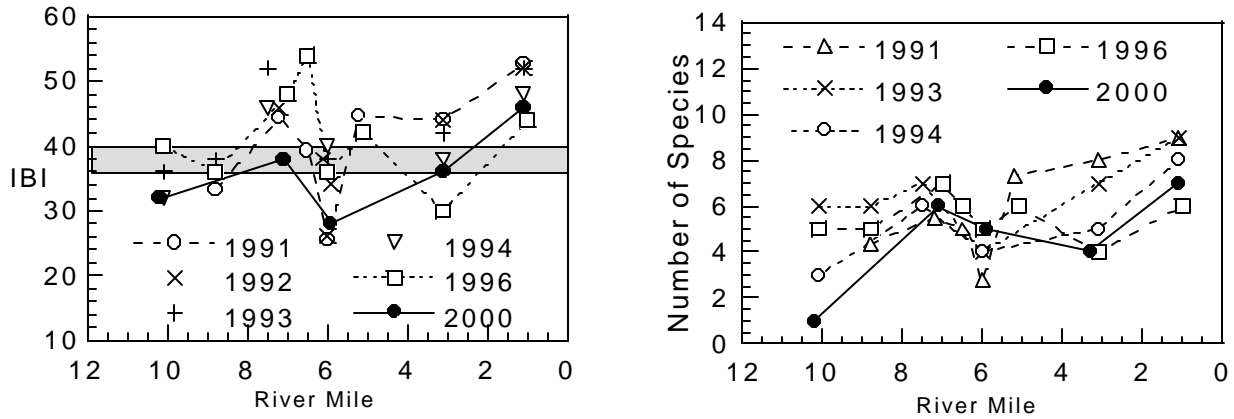


Initial declines in the number of sensitive fish species were detectable when the amount of impervious cover exceeded 5.3%, and overall biotic integrity declined below Clean Water Act goals when impervious cover exceeded 27.1%. Overall loss of biological integrity, as measured by the Index of Biotic Integrity (IBI, Karr 1981), is characterized by shifts in community structure relative to the fish community expected for a given stream size and location.

The results for Ohio are similar to other studies from around North America. The typical result being that the quality of any given stream is negatively correlated with the amount of urbanization in its surrounding watershed (Steedman 1988; Schuler 1994; Wang et al. 1997; Karr and Chu 2000; Wang 2001). Urban runoff carries toxic contaminants (metals, polynuclear aromatic hydrocarbons [Yaun et al. 2001]), nutrients and sediment (Young et al. 1996), pathogens and debris. Impervious surfaces also result in hydrologic and geomorphic alterations to low order streams: increased variance in stream flow, increased stream temperatures, and destabilization of the channel (Bledsoe 2002). Collectively these stressors act to grossly impair biological communities when the range of impervious cover within a watershed reaches 8 to 20 percent (Karr and Chu 2000, Schuler 1994), and become irreparably damaged in the range of 25 to 60 percent (Karr and Chu 2000). Here “grossly impaired” and “irreparably damaged” are in reference to minimum water quality standards (*e.g.*, state narrative or numeric standards for warm-water habitat), and do not necessarily capture the more subtle, but highly consequential, effects evident at low levels of anthropogenic disturbance (Scott and Helfman 2001, Jones et al. 1999). The reason these ranges vary exponentially is that the severity of impairment in urban areas is dependant on the number and type of allied stressors (*e.g.*, combined sewer overflows [CSOs], wastewater discharges, landfills, accidental spills, intentional dumping, and stream channel dredging and filling) associated with urbanization beyond the retinue of hydrological and water quality consequences effected by imperviousness alone (Yoder and Rankin 1996).

Recently, declining biotic integrity was noted in Rocky Fork of Big Walnut (Miltner et al. in review), a stream located in the rapidly suburbanizing Columbus, Ohio metropolitan area. The IBI scores for Rocky Fork fish communities over time are provided in Figure 1. The declining biotic integrity observed in Rocky Fork mirrored what was observed in the static state-wide urban gradient data set as describe above. These declines were attributed to new home and allied infrastructure construction, and likely hastened by the rapid pace of development. Portions of the watershed that were rural in 1990 had been decidedly urbanized by 2000. Conditions were also aggravated due to a lack of meaningful environmental controls on construction sites, and suggest that land disturbance is the initial cause of declining biotic integrity in a suburbanizing landscape.

We wanted to test for declining biotic integrity in several streams on the periphery of the Columbus Metropolitan area that have suburbanizing watersheds to examine whether conditions observed in Rocky Fork could be generalized among similar sized area streams. The streams chosen had all been sampled between 1996 and 1997, and so offered the opportunity to observe whether measurable differences could be detected within five years, and at rates of development modest compared to that observed in the Rocky Fork watershed. This paper discusses our current findings in light of previous findings for urban streams (Yoder et al. 2000, Miltner et al. in review) and potential directions for land-use policies.

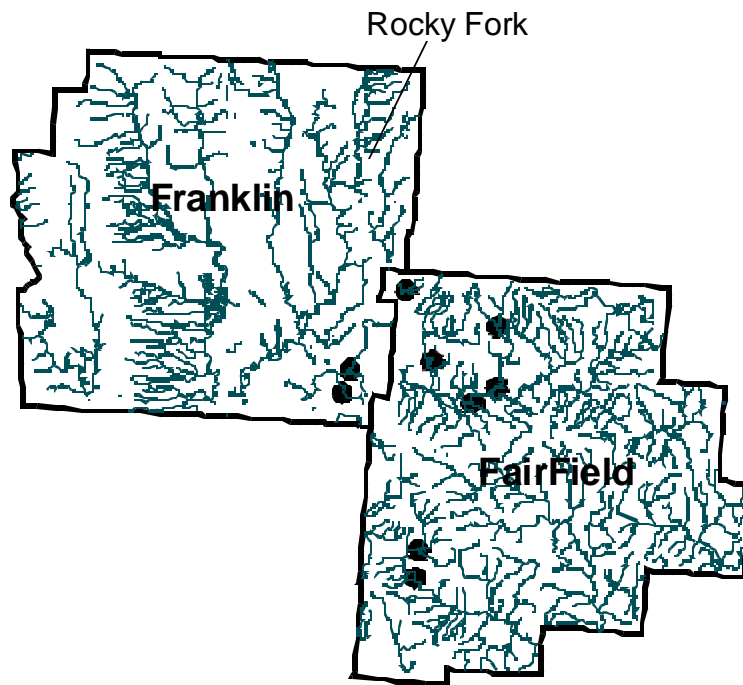


**Figure 1.** Trends in IBI scores (left panel) and the number of sensitive fish species sampled in Rocky Fork, 1991-2000. The shaded bar in the left plot shows the minimum range for acceptable IBI scores for small warm-water Ohio streams.

## Methods

Fish communities were sampled at eight locations in seven streams (Figure 2; Table 1) using generator-powered, pulsed D.C. electrofishing units and a standardized methodology (Yoder and Smith 1999). Fish community attributes were quantified with the Index of Biotic Integrity (IBI; Karr 1981; Karr et al. 1985), as modified for Ohio streams and rivers (Ohio EPA 1987, Yoder and Rankin 1995). Habitat was assessed at all fish sampling locations using the Qualitative Habitat Evaluation Index (QHEI; Rankin 1995). The QHEI is a qualitative, visual assessment of the functional aspects of stream macrohabitats, and includes rankings for such things as amount and type of cover, substrate quality and condition, riparian quality and width, siltation, and channel morphology.

An estimate of urbanization between 1990 and 2000 was made for each sampling location by comparing data from census blocks immediately surrounding and upstream from a sampling location and using housing density as a surrogate for urban land-use. The number of sensitive species and IBI scores sampled at the same locations and for each time period were compared using a two sample t-test. Sample distributions were checked for normality using a normal probability plot. Sample variances between time periods for both IBI scores and number of sensitive fish species were compared using a two-tailed variance ratio test (Zar 1999) and found equal ( $F_{1-\alpha/2, 9, 9} = 4.03$ , > ratio of variances for IBI scores and number of sensitive fish species was 52.778/42.000 and 4.528/2.444, respectively).



**Figure 2.** Study area and locations sampled in 2002. Rocky Fork is located for reference.

**Table 1.** Change in housing density (units•mi<sup>2</sup>) in census blocks surrounding and upstream from stream sampling locations.

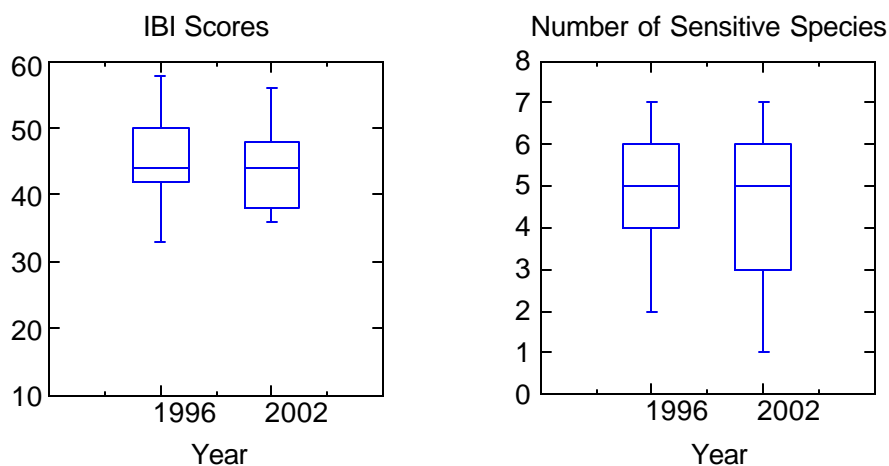
Stream Name	Location	Drain Area (mi <sup>2</sup> )	Housing Density 1990	Housing Density 2000	Percent Change	IBI 1996	IBI 2002	QHEI
Clear Creek	Dst US 22, Amanda Twp.	19.7	25.80	29.61	15	50	38	58.5
Poplar Creek 2	Poplar Cr. Rd., Liberty Twp.	8.1	48.32	55.73	15	58	56	76.0
Poplar Creek 1	Bish Rd., Liberty Twp.	17.5	48.32	55.73	15	42	48	79.5
Muddy Prairie Creek	Amanda-Northern Rd., Amanda Twp.	3.8	25.80	29.61	15	52	42	41.5
Sycamore Creek	Busey Rd., Violet Twp.	21.6	176.67	301.40	71	44	44	78.5
Big Run	Hayes Rd., Madison Twp.	6.3	95.78	172.38	80	46	38	56.0
George Creek	Groveport Rd., Madison Twp.	15.4	95.78	172.38	80	40	44	61.0
Blacklick trib 10.36	SR 256, Violet Twp.	2.9	153.19	281.76	84	44	50	71.0
Rocky Fork 3.1*	Clark Rd., Jefferson Twp.	22.4	57.10	202.50	254	30	NA	66.0

\* Rocky Fork was not sampled in 2002.

## Results and Discussion

In contrast to what was observed in Rocky Fork (Figure 1), no differences ( $P > 0.05$ ) were found in either the number of sensitive species at a given site, nor for IBI scores at the eight study sites (Figure 2; Table 1), most notably at the two sites that had the greatest rate of increase in housing density between 1990 and 2000, Blacklick trib 10.36 and Sycamore Creek. One explanation for this observation is that the level of urban land use in each of the eight study sites is estimated at less than 5%, except for Blacklick trib 10.36 where the level of urban land-use from the 1994 Landsat Thematic Mapper Data was 7%. Also, the rate of change in housing density in all cases is less than that observed in Rocky Fork (Table 1). Another difference, though not directly quantified, is that proper construction site environmental practices were observed in Fairfield County where six of the eight samples were collected (Figure 2). Fairfield County has storm water and construction site regulations requiring environmental measures, and performs regular inspections for compliance through the local Soil and Water Conservation District (Fairfield County SWCD, personal communication, Chad Lucht). Environmental measures to mitigate construction site impacts were rarely observed in the Rocky Fork watershed (Figure 3).

Water resources can be impacted by land development. Whether that is because existing regulations are under-enforced or are under-protective is an open question. Regulations vary widely between political jurisdictions. In Ohio, a general storm water construction permit that is applicable state-wide requires best management practices (BMPs) to minimize sediment loads. Temporary stabilization is one such BMP wherein disturbed areas that will lie dormant for at least 45 days must be stabilized with fast growing grasses and straw mulch within seven days, or within two days if within 50 feet of a stream. Other required BMPs include sediment ponds, silt fences, construction entrances, inlet protection, and permanent stabilization. This basic level of protection is augmented by stricter regulations and enforcement in some Ohio counties, such as Fairfield County.



**Figure 3.** Distributions of IBI scores (left panel) and number of sensitive fish species (right panel) sampled at the same location in 1996 and 2002 in seven streams located in the periphery of the Columbus, Ohio metropolitan area.

Other states have been more aggressive in regulating nonpoint pollution. Storm water protection in the State of Maryland is administered through local governance with state oversight. For example, Baltimore County has a stream protection ordinance that calls for a forested buffer to extend on both sides of a stream and to include the adjacent floodplain, slopes, and wetlands. And wherever development may adversely affect water quality, the buffer can be extended to protect steep slopes, erodible soils and other sensitive areas. This is in addition to the fourteen general performance standards for storm water management applicable throughout Maryland (Maryland Department of the Environment 2000, and available at [http://www.mde.state.md.us/programs/waterprograms/sedimentandstormwater/stormwater\\_design/index.asp](http://www.mde.state.md.us/programs/waterprograms/sedimentandstormwater/stormwater_design/index.asp)). These performance standards go beyond simply minimizing the amount of sediment from construction sites by striving to maintain the pre-disturbance hydrology of the watershed including groundwater recharge, stream channel stability, and peak discharge volume. Compliance with local storm water regulations is encouraged through performance bonds. A performance bond is bond issued to a contractor or other responsible party conducting land development, forfeiture of which is risked if the party does not comply with the terms of the bond (*i.e.*, performance standards). Wisconsin has recently enacted sweeping state-wide regulations governing both urban and agricultural nonpoint pollution.

The realization of environmental consequences from land development has brought environmental considerations to the fore as evidenced by model “smart growth” legislation proposed by the American Planning Association (2002), and as enacted in Maryland and Wisconsin. Aggressive regulation and follow-up enforcement is needed to address water quality impacts associated with land development, but finite limits on development must also be an integral component of any future land use planning and regulatory framework. Significant numbers of sensitive species are lost at relatively low levels of impervious cover, suggesting that the upper limit of urban land use for the highest quality watersheds is about 5%. This argues strongly for no net gains in impervious cover in some watersheds. However, for less sensitive waterbodies, aggressive regulations that protect riparian buffers and preserve much of the pre-development hydrology may be effective at maintaining aquatic life uses consistent with basic Clean Water Act goals at comparatively high levels of urban land use. Such regulations should include performance standards analogous to those for Maryland. More specifically, they should minimize the loss of pervious cover, manage and treat stormwater runoff to remove pollutants, retain stormwater and promote infiltration to maintain groundwater recharge and stream base-flow, and pre- and post development peak discharge should remain similar to protect stream channels. The level of urban land-use that can be reached and stream biotic integrity maintained under a regimen of aggressive protection is currently unknown, but may go as high 50%. For example, from our previous study of state-wide urban gradient sites (Yoder et al. 2000), sites that maintain good IBI scores at impervious cover greater than 30% have either intact riparian zones and undeveloped floodplains, or have high sustained base-flows relative to their drainage area. Also, Steedman (1988) found that an intact riparian zone of 20 m width was important in mitigating effects of urban land use on aquatic life in Toronto area streams.

In summary, the cause and effect relationship between increasing land development and decreasing stream quality is clear and abundantly demonstrated. For future land development to be sustainable, finite, watershed-specific limits to development must be defined, land use planning must consider the ecological aspects of the landscape and allocate development accordingly, and state and local governments must adopt rigorously protective environmental regulations governing land development.



**Figure 4.** Construction sites observed in the rapidly suburbanizing Columbus, Ohio metropolitan area. Upper left, a construction site in the Rocky Fork watershed; the exposed soil is supposed to be stabilized with straw and seeded with grass. Upper right, another tributary bulldozed for new construction. Lower picture, a construction site in Fairfield County instituting proper environmental controls including silt fencing and a settling pond.

## Acknowledgments

The authors thank all the staff of the Ecological Assessment Section of the Ohio Environmental Protection Agency. The comments of two anonymous reviewers greatly improved this manuscript.

## References

- American Planning Association. 2002. Growing Smart Legislative Guidebook: Model Statutes for Planning and the Management of Change. Edited by Stuart Meck. American Planning Association, Washington, D.C.
- Bledsoe, B. P. 2001. Relationships of stream responses to hydrologic changes. *In Linking Stormwater BMP Designs and Performance to Receiving Water Impact Mitigation: Proceedings of an Engineering Foundation Conference, August 19-24, 2001, Snowmass Village, Colorado, pp.127-144.* Edited by Ben R. Urbonas. United Engineering Foundation, Environmental and Water Resources Institute of ASCE.
- Jones, E. B. D., III, Helfman, G. S., Harper, J. O. and Bolstad, P. V. 1999. The effects of riparian deforestation on fish assemblages in southern Appalachian streams. *Conservation Biology* 13: 1454-1465.
- Karr J. R. 1981. Assessment of biotic integrity using fish communities. *Fisheries* 6: 21-27.
- Karr J. R., Heidinger R. C. & Helmer E. H. (1985) Effects of chlorine and ammonia from wastewater treatment facilities on biotic integrity. *Journal of the Water Pollution Control Federation*, 57, 912-915.
- Karr J. R., and Chu, E. W. 2000. Sustaining living rivers. *Hydrobiologia* 422/423: 1-14.
- Maryland Department of the Environment. 2000. 2000 Maryland storm water design manual, Volumes I and II. Center for Watershed Protection and the Maryland Department of the Environment. Water Management Administration, Baltimore.
- Miltner, R. J., White, D., and Chris O. Yoder. In review. The biotic integrity of streams in urban and suburbanizing landscapes. *Landscape and Urban Planning*.
- Ohio Environmental Protection Agency. 1987. Users Manual for Biological Field Assessment of Ohio Surface Waters, Vol II. Division of Surface Water, Columbus, Ohio.
- Rankin E. T. 1995. Habitat indices in water resource quality assessments. *In Biological Assessment and Criteria, Tools for Water Resource Planning, pp.181-208.* Edited by W. S. Davis and T. P. Simon. Lewis Publishers, Boca Raton, Florida.
- Schuler, T. R. 1994. The importance of imperviousness. *Watershed Protection Techniques* 1: 100-111.
- Scott, M. C., and G. S. Helfman. 2001. Native invasions, homogenization, and the mismeasure of integrity of fish assemblages. *Fisheries* 26: 6-15.



- Steedman, R. J. 1988. Modification and assessment of an Index of Biotic Integrity to quantify stream quality in southern Ontario. *Canadian Journal of Fisheries and Aquatic Sciences* 45: 492-501.
- Wang, L., Lyons, J., Kanehl, P. and Gatti, R. 1997. Influences of watershed land use on habitat quality and biotic integrity in Wisconsin streams. *Fisheries* 22: 6-12.
- Wang, X. 2001. Integrating water-quality management and land-use planning in a watershed context. *Journal of Environmental Management* 61: 25–36.
- Yoder C. O. & Rankin E. T. 1995. Biological criteria program development and implementation in Ohio. *In* *Biological Assessment and Criteria, Tools for Water Resource Planning*, pp.109-144. Edited by W. S. Davis and T. P. Simon. Lewis Publishers, Boca Raton, Florida.
- Yoder, C. O., and Smith, M. A. 1999. Using fish assemblages in a state biological assessment and criteria program: Essential concepts and considerations. *In* *Assessing the Sustainability and Biological Integrity of Water Resources Using Fish Communities*, pp.17-56. Edited by T. P. Simon. CRC Press, Boca Raton, FL.
- Yoder, C. O., Miltner, R. J., and D. White. 2000. Using biological criteria to assess and classify urban streams and develop improved landscape indicators, pp. 32 - 44. in S. Minamyer, J. Dye, and S. Wilson (eds.), *National Conference on Tools for Urban Water Resource Management and Protection*. U.S. EPA, Office of Research and Development, Cincinnati, Ohio. EPA/625/R-00/001.
- Young, W. J., Marston, F. M., Davis, J. R. 1996. Nutrient exports and land use in Australian catchments. *Journal of Environmental Management* 47: 165-183.
- Yuan, Y., Hall, K., and Oldham, C. 2001. A preliminary model for predicting heavy metal contaminant loading from an urban catchment. *The Science of the Total Environment* 226: 299-307.
- Zar, J. H. 1999. *Biostatistical Analysis*. Prentice Hall, Upper Saddle River, New Jersey.

# ELEMENTS OF SUCCESSFUL STORMWATER OUTREACH AND EDUCATION

Catherine Neiswender  
University of Wisconsin-Extension  
Madison, WI

Robin Shepard  
Wisconsin Extension Water Quality Coordinator  
University of Wisconsin  
Madison, WI

## **Abstract**

Population growth, residential and industrial development, and the resulting increase in impervious surfaces have led to stormwater quality and quantity concerns and related habitat and fiscal issues. To effectively manage such issues, stormwater professionals are finding it necessary to develop community support through implementation of education strategies. This need arises not only from the regulatory requirements of EPA Phase II Stormwater rules, but also from the recognition that local decision makers, citizens and elected officials will require more than a rudimentary grasp of stormwater pollution concerns in order to make effective decisions that will have a positive impact on stormwater issues.

Throughout EPA Region 5, the University Cooperative Extension System is playing a strong role in developing effective, outcomes-based stormwater education and outreach programs that not only meet the federal requirements, but also the needs of the communities they serve. This paper will highlight some of the successful stormwater education and outreach programs that Cooperative Extension is involved in and describe its role in building the capacity of decision-makers. Elements of successful stormwater education programs will also be highlighted.

## **Situation Statement**

Like many regions in the country, states in the Midwest are experiencing some areas with rapidly growing populations and accompanying development pressures. Population growth has spurred industrial, commercial and residential development not only around the major metropolitan areas, but also in the surrounding agricultural landscapes as well. For example, Ohio, which ranks as the 5<sup>th</sup> most populated state nationally, is experiencing land development rates (in acres) 4.7 times faster than its population increase (Lawrence, 2002). The resulting increase in impervious surface has led to stormwater quality and quantity concerns and related habitat and fiscal issues.

To effectively manage such issues, stormwater professionals are finding it necessary to develop community support through implementation of education strategies. The need to develop a knowledge base arises not only from the regulatory requirements in EPA Phase II Stormwater Rules, but also from the recognition that elected and appointed officials may have little incentive to prevent stormwater problems from escalating unless they have a rudimentary understanding of stormwater concerns and solutions.

Two critical elements of Stormwater Management plans are the development and implementation of an educational plan and public participation.

In the 6 states in EPA Region 5 (Minnesota, Wisconsin, Illinois, Indiana, Michigan and Ohio), over 1,800 communities are required by the Phase II Stormwater Rule to obtain a stormwater permit and develop a stormwater management plan (Federal Register, 1999). Developing educational and public participation strategies for all of these communities requires creative partnerships to not only meet the stormwater requirements, but more importantly to ensure that stormwater programs are effective in reducing pollution and improving water quality. The U.S. Environmental Protection Agency (EPA) has identified the importance of informing and educating municipalities, the construction trades, professional service providers, and citizens about storm water pollution. Control of stormwater pollution is most effectively implemented when people and organizations understand the impact of stormwater pollution, its sources, and the actions they can take to control it (Dane County, 2003).

University Extension Systems in many of the Midwestern states are involved in and taking a lead role in developing education programs to address stormwater and urban water quality issues. These programs are conducted at several scales including regional, statewide, local or watershed, and metropolitan area. These programs encompass several key elements for successful educational programming. Programs from three states, and successful educational program elements, will be highlighted below.

## **Highlighted State Programs**

### ***Ohio***

Ohio's statewide program goes well beyond efforts required by stormwater regulations and finds its foundations in long-term watershed work that has occurred over the past decades in the state. Ohio's statewide Nonpoint Source Education for Municipal Officials (NEMO) program encompasses a broad partnership of agencies, with educational efforts led by the Ohio State University Extension (OSUE). The Ohio NEMO program attacks a broad range of land use related water issues including stormwater, source water and general natural resources based land use planning. Modeled after the National NEMO program, the Ohio version is a non-regulatory research based educational program that addresses NPS pollution and its link to different land uses, particularly impervious surfaces and, transport and concentration of pollutants in stormwater. The Ohio NEMO program is a multi-level education program that involves 5 OSU Extension Watershed Agents and several partner agencies for statewide delivery of educational programs that meet the needs of agency staff, watershed groups, and local officials who are facing rapid urban expansion into traditional agricultural areas.

The NEMO program also works to continue delivery of education as the constant turnover of local township trustees, county commissioners and zoning board officials highlight the need to keep these decision makers aware of the ramifications of land use impacts on water quality. The goals of the program, which expand beyond stormwater education needs, are to increase public participation in water resources decision making processes, and increase collaborative efforts of citizens and local decision makers in both development and implementation of watershed action plans and source water protection plans.

OSUE faculty have several roles in the NEMO program. In addition to providing overall coordination and leadership, OSUE augments local education efforts with materials, slide shows and more importantly, educators that have knowledge expertise in stormwater and natural resources planning as well as skills in facilitation and teaching strategies.

Successful elements of the NEMO program which lend themselves to effective outreach and education programs include the systematic approach to address the turnover of local decision makers and the

interconnection of stormwater with other natural resources planning efforts. For example, since the beginning of the program, 80 professional staff have participated in training sessions on the use of NEMO materials with local officials and watershed groups. These staff are then available to provide ongoing training to new decision makers when turnover occurs (Lawrence, 2002).

### ***Wisconsin***

University of Wisconsin Extension (UWEX) faculty are involved in several stormwater education initiatives throughout the state. In Dane County, 19 communities came together to develop a joint Information and Education Plan and hire a half time education specialist to implement the plan. UWEX faculty provided information to communities on why education is important and how to develop an education plan. This work built community support and led to the development of an agreement to set aside funding to support development of a Plan, hire the stormwater educator and provide \$10,000 of annual funding for program implementation. UWEX also facilitated the process of developing the Information and Education Plan with a committee of representatives from the 19 communities and Department of Natural Resources. The stakeholder committee first developed educational goals and UWEX was able to bring their expertise in proven outcomes-based educational strategies to bear on these goals. This included identifying and ranking target audiences and subsequently prioritizing educational objectives for each of the specific audiences. UWEX also played a significant role in writing the final Plan document.

Successful elements of this approach include the identification of what the educational program efforts are to achieve (i.e. the goals) and the target audience. This approach prevents the scatter-shot effect of random educational efforts that are difficult to prove whether they have had an impact or not. Another successful element of this effort includes a significant evaluation component funded by a separate grant. A pre-assessment survey will be delivered to 500 residents in the communities to assess perceptions, behavior and willingness to change behavior. After five years, a post-assessment survey will be administered to evaluate the effectiveness of the stormwater program. Additionally, each major educational programming effort will be evaluated to ensure that it is having the desired affect on changing people's behavior (Wade, 2002).

A related effort in Dane County was the development of a public participation process for their stormwater ordinances. The UWEX role included working with specialists and engineers to develop the ordinance, then providing outreach to local government units about the ordinance, and providing technical workshops for engineers and consulting firms. A key UWEX role was to involve a wide variety of stakeholders early in the ordinance development process and ensure their time and skills were well utilized. They enabled the ordinance information to be re-packaged for the various audiences they were targeting. They also encouraged public participation prior to ordinance development so that concerns were brought out early in the process (Habecker, 2002).

A third educational initiative in Wisconsin occurred in the Fox Valley in the northeast region of the state. This more traditional educational initiative included regional stormwater conferences and workshops on a variety of regulatory and technical stormwater topics; a county-based stormwater management plan development process; and a high school youth based stormwater monitoring project. UWEX faculty and staff play key leadership roles in developing and implementing these programs. These three nested initiatives focused on targeting the various audiences, while linking education with technical expertise to ensure audiences were able to understand the complex nature of stormwater management alternatives to make the best decisions (Koles and Neiswender, 2002).

## ***Minnesota***

The University of Minnesota Extension (UMNEX) is extensively involved in the Metro Water Quality Education Program in the Twin Cities (St. Paul and Minneapolis) metro area. This program, which is a partnership of several agencies, targets educational programs to citizens, industry and local decision makers. Several deliverable programs focus on lawn care, volunteer stream monitoring, wetland evaluation, NEMO and Phase II Stormwater Education. Since Metro area water quality education involves a host of other organizations, departments and agencies, the UMNEX plays a lead role in coordinating educational efforts of these entities to create both efficient and effective educational programs. UMNEX also helps the groups enhance their efforts by pooling financial and institutional resources leading to less expensive educational programming, more consistent information and greater educational impacts.

A new initiative in the Metro area will focus on lawn, garden and home practices that improve urban stormwater quality. This new educational program will target homeowners and public property managers and have an accompanying evaluation plan that will evaluate short and medium-term outcomes of the educational initiatives (Struss, 2002).

## **Role of Cooperative Extension**

This sampling of education initiatives throughout the Great Lakes region emphasizes the value of a proactive approach to building education into the development of stormwater management programs. The University Extension System has played key lead roles in these examples, which are ultimately all highly collaborative with other partners. These programs elevate the importance of education to the same level of importance as the engineering, modeling and monitoring work that must also go into development of a stormwater plan. Many of our clean water goals will only be met through the individual actions of citizens, construction crews, and local decision makers – actions that require targeted educational programs to change these behaviors.

University Extension faculty have the education and process skills that lend themselves well to stormwater programs. In these examples Extension faculty have acted as educators for a variety of audiences including local government decision makers; facilitators of meetings and processes that lead to the development of educational strategies and sound decisions; specialists in outcomes-based educational program development; authors of educational plans; and conveners of broad collaborative groups during various stages of stormwater plan development.

## **Successful Education Elements**

There is some feeling that regulation and enforcement should be the main tools to accomplish clean water goals, instead of education. However, past programs that relied solely on enforcement or monetary incentives have not been successful. Research in Milwaukee, Wisconsin showed that a strong education program must complement other means - especially when enforcement is spotty, penalties are light and the audience is vast and widespread. Education programs can often be under funded or eliminated as an element of a comprehensive stormwater management program. Therefore it is critical that anytime an education program is developed, it must be effective and justify the resources and time used to implement the program (Dane County, 2003).

Several elements of success are presented here to help communities, educators and program managers build effective education programs. These elements are drawn from several stormwater and urban water quality education programs throughout the upper Midwest that have leadership by or involvement of the University

of Extension System in the state. The definition of success will vary from program to program, but generally speaking, a successful education program is one that targets its audience and achieves the desired outcomes and behavior changes. Likewise, success also includes elements of efficiency and sustainability.

These elements are:

- ❖ Going beyond ‘awareness’ – using outcomes-based educational principles
- ❖ Audience targeting – particularly decision-makers
- ❖ Partnering educators with technical expertise
- ❖ Incorporating stormwater into other natural resources and land use planning efforts
- ❖ Using public participation effectively
- ❖ Coordination of multi-jurisdictional efforts to effectively use education dollars
- ❖ Evaluation strategies

### ***Outcomes-Based Education***

A large body of research describes education principles, communication science and current learning theory and their application to environmental and community-based projects (see for example Rice and Atkin, 2001; Rogers, 1995). Addressing complex environmental issues, such as stormwater management, requires a combination of technical programs, best management practices and a vigorous and targeted education strategy. Without effective education programs, best management implementation is often only done by the early adopters. Effective education programs are ones that apply the outcomes-based principles of situation analysis, audience targeting, and a focus on the desired behavior changes, not the ‘products’ of a typical outreach or public relations program. Social marketing theory and research points to flaws in traditional single-media educational campaigns and their inability to target key audiences (Earle, 2000; Shepard, 1999; Hill, 1996). However, this research has not been incorporated enough into development of outreach programs for environmental programs. For this reason, these outreach programs become little more than public relations efforts relying too much on mass media, and as a consequence too often fail to achieve meaningful behavior changes.

The University Extension System has long practiced outcome-based education in its programming efforts (Seevers, et al. 1997). These methods rely on developing locally driven programs with the audience in mind, integrating research and knowledge to improve understanding and decision making, and focusing on desired outcomes (Scarborough et al., 1997; Van den Ban and Hawkins, 1996). These principles are regularly applied to a wide array of Extension programming and can be successfully applied to stormwater programs as well. See Figure 1 for a diagram of Program Development and Evaluation method that is based on outcomes-based education principles.

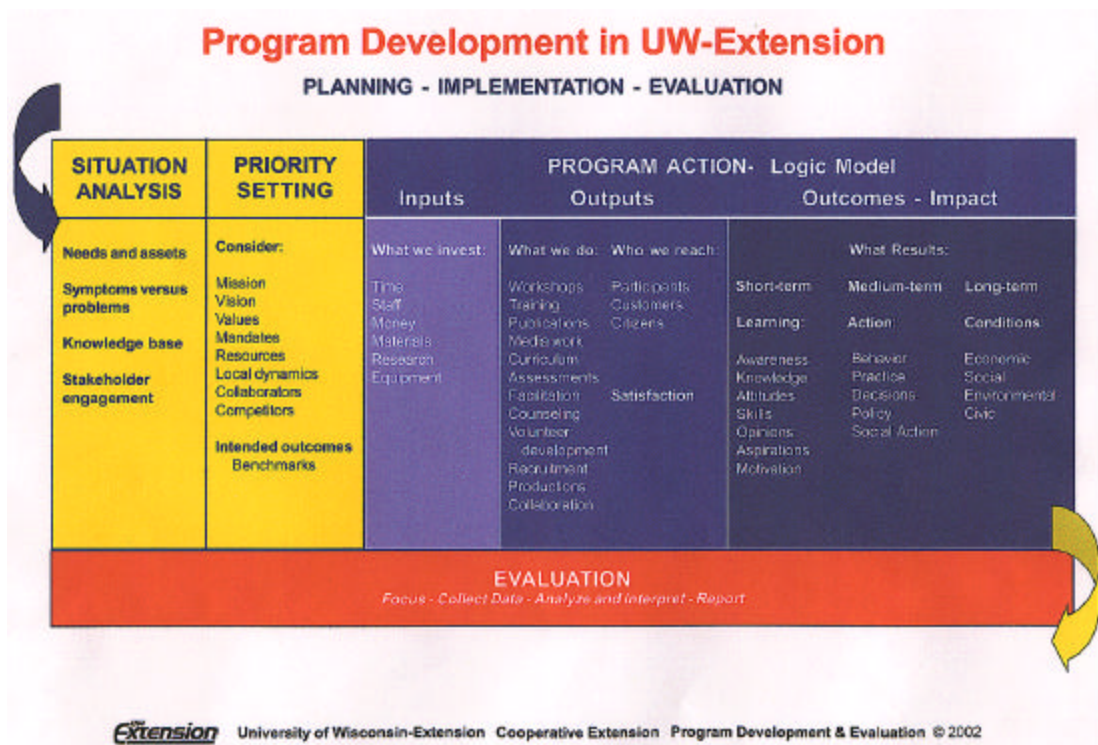


Figure 1. UW-Extension Program Development Model

Using outcomes-based education principles means focusing on desired outcomes of your educational program (i.e., behavior change), not just the immediate outputs (i.e., factsheets, workshops and billboards). Programs must go beyond making people aware of the problem and rather should focus on changing critical behaviors. Though glossy publications are attractive, do they really lead to the behavior changes needed to meet the water quality goals of the stormwater plan? Outcomes based education uses several social marketing concepts to be successful, including 1) asking for a commitment from the audience, 2) placing specific behavior prompts near behavior, 3) communicating the norm, and 4) removing barriers to desired behavior (Dane County, 2003). An example of outcomes-based education is illustrated by Ohio's NEMO program. A desired outcome of the educational initiative was the adoption of stormwater principles into regulations and policies – an important behavior change by local officials that ultimately leads toward the improvement of environmental quality. The program highlights several communities that adopted stormwater management principles, due in part as a result of the Ohio NEMO educational programming they participated in.

In Wisconsin, 19 communities in and around Dane County formed a committee to develop a joint Information and Education Plan for their stormwater permit application. Specific behaviors that would affect water quality change were identified and prioritized based on their potential impact to change water quality. For example, controlling construction erosion in this rapidly developing area was identified as a key issue; desired behavior changes included implementing specific Best Management Practices. The 19 communities deliberately worked to develop and prioritize strategies that will focus on these outcomes.

Also in Wisconsin, in the rapidly developing Fox Valley a county and regional education strategy was developed. It focused on the desired behavior change of local decision makers to develop policy and effectively apply tools and technologies to their stormwater programs. Positive outcomes of this

educational strategy included the adoption of new stormwater and construction site erosion control ordinances and commitment of a county revolving loan fund to support better stormwater management.

### ***Audience Targeting***

Targeting the audience is critical to effective education programs. Focusing on desired behavior change requires the educator to focus on a specific collection of people that will do that behavior change. In Wisconsin, a joint Information and Education plan identifies three types of audiences for their efforts, 1) those that must act (elected officials, homeowners, business owners, developers), 2) those that must support change (conservation groups, civic organizations, media and concerned citizens) and 3) those who are future supporters and actors (youth, teachers) (Dane County, 2003). In Ohio, their NEMO program targets decision makers and recognizes in particular that local officials and decision makers have high turnover rates and a process must be in place to educate new decision makers as change of leadership occurs. A cadre of professional staff have been trained to provide continuous support as this audience turns over periodically.

### ***Partnering Education with Technical Expertise***

It is critical to engage the technical expertise of consultants and engineers when developing and implementing stormwater education programs. For many aspects of stormwater management, the devil is in the details, and the stormwater professional is the most appropriate person to help address technical questions and provide analysis of options. During the county Stormwater Technical Advisory Committee process in WI, the technical engineers regularly paired up with the Extension educator to present detailed concepts and alternatives to their audience. The best role of the educator is to work with the technical experts to communicate the technical messages to a variety of audiences in understandable ways (Koles and Neiswender 2002).

### ***Incorporating Stormwater into Natural Resources planning processes***

Stormwater management fits logically into other natural resources and land use planning efforts. Often the same measures taken to protect natural resources and manage sprawl (such as conservation design, and reducing impervious surfaces) serve the dual purpose to protect stormwater infiltration areas like wetlands and vegetated areas, foster on-site treatment and infiltration and reduce runoff via traditional curb and gutter designs. Multi-agency coordination will strengthen the ability of planners to integrate various natural resources and land-use planning elements together.

The Ohio NEMO program highlights the interconnections between stormwater and natural resources management planning and works with local government officials to build their capacity to integrate these programs.

### ***Public Participation***

Public participation is one of the 6 minimum measures of a stormwater plan and when done correctly, can build the support needed to fund and implement changes that will affect nearly everyone in the community. In Dane County, WI a public participation plan was developed prior to the development of the stormwater ordinance. The public was engaged to help design the ordinance by providing the parameters and guidelines. A team of specialists then developed the technical specifications to meet these criteria. The use of public participation prior to ordinance development enabled the county to minimize potential conflict resulting from ordinance changes.



### ***Coordination of multi-jurisdictional and multi-agency efforts***

Efficiencies can be gained by coordinating educational efforts and messages and pooling educational dollars. Several examples exist. In Minnesota, the Metro area of Minneapolis-St. Paul recognizes that county tax dollars and university resources are most effectively used when there is coordination among the host of organizations that have an educational role or need. In Wisconsin, the 19 municipalities in Dane County all pooled their local resources to fund a joint stormwater educator position that would serve all of the communities. Additionally, Ohio's Stormwater Task Force, comprised of several local and state agencies, consultants and environmental groups, guides implementation of Phase II in Ohio and coordinates educational activities across agencies.

### ***Evaluation***

To know that scarce education dollars are spent well and desired behaviors are changed, it is important to evaluate educational programs. Evaluation measures a variety of outcome data against the program's intent (Bennett and Rockwell, 1995). Evaluation should occur for short, medium and long-term desired outcomes to ensure the educational program is on track.

The Metro Educational program in Minnesota and the Dane County Joint Education Plan in Wisconsin are excellent examples of educational initiatives that have built in an evaluation plan at the beginning of the effort. In Dane County a scientifically designed pre-assessment survey will be delivered to 500 residents in the communities to assess perceptions, behavior and willingness to change behavior. After five years, a post-assessment survey will be administered to evaluate the effectiveness of the stormwater program.

### ***Conclusion***

The success of these education approaches does not mean the stormwater learning needs will subside. On the contrary, enhanced regulatory measures, continued growth, and related environmental factors are effectively increasing the demand for quality outreach education. The expectation that individual and collective behavior changes will improve stormwater quantity control and quality necessitates continuous, multi-tiered, education strategies.

The authors encourage stormwater professionals and educators to use outcomes-based educational principles when developing their education strategies. Additionally, professional facilitation and process skills are critical to development of educational plans and public participation initiatives required by the new stormwater rules. The University Extension System has expertise in these areas and in many places is working with or taking the lead on stormwater educational programming and collaboration.

Such programs are critical to achieving desired results and behavior changes that will have a positive impact on stormwater quality and quantity. The authors challenge states and communities to consider stormwater educational programming a valid and serious part of their overall stormwater management plan and design strategies that are targeted to local situations.

### ***For more information***

For more information on the programs described above contact the author at [catherine.neiswender@ces.uwex.edu](mailto:catherine.neiswender@ces.uwex.edu). The Ohio NEMO program is found on the web at <http://nemo.osu.edu>. A listing of University Extension Water Quality contacts is available at <http://www.usawaterquality.org/contacts/WQCDirectory.pdf>.

## References

- Bennett, C., & Rockwell, K. (1995). Targeting outcomes of programs (TOP): An integrated approach to planning and evaluation. From: <http://deal.unl.edu/TOP/>
- Dane County, WI, 2003. Draft Joint Stormwater Permit Group Information and Education Plan, A stormwater Information and Education Plan for 19 Dane County Municipalities, in draft.
- Earle, R., 2000. The Art of Cause Marketing. Lincolnwood, IL: NTC Business Books.
- Federal Register, 1999. Appendix 6 & 7, Volume 64, No. 235, pages 68812-68837.
- Habecker, M., 2002. Dane County University of Wisconsin-Extension. Personal Communication.
- Hill, R.P., 1996. Marketing and Consumer Research in the Public Interest. Thousand Oaks, CA: Sage.
- Koles, M. and C. Neiswender, 2002. University of Wisconsin-Extension Steps up to the Plate for Stormwater Education, P103-PUB, StormCon Conference, August 2002, San Marcos, Florida.
- Lawrence, T., 2002. University of Ohio Extension. Personal Communication.
- Rice, R., and C. Atkin, 2001. Public Communication Campaigns, 3<sup>rd</sup>. Ed. Thousand Oaks, CA: Sage.
- Rogers, E.M., 1995. The Diffusion of Innovations, 4<sup>th</sup> Ed. New York: Free Press.
- Scarborough, V., Killough, S., Johnson, D., and J. Farrington (Eds.), 1997. Farmer-led Extension. Intermediate Technology Publications, Ltd.: London.
- Seevers, B., Graham, D., Gamon, J. and N. Conklin, 1997. Education through Cooperative Extension. Delmar: Albany, NY.
- Shepard, R.L., 1999. Taking Aim in Water Quality Education: Designing Audience-Specific Programs. In Proceedings of the Sixth National Watershed Conference, Austin TX: Water Environment Federation.
- Struss, R., 2002. University of Minnesota Extension. Personal Communication.
- Van den Ban, A.W. and H.S. Hawkins, 1996. Agricultural Extension (2nd ed.). Blackwell Science Ltd.: Cambridge, Massachusetts.
- Wade, S., 2002. University of Wisconsin-Extension. Personal Communication.

# **A CONSERVATION PLAN FOR THREE WATERSHEDS WITHIN THE MILWAUKEE METROPOLITAN SEWERAGE DISTRICT (MMSD)**

By Mark J. O'Leary, Applied Ecological Service, Inc.  
Doug J. Eppich, Applied Ecological Services, Inc.  
Peg Kohring, The Conservation Fund  
Steve Apfelbaum, Applied Ecological Services, Inc.

## **Abstract**

Previous watercourse studies completed for the Menomonee River, Oak Creek, and Root River have indicated that demographic and community development trends over the next 20 years will exacerbate flooding problems within these watersheds. These studies have provided recommendations for traditional, engineered strategies to combat flooding; and they have acknowledged the importance of maintaining existing open space to prevent future flooding. As a result, the Milwaukee Metropolitan Sewerage District (MMSD) retained a team led by The Conservation Fund to develop a Conservation Plan for the acquisition and protection of important open space at risk of development. The objectives of the plan were as follows: 1) Identify undeveloped private properties potentially at risk for development that could provide future flood-reduction benefits; 2) Assess opportunities for MMSD to partner with public, private, or non-profit entities that would assist with the acquisition, management, and maintenance of identified properties; 3) Assess mechanisms and strategies to leverage MMSD funding for this effort; 4) Provide recommendations for the acquisition of parcels (or easements on these parcels) at risk for development; and 5) Consider how the ecological restoration of identified parcels could reduce future flooding. The Project Team used GIS-based remote sensing techniques (aerial photography, soils maps, wetland maps, etc.) and field visits to identify more than 28,000 acres of undeveloped land containing hydric soils that provide future flood reduction benefits. A subset of 199 sites that were 25 acres or larger in size (a total of 17,146 acres) was identified for further investigation. Thirty-four sites totaling 2,417 acres (representing 4,835 potential acre-feet of storage) were eliminated during field visits because they had been developed. Other sites were eliminated or ranked as low priority for acquisition if they contained a high number of parcels, were aligned in an impractical configuration, or were known to contain environmental hazards. Forty-two sites were identified as high priorities for acquisition. These were ranked based on several factors including: 1) surface area; 2) potential storage capacity of the site relative to runoff produced by the sub-watershed tributary to the site; 3) Potential storage to reduce flooding along the main stem of the watercourse; and 4) importance of the site in reducing future flood risks. This study provides the scientific and practical rationale for protecting these parcels from development in perpetuity, and for using public, private and non-profit entities to manage these properties to maximize flood control benefits. Furthermore, this study identifies funding mechanisms and strategies to leverage monies earmarked for land acquisition.

## **Introduction and Background**

### ***Watershed Changes***

“While much attention of late has focused on the construction of engineering works as a means of meeting water deficiencies . . . comparatively little consideration has been given to the regulatory influence of the soil and rocks of the watersheds, or of the part played by herbaceous range plants in maintaining the efficiency of these natural reservoirs.” (Pearse and Wooley, 1937).

Flooding is a natural process in which a stream or river spills over its banks and into the adjacent floodplain. Flooding usually occurs because the volume of water running off of the contributing tributary area is greater than the capacity of the receiving waterway, and the rate of water running off of the landscape is too great for the receiving waterway to convey within its channel. Flooding also occurs when obstructions within the channel or floodplain create bottlenecks that elevate water levels upstream.

Flooding has many positive effects in a healthy watershed including dissipating the energy of water and thereby minimizing in-channel erosion; depositing nutrient-rich silt and sediment into the receiving floodplain; temporarily storing water in the floodplain and then slowly releasing it into the primary channel as water levels drop; and providing a plethora of habitat benefits, especially for wildlife that depend on floodplain habitat during important times of their life cycle such as breeding and migration. Flooding can result in devastating damage to property, water quality, wildlife habitat, and channel stability when the ability of the floodplain to slow down and store water is impaired.

The frequency and degree of impact of floods is based on a number of watershed factors including precipitation, topography, soil type, vegetation type and cover, and in developed watersheds, the type and extent of land use.

Precipitation drives the storm water runoff of the watershed. Precipitation, while varying with event, is relatively constant over time.

Topography influences the rate and volume of water running off of the landscape. All things being equal, steeper landscapes convey more water at a higher rate than flatter landscapes. Flatter landscapes, or landscapes with depressed areas, provide more opportunities for water to infiltrate, evaporate, and slowly release into the waterway.

Soil type affects the infiltration of water into the ground. Highly pervious soils such as sand infiltrate water more quickly into the ground than tight soils such as clay. Hydric soils, or soils created under anaerobic conditions, often occur in depressed areas of the landscape.

Vegetation cover and type can dramatically affect the rate and volume of runoff. Living vegetation and organic debris (duff) retard runoff. Roots provide channels for water to infiltrate into the ground and build organic matter that has a higher water holding capacity than mineral soil. Vegetation type has a dramatic influence as well. In general, native vegetation such as prairie plants have a much greater ability to capture and infiltrate runoff than introduced species such as turf grass (Weaver and Clements, 1938; Weaver, 1954).

Changing land uses have the most dramatic effect on the frequency and impact of flooding. But before listing the most important reasons, it is useful to consider how the historic Midwest landscape functioned to manage storm water runoff before it was plowed, plumbed and peopled.

Today's Midwest landscape was shaped and formed over the last 10,000 years following the last glacial period. The major land forms – plains, hills, valleys, wetlands, rivers and lakes – are artifacts of the glaciers carving during encroachment, depositing debris during glacial retreats, and creating drainage ways for melting ice to the Gulf of Mexico.

Plants colonized the raw earth left by the retreating glaciers and evolved and adapted to climatic and edaphic conditions that persist today. By the time the first Europeans established a firm foothold 150 years ago, the ecosystems of the tall grass prairies, savannas, woodlands and wetlands were firmly established.

From a storm water management perspective, it is important to note that the capacity and morphology of today's streams and rivers were formed (some might say "sized") when the contributing watershed was vegetated in native prairie, savanna, woodland and wetland. Impervious surfaces only existed in localized areas where bedrock was exposed. All other areas were vegetated or inundated. Storm water runoff was minimal due to the great water holding capacity and natural infiltration of native vegetation and localized natural depressions. In the prairie lands, many of the major rivers of today were little more than large vegetated swales.

The character of our historic watersheds and receiving waterways began to change shortly after the arrival of Europeans. In 1859, Henry F. French records the effects of agricultural practices on stream flows in his *Farm Drainage* monograph:

"The effect of drainage upon streams and rivers, has, perhaps, little to interest merely practical men, in this country, at present; but the time will soon arrive, when mill-owners and land-owners will be compelled to investigate the subject... If now, this surplus of water, this part which cannot be evaporated, and must therefore, sooner or later, enter the stream or pond, be, by artificial channels, carried directly to its destination, without the delay of filtration through swamps and clay-banks; the effect of immediate agricultural drains furnish those artificial channels. The flat and mossy swamp, which before retained the water until the Midsummer drought, and then slowly parted with it, by evaporation or gradual filtration, now, by thorough-drainage, in two or three days at most, sends all its surplus water onward to the natural stream. The stagnant clay-beds, which formerly, by slow degrees, allowed the water to filter through them to the wayside ditch, and then to the river, now, by drainage, contribute their proportion, in a few hours, to swell the stream. Thus, evaporation is lessened, and the amount of water which enters the natural channels largely increased; and, what is of more importance, the water which flows from the land is sent at once, after its fall from the heavens, into the streams. This produces upon the mill-streams a two-fold effect; first, to raise sudden freshets to overflow the dams, and sweep away the mills; and, secondly, to dry up their supply in dry seasons, and to diminish their waterpower."

Engineering News printed in 1892 a story with a similar message, titled "The Drainage of the Kankakee Marsh," and excerpted as follows:

"But when the whole swamp is drained and under cultivation the rainfall will drain off from it as rapidly as from any other tract of cultivated land of similar slope and character of soil. The swamp will no longer be a great shallow storage reservoir to hold the floods which pour down from other parts of the watershed. It is certain, then, that when the drainage enterprise is carried out, a considerable increase in the flood volume of the Kankakee will result. The exact amount of the increase it will be the duty of the engineers of Chicago drainage canal accurately to determine, for in future years, when the compensation for flood damages in the Illinois valley arises the increased flow from the Kankakee must be considered as well as that from the Chicago River".

These early investigators write of draining the land and changing the plant communities from native prairie, savanna, woodland and wetland, to agricultural land. It wasn't long before we started removing the vegetation all together and began constructing impervious roofs, roads and parking lots.

The sequence of events beginning with a healthy undeveloped watershed with minimal to no flooding to an urbanized watershed with severe flooding are summarized as follows (Coffman, 2002):

- In a healthy, undeveloped landscape, water falling on the ground is intercepted by vegetation, retained in depressed areas such as wetlands, and is evaporated and infiltrated. Essentially, water falling on the land stays on the land, or is slowly released into receiving streams.
- Urbanization results in compressed soils, an increase in impervious surfaces, and improved conveyance systems such as streams straightened to ditches, agricultural drain tiles, and storm sewers. Rather than remaining on the land as in a natural setting, water is piped off of the land as quickly as it falls on to the ground.
- Streams and rivers, "sized" over the millennia to receive water from the native landscape, respond to increased runoff by becoming wider and deeper. Flooding occurs as the effects of urbanization outpace the ability of the waterways to receive and convey water; water quality drops as the channel erodes, and water is conveyed through pipes rather than through native vegetation that filters water; wildlife habitat is lost.

It wasn't long before the historic prairie streams – moving marshes with a current, really – were well beyond their capacity to convey the volume and rate of water racing off of the urbanizing landscape. And flooding began in earnest.

### ***The MMSD Model***

Studies completed for the Menomonee River, Oak Creek, and Root River watersheds in southeast Wisconsin indicate that demographic and community development trends over the next 20 years will exacerbate flood problems. These studies provide recommendations for conventional, engineered strategies to combat flooding, as well as acknowledging the importance of maintaining existing open space to prevent future flooding (SWRPC, 1990; CDM, 2000, a,b,c).

Conventional engineered strategies include constructing massive storm water detention facilities where storm water runoff is temporarily stored and released downstream at a controlled rate, or improved conveyance to move water more quickly from one point in the watershed to another point downstream.

While detention and improved conveyance has been proven to reduce flooding within a localized region, in many cases, these strategies have failed to adequately protect downstream communities from flooding, degraded water quality and wildlife habitat, and eroding waterways for a number of reasons:

- New developments are still mass graded and sewered to drain water from the site as quickly as possible. Conveyance is maximized while infiltration and evaporation are minimized.
- Proactive communities require detention ponds designed to release water from new developments at the same rate water was released before the site was developed. However, release rates for detention ponds are usually calculated based on the land cover type immediately prior to development rather than the historic vegetation cover that likely had a much slower release rate. As a result, release rates are often over estimated.

- Detention facilities do not account for the increased volume of runoff from developed areas due to the reality that much less water infiltrates into the ground than under historic conditions (Ferguson, 2002).
- Most storm water regulations address individual development projects but do not take into account the cumulative affect of multiple detention facilities constructed along the same waterway.
- Some communities continue to allow development of naturally depressed storage areas such as wetlands and floodplains. Even if existing regulations do protect these depressed storage areas, regulations can change. Isolated wetlands, for example, are no longer protected from filling under Section 404 of the U.S. Clean Water Act.
- Runoff characteristics of a watershed are very complex and storm water runoff models often underestimate the actual rate and volume of runoff (Apfelbaum, 2001).

The construction of detention facilities over the last 30 years has provided tremendous flood protection benefits and will continue to do so in the future. However, the persistence of flooding in areas where detention facilities and other conventional storm water management strategies are in place, and the failure of conventional techniques to adequately address water quality and habitat goals, makes the objective observer question whether there aren't alternatives to at least supplement conventional strategies.

MMSD took the judicious approach of adopting a conventional storm water management plan per the recommendations of Watercourse Reports prepared by Camp Dresser McKee. But in addition, they launched an aggressive land acquisition program targeting land at threat to development that provided important, natural storm water management functions.

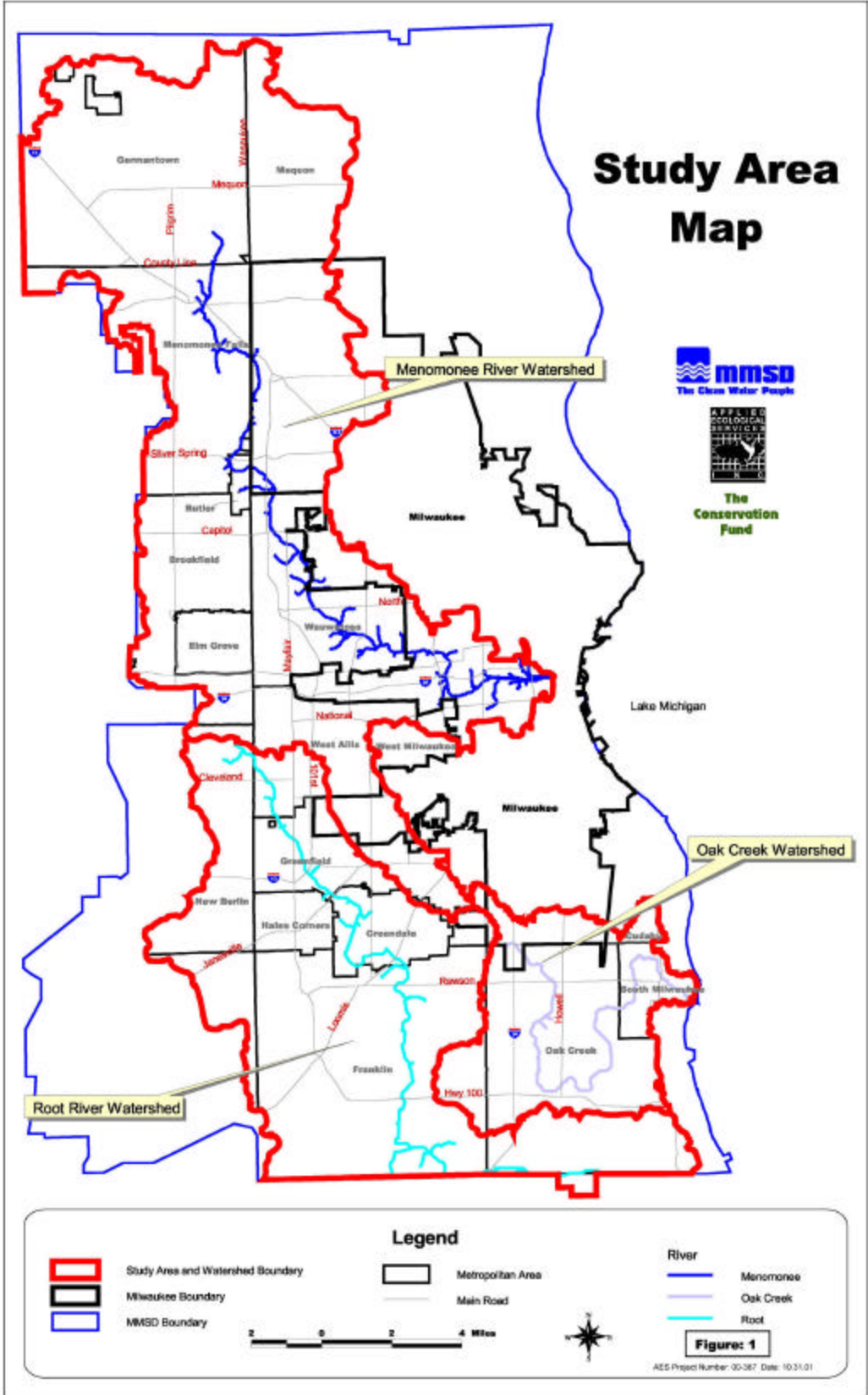
MMSD retained a team led by The Conservation Fund to develop a Conservation Plan with the following key components: 1) Identify undeveloped private properties potentially at risk for development that could provide future flood-reduction benefits; 2) Assess opportunities for MMSD to partner with public, private, or non-profit entities that would assist with the acquisition, management, and maintenance of identified properties; 3) Assess mechanisms and strategies and leverage MMSD funding for this effort; 4) Provide recommendations for the acquisition of specific parcels (or easements on those parcels) at risk for development; and 5) Consider how the ecological restoration of identified parcels could reduce future flooding.

The Conservation Plan was completed during 2001 and provides a technical basis and justification for identifying undeveloped properties to purchase that have the greatest potential to protect against future flooding. The plan also describes a land acquisition strategy, partnership opportunities, additional funding sources, and how the plan can be expanded to target additional objectives such as water quality and wildlife habitat with the implementation of an ecological restoration strategy. MMSD allocated \$15 million dollars over five years to develop the Conservation Plan and purchase property.

## **Project Area**

The project area consisted of the watersheds of the Menomonee River, Root River and Oak Creek that are within the MMSD Planning Area (Figure 1). The MMSD planning area is in southeast Wisconsin and includes portions of Washington, Waukesha, Milwaukee, and Ozaukee counties. The Menomonee River drains an approximately 135 square mile area including at least portions of the cities of Brookfield, Milwaukee and Germantown. The Root River drains an approximately 197 square mile area including at least portions of the cities of Franklin and New Berlin. Oak Creek drains an approximately 27 square mile area including the city of Oak Creek, Milwaukee, and South Milwaukee.

Figure No. 1: The study area consists of the Menomonee River, Root River and Oak Creek watersheds.





## **Methods and Results**

### ***Base GIS Information***

An extensive Geographical Information Systems (GIS) database was developed using ArcView™ to assemble, store, manipulate and display geographically referenced information. Digital data was obtained from Southeast Wisconsin Regional Planning Commission (SEWRPC), MMSD, participating counties, townships and municipalities, and the World Wide Web. Data layers developed included watershed boundaries, sub-watershed boundaries, digital elevation models, aerial topography, 2' topography (where available), planned and existing environmental corridors, governmental boundaries, parcel boundaries and other layers.

Digital ortho-rectified aerial photography (1995 were the most current images available during the study period), hydric soils, floodplain, private/public land, and land use/land cover data were obtained from SEWRPC. Watershed boundaries and characteristics were obtained from Wisconsin DNR, Geographic Services Section (April 1997). USGS 7.5" Digital Elevation Model (DEM) data were used to create an elevation model.

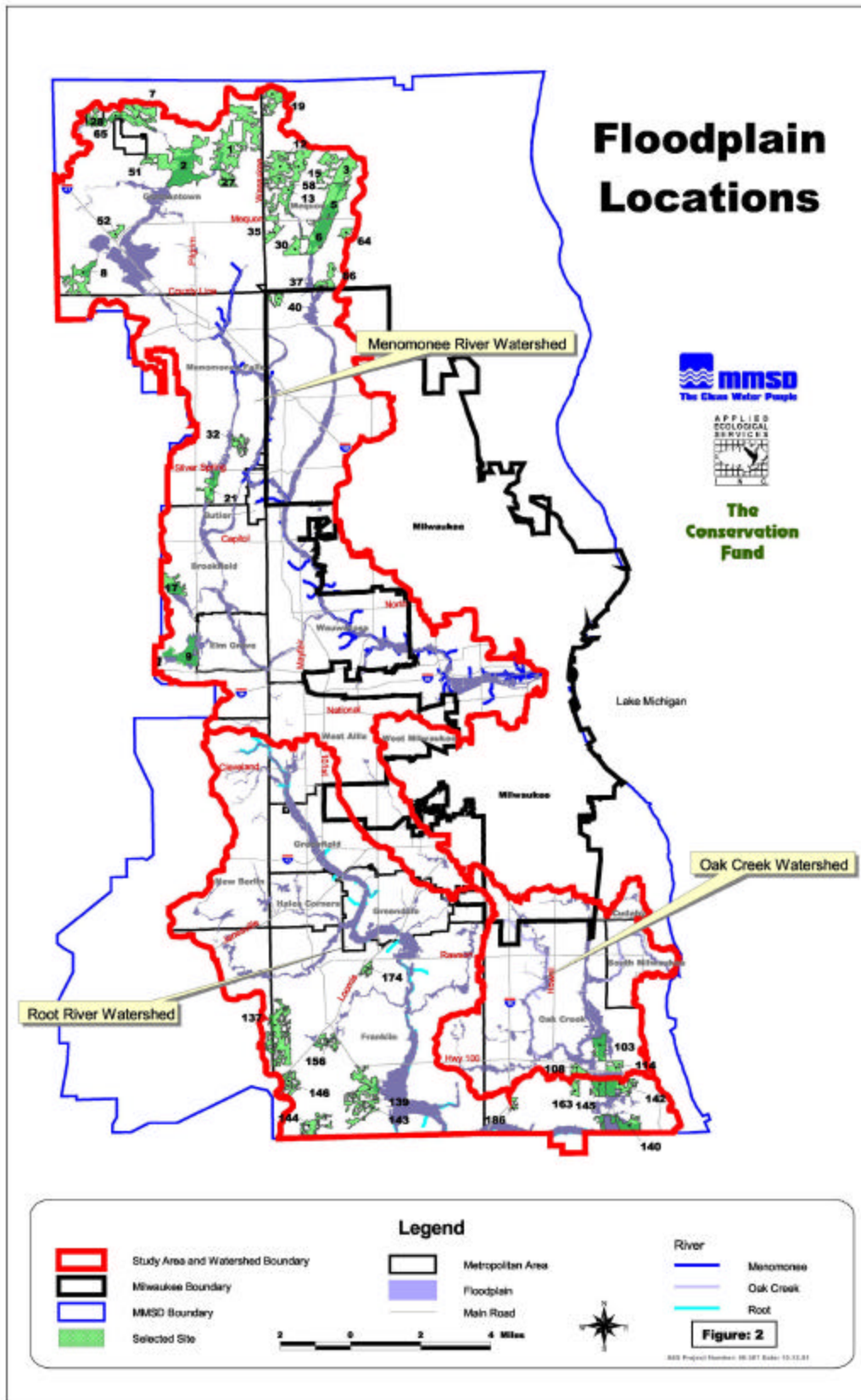
### ***Hydrologic Impact Site Analysis***

The primary objective of the Hydrologic Impact Site Analysis was to identify undeveloped, privately held parcels and evaluate their potential ability to store runoff and reduce flood risks.

An undeveloped site can reduce flooding in two ways. One, reduce the rate and volume of water running off of the site; and two, reduce the rate and volume of water running off of lands tributary to the site. Several criteria were used to evaluate and rank potential sites for restoration for floodwater runoff reduction including: area; the potential floodwater storage capacity of the site relative to runoff tributary to the site; the effectiveness of a site to store water; and the importance of a site to reducing flooding downstream along the mainstem.

Site Selection – We began our initial investigations for potential sites by intersecting privately held, undeveloped lands with hydric soils and floodplain. More than 28,000 acres of land were identified in the initial query. Sites less than 25 contiguous acres were dropped leaving a subset of 199 (Figure 2) sites totaling 17,146 acres. The smaller sites were dropped to create a more manageable data set to work with, and because smaller sites would likely have less potential to affect floodwater runoff.

Figure No. 2: Each floodplain was mapped to assist in the hydrologic analysis.



Each of the 199 sites was field-verified with mapped data. Sites already developed or in the process of being developed were removed. Thirty-four sites totaling 2,417 acres were eliminated during field visits because they had been developed between 1995 and 2001.

Capacity Relative to Runoff – Each of the 199 sites were evaluated and ranked as to their potential to efficiently handle runoff from their tributary watershed during a 100-year, 24 hour duration, storm event.

We assumed that the land cover of the tributary watershed was a typical, residential urban development (Cn=75). This resulted in approximately 3.5” of runoff during a 100-year event (duration 24 hours, Huff 3<sup>rd</sup> quartile precipitation distribution, precipitation 6.24”) for the watershed.

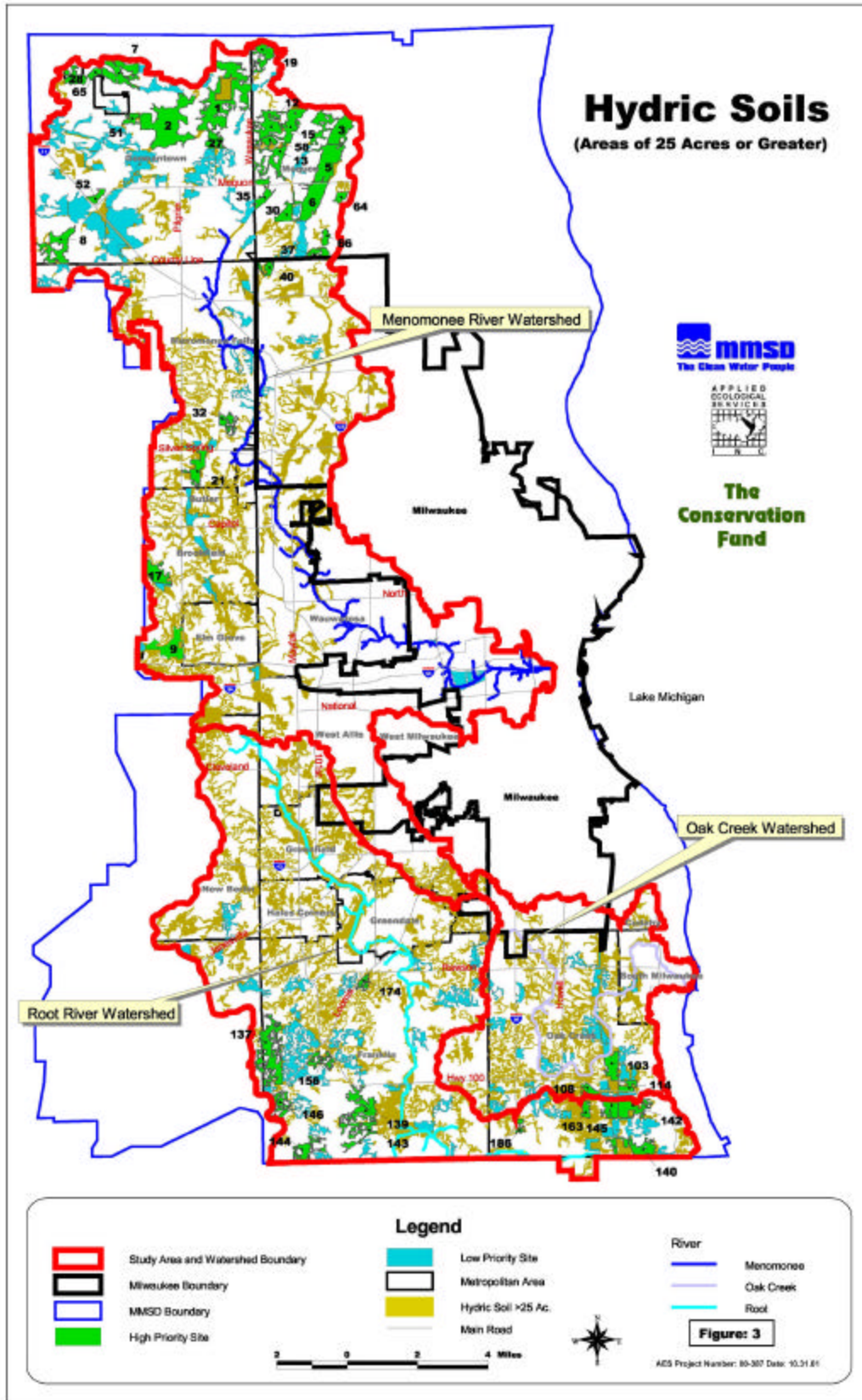
We also assumed that 2 feet of storage was available within the open space site, so a site with a watershed seven times the size of the site (7:1 watershed to site ratio) would most efficiently handle 3.5” of runoff (watershed area x 3.5 inches/12/foot = storage area x 2 feet). Table 1 describes the ranking system created to develop the Watershed/Site Area Ratio Score.

**Table No. 1:** Watershed/Site Area Ratio. A weight of 0 is assigned to sites with negligible on-site storage capacity for runoff relative to the size of the contributing watershed. A weight of 10 is assigned to sites with optimum on-site storage capacity for runoff relative to the size of the contributing watershed. Note each weight is assigned to a range of ratios.

Watershed area: site area ratio	Weight
0:1 to 2:1	3
2:1 to 4:1	6
4:1 to 6:1	8
6:1 to 8:1	10
8:1 to 10:1	9
10:1 to 12:1	8
12:1 to 14:1	7
14:1 to 16:1	4
16:1 to 18:1	2
18:1 to 20:1	1
> 20:1	0

Storage Effectiveness – The storage effectiveness of each site was calculated as a function of the area of the site, and the ratio between the area of the site and the area of the contributing watershed. Larger sites that efficiently store water are ranked higher than smaller sites that do not efficiently store water. The storage effectiveness score was used to identify the 42 highest priority sites (7,065 acres) for protection (Figure 3).

Figure No. 3: Soil analysis contributed to site assessment and prioritization.



Site Importance to Flood Risk Reduction – Each of the 42 high priority sites were assessed as to their importance for reducing flooding risks along the main stems of the primary channels of their watersheds. The importance of the site was based on the proximity of the site to areas along the main stem projected to have flood increases between the 1995 design year and 2020.

Flood projections were taken from Hydrologic Simulation Program-Fortran (HSPF) models prepared Camp Dresser and McKee (2000 a,b,c). Sites were assigned a **high priority** location rank if they were located in sub-watersheds that discharged into reaches of the main stem projected to have significant increases in the 100-year design flood substantially greater than projected increases on the main stem immediately upstream of the site.

Sites were assigned a **medium priority** location rank if they were located in sub-watersheds that discharged into reaches of the main stem projected to have increases in the 100-year design flood that were similar to projected increases on the main stem immediately upstream of the site.

Sites were assigned a **low priority** location rank if they were located in sub-watersheds that discharged into reaches of the main stem that were not projected to have increases in the 100-year design flood.

Final Ranking of Each Site – Each of the 42 high priority sites were ranked in order of 1-42 using weighted variables described above. The rank of each site is described within each of the three watersheds as well as within the entire project area. Table 2 indicates the final rank of each of the 42 high priority sites.

**Table No. 2:** Final ranking of high priority sites by watershed as well as within the entire study area.

Restoration Site	Watershed	Site Area (Acres)	Storage Effectiveness Score	Location Rank	Watershed Rank	Study Area Rank
8	Menomonee River	250.2	85	H	1	1
2	Menomonee River	667.2	80	H	2	2
7	Menomonee River	265.3	76	H	3	3
27	Menomonee River	105.4	63	H	4	5
28	Menomonee River	104.3	62	H	5	6
35	Menomonee River	71.7	60	H	6	7
5	Menomonee River	312.7	87	M	7	8
15	Menomonee River	188.5	81	M	8	9
13	Menomonee River	208.9	74	M	9	11
52	Menomonee River	51.4	42	H	10	13
21	Menomonee River	145.5	69	M	11	14
40	Menomonee River	64.3	36	H	12	15
3	Menomonee River	354.7	58	M	13	17
12	Menomonee River	226.1	55	M	14	18
37	Menomonee River	68.7	51	M	15	21
30	Menomonee River	95	45	M	16	22
58	Menomonee River	47.4	27	H	17	23
51	Menomonee River	55.2	43	M	18	25
32	Menomonee River	84.4	21	H	19	27
1	Menomonee River	673.7	80	L	20	28
9	Menomonee River	230.6	75	L	21	29
65	Menomonee River	43.1	15	H	22	30
17	Menomonee River	155.8	71	L	23	32
64	Menomonee River	44.1	23	M	24	33
66	Menomonee River	42.6	22	M	25	34
6	Menomonee River	292.8	19	M	26	35
19	Menomonee River	152.6	26	L	27	40
103	Oak Creek	138.9	68	H	1	4
114	Oak Creek	65.3	43	H	2	12
108	Oak Creek	73.8	55	M	3	19
144	Root River	135.3	76	M	1	10
137	Root River	420.3	59	M	2	16
174	Root River	44.8	31	H	3	20
156	Root River	88.3	44	M	4	24
139	Root River	239.7	38	M	5	26
146	Root River	119.4	25	M	6	31
142	Root River	188.6	54	-	7	36
145	Root River	120	50	-	8	37
140	Root River	195.3	36	-	9	38
143	Root River	148.9	9	M	10	39
163	Root River	54.9	16	-	11	41
186	Root River	29.9	14	-	12	42

## ***Parcel Prioritization***

Each parcel within each of 42 high priority sites was evaluated and prioritized for acquisition based on the potential storm water runoff storage each parcels would provide. The parcel evaluation methodology consisted of a two-step process:

- Identification of parcels, boundaries and ownership within each of the high priority sites;
- Evaluation of the storage potential of each of the individual parcels.

Parcel Identification – Parcel boundaries and ownership was defined according to available land parcel ownership records.

Parcel Storage Evaluation – The storage potential for each parcel within each of the 42 high priority sites were determined as follows:

1. A site digital elevation model (SDEM) using ArcView™ software was developed for each site.
2. The minimum elevation value (site runoff evaluation) along the perimeter of the site was extracted from the SDEM.
3. A reservoir surface model was generated based on the minimum elevation value along the perimeter of the site.
4. Ownership parcel boundaries were defined and put into the SDEM.
5. The potential volume of each parcel was calculated by using the SDEM elevation grid as the product of the difference between the grid elevation and the minimum elevation along the site perimeter for each SDEM grid and the area of the grid cell. Iterations were calculated based on existing conditions, and the construction of 2-foot, 4-foot, and 6-foot berms.
6. Parcels were ranked and prioritized based on their potential storage at various berm heights.

While the parcel storage evaluation method provided an effective way to compare the potential storage capacity of one parcel to another, the topographic drawings available to us were at too coarse of a scale to permit an accurate representation of actual storage per parcel.

Site Action Plan – A site action plan was developed for each of the high priority sites. The site action plan included an aerial base map indicating site limits and parcel boundaries within the site. Parcels were color coated to indicate parcels with the most potential for storing water. Parcels were linked to a Microsoft 2000 ACCESS database that provided additional information useful to land negotiators, including ownership, size, potential storage, and other information.

## ***Partnership Opportunities and Potential Funding Mechanisms***

Concurrently with the preparation of the Base GIS Information and Hydrologic Impact Site Analysis, staff from The Conservation Fund investigated opportunities for partnering with land trusts, local units of government and private landowners to own, hold easements, or manage Conservation Plan Sites. Staff from Heart Lake Conservation Associates investigated methods to leverage the \$15 million MMSD had allocated to this effort to obtain additional monies through grants or gifts.

Partnership Opportunities – Partnership opportunities with local units of government were evaluated by identifying the overlap between each of the 13 local government’s park and open space plans with Conservation Plan sites. Eleven local units of government were surveyed. Eight of the 11 governments were interested in working with MMSD to manage Conservation Plan sites long term.

Partnership opportunities with non-profit land trusts were evaluated by developing a list of land trusts operating in the project area, and by determining whether the land trust met the minimum requirements for a profile The Conservation Fund developed. Sixteen organizations were identified and 10 were interviewed to determine interest and whether or not the organization met the profile. Two organizations expressed interest and have the capability to own and manage 23 of the 42 Conservation Plan sites.

The Conservation Fund also explored potential partnership opportunities with the private sector including private landowners, residential developers and commercial developers. Private landowners would be more inclined to explore easement arrangements such as the Wetland Reserve Program, Crop Reserve Enhancement Program and the Wisconsin Stewardship program. Commercial and residential developers would more likely be interested in incentive for conservation developments.

Potential Funding Mechanisms – Heart Lake Conservation Associates identified and researched 30 grants that MMSD might pursue to purchase and/or manage Conservation Plan sites and interviewed 18 agencies and organizations. Public and private entities exhibited a high level of interest in supporting a Conservation Plan they viewed as an innovative and exciting approach to deal with multiple objectives (flooding, water retention, wildlife habitat, water quality, open space protection, etc.). Heart Lake estimated that MMSD had the potential to double its \$15 million investment through leveraging.

Heart Lake identified two broad categories of funding that might be leveraged. The first, existing grant programs, is available to grant applicants that meet the criteria of the grant program. The second, that Heart Lake termed “money to be found,” has even greater potential for leveraging funding than grants. “Money to be found” refers to MMSD developing successful partnerships and relationships with organizations that can provide funds. It is not uncommon for agency staff to direct discretionary funds to a project because the project is attractive, a priority for the agency, or will help an organization achieve its goals.

One nearly universal rule when soliciting funds from outside sources is that funding agencies tend to look more favorably on projects that meet multiple objectives. A project that provides flooding, water quality, wildlife habitat and recreational benefits and opportunities would be looked on more favorably than a project with just flood reduction benefits.

## **Discussion**

### ***A Case for Protection***

State and federal statutes and regulations govern much of the activities that are permitted in floodplains, floodways, wetlands and shore land zones. However, most of these resources are not given outright protection by these statutes or regulations, but are merely regulate as required by the statutes.

For example, floodplains and wetlands are frequently impacted by agricultural operations and development. These impacts often result in filling, and reduced size and capacity to function. Many of these impacts are



permissible by state and federal regulations with a permit. Whether or not these permits compensate for lost resources is subject to debate.

Studies of wetland mitigation areas across the country have suggested that most wetland mitigation projects designed to compensate for wetland fills fail to meet design standards. Isolated wetlands, which have been regulated by the Corps of Engineers for more than 15 years, have lost their protection since February 2001 due to changing regulations.

Protection through acquisition or easement offers the very best way to ensure that areas currently used for floodwater storage will be allowed to function in this way in the future. Where protection has not been granted, the range of impacts and alterations to these important areas have contributed greatly to the current flooding problems now experienced in our communities.

### ***Flood Benefits of Protected Sites***

An undeveloped open site provides two opportunities for floodwater runoff reduction. 1) Reduce the rate and volume of runoff from the site itself; and 2) Reduce the rate and volume of runoff from the site through on site management of floodwater runoff from a watershed tributary to the site.

Volume reduction is accomplished through retention (surface water is prevented from leaving the site). Rate reduction is accomplished both by retention and by detention (surface water is temporarily stored on the site and then slowly discharged at a controlled rate).

The type of land cover and vegetation on the landscape has a substantial effect on the amount of surface water running off of the land. A typical urban development will result in surface runoff of approximately 3.5 inches from a 100-year recurrence interval design storm (duration 24 hours, Huff 3<sup>rd</sup> quartile precipitation distribution, precipitation of 6.24"). An undeveloped fallow field with deep-rooted vegetation (i.e. prairie plants) decreases surface runoff of a fallow field from 2.9 inches to 1.1 inches, providing retention of 1.8" of floodwater runoff.

The construction of low berms provides an additional (and greater) volume of floodwater storage. Perimeter berms can reduce floodwater runoff to zero inches. The installation of additional berms at strategic locations throughout the site can retain storm water runoff to a depth of two feet that in turn provides two feet of retention on a site. Such a strategy has the potential to reduce runoff to zero inches for an off-site tributary area up to 6.5 times larger than the site itself.

### ***Cost Effectiveness of Preservation***

It is difficult to accurately measure the cost effectiveness of preserving and restoring open space to the extent that flood benefits are realized. While the Conservation Plan provides a technically defensible method for identifying and prioritizing land to protect, budget and data limitations prevented us from precisely quantifying how much runoff each site or parcel could store.

The budget for preparing the Conservation Plan was less than \$200,000. In the absence of funds to prepare a 1' or 2' topographic survey, we were forced to use U.S.G.S. 7.5" topographical data to quantify the potential storage in sites and parcels. Storage numbers cited in the plan are most useful for comparisons between sites and parcels rather than as a precise representation of actual storage provided.

However, common sense and the use of reasonable assumptions indicate that preserving open space can be very economical when compared to the costs of flood damages, conventional flood damage studies, the costs of implementing conventional flood damage strategies, and costs associated with the loss of water quality, habitat, and other open space opportunities when conventional strategies are exclusively used.

For example. MMSD has a goal of purchasing 5,000 to 7,000 acres of land over the next 5 years using the \$15 million budgeted for the project. If we assume that each acre of land would provide an average of two acre-feet of storage (Eppich et al. 1998), the acquisition of 7,000 acres of land could provide approximately 14,000 acre feet of storage (7,000 acres x two feet of storage per acre = 14,000 acre feet of storage). That translates into \$1,071 per acre-foot of storage for land costs.

Cost per acre-foot of storage would increase once you add construction costs associated with restoring a site to maximize its capacity to store floodwater. Costs for restoration can range from \$1,000 to \$5,000 per acre which raises total cost per acre-foot of storage to \$2,071 to \$6,071 per acre-foot of storage.

It is useful to consider how these costs compare with traditional storm water detention facilities. The Village of Arlington Heights, Illinois provides one such comparison. The Village allows some developers to purchase storm water storage from a regional storm water detention facility in lieu of providing storm water detention on site at a cost \$1/cubic foot of storage, or \$43,560 per acre-foot of storage.

Costs associated with a Phase II Corps of Engineers flood damage reduction project on the Des Plaines River in Illinois provide another useful comparison. The maximum flood of record in 1986 caused \$35 million in damage. The cost of just the study to determine what can be done is \$9.8 million.

Logic suggests that costs associated with flood damages, preparing engineering studies to deal with flood damages in conventional means, and constructing conventional flood damage reduction projects are far greater than costs associated with protecting open space important in storing floodwaters.

Restoration ecologists and storm water management experts will argue without cease as to the virtues and pitfalls of their respective approaches. If approached objectively, and with humility, such arguments are healthy. Ecologists must have the numbers to back up assertions for alternative approaches; engineers must recognize that models can turn into black boxes with simplistic answers to complex questions. However, no alternatives to conventional practices will exist without the land on which to work.

### ***Water Quality Benefits***

Water quality benefits associated with storing storm water runoff in the natural landscape when compared with no storm water management, or even conventional storm water management strategies where water is piped to detention ponds, are substantial.

Coffman (2002) prepared a table summarizing research completed by the Center for Watershed Protection that cites 16 papers published between 1979 and 1994 examining the relationship between urbanization and stream water quality. These papers indicate significant reductions in the diversity of aquatic fauna once total impervious cover in the contributing watershed approaches 10%.

Liptan and Thomas (2002) cite a Portland Bureau of Environmental Service experiment in which a swale planted in turf grass is compared with an identically configured swale planted in native prairie grasses and forbs. The investigators found that runoff attenuation in the native swale was 41% compared with the turf grass swale that was 27%. 68% of the total suspended solids (TSS) in the runoff were retained within the native swale compared with 59% in the turf grass swale. It is important to note that if sewers were used for conveyance rather than swales, attenuation of runoff and TSS would not be significant.

The Storm water Treatment Train™ concept uses constructed landscape features of upland prairies, swales vegetated in native plants, wetlands and lakes to retain and treat runoff. Apfelbaum et al (1995) used HSPF modeling to predict the effectiveness of this system in treating runoff from the Prairie Crossing conservation development in Grayslake, Illinois, with the following results: Surface runoff would be reduced by 65%; TSS would be reduced by 98%; total nitrogen would be reduced by 85%; and total phosphorus would be reduced by 95%.

### ***Lessons Learned and Additional Research***

- This paper provides an original approach for quantifying the potential efficiency of open space to provide storage for storm water runoff. While the topographic information at our disposal was too coarse to provide a precise quantification of potential storage, the technique used permitted us to make objective comparisons between sites and parcels. Higher resolution topographic data would have allowed us to make precise quantification of potential storage using the techniques we developed.
- Costs associated with flood damages, preparing studies to reduce flood damages, and implementing conventional storm water management strategies to combat flooding, are enormous. This study justifies allocating more resources toward studying alternative strategies that rely on preservation and restoration as a cost effective means to combat flooding, as well as address other objectives such as water quality, habitat, and open space benefits.
- The investigators were restricted to considering only privately held open space. We recommend expanding the study to include publicly held open space for additional passive floodwater storage opportunities.
- The ranking system did not include restoration measures on each site that could maximize the potential for each site to store floodwater. We recommend expanding the study to consider how restoration could maximize the potential for each site.
- This study concentrated on floodwater benefits of open space. We recommend additional work to demonstrate how preserved open space will provide multiple benefits including water quality, habitat, and other open space benefits.
- The investigators learned that it is absolutely essential to be sensitive and humble when proposing alternative methods for combating flooding. Communities may wait years for flooding relief that may or not be consistent with alternative strategies described in this paper. The investigators acknowledge the value conventional storm water strategies have had in the past and will continue to have today and into the future.

### **Conclusion and Summary**

- This Conservation Plan identified 199 sites total 17,146 acres for further investigation. Thirty-four sites totaling 2,417 acres were eliminated during field visits because they were already developed.

Forty-two sites totaling 7,065 acres were identified as high priority sites. Remaining sites were identified as low to medium priority for acquisition due to limited flooding benefits, an impractical configuration for acquisition, or an excessive number of parcels.

- Interviews with potential partners (local governments, land trusts, others) indicate that 61% of the high priority sites have entities that are “definitely” interested with MMSD.
- Thirty-four high priority sites containing up to 4,835 acre-feet of potential storage have been lost or altered since 1995.
- Approximately \$15 million is earmarked for the implementation of the Conservation Plan. While variable land costs prohibit an accurate estimate of the amount of land that might be purchased with available funds, this study indicates that costs associated with preserving and restoring important open space is less than the cost of constructing traditional detention facilities to deal with existing or future flood problems.
- This study provides an original approach for quantifying the potential efficiency of open space to provide storage for storm water runoff. While the topographic information at our disposal was too coarse to provide a precise quantification of potential storage, the technique used permitted us to make objective comparisons between sites and parcels. Higher resolution topographic data would have allowed us to make precise quantification of potential storage using the techniques we developed.
- Conceptual cost estimates indicate that securing undeveloped sites and maximizing their natural flood storage potential is cost effective compared with conventional flood control alternatives.

## ***Acknowledgements***

Portions of this paper first appeared in the MMSD’s Conservation Plan (2001). Steve McCarthy was the MMSD’s project manager. Peg Kohring of The Conservation Fund led the consulting team. Mark O’Leary of Applied Ecological Services, Inc. was the project manager for the technical team and writing the Conservation Plan. Doug Eppich of Applied Ecological Services, Inc. assisted with the development of the ranking system. Neal Thomas of Research Data, Inc., and Jason Carlson of Applied Ecological Services, Inc. completed the GIS analysis. Steve Apfelbaum of Applied Ecological Services, Inc. provided leadership and vision. Peter McKeever of Heart Lake Conservation Associates contributed to the funding portion of the study. Megan Kelly, David Johannesen and Pam Sullivan provided additional assistance on the Conservation Plan. Karen Sands and Kevin Shafer provided important reviews of the Conservation Plan. Iva McRoberts edited and formatted this paper. The Project Team gratefully acknowledges their support and assistance.

## **Bibliography**

Apfelbaum, S.I., Eppich J.D., Price T.H., and M. Sands, 1995. The Prairie Crossing Project: attaining water quality and stormwater management goals in a conservation development. Pages 33-38 in *Using Ecological Restoration to Meet Clean Water Act Goals*, Chicago, Illinois.

Apfelbaum, S.I., 2001. A brief history and analysis of floodwater management engineering: experiments with undefined certainty. From the Milwaukee Metropolitan Sewerage District’s Conservation Plan. 2001.

Camp Dresser and McKee, 2000a. Watercourse Study for the Oak Creek Watershed. Prepared for the Milwaukee Metropolitan Sewerage District.

Camp Dresser and McKee, 2000b. Watercourse Study for the Menomonee River Watershed. Prepared for the Milwaukee Metropolitan Sewerage District.

Camp Dresser and McKee, 2000c. Watercourse Study for the Root River Watershed. Prepared for the Milwaukee Metropolitan Sewerage District.

Coffman, L.S., 2002. Low-impact development: an alternative stormwater management technology. Pages 97-124 in Handbook of Water Sensitive Planning and Design. Edited by Robert L. France. Lewis Publishers. Boca Raton.

Engineering News, 1892. The drainage of the Kankakee Marsh. Drainage Journal, 14:323-324.

Eppich, J. D., Apfelbaum S.I., and L. Lewis, 1998. Working paper # 2: small wetlands use for stormwater runoff management in the Red River of the North basin. From a Compendium of Technical and Scientific Advisory Committee Working Papers. In press.

Ferguson, B.K., 2002. Stormwater management and stormwater restoration. Handbook of Water Sensitive Planning and Design. Edited by Robert L. France. Lewis Publishers. Boca Raton. Pages 11-28.

French, Henry F., 1859. Farm Drainage. A.O. Moore & Co., New York, NY.

Liptan, T., and R. K. Murase, 2002. Water gardens as stormwater infrastructure (Portland, Oregon). Handbook of Water Sensitive Planning and Design. Edited by Robert L. France. Lewis Publishers. Boca Raton. Pages 125-153.

Pearse, C.K., and Samuel B. Wooley, 1937. The Influence of Range Plant Cover on the Rate of Absorption of Surface Water by Soils.

Southeastern Wisconsin Regional Planning Commission, 1990. A stormwater drainage and flood control system for the Milwaukee Metropolitan Sewerage District. Waukesha, WI. Community Assistance Planning Report No. 152.

The Conservation Fund; Applied Ecological Services, Inc.; Resource Data, Inc.; Heart Lake Conservation Associates; Velasco & Associates, K. Singh & Associates. 2001. Conservation plan. Prepared for the Milwaukee Metropolitan Sewerage District.

Weaver, J.E., 1954. North American Prairie. Johnsen Publishing Company. Lincoln, Nebraska.

Weaver, J.E., and F.E. Clements, 1938. Plant Ecology. McGraw-Hill Book Company, Inc. New York.

# **CRITICAL COMPONENTS FOR SUCCESSFUL PLANNING, DESIGN, CONSTRUCTION AND MAINTENANCE OF STORMWATER BEST MANAGEMENT PRACTICES**

Richard A. Claytor, Jr., P.E.  
Director of Watershed Services  
Horsley & Witten, Inc.  
Sandwich, Massachusetts

## **Abstract**

This paper presents a common nomenclature for structural stormwater best management practices (BMPs) and reviews the several critical elements that must be addressed to ensure that BMPs meet watershed protection goals. A set of key planning, design and implementation elements is reviewed. The paper documents some of the many possible pitfalls that planners, designers, and local officials are faced with during the BMP implementation process. Several real world examples of successful and failed BMP implementation are cited as illustrations. The old adage, "the devil is in the details," is illustrated to alert stormwater management practitioners to critical components throughout the BMP implementation process.

## **Introduction**

This paper presents a series of suggestions to help implement successful stormwater management best management practices (BMPs). A nomenclature is introduced to understand the context of how planning, design, and construction decisions vary depending on which stormwater practice is being discussed. Next, a series of BMP performance factors are presented to help the reader understand the complex nature that governs BMP effectiveness. Finally, several planning, engineering, construction and maintenance considerations are reviewed that identify specific measures to help engineers, plan reviewers, and regulators implement successful BMPs.

## **Background**

Stormwater BMPs are commonly grouped into one of two broad categories, as so-called "structural" management measures or as "non-structural" measures. For purposes of discussion, structural measures are those that consist of a physical device or practice that is installed to capture and treat stormwater runoff for a prescribed precipitation amount, frequently referred to as either the "water quality volume" or "first flush" volume. Structural BMPs include a wide variety of practices and devices, from large-scale retention ponds and constructed wetlands, to small-scale underground treatment systems, and manufactured devices. Non-structural practices are generally defined as the operational and/or behavior-related practices that attempt to minimize the contact of pollutants with stormwater runoff.

Over the years, there has been a great deal of confusion and uncertainty regarding BMP nomenclature. For example, one person may use the term "wet pond" to describe a retention pond. Another may use the term "retention pond" to describe an infiltration basin because runoff is "retained" within the pond until it is infiltrated into the ground. Both are technically correct, since a wet pond "retains" runoff in a permanent pool and an infiltration basin "retains" runoff within the underlying soils of a basin. This confusion arises

because stormwater practitioners do not have a consistent BMP nomenclature whereby everyone knows what everyone else is talking about. To help provide a consistent basis for comparison and discussion of BMPs, many organizations, state agencies and others are developing naming conventions for the most common stormwater treatment practices. Table 1 lists some of the various widely accepted structural practices and provides a brief description of each. As illustrated in Table 1, the so-called structural practices can be grouped into one of six major categories as ponds, wetlands, infiltration practices, filters, open channels, and other practices. While Table 1 certainly cannot be offered as the "standard" for BMP nomenclature, it recently has been adopted in a series of statewide programs in Vermont, New York, Maryland, and Georgia. Figure 1 illustrates four of the more widely applied of these structural BMPs.

Another area of particular interest and concern to stormwater managers is the question of how effective BMPs actually will be in meeting watershed protection goals, such as helping to achieve total maximum daily load (TMDL) targets or implementation as part of EPA's Phase II Stormwater Program. This raises the question, what watershed management objectives are BMPs being designed to solve? In general, stormwater management measures are called upon to meet one or more of four major watershed planning objectives, including:

- Promoting groundwater recharge
- Reducing pollutant loading to receiving waters
- Minimizing or eliminating accelerated stream channel erosion
- Minimizing or eliminating flooding

The management objective along with any site constraints will dictate which practice, or suite of practices, is employed for implementation. For example, the typical dry detention pond or underground vault does little to reduce pollutant loading, but can be reasonably effective in meeting channel protection and flood control goals (Winer, 2002). Infiltration practices certainly promote groundwater recharge, but rarely are capable of meeting flood control objectives. This paper will concentrate on those components that go into the successful planning, design and implementation of BMPs to reduce pollutant export to receiving waters.

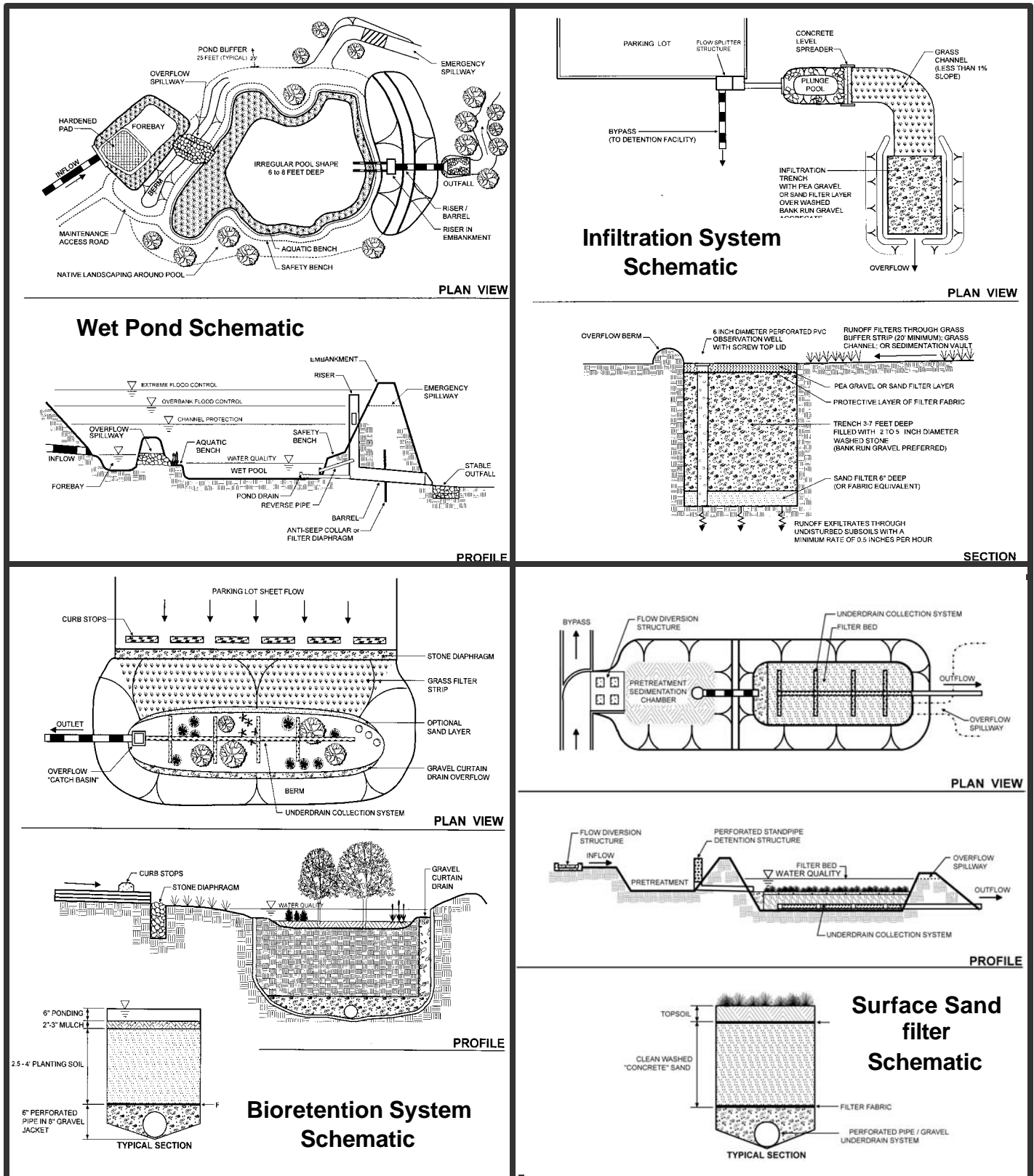
All of the structural stormwater management measures have some capability to remove pollutants, but their effectiveness varies widely depending on the type of practice, design characteristics, site characteristics, target pollutant constituents, and construction and maintenance factors. Watershed managers are increasingly aware that there are limitations and uncertainty to structural BMP effectiveness. Consequently, there is frequently a need to also employ a suite of "non-structural" practices to help meet watershed protection goals. While the uncertainty of the effectiveness of non-structural practices is probably an order of magnitude higher than that of structural BMPs, many practitioners recognize the need to do both.

While there are certainly several options available to watershed managers, the reality is that many practices, both structural and non-structural, may simply be infeasible or impractical in certain situations. Furthermore, there are other considerations, such as cost, unintended environmental consequences, neighborhood acceptance, or maintenance burden that will affect the ultimate selection and implementation of any given stormwater management strategy. The remainder of this paper will focus on those factors affecting structural BMP performance and longevity. This is not to underestimate the role of non-structural BMPs in the stormwater manager's toolbox, but simply to acknowledge that data in this arena is currently under-represented in the literature.

**Table 1: Naming Convention of Common Structural Stormwater Management Practices for Water Quality Management and Treatment (Adapted from CWP, 2002)**

<b>BMP Group</b>	<b>Practice Name</b>	<b>Practice Description</b>
<b>Ponds</b>	Dry Detention Pond	Dry ponds or vaults are generally designed to temporarily detain runoff from a set of defined storm frequencies to provide peak flow attenuation for flood control purposes.
	Dry Extended Detention Pond	Ponds that treat a prescribed water quality volume through extended detention, a design option that holds runoff over a fixed detention time.
	Wet Pond	Ponds that provide storage for a water quality volume in a permanent pool.
	Wet Extended Detention Pond	Ponds that treat a water quality volume by detaining runoff above the permanent pool for a specified minimum detention time.
	Multiple Pond System	A group of inter-connected ponds that collectively treat a water quality volume.
<b>Wetlands</b>	Shallow Marsh	Constructed wetlands that provide water quality treatment primarily in a wet shallow marsh.
	Extended Detention Wetland	Wetland systems that treat a portion of a water quality volume by detaining storm flows above the marsh surface.
	Pond/ Wetland System	Wetland systems that treat a portion of a water quality volume in a permanent pool of a wet pond that precedes the shallow marsh wetland.
	Gravel Wetland	Wetland systems composed of wetland plant mats grown in a gravel matrix.
<b>Infiltration</b>	Infiltration Trench	Infiltration practices that store a water quality volume in the void spaces of a gravel trench or within a chamber or vault before being infiltrated into underlying soils.
	Infiltration Basin	Infiltration practices that store a water quality volume in a surface depression, before being infiltrated into underlying soils.
<b>Filters</b>	Surface Sand Filter	Filtering practices that treat stormwater by settling out larger particles in a sediment chamber, and then filtering stormwater through a sand matrix.
	Underground Sand Filter	Filtering practices that treat stormwater as it flows through an underground sediment chamber and then into a sand-matrix filtering chamber.
	Perimeter Sand Filter	Filters that incorporate a shallow sediment chamber and a sand filter bed as parallel vaults.
	Organic Filter	Filtering practices that use an organic medium such as compost in the filter, or incorporate organic material in addition to sand (e.g., peat/sand mixture).
	Bioretention	Practices that incorporate shallow depressions with vegetation that treat stormwater as it flows through a soil matrix.
<b>Open Channels</b>	Dry Swale	Open vegetated channels or depressions explicitly designed to detain and promote the filtration of stormwater runoff into a prescribed underlying soil media.
	Wet Swale	Open vegetated channels or depressions with wetland vegetation designed to retain water or intercept groundwater for water quality treatment.
	Grass Channel	Open vegetated channels or depressions designed to convey and detain a water quality volume at a very slow maximum velocity with a minimum residence time.
<b>Other Practices</b>	Hydrodynamic Devices and Swirl Concentrators	Hydrodynamic solids separation devices characterized by an internal structure that creates a swirling vortex.
	Oil and Grit Separator	Flow separation devices designed to remove pollutants from stormwater runoff through gravitational settling and trapping.
	Filter Strips	Vegetated areas with prescribed dimensions and slopes, designed to treat sheet flow runoff from adjacent surfaces and remove pollutants through filtration and infiltration (a.k.a., grass filter strips, filter strips, and forested buffers).





**Figure 1:** Illustration of four common structural stormwater BMPs (source, CWP, 2002) (the figure illustrates the plan and profile schematic view of four BMPs: the wet pond, infiltration trench, bioretention system and surface sand filter)

## *Pollutant Removal Effectiveness*

What are the characteristics or criteria that govern BMP pollutant removal effectiveness and how can one be reasonably certain that BMPs will meet watershed management objectives? These are key questions that watershed managers need to address in order to reliably predict benefits of stormwater implementation.

From the author's experience there are at least six separate variables that govern BMP pollutant removal effectiveness. These include:

1. The estimated pollutant removal capability of the practices themselves, based on prior monitoring
2. The contributing drainage area that is physically directed to one or more BMPs
3. The fraction of the annual rainfall that is effectively captured by practices
4. The criteria that are employed for the design and implementation of new BMPs
5. The construction inspection and enforcement capabilities of watershed managers and/or agencies to ensure that the design criteria are applied and implemented
6. The maintenance performance of BMPs over the long term

While several of these variables are self explanatory, it is worth a brief explanation to describe them in greater detail. The estimated pollutant removal capability of specific BMPs is simply the pollutant removal efficiency that has been calculated from monitoring data of actual field studies of BMP performance. Generally, quoted removal efficiencies are based on the median removal values from a dataset of performance monitoring studies. There are several factors that will govern the pollutant removal of a given practice, including inflow concentration, internal geometry, storage volume, and several site characteristic parameters such as soil type/sediment particle size, catchment size, watershed land use, and percent impervious. Two of the most extensive datasets available are the National Pollutant Removal Database for Stormwater Treatment Practices, 2<sup>nd</sup> Edition (Winer, 2000), and the US EPA/ASCE National Stormwater BMP Database ([www.bmpdatabase.org](http://www.bmpdatabase.org)).

Unfortunately, watershed load reduction is not necessarily a direct function of the BMP removal efficiency because often a portion of a watershed cannot be captured by stormwater BMPs. Watershed managers must account for watershed areas and loads that do not drain directly to structural BMPs.

The next important factor is the fraction of the annual rainfall and resulting runoff that cannot be effectively treated by structural BMPs. The pollutant removal rates for most BMPs represented in pollutant removal databases are specific to a certain prescribed runoff volume. If BMP sizing criteria in a given watershed is either higher or lower than the norm, watershed managers may need to adjust removal estimates accordingly. Furthermore, the flow path, depth, area, and topographic complexity within a BMP site can influence performance. For example, it has been surmised that pond and wetland geometry is an equally important parameter to design volume in defining pollutant removal performance (Schueler, 1992 and Strecker, et al., 1992). Designs that do not consider internal geometry criteria or ignore "short-circuiting" possibilities are likely to be less effective.

The final two factors that govern BMP effectiveness relate to the quality of construction and the maintenance performed over time. Many structural BMPs have unique and often subtle design features that facilitate pollutant removal. For example, shallow marsh wetlands must have shallow water depths and complex topographical features to maximize pollutant removal. Filtering practices must be constructed within very tight elevation tolerances to ensure proper inflow and distribution across the surface area of the

practice. Even small variances in the construction of these facilities can result in significant impacts to pollutant removal performance.

Finally, long-term maintenance must be performed to achieve the stated pollutant removal estimates established from prior monitoring studies. While there is not a great deal of research documenting BMP effectiveness over time, at least one study of a constructed wetland in Minnesota found a significant reduction in pollutant removal ten years after initial construction, primarily as a result of a lack of maintenance (Oberts, 1997). Furthermore, the vast majority of facilities being evaluated in BMP performance studies are less than three years old (Winer, 2000). The net result should be that watershed managers and those developing watershed loading assessments should be prepared to discount pollutant removal effectiveness in relationship to anticipated maintenance.

## **Planning for BMP Implementation**

It all starts with planning. Remember the six P's? *Poor Planning Produces Piss Poor Performance!* Well, it could not be any more appropriate than for stormwater BMP implementation. Stormwater practitioners must understand the broad watershed management objectives, site-specific physical limitations, and a host of other issues to select and locate the most effective BMP system. The selection of appropriate stormwater practices involves a combination of the process of elimination and the process of addition. Typically, no single practice will meet all of the stormwater management objectives at a given site. Instead, a series of practices are generally required. Certain practices can be eliminated from consideration, based on one limiting factor, but several practices may ultimately "survive" the elimination process. The most appropriate practices are those that are technically feasible, achieve the benefits for watershed protection, can be most easily maintained, and meet budget constraints of the owner.

The basic considerations for arriving at the most appropriate practice or suite of practices are governed by a variety of factors, including:

### Land use

*Which practices are best suited for the proposed land use at the site in question?* Conversely, some practices are ill suited for certain land uses. For example, infiltration practices should not be utilized where runoff is expected to contain high levels of dissolved constituents, such as metals or the gasoline additive, MTBE.

### Physical feasibility factors

*Are there certain physical constraints at a project site that restrict or preclude the use of particular practices?* This involves an assessment of existing onsite structures, soils, drainage area, depth to water table, slope or head constraints at a particular site. For example, stormwater wet ponds generally require a drainage area approaching 25 acres unless groundwater interception is likely. They can also consume significant land area.

### Watershed factors

*What watershed protection goals are needed within the watershed that the site drains to?* This set of factors involves screening out those practices that might be in conflict with overall watershed protection strategies. For example, practices that contribute to thermal loading should be restricted in cold-water fisheries.

### Stormwater management control capability

*What is the capability of a particular stormwater practice or suite of practices to meet the multiple objectives of water quality control, channel erosion mitigation and/or flood control?* Certain practices have limited capabilities to manage a wide range of storm frequencies. For example, the filtering practices are generally limited to water quality treatment and seldom can be utilized to meet large storm management objectives.

### Pollutant removal capability

*How do each of the stormwater management options compare in terms of pollutant removal?* Some practices have a better pollutant removal potential than others or have a better capability to remove certain pollutants. For example, stormwater wetlands provide excellent total suspended solids (TSS) removal but only modest total nitrogen (TN) removal.

### Environmental and maintenance considerations

*Do the practices have important environmental drawbacks or a maintenance burden that might influence the selection process?* Some practices can have secondary environmental impacts that would preclude their use in certain situations. Likewise, some practices require frequent maintenance and operation that is beyond the capabilities of the owner. For example, infiltration practices are generally considered to have the highest maintenance burden because of a high failure history.

## *Key Planning Considerations*

### **Choosing the right BMP**

While designers and reviewers alike may be familiar with the list of selection criteria cited above, many still select BMPs primarily based on a single factor, cost. This is particularly true in the private sector, where cost seems to be the overriding selection criteria. This includes the cost to design as well as the capital costs of construction. Design firms submit competitive bids to clients and tend to select BMPs that are easy and quick to design. The easiest designs are those that involve the implementation of proprietary products, where vendors provide sizing computations and ready-drawn cad files. As a result, many sites end up with "stormwater in a can" as the proposed BMP, yet in general, these practices provide no groundwater recharge, little or no channel protection or flood control benefits, and often do little to remove pollutants of concern. One example is from Lake George, New York, where a propriety product was installed to help mitigate fecal coliform delivery to a downstream swimming beach. Unfortunately, this product had no documented capabilities to remove bacteria and as it turned out, actually exported bacteria to the beach (West, et al., 2001). Apparently, the right conditions existed in the system for bacteria reproduction.

In this climate of intense competition and modest profit margins, developers are increasingly unwilling to weigh other factors beyond cost in the BMP selection process unless forced by regulatory agencies. Another preferred practice has historically been the standard dry detention pond. In some jurisdictions, however, the dry pond no longer meets required water quality performance criteria. For example, Massachusetts requires an 80% total suspended solids (TSS) removal rate as part of the statewide stormwater policy. The dry pond is not rated to remove this percentage and therefore developers frequently turn to the wet pond as a substitute. The problem is that wet ponds are being proposed in several applications where they likely will not function. In one example in Mattapoisett, Massachusetts, the engineer and developer of a five-acre condominium project are implementing a 5,000 square foot, four-foot deep wet pond with a drainage area of 4.3 acres, where the groundwater elevation is below the pond bottom

for most of the year (Rizzo Associates, 2002). At best, one should expect to see eutrophic conditions at this pond and frequent complaints from homeowners living nearby.

### **Site Surveys and Physical Investigations**

A comprehensive site survey and physical investigations are perhaps the two most important BMP planning considerations. At a minimum, a soils test and a simple site visit should be performed at all sites. Aside from flat terrain, site soils and groundwater elevation are the most common limiting factors inhibiting successful BMP implementation. Only a few of the filtering systems and the proprietary products can be implemented in most soil conditions. Other practices such as ponds and wetlands must have soils suitable for embankment construction and water retention. All infiltration practices must have soils with appropriate percolation rates and separation between groundwater. Even open channels rely on either porous soils for infiltration, or impermeable soils for retention. Poor underlying soils are perhaps the greatest single factor leading to infiltration system failure. For example, approximately 55% of infiltration trenches installed in one Maryland county had failed within five years of construction, most as a result of poor underlying soils (Galli, 1992). In Massachusetts and several other states, at least a two-foot separation distance is required between the seasonal high groundwater elevation and the bottom of any infiltration facility (MADEP/CZM, 1997). Failure to document water table elevations can lead to potential groundwater contamination and inadequate treatment where groundwater mounds-up into the bottom of infiltration facilities.

The site visit can reveal limitations that may not appear in topographic surveys or geographic information system (GIS) mapping. For example, specimen trees can be identified, located and avoided in subsequent design plans, underground and surface utilities can be documented, subtle drainage patterns that might have a significant impact on the design can be identified, or design constraints from adjacent property owners might be revealed.

### *Development of the Stormwater Management Concept Plan*

Before developing full-scale engineering construction drawings, designers should prepare a conceptual design that clearly defines the location, type, and approximate size of the practice. At this stage, preliminary hydrologic computations should be performed to arrive at the basic configuration of a facility. Potential permitting issues can be identified and hopefully addressed. Typically, a preliminary cost estimate is developed to give the owner some sense of the ultimate capital costs of implementation. Figure 2 illustrates the level of detail typically found at the conceptual stage. The primary purpose of the conceptual plan is to present the design intent in sufficient detail so owners, reviewers, and regulatory staff can understand the project plans and provide input prior to the development of more expensive engineering construction drawings and specifications.

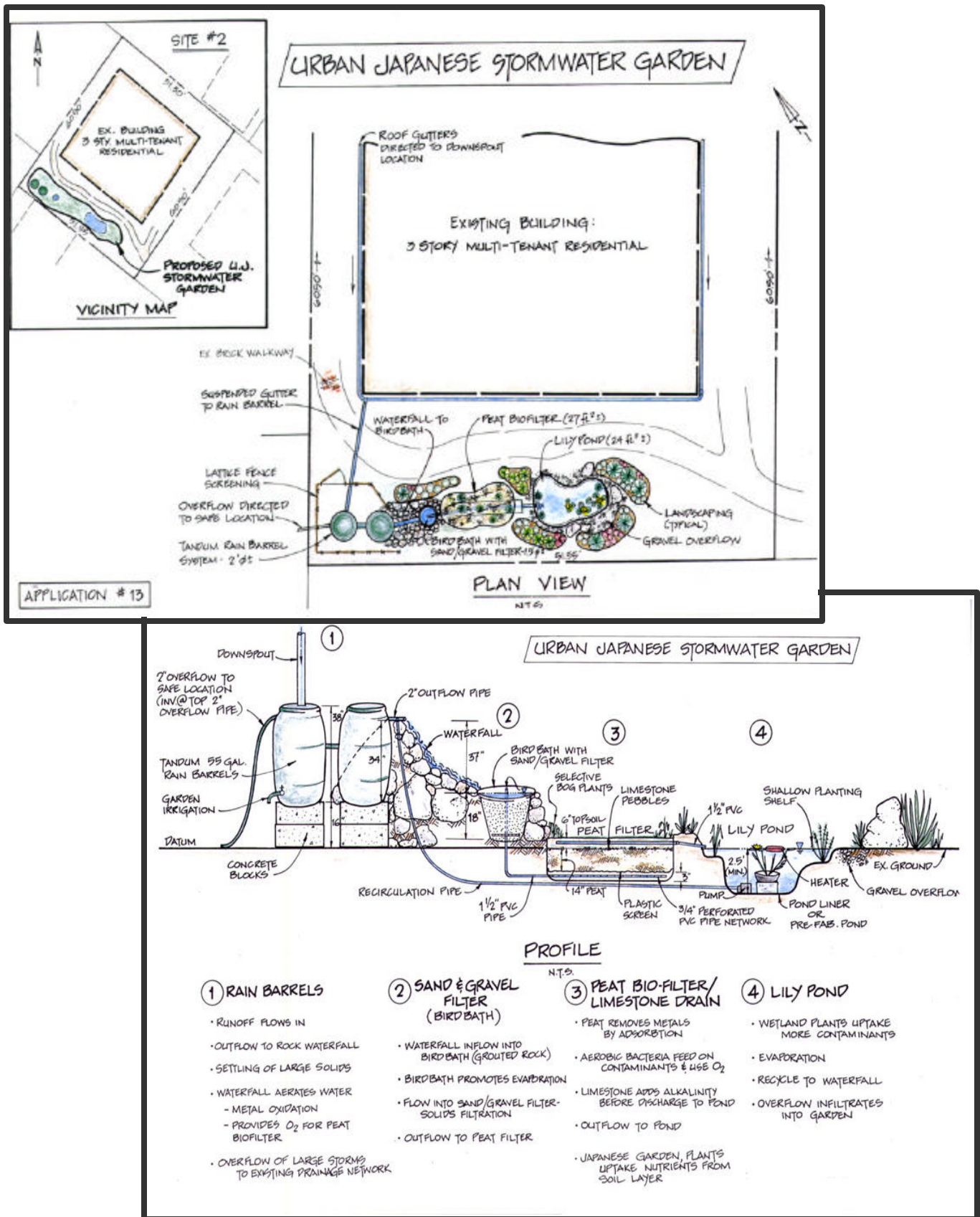


Figure 2: Illustration of a typical stormwater management concept plan (Sourial and Claytor, 2002)(the figure shows the level of detail typical of a stormwater management concept plan)

## **BMP Design**

Assuming an appropriate BMP has been identified and selected in the planning stage, the next opportunity for success or failure is at the design stage. Generally, this stage is where most engineers do all right. Engineers typically have a good education and training background to develop a set of sound construction plans and specifications. However, there are a couple of key considerations that consistently seem to be the vulnerable points in the design process.

### *Hydrologic and Hydraulic Computations*

The development of hydrologic and hydraulic computations is the first point in the design process of a stormwater management system, and the most crucial to get right, since all other design depends on the answers. While the examination of hydrologic methods is beyond the scope of this paper, the following considerations are worth noting:

- Get the rainfall amount right. Many designers rely on the venerable National Weather Service Technical Paper 40 (TP-40), which dates to the early 1960's, to obtain precipitation values for selected storms (NRCS, 1986). While TP-40 is widely referenced in regulatory documents, more recent research is probably more accurate. For example, the Northeast Regional Climate Center at Cornell University has published recent data that is significantly different than those values represented in TP-40 (Wilks and Cember, 1993).
- Estimate a realistic time of concentration. The time of concentration is the single most sensitive hydrologic variable that hydrologists rely upon to estimate peak flow rates. The use of an excessively long overland flow condition can artificially distort the travel time and reduce peak discharge rates.
- Examine land use assumptions to ensure that values are based on current and projected future conditions.
- Examine hydrologic soil group assumptions to make sure they are representative of actual watershed conditions. In one example in the Catskill Mountains of New York, engineers used hydrologic group "C" soils in an attempt to mimic a shallow-shale based soil profile that had large initial infiltration potential and equally large interflow rates, but no relationship to the hydrologic conditions representative of the "C" soil group.
- Utilize appropriate assumptions when performing hydraulic modeling. Many errors occur in describing the storage and outlet conditions of facilities that are very different from what ultimately makes it to the design plan. Examples include: applying large infiltration rates where soil data show modest or poor infiltration, over estimating the storage capacity of a pond, describing an outlet as a single orifice where multiple releases are proposed, getting the invert elevations wrong, or simply ignoring a contributing area in the hydrologic routing to a facility.

### *Soils and Structural Design*

Almost all stormwater designs involve some requirement for soils information and in some cases, reasonably complex geotechnical calculations for soil compaction, seepage diaphragm design or rapid drawdown analyses, for example. Yet few BMP designs incorporate these measures. As a consequence, poor soils analyses ranks as perhaps the most common factor leading to BMP practice failure. Designers and reviewers must involve a reliable soils evaluator or geotechnical engineer in the design process and incorporate their recommendations in the design. Again, according to Galli, (1992), soil limitations ranked among the highest factor contributing to infiltration system failure. Design of infiltration BMPs must include adequate subsurface investigations and reporting.

Structural design is another key component for many BMPs. Typical examples include: adequate foundation design for pond outlet control structures or underground vaults, retaining wall design for weir walls or large outlet facilities, and concrete slab design for load bearing structures. Many hydrologic and hydraulic engineers are unfamiliar with this component of design to the level of expertise required for some applications. For example, one of the more notable stormwater facilities designed by this author was the Wheaton Branch Retrofit facility constructed in Maryland in the early 1990s (Claytor, 1998). The Wheaton Branch facility design required the modification of a nearly 30-year old riser that wasn't adequately evaluated for structural integrity. As a consequence, the newly constructed facility developed failure cracks that had to be remediated shortly after the facility was finished, at great expense and embarrassment to all parties involved, especially, this author. So the point is, one must recognize that sometimes stormwater design involves detailed structural calculations that involve an experienced structural engineer, do not be bashful in seeking their expertise.

### *Seeking Adequate Storage Volume*

The storage volume design element involves simply making sure a facility is large enough to accommodate the appropriate design criteria. However, one cannot imagine the difficulty that this criteria imposes on BMP designers. For one thing, a site is often simply not big enough to accommodate the required storage, so designers tend to make the "hole in the ground" deeper to accommodate the criteria. Ponds can end up excessively deep and frequently with steep side slopes. Another common problem arises when designing shallow marsh wetlands. Designers are trying to meet the dual objectives of obtaining a minimum water quality volume, while maintaining a shallow marsh system. Invariably, one or the other design objective looses. Two examples illustrate this point. The first was one of the pilot stormwater retrofit projects implemented in Montgomery County, Maryland in the late 1980's. In this facility, the planners and engineers were trying to meet a minimum water quality volume within a limited area constraint. The result was a 2-foot deep permanent pool that was intended to be a shallow marsh and instead resulted in a shallow pond (see Figure 3a). Likewise, for a project completed on Staten Island as part of the "South Richmond Bluebelt Restoration" effort, a shallow marsh stormwater facility was planted with Pickerelweed (*Pontederia cordata*) in 18 inches of water. Unfortunately, Pickerelweed does not typically survive in depths over about 12" (Thunhorst, et al., 1993) and, again, another shallow open water pond was created (see Figure 3b).



**Figure 3a: 2-foot deep pond in Montgomery County Maryland** (illustrating open water where a shallow marsh should be present)



**Figure 3b: 18-inch deep pond in Staten Island, New York** (illustrating open water where Pickerelweed should be growing)



## **BMP Construction and Maintenance**

This last area of successful BMP implementation involves the often-grueling process of getting designs constructed properly, and ensuring that practices are maintained over the long term. Construction of BMPs can be a very rewarding process. The satisfaction of seeing a set of design plans mature to a real world facility is very fulfilling. Unfortunately, the construction process is often where the "successful implementation" part of the process breaks down. There seem to be a number of commonalities, as discussed below.

### *BMP Construction*

There are a number of elements that contribute to a successfully constructed facility. Based on the author's experience, it is hard to say whether one element is more crucial than another. However, it is certainly true that any one flawed component can lead to a failed system. The following considerations are worth particular attention:

- Design drawings, details and specifications need to be clear, concise, unambiguous and correct. While there are certainly many places where construction problems can occur, it all starts with the engineering drawings. Engineers must take extra caution to produce plans that are error-free. Details should be easy to interpret and free of vague information. Designers need to consider the "twelve-year old rule." If one's twelve year old child will not understand it, then one is asking for interpretation problems by the contractor. Interpretation problems often lead to contract change orders and usually increase construction costs.
- The design engineer should be involved in the construction process, if possible. Where it is not possible, or preferable to retain the original designer, then an equally qualified engineer, who has design experience with the specific BMPs being constructed, should be involved in the project. "Involved with the project" means that the engineer supervises construction inspections, reviews shop drawings, participates in construction progress meetings, and coordinates directly with the contractor on critical construction issues.
- The contractor should have prior experience building the specific BMPs being proposed. Most construction contracts go to the low bidder. In fact, most municipal laws require that contracts go to the "lowest qualified bidder." The key word is "qualified." Bidding documents should contain specific requirements for contractors to submit prior work experience that are used as part of a "qualified bidder" assessment process. Many construction problems can be attributed to the fact that a contractor has never seen anything like an "underground sand filter" before, for example. Conversely, a qualified contractor can solve many unforeseen problems, often before they become problems.
- Do not start construction in November when working in a cold climate. Many stormwater practices involve earth moving operations, dewatering, and or stream diversions. Winter construction complicates almost everything. A good example was the University Boulevard Retrofit project in Maryland that started in the late fall of 1992 and finished about a year later. The original construction duration was estimated to be 120 days with a anticipated start date in May. But the county procurement process took over six months from the contract award to the "notice to proceed." While the project resulted in a very successful BMP, the construction process was brutal. The contractor could not meet compaction specifications due to excessive soil moisture, construction equipment was routinely mired in muck, concrete curing required tenting, and stabilization of disturbed areas was next to impossible. Not to mention the joy of attending weekly progress meetings in freezing weather (see Figure 4).



**Figure 4: University Boulevard Retrofit project in Maryland – during and after construction**  
 (illustrating the complexity of winter construction on the left and the successfully completed project on the right)

- "Work in the dry." Most BMPs are constructed at the bottom of a drainage system of one kind or another, and projects are not usually completed before at least a few precipitation events. Designers and contractors need to work together to divert storm flows around construction stages to prevent costly delays and/or downstream sediment transport.
- Make sure a professional land surveyor stakes out the project. Many projects end up being constructed with just a small variance from the original design drawings. In most cases, this is all right, but in some it means the difference between a successful project and failure. Shallow marsh wetlands require the maintenance of extremely tight tolerances to foster the different depth zones required for a complex wetland plant community. Filter strips function properly only when sheet flow is maintained. The slightest imperfection in a level spreader will result in concentrated flow. Sand Filters, which also rely on the distribution of flow across a level filter bed, need to be built to within very tight tolerances.
- Provide construction inspections to ensure facilities are built in accordance with approved design plans. This involves a commitment from the approving regulatory agency to develop inspection standards, train personnel on how to perform inspections, and provide enforcement mechanisms for those facilities that are not constructed in accordance with approved plans.

### *BMP Maintenance*

The key to successful BMP implementation is to provide needed maintenance in a manner that ensures that facilities will remain effective over the long term. A successful maintenance program should include at least the following three components:

- Inspection of facilities to identify and document material deficiencies
- Technical resources on how to correct facility deficiencies
- Enforcement provisions on how to deal with owners/operators who are unwilling or unable to correct material deficiencies

In practice, the key to a successful maintenance program is to develop an adequate funding source to perform inspections, correct facility deficiencies, and provide technical capabilities to owners/operators. Adequate funding is perhaps the greatest single hurdle for small municipalities that seek to implement successful stormwater management programs. The few communities that have succeeded have developed

either aggressive fee structures funded by new development, stormwater utilities that collect fees from existing residents and businesses that contribute to stormwater runoff impacts, or stormwater tax systems. While a review of stormwater funding is beyond the scope of this paper, it is generally agreed that the stormwater utility option appears to provide the most reliable source of funding for long-term maintenance implementation.

## Conclusion

To summarize, successful implementation of stormwater management BMPs requires careful attention to detail at several stages across the planning, design, construction and maintenance process. As municipalities move into the implementation of EPA's Phase II Stormwater Rule, practitioners should be aware of the several critical elements to successful BMP implementation. From the author's experience, successful programs include a number of key ingredients, such as:

- A comprehensive BMP design criteria that specifies such elements as practice selection, sizing requirements, geometry, landscaping, and maintenance provisions
- A training program for engineers and reviewers on the application of the design criteria
- A well-defined permitting process that includes adequate protections to ensure that facilities are constructed in accordance with approved plans (e.g., review fees, design checklists, surety, enforcement provisions)
- An adequately staffed and trained inspection force to ensure facilities are constructed in accordance with approved plans
- A long-term inspection and maintenance program to ensure facility function over time, and
- A funding source to ensure that above provisions are capable of being implemented

While stormwater BMPs are conceptually relatively easy to understand, they are too often used as a blunt instrument in a watershed manager's toolbox. They are a relatively simple technology that is being applied to help solve a very complex interaction between natural systems and human activities. The unfortunate message is that it may only take one lapse in judgment or lack of training on the part of any one of a variety of individuals, organizations, or institutions to implement a measure that may be partially or wholly ineffective at meeting the challenge of watershed protection. The hopeful message is that, from that author's experience, with thoughtful attention and diligent effort from those involved in the process, stormwater BMPs can be implemented successfully in a variety of applications to help meet a variety of watershed management objectives.

## References:

Center for Watershed Protection (CWP). 2002. *The Vermont Stormwater Management Manual – Final Draft*. Final Report to the Vermont Agency of Natural Resources. Center for Watershed Protection, Ellicott City, Maryland.

Claytor, R.A. 1998. An Eight Step Approach to Implementing Stormwater Retrofitting. in proceedings from National Conference on Retrofit Opportunities for Water Resource Protection in Urban Environments. February 9-12, 1998. Chicago, Illinois.

Galli, J. 1992. Analysis of Urban BMP Performance and Longevity in Prince George's County, Maryland. Metropolitan Washington Council of Governments. Washington, DC.

Massachusetts Department of Environmental Protection and Massachusetts Office of Coastal Zone Management (MADEP/CZM). 1997. Stormwater Management: Volume One: Stormwater Policy Handbook. Commonwealth of Massachusetts, Executive Office of Environmental Affairs, Boston, Massachusetts.

Natural Resources Conservation Services (NRCS), formerly the Soil Conservation Service. 1986. Urban Hydrology for Small Watersheds, Technical Release Number 55. US Department of Agriculture. Washington, DC.

Wilks, D. S. and R. P. Cember. 1993. Atlas of Precipitation Extremes for the Northeastern United States and Southeastern Canada. Northeast Regional Climate Center. Cornell University, Ithica, New York.

Oberts, G. 1997. *Lake McCarrons Wetland Treatment Systems – Phase II Study Report*. Metropolitan Council Environmental Services. St Paul, Minnesota.

Rizzo Associates. 2002. Drainage Report: The Village at Mattapoisett. Mattapoisett, Massachusetts.

Schueler, T. 1992. *Design of Stormwater Wetland Systems - Guidelines for Creating Diverse and Effective Stormwater Wetland Systems in the Mid-Atlantic Region*. Metropolitan Washington Council of Governments. Washington, DC. 131pp.

Strecker, E. 1992. *Pollutant Removal Performance of Natural and Created Wetlands for Stormwater Runoff*. Final Report to US EPA, Woodward Clyde Consultants, Inc. Portland, OR. 112pp.

Sourial, J., and R. Claytor. 2002. The Urban Japanese Stormwater Garden. finalist in the MIT/EPA Stormwater Competition. Cambridge, Massachusetts/

Thunhorst, G.A., D. R. Biggs, and B. E. Slattery. 1993. Wetland Planting Guide for the Northeastern United States. Environmental Concern, Inc. St. Michaels, Maryland.

Winer, R. 2000. *National Pollutant Removal Performance Database for Stormwater Treatment Practices, 2<sup>nd</sup> Edition*. Final Report to US EPA, Office of Science and Technology. Center for Watershed Protection. Ellicott City, Maryland. 29pp.

West, T. A., J. W. Sutherland, J. A. Bloomfield, and D. W. Lake, Jr. 2001. A Study of the Effectiveness of a Vortechs Stormwater Treatment System for the Removal of Total Suspended Solids and Other Pollutants in the Marine Village Watershed, Village of Lake George, New York. New York State Department of Environmental Conservation. Albany, NY.

[www.bmpdatabase.org](http://www.bmpdatabase.org). 2002. National Stormwater Best Management Practice (BMP) Database. website. Geosyntec Consultants, Wright Water Engineers, and the Denver Urban Drainage and Flood Control District. Sponsored by USEPA, Washington, DC. and the American Society of Civil Engineers, Reston, Virginia.

# EVALUATION OF NPDES PHASE 1 MUNICIPAL STORMWATER MONITORING DATA

Robert Pitt, Alex Maestre, and Renee Morquecho  
Dept. of Civil and Environmental Engineering  
University of Alabama  
Tuscaloosa, AL 35487

Ted Brown, Chris Swann, Karen Cappiella, and Tom Schueler  
Center for Watershed Protection  
Ellicott City, Maryland 21043

## Abstract

The University of Alabama and the Center for Watershed Protection were awarded an EPA Office of Water 104(b)3 grant in 2001 to collect and evaluate stormwater data from a representative number of NPDES (National Pollutant Discharge Elimination System) MS4 (municipal separate storm sewer system) municipal stormwater permit holders. The data are being collected and reviewed to both describe the characteristics of this data and to provide guidance to permit writers for future sampling needs.

There have been serious concerns about the reliability and utility of Phase 1 stormwater NPDES monitoring data, mainly due to the wide variety of experimental designs, sampling procedures, and analytical techniques used. On the other hand, the cumulative value of the monitoring data collected over nearly a ten year period from more than 200 municipalities throughout the country has a great potential in characterizing the quality of stormwater runoff and comparing it against historical benchmarks. This project is creating a national database of Phase 1 stormwater monitoring data, providing a scientific analysis of the data, and providing recommendations for improving the quality and management value of future NPDES monitoring efforts.

Each data set is receiving a quality assurance/quality control review, based on reasonableness of data, extreme values, relationships among parameters, sampling methods, and a review of the analytical methods. The statistical analyses is being conducted at several levels. Probability plots are used to identify range, randomness and normality. Clustering and principal component analyses are also being utilized to characterize significant factors affecting the data patterns. The master data set is also being evaluated to develop descriptive statistics, such as measures of central tendency and standard errors. We are testing for regional and climatic differences, the influences of land use, and the effects of storm size and season, among other factors.

This paper describes our data collected to date and presents some preliminary data summaries. We have been collecting much data to date, and encourage any other communities with wet weather outfall data collected as part of their NPDES permit program to contact us so we can include as much data as possible in our final effort.

## Project Description and Background

The importance of this project is based on the scarcity of nationally summarized and accessible data from the existing NPDES stormwater permit program. There have been some local and regional data summaries, but little has been done with nationwide data. A notable exception is the CDM national stormwater database (Smullen and Cave 2002) that combined historical NURP (Nationwide Urban Runoff Program) (EPA 1983), available urban USGS, and selected NPDES data. Their main effort has been to describe the probability distributions of this data (and corresponding EMCs, the event mean concentrations). They concluded that concentrations for different land uses were not significantly different, so all their data was pooled.

Other regional databases also exist, mostly using local NPDES data. These include the Los Angeles area database, the Santa Clara and Alameda County (CA) databases, the Oregon Association of Clean Water Agencies Database, and the Dallas area stormwater database. These regional data are (or will be) included in this comprehensive NPDES national database. However, we will not be including the USGS or historical NURP data in this NPDES database due to lack of consistent descriptive information for the older drainage areas. Much of the NURP data are available in electronic form at the University of Alabama student American Water Resources Association web page at: <http://www.eng.ua.edu/~awra/download.htm> The results from these other databases will be compared to our results during our final analyses to indicate any important differences.

This new NPDES database is unique in that detailed descriptions of the test areas and sampling conditions are also being collected, including aerial photographs and topographic maps for many locations which we are collecting from public domain Internet sources. The land use information used is as supplied by the communities submitting the data, although aerial photographs and maps are also used to clarify any questions. Most of the sites have homogeneous land uses, although many are mixed. These characteristics are all fully noted in the database.

This project is collecting stormwater runoff data from existing NPDES permit applications and permit monitoring reports; we are conducting QA/QC (quality assurance/quality control) evaluations of these data; and statistical analyses and summaries of these data. The final information will be published on the Internet (such as on an EPA OW-OWM, Office of Water and Office of Wastewater Management, site and on the Center for Watershed Protection's SMRC, Stormwater Manager's Resources Center, site at: <http://www.stormwatercenter.net/>). Some of the information is currently located at Pitt's teaching and research web site at: <http://www.eng.ua.edu/~rpitt/>.

The phase 1 NPDES communities included areas with:

- A stormwater discharge from a MS4 serving a population of 250,000 or more (large system), or
- A stormwater discharge from a MS4 serving a population of 100,000 or more, but less than 250,000 (medium system)

More than 200 municipalities, plus numerous additional special districts and governmental agencies were included in this program. Part 2 of the NPDES discharge permit application specified that sampling was needed and that the following was to be included in the application:

- Proposed monitoring program for representative data collection during the term of the permit.
- Quantitative data from 5 to 10 representative locations,

- Estimates of the annual pollutant load and event mean concentration (EMC) of system discharges,
- Proposed schedule to provide estimates of seasonal pollutant loads and the EMC for certain detected constituents during the term of the permit.

The permit applications were due in 1992 and 1993. For Part 2 of the application, municipalities were to submit grab (for certain pollutants) and flow-weighted sampling data from selected sites (5 to 10 outfalls) for 3 representative storm events at least 1 month apart. In addition, the municipalities must have also developed programs for future sampling activities that specified sampling locations, frequency, pollutants to be analyzed, and sampling equipment.

Numerous constituents were to be analyzed, including typical conventional pollutants (TSS, TDS, COD, BOD<sub>5</sub>, oil and grease, fecal coliforms, fecal strep., pH, Cl, TKN, NO<sub>3</sub>, TP, and PO<sub>4</sub>), plus many heavy metals (including total forms of arsenic, chromium, copper, lead, mercury, and zinc, plus others), and numerous listed organic toxicants (including PAHs, pesticides, and PCBs). Many communities also analyzed samples for filtered forms of the heavy metals. Our database includes information for about 125 different stormwater quality constituents, although the current database is mostly populated with data from 44 of the commonly analyzed pollutants (as summarized later in Table 3). Therefore, there has been a substantial amount of data collected during the past 8 or 9 years from throughout the country, although most of these data are not readily available, nor have detailed statistical analyses been conducted and presented.

## **Data Collection and Analysis Efforts to Date**

As of mid-December 2002, 3,757 events from 66 agencies and municipalities from 17 states have been collected and entered into our database. These locations are listed in Table 1. Table 2 lists 27 states where municipalities have been contacted and we plan to target for our next phase of data collection. Figure 1 shows the locations of these municipalities on a national map. We anticipate excellent national coverage, although we may have few municipalities from the northern west-central states of Montana, Wyoming, North and South Dakota (where cities are generally small, and few were included in the Phase 1 NPDES program).

Some of the municipalities that we have contacted (and some where we actually received data) have information that could not be used for various reasons. One of the most common reasons for not being able to use the data was that the samples had been collected from receiving waters (such as Washington state, Nashville, and Chattanooga). We are using data only from well-described stormwater outfall locations. These can be open channel outfalls in completely developed areas, but are more commonly conventional outfall pipes. The other major problem is that the sampling locations and/or the drainage areas were not described. We are using data with some missing information for now, with the intention of obtaining the needed information later. However, there will likely still be some minor data gaps that we will not be able to fill. In addition, the list of constituents being monitored has varied for different locations. Most areas evaluated the common stormwater constituents, but few have included organic toxicants. The most serious gap is the frequent lack of runoff volume data, although all sites have included rain data. Finally, if we collect all the data we have asked for, our current project resources will not permit us to fully utilize them, as it requires a great deal of time to enter and review this information.

The assembled data has been entered into a database which contains site descriptions (state, municipality, land use components, and EPA rain zone), sampling information (date, season, rain depth, runoff depth, sampling method, sample type, etc.), and constituent measurements (concentrations, grouped in categories).

In addition, more detailed site, sampling, and analysis information has been collected for each sampling site and included as supplemental information. We are using the reported land use information supplied by the communities, and are verifying some with aerial photographs and maps. In many cases, the sampled watersheds have multiple land uses and those designations are included in the database (we list the percentages of the drainage as residential, commercial, industrial, freeway, institutional, and open space). Our final data analyses will consider these mixed sites also, although the following preliminary results are only for the homogeneous land use sites.

***Preliminary Summary of Phase 1 Stormwater Data***

We plan to acquire additional stormwater data before our final data analysis, and to complete many of the missing records. The following data and analysis descriptions should therefore be considered preliminary and will change with these additional data and analyses. However, we are presenting only our most basic and robust analyses here for consideration. Our final report and data presentations will obviously be much more comprehensive.

**Table 1. Municipalities whose Data has been Entered into Database**

<b>ALABAMA</b>	<b>IDAHO</b>	<b>MINNESOTA</b>	<b>TEXAS</b>
Jefferson County Mobile	Ada County Highway District	Minneapolis	Arlington Dallas Dallas County
	<b>KANSAS</b>	<b>NORTH CAROLINA</b>	
<b>ARIZONA</b>	Topeka Wichita	Charlotte Fayetteville Greensboro	Fort Worth Garland Harris County Houston
Maricopa County Tucson			Irving
<b>CALIFORNIA</b>	<b>KENTUCKY</b>	<b>OREGON</b>	
Alameda Caltrans	Jefferson County Louisville Lexington	Clackamas County Eugene Gresham Portland	Mesquite Plano Tarrant County
<b>COLORADO</b>	<b>MASSACHUSETTS</b>		<b>VIRGINIA</b>
Denver Colorado Springs	Boston	Salem ODOT	Arlington County Chesapeake County Chesterfield County
	<b>MARYLAND</b>	<b>PENNSYLVANIA</b>	Fairfax County Hampton County
<b>GEORGIA</b>	Anne Arundel County Baltimore County Baltimore City Carroll County Charles County Harford County Howard County Montgomery County Prince Georges County State Highway	Philadelphia	Henrico County Newport News County Norfolk County Portsmouth County Virginia Beach County
Clayton County Cobb County De Kalb County Fulton County Gwinnett County Atlanta		<b>TENNESSEE</b>	
		Knoxville Memphis	

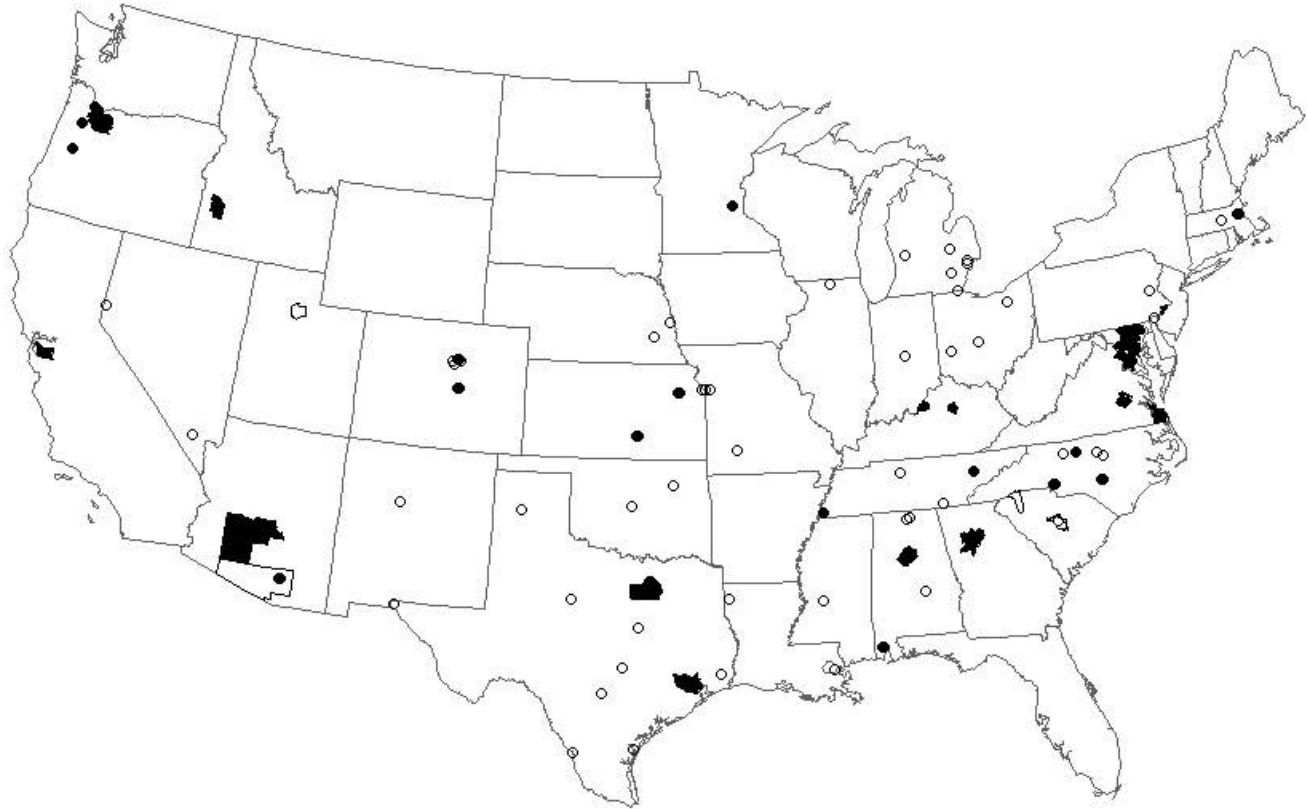


**Table 2. Communities Targeted for Next Phase of Data Collection**

<b>ALABAMA</b>	<b>ILLINOIS</b>	<b>NEBRASKA</b>	<b>PENNSYLVANIA</b>
Madison	Rockford	Lincoln	Allentown
Huntsville - Madison		Omaha	
Montgomery	<b>INDIANA</b>	<b>NEVADA</b>	<b>SOUTH CAROLINA</b>
	Indianapolis		Greenville County
<b>ALASKA</b>	<b>KANSAS</b>	Las Vegas	Richland County
Anchorage	Kansas City	Reno	Columbia
		Clark County	
<b>ARIZONA</b>	<b>LOUISIANA</b>	<b>NEW MEXICO</b>	<b>TEXAS</b>
Pima County	New Orleans	Albuquerque	Abilene
Mesa	Shreveport		Amarillo
Phoenix		<b>NEW YORK</b>	Austin
Tempe	<b>MASSACHUSETTS</b>	Various Communities	Beaumont
	Worcester		Corpus Christi
<b>CALIFORNIA</b>		<b>NORTH CAROLINA</b>	El Paso
Various Communities	<b>MICHIGAN</b>	Durham	Laredo
	Ann Arbor	Raleigh	Pasadena
<b>COLORADO</b>	Flint	Winston-Salem	San Antonio
Aurora	Grand Rapids		Waco
Lakewood	Sterling Heights	<b>OHIO</b>	<b>UTAH</b>
Littleton	Warren	Akron	Salt Lake County
		Columbus	Salt Lake City
<b>DELAWARE</b>	<b>MISSISSIPPI</b>	Dayton	
Wilmington	Jackson	Toledo	<b>WISCONSIN</b>
New Castle County			Milwaukee
<b>FLORIDA</b>	<b>MISSOURI</b>	<b>OKLAHOMA</b>	
Various Communities	Independence	Oklahoma City	
	Kansas City	Tulsa	
<b>HAWAII</b>	Springfield		
Honolulu County			

Table 3 is a summary of the Phase 1 data we have collected and entered into our database as of mid December 2002. The data are separated into six major land use categories: residential, mixed residential (but mostly residential), commercial, industrial, institutional, and freeways. Our open space and other mixed land use data are not included on these tables due to lack of space in this paper. This table also summarizes all data combined. The total number of events included in the database is 3,757, with most in the residential category. Many of the monitoring locations are characterized by mixed land uses. With the exception of the mixed residential area, only the main land use categories are shown separately on this table. For most common constituents, we have detectable values for almost all monitored events. However, filtered heavy metal observations, and especially organic analyses, have many fewer detected values. This table shows the percentage of analyzed samples that had detected values. The median and coefficient of variation (COV) values are only for those data having detectable concentrations. If we included the non-detected results in these calculations, extreme biases would invalidate many of the COV calculations. Our final analyses will

further examine issues associated with different detection limits, multiple laboratories, and varying analytical methods on the reported results and statistical analyses. See Burton and Pitt (2002), and the many included references in that book, for further discussions on these important issues.



**Figure 1. Data has been obtained and entered in our database for the communities shown in black. The other communities are targeted for our next data collection phase (plus Delaware, Alaska, Wisconsin, Southern California, Florida, and Hawaiian communities).**

**Table 3. Summary of Available Stormwater Data Included in NPDES Database**

<b>Land Use (Number of Events)</b>	<b>Area (acres)</b>	<b>% Imperv.</b>	<b>Precip. Depth (in)</b>	<b>Cond. (uS/cm @25°C)</b>	<b>Hardness (mg/L CaCO<sub>3</sub>)</b>	<b>pH</b>
<b>All Data Combined (3757)</b>						
Number of observations	3562	2036	3063	887	1115	1690
% of samples above detection	94	100	100	78	81	86
Median of detected values	45	50	0.47	121	39	7.4
Coefficient of variation	7.79	0.44	0.97	1.75	1.45	0.11
<b>Residential (983)</b>						
Number of observations	937	558	831	164	223	247
% of samples above detection	94	100	100	65	76	74
Median of detected values	57.3	37	0.455	96	31	7.13
Coefficient of variation	4.91	0.44	0.99	1.51	0.98	0.12
<b>Mixed Residential (584)</b>						
Number of observations	582	239	421	137	146	341
% of samples above detection	97	100	100	77	75	88
Median of detected values	104	40	0.56	116	43.4	7.3
Coefficient of variation	2.46	0.28	0.75	1.15	0.90	0.10
<b>Commercial (464)</b>						
Number of observations	442	211	399	73	120	152
% of samples above detection	90	100	99	90	94	91
Median of detected values	32	80	0.39	118.5	36	7.1
Coefficient of variation	4.83	0.11	1.05	0.98	1.04	0.13
<b>Industrial (471)</b>						
Number of observations	448	255	395	129	114	205
% of samples above detection	93	100	100	84	79	86
Median of detected values	37.9	71.8	0.47	136	37.3	7.2
Coefficient of variation	1.70	0.32	1.00	1.31	1.09	0.11
<b>Institutional (18)</b>						
Number of observations	18	18	17	0	0	0
% of samples above detection	100	100	100	n/a	n/a	n/a
Median of detected values	36	45	0.18	n/a	n/a	n/a
Coefficient of variation	0.00	0.00	0.91	n/a	n/a	n/a
<b>Freeways (185)</b>						
Number of observations	182	154	182	86	128	111
% of samples above detection	85	100	100	100	99	100
Median of detected values	0.99	80	0.54	99	34	7.1
Coefficient of variation	0.72	0.13	1.05	1.01	1.85	0.11

**Table 3. Summary of Available Stormwater Data Included in NPDES Database (cont.)**

	<b>TDS (mg/L)</b>	<b>TSS (mg/L)</b>	<b>BOD<sub>5</sub> (mg/L)</b>	<b>COD (mg/L)</b>	<b>Fecal Coliform (mpn/ 100 mL)</b>	<b>Fecal Strep. (mpn/ 100 mL)</b>
<b>All Data Combined (3757)</b>						
Number of observations	3062	3525	3135	2796	1764	1142
% of samples above detection	97	98	94	96	89	91
Median of detected values	78	63	8.3	52	5000	16000
Coefficient of variation	4.13	6.05	4.45	4.79	4.64	3.85
<b>Residential (983)</b>						
Number of observations	802	923	867	746	382	267
% of samples above detection	97	98	96	97	87	90
Median of detected values	69	50	9.05	55.5	7750	24000
Coefficient of variation	2.17	6.25	3.34	3.49	5.06	1.89
<b>Mixed Residential (584)</b>						
Number of observations	470	570	557	444	342	160
% of samples above detection	98	99	92	98	93	94
Median of detected values	85	74.8	7.16	40	11000	25000
Coefficient of variation	5.68	7.89	1.37	1.47	3.21	2.21
<b>Commercial (464)</b>						
Number of observations	378	446	410	353	215	152
% of samples above detection	98	98	94	96	87	90
Median of detected values	74	48	12	60	3000	9200
Coefficient of variation	1.92	4.85	1.12	1.01	3.93	2.84
<b>Industrial (471)</b>						
Number of observations	380	434	377	339	272	176
% of samples above detection	97	98	94	96	86	92
Median of detected values	84	90	9	61	2400	13050
Coefficient of variation	4.11	4.74	6.34	2.17	6.11	6.89
<b>Institutional (18)</b>						
Number of observations	18	18	18	18	0	0
% of samples above detection	100	94	89	89	n/a	n/a
Median of detected values	52.5	17	8.5	50	n/a	n/a
Coefficient of variation	0.67	0.83	0.70	0.91	n/a	n/a
<b>Freeways (185)</b>						
Number of observations	97	134	26	67	49	25
% of samples above detection	99	99	85	99	100	100
Median of detected values	77.5	99	8	100	1700	17000
Coefficient of variation	0.80	2.53	1.26	1.06	1.95	1.21

**Table 3. Summary of Available Stormwater Data Included in NPDES Database (cont.)**

	<b>NO<sub>2</sub>+NO<sub>3</sub> (mg/L)</b>	<b>Ammonia (mg/L)</b>	<b>Nitrogen, Total Kjeldahl (mg/L)</b>	<b>Phos., filtered (mg/L)</b>	<b>Phos., total (mg/L)</b>	<b>Oil and Grease (mg/L)</b>
<b>All Data Combined (3757)</b>						
Number of observations	3127	1874	3304	2470	3307	1830
% of samples above detection	96	75	95	89	96	71
Median of detected values	0.6	0.44	1.32	0.12	0.27	4
Coefficient of variation	1.99	3.45	3.64	2.44	8.74	4.50
<b>Residential (983)</b>						
Number of observations	863	564	879	656	885	473
% of samples above detection	97	87	96	90	96	66
Median of detected values	0.58	0.31	1.42	0.16	0.31	3.3
Coefficient of variation	1.93	2.14	3.87	0.98	8.13	7.79
<b>Mixed Residential (584)</b>						
Number of observations	542	255	562	399	554	254
% of samples above detection	96	57	94	90	95	74
Median of detected values	0.56	0.36	1.2	0.11	0.27	4
Coefficient of variation	1.01	2.96	1.85	3.70	7.98	2.53
<b>Commercial (464)</b>						
Number of observations	415	285	426	295	425	260
% of samples above detection	96	85	95	85	96	77
Median of detected values	0.62	0.57	1.6	0.1	0.23	5
Coefficient of variation	1.07	2.52	4.86	3.25	7.36	3.13
<b>Industrial (471)</b>						
Number of observations	398	243	411	301	403	287
% of samples above detection	94	91	95	90	97	74
Median of detected values	0.75	0.52	1.4	0.1	0.27	4
Coefficient of variation	0.96	3.60	2.53	1.25	6.79	3.28
<b>Institutional (18)</b>						
Number of observations	18	18	18	18	18	0
% of samples above detection	100	89	100	83	94	n/a
Median of detected values	0.6	0.31	1.35	0.14	0.17	n/a
Coefficient of variation	0.64	0.53	0.50	0.53	1.04	n/a
<b>Freeways (185)</b>						
Number of observations	25	79	125	22	128	60
% of samples above detection	96	87	97	95	99	72
Median of detected values	0.28	1.07	2	0.197	0.25	8
Coefficient of variation	1.23	1.73	1.37	2.13	1.76	0.62

**Table 3. Summary of Available Stormwater Data Included in NPDES Database (cont.)**

	<b>Sb, total (mg/L)</b>	<b>As, total (mg/L)</b>	<b>As, filtered (mg/L)</b>	<b>Be, total (mg/L)</b>	<b>Cd, total (mg/L)</b>	<b>Cd, filtered (mg/L)</b>	<b>Cr, total (mg/L)</b>
<b>All Data Combined (3757)</b>							
Number of observations	755	1425	209	842	2481	389	1561
% of samples above detection	9	49	27	10	49	31	63
Median of detected values	3	3.3	1.5	0.31	1	0.5	7
Coefficient of variation	2.56	2.42	1.00	2.74	4.42	1.69	1.47
<b>Residential (983)</b>							
Number of observations	214	366	32	239	599	85	383
% of samples above detection	2	37	6	11	38	6	50
Median of detected values	40	3	1.48	0.4	0.5	0.7	4.55
Coefficient of variation	1.11	2.42	0.50	2.92	5.20	0.55	1.31
<b>Mixed Residential (584)</b>							
Number of observations	74	170	18	76	398	30	172
% of samples above detection	4	65	28	16	51	40	72
Median of detected values	1	4	2	0.3	0.9	0.3	8
Coefficient of variation	1.59	3.78	0.84	2.86	3.53	0.64	1.62
<b>Commercial (464)</b>							
Number of observations	91	165	21	112	303	48	201
% of samples above detection	3	38	10	6	54	25	66
Median of detected values	69	2.5	1.5	0.5	0.86	0.33	6
Coefficient of variation	0.79	0.79	0.47	1.99	5.02	2.26	1.38
<b>Industrial (471)</b>							
Number of observations	123	219	23	164	329	42	215
% of samples above detection	18	58	13	12	60	55	72
Median of detected values	4.8	5	1	0.345	1.9	0.6	15
Coefficient of variation	1.37	0.94	0.43	2.55	3.77	1.10	1.13
<b>Institutional (18)</b>							
Number of observations	0	0	0	0	18	0	15
% of samples above detection	n/a	n/a	n/a	n/a	17	n/a	0
Median of detected values	n/a	n/a	n/a	n/a	0.5	n/a	n/a
Coefficient of variation	n/a	n/a	n/a	n/a	0.69	n/a	n/a
<b>Freeways (185)</b>							
Number of observations	14	61	72	12	95	114	76
% of samples above detection	50	56	50	17	72	26	99
Median of detected values	3	2.4	1.43	0.3	1	0.68	8.3
Coefficient of variation	0.25	0.70	1.15	0.47	0.90	1.03	0.71

**Table 3. Summary of Available Stormwater Data Included in NPDES Database (cont.)**

	<b>Cr, filtered (mg/L)</b>	<b>Cu, total (mg/L)</b>	<b>Cu, filtered (mg/L)</b>	<b>CN, total (mg/L)</b>	<b>Pb, total (mg/L)</b>	<b>Pb, filtered (mg/L)</b>	<b>Hg, total (mg/L)</b>
<b>All Data Combined (3757)</b>							
Number of observations	260	2770	413	1012	2902	446	1014
% of samples above detection	61	86	83	8	80	50	11
Median of detected values	2.08	16	8	5	15.9	3	0.2
Coefficient of variation	0.74	2.24	1.68	2.62	1.89	2.01	1.17
<b>Residential (983)</b>							
Number of observations	33	719	91	325	704	109	252
% of samples above detection	27	84	64	7	75	34	10
Median of detected values	1.28	11.1	7	5	12	3	0.2
Coefficient of variation	0.59	1.60	1.92	1.93	1.95	1.84	1.14
<b>Mixed Residential (584)</b>							
Number of observations	21	421	30	82	501	30	100
% of samples above detection	52	85	73	6	78	47	19
Median of detected values	2	18.7	5.75	0.01	19	3	0.3
Coefficient of variation	0.80	1.31	2.33	2.20	1.34	0.68	0.85
<b>Commercial (464)</b>							
Number of observations	27	360	49	144	345	59	133
% of samples above detection	41	96	80	15	95	54	11
Median of detected values	2	15	8	0.013	17	5	0.2
Coefficient of variation	0.59	1.55	1.50	1.69	1.70	1.61	0.79
<b>Industrial (471)</b>							
Number of observations	36	372	42	177	372	51	178
% of samples above detection	56	91	90	10	83	53	11
Median of detected values	3	21.8	8	5.92	23.7	5	0.1
Coefficient of variation	0.73	2.01	0.67	1.60	1.90	1.58	1.89
<b>Institutional (18)</b>							
Number of observations	0	17	0	0	0	0	0
% of samples above detection	n/a	41	n/a	n/a	n/a	n/a	n/a
Median of detected values	n/a	17	n/a	n/a	n/a	n/a	n/a
Coefficient of variation	n/a	0.59	n/a	n/a	n/a	n/a	n/a
<b>Freeways (185)</b>							
Number of observations	101	97	130	3	100	126	34
% of samples above detection	78	99	99	0	100	50	6
Median of detected values	2.3	34.7	10.9	n/a	27.5	1.8	0.19
Coefficient of variation	0.70	0.95	1.50	n/a	1.44	1.65	0.80

**Table 3. Summary of Available Stormwater Data Included in NPDES Database (cont.)**

	<b>Ni, total (mg/L)</b>	<b>Ni, filtered (mg/L)</b>	<b>Se, total (mg/L)</b>	<b>Ag, total (mg/L)</b>	<b>Zn, total (mg/L)</b>	<b>Zn, filtered (mg/L)</b>
<b>All Data Combined (3757)</b>						
Number of observations	1602	246	912	1149	3053	383
% of samples above detection	40	64	9	14	95	96
Median of detected values	9	4	2	3	112	51
Coefficient of variation	2.08	1.47	1.48	4.63	4.59	3.91
<b>Residential (983)</b>						
Number of observations	381	25	246	297	728	90
% of samples above detection	33	44	7	17	96	90
Median of detected values	6	2	2	5	73	32
Coefficient of variation	1.19	0.51	0.54	4.33	4.33	0.85
<b>Mixed Residential (584)</b>						
Number of observations	179	25	80	92	505	28
% of samples above detection	28	72	9	10	92	100
Median of detected values	10	5.5	4	2800	97	48
Coefficient of variation	0.84	0.87	0.89	2.02	1.06	0.88
<b>Commercial (464)</b>						
Number of observations	203	23	118	148	366	49
% of samples above detection	58	48	7	20	100	100
Median of detected values	7	3	2.5	5	150	59
Coefficient of variation	1.82	0.84	0.82	3.02	1.26	1.37
<b>Industrial (471)</b>						
Number of observations	225	36	175	216	387	42
% of samples above detection	53	58	10	23	98	95
Median of detected values	20	5	2	1	220	111.5
Coefficient of variation	0.87	1.43	0.98	4.28	2.28	3.62
<b>Institutional (18)</b>						
Number of observations	15	0	0	0	18	0
% of samples above detection	0	n/a	n/a	n/a	100	n/a
Median of detected values	n/a	n/a	n/a	n/a	305	n/a
Coefficient of variation	n/a	n/a	n/a	n/a	0.81	n/a
<b>Freeways (185)</b>						
Number of observations	79	95	16	21	93	105
% of samples above detection	87	67	6	19	97	99
Median of detected values	9.2	4	2	0.35	200	51
Coefficient of variation	0.92	1.38	n/a	0.87	1.01	1.86



**Table 3. Summary of Available Stormwater Data Included in NPDES Database (cont.)**

	<b>Methylene- chloride (mg/L)</b>	<b>Bis(2- ethylhexyl) phthalate (mg/L)</b>	<b>Di-n-butyl phthalate (mg/L)</b>	<b>Fluoranthene (mg/L)</b>
<b>All Data Combined (3757)</b>				
Number of observations	251	250	93	259
% of samples above detection	36	30	16	19
Median of detected values	11.2	9.5	0.8	6
Coefficient of variation	0.77	1.13	1.03	1.31
<b>Residential (983)</b>				
Number of observations	104	143	22	145
% of samples above detection	33	20	18	3
Median of detected values	11.3	4.5	10	3
Coefficient of variation	0.93	1.68	0.64	1.21
<b>Mixed Residential (584)</b>				
Number of observations	23	26	8	26
% of samples above detection	43	15	13	0
Median of detected values	9.05	5.1	14	n/a
Coefficient of variation	0.51	0.38	n/a	n/a
<b>Commercial (464)</b>				
Number of observations	42	72	20	75
% of samples above detection	21	44	25	35
Median of detected values	9.2	10.1	0.7	5.9
Coefficient of variation	0.40	1.07	1.39	4.38
<b>Industrial (471)</b>				
Number of observations	33	49	12	51
% of samples above detection	33	43	25	25
Median of detected values	9.7	10	0.7	3.8
Coefficient of variation	0.40	0.81	0.09	0.97
<b>Institutional (18)</b>				
Number of observations	0	0	0	0
% of samples above detection	n/a	n/a	n/a	n/a
Median of detected values	n/a	n/a	n/a	n/a
Coefficient of variation	n/a	n/a	n/a	n/a
<b>Freeways (185)</b>				
Number of observations	0	0	0	0
% of samples above detection	n/a	n/a	n/a	n/a
Median of detected values	n/a	n/a	n/a	n/a
Coefficient of variation	n/a	n/a	n/a	n/a

**Table 3. Summary of Available Stormwater Data Included in NPDES Database (cont.)**

	Phenanthrene (mg/L)	Pyrene (mg/L)	Diazinon (mg/L)	2, 4-D (mg/L)
<b>All Data Combined (3757)</b>				
Number of observations	233	249	79	101
% of samples above detection	13	14	22	35
Median of detected values	3.95	5.2	0.06	3
Coefficient of variation	1.00	1.24	1.90	0.86
<b>Residential (983)</b>				
Number of observations	136	140	11	11
% of samples above detection	3	4	36	64
Median of detected values	1.7	2.2	30	8
Coefficient of variation	0.70	0.30	0.40	0.72
<b>Mixed Residential (584)</b>				
Number of observations	23	26	1	2
% of samples above detection	0	0	0	50
Median of detected values	n/a	n/a	n/a	5
Coefficient of variation	n/a	n/a	n/a	n/a
<b>Commercial (464)</b>				
Number of observations	70	75	19	13
% of samples above detection	31	35	42	69
Median of detected values	4.05	5	0.045	3
Coefficient of variation	4.50	4.57	0.49	0.94
<b>Industrial (471)</b>				
Number of observations	47	47	9	3
% of samples above detection	17	21	33	100
Median of detected values	9	7.2	0.72	2
Coefficient of variation	0.72	0.73	1.40	1.14
<b>Institutional (18)</b>				
Number of observations	0	0	0	0
% of samples above detection	n/a	n/a	n/a	n/a
Median of detected values	n/a	n/a	n/a	n/a
Coefficient of variation	n/a	n/a	n/a	n/a
<b>Freeways (185)</b>				
Number of observations	0	0	1	1
% of samples above detection	n/a	n/a	100	0
Median of detected values	n/a	n/a	0.05	n/a
Coefficient of variation	n/a	n/a	n/a	n/a

## *Data Analyses*

Statistical analyses are being conducted at several levels. First, probability plots are used to identify range, randomness, and normality. Figure 3 (end of paper) is an example of log-normal probability plots for some of the constituents and for all data pooled. Probability plots shown as straight lines indicate that the concentrations can be represented by log-normal distributions. This is important as it indicates that data transformations, or the use of nonparametric statistical analyses, will be needed. Other plots with obvious discontinuities (such as for bacteria, phosphorus, lead, and zinc) imply that multiple data populations may be included. Our future analyses will identify the significance of these different data categories (such as land use, region, and season).

Clustering and principal component analyses (PCA) are also being utilized to characterize expected factors influencing sample variability. Figure 4 is an example dendrogram from a cluster analysis of all of the preliminary data combined. This plot indicates very close relationships between rain depth and the nutrients (total phosphorus, dissolved phosphorus, nitrite plus nitrate, ammonia, and Total Kjeldahl Nitrogen). Some of the heavy metals (cadmium, nickel, and chromium) are closely related to each other, but copper, lead and zinc are much more independent. BOD<sub>5</sub>, COD, dissolved solids, and suspended solids are poorly related to other pollutants for the pooled data. Pearson correlation analyses did show relatively strong relationships between suspended solids and the total forms of most of the heavy metals, substantiating the observation that most of the stormwater metals are not in filtered forms.

The master data set will also be evaluated to develop descriptive statistics, such as measures of central tendency and standard errors. The runoff data will then be evaluated to determine which factors have a strong influence on event mean concentrations, including sampling methods. We will test for regional and climatic differences, the influence of land use, and the effect of storm size, among other factors. Figure 5 includes example scatter plots of COD vs. BOD<sub>5</sub> and filtered copper vs. total copper, illustrating these suspected close relationships. Also shown on this figure are scatter plots of suspended solids and phosphorus concentrations for different rain depths. Little variation of these concentrations with rain depth are seen when all of the data are combined, implying little likelihood of important “first-flush” effects at stormwater outfall locations. Specific comparisons of concentrations from first-flush samples with concurrent composite samples will be a more direct test and will be conducted later.

Figures 6 and 7 are example grouped box and whisker plots of suspended solids, total Kjeldahl nitrogen, fecal coliforms, and copper, grouped for different major land uses and for different seasons. The TKN and copper observations are lowest for open space areas, while the freeway locations had the highest values. Suspended solids and fecal coliform variations are not as obvious, although it is likely that the freeway bacteria values are significantly lower than those found in residential areas. The seasonal variations are not as obvious, except that the bacteria values appear to be lowest during the winter season (a similar conclusion was obtained during the NURP, EPA 1983, data evaluations). Preliminary statistical ANOVA analyses for all land use categories (using SYSTAT) found significant differences for land use categories for all pollutants. Our final analyses will further investigate this important finding and will also examine possible confounding factors.

A major goal of these analyses will be to provide guidance to stormwater managers and regulators. Especially important will be the use of this data as an updated benchmark for comparison with locally collected data. In addition, this data may be useful for preliminary calculations when using the “simple method” for predicting mass discharges for unmonitored areas. This data can also be used as guidance when

designing local stormwater monitoring programs (Burton and Pitt, 2002), especially when determining the needed sampling effort based on expected variations.

We will also be examining trends of concentrations with time. A classical example would be for lead, which is expected to decrease over time with the current use of unleaded gasoline. Older stormwater samples from the 1970s typically have had lead concentrations of about 100 µg/L, or higher, while most current data indicate concentrations in the range of 1 to 10 µg/L. Figure 8 is a plot of lead concentrations for residential areas only, for the time period from 1991 to 2002. This preliminary plot shows likely decreasing lead concentrations with time for all residential sites combined. However, more work is needed to investigate interacting factors and other relationships of potential interest in order to reduce the variability inherent in this (and the other preliminary) plots.

Our final analyses will expand on these preliminary examples and will also investigate other stormwater data and sampling issues. As an example, we will compare “first flush” samples with composite samples for a number of locations and conditions (the above data only represent composite samples) and will also compare data collected manually vs. automatically.

As we are still collecting information for the database, we encourage all local and state agencies who have Phase 1 municipal stormwater data but have not previously sent it to us, to please contact us so we can arrange to have your data included in our final analyses.

## References

- Burton, G.A. Jr., and R. Pitt, 2002. *Stormwater Effects Handbook: A Tool Box for Watershed Managers, Scientists, and Engineers*. CRC Press, Inc., Boca Raton, FL. 911 pgs.
- Smullen, J.T. and K.A. Cave, 2002. “National stormwater runoff pollution database.” In: *Wet-Weather Flow in the Urban Watershed*, edited by R. Field and D. Sullivan. Lewis Publishers. Boca Raton, pgs. 67 – 78.
- U.S. Environmental Protection Agency, Dec. 1983. *Results of the Nationwide Urban Runoff Program*. Water Planning Division, PB 84-185552, Washington, D.C.

## Acknowledgements

Many people and institutions need to be thanked for their help on this research project. Project support and assistance from Bryan Rittenhouse, the US EPA project officer for the Office of Water, is gratefully acknowledged. The many municipalities who worked with us to submit data and information were obviously crucial and the project could not be conducted without their help. Finally, a number of graduate students at the University of Alabama (especially Veera Rao Karri, Sanju Jacob, and Sumandeep Shergill) and employees of the Center for Watershed Protection are also thanked for their careful work.

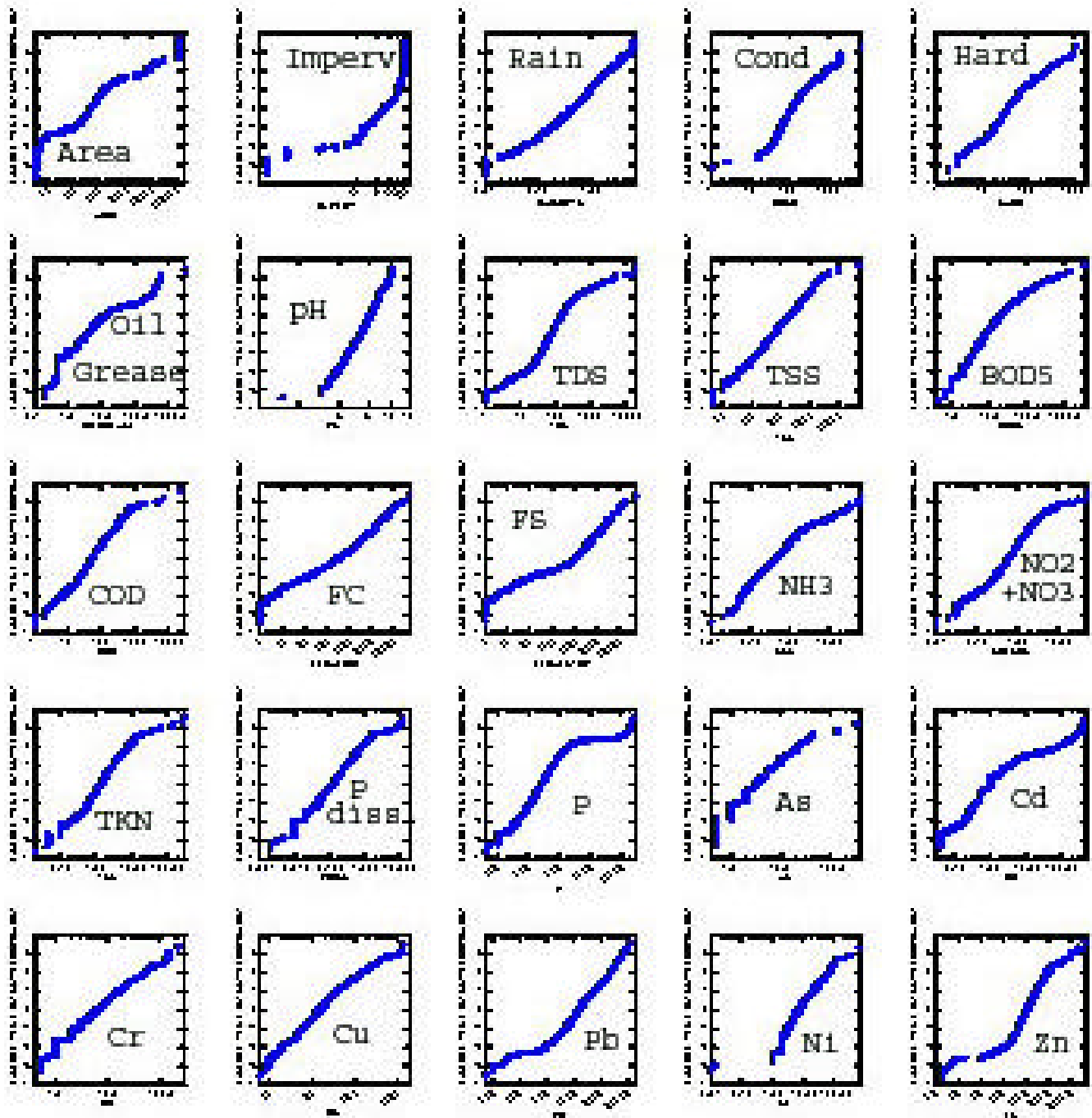


Figure 3. Log-normal probability plots of selected stormwater quality data.

# Cluster Tree

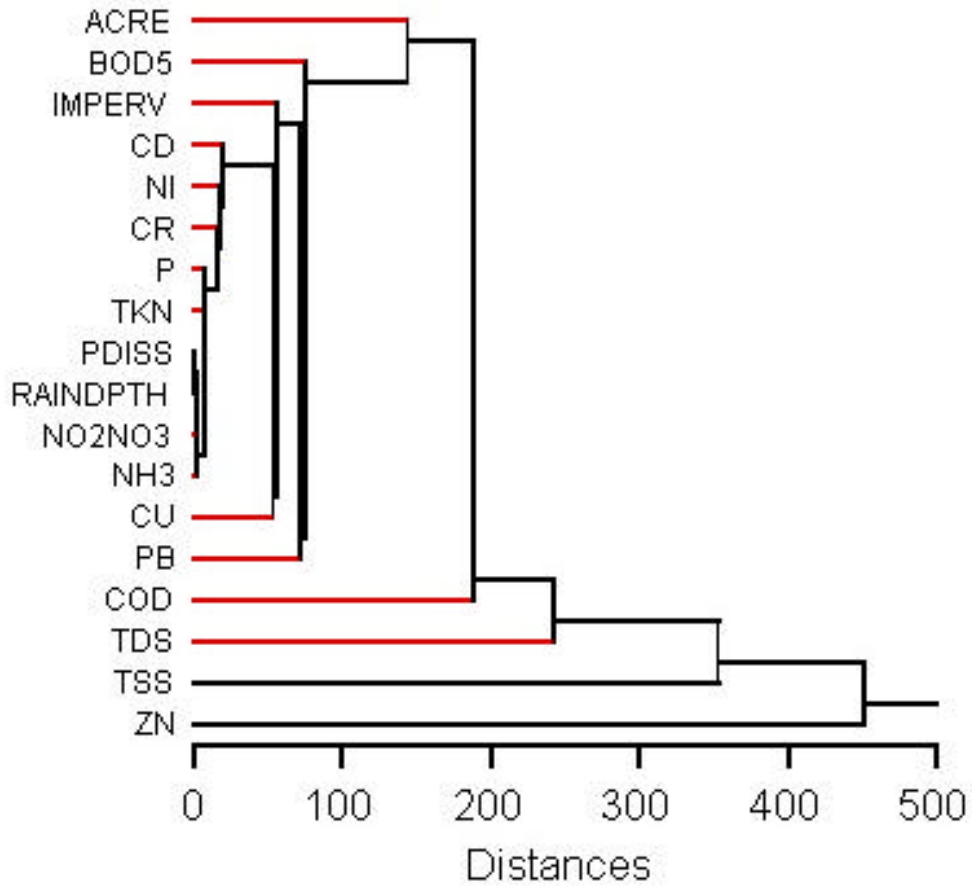


Figure 4. Cluster analysis (dendrogram) showing relationships between stormwater pollutants.

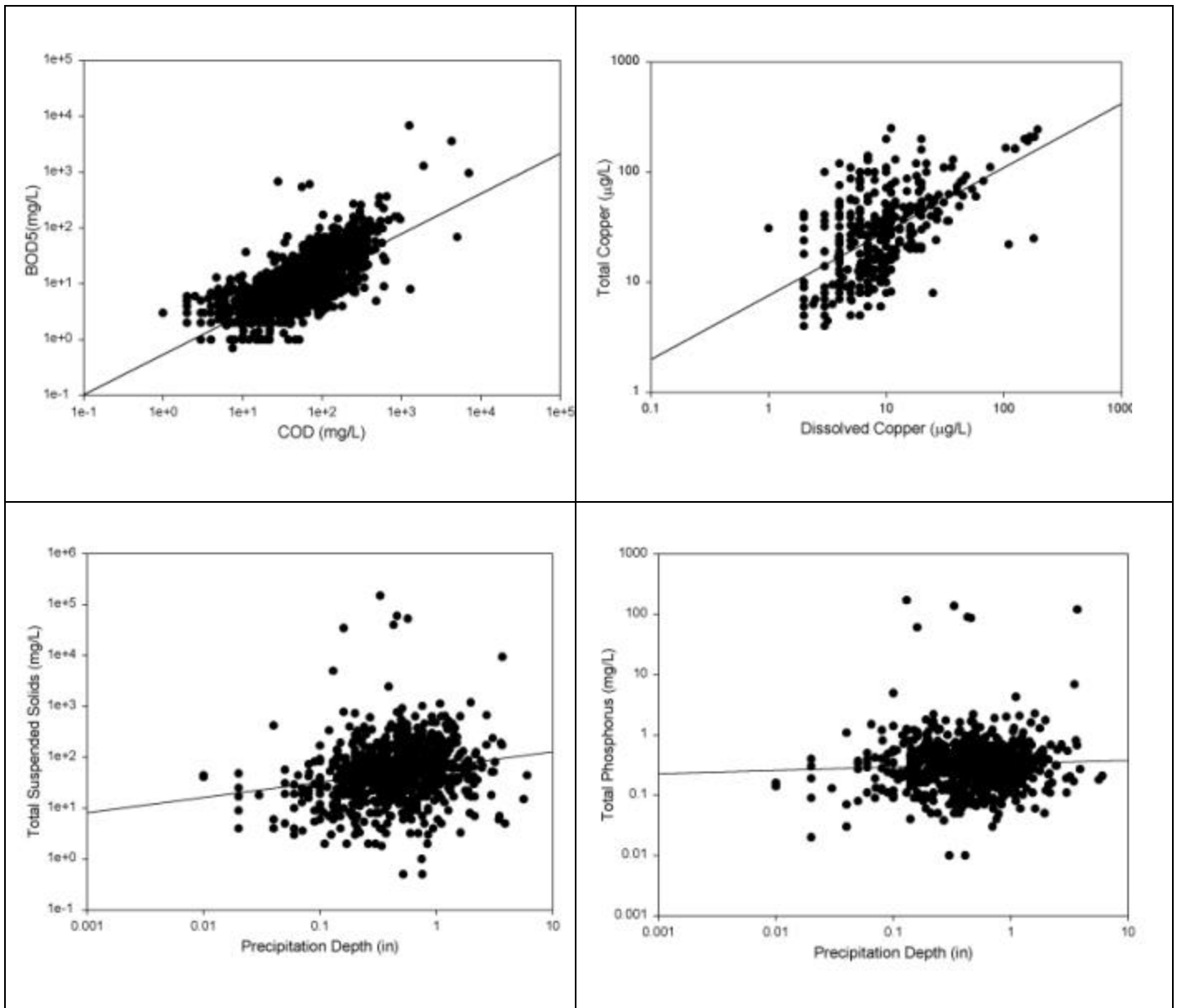


Figure 5. Example scatter plots of stormwater data.

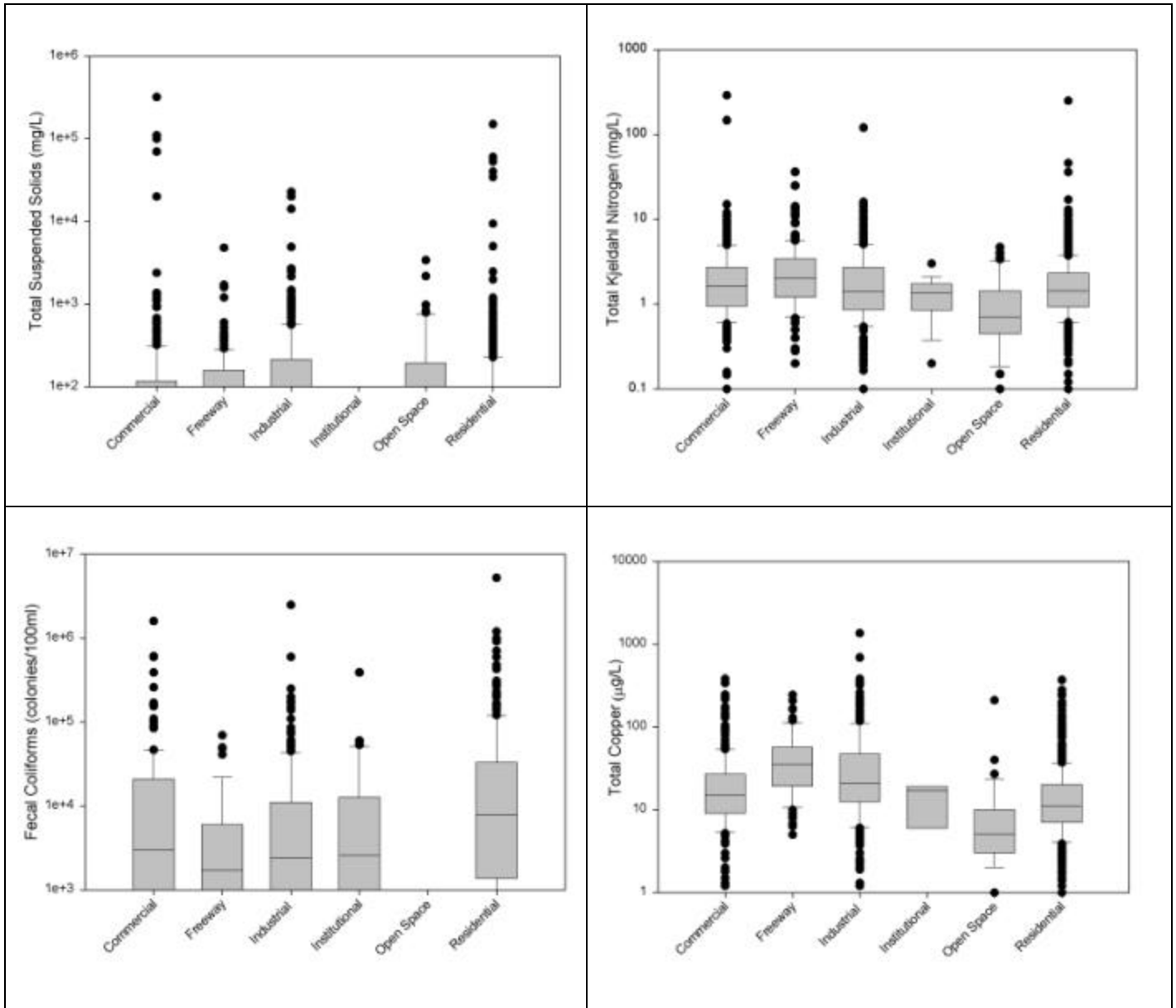


Figure 6. Example stormwater data sorted by land use (no mixed land use data included in plots).



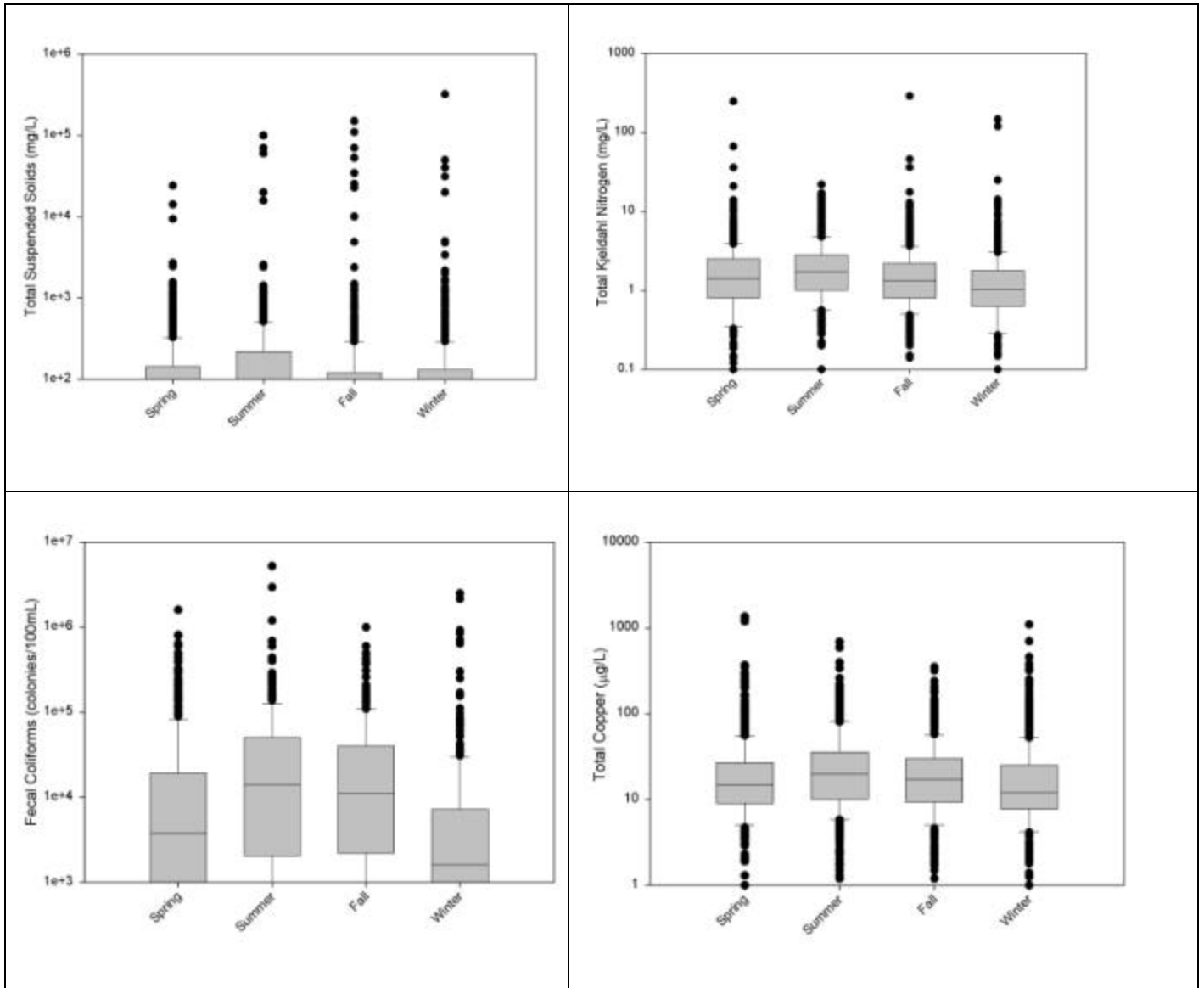


Figure 7. Example residential area stormwater pollutant concentrations sorted by season.

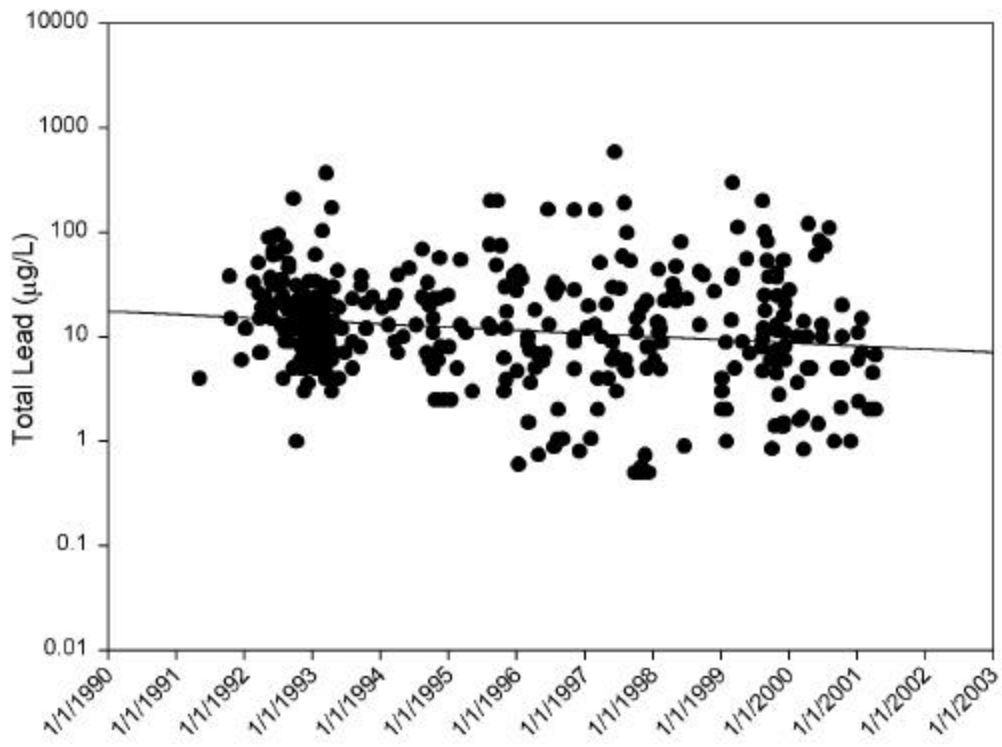


Figure 8. Residential lead concentrations with time.

# Funding Phase II Storm Water Programs

Andrew J. Reese  
AMEC Earth & Environmental, Inc.  
Nashville, TN  
615-333-0630  
andrew.reese@amec.com

## Abstract

Most Phase II cities are now in the midst of looking at how to fund their stormwater Phase II programs. The cost of Phase II is widely variable but expected to be in the range of \$3.75 to \$6.00 per citizen per year when the program is fully formed. Not all of those costs are new line items in a local budget. This paper explores an approach for funding that combines a variety of methods or sources available to most local governments – many of them not requiring new funds at all but using human resources instead. A hierarchy of methods is established and a cost effectiveness method of program development defined.

## Introduction

NPDES Phase II programs are in the final stages of planning. Assuming you have the authority and organizational issues worked out (a BIG assumption), at about this point in the process Municipal Separate Storm Sewer system owners and operators are asking the difficult question: “so how do we pay for the six minimum controls?” Perhaps a better question is, “how can I best define a program that I can pay for?” Under Phase I many communities defined a program, often in a vacuum, and then attempted to find ways to fund it. Under Phase II the majority of the efforts under the six minimum controls required are highly integrated with current stormwater program efforts. Thus, it makes sense to formulate a stormwater program by working from both ends toward the middle – funding or resource sources and program requirements.

## Phase II Costs

There have been several attempts to estimate the probable costs of the NPDES Phase II stormwater program. EPA’s overall annual estimate for all permittees is nearly one billion dollars. Most individual MS4 estimates are expressed in terms of cost per person per year, though the actual costs do not always lend themselves very well to this yard stick. EPA itself, based on very scattered data and surveys, established their cost estimate as \$1,525 per permittee + \$3.50 per person which, plotted, looks like Figure 1.

Reese, et al, (2000) provide cost estimates for model stormwater Phase II programs for a small town and a city of 50,000 in

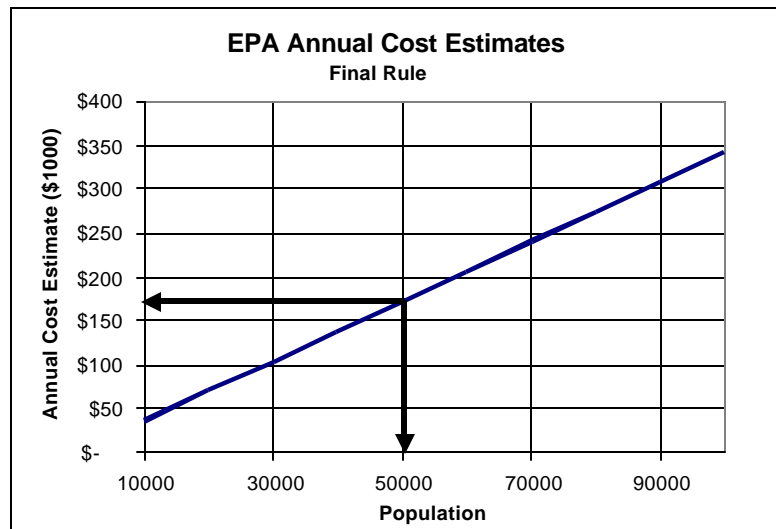


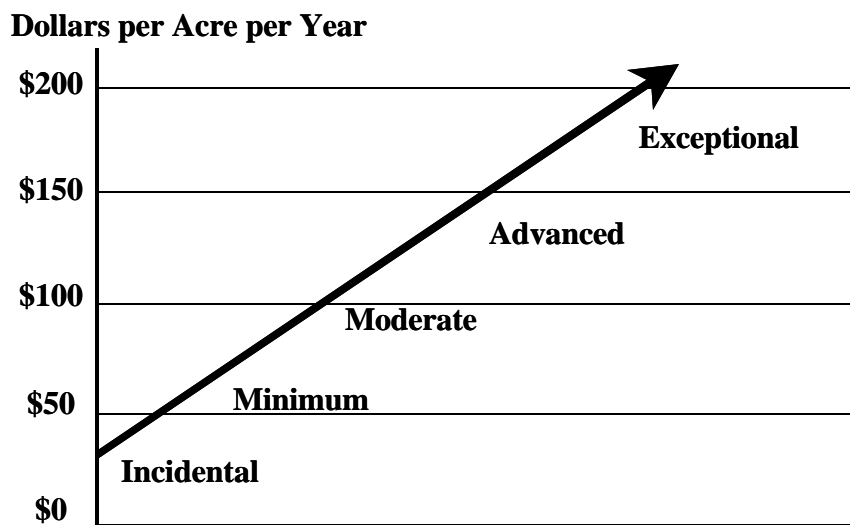
Figure 1. EPA Cost Estimates for Phase II Program Implementation

population. However, as they point out, there are great variations in the potential costs of any stormwater Phase II program due to such things as:

- Character of the MS4
- Climate and geology
- Preferences of the permit writer and specific requirements of the state
- Maturity of current stormwater program
- Character of stream quality and need for improvement
- Ability to share costs with others

Based on that analysis and subsequent work by the Denver Urban Drainage and Flood Control District (personal communication) a range of cost (on a per person per year basis for a fully developed Phase II program) was established between about \$1.50 and \$8.00 in today’s dollars for a very minimal and fairly well developed stormwater program for a city of 50,000 (Reese, et al, 2000). This range is not very helpful in actually estimating Phase II program costs other than to point out and illustrate the great variability and flexibility in the program.

Another way to arrive at the potential cost is to recognize that most MS4s that have already implemented a fairly advanced stormwater quality program spend about 15 to 25 percent of their total stormwater dollars on stormwater quality aspects – a subset of which is Phase II compliance. Figure 2 shows typical stormwater program costs for a range of stormwater program maturities on a per developed acre per year basis. This is based on the author’s firm’s experience in over 100 cities and counties.



**Figure 2.** Average Annual Per Developed Acre Stormwater Program Costs

Assuming typical numbers of about three persons per acre (2000 per square mile), and that stormwater quality compliance aspects make up roughly 15 percent of the program then for a moderate program the cost of the stormwater quality program is in the range of \$3.75 to \$6 per person per year.

However it needs to be stated that not all of these costs are monetary, and not all of them are new costs. These numbers simply reflect a level of effort necessary to implement the permit, not a budgetary line item in some City's comprehensive annual financial report. As we will see below, that effort can be realized in many ways, not all of them fully budgetary.

## **The MEP Standard and Cost**

The NPDES regulatory compliance program for stormwater is based on the dual standard of "prohibition" and "maximum extent practicable (MEP)." Prohibition means keeping non-stormwater from the stormwater system. MEP means addressing and mitigating all the ways pollutants get into the system including dirty stormwater, and doing so to one's maximum ability.

MEP consists of the mix of Best Management Practices (BMPs) and measurable goals that will attain reduction of pollution to attain water quality standards. This is described in 40 CFR 68754, Dec. 8<sup>th</sup>, 1999, as follows (*italics mine*):

The pollutant reductions that represent MEP may be different for each small MS4, given the unique local hydrologic and geologic concerns that may exist and the differing possible pollutant control strategies. Therefore, each permittee will determine appropriate BMPs to satisfy each of the six minimum control measures through an evaluative process. EPA envisions application of the MEP standard as an iterative process. MEP should continually adapt to current conditions and BMP effectiveness and should strive to attain water quality standards. Successive iterations of the mix of BMPs and measurable goals will be driven by the objective of assuring maintenance of water quality standards. If, after implementing the six minimum control measures there is still water quality impairment associated with discharges from the MS4, after successive permit terms the permittee will need to expand or better tailor its BMPs within the scope of the six minimum control measures for each subsequent permit. EPA envisions that this process may take two to three permit terms.

MEP really depends on the consideration of several things as illustrated in Figure 3:

- Do I have, or can I obtain, the legal authority to carry out the program I am describing?
- Is my technical approach sound in that it is a "proven" approach, structural or non-structural that addresses pollutants of concern in an effective manner?
- Are my defined procedures, policies, staff resources and equipment appropriate for the level and type of program described?
- Do I have, or can I obtain, dedicated and sufficient funding to support the program I am describing?

Currently there are no specific numeric criteria for stormwater discharges (unless established under a TMDL or court induced program), and there will not be until 2013. MEP is considered a flexible, narrative, technology-based standard. If you do what you say you are going to do you are, by definition, in compliance – regardless of the actual water quality. Monitoring may be required in the second round for a percentage of MS4's to prove that water bodies are attaining water quality standards. If not...the requirements will be tightened. Remember that the congressionally mandated goal is to meet water quality standards (as they are currently defined or may change as newer wet weather approaches are developed),

Maximum Extent Practicable				
	LEGAL	TECHNICAL	ADMINISTRATIVE	FINANCIAL
Public Education				
Public Involvement	✓	✓	✓	✓
Illicit Connection				
Construction	✓		✓	✓
Post-Construction		✓		
Pollution Prevention	✓			

**Figure 3.** Definition of Maximum Extent Practicable

and EPA plans to negotiate a change in the definition of MEP for you on the basis of existing or collected monitoring information in each successive permit period.

Language throughout the preamble to the permit language and in the congressional record describing MEP definitions also contains the term “cost effective” when it describes BMP programs. This term “cost effective” has not been defined either but can serve as a critical basis when selecting among BMP options, the level of the stormwater quality program, and funding needs.

The fact that cost should and can be considered when developing an MEP program is incontrovertible – to what extent, that is a source of controversy and must be balanced with other considerations. Consider:

- President Clinton’s Clean Water Initiative (USEPA, 1994) addressed a number of issues associated with NPDES requirements for storm water discharges and proposed establishing a phased compliance with a water quality standards approach for discharges from municipal separate storm sewer systems with priority on controlling discharges from municipal growth and development areas and clarifying that the maximum extent practicable standard should be applied in a site-specific, flexible manner, taking into account cost considerations as well as water quality effects.
- EPA has stated (see footnote 1) that MS4s need the flexibility to optimize reductions in storm water pollutants on location-by-location basis. EPA envisions that this evaluative process will consider such factors as conditions of receiving waters, specific local concerns, and other aspects included in comprehensive watershed plan. Other factors may include MS4 size, climate, implementation schedules, current ability to finance the program, beneficial uses of receiving water, hydrology, geology, and capacity to perform operation and maintenance.

- In California the State Water Quality Board provided the following explanation of MEP<sup>1</sup>: "There must be a serious attempt to comply, and practical solutions may not be lightly rejected. If, from the list of BMPs, a permittee chooses only a few of the least expensive methods, it is likely that MEP has not been met. On the other hand, if a permittee employs all applicable BMPs except those where it can show that they are not technically feasible in the locality, or whose cost would exceed any benefit to be derived, it would have met the standard. MEP requires permittees to choose effective BMPs, and to reject applicable BMPs only where other effective BMPs will serve the same purpose, the BMPs would not be technically feasible, or the cost would be prohibitive. Thus while cost is a factor, the Regional Water Board is not required to perform a cost-benefit analysis."

## Funding Sources

The objective of a local stormwater manager in setting up his or her Phase II program is to find a program that attempts to meet the long-term objective of the Clean Water Act while being affordable – knowing there is both an ability to consider cost (and funding) in developing the program and a mandate to not let cost rule the final outcome.

Much has been written about the program side of the equation – focusing first on the worst problems and on those problems that are important to the local community and then filling in the rest of the six minimum controls. Lets focus on the funding side of the equation.

There are many ways to help resource the NPDES program that cost little – but it will take some imagination. As local communities look at the potential program needs they have a variety of ways to resource the program. These ways fall naturally into a hierarchy of ease of resource acquisition or use. A local community should systematically look to the following resource sources prior to looking to the general fund and the other usual culprits. In this discussion I will assume that there is currently little or no actual stormwater quality work being done in the community.

*1. Modify local programs* The first step in the resourcing analysis is to look at the current local program and see what is being done that looks and smells like Stormwater Phase II. Based on looking at several stormwater programs we have found that, perhaps, 25 percent of a typical Phase II program is already being done to some extent by current staff, or similar things are being done. With suitable adjustment and refocus some responsibilities can be covered by current staff as part of, or a redefinition of, their current duties. In some cases it will take little effort to redefine or describe current practices. Table 1 contains a set of potential areas to look for each of the six minimum controls.

*2. Share costs with neighbors or region/state-wide* Much of what can be done can be done more cheaply sharing the cost. After determining what you can already do in-house, or offer to others, the next step is to see what others can offer to you. Phase I saw large numbers of group permits issued causing regional approaches to spring up. There are various types of relationships that can be formed for sharing. In one set of cities each agreed share costs for a minimal program and go independently for a more advanced program. Costs can be shared for all activities that each community has to do in a similar fashion. This includes a whole host of things for each of the minimum controls including things like models, joints and bulks:

---

<sup>1</sup> California State Water Quality Board Order WQ 2000-11, page 19.

- “Models” – model brochures, ordinances, bill stuffers, checklists, instruction manuals, white papers, curriculum, etc.
- “Joints” – joint design criteria, videos, billboards, procedure manuals, brochures, web sites, advertising, etc.
- “Bulks” – Bulk orders for printing, stencils, placards, other PR materials, manual printing, etc.

**Table 1.** Some Potential Existing Stormwater Program Modification Areas

<p><b>1. Public Education</b></p> <ul style="list-style-type: none"> <li>• Inserts in other bills</li> <li>• Speakers bureau</li> <li>• PAO staff person</li> <li>• Brochure printing and distribution capability and channels</li> <li>• Public access TV</li> <li>• Web site</li> <li>• Watershed signage</li> <li>• Library</li> </ul>	<p><b>3. Illicit Connections</b></p> <ul style="list-style-type: none"> <li>• GIS coverage</li> <li>• SARA Title III program</li> <li>• Pretreatment program</li> <li>• Land use mapping</li> <li>• System inventory</li> <li>• Mayor’s complaint hotline</li> <li>• Water and wastewater monitoring program</li> <li>• Camera and smoke testing capability in water and wastewater</li> <li>• Household hazardous waste collection day</li> <li>• Recycling programs</li> <li>• Field personnel</li> <li>• Used oil programs</li> <li>• Web site</li> </ul>	<p><b>5. Post Construction BMPs</b></p> <ul style="list-style-type: none"> <li>• Current zoning, stormwater and subdivision ordinances</li> <li>• Current design criteria manual</li> <li>• Open space and related ordinances</li> <li>• Current overlay districts</li> <li>• Master plans</li> <li>• Floodplain program</li> </ul>
<p><b>2. Public Involvement</b></p> <ul style="list-style-type: none"> <li>• Citizen advisory group or panel</li> <li>• Festivals</li> <li>• Scout troops</li> <li>• Internships</li> <li>• Non-profit groups</li> <li>• Clubs</li> <li>• Web site</li> <li>• Storm drain labeling programs</li> <li>• Stream walks</li> </ul>	<p><b>4. Construction BMPs</b></p> <ul style="list-style-type: none"> <li>• Current ordinance and development process</li> <li>• Site inspections</li> <li>• Other building inspectors (e.g. electrical, plumbing)</li> <li>• Mayor’s complaint line</li> <li>• Web site</li> <li>• Bonding program</li> <li>• Plan review checklists</li> </ul>	<p><b>6. Municipal Housekeeping</b></p> <ul style="list-style-type: none"> <li>• Street, storm drain and other maintenance programs</li> <li>• Current employee training programs</li> <li>• Current materials handling programs</li> <li>• Current flood control specifications and in-place structures</li> <li>• Recycling program</li> <li>• Adopt a highway programs</li> <li>• Neighborhood and non-profit groups</li> <li>• Street sweeping program</li> <li>• Waste disposal program</li> </ul>

*3. Get free information on the web* The Internet has hundreds of sites giving examples of BMPs, manuals, ordinances, documents, guidance, pamphlets, etc. Literally almost every written document that might be necessary has been developed somewhere and is available free of charge. The experience of other Phase I cities is especially helpful for Phase II cities. Fort Worth (<http://ci.fort-worth.tx.us/dem/sitemap.htm>) especially has a helpful web site with multiple links to other sites. The Center for Watershed Protection



(<http://www.cwp.org/>) offers a multitude of helpful documents and links and their stormwater center (<http://www.stormwatercenter.net/>) has hundreds of references and assistance tools. Other useful sites include <http://www.mtas.utk.edu/bmptoolkit.htm> , <http://www.dfstormwater.com>, which have links sorted by each of the six minimum controls. EPA's website (best found from a search as it changes quite often) offers significant Phase II guidance as well as information on many related programs.

4. *Partner with non-profits* There are hundreds of non-profit organizations created to accomplish various environmentally related functions. Often these groups will adopt a watershed, provide workers, perform monitoring, do public education and involvement campaigns (they are a public involvement campaign), and find sources of money not available to local governments (501(c)(3) grants to non profits). Some local communities actually assist them in finding and applying for grants. They also are less willing to file a lawsuit against a local government when they are partners with it. Areas to investigate beyond the obvious watershed type grants include Greenspace, parks, quality of life, sustainable development, education, etc. Sites include: <http://www.adopt-a-watershed.org/>, <http://www.cwn.org> <http://www.iwla.org> <http://ctic.purdue.edu>, <http://www.nrdc.org/nrdc/>, <http://www.tnc.org>, <http://www.waterkeeper.org>, <http://www.rivernetnetwork.org/> (provides a complete listing of other organizations as well as a funding source catalog).

5. *Federal, regional and state consulting programs* Various Federal programs provide consulting either gratis or cost share.

- For example, TVA supplies Stream Teams to any local community willing to pursue a watershed protection program ([http://www.tva.gov/river/landandshore/landuse\\_contacts.htm](http://www.tva.gov/river/landandshore/landuse_contacts.htm)).
- The National Park Service provides a Rivers, Trails and Conservation Assistance Program that provides meeting facilitators and planning assistance for river corridor development (<http://www.nrc.nps.gov/programs/rtca/index.html>).
- Several Phase II communities received significant assistance from the Corps of Engineers in their Phase II permit application and parts of their implementation.
- The USGS cooperative program will provide monitoring and data analysis (<http://water.usgs.gov/coop/>).
- In many cases a regional flood control authority, planning agency, or a state league of counties or municipalities is more than willing to step in and serve as an integrator programs.
- Pseudo state/university programs often provide consulting free or at greatly reduced rates or can use other Federal grant monies to provide consulting or product services. For example, in several states a university, through a 319 grant, developed a statewide BMP manual to serve all communities in the state. The Ohio Department of Natural Resources "Rainwater and Land Development Manual" is an excellent BMP source in Ohio.
- Sometimes state programs can serve to partially fulfill one, or more, of the minimum controls. For example in several states an erosion control or channel protection and permitting program operated by the state is being relied on for part of the construction minimum control.

6. *Federal, State and regional grants* States and federal agencies administer or provide grant monies for local governments to pursue environmental projects:

- State administered programs such as Section 319 (recent congressional action extending the ability to use 319 money for Phase II for one year, after that some agencies allow "horse

trading”), 604(b), 104(b)(3), HUD block grants (<http://www.hud.gov/progdesc/cdbgent.cfm>), Coastal Zone (<http://www.epa.gov/owow/watershed/wacademy/fund/coastzone.html>), Well head protection, FEMA ([http://www.fema.gov/regions/iv/2000/r4\\_06.shtm](http://www.fema.gov/regions/iv/2000/r4_06.shtm)), etc. provide funds for various programs.

- Much of this information can be gleaned from Federal web sites including <http://www.epa.gov/efinpage/fundings.htm> (the environmental finance program), <http://www.epa.gov/OWOW/watershed/wacademy/fund.html> (watershed Academy funding site), and EPA regional sites.
- The TEA water quality mitigation retrofit demonstration projects also can be used along with other TEA-21 mandatory set asides (<http://www.fhwa.dot.gov/tea21/>).
- Several states have grants set aside for environmental education projects through schools.
- Greenspace programs abound at both the Federal, state and private grant areas and could be explored as part of a Low Impact Development or Smart Growth approach .

While some of these programs are not, per se, to be used for compliance activities many Phase I cities and regulators have been cagey about how to bend rules and waive requirements in order to secure funding for key projects and programs.

7. *Special fees for service* Another source of funding is to charge special fees for added services including inspection fees for BMPs, additional construction program related fees, plans review fees, etc. These fees can be scaled to cover part of or a whole program area. Some communities have instituted a simple “environmental” surcharge on a water bill as a special assessment. There are really four basic ways local governments get money: taxes, service charges, exactions and assessments. Each of these basic ways have rules that vary somewhat state to state, so it is important to know what you are getting into. I recently visited a city that had 108 different fees and charges based on specific services offered – not sure if that was a good thing !

8. *Private resources* Having your corporate name associated with a clean environment is still considered a good thing. This leads naturally to looking to private resources to fund public environmental projects. This can take the form of corporate grants, corporate involvement in adopt a stream programs, and other visible volunteer-based activities:

- Several communities have benefited from industry providing bags, gloves, vests, hats, key chains, pens, trinkets, coffee cups, new cars... well ok not new cars.
- Others sponsor stream clean ups, partner in restoration projects, construct greenways, etc.
- Another innovative approach is to allow them to put their logos on such things as storm drain plaques or banners. A firm called adopt-a-storm-drain specializes in this approach... perhaps among others (<http://www.adoptastormdrain.com/>).

9. *Stormwater Utility* The surest and best way to fund stormwater, if you don’t have lots of gambling loot that is, is through a user fee system based on demand on the stormwater infrastructure. If it looks like water and wastewater it should be funded like those other two public utilities. There is lots of information about how to set a stormwater utility up, some of it has even been developed by persons have set up a large number of them. Here are a few good sources: <http://www.florida-stormwater.org/manual.html>, [http://www.forester.net/sw\\_0011\\_utility.html](http://www.forester.net/sw_0011_utility.html), <http://stormwaterfinance.urbancenter.iupui.edu/>. With the demands of Phase II coming there might just be sufficient planetary alignment to attempt it for even the

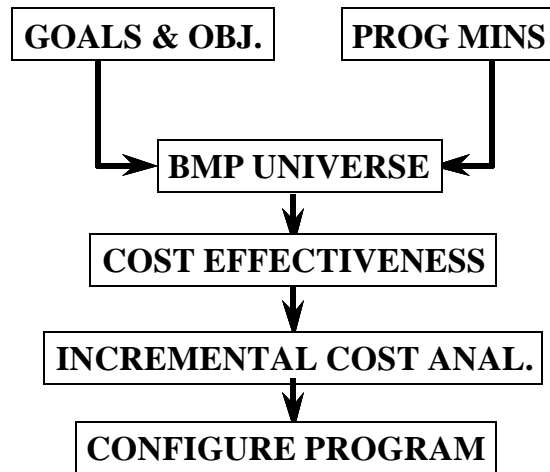
most reluctant Public Works director. I would not blame EPA for the utility, but it certainly can be the straw that breaks the camels back, amidst the other pressing stormwater program needs. It IS an unfunded Federal mandate after all. Again a word of caution. Do it right. Your opportunity cost of failure due to cutting corners on public education and consensus building is five to seven years of stormwater revenue – maybe millions. The cost to do it right versus cutting corners is less than two months revenue. Do the math.

*10. Partner with local organizations/agencies* Many local/county organizations may be already implementing programs that fall right in line with the Phase II requirements. For example, educational school programs, teacher monitoring workshops, watershed festivals, storm drain labeling and stream walk/community clean-up events, and watershed signage programs are often taken on by county Soil & Water Conservation Districts (SWCDs). Additionally, construction site plan reviews, inspections, and enforcement procedures are carried out by SWCD offices. Other organizations such as a Public Works Departments or Engineers may have the storm sewer systems and detention areas within the county mapped out. The Health Department may have a map of the septic system locations, thereby making it easier to determine where illicit discharges may be located.

## **Defining a Program that Can Be Paid For**

Environmental Cost Effectiveness is a term that has evolved over the years principally through the Federal government's attempt to quantify habitat or ecological benefits of potential projects (COE, 1994). Traditional benefit-cost analysis is, of course, not possible because costs and benefits are expressed in different units. Costs are expressed in terms of: dollars, volunteer man hours, level of effort ("hassle factor"), resources consumed, etc. Benefits are expressed in a wide variety of metrics in stormwater management including such "measurable goals" as: contact hours, pounds of pollutant removed, stream miles removed from the 303(d) list, increase in some biotic integrity or bio-assessment measure, bank-miles restored, "habitat units" restored or protected, delivered information pieces, constructed BMPs, specific actions taken, etc. Recreational activities such as fishing, boating, biking, etc. can have an associated dollar value.

Because it is difficult to evaluate cost effectiveness in absolute terms, most cost effectiveness analyses seek to determine effective programs relative to other potential options. The goal is not to lead to perfect environmental or economic solutions, but to elevate the decision process above the often emotional cost oblivious arguments. Steps in a typical cost effectiveness analysis modified to fit a Phase II program might include (see figure 4):



**Figure 4.** Cost Effectiveness Analysis for Phase II

1. Establish Value. Define the goals and objectives of the overall program focusing on solving apparent water quality problems or protecting key assets or resources, while keeping in mind the need to have a program under each of the six minimums. Identify key streams or other water bodies, ecological systems, habitat areas, and key pollutants of concern. Discuss MS4 values and the environmental characteristic of the community. Seek to define, in some way, what the community wants to achieve – besides compliance at minimum cost. Then insure that you have defined a complete set of goals for all of the minimum controls – even those where you would not normally chose to focus. Your eventual cost effectiveness consideration will be a bit different for those goals and objectives that are “essential” and those that are more “fillers” to round out the program.
2. Define the Universe of Possible Solutions. Brainstorm and screen individual and combinations of BMP programs (both structural and non-structural) including cost or resource estimates, potential type and availability of funding sources, fit with local program, ability to impact the goals and objectives, level of expected impact and benefit, mutual exclusivity. Focus first on the “real” goals and objectives and secondly on meeting each of the six minimum controls. The end product is a set of feasible BMP or combinations.
3. Perform Basic Cost Effective Analysis. Seek to eliminate inefficient and ineffective (economically irrational) solutions. Often a certain level of environmental benefit, or program level can be obtained in several different ways.
  - Efficiency is determined by selecting the BMP programs that can produce a given level of environmental benefit or output at the lowest resource expenditure combination. This analysis would be most appropriate for this minimum control areas that are not seen as key to the overall thrust of the local program.

- Effectiveness is determined by determining the highest level of environmental benefit or output at the lowest cost. This analysis would be most appropriate for those areas of the program identified in step one that are key to the overall surface water health of the community – the “compelling case”.

For example there are several potentially viable options for stream clean up: (1) hiring students during the summer, (2) using non-profit watershed groups, (3) hiring full-time staff, (4) working through scouting agencies, (5) working through neighborhood groups, (6) using local businesses in a way similar to adopt-a-highway. Student hires for stream trash removal may be more cost effective than full-time staff. However, with a higher initial cost and effort, it might be possible to set up self funded and largely self managed “adopt-a-stream” groups as 501(c)(3) non profit groups who will be self sustaining, increase public involvement and education, and provide other ancillary benefits. This option may then be seen as the most cost effective of the options when considering the long term program and the character of the community.

4. Perform Incremental Cost Analysis The Attempt is to optimize cost effective solutions. The goal is to answer the question: “is the increment in environmental benefit worth the increment in cost?” For each cost effective BMP a range of effort and cost may be defined and, if possible a range of environmental outputs in response to that effort input range. That is, if we increase the level of effort for a particular BMP program will the range of environmental benefit also increase – and how?

For example, there will be diminishing returns in public education programs as saturation is reached. Each incremental brochure, billboard, or other means will not yield as high a return – though sometimes only intuition and experience will often define those points, or that curve.

Or using the example from step three, it might be found that student summer hires are the most cost effective way to achieve stream clean up. This step then looks at this options and seeks to find ways to maximize the effectiveness of that particular solution. It might be that providing a certain level of resources, finding private grant money, forming a student organization, etc. will provide maximized returns for this option.

5. Configure the Program. Blend the various BMPs into a cohesive program, seeking synergy and practicality. Insure the program is at a level that is both acceptable to the permit writer and doable within the legal, social, financial, political, technical and physical constraints within the community. Lay out a program and funding strategy, leaving “outs” if anticipated funding sources do not emerge. Develop processes to manage the program and attain measurable goals.

## References

Reese, A.J., E. Treadway and D. Noel, 2000. Estimating Costs for the Phase II Stormwater Management Program, Water Environment and Technology, Water Environment Federation, April 2000, pp. 33-39.

US Army Corps of Engineers, 1994. Cost Effectiveness Analysis for Environmental Planning: Nine Easy Steps, IWR Rpt. 94-PS-2, Inst. For Water Resources, 7701 Telegraph Rd., Alexandria, VA, 22315.

U.S. Environmental Protection Agency, Office of Water. 1994. *President Clinton's Clean Water Initiative*. Washington, D.C. EPA 800-R-94-001.

# PROTECTING WATER RESOURCES WITH HIGHER DENSITY DEVELOPMENTS

Lynn Richards, Geoffrey Anderson, Mary Kay Santore  
US Environmental Protection Agency  
Washington, DC

## ABSTRACT

How and where development occurs can affect water quality. The purpose of this paper is to examine the water quality impacts from low and high-density development at the site level and watershed level. Considerable evidence in the literature demonstrates that dispersed, low-density development can exacerbate non-point source pollutant loadings by consuming absorbent open space and increasing impervious surface area relative to compact development. Some case studies have demonstrated that higher density development can minimize impacts on regional water quality by consuming less land and minimizing impervious surface cover. This paper discusses the relationship between water quality and growth patterns; uses modeling results to compare pollutant loadings from different types of residential development; and discusses measures to mitigate potential increased pollutant concentrations, which may result from higher density development

## INTRODUCTION

In the face of droughts, oil spills, beach closures, and overall declining water quality, communities are increasingly concerned about managing their watersheds to maintain hydrologic integrity and water quality. The nation's aquatic resources are among its most valuable assets. Although environmental protection programs in the United States have improved water quality during the past 25 years by focusing on point sources, many challenges remain. EPA estimates that of the causes of pollution in the states' impaired waters, only 10 percent is presently attributable to point source pollution, such as industrial discharges. The rest is ascribed to non-point source pollution or some combination of point and non-point source pollution, which can include increased sedimentation from land development, stormwater runoff, and on-site sewage systems.

The *National Water Quality Inventory: 1998 Report to Congress* identified urban runoff as one of the leading sources of water quality impairment in surface waters.<sup>1</sup> Of the 11 pollution source categories listed in the report, emissions from urban runoff and storm sewers was ranked as the sixth leading source of impairment in rivers, fourth in lakes, and second in estuaries. In addition, recent water quality data find that more than a third of assessed rivers and streams (291,000 of 840,000 miles) do not meet water quality standards. For these impaired surface waters, urban and agricultural runoff are the primary sources of pollution.<sup>2</sup>

Of special concern are the problems associated with non-point source storm water runoff in our urban streams, lakes, estuaries, aquifers, and other water bodies caused by runoff that is inadequately controlled or treated. These problems include changes in flow, increased rates of sedimentation, higher water temperature, lower dissolved oxygen, degradation of aquatic habitat structure, loss of fish and other aquatic

---

<sup>1</sup> U.S. Environmental Protection Agency (USEPA). 2000a. *National Water Quality Inventory: 1998 Report to Congress*. [www.epa.gov/305b/98report](http://www.epa.gov/305b/98report). Last updated October 5, 2000.

<sup>2</sup> U. S. Environmental Protection Agency, Office of Water. June 2000b. "Water Quality Conditions in the United States: A Profile from the 1998 National Water Quality Inventory Report to Congress" Washington, DC. EPA841-F-00-006 (also available at [www.epa.gov/OWOW/305b/](http://www.epa.gov/OWOW/305b/)).

populations, and decreased water quality due to increased levels of nutrients, metals, hydrocarbons, bacteria, and other constituents.

Recent research has revealed a strong relationship between impervious cover and water quality. These studies have demonstrated that at 10 percent imperviousness, a *watershed* will become impaired.<sup>3</sup> In addition, water quality suffers not only from the increase in impervious surface, but also from the associated activities: construction, increased travel to and from the development, extension of infrastructure, and chemical maintenance of the areas in and surrounding the development. Oil from motor vehicles, lawn fertilizers, and other common solvents, combined with the increased flow of runoff, contribute substantially to water pollution. These findings suggest that as imperviousness increases, so do associated activities, thereby delivering an increased impact on water quality. In an effort to protect water resources, communities may apply the 10 percent impervious cover threshold from the watershed level to the site level. The purpose of this downscaling is to reduce development densities and therefore reduce overall impervious surfaces at the site level. While intended to address overall impervious within the watershed, when the 10 percent figure is applied to the individual site level within the watershed, it suggests that only lower densities can protect water quality.

This study suggests that the opposite may in fact be true-- attempts to ensure low densities at the site level can often lead, not to better, but to worse overall water quality. Other recent studies have demonstrated that dispersed, low-density development can exacerbate non-point source pollutant loadings through increased consumption of pervious open space and greater amounts of transportation-related impervious infrastructure, such as roads, driveways, and parking lots. On the other hand, a compact development approach accommodates more activity while consuming less space. In turn, this reduces overall imperviousness and helps to maintain watershed functions.

The purpose of this paper is to examine the water quality impacts from low and high-density development at the site level and then to extrapolate these findings to the watershed level. This paper discusses the relationship between water quality and growth patterns; uses modeling results to compare pollutant loadings as a function of residential density; and summarizes existing research on the subject. We conclude that accommodating new growth in a compact, higher density fashion (in undeveloped areas or developed areas) will likely be more protective of water quality than lower density development.

#### **DEVELOPMENT'S IMPACT ON WATERSHED FUNCTIONS**

One of the most noticeable trends in recent history has been the dramatic expansion in the geographic size of metropolitan areas. Virtually every urban area in the United States has expanded substantially in land area in recent decades. Between 1954 and 1997, urban land area has almost quadrupled, from 18.6 million acres to about 74 million acres in the contiguous 48 states.<sup>4</sup> Moreover, from 1992-1997, the national rate of development more than doubled. During this five-year period, more land was developed (nearly 16 million acres) than during 1982-1992 (about 13 million acres).<sup>5</sup> The newly developed land has typically come from forest land, pasture and range land, and crop land. A 1994 study by the American Farmland Trust showed

---

<sup>3</sup> See, for example, Montgomery County Department of Environmental Protection, 2000; Center for Watershed Protection, 1998; Schueler, 1994; Arnold and Gibbons, 1996.

<sup>4</sup> U.S. Department of Agricultural, Economic Research Service, Natural Resources and Environmental Division. *Agricultural Resources and Environmental Indicators (AREI) Updates, No. 3*. "Major Land Use Changes in the Contiguous 48 States." June 1997.

<sup>5</sup> Ibid.



that urban development already has consumed nearly a third of the country's most highly productive farming regions.<sup>6</sup>

Direct environmental impacts of current development patterns include habitat loss and fragmentation and degradation of water resources. Building on undeveloped land consumes and fragments habitat and thus displaces or eliminates wildlife communities. The construction of impervious surfaces such as roads and rooftops leads to the degradation of water quality by increasing runoff volume, altering regular stream flow and watershed hydrology, reducing groundwater recharge, and increase stream sedimentation.

Watersheds and their streams and rivers provide critical ecological and economic services. Ecologically, small watersheds and streams sustain larger ecosystems. In addition, the stream corridor, with its rich flood plains, wetlands, and forests, is home to unique plant and animal species. Streams support diverse aquatic communities and perform the vital ecological roles of processing the carbon, sediments, and nutrients upon which downstream ecosystems depend. Economically, small watersheds are the ultimate source of our drinking water; watershed and riparian buffer zone soils act as filters for water that might ultimately be consumed. Slow-order streams and their associated flood plains serve as temporary storage for floodwaters, and thereby act as natural flood control. The services provided by small watersheds are maximized when their land area is maintained in a natural condition.

The extent of beneficial watershed services begins to diminish when the natural condition of land is altered through development. Construction exposes sediments and construction materials to precipitation, which then washes material into storm drains or directly into nearby bodies of water. After construction, development usually replaces native meadows, forested areas, and other natural landscape features with compacted and fertilized lawns, pavement, and rooftops. These largely impervious surfaces generate substantial quantities of surface runoff. In addition, engineers traditionally design drainage systems to move rainwater as quickly as possible by directly it over the ground towards curbs, gutters, streets, and sewers. These conventional drainage systems prevent water from flowing into the ground and filtering through soil before being released into surface and ground waters. To compound problems, traditional construction practices seek to "connect" all of the impervious surfaces in a development to direct water to a minimal number of drainage outlets. For a typical retail project, the storm water system connects water from all rooftops, several parking lots and the interior road network. Even when landscaped islands are built into the project, the grading typically directs water away from the landscaping, thus losing any opportunity to "disconnect" the imperviousness for infiltration. This connected system instead creates more surface runoff—and this results in increased flooding, erosion, and pollution. Consequently, an urban watershed produces a greater volume of stormwater runoff, which in turn degrades the physical, chemical, and biological quality of streams.<sup>7</sup>

Some communities are taking steps to preserve undeveloped parcels or regional swaths of open space, in order to preserve watershed functions, among other environmental, economic, and social goals. Preserving open space can reduce total watershed impervious surfaces. Indeed, since 1998, nearly \$20 billion has been approved for open space preservation in local and state referenda. Since all land has differing ecological value, some communities are beginning to develop open space conservation programs that target the most

---

<sup>6</sup> American Farmland Trust. 1994. *Farming on the Edge: A New Look at the Importance and Vulnerability of Agricultural Near American Cities*.

<sup>7</sup> Woodworth, James et al. 2002. *Out of the Gutter: Reducing Polluted Runoff in the District of Columbia*. NRDC: Washington, DC.

critical areas for preservation.<sup>8</sup> However, strategic and targeted open space preservation planning is in its nascent stages and the overall impact of these measures tends to be somewhat limited from an ecological protection standpoint. While open space preservation is certainly part of the solution for development-related water quality problems, it is critical to address overall densities in the watershed in order to minimize total land consumption.

### **LOW DENSITY DEVELOPMENT--BAD FOR WATER QUALITY? CRITIQUING CONVENTIONAL WISDOM**

Knowing that development has the ability to impair the natural functions performed by watersheds, state and local governments are asking, “If we are going to grow, how do you minimize development’s impacts on water quality? Are some patterns of development less harmful than other development patterns? Are there critical thresholds of which to be aware? How much development can a watershed absorb without significant harm occurring?”

There are some answers to these questions. Studies have demonstrated that watershed’s suffer impairment at a 10 percent impervious cover. Over 25 percent, the watershed is considered severely impaired.<sup>9</sup> Conventional thinking has translated these findings into the notion that low-density development will result in better water quality. The reasoning behind these policies is: a 1-acre site will typically have one or two residential units with a roadway passing by the property, the driveway, a home with an average footprint of 2,265 ft<sup>2</sup>.<sup>10</sup> The remainder of the site is lawn. The impervious cover is approximately 35 percent.<sup>11</sup> The lawn, however, while still pervious cover, contributes to stormwater runoff because of its disturbed nature, e.g., the soils have been compacted due to scraping and the traversing of construction equipment. The effects of this compaction can remain for years, and be increased due to mowing. Therefore, sites with fewer houses minimize impervious cover and maximize lawn cover or other types of variably pervious surface. Given indications that watershed impairment begins at 10 percent impervious cover, it is thought that a low-density development scenario may be one approach to the improvement of water quality. However, in a higher-density scenario, which will typically have eight to ten residential units per acre, the parcel is likely to be built out with upwards of 85 percent impervious cover.<sup>12</sup> The majority of this impervious cover is due to the footprints of the housing units. Lawn space is generally minimized. This scenario seems less protective of water quality because it has more impervious cover due to housing footprints.

Because impervious surface area appears to vary with specific land use, a common approach to local land use regulation in support of water quality is to specify maximum development densities. The reasoning here is that if each site minimizes water quality impact through density alone, e.g, the number of residential unites per acre, then overall parcel-level impervious cover is regulated, with the putative benefits apparent at the watershed or regional scale.<sup>13</sup> While this seems to make sense, there are some significant flaws in this thinking.

---

<sup>8</sup> Trust for Public Land and the National Association of Counties. 2002. *Volume 1: Local Greenprinting for Growth: Using Land Conservation to Guide Growth and Preserve the Character of Our Communities*.

<sup>9</sup> There are different levels of impairment. In general, when the term is used in EPA publications, it usually means that a water body is not meeting its designated water quality standard. However, the term can also imply a decline or absence of biological integrity, e.g., the water body can no longer sustain critical indicator species, such as trout or salmon. Further, there is a wide breadth of levels of impairment, e.g., endangered trout versus spontaneous combustion.

<sup>10</sup> National Association of Home Builders. 2001. *Housing Facts, Figures, and Trends: 2001*. NAHB: Washington, DC. The average house built in 2001 includes 3 or more bedrooms, 2.5 baths, and a 2-car garage.

<sup>11</sup> Soil Conservation Service, 1986. Technical Release No. 55 (TR-55). *Urban Hydrology for Small Watersheds*.

<sup>12</sup> *Ibid.*

<sup>13</sup> See, for example, the code for Durham, NC: [www.ci.durham.nc.us/departments/planning/zoneord/Section5/556.html](http://www.ci.durham.nc.us/departments/planning/zoneord/Section5/556.html)

- 1) *Density and imperviousness are not equivalent.* Depending on the actual design of the development, two houses may actually create as much imperviousness as four houses, for example. The impervious area on site associated with given number of residential dwelling units can vary widely due to road infrastructure, housing design (single story or multi-story), or length and width of driveways. For example, a multi-story apartment of 10 units on one acre can have less impervious surface than 6 single-family homes on the same acre. Even at the level of a single house, impervious area can vary widely, and therefore assumptions about the impervious area per dwelling unit are questionable. For example, in some dispersed low-density communities, such as Fairfax County, Virginia, some homeowners are paving their front lawns to create more parking space for the large number of cars each household owns.<sup>14</sup> This phenomenon has also been noted in some San Francisco, California neighborhoods with large households and high vehicle ownership rates.<sup>15</sup>
- 2) *Much of the “pervious” surface left on low-density development acts like impervious surface for water quality purposes.* All else being equal, undisturbed land is better for water quality than disturbed land, including lawns and other maintained areas. However, disturbed and impervious areas vary widely in the amount, speed, and type of runoff per square foot. At one time, lawns were thought to provide “open space” for infiltration of water. However, development can involve wholesale grading of the site, removal of topsoil, severe erosion during construction, compaction by heavy equipment and filling of depressions. Research now shows that the run-off from highly compacted urban lawns is almost as high as paved surfaces.<sup>16</sup> Therefore, a one or two acre lawn does not offer the same watershed services that a one or two acre undisturbed forest does. The idea that minimizing impervious surfaces by limiting housing structures and maximizing larger lawns does not address the loss of ecological services that the area provided before development.
- 3) *Low-density developments mean more off-site impervious infrastructure.* Development in the watershed is not simply the sum of the sites within it. Rather, total impervious area in a watershed is the sum of site developments plus all the infrastructure supporting those sites, such as roads, parking lots, ditches, and other impervious surface infrastructure. Furthermore, recent research has demonstrated that impervious surfaces attributed to streets, driveways, and parking lots can represent upwards of 75 percent of total site imperviousness, and this is on sites with two residential units per acre.<sup>17</sup> That number decreases to 56 percent on sites with 8 residential units per acre. This indicates that as density decreases, off-site transportation-related impervious infrastructure often increases. In a density-limiting policy environment, densities are generally calculated absent this infrastructure, and low-density development requires substantially higher amounts of this infrastructure per capita and per acre than do the more dense developments, which are paradoxically prohibited by some types of zoning regulation.
- 4) *The scale of the finding that 10 percent impervious cover impairs watersheds is for the watershed level.* Often, this finding is applied at the site level, and, as discussed in the previous point, does not take into account the transportation-associated infrastructure. Applying this finding at the site level is flawed since the research behind this finding was conducted at the watershed level, not the site level. Extrapolating from the site to the watershed would be incorrect because other factors come into play at

---

<sup>14</sup> Rein, Lisa and David Cho, “In Defense of the Front Lawn: Fairfax Attacks Crowding With Ban on Oversize Driveways,” *Washington Post*, June 4, 2002, p. A1.

<sup>15</sup> Brown, Patricia Leigh, “The Chroming of the Front Yard,” *New York Times*, June 13, 2002, p F1.

<sup>16</sup> Schueler, T. 2000. The Compaction of Urban Soil. *Techniques for Watershed Protection*. Center for Watershed Protection, Ellicott City, MD.

<sup>17</sup> Capiella, K. and Brown, K. 2001. *Impervious Cover and Land Use in the Chesapeake Bay Watershed*. Ellicott City, MD.

the watershed level. However, what the 10 percent finding does suggest is that it is better to cluster development or to increase the density of existing communities.

- 5) *Growth is coming to the region, limiting density on a given site doesn't eliminate that growth.* Density limits are responses to—and attempts to manage—growth. Yet they do not in fact manage growth; they only manage *some* growth—the growth on the density-limited area. The rest of the growth that was going to come to the region still comes, but goes elsewhere. Is that elsewhere better or worse for regional water quality than accommodating the growth at the density-limited site? Rarely if ever are density limits part of a watershed plan that answers that question. If growth is coming to a region, it will come regardless of density limits in a particular place. There is a lively debate in economic development circles about whether certain types of development are especially attractive to residents and/or businesses, and will therefore draw additional growth. But no one argues that pursuing a particular kind of growth will slow or stop growth in a region.<sup>18</sup> (This issue is discussed in more detail in on page 11). At most, covering a large part of a region with density limits will drive growth to other parts of the region. If the excluded growth's destination is upstream from the density-limited area, then the area with the density limits will still be affected by the growth, and, depending on local conditions, may actually be made worse off from a water quality perspective than if the growth had been accommodated and well-managed in the area.

#### **TESTING THE ALTERNATIVE: CAN COMPACT DEVELOPMENT IMPACT REGIONAL WATER QUALITY?**

The debate over how best to protect water quality, and how to continue to enjoy the ecological and economic services of watersheds, begins with the expanding United States population. The Census Bureau projects that U.S. population will grow by 50 million people between 2000 and 2020.<sup>19</sup> Where and how these people will be accommodated is fundamental to all water quality protection strategies.

What is the alternative to the density-limiting approach? Compact development can accommodate more people on less land, leaving more undisturbed land, i.e., greenfields, available to serve critical ecological functions as previously described.<sup>20</sup> The fundamental debate, then, is over which scenario is better for regional, or watershed, water quality—lower density or higher density (“compact”) development. The two arguments can be summarized as follows:

1. Low-density development is better for watershed water quality because it limits impervious cover at the site level.

Or

---

<sup>18</sup> There are, of course, minor exceptions to this dynamic. An area that is desirable will probably experience an increase in housing prices and would consequently experience a very modest displacement of development to other parts of the region. For example, housing prices in some neighborhoods in Manhattan, New York, San Francisco, California, or Washington, DC have increased significantly because of the urban form and high densities. It is likely that the higher housing prices have fostered development in areas further from these central locations.

<sup>19</sup> “Annual Projections of the Total Resident Population as of July 1: Middle, Lowest, Highest, and Zero International Migration Series, 1999 to 2100.” Population Projections Program, Population Division, U.S. Census Bureau, Washington, D.C. 20233. Internet Release January 13, 2000, revised February 14, 2000 at [www.census.gov/population/www/projections/natsum-T1.html](http://www.census.gov/population/www/projections/natsum-T1.html).

<sup>20</sup> In addition, higher densities make public transit profitable, increase walkability, and generally increase other livability factors that are absent in dispersed, low-density sites. For more information on these positive externalities associated with compact development, see EPA document 231-R-01-002 “Built and Natural Environment: A Technical Review of the Interactions between Land Use, Transportation, and Environmental Quality.”

2. High-density development is better for watershed water quality because overall it disturbs less land to accommodate the similar numbers of people and therefore leaves more land available to serve critical ecological functions.

Although the previous section gave numerous reasons to doubt that the density-limiting approach was protective of watershed quality, a complete evaluation needs to test the density-limiting approach against one that encourages compact development. We test the competing approaches by comparing higher- and lower-density developments by using hypothetical site plans that represent typical low-density and compact development patterns.<sup>21</sup>

### ***Assumptions***

In order to construct scenarios and conduct the modeling in a way that produces policy-relevant results, certain assumptions drive the analysis. Because the relevant question concerns selection of an approach that produces less runoff and pollutant loadings, the analysis examines the *comparative* differences in the impacts of low density and compact development patterns. The analysis is driven by two major assumptions:

1. *Metropolitan regions will continue to grow.* This assumption is consistent with US Census projections that the US population will grow by roughly 50 million people by 2020.<sup>22</sup> Given this projected population growth, communities across the country are or will be grappling with how to accommodate expected population increases to their regions.
2. *Shifting growth represents a shift in growth, not additional growth within the region.* Individual states and regions grow at different rates depending on a variety of factors including macroeconomic trends (e.g., the technology boom in the 1980s spurring development in the Silicon Valley region in California); historical growth rates; and demographic shifts. These factors are not significantly impacted by the prevailing distribution of density of development. The question for a state or a region is, “If we are going to receive X number of new jobs and X number of new residents, what is the effect of accommodating those jobs and residents in a higher density pattern of development versus a low density pattern of development?”

### **AN ILLUSTRATIVE EXAMPLE**

To determine which development pattern is more protective of water quality, we have developed two scenarios in order to examine water quality impacts from a high density and lower density developments. These scenarios take place within a fictional watershed and are simplified in order to isolate and examine the impacts of density on water quality. Issues such as slope, ground water hydrology, commercial, industrial, and agricultural land uses are important to watershed health, but are not considered in these scenarios.

Two communities in this watershed are each growing by the same amount. The region’s council of governments has forecasted that over the next 20 years, the metro area will grow by 270,000 persons. As the region looks to accommodate this new growth, they are also looking for ways to protect water quality and the overall health of the watershed.

---

<sup>21</sup> For more information and other tests, please see EPA’s draft document, *Minimizing the Impacts of Development on Water Quality*, 2003.

<sup>22</sup> U.S. Census Bureau.

Two communities in this region have different average densities. Community A is dominated by lower density development, and has an average residential density of three residential units per acre.<sup>23, 24</sup> Community B, the higher density area, has a density average of approximately nine residential units per acre. Each residential unit in both communities generates a certain volume of stormwater runoff and a proportional amount of pollution. For both communities, we assumed that development would have the following features:

- The entire acre is disturbed land; e.g., no forest or meadow cover would be preserved.
- Each residential unit in both communities has a footprint of 2,200 square feet.
- The same percentage of transportation-associated infrastructure, such as roads, parking lots, driveways, and sidewalks is allocated to each community acre.
- No best management practices, structural or otherwise, are implemented.

In general, impervious surfaces, such as housing footprint, driveways, and roads will have higher amounts of runoff and associated pollutants. Lawns, while pervious, still contribute to runoff due to their compacted and disturbed nature. Based on these assumptions, the overall percent imperviousness for Community A is approximately 30 percent for an average density of 3 residential units per acre and the overall percent imperviousness for Community B is 70 percent for an average density of 9 residential units per acre.<sup>25</sup> While these assumptions are based on an illustrative example and not on actual site plans, the size of housing units is based on national trends from the National Association of Home Builders.<sup>26</sup> The percentage of infrastructure that is attributable to each acre is based on the curve number methodology from the Natural Resources Conservation Service (NRCS); and the overall site imperviousness is based on NRCS studies of urban hydrology.<sup>27</sup>

The model used to generate the results described below is Smart Growth Water Assessment Tool for Estimating Runoff (SG WATER)<sup>28</sup>—a peer reviewed sketch model that was developed specifically to compare water quantity and quality differences among different development patterns. SG WATER's methodology is based on the NRCS curve numbers,<sup>29</sup> event mean concentrations, and daily rainfall data.<sup>30</sup>

---

<sup>23</sup> Densities at three or nine residential units per acre are conservative and used here for illustrative purposes only. Many communities now are zoning for one unit per two acres at the low-density end of the spectrum. Low density residential zoning exists in places as diverse as Franklin County, OH that require no less than 2 acres per unit ([http://www.co.franklin.oh.us/development/franklin\\_co/LDR.html#304.041](http://www.co.franklin.oh.us/development/franklin_co/LDR.html#304.041)) to Cobb County, Georgia outside of fast growing Atlanta that requires between 1 and 2 units per acre in its low density residential districts ([http://www.cobbcounty.org/community/plan\\_bza\\_commission.htm](http://www.cobbcounty.org/community/plan_bza_commission.htm)). By comparison, some communities are beginning to allow higher densities upward to 20 or high units per acre. For example, Sonoma County, California's high density residential district permits between twelve (12) and twenty (20) units per acre ([http://www.sonoma-county.org/prmd/Zoning/article\\_24.htm](http://www.sonoma-county.org/prmd/Zoning/article_24.htm)) and the City of Raleigh, NC allows up to 40 units per acre in planned development districts. ([http://www.raleigh-nc.org/planning/DPRC/BROCHURES%20PDF/HIGH\\_DENSITY.PDF](http://www.raleigh-nc.org/planning/DPRC/BROCHURES%20PDF/HIGH_DENSITY.PDF))

<sup>24</sup> For this example and throughout this paper, residential units instead of commercial units are compared. Most communities do not zone for density limits for commercial and retail properties.

<sup>25</sup> Soil Conservation Service, 1986.

<sup>26</sup> National Association of Home Builders. 2001.

<sup>27</sup> The NRSC estimate for average imperviousness for 8 units per acre is 65 percent. They do not have an estimate for 9 units per acre. Given our calculations and NRSC estimates of average site imperviousness, we are extrapolating average impervious for 9 unit per acre to be 70 percent.

<sup>28</sup> *Technical Approach for SG WATER: Smart Growth Water Assessment Tool for Estimating Runoff*, 2002.

<sup>29</sup> Soil Conservation Service. Technical Release No. 55 (TR-55). *Urban Hydrology for Small Watersheds*.

<sup>30</sup> Daily time-step rainfall data for the three year period (1997-1999) was used.

It does not take into account wastewater or drinking infrastructure, slope, or other hydrological interactions that the more complex water modeling tools use.

Please note that SG WATER uses a general and simple methodology based on curve numbers. One limitation of curve numbers is that they tend to under predict stormwater runoff for smaller storms. This under prediction can be significant since the majority of storms any given area experiences in any year are small storms. In addition, the curve numbers tend to over-estimate runoff for large storms. However, curve numbers will more accurately predict runoff in areas with more impervious cover because the runoff for impervious cover is similar using the curve number approach and the small storm hydrology approach.<sup>31</sup> For the analysis here, the runoff from the low-density site will be under predicted to a larger degree than the runoff from the higher density site because the higher density site has more impervious cover. Simply put, the difference in the numbers presented here are conservative—it is likely that the *comparative difference* in runoff between the two sites will be much greater if more extensive modeling was used.

## RESULTS

In the lower-density Community A, the total average annual volume of runoff from the one-acre site, with three housing units, is 21,400 ft<sup>3</sup> – and the total average annual volume of runoff from Community B, with 9 housing units is 42,900 ft<sup>3</sup>. These totals represent the amount of water measured at one hypothetical outfall. Community B, with more housing units, has a greater amount of impervious surface cover and thus generates a larger volume of runoff at the site level.

Exhibit 1: Total Average Annual Stormwater Runoff Per Acre for Both Communities. *(These totals represent the amount of water measured at a hypothetical outfall.)*

	Density	Imperviousness	Average Annual Runoff <sup>32</sup> per acre
Community A	3 residential units per acre	30 percent	21,400ft <sup>3</sup>
Community B	9 residential units per acre	70 percent	42,900 ft <sup>3</sup>

Now, looking at how much runoff each *individual housing unit* produces, we see that in Community A, each house yields 7,133 ft<sup>3</sup> of average annual runoff, whereas in the more dense Community B, each unit produces 4,767 ft<sup>3</sup> average annual runoff. Therefore, when examined at the housing unit-level, each house in Community B produces approximately 33 percent less runoff for each house in Community A. This is because houses in Community B have smaller yards and less site-infrastructure on a per unit basis. Therefore, on a per unit basis, each home in the higher-density communities contributes less stormwater runoff. Exhibit 2 demonstrates.

<sup>31</sup> Most existing stormwater models incorrectly predict flows associated with small rains in urban areas. Most existing urban runoff models originated from drainage and flooding evaluation procedures that emphasized very large rains (several inches in depth). These large storms only contribute very small portions of the annual average discharges. Moderate storms, occurring several times a year, are responsible for the majority of the pollutant discharges. The effects caused by these frequent discharges are mostly chronic in nature, such as contaminated sediment and frequent high flow rates, and the interevent periods are not long enough to allow the receiving water conditions to recover.

<sup>32</sup> Calculated by SG WATER using Atlanta, Georgia daily time step rainfall data and assuming hydrologic soil type C.

Exhibit 2: Total Average Annual Stormwater Runoff Per Housing Unit for Both Communities. (These totals represent the amount of water measured at a hypothetical outfall.)

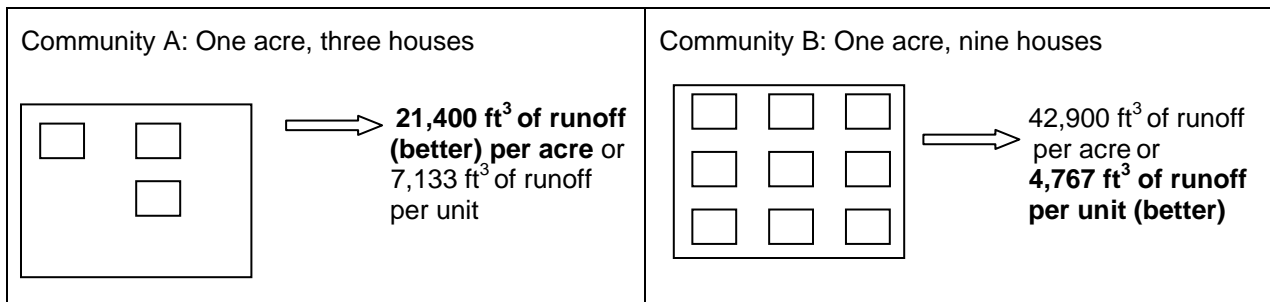
	Density	Imperviousness	Average Annual Runoff per Acre	Average Annual Runoff per Unit
Community A	3 residential units per acre	30 percent	21,400 ft <sup>3</sup>	7,133 ft <sup>3</sup>
Community B	9 residential units per acre	70 percent	42,900 ft <sup>3</sup>	4,767 ft <sup>3</sup>

In sum, our model showed that when density is tripled, total stormwater runoff doubles at the per acre level, but is decreased by one-third at the housing unit level. In other words:

- density triples; and
- imperviousness doubles; and
- *total average annual* doubles; and
- *runoff per housing unit* falls by 33 percent.

Exhibit 3 illustrates the relative differences between Community A and Community B. At the one-acre level, the lower total average annual runoff produced by Community A’s low-density development would be better for water quality than the Community B’s high-density development. On the other hand, at the individual housing unit level, the high-density development of Community B produces less stormwater runoff on a per-dwelling-unit basis.

Exhibit 3: Average Annual Stormwater Runoff in Community A and Community B. (These totals represent the amount of water measured at a hypothetical outfall.)



On a strict site-level basis, the density limiting approach is more environmentally protective. Recalling from the previous section the conclusion that the watershed is the correct level of analysis, rather than the site-level, we turn next to examining the implications for the watershed, by extrapolating these site-level results.

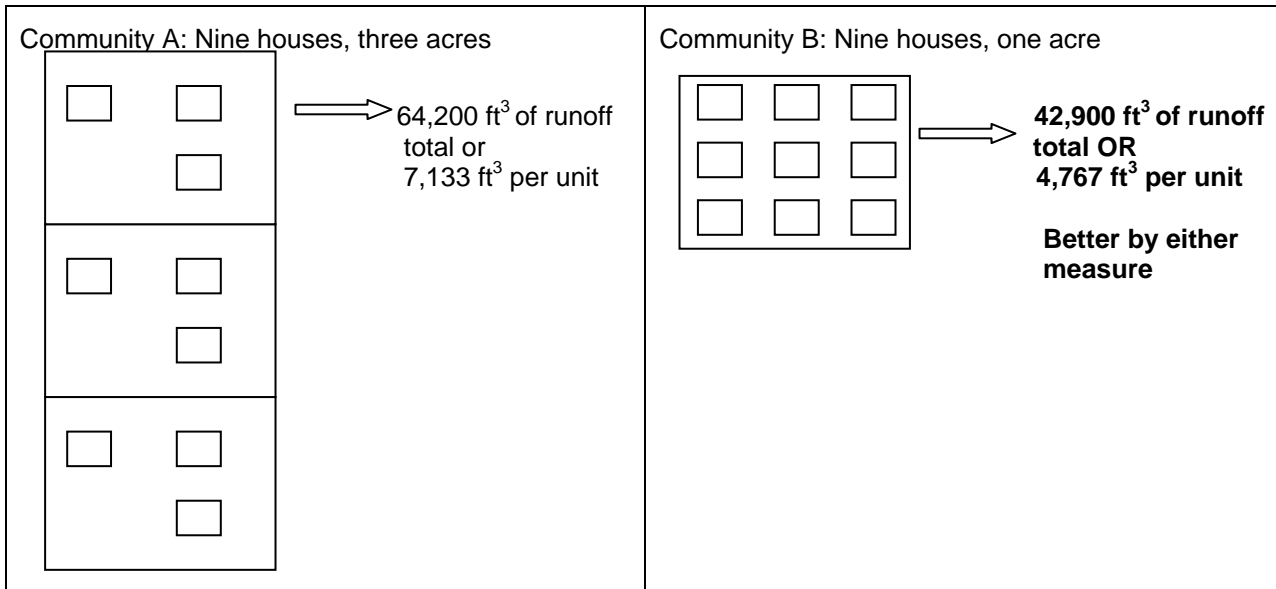
The assumptions establish that Communities A and B will grow at the same rate. Thus our initial model run, placing only three units in Community A, did not test the situation actually faced by Community A. Community A will also need to accommodate the same nine dwelling units, so the correct scenarios must compare nine new dwelling units in Community A to nine new dwelling units in Community B.

Where is Community A put the six additional houses that Community B accommodated? Assuming the same development densities, Community A will need to develop two additional acres, or three acres total, to accommodate the same number of housing units that Community B accommodated on one acre. In this scenario, total average annual runoff from nine houses in Community A is 64,200 ft<sup>3</sup> (21,400 ft<sup>3</sup> x 3 acres),



which is 50 percent more runoff as the same nine houses produce in Community B (the same 42,900 ft<sup>3</sup> total average annual runoff). Exhibit 4 illustrates.

Exhibit 4. Each community accommodates nine houses. (*Average annual runoff—assuming one hypothetical outfall.*)

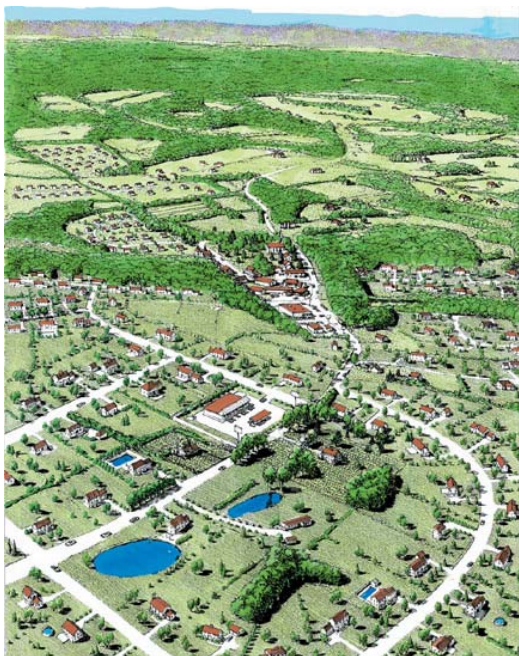


From this example, we can see that with higher densities, the per unit runoff rates are dramatically less (approximately 33 percent) than their low-density counterparts. If we only look at runoff from the 1-acre site level (not looking at the per unit rates or the rates for accommodating the same number of houses given permitted densities) we see that lower densities can create less impervious cover and produce less runoff. But if we treat the watershed as a whole—expecting that the region will be accommodating a given amount of new growth, regardless of whether that growth is low or high density-- the lower density developments will necessarily require developing further into the watershed. In turn, each low-density unit, requiring more space for driveways, roadways, and compacted lawns, will create more runoff and watershed degradation. If these impacts are extrapolated to the watershed level, Community A will develop land at a rate three times faster than Community B. Exhibit 5 is intended to illustrate the potential regional build out of these two different community scenarios. These illustrations<sup>33</sup> give us a pictorial view of how Community A and B might end up developing at a watershed scale. Clearly development in Community B disturbs less land, thereby preserving more critical ecological functions than the low-density development patterns in Community A. Yet, both communities are accommodating the same number of people.

<sup>33</sup> Provided by the New Jersey Office of Planning; <http://www.state.nj.us/osp/plan2/p2full/colors00.htm>.

*Exhibit 5: Comparison of Watershed Build Out for Communities A and B*

Community A



Community B



**FINDINGS FROM THE ILLUSTRATIVE EXAMPLE**

Using average densities to project stormwater runoff for two communities, we were able to demonstrate that a higher density scenario generates less stormwater runoff on a per housing unit basis. Specifically, this example illustrates:

- For a given site, less compact development can create less impervious cover, less runoff, and may better protect water quality;
- With more compact development, runoff rates per residential unit fall dramatically, to approximately 1/3 of their less compact counterparts;
- For the same amount of development, the more compact development will produce less runoff than the less compact development pattern; and
- For a given amount of growth, then lower density developments must force development further into the watershed.

Taken together, these findings lead to the conclusion that, all else being equal, including amount of growth, at the watershed level, higher densities are more environmentally protective. These results were also tested for comparative development sites at the square mile area and 10-acre area in addition to the one-acre analysis. At all levels, the ratios remain the same: when density is tripled, total stormwater runoff doubles at the per acre level, yet the housing level stormwater runoff is decreased by one-third.

## ISSUES TO CONSIDER IN THIS ANALYSIS

### 1. *Is growth really fixed?*

A basic assumption for our modeling is that the amount of growth coming to either Community A or B is fixed—and the question to be examined is how can certain strategies influence the density and pattern of that growth. When developing and examining the consequences of regional growth trends, regional forecasters ask, “how much growth is expected to come to this region in a given period of time?” In standard regional population modeling practice, wage or amenity (a firm-location criterion based on pleasant locational attributes—such as climate or culture—rather than on transport or production cost<sup>34</sup>) differentials with other areas of the country seem to account for most of the ingress or egress to a metropolitan area.<sup>35</sup> Growth is also a function of birth and death rates in a region. Regional growth models do not typically employ density drivers of regional jobs or population. That is, growth is apparently not a function of regional development patterns. Development density is independent of regional growth, there is no reason to believe that low-density zoning limits the number of people moving to a region, and many reasons to believe that such zoning does not limit the number of people moving to a region, but rather simply pushes them further out.

Estimates of future growth are rarely precise and despite this imprecision, regions have used this fixed amount of growth to test the effects of adopting different growth planning strategies. This is possible if we accept the premise that development patterns do not significantly change the amount of regional growth. A wide variety of regions have used this approach. One of the best-known studies and planning processes is Portland, Oregon’s “Vision 2040.” Portland understood that the region would grow substantially by 2040; the question was not if, but where and how. In response, it developed a base case and three alternative growth concepts that all absorbed the same amount of growth; approximately 720,000 additional residents and 350,000 additional jobs in the region.<sup>36</sup> These four alternative futures are schematically illustrated in Exhibit 6. Although they all absorb the same amount of people and jobs, they vary substantially in infrastructure requirements, open space preservation, and impact on both the urban and natural environment. Each option was analyzed for effects on:

- land consumption
- travel times and distances
- open spaces and air quality
- various urban landscapes.”<sup>37</sup>

---

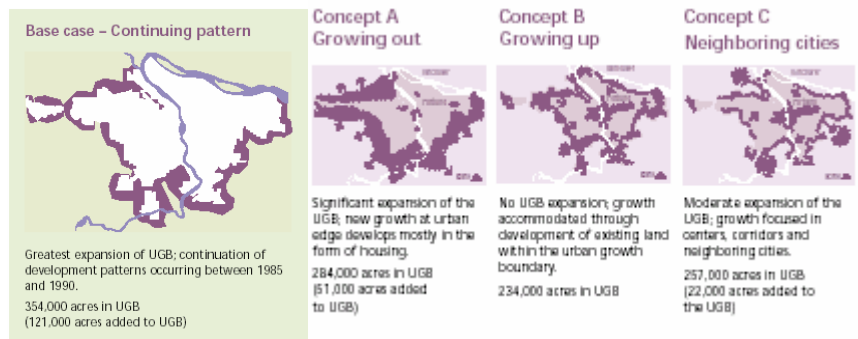
<sup>34</sup> Mills, Edwin, B. Hamilton. 1994. *Urban Economics: Fifth Edition*. Harper Collins College Publishers.

<sup>35</sup> The most widely-used such model—the REMI® Policy Insight™ model—uses an amenity variable. However, even this is implemented as an additional change in the wage rate. See [www.remi.com/Overview/Evaluation/Structure/structure.html](http://www.remi.com/Overview/Evaluation/Structure/structure.html). All other regional population models in a survey by ICF use only economic and demographic drivers. The in-house model used by San Diego Association of Governments is an advanced example of the type used by COGs around the country. [www.sandag.cog.ca.us/resources/demographics\\_and\\_other\\_data/demographics/forecasts/index.asp](http://www.sandag.cog.ca.us/resources/demographics_and_other_data/demographics/forecasts/index.asp).

<sup>36</sup> <http://www.metro-region.org/growth/tfplan/2040.html>

<sup>37</sup> Metro, “The Nature of 2040: The region’s 50-year plan for managing growth,” 2000. See <http://www.metro-region.org/growth/tf/2040history.pdf>

Exhibit 6: Same amount of growth, different locations and densities: Portland’s Vision 2040 alternatives analysis.



The Minneapolis-St. Paul region took the same approach in its Blueprint 2030, developing alternative growth scenarios that all absorbed the same amount of growth—in this case, 280,000 households—and then forecasting the impacts associated with each scenario.<sup>38</sup> As in Portland’s study, the growth scenarios varied substantially in where in the region they located the 280,000 new households, and how dense those households were developed in those locations. Total growth, however, was held constant across scenarios.

This approach has been used at the statewide level as well. New Jersey, in their State Plan, explicitly addressed the question whether population and jobs would change under the PLAN versus business-as-usual TREND, and found that, “It is anticipated that the TREND and PLAN scenarios will have essentially the same population and household growth at the state and regional levels, but significantly different growth by type of community and State Plan planning area. It is also anticipated that under the PLAN regimen there will be more growth in communities with more densely developed planning areas and in communities with urban, regional, and/or town centers, and that there will be less growth in these areas under the TREND regimen.” So, both PLAN and TREND scenarios analyzed “Accommodating a growth of 462,000 households and 802,500 jobs over the period 2000 to 2020 [requiring] approximately 486,500 housing units and 422.5 million square feet of nonresidential space.”<sup>39</sup>

Although these three studies are excellent examples, they are by no means only examples of this approach to regional and statewide growth planning. Other examples include:

- Puget Sound Regional Council’s Vision 2020 (where and how to absorb 1.4 million people),<sup>40</sup>
- San Francisco Bay Area’s Smart Growth Strategy,<sup>41</sup> developed by the Association of Bay Area Governments (where and how to absorb 1 million new residents and 1 million new jobs),
- Envision Utah (where and how to absorb 600,000 new residents by 2020),<sup>42</sup>

<sup>38</sup> Metropolitan Council, Blueprint 2030: “[E]ach alternative future illustrates a distinct way in which the Twin Cities can accommodate the Region’s next 280,000 households (approximately 580,000 people) and 360,000 jobs.

<http://www.metrocouncil.org/planning/blueprint2030/overview.htm>

<sup>39</sup> <http://www.state.nj.us/osp/plan2/ias/sp3economic.pdf> and <http://www.state.nj.us/osp/plan2/ias/ia2000en.htm>.

<sup>40</sup> <http://www.psrc.org/projects/vision/2020overview.htm>

<sup>41</sup> Association of Bay Area Governments, “Smart Growth Strategy: Shaping the Future of the Nine-County Bay Area,” Alternatives Report, April 2002. See <http://www.abag.ca.gov/planning/smartgrowth/AltsReport/SmartGrowthStrategy.pdf>

While these studies have forecast the environmental impacts of a fixed amount of growth absorbed in various locations and in various densities, they have not, in most cases, looked explicitly at water impacts. The population and growth assumptions outline in this paper, then,

- Follows the standard model of growth impacts analysis by examining the impact on the environment of a fixed amount of growth, absorbed in different locations and in different densities;
- Seeks to contribute to the standard approach by demonstrating that it is both possible and important to add water to the list of impacts that is examined in this type of alternatives analysis for regional and statewide growth.

In sum, the approach in this study is both consistent with the current state of the practice, and builds on it. Finally, as we establish the assumptions for this analysis, it is important to note: we do not argue that the projected 270,000-person growth increment is necessarily the correct number and that the growth is fixed and known. It may be 240,000 persons, or it may be 340,000 persons. There is uncertainty in these projections, as in all growth forecasting. However, we also know that some amount of growth is coming, and that whatever the amount it will not vary as a result of lower or higher density development. That is the sense in which it is fixed for the purposes of this policy analysis.

## *2. What happens if high-density development occurs and the remaining green space is developed as well?*

Higher density development performs better at the watershed level because some green space is “saved” by concentrating development regionally--see Exhibit 5 for an illustration of this dynamic. In other words, accommodating more people in closer proximity can relieve development pressures at the edge. However, critics argue that the undeveloped lands will be developed anyway, thereby further degrading water quality by allowing higher densities and by developing on all the absorbent open space. However, there are two issues with this critique:

- (1) Growth is fixed. As discussed in the previous section. More growth will not arbitrarily come to a region simply because there is space to expand.
- (2) Comparisons between built out densities must keep the number of housing units accommodated the same. For example, if critics argue that the high-density approach will bring more development to the remaining open spaces, that same amount of development must be added to the comparison watershed that has developed at lower densities.

We have already explored the first issue. For the sake of exploring the second issue, we'll examine two comparative watersheds in three stages: (1) each watershed accommodates the same number of housing units but at different densities; (2) as the critics argue, the more dense watershed is fully built out, while no growth is added to the comparison watershed; and (3) the comparison watershed accommodates the growth of the more dense watershed, which means that each watershed accommodates the same number of housing units. We're assuming that the watershed in question is 10,000 acres.

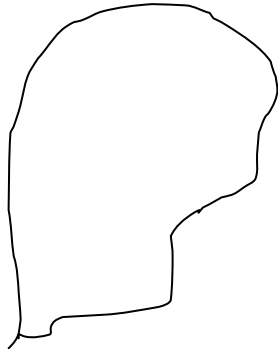
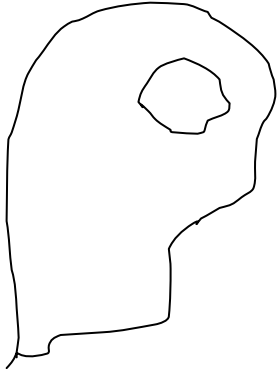
The first step in this process is to examine each watershed accommodating the same number of housing units- but at different densities. Initial growth projections suggested that at 3 housing units per acre the watershed would be fully built out. However, at the higher density level of 9 housing units per acre, only one third of the watershed would be built out. The runoff associated with each of these scenarios is shown in Exhibit 7.

---

<sup>42</sup> See <http://www.calthorpe.com/Project%20Sheets/Envision%20Utah.pdf>

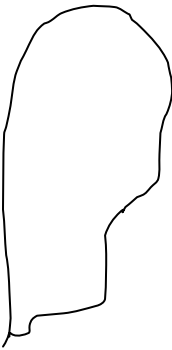
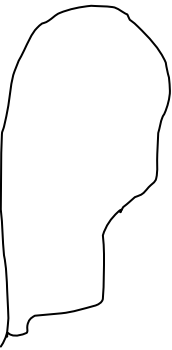
As Exhibit 7 shows, if development occurs at a lower density, e.g., 3 housing units per acre, the entire watershed will be built out. Any additional development that occurs in this community will have to go into another watershed, since this watershed is built out. This total buildout will generate 214 million ft<sup>3</sup> average annual stormwater runoff, assuming one hypothetical outfall. This is approximately one-third more stormwater runoff than the watershed that is developed at the higher density. In this situation, developing at the lower density seems worse for watershed water quality.

Exhibit 7: Hypothetical 10,000-acre Watershed Developed at Different Densities

	
<p><b>Scenario 1:</b> The 10,000-acre watershed is fully built out at 3 housing units per acre. 30,000 housing units are accommodated. This translates to:</p> <p>10,000 acres x 3 housing units x 7,133 ft<sup>3</sup> of runoff</p> <p><b>214 million ft<sup>3</sup> average annual stormwater runoff</b></p> <p><b>30,000 housing units accommodated</b></p>	<p><b>Scenario 2:</b> The 10,000-acre watershed is only partially built out because development is occurring at higher densities—9 housing units per acre. 30,000 housing units are still accommodated. This translates to:</p> <p>1/3 (10,000 acres) x 9 housing units x 4,767 ft<sup>3</sup> of runoff</p> <p><b>141.57 million ft<sup>3</sup> average annual stormwater runoff</b></p> <p><b>30,000 housing units accommodated</b></p>

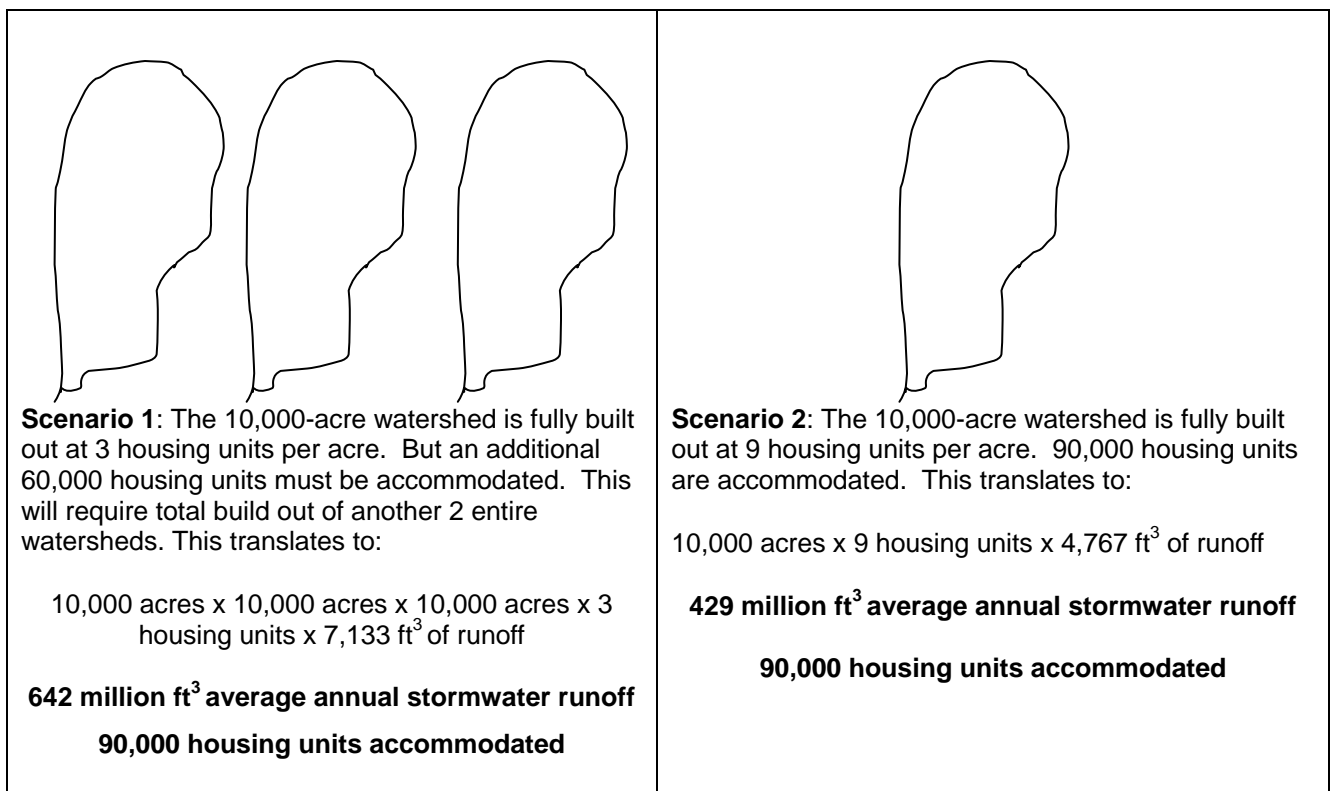
But what happens if the remaining 2/3 of the watershed in Scenario 2 is built out, as was initially suggested? Exhibit 8 examines those numbers considering the worst case situation—that the remaining land in the watershed is developed at the higher density of 9 housing units per acre.

Exhibit 8: Hypothetical 10,000-acre Watershed Developed at Different Densities

	
<p><b>Scenario 1:</b> The 10,000-acre watershed is fully built out at 3 housing units per acre. <u>30,000</u> housing units are accommodated. This translates to:</p> <p>10,000 acres x 3 housing units x 7,133 ft<sup>3</sup> of runoff</p> <p><b>214 million ft<sup>3</sup> average annual stormwater runoff</b></p> <p><b>30,000 housing units accommodated</b></p>	<p><b>Scenario 2:</b> The 10,000-acre watershed is fully built out at 9 housing units per acre. <u>90,000</u> housing units are accommodated. This translates to:</p> <p>10,000 acres x 9 housing units x 4,767 ft<sup>3</sup> of runoff</p> <p><b>429 million ft<sup>3</sup> average annual stormwater runoff</b></p> <p><b>90,000 housing units accommodated</b></p>

Now, both watersheds are fully built out and the watershed developed at the higher density, e.g., developed at 9 housing units per acre, is generating approximately double the total stormwater runoff. This would be worse for watershed water quality if both scenarios accommodated the same amount of growth. However, note that the watershed with the higher density is accommodating *60,000 more units of housing*, or three times the number of housing units. And, as was discussed in the previous section, growth is fixed. A region will not accommodate unlimited growth. In essence we are projecting what would happen if the regional growth is three times higher than initially projected. So, where are those additional housing units accommodated in the watershed that was developed at the lower-density? They were built in nearby or adjacent watersheds. So, to continue with the analysis, if regional forecasts were wrong and 90,000 housing units were needed and not 30,000 housing units, then the watershed developed at the lower density level, e.g., 3 housing units, will need to expand into two additional watersheds to accommodate the same growth! Exhibit 9 illustrates this situation.

*Exhibit 9: Hypothetical 10,000 acre Watershed Developed at Different Densities*



As Exhibit 9 demonstrates, accommodating an additional 60,000 housing units requires disturbing and developing another 2 watersheds. Total average annual stormwater runoff from accommodating 90,000 housing units at 3 housing units per acre generates 642 million ft<sup>3</sup> average annual runoff. While the watershed developed at the higher density, e.g., 9 housing units per acre, has still just disturbed one watershed and is generating approximately one third less stormwater runoff—or 429 million ft<sup>3</sup> average annual runoff.

*3. Urban water infrastructure is failing — how can it accommodate more users?*

It is better to preserve public investments by investing where the public has already invested. It is a poor strategy economically and environmentally to divert development away from any area because infrastructure is failing. For example, in a report by the Office of Technology Assessment, one official of a large western city reported that it costs the city \$10,000 more to provide infrastructure services to a house on the suburban fringe than one in the urban core.<sup>43</sup> Myron Orfield, a member of Minnesota’s House of Representatives, calculated that by 1992, the central cities of Minnesota were paying over \$6 million annually to subsidize growth in edge areas. This was especially troubling to areas like Minneapolis, which had 22 percent existing sewer service that in 1990 remained undeveloped. Rather than directing growth to this area, between 1987 and 1991, the region provided new capacity to 28 square miles of land at the cost of \$50 million per year.<sup>44</sup> The capacity went primarily to serve expansion into the development affluent

<sup>43</sup>US Congress, Office of Technology Assessment, *The Technological Reshaping of Metropolitan America*. Washington, DC: US Government Printing Office, 1995. OTA-ETI-643.

<sup>44</sup> Orfield, Myron. 1997. *Metropolitics: A Regional Agenda for Community and Stability*. Washington, DC: Brookings Institution Press.



southwest suburbs. This kind of infrastructure spending subsidizes and encourages development at the fringe.

The implications of building new infrastructure instead of maintaining existing infrastructure is that it is apparently more important to provide new infrastructure than to maintain good service in existing communities. This signal leads to an unwillingness to invest on the part of private owners. Thus, a catch-22 situation begins—an area is degraded and no one, including the local government, wants to invest in it, which causes further degradation of the area. The result of this type of disinvestment causes the movement of people and businesses out of the community to newer developed areas. This movement can lead to sprawl even in the absence of significant population growth. This has been evidenced in numerous cities such as Buffalo, New York, Cleveland, Ohio, and Pittsburgh, Pennsylvania. All these cities experiences population loses at the same time as their land consumption and urbanized area grew. The result of this outward growth, with or without population growth, is a significant increase in watershed or regional impervious cover, which will further degrade regional water quality.

#### *4. Shouldn't increasing densities be accompanied by open space offsets?*

This question essentially asks that if the benefits of density are derived from undeveloped open space, shouldn't there be a requirement that this land be preserved? Earlier, we discussed the issue that the resulting open space will be developed in addition to the higher density development is in essence a fear that the region will receive more growth than anticipated. The implication here is that without some active preservation, the open space will be developed anyway. As discussed, this growth would have come to the region in either the low density or the higher density scenario and we asked which density development pattern would accommodate this new growth with the least impact to water quality.

There is a fixed amount of growth coming to any given region. Once that growth is accommodated, developers (in the private or public sector) will not continue to develop land independent of the demand for that development. For example, if the market anticipates that 1,000 new households will be coming to the region, it will supply 1,000 new units of housing. Once those units are supplied the market will not then add another 1,000 units. This is unaffected by the density at which the 1,000 are supplied. Thus, the open space remains undeveloped simply by virtue of the fact that the higher density development alleviates the need for the development of additional land. If, on the other hand forecasts are incorrect and an additional 500 units of housing comes to the region, then we are left with the original question, "What is the best way to accommodate this growth?"

The second problem with *linking* open space preservation requirements to higher density development is that it can create unintended consequences that may harm water quality. For example, there are two ways to link open space preservation to higher density development: require the developer to provide the open space offsets of some type, or use public tools such as downzoning or open space purchases to achieve preservation while increasing densities elsewhere. Either approach adds a barrier for the developer who wants to build higher density development. The "high-density" developer would be faced with the additional time and cost of complying with these rules while the "low-density" developer would have no such barrier or cost. In essence, either strategy puts an extra burden on the development product that is, by itself, more protective of water quality. Water quality professionals are not in the business of making developments easier for developers to build. However, by tilting the playing field towards "low density" developers, it is likely that more low density projects will be built, thereby further consuming absorbent open space, increasing transportation-related impervious cover, and overall, increasing the footprint of a

region. As a result, in an attempt to guarantee water quality benefits by linking open space preservation to higher density development we actually hasten water quality declines. One could argue that it is more important is the role of open-space offsets in low-density zoning environments. Given that low-density development drives subsequent development further into undisturbed land, it would appear more important to attach offset requirements to low-density zoning than to the land-conserving approach of compact development.

The question underlying this issue is how can communities determine where to develop and where to preserve? In all development scenarios, ensuring adequate open space for water quality, flooding mitigation, sports and recreation, habitat, and biodiversity is a critical part of the planning process. Hydrologically speaking, it is generally accepted that more open space is needed, and specifically removal of development from flood plains. Not all land has equal ecological value and it is critical for local governments to determine where the critical ecological systems exist within their region and to take steps to preserve these areas. Once this process of determining how to minimize new development and maximize retention and reclamation of open space, a community will perhaps have in place a significant network of green infrastructure.<sup>45</sup>

In addition, open space preservation specialists argue that for an open space plan to be effective, preserved parcels must be large enough to serve a critical environmental function and, if possible, connected. By requiring any development to have an open space offset, a community has the potential of creating a hodge podge of spaces that may or may not have significant environmental value. In addition, open space offsets, in the worse case scenario, cause leapfrog development. What some communities have done to address the issue of preserving open space in the face of mounting development pressures is to require all new developments, high and low densities, to pay a fee into a general fund. The local government then uses these funds to acquire or purchase the lands they have identified as having high environmental, economic, or social value.

5. *Do infill sites (such as brownfields and greyfields) represent a particular opportunity?*

This paper has demonstrated that compact development produces less stormwater runoff on a per-unit basis than does low-density dispersed development. Communities can enjoy a further reduction in runoff if they take advantage of underutilized properties, such as infill, brownfield, or greyfield<sup>46</sup> sites. For example, an abandoned shopping center (a greyfield property) is often almost completely impervious cover, and is already producing high volumes of runoff. If this property is redeveloped, the net runoff increase will likely be zero since the property was already predominately impervious cover. In many cases, redevelopment of these properties will break up or remove some portion of the impervious cover, converting it to pervious cover and allowing for some stormwater infiltration. In this case, redevelopment of these properties can produce a net improvement in regional water quality by decreasing total average annual . Exhibit 11 illustrates this opportunity.

---

<sup>45</sup> For more information on the environmental and ecological benefits of preserving open space, please see Trust for Public Land's "Economic Benefits of Preserving Open Space;" and "Local Greenprinting for Growth: Using Land Conservation to Guide Growth and Preserve the Character of Our Communities."

<sup>46</sup> Greyfield sites generally refer to abandoned or underutilized shopping malls, strip malls, or other areas that have significant paved surface and little or no contamination (in order to distinguish it from brownfield sites). For more information on greyfield sites and the potential for redevelopment, please see Urban Land Institute's publication, "Turning Greyfields into Goldfields."

*Exhibit 10: Redevelopment of a Greyfield Property*

Before Redevelopment



After Redevelopment



Utilization of brownfield and greyfield sites can reduce regional land consumption and ensure accommodation of projected growth thus decreasing its environmental impact. A recent George Washington University study found that for every brownfield acre that is redeveloped, 4.5 acres of open space are preserved.<sup>47</sup> In addition to redeveloping brownfield sites, regions can identify underutilized properties or land, such as infill or greyfield sites, and target those areas for redevelopment. For example, a recent analysis completed by King County, Washington demonstrated that property that is vacant and eligible for redevelopment in the county’s growth areas can accommodate 263,000 new housing units—enough for 500,000 people.<sup>48</sup> Redeveloping this property represents an opportunity to accommodate new growth without degrading water quality. As discussed, much of the abandoned properties in areas are already close to 100 percent impervious cover. By taking advantage of these properties, a community experiences the benefits of growth without the costs of water quality degradation. Finally, in addition to water quality benefits, if these properties are developed at higher densities, a local government can ensure that more people are accommodated in areas with existing infrastructure, housing choices, and transportation choices.

6. *What about localized hot spots?*

One of the largest benefits about developing at higher densities are the other community opportunities that become more viable because of more people living in closer proximity to each other. For example, bus transit becomes viable at 7 units an acre, while light rail and subway become viable at 15-20 units an acre.<sup>49</sup> Mixed use, such as first floor retail, becomes viable only at higher densities. And, community walkability and livability increase dramatically as densities increase.<sup>50</sup> Increasing densities on a regional scale is more

---

<sup>47</sup> Deason, Jonathan, *et al.* “Public Policies and Private Decisions Affecting the Redevelopment of Brownfields: An Analysis of Critical Factors, Relative Weights and Area Differentials.” Prepared for US EPA Office of Solid Waste and Emergency Response. The George Washington University, Washington, DC. September, 2001. Available at [www.gwu.edu/~eem/Brownfields/project\\_report/report.htm](http://www.gwu.edu/~eem/Brownfields/project_report/report.htm).

<sup>48</sup> Pryne, Eric. “20 Years’ Worth of County Land?” *Seattle Times*, Monday, May 20, 2002.

<sup>49</sup> Ewing, Reid. “Pedestrian and Transit-Friendly Design: A Primer for Smart Growth. ICMA: Washington, DC. 1999.

<sup>50</sup> For more information on the other benefits of density, please see, ICMA’s publication, “Getting to Smart Growth: 100 Policies for Implementation;” [www.smartgrowth.org](http://www.smartgrowth.org); and [www.smartgrowthamerica.org](http://www.smartgrowthamerica.org).

protective of water quality, overall, but has the potential to create localized hot spots that affect proximate water bodies. EPA estimates that over 70 percent of urban water bodies are impaired. If a local community increases densities in their development patterns, while better for overall regional watershed health, there is a real potential to increase pollutant loadings in water bodies new or adjacent the new development. Of course, even with low-density development, creating hotspots is also a real potential, but because of the slightly higher runoff and pollution levels of the higher-density development patterns, as demonstrated, localized hot spots are a greater concern.

This paper suggests that the answer to this question is to protect pristine watersheds and overall watershed health through compact development and mitigate hot spots. There are two approaches for mitigating hotspots:

- (1) Address increased pollutant loads at the site- and development-level, reducing the amount of runoff and associated pollutants entering the system through structural or non-structural best management practices, such as riparian buffer zones or conservation easements, or low-impact development; and
- (2) Reduce the overall levels of “background” pollution, thereby allowing the streams and water bodies to absorb more pollution from localized hotspots while still maintaining water quality standards.

EPA and other organizations, such as the Center for Watershed Protection, have written extensively about numerous best management practices and low-impact development techniques that reduce site- or development-specific stormwater runoff and associated pollutants.<sup>51</sup> For example, low-impact development is increasingly recognized as one mechanism to reduce effective impervious cover and to allow natural features to serve their ecological functions. Some LID techniques include:

- Rain gardens and bioretention;
- Rooftop gardens or simple roof storage;
- Tree preservation and planting;
- Vegetated swales, buffers, and strips;
- Roof leader disconnection;
- Rain barrels and cisterns;
- Impervious surface reduction and disconnection;
- Soil amendments;
- Permeable pavers; and
- Pollution prevention and good housekeeping.<sup>52</sup>

The Center for Watershed Protection recently released a document that details 11 techniques for reducing water quality impacts from development. While this document, “Redevelopment Roundtable Consensus Document,”<sup>53</sup> is geared for urban infill redevelopment opportunities, many of the practices described, such as, “Design sites to maximize transportation choices in order to reduce pollution and air and water quality,” can also be applied to high-density greenfield developments.

---

<sup>51</sup> See, for example, [www.bmpdatabase.org](http://www.bmpdatabase.org) and [www.stormwatercenter.net](http://www.stormwatercenter.net).

<sup>52</sup> Woodworth, “Out of the Gutter.”

<sup>53</sup> For more information on this document, please see [http://www.cwp.org/pubs\\_download.htm](http://www.cwp.org/pubs_download.htm).

Unlike reducing site-specific impacts that only require innovation and desire on the part of the developer, reducing background levels of pollution generally require some type of local government involvement. For example, stormwater management utilities provide an opportunity for the local government to address the most pressing stormwater problems. Residents, commercial, and industrial users of wastewater treatment plants pay into this fund, giving the localities the funds and flexibility to address the area's most severe problems. Other regional examples include:

- Variable sewer hookup fees, such as in Sacramento, California, which recently changed its hookup fees to vary by location and type of development. This results in developers having to pay almost twice as much to hook up sewer lines in fringe or edge areas as in urban areas.
- Maine charges “compensation fees” to residents and commercial entities for not meeting statewide phosphorus reduction requirements. These fees enable the state to address the increasing phosphorous problem at the source—either in locations with hot spots or at the waste water treatment facility.
- North Carolina has established density averaging of non-contiguous parcels, and density trading with buffer zones. The goal of this program is to encourage density in clusters, that is, encourage density without a net increase in watershed development density.

These and other regional policies are described in an EPA document, “*Protecting Water Resources with Smart Growth: 100 Policies*.”<sup>54</sup> This report describes both site-specific and regional policies that local communities have put in place to address localized hotspot and associated water quality issues.

To demonstrate the importance of these principles in reducing site- and development-related hot spots, the *University of Oregon* conducted a study entitled: “Measuring Stormwater Impacts of Different Neighborhood Development Patterns.”<sup>55</sup> The study site near Corvallis, Oregon, was created to compare stormwater management strategies in three common neighborhood development patterns.<sup>56</sup> For example, BMPs, such as disconnecting residential roofs and paving from the stormwater system, introducing swales and water detention ponds into the sewer system, and strategically locating open space had significant impacts on peak water runoff and infiltration. The study concludes that:

“Some of the most effective opportunities for reducing stormwater runoff and decreasing peak flow are at the site scale and depend on strategic integration with other site planning and design decisions.

“Reduced street networks of narrower streets and planting strips significantly reduce the amount of pavement and as a result, runoff, in urban areas. Best management practices such as swales, constructed wetlands and ponds integrated with urban streets and open space networks are also important to collect, clean, store and slow the flow of runoff. However, these facilities and their physical relationships must be planned early to be well orchestrated and effective.”<sup>57</sup>

---

<sup>54</sup> This document will be ready for distribution by June 1, 2003.

<sup>55</sup> Study description and results on [neighborhood.uoregon.edu/projects/research/owrri/owrri.html](http://neighborhood.uoregon.edu/projects/research/owrri/owrri.html).

<sup>56</sup> The University of Oregon used the PCSWMM model developed by Computational Hydraulics, in Guelph, Ontario, Canada.

<sup>57</sup> [http://neighborhood.uoregon.edu/projects/research/owrri/owrri\\_conclusion.html](http://neighborhood.uoregon.edu/projects/research/owrri/owrri_conclusion.html)

## 7. Won't increasing densities create sacrifice zones?

In the mid-1990's advocates for the environment, affordable housing, farmland preservation, transportation reform, and community reinvestment started calling on communities to develop in new ways. Since then, citizens across the nation are demanding it -- in polls, in the market, and at the ballot box. Americans want fewer hours in traffic and more opportunities to enjoy green space; housing that is both affordable and close to jobs and activities; healthy cities, towns and suburbs; air and water of the highest quality; and a landscape our children can be proud to inherit. Increasing densities and determining where we should develop and where we should preserve offers the best chance of attaining those goals. Not only will our communities thrive economically and socially, but also environmentally. Increasing densities provides a mechanism for communities to accommodate growth, enjoy economic development and jobs in the most environmentally protective way possible.

### WHAT HAS OTHER RESEARCH FOUND?

Current research suggests that compact development and/or redevelopment in existing areas will impact water quality less than scattered, low-density development. Several site-specific studies have been conducted across the country to predict the runoff and pollutant loading responses to changing land use. This section highlights five case studies that approach the research question with varying levels of complexity. Jordan Cove in Connecticut; Belle Hall in South Carolina; a statewide analysis of New Jersey; Chicago in Illinois; and an analysis done by the Chesapeake Bay Foundation each analyze the differences in runoff and associated water pollution from different types of development.

Researchers at *Jordan Cove*<sup>58</sup> development in Waterford, Connecticut are finding that, when compared to high-density design development, the large lot development, or low-density design, produces 95 more runoff during construction. Using monitoring data from two study sites and a control site, these paired sites will evaluate "Traditional" suburban development, "BMP" development, and the control subdivision. Early results from storm events during construction indicate that construction of the large lot neighborhood is causing significant impacts on runoff quality and quantity, including observed increase in mean weekly flow volume (99 percent), runoff frequency (from 16 to 95 percent), and mean weekly peak discharge (79 percent).

The Belle Hall study, completed by the South Carolina Coastal Conservation League (1995), examined the water quality impacts of two development alternatives for a 583-acre site in Mount Pleasant, South Carolina. In the "Sprawl Scenario," the property was analyzed as if developed along a conventional suburban pattern. The "Town Scenario," was analyzed if using the development incorporated traditional neighborhood patterns instead. In each scenario, the overall density and intensity (the number of residential unit, square feet of commercial and retail space, and so forth), was held constant, although the building types and sizes vary. The results found that "Sprawl Scenario" consumed 8 times more open space,

---

<sup>58</sup> Cote, M.P., Clausen, J., Morton, B., Stacey, P., Zaremba, S. 2000. *Jordan Cove Urban Watershed National Monitoring Project*. Presented at the National Conference on Tools for Urban Water and Resource Management Protection, Chicago, IL. See also Engdahl, J. 1999. *Impacts of Residential Construction on Water Quality and Quantity in Connecticut*. University of Connecticut, Storrs, CT.

[h2osparc.wq.ncsu.edu/96rept319/CT-96.html](http://h2osparc.wq.ncsu.edu/96rept319/CT-96.html)

[www.epa.gov/owow/estuaries/coastlines/summer98/jordancove.html](http://www.epa.gov/owow/estuaries/coastlines/summer98/jordancove.html)

[www.canr.uconn.edu/jordancove/](http://www.canr.uconn.edu/jordancove/)

generated 43 percent more runoff, 4 times more sediment, almost 4 times more nitrogen, and 3 times more phosphorous as compared to the “Town Scenario” development.<sup>59</sup>

New Jersey’s State Plan calls for increasing densities in the state by directing development to existing communities and existing infrastructure (“Plan”). Researchers at Rutgers University analyzed the water quality impacts from “Trend” versus “Plan” development. The study found that compact development (“Plan” development) would generate significantly less water pollution than low-density development (“Trend” development) for all categories of pollutants.<sup>60</sup> The reductions ranged from over 40 percent for phosphorus and nitrogen to 10 percent for lead. The smaller impervious areas would produce 30 percent less runoff, and concentrating this development in areas served by sewers would reduce its impact on the environment by another 10 percent.<sup>61</sup> These conclusions supported a similar statewide study completed in 1992 that concluded that compact development would result in 30 percent less runoff and 40 percent less water pollution than would a sprawl scenario.<sup>62</sup>

Researchers at Purdue University examined two possible project sites in the Chicago, Illinois area.<sup>63</sup> The first site was in the urban core and currently consists of a mix of residential, industrial, and commercial properties. The second site was on the urban fringe. The results found that placing a hypothetical low-density development at the Chicago fringe area would produce 10 times more runoff than a higher-density mixed-use development located in the urban core.

Finally, a study published by the Chesapeake Bay Foundation in 1996 comparing conventional and clustered suburban development on a rural Virginia tract found that clustering would convert 75 less land, create 42 percent less impervious surface, and produce 41 percent less stormwater runoff.<sup>64</sup>

## CONCLUSIONS

As metropolitan areas continue to grow in population, the area of the region’s built environment will continue to expand. How and where this development occurs will have a profound impact on water quality. EPA believes that increasing densities of all developments can minimize water quality impacts from development. Nationwide, state and local governments are considering the environmental implications of development patterns. A growing body of research clearly documents that the creation of impervious cover causes a predictable and profound decline in critical elements of aquatic ecosystems.<sup>65</sup> Conventional low-density development and its attendant infrastructure consume previously undeveloped land and create stretches of impervious cover throughout a region. In turn, these land alterations are not only likely to degrade the quality of the individual watershed, but are also likely to degrade a larger number of watersheds.

---

<sup>59</sup> South Carolina Coastal Conservation League, EPA, NOAA, SC Department of Health and Environment; Town of Mount Pleasant. 1995. *The Belle Hall Study: Sprawl vs. Traditional Town: Environmental Implications*. Dover, Kohl, and Partners, South Miami, FL.

<sup>60</sup> *Ibid.*

<sup>61</sup> University of Rutgers. 2000. *The Costs and Benefits of Alternative Growth Patterns: The Impact Assessment of the New Jersey State Plan*. Center for Urban Policy and Research.

<sup>62</sup> Pollard, Trip. “Greening the American Dream.” *Planning Magazine*: American Planning Association, October 2001.

<sup>63</sup> Harbor, J., Engel, B., et al. “A Comparison of the Long-Term Hydrological Impacts of Urban Renewal versus Urban Sprawl.” Purdue University: West Lafayette, IN. 2000.

<sup>64</sup> Pollard.

<sup>65</sup> See Arnold, Chester L. Jr., C. James Gibbons. See also EPA, *Urbanization and Streams: Studies of Hydrological Impacts*. Washington, DC: EPA Office of Water. 1997. EPA # 841-R-97-009.

Concentrating development in urban areas maintains the functions of smaller watersheds because at the regional or watershed scale, impervious cover is minimized and undisturbed open space is maximized. Further, development decisions can often affect transportation-related imperviousness across multiple watersheds. While a low-density scenario often subjects numerous watersheds to possible degradation, a compact scenario can limit the number of watersheds affected by development.<sup>66</sup> This review of the effects of different development densities on water quality suggests three conclusions:

1. Compact development is better good for water quality than less compact development. It minimizes the consumption of land needed to support critical watershed functions, which in turn minimizes the creation of impervious surfaces that lead to increased runoff, and associated pollutants. And intensifies activity in a smaller area – e.g., less motor traffic outside of cities.
2. There is no reason to expect that lower density development reduces total or even necessarily (depending on site design and building type) site-level runoff,<sup>67</sup> or are protective of watershed water quality. Rather, this paper and the literature suggest that, all else being equal, accommodating new growth through higher densities will likely be more protective than lower density development.
3. The denser development should be given preference, because its lower per-unit runoff minimizes the impact of a given increment of growth, and leaves more room for additional growth.
4. Regions can enjoy a substantial bonus from re-using existing brownfields, greyfields, and other sites that are already impervious. Building on these saves land elsewhere, can often accommodate higher densities, and can reduce flows from the developed parcel.

In sum, compact development is an environmental protection strategy, and should be included in any set of such strategies that are reviewed as part of a search for ways to protection water quality, whether at the local, state, or national level.

#### **ACKNOWLEDGEMENTS**

The authors would like to thank Will Schroeer from ICF Consulting for his research assistance. This paper is currently being reviewed by EPA’s Office of Water and outside peer reviewers. Their comments will be incorporated into the final draft of this paper.

---

<sup>66</sup> See review of several cases in US EPA, Development, Community and Environment Division, *Our Built and Natural Environments: A Technical Review of the Interactions between Land Use, Transportation, and Environmental Quality*, EPA #123-R-01-002, 2001. pp. 41-43.

<sup>67</sup> Keeping the number of housing units similar to a higher density development.



## REFERENCES

- American Farmland Trust. 1994. *Farming on the Edge: A New Look at the Importance and Vulnerability of Agricultural Near American Cities*.
- Arnold, C. L. and C. J. Gibbons. 1996. Impervious Surface Coverage: The Emergence of a Key Environmental Indicator. *Journal of the American Planning Association* 62(2) 243-258.
- Association of Bay Area Governments. 2002. Smart Growth Strategy: Shaping the Future of the Nine-County Bay Area, *Alternatives Report*. See <http://www.abag.ca.gov/planning/smartgrowth/AltsReport/SmartGrowthStrategy.pdf>
- Brown, Patricia Leigh, "The Chroming of the Front Yard," *New York Times*, June 13, 2002, p F1.
- Cappiella, K. and Brown, K. 2001. *Impervious Cover and Land Use in the Chesapeake Bay Watershed*. Ellicott City, MD.
- Center for Watershed Protection (CWP). 1998. *Rapid Watershed Planning Handbook—A Comprehensive Guide for Managing Urban Watersheds*. Ellicott City, MD.
- Chesapeake Bay Foundation. 2001. State of the Bay Report. Annapolis, MD.
- Cote, M.P., Clausen, J., Morton, B., Stacey, P., Zaremba, S. 2000. *Jordan Cove Urban Watershed National Monitoring Project*. Presented at the National Conference on Tools for Urban Water and Resource Management Protection, Chicago, IL.
- Deason, Jonathan, *et al.* 2001. *Public Policies and Private Decisions Affecting the Redevelopment of Brownfields: An Analysis of Critical Factors, Relative Weights and Area Differentials*. Prepared for US EPA Office of Solid Waste and Emergency Response. The George Washington University, Washington, D.C.
- Engdahl, J. 1999. *Impacts of Residential Construction on Water Quality and Quantity in Connecticut*. University of Connecticut, Storrs, CT.
- Ewing, Reid. 1999. *Pedestrian and Transit-Friendly Design: A Primer for Smart Growth*. ICMA: Washington, D.C.
- Krugman, Paul. 1991. *Geography and Trade*. MIT Press, Boston, MA.
- Krugman, Paul . 1995. *Development, Geography, and Economic Theory*. MIT Press, Boston, MA.
- Harbor, J., Engel, B., et al. 2000. *A Comparison of the Long-Term Hydrological Impacts of Urban Renewal versus Urban Sprawl*. Purdue University: West Lafayette, IN.
- McGrath ,Daniel T. 2001. 2025 Urban Land Area Forecasts for the US Top 20 Coastal Metropolitan Regions. Great Cities Institute, unpublished, available at <http://iisgcp.org/research/cbe/2025forecast.htm>.

- Metropolitan Council, Blueprint 2030. <http://www.metrocouncil.org/planning/blueprint2030/overview.htm>
- Mills, Edwin, B. Hamilton. 1994. *Urban Economics: Fifth Edition*. Harper Collins College Publishers.
- Montgomery County Department of Environmental Protection. 2000. *Stream Conditions Cumulative Impact Models for the Potomac Subregion*. MCDEP, MD.
- National Association of Home Builders. 2001. *Housing Facts, Figures, and Trends: 2001*. NAHB: Washington, DC.
- New Jersey Office of Planning. 2002. <http://www.state.nj.us/osp/plan2/p2full/colors00.htm>.
- Orfield, Myron. 1997. *Metropolitics: A Regional Agenda for Community and Stability*. Brookings Institution Press, Washington, D.C.
- Pollard, Trip. 2001. *Greening the American Dream*. Planning Magazine: American Planning Association.
- Portland Metro, 2000. The Nature of 2040: The region's 50-year plan for managing growth." See <http://www.metro-region.org/growth/tf/2040history.pdf>.
- Pryne, Eric. "20 Years' Worth of County Land?" Seattle Times, Monday, May 20, 2002.
- Rein, Lisa and David Cho, "In Defense of the Front Lawn: Fairfax Attacks Crowding With Ban on Oversize Driveways," *Washington Post*, June 4, 2002, p. A1.
- Schueler, T. 1994. The Importance of Imperviousness. *Watershed Protection Techniques* 1(3): 100-111.
- Schueler, T. 2000. The Compaction of Urban Soil. *Techniques for Watershed Protection*. Center for Watershed Protection, Ellicott City, MD.
- Soil Conservation Service. 1986. Technical Release No. 55 (TR-55). *Urban Hydrology for Small Watersheds*. Washington, DC.
- South Carolina Coastal Conservation League, EPA, NOAA, SC Department of Health and Environment; Town of Mount Pleasant. 1995. *The Belle Hall Study: Sprawl vs. Traditional Town: Environmental Implications*. Dover, Kohl, and Partners, South Miami, FL.
- Trust for Public Land and the National Association of Counties. 2002. *Volume 1: Local Greenprinting for Growth: Using Land Conservation to Guide Growth and Preserve the Character of Our Communities*.
- University of Rutgers. 2000. The Costs and Benefits of Alternative Growth Patterns: The Impact Assessment of the New Jersey State Plan. Center for Urban Policy and Research.
- U.S. Census. 2000. *Annual Projections of the Total Resident Population as of July 1: Middle, Lowest, Highest, and Zero International Migration Series, 1999 to 2100*. Washington, D.C.

- U.S. Congress, Office of Technology Assessment. 1995. *The Technological Reshaping of Metropolitan America*. Washington, D.C., 1 OTA-ETI-643.
- U.S. Department of Agricultural, Economic Research Service, Natural Resources and Environmental Division. June 1997. *Agricultural Resources and Environmental Indicators (AREI) Updates, No. 3*. "Major Land Use Changes in the Contiguous 48 States."
- U.S. Environmental Protection Agency. 1997. *Urbanization and Streams: Studies of Hydrological Impacts*. Washington, DC: EPA Office of Water. EPA # 841-R-97-009.
- U.S. Environmental Protection Agency (USEPA). 2000a. *National Water Quality Inventory: 1998 Report to Congress*. [www.epa.gov/305b/98report](http://www.epa.gov/305b/98report). Last updated October 5, 2000.
- U. S. Environmental Protection Agency, Office of Water. June 2000b. *Water Quality Conditions in the United States: A Profile from the 1998 National Water Quality Inventory Report to Congress*. Washington, DC. EPA841-F-00-006 (also available at [www.epa.gov/OWOW/305b/](http://www.epa.gov/OWOW/305b/)).
- Woodworth, James et al. 2002. *Out of the Gutter: Reducing Polluted Runoff in the District of Columbia*. NRDC: Washington, DC.

# **PREDICTING THE IMPACT OF URBAN DEVELOPMENT ON STREAM TEMPERATURE USING A THERMAL URBAN RUNOFF MODEL (TURM)**

A. Roa-Espinosa<sup>1</sup>, T.B. Wilson<sup>2</sup>, J.M. Norman<sup>2</sup>, and Kenneth Johnson<sup>3</sup>

<sup>1</sup>Dane County Land Conservation Department, Fen Oak Resource Center, 1 Fen Oak Court, Madison, WI 53718. Biological Systems Engineering, University of Wisconsin, Madison, 460 Henry Mall, Madison, WI 53706

<sup>2</sup>Department of Soil Science, University of Wisconsin-Madison, 1925 Linden Drive, Madison, WI 53706

<sup>3</sup>Wisconsin Department of Natural Resources

## **Abstract**

In this paper, we present a Thermal Urban Runoff Model (TURM) developed by the Dane County Land Conservation Department and the University of Wisconsin-Madison to predict the effect of urban development on runoff thermal regime. The model can predict the temperature increase of runoff from impervious surface by calculating the heat transfer between runoff and the heated impervious surfaces that commonly exist in urban areas. The model mainly assumes a complete mixing of runoff water to predict the heat transfer and the thermal gradient within the impervious media in contact with the runoff flow. Runoff temperature measurements indicate that the hot paved surfaces receiving rainfall initially produce energy released by evaporation, but high temperature runoff is quickly generated by the gradual increase in rainfall intensity. TURM can also predict the temperature reduction after the runoff passes through rock-filled channels; open vegetated swales, infiltrating surfaces; conduits and rock-filled chambers that can be used to cool the first flush of heated storm water runoff. Data collected during summertime storms indicate that determination of the air and rainfall temperatures is critical in predicting the runoff temperature.

TURM was used to evaluate the heating of runoff water during summertime and its impact characteristics at two urban subdivisions in Dane County, Wisconsin with different proportions of imperviousness. The percentage of imperviousness and rainfall depth defined the changes in runoff rate, volume and the timing of runoff. The model predictions for the temperature increase in runoff agree very well with site-specific measurements.

This study is an attempt to fill the knowledge gap that currently exists in determining the thermal impact of urban runoff on coldwater systems. The justification of this research effort is to provide a useful tool to urban planners, fishery managers, biologists, and the engineering community in Wisconsin to better manage impact of large urban development. TURM is still at the early stages of development and additional work is required to make the model applicable to wide array of practical situations.

Keywords: urban imperviousness, runoff: cold water stream, heat transfer, and thermal impact.

## 1. Introduction

The increase in temperature of stream waters has historically received little attention. However, recent studies have suggested that the expanding urbanization has a strong thermal impact on small streams, and as a result, water temperature is now being considered as a part of the permitting process for urban development throughout Wisconsin. Stream water temperature is a limiting factor for cold-water fisheries and is the “narrowest door” in the water system, as all biological activity depends on temperature. Over time, the cumulative impact of hundreds of individual development sites will slowly increase water temperature, affecting the habitat for every stream biota.

Temperature is a characteristic of water quality and is very important in chemical and biochemical processes, particularly those involving biochemical activity. Higher stream temperatures result in lower dissolved oxygen (DO) concentrations and may cause biological oxygen demand (BOD) to increase. Temperature increases in streams can also result in changes in the behavior of fish and macro invertebrates (aquatic insects). Stenothermal fish are very sensitive to temperature changes, with a physiological optimum temperature of  $<20^{\circ}\text{C}$ , while temperatures above  $26^{\circ}\text{C}$  are considered lethal. Brown Trout (*Salmo trutta*), for example, have an optimum temperature range of  $7$  to  $17^{\circ}\text{C}$  and become stressed at temperatures above  $19^{\circ}\text{C}$ . Macro invertebrates, such as Stoneflies (Plecoptera sp) and Caddis flies (Trichoptera sp), have a maximum temperature of  $17^{\circ}\text{C}$  and are important not only because they are the primary food source for trout, but because they are indicators of the overall health of the ecosystem. As a result, cold-water streams are apparently the most ecologically sound at temperatures between  $7$  and  $17^{\circ}\text{C}$  (Lyons and Wang, 1996, Simonson, 1996)

Urban runoff heating is recognized as the biggest threat to cold-water streams. The permanent warming of streams is often due to the increase in imperviousness and the heating of runoff water in contact with warm surfaces. The runoff is heated as it passes over the impervious surfaces with large heat storage due to solar radiation. In Dane County, Wisconsin, measured runoff temperatures from urban impervious areas have been as high as  $29^{\circ}\text{C}$ . Excessive heated runoff can substantially and permanently harm runoff receiving cold-water streams. Widely elevated water temperatures can impair the health of aquatic organisms and are responsible for habitat degradation in the headwaters of cold-water streams in urban areas. It is also warmed by the displacement of stored runoff heated by summer conditions that are in line with the storm water conveyance systems, such as wet detention basins.

Increased area under impervious surface in urban areas is a major source of thermal heating in cold climates and can threaten the health of cold-water ecosystems. Impervious areas absorb energy from the sun, which causes them to become warmer. As water runs over these areas, it absorbs some of that heat energy and is warmed, causing thermal pollution in lakes, rivers, and streams. Impervious areas also compound the problem by reducing infiltration, which in turn increases the volume of runoff that is created, leading to higher permanent stream temperatures in the summer months. By mitigating runoff and water temperature impacts, the stream community will benefit not only from temperature reduction, but also from a decline in the amount of sediment, nutrients, and pollution that reaches receiving waters.

The issues of urban runoff thermal impacts require the use of detailed models of the urban surface-water-atmosphere system. Modeling the heat transfer from warm surfaces to runoff water provides a means of assessing the contributions of various factors to the overall rise in water temperature. Some of these factors that may significantly affect the water temperature are solar radiation, air temperature, relative humidity, wind speed, the temperature and amount of rainfall or runoff, and the temperature and amount of ground water entering the river or stream.

The objective of this analysis is to develop a reliable urban rainfall-runoff model that includes a thermal component for impervious areas. The justification of the Thermal Urban Runoff Model (TURM) is to enable communities with cold-water streams to better manage development and minimize thermal impacts to streams. The focus of this paper is therefore on three specific objectives: (1) to provide evidence of the thermal impact of urban imperviousness, (2) to validate the performance of TURM, and (3) to evaluate the effectiveness of using a rock crib as a temperature moderating device.

## **2. Methods**

### *2.1. Field measurements*

Data were collected at several sites from May 28<sup>th</sup> to September 30<sup>th</sup>, 2000 (Figure 1). Stream discharge data was collected in the Token Creek subwatershed at 6 locations, temperature data at 11 locations, and rainfall data at 6 locations. The University of Wisconsin Geology Department collected stream flow and temperature data at two locations. A weather station located at Shonas Heights recorded the following measurements: wind speed with cup anemometer, solar radiation with a silicon cell pyranometer, rain and air temperature with thermocouple wires, relative humidity with a humidity probe, and rainfall with a tipping bucket rain gauge. The flow and rainfall data was collected every 5 minutes and the temperature every 15 minutes. The data was summarized for seven rainfall events in four-hour intervals. Interflow and groundwater discharge, as a base flow, is an important source of cool water for streams. The average base flow temperatures measured in the study area ranged from approximately 9 to 10 °C and remained nearly constant during the entire summer season. The exact study area is described in Table 1 below.

Token Creek Subwatershed illustrated in Figure 1 and 2 was selected to study the impact that imperviousness has on stream temperatures. This subwatershed extends west from Sun Prairie to Cherokee Marsh, and north to the Dane County line, and contains naturally occurring springs as well as urban, agricultural, and naturally vegetated areas, encompassing an area of 22.2 square miles (14,212 acres). The storm water in this subwatershed is discharged to streams or stream segments that are classified as either existing or proposed cold water communities by the Wisconsin Department of Natural Resources and thus are more susceptible to thermal impacts than other streams. Token Creek is a major contributor of fresh water to Lake Mendota, with a base flow of about 22.21 cubic feet per second (cfs) during July 2000 (data collected by the USGS); contributing 93% of all stream flow the lake receives (A Water Resources Study, U.W, 1997).

Table 1. Site descriptions and measurements.

Site	Description	Measurement
Culver Springs	Naturally spring-fed area	Base flow
St Albert Pond	Urban area with 20% imperviousness	Runoff temperature
Shonas Upstream Pond	Urban area with 20% imperviousness	Runoff temperature
Shonas East Subdivision (Figure 3)	Urban development	Runoff temperature
Shonas West Subdivision (Figure 3)	Urban area with 35% imperviousness	Runoff temperature
Rock Crib (Figure 3)	Rock chamber of 255 m <sup>3</sup>	Base flow/Runoff temperature
Token Branch	Urban drainage area	Base flow/Runoff temperature
Stonehaven	Natural grass area	Runoff temperature
Highway C	Confluence of streams	Base flow/runoff temperature
Highway 51	Confluence of streams	Base flow/runoff temperature

The thermal impact on Token Creek was measured over 7 rainfall events that occurred between June 1<sup>st</sup> and August 5<sup>th</sup> 2000. Table 2 and Figure 4 present the summary of runoff temperatures for the study area in 4-hour increments (0, 4, 8, 12, 16, 20). Table 2 and Figure 4 show that the runoff temperature from this area is consistently above the threshold for many cold-water species. Other impervious areas, such as Shonas Upstream Pond, Shonas East, and Shonas West, also had temperatures that were consistently above the threshold, but showed a period between the hours of 4 and 8 when the temperatures were lower and suitable for cold-water species. The total thermal impact on the Token Creek sub watershed is clear when the temperatures observed at Culver Springs (~10° C) are compared with those observed at Highway C. Highway C has temperatures that are approximately 7 to 8° C higher than those at Culver Springs (Table 2). The cooling effect that Culver Springs has on Token Creek can be seen at Highway 51, where the temperatures measured remained within the optimum temperature for trout

Figure 1. Data Collection Locations in the Token Creek Subwatershed

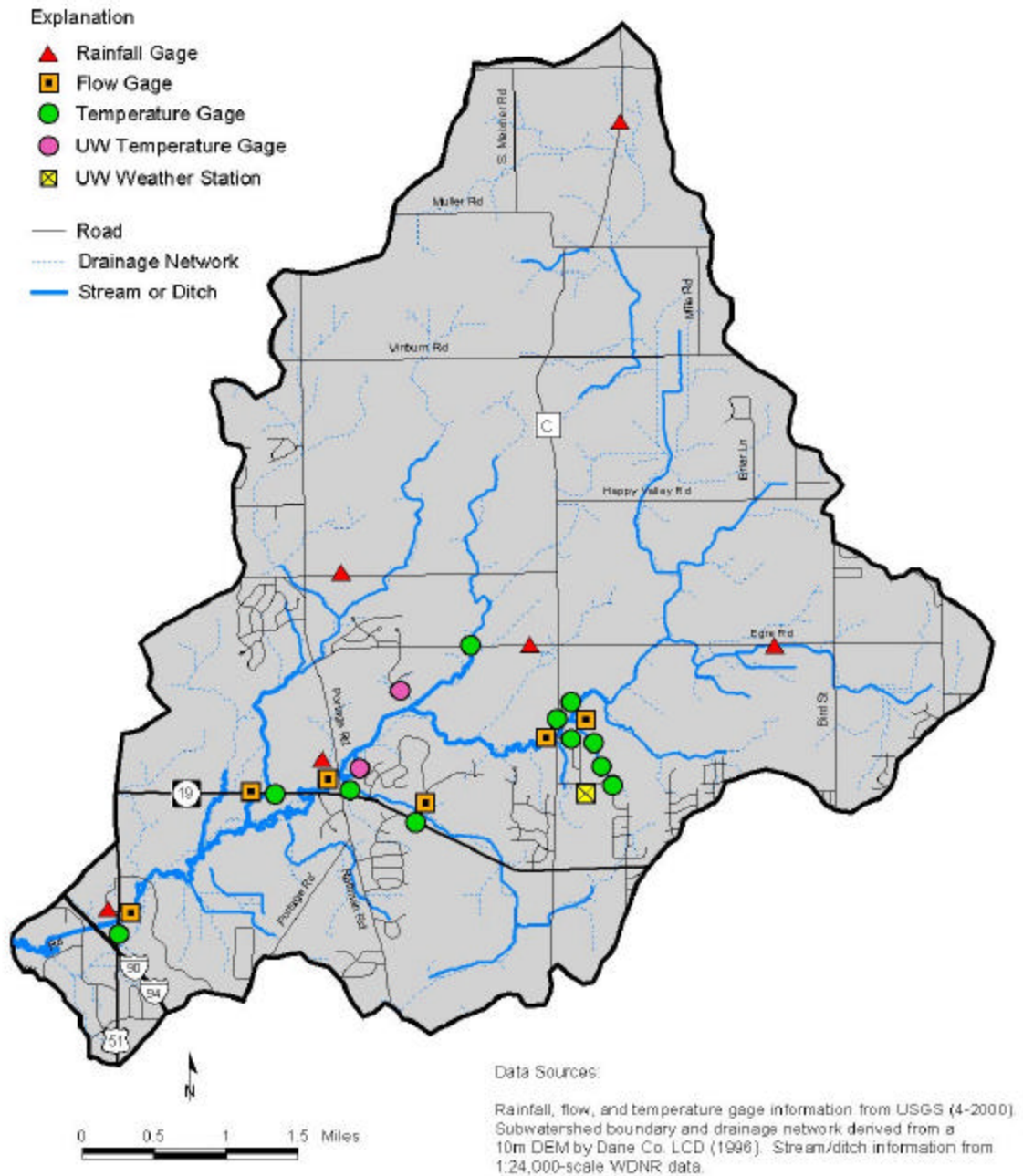




Figure 2. Land Use in the Token Creek Subwatershed

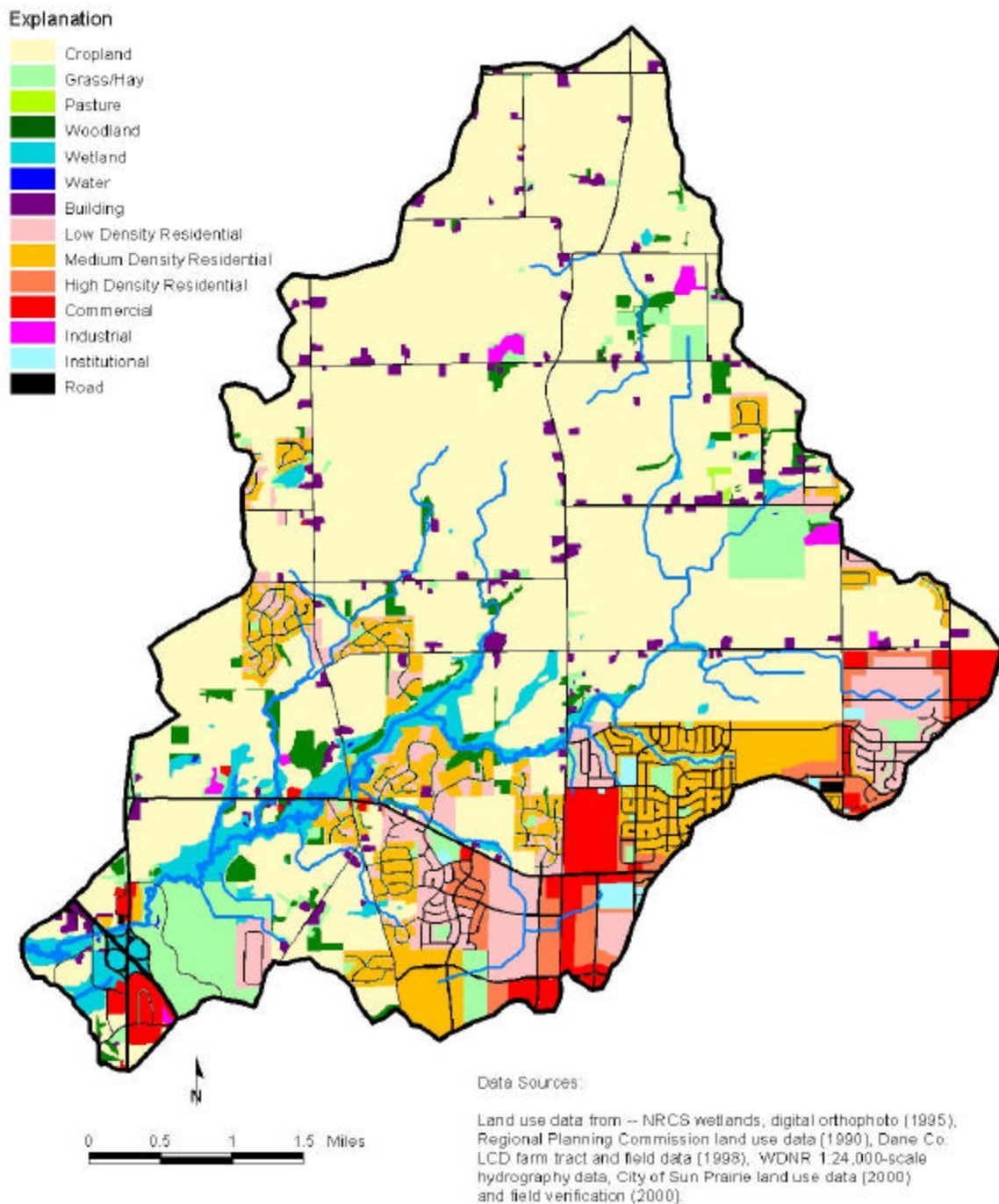
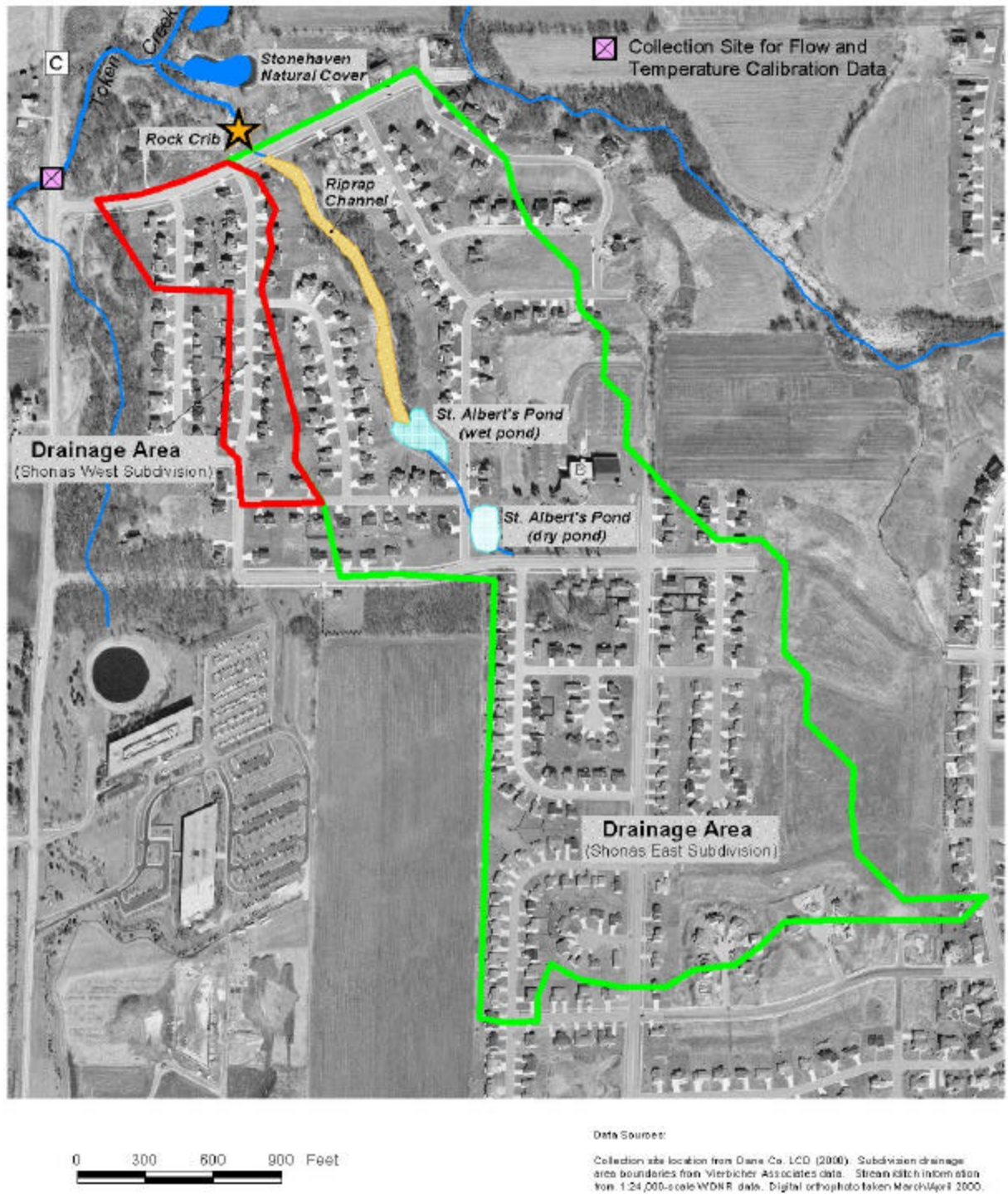


Figure 3. Detail of the TURM Model Testing Site



## 2.2. *TURM model in brief*

To estimate the thermal impacts of the study, TURM was used for urban sewer sheds. This model accounts for the fact that stormwater not only absorbs heat from impervious surfaces, but that it also cools these surfaces, reducing the ability of the impervious surface to heat runoff from additional rainfall. Other model considerations include: the amount and temperature of impervious surfaces, the ambient air temperature, the gain or loss of heat from the passage of water through swales, detention basins, and streams, the gain or loss of heat due to tree canopy, the heat loss due to evaporation, heat loss due to heat exchange in rock cribs, and the time and duration of storm events. In addition, the model accounts for the time difference between the runoff from impervious surfaces ( $TC_{\text{imperv}}$ ) and from vegetated areas ( $TC_{\text{veget}}$ ). However, TURM does not account for the inherited variability of rainfall due to changes in intensity and the type of storm, as the model assumes that the rainfall is uniform over the entire duration of the event.

The specific theoretical developments of TURM are listed as follows:

- 1) The convective transfer coefficient from Raney and Mihara (1974) was inappropriate for use in TURM, and under-estimated the heat lost to the air. The equation from Ryan and Harleman (1973) seems more appropriate.
- 2) Equations were developed to estimate the temperature of pavement on a clear day, before rain falls. This simple model formulation for estimating the difference between the surface pavement temperature and air temperature produces reasonable results when compared with field measurements.
- 3) The inclusion of air and rainfall temperature as inputs into the model indicates that wet bulb temperature during the rainfall period is a reasonable approximation of raindrop temperatures.
- 4) A routine was developed in the model to account for the cooling effect of dry and water fill rock crib.

## 3. Measurements

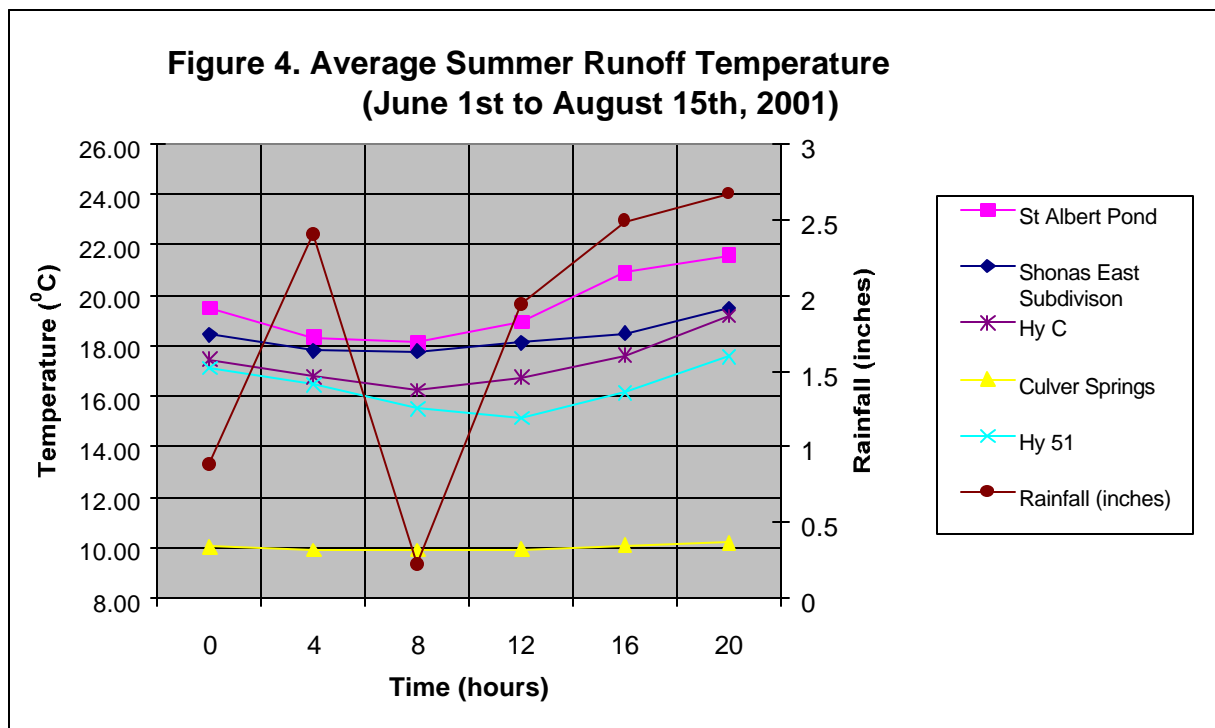
The thermal analysis data from TURM indicates that storm-water runoff from Token Creek subwatershed's impervious areas can increase the temperature of the stream. Furthermore, depending on the time of day that the rainfall event occurred, the impact of runoff on the receiving waters can cause the stream temperature to reach lethal levels (Figure 4).

The model results are based solely on the data obtained between June 1<sup>st</sup> and August 15<sup>th</sup>, although the model is capable of producing year-round results. These months were chosen because, historically, they produce the largest amount of rainfall and the highest temperatures of the year. Runoff volumes for urban areas were calculated using the rainfall data collected by the University of Wisconsin's Soil Science Weather Station, the Wisconsin Department of Natural Resources, and the United States Geological Survey. The runoff was measured as a continuous stream flow in cubic feet-per-second at six gauging stations, (Figure 1), while the flow rate at the outfall of each sewershed was determined by the ratio of rainfall depth to the individual land use (curve numbers).

Table 2. Runoff Temperature Summary (June 1<sup>st</sup> –August 15<sup>th</sup>, 2000)

Site	Time (In 4 Hour Intervals)					
	0	4	8	12	16	20
St Albert Pond	19.51	18.34	18.11	18.95	20.91	21.58
Shonas Upstream Pond	17.84	16.66	17.08	18.75	20.70	20.81
Shonas East Subdivision	18.43	17.82	17.79	18.12	18.49	19.48
Shonas West Subdivision	18.25	17.39	17.16	17.82	18.67	19.40
Token Branch Up	16.60	15.80	15.24	15.53	16.16	17.85
After Rock Crib	17.45	16.09	15.38	15.52	16.50	17.30
Stonehaven Grassed Area	15.06	14.80	15.22	16.30	16.62	17.91
Highway C	17.45	16.76	16.26	16.73	17.62	19.18
Culver Springs	10.02	9.89	9.89	9.93	10.07	10.18
Highway 51	17.12	16.44	15.49	15.12	16.15	17.57
Rainfall (inches)	0.88	2.40	0.22	1.94	2.49	2.67

The data presented in tables 2 through 5 and displayed in Figures 4 through 10 represents a summary of the field data collected by the USGS and WDNR Fisheries Department during June, July, and August 2000.



### 3.1. Measurements of June 4, 2000

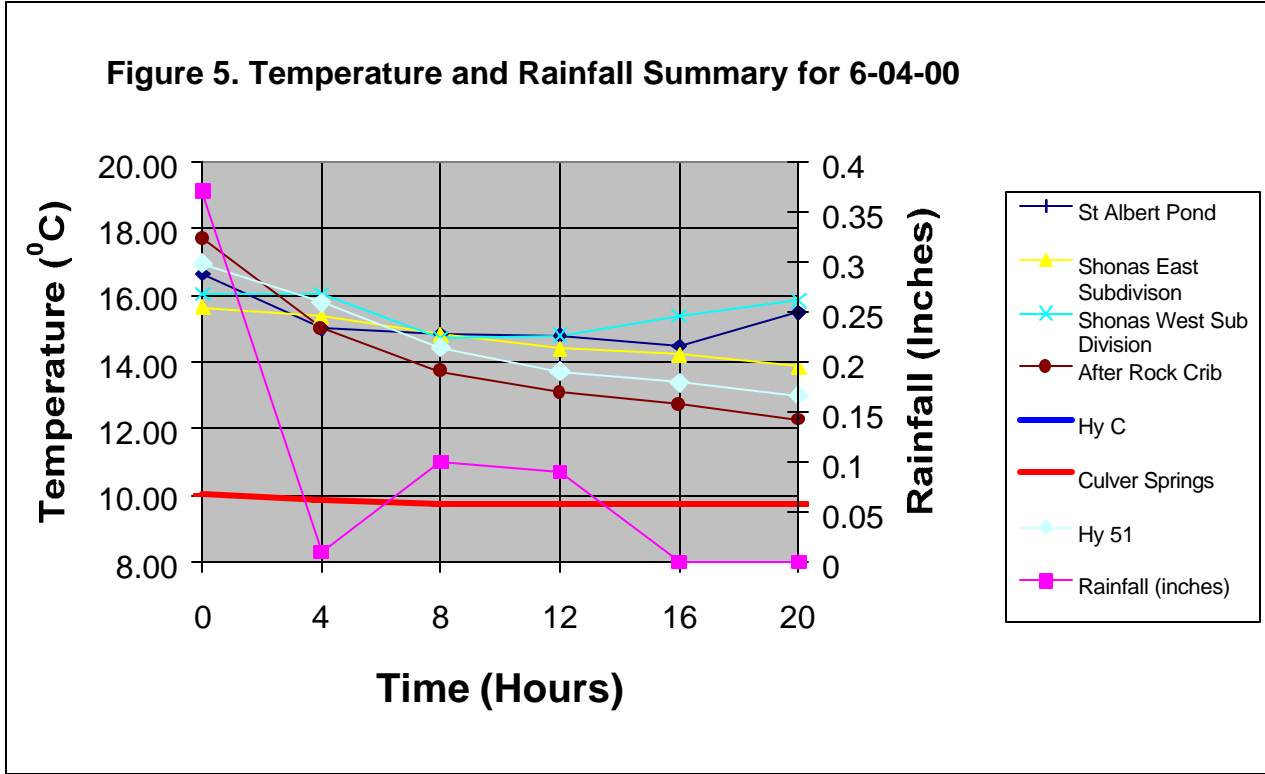
The 0.37 inches of rain fell in the early morning hours of June 4<sup>th</sup>. During this event, a temperature difference of approximately 3° C was observed between the non-urban (Stonehaven, Token Branch Up) and urban areas at the onset of the rain. The urban areas measured, on average, 6° C higher than Culver Springs, or twice the temperature increase measured at the non-urban areas. Because this rainfall occurred in the early morning hours, the impervious areas had not yet been warmed by the sun, resulting in a lower than average high water temperature for urban areas. The high temperatures for the urban and non-urban areas for this event were very similar, separated by ~2° C.

The rain began at hour 4 and ended at hour 16 with 0.1 inches of rain. The runoff temperatures for the entire study area declined throughout the storm event and were compared to the air temperature, rainfall temperature, and the solar radiation data (measured at the weather station). The resulting temperatures were the lowest recorded during the entire study period (Table 3 and Figure 5). This data relates that thermal impact is closely related to the weather conditions and the time of day when the rainfall event occurred.

The thermal impact of the runoff from the Shonas urban area on the crib was minimal, measuring only 2.5° C. This is significant because the temperature of the runoff after the crib represents the temperature of the ground water during and after the rainfall event (Figure 5). Due to the low intensity and long duration of this storm event, the runoff from the Shonas urban areas did not overwhelm the heat exchange capacity of the rock or the cooling effect of the water in the rock crib. Thus, the temperature of the runoff after crib was within 1° C of the temperature of the stream at Highway 51 (table 3).

Table 3. Temperature and rainfall data summary for June 04, 2000

Site	Time (Hour)						
	Date	0	4	8	12	16	20
Shonas St. Albert	04-Jun	16.63	15.00	14.84	14.80	14.47	15.48
Shonas Upstream Pond	04-Jun	16.53	15.36	14.22	14.02	14.34	15.04
Shonas East Subdivision	04-Jun	15.64	15.36	14.82	14.39	14.22	13.85
Shonas West Subdivision	04-Jun	16.03	16.02	14.68	14.79	15.37	15.83
Token Branch Up	04-Jun	16.08	14.77	13.78	13.18	13.01	12.98
After Rock Crib	04-Jun	17.69	15.00	13.72	13.08	12.72	12.26
Stonehaven	04-Jun	13.79	13.43	13.31	13.09	12.89	13.30
Highway C	04-Jun						
Culver Springs	04-Jun	10.01	9.83	9.73	9.73	9.76	9.73
Highway 51	04-Jun	16.94	15.77	14.43	13.71	13.38	13.00
Rainfall (Inches)	04-Jun	0.37	0.01	0.1	0.09	0	0



3.2. *Measurements of July 10, 2000*

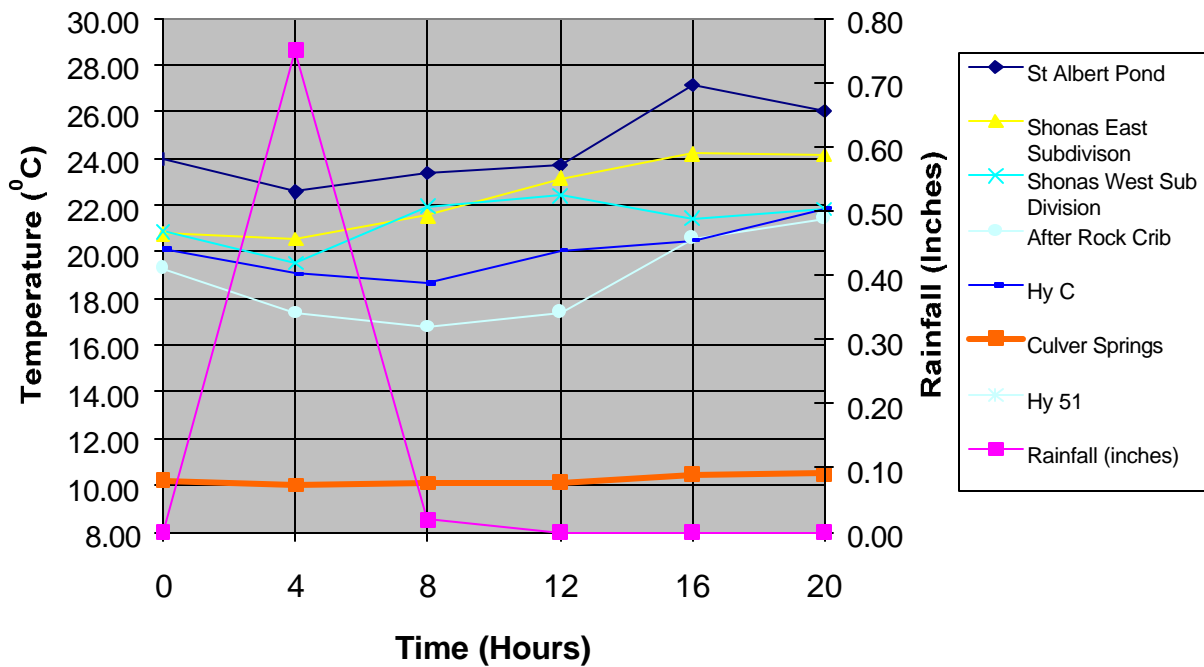
Table 4 and Figure 6 show the results of a 0.77-inch rainfall, which was preceded by 0.20 inches of rain on July 9<sup>th</sup> between the hours of 10 and 12. The rain on the 10<sup>th</sup> began at hour 0 and ended at hour 8, during a period of time when the sun shines only briefly, meaning that most of the increase in runoff temperature is due to the stored heat in impervious surfaces.

The temperatures at St. Albert Pond, which collects drainage from an urbanized area, ranged from 22.59° C to 27.15° C, with an average temperature of 24.47° C. These temperatures were the highest that were recorded at any location during the course of this study and represent near lethal to lethal temperatures for many cold-water species; including fish such as the Brown and Brook Trout. In contrast, the temperatures recorded at Culver Springs reached a high of only 10.51° C, 12-17 ° C lower than the temperatures recorded at St. Albert Pond.

Table 4. Temperature and Rainfall Data Summary for July 10, 2000

Site	Time (Hour)						
	Date	0	4	8	12	16	20
Shonas St. Albert	10-Jul	23.98	22.59	23.36	23.72	27.15	26.03
Shonas Upstream Pond	10-Jul	21.87	20.04	21.84	22.35	24.99	24.43
Shonas East Subdivision	10-Jul	20.76	20.55	21.55	23.14	24.19	24.13
Shonas West Subdivision	10-Jul	20.86	19.53	21.96	22.39	21.42	21.83
Token Branch Up	10-Jul	20.08	18.96	18.48	19.78	20.29	21.93
After Rock Crib	10-Jul	19.28	17.39	16.79	17.42	20.56	21.41
Stonehaven	10-Jul	16.75	16.05	19.18	22.09	22.22	21.28
Highway C	10-Jul	20.14	19.07	18.66	20.06	20.48	21.88
Culver Springs	10-Jul	19.25	18.86	17.16	15.79	18.08	20.33
Highway 51	10-Jul	10.22	10.02	10.11	10.13	10.48	10.51
Rainfall (Inches)	10-Jul	0	0.75	0.02	0	0	0

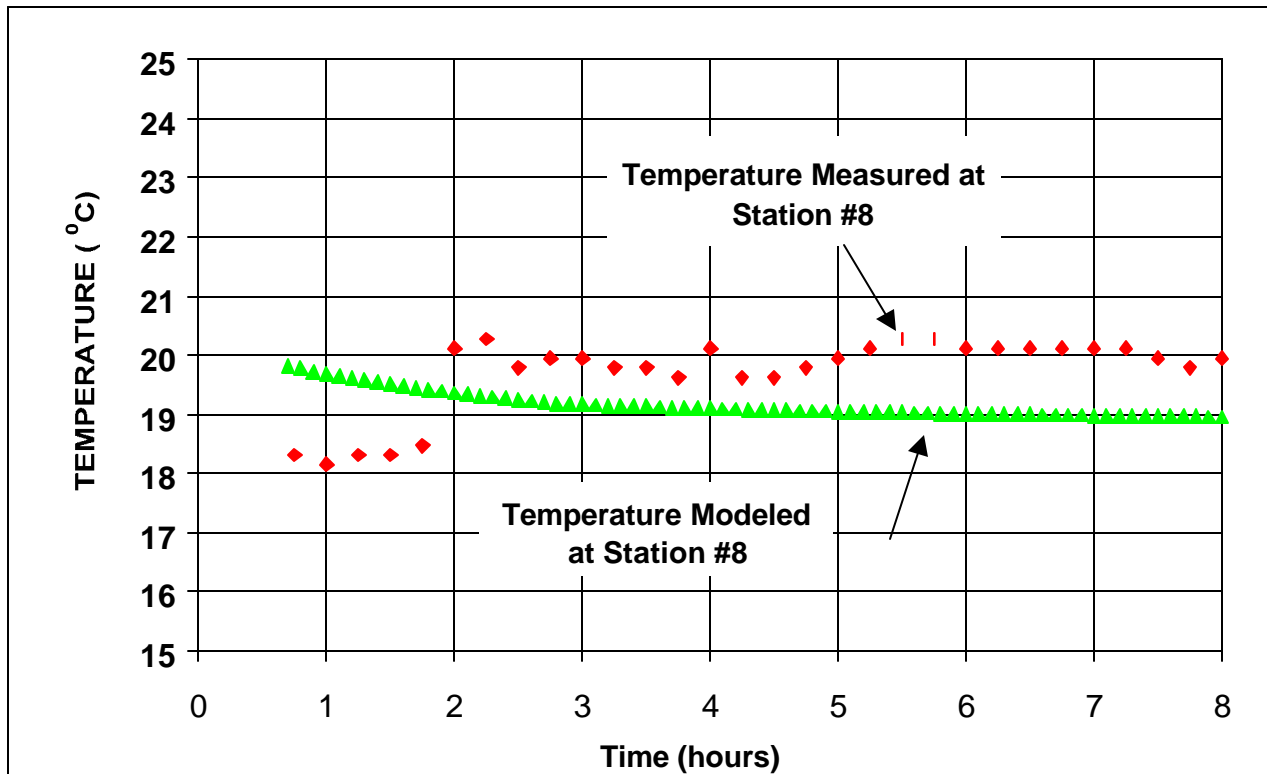
Figure 6. Temperature and Rainfall Summary for 7-10-00



### 3.3. Comparison of model results with measurements at St. Albert Shonas

Figure 7 presents the average temperature of runoff that drained into St. Albert's dry detention pond. The measured temperature averaged 19.54° C, 0.42° C greater than the modeled temperature, 19.12° C. The model, represented in Figure 7, over-predicts the initial runoff temperature by ~2° C because the model assumes that runoff is produced immediately after the rainfall event starts. However, some rainfall evaporates when it meets the pavement, while some is stored in the micro-depressions present in pavement and other impervious surfaces. Because of this assumption, this immediate runoff has the highest modeled temperature for the event. At mid-day (between hours 12 and 16), pavement temperatures in urban areas are often considerably higher than air temperatures, and TURM requires an initial temperature before an estimate of runoff temperature can be made. To correct this problem, maximum air temperature, minimum air temperature, and mean wind speed at midday hours were used to solve for the temperature difference. The approach for this simple set of equations is to solve for the temperature difference between the black top surface and the air at hour 17, when the conduction flux into the pavement is zero, and also at hour 5 when surface heat conduction equals zero.

**Figure 7. Measured and predicted runoff temperatures at St Albert Shonas**

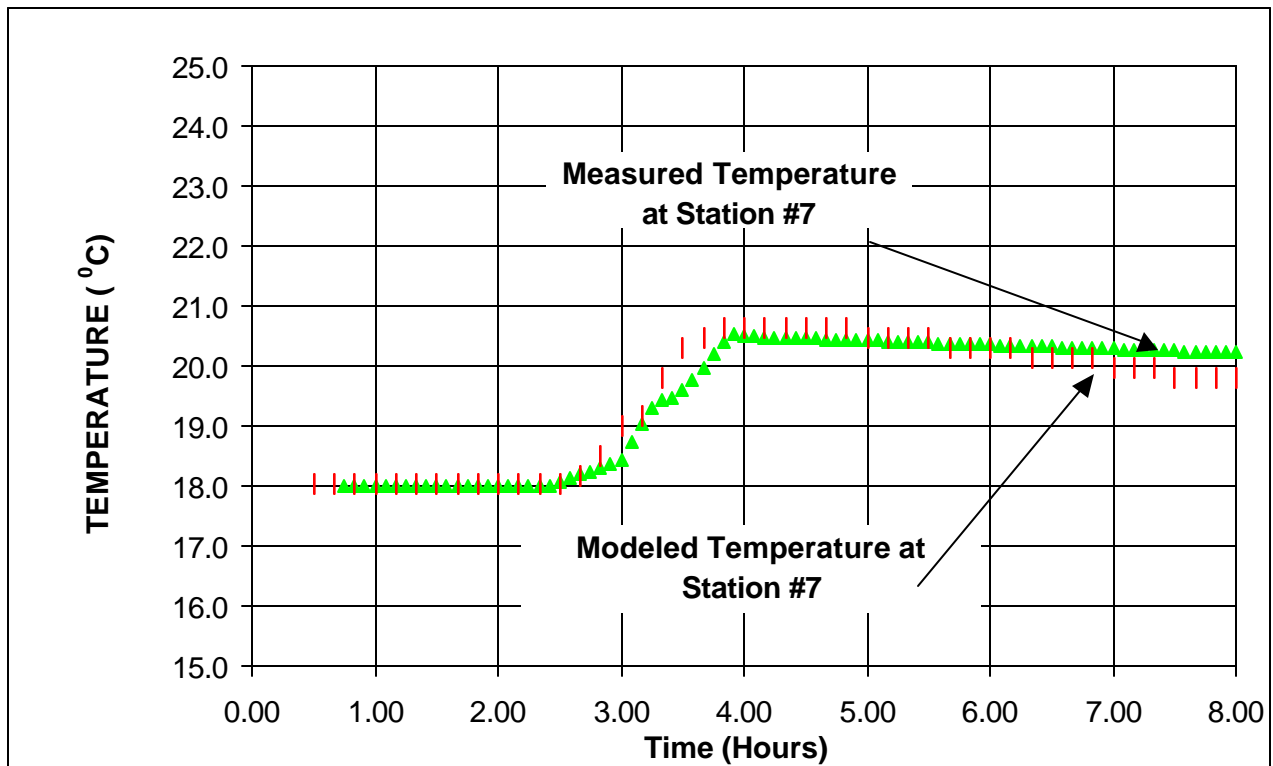




**Shonas Pond:** The temperatures predicted for the St. Albert Shonas areas were assumed to be the initial temperature of the runoff when it was delivered to the pond. The average runoff temperature over the duration of the rainfall and the duration of the effective runoff was measured at 20.27° C, while the model predicted a temperature of 20.76° C, a difference of 0.5° C. However, the actual runoff temperature was influenced by the storage water in the pond, which was assumed to be equal to the air temperature prior to the rain, which may account for some of the difference in the results.

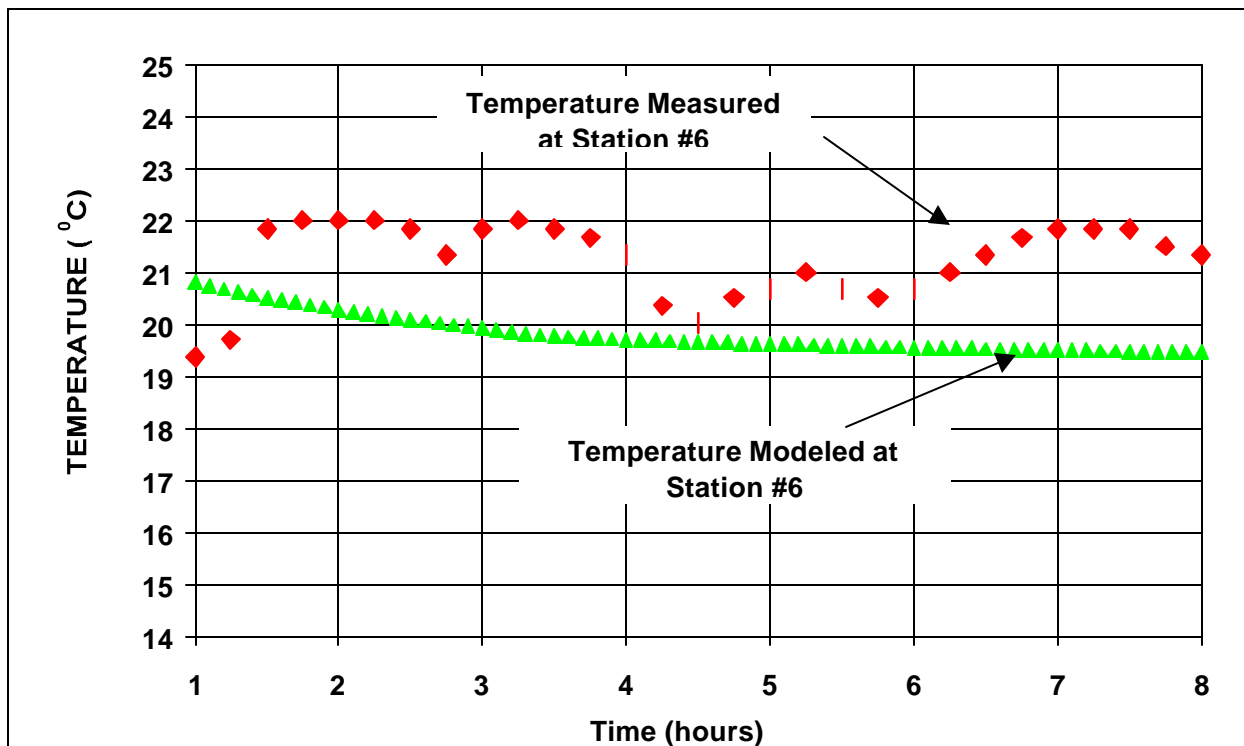
**Shonas East:** The runoff from Shonas East is delivered to the rock crib by a rock-lined channel. The rock-lined channel's time of concentration is related to the voids of the channel bottom, the interception by the rock, and the roughness coefficient of the rocks that impede the free flow of the runoff. These characteristics reduce the inherited variability of the rainfall, stabilizing the time of concentration and allowing the model to more accurately predict the temperature of the runoff. The rock temperature was assumed to be the same as the air temperature when the rain began to fall, while the initial temperature of the runoff was assumed to be the same temperature of the pond. The temperatures changed according to the relationship developed in Figure 8. The heat exchange in the rock channel was modeled to occur initially at air temperature (before the rain fell) and the heated runoff from the impervious areas and was calculated utilizing the model for dry rock basins. The predicted runoff temperature (19.25° C), proved to be very close (within 0.27° C) to the field data (19.52° C).

**Figure 8. Measured and predicted runoff temperatures at Shonas East**



**Shonas West:** The runoff was delivered to the rock crib directly by a 24-inch concrete pipe. The temperature of the runoff from Shonas West (12 acres and 40% impervious) was modeled as a direct heat transfer from the impervious areas to the runoff. Figure 9 presents the average runoff temperatures from the impervious areas that drain to the outfall at Shonas West. The average, calculated over 12 hours, was measured at 21.25° C and modeled at 19.82° C, for a difference of 1.4° C over the entire runoff event. The model, represented in Figure 9, shows that the model over-predicted the initial runoff temperature by 1.5° C. As previously discussed, the model assumes immediate runoff and does not allow for the delays that occur in the field. TURM also does not account for the inherited variability of the rainfall due to changes in intensity and the type of storm; rather, it assumes a uniform rainfall over the entire duration. This relationship is shown in Figure 9.

**Figure 9. Measured and predicted runoff temperatures at Shonas West**



In a study conducted by Steve Greb of the WDNR in 1996, measurements were made of the runoff flow and temperature, and pavement temperature from a parking lot in the City of Madison, Wisconsin. The weather conditions during this study showed 0.43 mm of rain, wind speed of 3.3 m/s, air temperature of 26° C, relative humidity of 92%, as well as the temperature of the pavement and roof tops (40° C and 50° C). The rainfall lasted 39 minutes. The results from the study proved to be very encouraging. The measured runoff outflow temperature averaged 29.3° C. Using the TURM, the predicted the temperature of the runoff was 29.4° C, indicating a difference between measured and predicted temperatures of only 1° C.

### 3.4. *Runoff Thermal Regime Best Management Practice (BMP)*

The thermal impact of the impervious areas on stream temperature for the St. Albert events was moderated by rock crib and by the base flow from Culver Springs, resulting in little change in stream temperature. Overall, after the rainfall event began, the temperatures predicted by TURM remained within 1° C of the actual measured temperatures for this event (Figures 7 to 10).

The rock crib was monitored for flow and temperature at the two inlets that drain into the crib, as well as 50 feet below the crib. The crib was built with the assumption that water that runs off impervious areas could be cooled by passing it through an underground rock chamber. From initial calculations, if the crib is empty, the conduction of heat from the rock limits heat transfer to the water, rather than the convective transfer coefficient of the moving water. As a result, the problem is one of transient heat conduction from spheres. If the space between the rocks is filled with water, the heat exchange in the crib is one of mixing, displacement, and the convective transfer coefficient of the moving water. Unfortunately, no analytical solution to this transient heat conduction is available, so a numerical solution was used.

The 255 m<sup>3</sup> rock crib received runoff from Shonas East (140 acres) and Shonas West (12 Acres). The runoff flowed through paving blocks (25% porous) on the surface to an opening filled with pea gravel, where the runoff was filtered into the rock crib, which is filled with ground water and stone. The temperature of the rock in the crib was assumed to be the same as the ground water temperature (15° C). The runoff (initially 30° C, enters and filters into the ground at the moment of the rain, with the temperature of the runoff (measured at each time step) changing according to the relationship developed in Figure 10. As previously discussed, the temperature of rain and the air are closely related, and the runoff temperature depends on the heat exchange with the stone in the riprap channel. The model has two heat exchange processes: the initial exchange between the heated runoff and the stone, followed by the heat exchange caused by the mixing of ground water with the runoff. The effectiveness of the rock crib depends on the ratio of the volume of runoff and the volume of the rock crib, as well as the volume of water stored in the crib prior to the rainfall event. In this case, the crib was filled to capacity (9,000 ft<sup>3</sup>), resulting in an effective thermal treatment for the 140 acres of urban development it drained. The field data shows that the rock crib mitigates the thermal impact caused by impervious areas until the initial volume of the crib has been completely replaced by the runoff. After the volume has been replaced, the rock crib no longer provides a thermal reduction for stormwater.

**Figure 10. Measured and Predicted Runoff Temperatures at the Rock Crib**

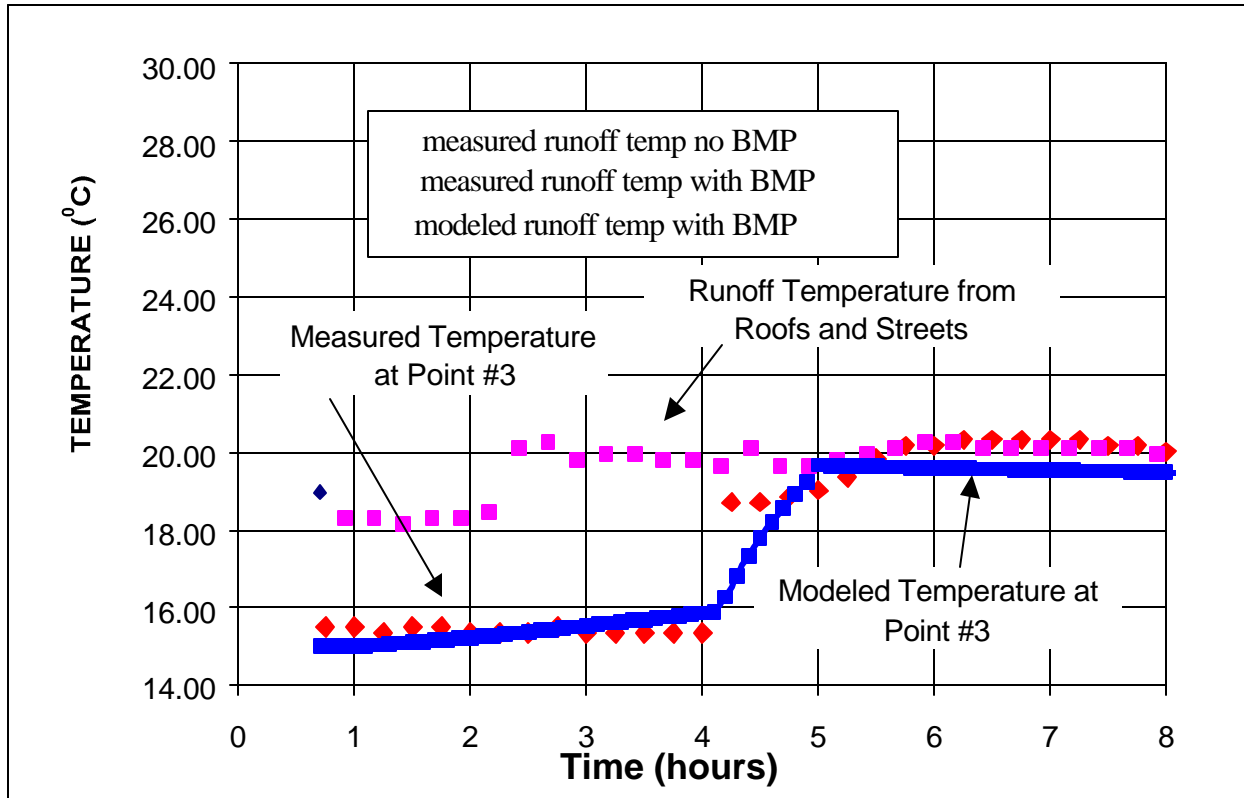
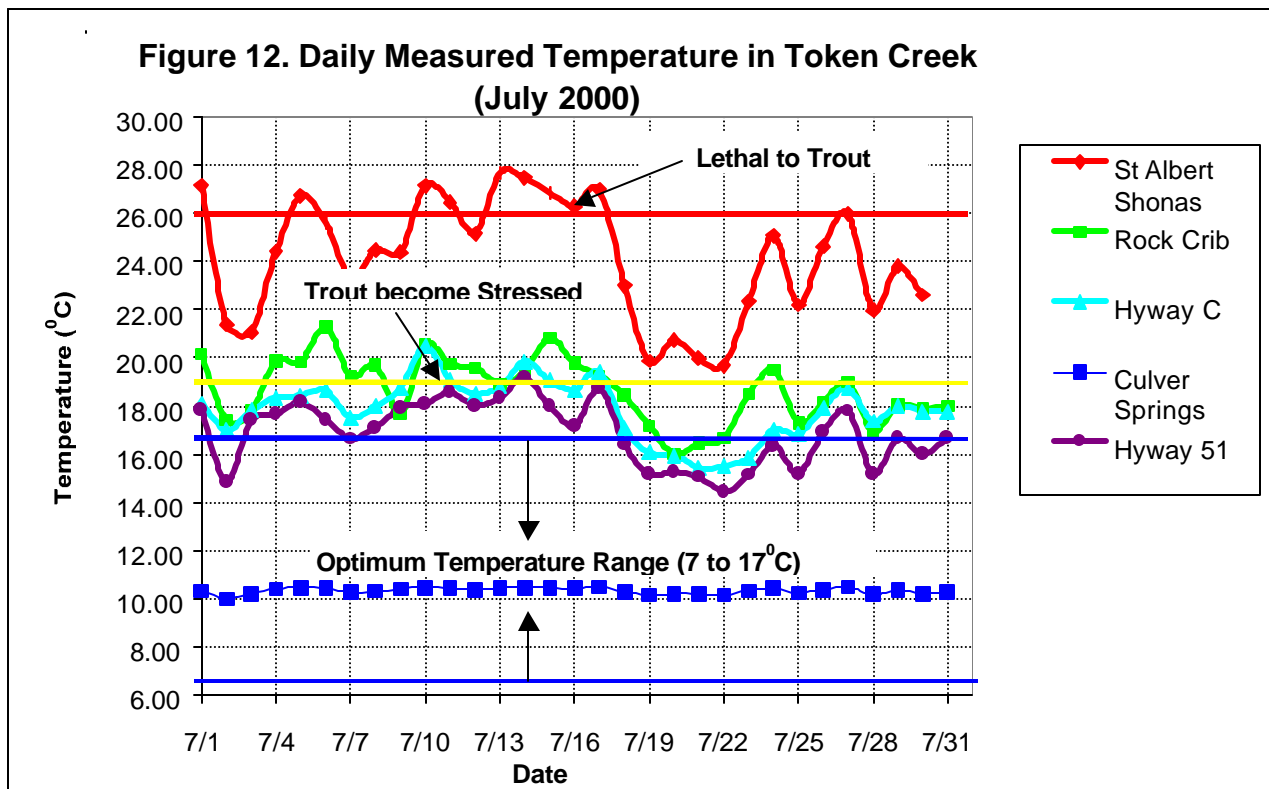
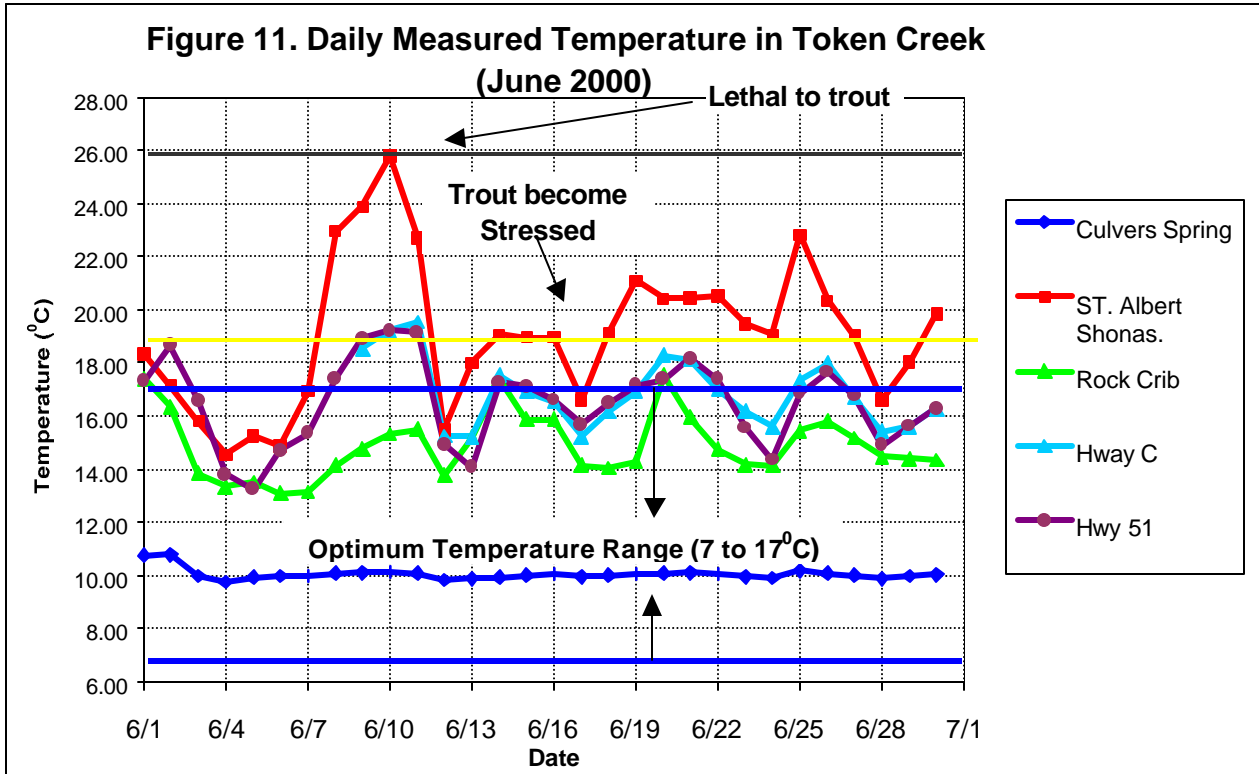


Table 5 shows a summary of the measured temperatures (recorded every 15 minutes) and the modeled temperatures (predicted every 5 minutes). The thermal impact was modeled for a 14-hour period because runoff and heat exchange continue after the rain has stopped. When runoff is directly discharged into an outfall from an impervious surface, the model does not account for the variability in rainfall intensity changes. However, when the runoff is delivered to a BMP, such as a pond, grassed channel, or rock crib, the variability of the attenuation factor is reduced because BMPs temporarily store runoff before releasing it at a preset rate to a receiving streams.

**Table 5. Measured vs. Modeled Runoff Temperatures at Selected Sites  
(15-Minute Intervals)**

Time of Rainfall Event	Measured Temperature Albert Shonas (Station #8) (° C)	Calculated Temperature at St. Albert Shonas (Station #8) (° C)	Measured Temperature at Shonas East (Station #7) (° C)	Calculated Temperature at Shonas East (Station #7) (° C)	Measured Temperature at Shonas West (Station #6) (° C)	Calculated Temperature at Shonas West (Station #6) (° C)	Measured Temperature at Rock Crib Shonas (Station #3) (° C)	Calculated Temperature at Rock Crib Shonas (Station #3) (° C)
12:00	18.32	19.61	18.02	18.00	19.55	21.05	15.35	15.50
12:15	18.16	19.54	18.02	18.00	19.38	20.88	15.51	15.50
12:30	18.32	19.48	18.02	18.00	19.71	20.68	15.51	15.50
12:45	18.32	19.42	18.02	18.00	21.84	20.57	15.35	15.50
13:00	18.48	19.37	18.02	18.00	22.01	20.42	15.35	15.50
13:15	20.12	19.32	18.02	18.00	22.01	20.34	15.35	15.50
13:30	20.28	19.27	18.02	18.06	22.01	20.25	15.51	15.50
13:45	19.79	19.23	18.02	18.25	21.84	20.14	15.35	15.60
14:00	19.95	19.19	18.02	18.42	21.34	20.03	15.35	15.70
14:15	19.95	19.17	18.02	19.03	21.84	19.96	15.35	15.80
14:30	19.79	19.16	18.02	19.48	22.01	19.86	15.35	15.90
14:45	19.79	19.14	18.02	19.76	21.84	19.80	15.35	17.33
15:00	19.63	19.13	18.02	20.41	21.67	19.75	18.71	18.59
15:15	20.12	19.12	18.18	20.49	21.34	19.72	18.71	19.67
15:30	19.63	19.10	18.51	20.48	20.36	19.71	18.87	19.66
15:45	19.63	19.09	18.99	20.47	20.03	19.69	19.03	19.66
16:00	19.79	19.08	19.16	20.45	20.52	19.66	19.36	19.65
16:15	19.95	19.07	19.81	20.43	20.68	19.64	19.84	19.64
16:30	20.12	19.06	20.29	20.42	21.01	19.61	20.17	19.63
16:45	20.28	19.05	20.46	20.41	20.68	19.60	20.17	19.63
17:00	20.28	19.05	20.62	20.39	20.52	19.58	20.33	19.62
17:15	20.12	19.04	20.62	20.38	20.68	19.57	20.33	19.61
17:30	20.12	19.03	20.62	20.36	21.01	19.55	20.33	19.60
17:45	20.12	19.02	20.62	20.35	21.34	19.54	20.33	19.60
18:00	20.12	19.02	20.62	20.33	21.67	19.52	20.33	19.59
18:15	20.12	19.01	20.62	20.32	21.84	19.52	20.17	19.59
18:30	20.12	19.00	20.62	20.30	21.84	19.50	20.17	19.58
18:45	19.95	19.00	20.46	20.29	21.84	19.49	20.01	19.57
19:00	19.79	18.99	20.46	20.27	21.51	19.48	20.01	19.57
19:15	19.95	18.99	20.46	20.32	21.34	19.52	20.01	19.56
19:30	19.79	18.98	20.46	20.26	21.51	19.47	19.84	19.56
19:45	19.95	18.98	20.29	20.25	21.67	19.46	19.84	19.55
20:00	20.12	18.97	20.29	20.25	21.67	19.46	19.68	19.55
<b>Average</b>	<b>19.54</b>	<b>19.12</b>	<b>19.41</b>	<b>19.70</b>	<b>21.25</b>	<b>19.82</b>	<b>18.40</b>	<b>18.33</b>
<b>Standard Deviation</b>		<b>0.90</b>		<b>0.73</b>		<b>1.90</b>		<b>.57</b>



#### 4. Conclusions

In this study, we have clearly illustrated that the existing urban development in the Token Creek subwatershed causes an increase in runoff temperatures. Further, the increases recorded at Highway 51 suggest that these increases cause a permanent rise in stream temperature.

The daily temperatures of Token Creek are presented in Figures 11 and 12 for the months of June and July. During June, the temperature of Token Creek did not increase above the lethal limit (26° C, but did rise above 19° C at several points, including St. Albert Pond and St. Albert Shonas, as well as at the major points of confluence in Token Creek Subwatershed (Highway C and Highway 51). The runoff temperatures at the outfall of St. Albert Pond were directly impacted by the heat exchange between the black top and the rainfall. The temperatures recorded during June continued to rise after each rainfall, reaching levels above the threshold for trout (19° C), while temperatures recorded during July often reached the lethal threshold (26° C). The cumulative temperature increase caused by new developments will have a profoundly negative impact on the sensitive cold-water community in Token Creek if provisions to reduce the thermal impact are not implemented. In order to predict the conduction of heat to the runoff, TURM takes into account two factors:

- 1) Time of concentration. In the present model, the runoff from impervious areas is delivered instantaneously to the conveyance system. However, due to micro-depressions and evaporation, peak runoff flow does not begin instantaneously.
- 2) A correction in the convective transfer coefficient, resulting in less heat being lost to the air. The result is that the pavement heats rainwater up more and during longer periods, which is the case for runoff in impervious surfaces in urban settings.

TURM was validated successfully, predicting temperatures within 1° C of the actual temperatures recorded. The standard deviation was less than one, and significant at the 1% level for all sites when the field data was compared having the same mean ( $\mu_1 = \mu_2$ ). When used for estimating the difference between pavement and air temperatures, TURM produces reasonable results compared to the field data collected by USGS (pavement temperatures during this research were from 10 to 20° C above air temperature at midday). The results indicate that rain and air temperature are very closely related, a unique finding as little, if any, data has been published previously on the subject. Due to this correlation, it is possible to have an analytical solution based on the atmospheric variables that were incorporated into TURM.

Thermal impact analysis accounts for the impact that impervious areas have on stream temperatures. These impervious areas are generally associated with urban development and are a major source of thermal pollution in cold climates, not only because they remove water's ability to infiltrate into the soil, increasing the quantity of runoff, but because they store heat. As rainfall passes over impervious areas such as rooftops, roadways, and parking lots, it absorbs a portion of the energy stored in the surface. Cumulatively, the rise in runoff temperature causes an increase in the temperature of the stream, degrading the habitat and the diversity of the stream. To reduce the thermal impacts on streams, effective Storm Water Best Management Practices should be used. Some examples of BMPs include: rain gardens, rock catchment basins, swales, deep tilling, constructed wetlands, reforestation, and buffer strips

The model for the rock crib indicates that cooling can be obtained from rock storage for a limited time and that the cooling depends on the size of the crib. Because TURM is based on an analytical solution, we can extend the model to other temperature reduction devices, such as detention ponds, dry ponds, deep rock trenches, drain tiles filled with pea gravel, grassed swales, and green areas. These practices and many others can be utilized to reduce runoff temperatures; however, any device selected should be integrated as part of a storm water management plan.

As a result of this study, it is clear that municipalities and developers alike should implement a system of BMPs to reduce the impact that impervious areas have on lakes, rivers, streams, and wetlands. Rock cribs, which are a relatively new thermal reduction device developed by the Dane County Land Conservation Department, proved to be very successful at reducing runoff temperatures during this study. In addition, they are a practical, attractive option for new developments and can be used to augment existing thermal reduction systems. The use of BMPs is critical to reduce the thermal impacts caused by urban areas and imperviousness and to ensure the future diversity and health of aquatic ecosystems.

*Acknowledgements:* This work was undertaken with support from the Wisconsin Department of Natural Resources (WDNR), Kevin Cornnors and the Dane County Land Conservation Department, and the University of Wisconsin-Madison.

## 5. References

- Aida, M. 1982a. Urban albedo as a function of the urban structure-A model experiment. *Boundary Layer Meteorol.* 23, 405-413.
- Campbell, G.S. and J.M. Norman. 1998. *Introduction to environmental biophysics.* Springer Verlag Publ. Co., N.Y.
- Galli and Robert Dubose, 1990. *Water temperature and Fresh water Stream Biota. An Overview.* Dept. of Environmental Programs. Metro. Wash. Council of Governments.
- David, Marshall, 2001. DNR Biologist. Personal communication.
- Lyons, J. L. Wang and T .D. Simonson. 1996. Development and validation of and index of biotic integrity for cold water streams in Wisconsin. *North America Journal of Fisheries management* 16:241-356.
- Norman, J.M. 1967. An application of harmonic analysis to an in-site determination of soil thermal diffusivity. M.S. Thesis, University of Minn., St. Paul, MN
- Norman, J.M and A. Roa-Espinosa. 2001. Modeling the effect of the natural environment and urban runoff on stream temperature.
- Raney, F.C. and Y. Mihara. 1974. Water and soil temperature. *In Irrigation of Agricultural Lands.* eds. R.M. Hagen, H.R. Haise and T.W. Edminster. No. 11 in Agronomy Series, Amer. Soc. Agron. Publ., Madison, WI. pp.1024 - 1036
- Ryan, P.J. and D.R.F. Harleman. 1973. An analytical and experimental study of transient cooling pond behavior. M.I.T. Dept. of Civil engr., Ralph M. Parsons Lab, Tech. Rept. No. 161, Cambridge, MA.



# RAIN BARRELS – TRUTH OR CONSEQUENCES

Karen Sands, AICP and Thomas Chapman, P.E.  
Milwaukee Metropolitan Sewerage District  
Milwaukee, Wisconsin

## Abstract

Rain barrels are a centuries-old technique used by many cultures to collect rainwater from rooftops for later use or consumption. Recently, rain barrels have become popular in parts of the United States and Canada for a variety of uses, particularly among “green” proponents. Their uses may include garden and lawn watering (particularly during drought conditions), and even possible combined sewer overflow volume (CSO) reduction. In addition to the logistical and cost issues surrounding the use of rain barrels, proponents boast the right to a “free” resource on the grounds of environmental ethics. Although there are many potential benefits, there are a number of factors that sponsoring agencies must consider before embarking on a rain barrel program. The Milwaukee Metropolitan Sewerage District (MMSD) will begin advocating for and implementing such a rain barrel program. While considering whether to pursue rain barrels, staff worked to quantify the potential benefits to CSO reduction. No CSO volume reductions were demonstrated, but treatment cost reductions *were* realized. Therefore, a program to subsidize, distribute, and educate people about how to use rain barrels will be crafted and launched by the MMSD.

This paper describes rain barrels and how they work. It also explores how well rain barrels perform against some of the benefit assumptions, including water quality issues not generally discussed in this context. This paper also compiles a list of assumptions and suggestions for their use that encompasses barrel size and shape, key barrel features, climate considerations, algae and mosquito control, and home foundation protection, among other issues. It will explore these issues from a neutral position, with the end result being a recommendation for or against the use of rain barrels in the MMSD service area—a recommendation that may be applied by other sewerage agencies looking to reduce treatment costs while also reaping other environmental benefits.

## Introduction

Rain barrels are on-site rainwater collection systems. Rainwater can be collected as a valuable resource for lawn and garden watering, as well as possibly retained to reduce CSO volume and storm water management costs. Implementing a rain barrel program first requires an evaluation of the potential to meet desired results. The Milwaukee Metropolitan Sewerage District (MMSD) has studied the effectiveness and benefits of such a program, and is in the early stages of crafting and eventually implementing it. Aspects of that evaluation and factors to be considered during implementation are described below.

## Program Function

There are a number of factors to consider before implementing a rainbarrel distribution program. These include setting goals for the program, educating the user public about how to operate and care for rainbarrels, and being realistic about the benefits. While a potential program for the Milwaukee region may produce only modest results, there are side-benefits to be gained, such as educating people and getting them involved in possibly reducing the volume of CSOs. The effectiveness of any potential program could be enhanced through promoting an integrated management plan featuring compatible stormwater management concepts, including things like downspout disconnections, green roofs, raingardens, and grassy swales. In

fact, this is the direction to be taken by the MMSD. While some rainbarrel users also use the rainwater for drinking, the MMSD will not likely recommend this use (see below).

## Uses

Recently, rain barrels have become popular in parts of the United States and Canada for a variety of uses, particularly among “green” proponents. Their uses may include garden and lawn watering (particularly during drought conditions) or even CSO reduction. In addition to the practical and cost issues surrounding their usage, rain barrel proponents boast the right to a “free” natural resource on the grounds of environmental ethics.

Although there are many potential benefits, there are a number of factors sewerage agencies must consider before embarking on a rain barrel program. These include water quality issues, climate considerations, algae and mosquito control, physical site suitability, homeowner ability and willingness to operate effectively, and home foundation protection.

**Water Quality.** Rainwater collected in a barrel can provide a relatively clean, safe, and reliable source of water as long as the collection system is properly built and maintained. Rainwater that is to be used outside to water lawns or gardens is typically not a water quality concern. The roof construction materials should not be treated cedar shakes or materials containing asbestos. The gutter system should not have lead solder or lead-based paint, and bird droppings should be cleaned from gutters and the roof as needed. Depending on the location, an awareness of the dry deposition of pollutants from the air may also be warranted. Overall, rain barrel water quality is not a major concern unless the water is intended to be consumed. Filtration and disinfection would be necessary for consumption-based water use, and is beyond the scope of this analysis.

**Climate.** Climate considerations apply particularly where temperatures regularly reach freezing during winter months. Where this occurs, rainbarrels should be disconnected during winter months to ensure that water in rainbarrels doesn't freeze and damage barrels and/or allow water to back up into downspouts or overflow into building foundations. When rainbarrels are disconnected for winter months, they should be stored upside down so they may fully drain and remain relatively clean. During this time, downspouts should be reattached so that winter precipitation doesn't damage foundations. In the Milwaukee, Wisconsin region, CSOs occur an average of 2.5 times per year. These have occurred overwhelmingly during non-winter months and, when they do occur in winter, are typically due to mechanical malfunction. Therefore, disconnecting rainbarrels in the winter will not likely reduce the effectiveness of rainbarrels as a CSO volume reduction approach.

**Algae.** Algae are microscopic, photosynthetic plants. When exposed to sunlight, chlorophyll in algae converts carbon dioxide (CO<sub>2</sub>) and water into glucose and oxygen (O<sub>2</sub>). Generally, algal growth in water is influenced primarily by the amount of nutrients (phosphorus, nitrogen, carbon, etc.) in water, and secondarily by the availability of light incident on the water. However, water temperature, water flow, available substrate, and pH also influence the growth of algae.

The primary factor controlling algal growth--nutrient content in water--generally comes from leaves, lawn clippings, fertilizer, pet waste, and non-contact cooling water that enter the water cycle *after* water is discharged from a rainbarrel. It would follow, therefore, that the nutrient content of rainbarrel water is not likely to be high, and may not be a large determinant in rainbarrel algae growth. Intuitively, there are exceptions to this: (1) rainbarrels that collect runoff from a green roof or rooftop garden and (2) rain gutters

that are filled with leaves, allowing rainwater to filter through. Raingardens remain rare in the Midwestern U.S., and the problem of leaves in the gutter is easily avoided by periodic cleaning to reduce this primary influence.

The secondary factor controlling algal growth is light. Light incident upon standing water in a rainbarrel is a function of rainbarrel design. Rainbarrels with open or screened tops or that allow light to penetrate will provide more light inside the barrels. Therefore, open and/or light colored rainbarrels would be more likely to contribute to algal growth. On the other hand, rainbarrels with openings limited to the size of the downspout or gutter tube would allow less light to reach water stored inside. Therefore, partially closed and/or darker rainbarrels would be less likely to contribute to algal growth.

Other factors listed above include water temperature, flow, and pH. Water temperature may be relatively high when rainbarrels are placed in full sun, thus increasing the risk of algal growth. Placing rainbarrels in shade can reduce this risk. Flow is virtually nonexistent, thus further increasing the overall risk of algal growth. Overall pH can be affected by roofing materials, and higher pH levels contribute to algal growth. Rainwater typically has a slightly lower pH and, therefore, higher pH is not likely an issue. Further study of this is suggested.

There are a number of factors, such as low nutrients, that tend to minimize algae growth. Other factors, such as incident light and water temperature, can be managed to further minimize (but not eliminate) the potential for algae growth. While algae is typically considered undesirable, small amounts of algae that may grow in a rainbarrel may actually help to fertilize gardens and lawns. Given that some causal factors are not favorable and that others may be minimized, algae growth in rainbarrels can be kept in check by selection of barrel characteristics that limit algal growth and proper barrel placement.

**Mosquitoes.** West Nile virus is increasingly becoming a concern in the Midwest, as an increasing number of illnesses and deaths are blamed on the virus. Mosquitoes tend to breed in wet areas, and the *Culex* mosquito that carries and transmits West Nile virus is found where there is decaying organic matter and wet conditions. Recommendations to reduce populations of *Culex* mosquitoes include source reduction of mosquito breeding sites and avoidance of biting mosquitoes. Recommendations for reducing breeding sites include eliminating or emptying artificial water collection containers described as “prime breeding spots for the mosquito species implicated in the transmission of West Nile Virus.” (See: <http://www.cfe.cornell.edu/erap/>). This potential connection between standing water breeding sites and rainbarrels may have implications for rain barrel use. Mosquitoes can breed in as little as 10 days. In rainbarrels that allow mosquitoes to enter, therefore, rainbarrels should be emptied in less than 10 days. Another potential solution is to screen the rainwater inlet so mosquitoes don't enter in the first place. In either case, user education is key to reducing the potential for *Culex* mosquito breeding sites.

**Physical Site Suitability.** Homeowners--rather than professionals--typically install rainbarrels, so it is very important that any distribution program make homeowners aware of the risk to their home foundations. Because water pooling near a foundation can eventually work its way into a home's basement, it's important to make sure the collection system keeps water away from the foundation. This includes properly channeling water from the inlet to the rainbarrel, provisions for rainbarrel overflow during larger storms, and drip-free spouts and hose connections. This also involves instructions on how to reattach downspout connections prior to winter months. With proper care, foundation and basement damage can be avoided.

There are some situations where rainbarrels may not be appropriate. These include high-density urban settings where there may not be a significant use for the collected water. Moreover, homes that are close together may not have an adequate area to contain rainbarrel overflow. Such homes in Milwaukee are more likely to be located within the combined sewer service area and, therefore, should be carefully evaluated, particularly when disconnecting direct downspouts to the combined sewer. Finally, where homes are located on smaller lots, there may be less opportunity for garden watering simply due to space constraints.

**Homeowner Willingness and Ability.** Proper care includes a willingness on the part of the homeowner to periodically check to see that connections and fittings are in proper working order, empty the barrel after a rainstorm (in advance of new rainstorms), remove the barrel and store it for winter, and reconnect the downspout. Some homeowners may see this work as bothersome, and still others may not be physically capable of performing the work. To have or not to have a rainbarrel is an individual decision. Incentive and assistance programs could be developed to encourage rain barrel use and proper maintenance.

### CSO Volume Reductions

The MMSD has responsibility for sewage conveyance and treatment as well as for flood management. MMSD's sewerage system includes a regional collection/conveyance system and two wastewater treatment plants. In the late 1970s and early 1980s, MMSD undertook a Water Pollution Abatement Program (WPAP), which included over \$2 billion in improvements to the conveyance system, treatment plants, and an inline storage system known as the "deep tunnel." Together, projects from the WPAP virtually eliminated separate sanitary overflows (SSOs) and reduced combined sewer overflows to an average of 2.5 times per year.

While the SSO and CSO goals of the WPAP were attained, the media and the public expect MMSD to further reduce CSO volumes. With this in mind, MMSD conducted an evaluation of a program that would utilize rain barrels in the combined sewer system area to reduce the volume of stormwater runoff. The study assumed 40,000 single-family homes in the combined sewer service area. Each home was estimated to have 1,200 square feet of roof area that emptied into two 90-gallon rain barrels, each collecting rainwater from 600 square feet of roof. Homeowners were assumed to empty the rain barrels after each storm event and the water would be released to infiltrate into the ground and not into the combined sewer system. An analysis of the precipitation record from 1940 to 1997 showed the following results:

Number of events:	78.2
Mean Volume:	0.40 inch
Median Volume:	0.19 inch
Mean Duration:	15.1 hours
Median Duration:	9 hours

The distribution of the storm events show half of all events are 0.19 inch or less, but we found that these events account for only 8.5 percent of the total rainfall volume. A 90-gallon rain barrel can hold 0.24 inch of rainfall from a 600 square foot roof. The annual capture amount from the 40,000 residences using two 90-gallon barrels was calculated to be 243 million gallons. With proper disposal, this volume represents water flow that would not need to be treated at the treatment plants. Most storm events that are 0.24 inch or less do not typically result in a CSO event. In fact, these relatively small storms with low rainfall volume are easily conveyed to the treatment plants. Even in a large storm the rain barrel volume collected in the beginning of the storm would not reduce the volume of a CSO, which happens much later in the storm. The study showed that an extensive rain barrel program would not have an impact on CSOs but that such a

program could reduce costs at the treatment plants. Further research is needed to determine if rain barrels used in conjunction with other on-lot treatments (rain gardens, storm water trees, boulevard swales, etc.) could be integrated to decrease runoff volumes enough to reduce the volume of a CSOs. While none of these other on-lot treatment programs may make a significant impact as a stand-alone solution, in combination there would likely be a greater benefit.

## **Recommendations**

An extensive rainbarrel distribution and use program may not provide reduction in CSO volumes, but would save treatment costs at the plants. There are a number of considerations that program sponsors must take into consideration before sponsoring a distribution program. These include:

- A realistic understanding of the goals to be met
- A public education program that includes the benefits, costs, and considerations of rainbarrels
- The likely need to provide technical assistance to homeowners

Likewise, homeowners must take into consideration a number of factors before deciding whether to become rainbarrel owners. These include:

- An understanding of how to operate rainbarrels, including the need to drain them within a reasonable period after a rainstorm
- A physical ability and personal commitment to operating rainbarrels as recommended

## **Conclusion**

There are a number of factors to consider before implementing a rainbarrel distribution program. These include setting goals for the program, educating the user public about how to operate and care for rainbarrels, and being realistic about the benefits. While a potential program for the Milwaukee region will produce only modest benefits, there are additional benefits to be gained by getting people involved in reducing treatment costs and by educating them in the process. And, the effectiveness of any potential program could be enhanced through promoting an integrated management plan that also promotes compatible stormwater management concepts, including things like green roofs, raingardens, storm water trees and grassy swales.

# **THE STRANGER AMONGST US: URBAN RUNOFF, THE FORGOTTEN LOCAL WATER RESOURCE**

Neal Shapiro  
City of Santa Monica  
Santa Monica, CA.

## **Abstract**

Urban runoff is an ignored and misunderstood local water resource. As a pollution problem, runoff is the single greatest source of water pollution in Southern California, specifically in the Santa Monica Bay and as an ecological problem causes degradation of water quality and impairment of beneficial uses, threatening the long-term health of marine ecosystems and local economies. As a water resource, capturing stormwater for groundwater recharge can add a significant regional water supply, lowering the region's dependence upon imported water, which causes ecological degradation and water supply disruption to distant watersheds. The City of Santa Monica adopted a strategy to solve both problems: harvest stormwater, treat it and infiltrate back into the ground, and keep a pollution source out of the Bay. The City's comprehensive watershed-urban runoff management approach includes: (1) an ordinance to require the harvesting of stormwater runoff from new development; (2) a philosophy of treating all dry weather and some wet weather urban runoff leaving the City; (3) a first-of-its-kind innovative recycling facility for dry weather runoff.

This runoff management approach allows for the development of a toolbox of innovative structural solutions, best management practices (BMPs), which can be tailored for each site's specific land use characteristics. A critical component of this successful toolbox is the unique management style: a shift from the traditional stormwater management approach of plumbing land, paving it over to move the maximum amount of runoff to receiving waters, to a low-impact site design approach of allowing the land to work within nature's hydrologic cycle, maximizing permeability and runoff infiltration into the ground.

The City ordinance requires low-impact BMP designs in new developments. These design techniques harvest precipitation and infiltrate it back into the ground, keeping urban runoff and its pollutants out of receiving waters. Not only are water quality objectives improved and beneficial uses restored as runoff is treated while passing across, through and into landscapes, but aquifers are recharged for future extraction.

The Santa Monica Urban Runoff Recycling Facility turns a perceived "waste" product into a natural resource, a commodity, for reuse in landscape irrigation and indoor plumbing, and eliminates dry weather runoff into the Bay. Secondary project goals include public outreach through urban runoff educational exhibits at the facility, and strong artistic and architectural elements into a highly functional design and community asset.

## **Introduction**

Studies cite contaminated urban runoff as the greatest single source of water pollution in the country. This non-point source urban runoff pollution problem in Southern California, specifically in the Santa Monica Bay, is one such major ecological problem, threatening the long-term health of marine ecosystems and local economies. The City of Santa Monica took a three-prong integrated management unique approach to this problem:

- Ground-breaking municipal ordinance to require the harvesting of stormwater runoff from new development;
- City goal of treating with Best Management Practices (BMPs) urban runoff from new City development and all urban runoff from its storm drain system before runoff leaves City boundaries; and
- Construction of a year-round dry weather runoff facility to treat and reuse in place of imported potable water urban runoff, the country's first dry weather urban runoff recycling facility.

The City redirected its approach to managing urban runoff from the traditional approach of moving runoff as fast as possible from the City and into the Bay, to a watershed approach in which the land is viewed as part of the hydrologic cycle and can absorb runoff for treatment and storage, keeping runoff out of the Bay. Instead of disrupting the water cycle, the City objective is to work with nature. Figure 1 demonstrates this approach, making a building and its surrounding hardscapes appear invisible to precipitation and runoff through the placement of BMPs and site planning so that rain runoff goes back into the ground to the maximum extent possible, instead of running off hardscapes into the street and water ways.



**Figure 1.** Making a building seem like it is not there in terms of precipitation and stormwater runoff to the land. On right, existing building and its hardscapes collect rain and runoff, and direct them onto the street and into the Bay, the Traditional Approach. On left, strategically-placed BMPs within the landscape receive runoff from the building for infiltration, keeping runoff out of the street and giving the appearance to the land that the building is not there, the Low-Impact Approach.

Studies (May, 1997; Schueler, 1995; Schueler, 1994) have shown that as impermeable surfaces increase, replacing permeable surfaces, water quality decreases and impacts on aquatic flora and fauna increase, even with as small as 5-10% increase of impermeable over permeable.

Many studies have documented the health risks and dangers to beach-users and aquatic habitats and life from urban runoff. The Southern California Coastal Water Research Project, a leading marine research group in Southern California, reported that storm water and urban runoff are the leading source of water pollution in the Los Angeles area (Cone, 2000); storm water pollution has increased 200-700 percent during the last 20 years. Stormwater has become a lethal cocktail of pollutants that now constitutes the single greatest source of water pollutants, contributing 50-60 percent of the pollutant load. According to the US EPA, urban stormwater is the largest source of water quality damage in estuaries, the second largest for wetlands degradation, third largest impairment of lakes and fourth largest source of river damage (Mehta,

2002; Sheppard, 2000; Coastal Alliance, 2000; Los Angeles County, 2000; American Oceans Campaign, 2000). An epidemiological study (Haile, 1996) showed that people who recreate near flowing storm drains are much more likely to contract intestinal, ear, and nose illnesses. In light of numerous studies mentioned above and with the passage of stricter regulations for urban runoff discharges, the City leadership believes that all dry weather and some initial wet weather runoff leaving the City should receive some treatment to remove pollutants of concern before entering the local receiving water body, the Santa Monica Bay. To achieve this goal, the City has installed BMPs in many of its storm drain outlets and in catch basins within the storm drainage system. The City has every expectation to have BMPs in all storm drain outlets in the near future.

The purpose of this paper is to describe the City's urban runoff management program and some examples of BMPs that have been implemented to reduce problems associated with urban runoff, namely water quality and quantity issues. The City's program integrates the resources of many departments to comply with urban runoff regulations and the City's Sustainable City Program. Instead of disconnecting staff, the program seeks to connect personnel and goals to achieve success. The program is a hands-on, proactive and watershed approach in which solutions seek to mimic nature, not disrupt it. Ultimately, the program seeks to convert a perceived waste into a valuable resource and at the same time keep pollutants out of the Bay.

### ***Santa Monica***

Santa Monica is about 20.5 kilometers<sup>2</sup> (8.1 miles<sup>2</sup>) in size with a residential population about 90,000. The daytime population increases by more than double. The City is surrounded by the Pacific Ocean (Santa Monica Bay) on the west, Santa Monica Mountains to the north, and cities of Los Angeles and Venice to the east and south. Attractive beaches and the Santa Monica Pier, pleasant year-round climate and proximity to attractions in Southern California make Santa Monica a popular destination. The City is completely built out.

The City's urban runoff management program is strongly supported by a City Council and management concerned about environmental stewardship and responsibility. To this end, the City enacted a Sustainable City Program (Santa Monica, 1994) to promote sustainable practices, including the reduction of pollution found in urban runoff. The Council has a history of political activism for environmental protection, which is critical to a City that depends upon a healthy Bay to support a healthy economy.

Due to recent media reports about the dangers of urban runoff and impacts to beach-goers and aquatic life, the City responded quickly and implemented many changes in how the City does business on a daily basis. The rest of this paper describes the many programs to improve urban runoff quality and reduce runoff quantity.

### **Source Control & Prevention**

The best solution to pollution found in urban runoff is to prevent pollutants from coming in contact with urban runoff, whether dry weather runoff or storm runoff. The pollutants of concern are familiar to us: petroleum products from vehicular use, heavy metals from vehicle brakes, organic chemicals and fertilizers (nutrients) from lawn care use, overwatering of landscapes, broken irrigation systems, sediments from exposed land, detergents from cleaning hardscapes, and pathogens from pets, wild animals and transients.

### ***Education***

The City has printed materials that are distributed to residents and businesses, explaining the problems associated with urban runoff and suggested solutions. People can obtain these materials from City offices,



at community events, through the mail, at City-sponsored presentations, or from the City's web site. The City also collaborates with other municipalities and regional groups to disseminate educational materials through newsprint and radio.

### ***Signage***

The City maintains signage on all City catch basins, warning people not to dump materials into basins, and providing a phone number to call in incidents of dumping. Unfortunately, a mix of materials, some hazardous, still finds its way into catch basins and storm drains. Over the years, the City has used painted stencils, ceramic tiles and thermoplastic stencils to alert people about dumping materials into the City's storm drain system.

The City also maintains signage on the Pier, warning visitors not to dump materials over the side and into the Bay, nor to feed the birds. Dumping materials over the side, such as food and fish guts, attracts birds, and birds defecate into surrounding waters, adding pathogens.

Some City parks and pet walk parks contain dispensers with bags to clean up after pets for pet-owners who forget to bring bags with them. A City ordinance requires that anyone walking a pet outdoors must have a visible means of cleaning up after the animal.

The Santa Monica Urban Runoff Recycling Facility (discussed below) has numerous educational signs to explain what urban runoff is, its causes, and solutions. The City has additional plans for signage at new installations of BMPs so that people can learn more about runoff and how to prevent pollution.

### ***Good House-Keeping Measures***

The City's Urban Runoff Pollution Mitigation (Santa Monica, 2000) ordinance requires people in existing buildings or at existing properties without new or redevelopment to take steps to prevent pollutants from coming into contact with urban runoff. For example, people should clean up any spilled household hazardous materials immediately. Lawn care chemicals should be used as per instructions and not overused, nor applied before rain. Sprinkler systems should be properly maintained; any leaks should be repaired immediately. Containers of chemicals and trash receptacles should not be left outside uncovered.

### ***Construction BMPs***

The Mitigation ordinance also requires construction sites to be well maintained. Responsible parties at a construction site must take steps to prevent pollutants from coming into contact with urban runoff, and to prevent erosion and the escape of polluted runoff and sediment from a site. As with Good House-Keeping BMPs, containers of chemicals must not be left open and exposed to the elements. Trash containers must be covered. A sediment rack must be at the entry/exit to minimize tracking sediments offsite. Mounds of dirt must be covered to prevent wind and water erosion offsite. These are some examples of BMPs to prevent pollutants from entering storm drains.



**Figure 2.** Concrete washouts are collected for disposal instead of released to the street, storm drain system and ocean.

### **Onsite Treatment**

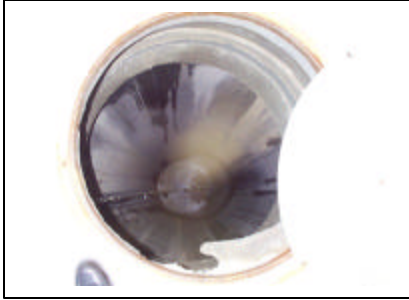
The Urban Runoff Pollution Mitigation ordinance requires new developments that exceed a specific threshold to incorporate best management practices, BMPs, such as infiltration trenches, french drains, permeable paving, biofilters and other low-impact structures into the post-construction design of a project. The design should be linked to how urban runoff will be managed onsite instead of dumping the problem into the public right-of-way. The express purpose of these low-impact development techniques is for harvesting precipitation, infiltrating it back into the ground and keeping urban runoff and its low-level pollutants out of receiving waters. Not only is water quality improved as the runoff passes through soil, but aquifers are recharged for future extraction.

### ***Private & Public Development: Infiltration Trenches, Biofilters, Permeable Paving***

A menu of BMPs is available to choose the best ones to incorporate into the design of a new building. These are post-construction BMPs to harvest, infiltrate and treat runoff. As shown in Figure 1, the goal is to design a low-impact development that minimizes the hardscapes, maximizes permeable surfaces and returns as much water as technically possible into the ground. The most common BMP for single-family developments is the infiltration trench, a sub-surface retention basin filled with large gravel, stackable plastic pallets or long concave-shaped plastic cylinders to store a certain amount of runoff for infiltration. Surface infiltration depression basins in yards also serve to retain runoff for infiltration. Biofilters and swales are other BMPs suitable for site-specific situations. Porous concrete and permeable paving products, modular and rolled, replace asphalt and concrete for parking lots, driveways and alleys.

### **Effectiveness**

To date, over 600 new developments, including single-family, multi-family, commercial and City, have implemented this requirement of post-construction BMPs, keeping over 4,540,000 liters (1,200,000 gallons) of runoff out of the Bay per 0.25 centimeters (0.10 inch) or greater storm. To put this in perspective, this amount of water, if harvested and used directly represents about 9% of daily water use. Moreover, the City contains about 22,500 parcels. About 2.5% of properties in the City have had to comply with the ordinance and install BMPs since 1995. The City recognizes that each project is site-specific and in some cases BMPs will not be possible onsite. The ordinance allows for variances.



**Figures 3, 4.** On left, cylindrical infiltration system some 20 feet deep under a subterranean garage for a multi-family building receives roof runoff during a storm and infiltrates into the ground; on right, common box-shaped, sub-surface infiltration trench at a single-family development collects roof and other hardscape runoff for infiltration.



**Figures 5, 6.** Use of plastic in-fill instead of gravel allows greater storage volume, 94% versus 40%. On left, sub-surface infiltration trench filled with *RainStore*; on right, trench filled with *StormCell*.



**Figure 7, 8.** On left, biofilter/swale system in parking lot of a school receives all runoff. For almost all storms, all runoff remains onsite for infiltration. On right, permeable pavers in a parking lot of a business allows runoff to infiltrate instead of run off into the street.



**Figures 9, 10.** On left and right, before and after photos of *Grassy Pavers* permeable pavers at a multi-family building in the parking stalls. Left photo shows pavers exposed before infill. Right photo shows pavers filled with colored rock.



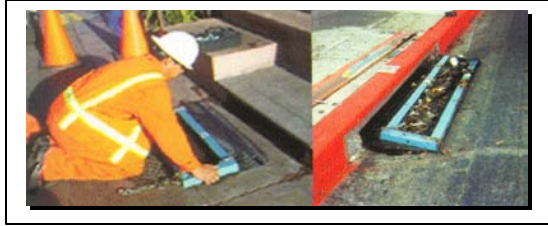
**Figure 11.** Porous concrete V-swale in a City alley to harvest runoff and reduce flooding of adjacent properties.

### ***Public Surface Systems***

As mentioned earlier, City leadership believes that all dry weather and some initial wet weather runoff leaving the City should receive some treatment to remove pollutants of concern before entering the local receiving water body, the Santa Monica Bay. The City continues to install BMPs in its storm drain system. The City has every expectation to have BMPs in all storm drain outlets in the near future.

### **Catch Basin Inserts**

The newest generation of basin and storm drain BMPs, inserts and screens, avoid many of the pitfalls of the earlier efforts—pieces of wood over the openings of catch basins. Water can pass into the catch basin, trash can be removed, and high flows still bypass into the basin, avoiding flooding. Many insert types are on the market. Some filter only trash and debris; some filter both trash and soluble chemicals via a special filtering medium. The City uses both types of strategies. The City places inserts for trash and debris in areas of high pedestrian traffic, such as the downtown Promenade area. Inserts that filter hydrocarbons, in addition to trash, are placed along streets with automotive businesses.



**Figures 12, 13.** A catch basin insert, *DrainPac*, captures trash and debris, preventing these materials from entering the receiving waters.

### **Catch Basin Screens**

With inserts, City staff must clean them out on a regular basis to maintain the removal efficiency of the BMP, a time-consuming and costly requirement, especially in confined spaces. With screens attached to the curbside, trash and debris are kept out of the runoff, water can pass into the basin or drain, and street sweepers or City staff can remove easily these materials. However, if not properly installed, vehicles can brush against screens and damage both screens and vehicles. And in some installations, flooding might be an issue if the screens are covered with trash or in a flood-prone location.



**Figure 14.** Catch basin screen operating during storm. Water can flow through the openings while keeping trash out.

The City has found inserts and screens to be effective when the best device is chosen for a site, installed properly and maintained regularly. Many other types of BMPs that fit into catch basins and storm drains exist. More information about these BMPs, and those used by the City, is available from the author.

### ***Public In-Line Systems***

The City installed a number of these BMP devices as off-line centralized treatment systems. The advantage of centralized BMPs is that all the collection of pollutants and maintenance occurs in one location, instead of City crews driving to hundreds of locations to clean BMPs. Time and money spent for maintenance are reduced. To date, the City has found these devices very effective in removing trash, debris, oil and grease, and solubles attached to sediments. City staff is gathering data on amounts of solid pollutants removed from catch basins, storm drains and in-line BMPs, as well as characterizing pollutant types. These devices also allow the City to pinpoint sources of some pollutants depending upon BMP locations.

Many other types of in-line BMPs that fit into storm drain systems exist. More information about these BMPs, and those reviewed by the City, is available from the author.



**Figures 15, 16.** Left, muffler and concrete pieces captured in a *CDS unit* during a rain storm. Right, trash, mostly plastics, removed by the same *CDS unit* (Continuous Deflective Separation). This *CDS unit* receives runoff from the City's highly congested downtown area, rich in pedestrians, visitors, trendy shops and restaurants, and the weekly Farmer's Market.

### **Santa Monica Urban Runoff Recycling Facility (SMURRF)**

The SMURRF is a first-of-its-kind facility that harvests on an annual basis dry weather urban runoff (93% of the City's total runoff) from the City's two main storm drain lines, treats the runoff through five systems, and reuses the new water resource for landscape irrigation and indoor toilet flushing. Santa Monica has become a leader in its efforts to safeguard and enhance the natural environmental and the community's health through innovative programs and policies.

What is truly revolutionary about the SMURRF is that not only does it represent an innovative 'wastewater' (not really wastewater) treatment facility, but it also represents a critical shift in philosophy and management of a natural resource. The traditional perspective is to dispose of a waste product "out of site, out of mind." In the case of urban runoff, the City has chosen a watershed perspective, transforming a waste product--urban runoff--into a valuable local natural resource.



**Figure 17.** The Santa Monica Urban Runoff Recycling Facility.

This project is an outstanding example of how the City effectively integrated art, engineering, and education to develop a project that is embraced by the public. This project safeguards and enhances water resources, prevents harm to the natural environment and human health, and enhances the community and local economy for the sake of current and future generations. The SMURRF is also an example of how cities work together to solve a shared problem. In this case, Santa Monica and Los Angeles are partners in this project. Some 1.1 million liters (300,000 gallons, almost 1 acre-foot) per day of dry weather runoff are being diverted from the ocean, treated to a high level and reused, or treated and returned to the ocean, removing a pollution source, especially pathogens.

## ***SMURRF Project Goals***

The primary objective of the SMURRF, which began operations in February 2001, is to dramatically reduce, if not eliminate, dry weather urban runoff pollution into Santa Monica Bay. To date, this goal is being met. Secondary project goals include raising public awareness about problems and solutions of urban runoff pollution through educational exhibits at the facility and combining strong artistic and architectural elements into a highly functional design. These goals have also been met through regular tours for interested visitors, from around the world: tourists, engineers, government officials, students and residents.

In addition, and no less important than any other secondary goal, the development of an additional water source for use throughout the City is critical. If the City has to treat urban runoff anyway to meet stricter regulations, why dump the treated effluent into the Bay? Is there not an advantage to reusing the treated local water resource and reduce imported water supplies? Every acre-foot of water recycled through the facility equates to one less acre-foot of potable water that must be imported from Northern California and the Colorado River. In doing so, the SMURRF benefits the entire region as well as Santa Monica.

## ***Water Quality Challenges of Dry Weather Flow***

Dry weather runoff captured by the SMURRF originates in a 153 kilometers<sup>2</sup> (4,200-acre) drainage area in the cities of Santa Monica and Los Angeles. Sources of dry weather runoff arise from the inefficient use of potable water by people: over-irrigation, broken irrigation systems, washing of paved surfaces and business equipment, car washing on hard surfaces, pool draining, leaking water pipes and hydrants, and illegal dumping. The average daily flow is estimated to be 1.1 million liters (300,000 gallons) per day, which represents slightly more than two percent of Santa Monica's overall water demand of 49 million liters (13 million gallons) per day. The facility has a capacity of 1.9 million liters (500,000 gallons) per day. A variety of pernicious contaminants are found in urban runoff. The presence and concentration of these contaminants appear to vary significantly over time. Contaminants found in the dry weather runoff treated by the SMURRF include:

- Suspended and Dissolved Solids
- Oil and Grease
- Trash and other debris
- Pathogens
- Heavy metals (lead, copper, zinc, and chromium)

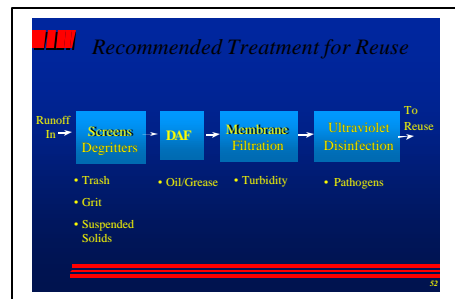
Initial laboratory tests of influent and effluent SMURRF water samples confirm significant reductions of these pollutants when found at elevated levels in influent.

## ***Demand Challenges for Recycled Water***

The two most likely uses for recycled urban runoff are landscape irrigation and toilet flushing in dual-plumbed buildings. To date, recycled water is being used for irrigation at the City's cemetery and two parks, and along a section of the Santa Monica Freeway within City boundaries. Additional users for indoor flushing will come online over the next few months at a major commercial development and next few years at the City's new Public Safety Facility next to City Hall and an international consulting firm.

## ***Treatment Challenges of Urban Runoff***

The five-stage treatment train at the SMURRF consists of bar screens, flow equalization, air floatation, microfiltration, and UV disinfection. Because the SMURRF is a new system, combining proven technologies to treat a new water resource presents challenges. Pre-treatment is critical to remove solids and sediments that can foul secondary and tertiary treatment systems. Daily maintenance is required. Oil and grease need to be monitored to avoid high concentrations (from spills) from entering the facility and exceeding the system's parameters. The microfiltration system requires special monitoring to ensure proper operation and long-term durability and reliability. A major challenge is the control of algae, which is very common in urban runoff. Initial designs required the injection of a background level of chlorine within the distribution line. However, the City has found that algae grows almost everywhere within the facility, especially in the finished reservoir. Weekly cleaning is required to prevent the buildup of algae. The City is considering adding chlorine earlier in the treatment train to reduce algal growth.



**Figure 18.** Diagram of SMURRF treatment train.

## ***Challenges of Public Education and Artistic Allure***

Placing a treatment facility near a prominent tourist site, the Santa Monica Pier and attractive sandy beaches, presented many challenges. The City took extraordinary steps to include educational, artist and architectural features, bringing drama to signage, landscape, and architecture; presenting educational material in a fresh fashion; and providing talking points for visitors. These features are key elements of a public information campaign that stresses the future importance of stormwater and wastewater recycling as a local water resource.

Because the SMURRF is open continuously, other types of challenges occur, the types of social challenges presented by youth and those without shelter. The City has had to balance the openness and unmonitored design of the SMURRF against the need for operational continuity and system security. During the first year of operation, City staff visit the facility daily for maintenance and damage control, in addition to its maintenance of the City's other water distribution systems: potable, waste, storm and recycled.

The daily activity of SMURRF reduces pollution into the Santa Monica Bay and provides a sustainable alternative water supply for the City of Santa Monica, with the displacement of up to four percent of potable water demand. The supply is sustainable in the sense that society is wasting hundreds of thousands of gallons a day through inefficient uses of water.

The collaborative design approach between the artist, architect, engineer, and public works department has transformed a potentially unsightly treatment facility into an important community asset. The more than 2 million visitors who come to the Santa Monica Beach and Pier each year will have an opportunity to learn about the benefits of pollution prevention and watershed protection.



The SMURRF is a reflection of the shift in how society manages all water resources. No longer is the traditional approach of removing any and all water resources from our midst acceptable. In a time of unstable, unreliable potable water supplies, water management needs to shift from the old traditional approach of over tapping existing potable supplies and think outside the box – use to the maximum extent practicable all existing and local water supplies, with an emphasis on water efficiency and conservation -- water efficient appliances and landscapes, elimination of leaks, and reuse of “waste” water supplies.

## **Funding Resources**

The City has been fortunate to have a stormwater utility fee, an annual fee incorporated into the annual property tax bill. This annual revenue source is approximately \$1.2 million. However, with the additional requirements on municipalities from regulations, such as the new NPDES permit and TMDLs, to reduce urban runoff pollution and improve water quality of receiving water bodies, this revenue source is inadequate. This fee can no longer support the anticipated future operating and capital expenses of the City’s urban runoff management program.

The City has received many federal, state and county grants, local rebates and state loan funds to implement many BMPs. A proactive staff and supportive management have allowed the City to seek out and obtain these grants. Grants cover most if not all of the construction cost of these systems. The City provides a certain level fiscal resources for planning, design, community outreach and education, and water quality monitoring. The City also works with neighboring cities to share expenses where appropriate.

## **Urban Runoff Management Plan**

The City recently began a major effort to codify into an urban runoff management plan its dispersed runoff management program, bringing together the activities of the City’s many divisions involved in urban runoff management. To date, the City has a variety of activities to curb runoff pollution and meet the requirements of its Phase I National Pollutant Discharge Elimination System permit, through the County of Los Angeles. Almost all City divisions participate in runoff management, from legal to planning to engineering to open spaces to enforcement. Since 1990, the City has operated its program without a formalized document, a repository of all requirements, whether regulatory and City policy, a document that anyone can review, share and update—a living, dynamic document. Without such a document, City finds it difficult to present a unified and centralized approach. When other government agencies contact the City for a copy of our plan, we do not have one document to present. Though the City has many clear objectives and policies, and a Sustainable City Program, for urban runoff, the City has been lacking in a written plan.

Beginning in November 2002, the City will work with a consultant to begin a year-long process to develop this document, incorporating the latest hydrologic and hydraulic data about the City’s storm drain system, GIS information and maps, regulatory requirements, and low-impact design solutions. The unique aspect of this plan is its low-impact approach, seeking watershed solutions upstream for any storm drain system deficiencies, soft and permeable BMPs instead of traditional hardscapes solutions. Wherever possible, to upgrade the storm drain system, low-impact design BMPs are preferred and requested, or the installation of treat and release systems to give a minimum of treatment to meet new standards. The plan’s approach is to treat runoff as the valuable local resource it truly is, and not as a waste product to be easily discarded.

## **Conclusion**

The City’s Urban Runoff Management Program has two goals: treat runoff to the highest possible standards, given economic and regulatory realities, and release; and treat runoff and reuse it as a valuable

resource. These goals have three implementation and guiding strategies within the management plan: treat all dry weather and initial wet weather runoff before leaving the City's boundaries; harvest wet weather flows for groundwater recharge; and harvest, treat and reuse dry weather runoff for landscape and in-door plumbing purposes. These goals and strategies make up the new Urban Runoff Management Plan. What makes this plan unique is the toolbox of human, technical and fiscal resources that the City employs to reach these goals and strategies: numerous divisions working together to meet regulatory requirements; a supportive City Council and management with a Sustainable City Program with guiding principles; City employees who are trained and believe in the goals and strategies; a stormwater user fee; grants; and tested and effective technologies.

SMURRF is the centerpiece of the City's integrated urban runoff management program, being the linchpin of the City's commitment to protecting the Bay's water quality, wildlife and beachgoers, and an important best management practice for the Santa Monica Sustainable City Program. Not only can urban runoff be treated and released back into the environment, the SMURRF demonstrates the feasibility of taking a local polluted resource, urban runoff, and turning it into a valuable natural resource for reuse, helping to displace the need for more expensive and energy-intensive imported water. This BMP and those BMPs installed by new development to harvest stormwater for infiltration establish a precedence for exhausting efforts to first reuse local water resources of various qualities before turning to distant water resources, the removal of which may cause significant ecological damage and water supply disruption to distant aquatic habitats and cities. These BMPs also keep potential pollutants of concern out of surface waters, improving water quality for beneficial uses and protection of wildlife and human visitors to the ocean.

## References

- American Oceans Campaign, 2000. About Stormwater and Polluted Runoff, [www.americanococeans.org](http://www.americanococeans.org).
- Coastal Alliance, 2000. Pointless Pollution: Preventing Polluted Runoff and Protecting America's Coasts, Washington, DC.
- Cone, Marla, 2000. Study Finds Widespread Runoff Peril on the Coast, Los Angeles Times, November 29.
- Los Angeles County, 2000. Reducing the Health Risks of Swimming at Los Angeles County Beaches, 1999-2000 Grand Jury Final Report, 192-246.
- Haile, R.W., Alamillo, J., Barrett, K., Cressey, R., Dermond, J., Ervin, C., Glasser, A., Harawa, N., Harmon, P., Harper, J., McGee, C., Millikan, R.C., Nides, M., and J.S. Witte, 1996. An Epidemiological Study of Possible Adverse Health Effects of Swimming in Santa Monica Bay, Final Report, Santa Monica Bay Restoration Project, Los Angeles.
- May, C.W., Horner, R.R., Karr, J.R., Mar, B.W., and E.B. Welch, 1997. Effects of Urbanization on Small Streams in the Puget Sound Lowland Ecoregion, Watershed Protection Techniques, 2:483-494, Center for Watershed Protection, Maryland.
- Mehta, S., 2002. State OKs Tough New Regulations to Reduce Runoff, Los Angeles Times, January 19.
- Santa Monica, City of, 2000. Urban Runoff Mitigation Ordinance, Chapter 7.10 of the Santa Monica Municipal Code, #1992, November 28.

Santa Monica, City of, 1994. Sustainable City Program adopted by City Council, September 24.

Schueler, T. and R. Claytor, 1995. Impervious Cover as an Urban Stream Indicator and a Watershed Management Tool, Effects of Water Development and Management on Aquatic Ecosystems, ASCE, New York.

Schueler, T., 1994. The Importance of Imperviousness, Watershed Protection Techniques, 1(3), Center for Watershed Protection, Maryland.

Sheppard, H., 2000. Testing the Waters: Health of region's shores threatened by urban runoff, Daily News, Los Angeles, May 17.

# **A PROCESS FOR DETERMINING APPROPRIATE IMPACT INDICATORS FOR WATERSHED PROJECTS**

Robin Shepard  
Wisconsin Water Quality Coordinator  
University of Wisconsin, Madison, WI;  
Catherine Neiswender  
Great Lakes Regional Water Quality Liaison; and  
on behalf of Cooperative Extension's  
Great Lakes Regional Water Quality Leadership Team\*

## **Abstract**

Watershed project evaluation, especially in urban-focused efforts, typically focuses on water quality improvements, habitat expansion or improvement, and a variety of other positive changes in the physical and biochemical realms. However, watershed projects are ultimately about influencing human behaviors and changing how people interact with the natural resources in the watershed. By including both physical and social indicators of change, a more holistic approach to watershed project evaluation can emerge. A Logic Model for Program Performance was used in group discussions by State Nonpoint Source Pollution (Section 319 Project) Coordinators from the Great Lakes Region to identify a set of common impact indicators for assessing Section 319 projects. These multi-state discussions confirmed the lack of focus on the behavioral and socio-economic components of water quality efforts. Results of these and ongoing discussions will establish a set of impacts that can be used both to develop state and regional reporting procedures and to create a training program for Section 319 project staff.

## **Introduction**

Increased pressures from politicians and agency personnel through program reviews and audits, as well as the federal enactment of the Government Performance and Results Act (GPRA) in 1993, are examples of the ever-expanding focus on program results and impacts. As the demand for accountability in natural resources programming increases, so too will the need for thoughtful, well-planned program evaluations (Davenport, 2002).

Evaluation is a critical dimension of any watershed project. It is most often used in summative or conclusive ways to identify what was accomplished by a project after a specified period of time. But, evaluation can also be a formative element in program planning and implementation, to ensure that projects within those programs are meeting short- and long-term goals. Building evaluation skills and developing the confidence to use those skills is critical for watershed-based staff if they are to answer questions about the effectiveness and efficiency of their programs. While it may not be necessary for educators to become evaluation experts, they do need a fundamental understanding of methods and ethical standards if they are to make evaluation part of overall program design.

Evaluation is the systematic collection of information about the activities, characteristics, and outcomes of programs, personnel, and products, in order to reduce uncertainties, improve effectiveness, and make decisions with regard to what those programs or products are doing and affecting (Patton, 1982). While evaluation includes a look at program impacts, it is different from impact reporting, which focuses on

specific program results that may only be important to program stakeholders (Patton, 1997; Bickman, 1985; and Cronbach, 1982) Evaluation measures a variety of outcome data against the program's intent (Bennett and Rockwell, 1995).

## **Approach**

To improve how evaluation is used in watershed projects, six land grant universities in the Great Lakes region (i.e., Illinois, Indiana, Michigan, Minnesota, Ohio and Wisconsin) are working with state and regional coordinators from nonpoint source pollution projects (Section 319). This multi-state effort, which includes participation by the U.S. Environmental Protection Agency Region V office, has been initiated to identify consistent and reliable impact indicators and evaluation processes. A series of small group discussions and interactive training sessions on evaluation is currently being offered to state-level 319 coordinators. Those meetings and interactions will encourage cross-state problem solving and lead to the development of common success indicators for watershed projects.

## **Discussion**

Typically, evaluation is not addressed until late in, or even at the end of, a project. This reactive evaluation is often merely a hunt for positive impacts, and has limited value in either describing the success of a program or in planning future efforts. A more planned, formative evaluation that is integrated into the project from the very beginning can track changes over time.

Formative evaluation (Scriven, 1967) examines issues such as audience needs, current knowledge gaps, prevalent behaviors, and information preferences. Because they are assessed prior to a project's start, these issues can be used to influence the design and implementation of the outreach efforts (King & Rollins, 1999; Lanyon, 1994; Mattocks & Steele, 1994). One barrier associated with formative evaluation approaches is deciding what to measure.

Water quality projects are by nature directed at protecting or improving physical water quality. Biophysical changes to the water are normally the measure of success (Davenport, 2002). While the ultimate goal of water quality projects may be to protect or enhance water quality, there are other impacts to assess, such as increased knowledge, improved skills or the adoption of improved management practices (Rogers, 1995). Research has shown certain management practices to be beneficial to water quality and farm profits, and the promotion of these practices by project staff is at the heart of most water quality outreach efforts. Therefore, both long-term indicators (i.e., physical changes to water quality) and more immediate impacts (i.e., changes in farm management and behavior) were assessed in this study to determine the level and type of evaluation support needed by and from state water quality coordinators.

In prior internal assessments of evaluation processes (Shepard, 2002) used by water quality program staff, only three (10 percent) of the states actually conducted a formative assessment strategy for their project. This involved documenting pre-project needs and audience characteristics specifically for USDA Water Quality program efforts pertaining to the Cooperative State Research Education and Extension Service (CSREES) Water Quality Initiative of the 1990s. When individual project coordinators were asked what information they intended to use to determine program impact, they mentioned a range of indicators, from biophysical environmental (e.g., sediment loading, biotic indexes, etc.) to behavioral (e.g., awareness, knowledge or adoption of practices). When a range of potential indicators was assessed for intended use, it was shown that many states intend to rely on such indicators without any true baseline from which change can be adequately assessed (Figure 1).

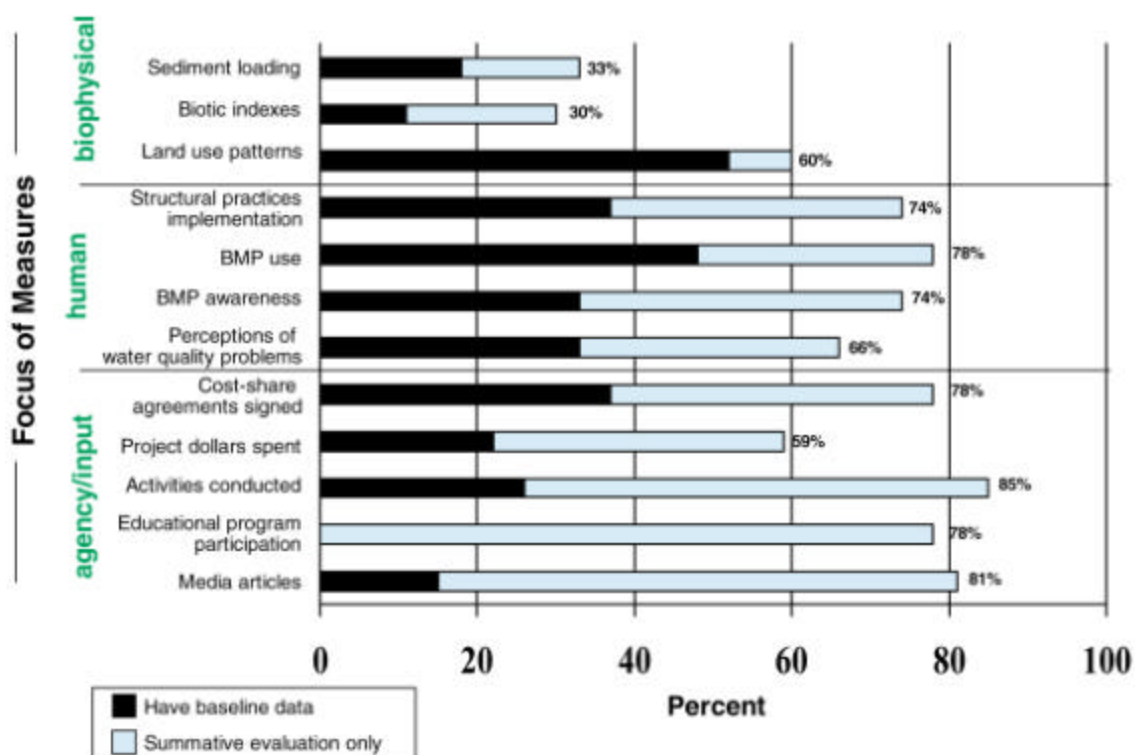


Figure 1. Evaluation Measures Used by CSREES Water Quality Coordinators.

## Presentation Focus

This presentation will summarize results from the Section 319 Project Coordinators’ group discussions about evaluation and the proposed training program (suggested in the Approach Section above). Results will offer ideas from state and regional project staff as to: 1) the purposes for evaluation, 2) suggested processes and methods, and 3) recommendations for strengthening watershed evaluations. As watershed-based efforts come under more scrutiny, watershed program administrators and funders need to know how to evaluate the success of these efforts. Results from this project are planned to be implemented in 319-funded and other watershed projects by 2004.

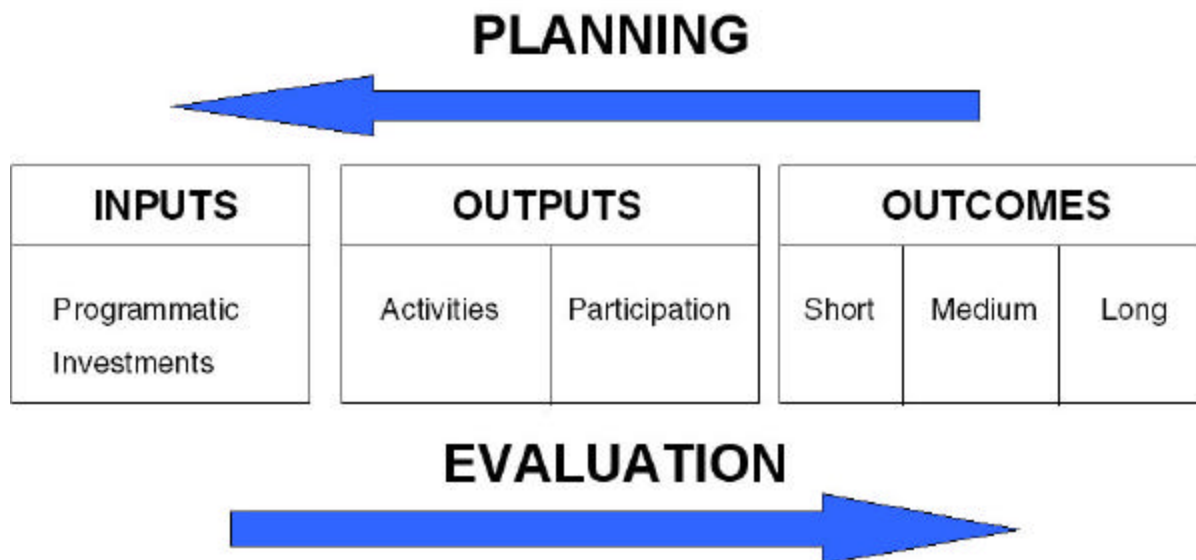
## An Overview of Results

In fall 2002, an interactive process began with a small group discussion of State Nonpoint Source Pollution (Section 319 Project) Coordinators from Illinois, Michigan, Ohio, Indiana and Minnesota. That meeting on October 23-24 was subsequently followed with a series of email discussions among the state coordinator in order to share ideas about what can and should be the basis of project-level reporting and evaluation.

As a starting point for the exchange of ideas on reporting, the October meeting focused on using the Logic Model for Program Performance as a framework to identify the potential range of program and project impacts. Over the next several months, the ideas generated by that meeting will continue to be discussed and further refined with the intent of developing set of primary program and project-level impacts that can be tracked over time and reported through the existing regional network of Section 319 projects. Again, this paper is a progress report on the development of common indicators for Section 319 projects, and is meant

to foster broader discussion through its presentation. The information and data presented here are preliminary and will continue to be refined as a training program is developed in 2003.

To guide the discussion pertaining to what is currently, and what can be, evaluated, the Logic Model for Program Evaluation was used (Figure 2). The Logic Model has been used in a number of disciplines to help identify three levels of programmatic impact referred to as: (1) input, (2) outputs and (3) outcomes.



**Figure 2. The Logic Model for Program Evaluation** (Taylor-Powell, 1998).

Inputs are a category of program investment that includes staff time and dollars invested to conduct the program or project. Outputs refer to those actions that are immediately caused or supported by the initial inputs. Outputs include watershed activities and events. Outputs also can include the initial participation in such activities, like the number of farmers attending a demonstration or field day. Outcomes are those impacts that result from the activities and events of the project. Outcomes are commonly divided into short-, medium- and long-term impacts. Short-term outcomes could include changes in knowledge or the acquisition of specific skills introduced at a demonstration or field day. Medium-range outcomes would include the application of skills or behaviors such as the adoption of improved management practices that were demonstrated by the project. And long-term indicators are most often considered to be actual changes to the environment, such as biophysical improvements in water quality. The Logic Model has relevance to both program planning and program evaluation. If programs/projects begin by identifying the outcomes they are hoping to achieve (top arrow), they will plan the program/project from right to left. As the program/project is implemented, it actually unfolds from left to right (bottom arrow).

In discussions with states in USEPA Region V (during the October 23-24 meeting), the Logic Model was used to help identify the three categories of inputs as they pertain to the Section 319/watershed projects (Figure 3). States and EPA Regional Staff readily identified inputs and outputs, but short- and medium-range outcomes were more problematic.

## PLANNING



INPUTS	OUTPUTS		OUTCOMES		
base funds amount of funds to sub-state recipients number of state employees	<b>Activities:</b> TMDL identification	<b>Participation:</b> bmp related activities	<b>Short:</b> bmp adoption rates	<b>Medium:</b> stream bank/shoreline restoration (miles)	<b>Long:</b> NPS pollutant reductions load reductions

## EVALUATION



**Figure 3. The Logic Model as Built by USEPA Region V Staff** (adapted from Taylor-Powell, 1998).

Results from this process have focused much attention on the lack of behavioral and socio-economic indicators in the short- and medium-outcome categories. This finding has not been totally unexpected, given the biophysical orientation of technically trained watershed staff and the emphasis placed on biological and chemical changes to water quality parameters. Few would disagree that water quality programs are primarily about changing or protecting water quality - the natural resource itself. However, concern over the extent of biophysical change that is possible, and the time it takes for those biophysical indicators to change, may be well beyond the political life of a watershed or water quality project. This means our staff and programmatic resources are often focused on five-to-ten year windows of time, while the biophysical indicators may take many more years to show change. Therefore, if biophysical changes in water resources do indeed take much longer than the life of a particular program, then social indicators of change (i.e., short- and medium-range indicators like practice adoption) may be more useful and obtainable as measures of success in the lifespan of the watershed project. Social indicators, in this context, are not considered exclusive, but rather are valuable complements to long-term biophysical outcomes. Watershed projects are about changing the way resources are managed and cared for. After all, human behavior and interactions with the resource may in fact be the true focus of many environmental protection programs, and social science indicators should be given more attention and not merely written off as "soft" or too difficult to measure adequately.

### Future Implications

During winter 2002-03, email and conference calls will be used to further complete the Logic Model(s) for each of the Region V states. The goal of this process is to (1) better define a set of impact indicators that can be built in to state and regional reporting procedures; and (2) identify a training and professional development program for Section 319 projects that will help build local/watershed capacity that will support



and conduct program evaluation. At this time it is premature to identify the exact curriculum and format for this training and professional development, however, those concepts are expected to be developed by February 2003.

## References

Bennett, C. and K. Rockwell, 1995. Targeting Outcomes of Programs (TOP), an Integrated Approach to Planning and Evaluation. (A program planning guide prepared for USDA employees.) Washington, D.C.: Cooperative State Research, Education and Extension Service.

Bickman, L., 1985. Improving Established Statewide Programs: A Component Theory of Evaluation. *Evaluation Review*, 9(2),189-208.

Cronbach, L.J., 1982. *Designing Evaluation of Educational and Social Programs*. San Francisco: Jossey-Bass.

Davenport, T.E., 2002. *The Watershed Project Management Guide*. Lewis Publishers: New York.

King, R. and T. Rollins, 1999. An Evaluation of Agricultural Innovation: Justification for Participatory Assistance. *Journal of Extension*, 37(4).

Lanyon, L.E., 1994. Participatory Assistance: An Alternative to Transfer of Technology for Promoting Change on Farms. *American Journal of Alternative Agriculture*, 9(3), 136-142.

Mattocks, D. and R. Steele, 1994. NGO-Government Paradigms in Agricultural Development: A Relationship of Competition or Collaboration? *Journal of International Agriculture and Extension Education*, 1(1), 54-61.

Patton, M., 1997. *Utilization-focused Evaluation*. Thousand Oaks, California: Sage. p.20 and p.200.

Patton, M., 1982. *Practical Evaluation*. Sage: Newbury Park, California.

Rogers, E.M., 1995. *The Diffusion of Innovations*. (4<sup>th</sup> ed.). Free Press: New York, NY.

Scriven, M., 1967. The Methodology of Evaluation. In Tyler, R.W., Gagne, R.M. and M. Scriven (Eds.), *Perspectives of Curriculum Evaluation* (pp. 39-83). Rand McNally: Chicago, Illinois.

Shepard, R., 2002. Evaluating Extension-based Water Resource Outreach Programs: Are We Meeting the Challenge? *Journal of Extension*, 40(1). Accessible at [<http://www.joe.org/joe/2002february/a3.html>].

Taylor-Powell, E., 1998. *The Logic Model: A Program Performance Framework*. Cooperative State Research Education and Extension Service and University of Wisconsin-Extension: Madison, Wisconsin. Accessible at [<http://www.uwex.edu/ces/pdande/>].

\* The Great Lakes Regional Water Quality Leadership Project is a collaborative effort among CSREES land grant universities. Team members include: Jim Anderson (Minnesota), Jon Bartholic (Michigan), Joe Bonnel (Ohio), Jane Frankenberger (Indiana), Mike Hirschi (Illinois), Ruth Kline-Robach (Michigan), Lois Wolfson (Michigan) and Robin Shepard (Wisconsin). The Great Lakes Regional Water Quality Liaison is Catherine Neiswender (Wisconsin).

# DUAL FUNCTION GROWTH MEDIUM AND STRUCTURAL SOIL FOR USE AS POROUS PAVEMENT

John J. Sloan and Mary Ann Hegemann  
Texas Agricultural Experiment Station  
Dallas, Texas

## Abstract

Porous grass-covered parking surfaces can reduce the quantity of urban storm water runoff and filter out potentially harmful chemicals. The objective of this study was to develop porous structural soils that promoted and sustained healthy turfgrass growth and also reduced the effects of contaminated pavement runoff. The basic medium for all soils was a 50:50 mixture of expanded shale and sand. The expanded shale component consisted of: 1) a large diameter particle (3 to 6 mm), 2) a small diameter particle (1 to 3 mm), or 3) a 50:50 mixture of the two. The basic blends were mixed with 0, 10, and 20% peat moss (v/v) and 0, 10, and 20% zeolites (v/v) and placed in 15-cm pots in a greenhouse. Bermudagrass plugs were planted in each pot. Grass growth was evaluated to determine which mixtures promoted establishment of vigorous turf. When added alone to the sand/expanded shale medium, peat moss increased bermudagrass growth and also improved plant response to added fertilizer, but the effect diminished in the absence of regular fertilization. Zeolites had no significant effect on plant growth in the absence of peat moss. Growing mediums that contained both 10-20% peat moss and 10-20% zeolites consistently produced more bermudagrass biomass than the unamended sand/expanded shale mixture. Changing the ratio of small to large diameter expanded shale in the basic medium did not affect bermudagrass yield. Very low amounts of Cd, Cu, Pb, and Zn were recovered in leachate after the addition of 10 mg metal per pot, suggesting that most heavy metals (>99%) were retained in the growing medium.

## Introduction

Urban areas are increasingly covered by impermeable parking surfaces that contribute to greater quantities and intensities of storm water runoff with elevated concentrations of particulates, heavy metals, and organic chemicals (Barrett et al., 1998; Harrison and Wilson, 1985; Morrison et al., 1984; Stotz, 1987). For example, the Elm Fork Branch of the Trinity River, which passes through the Dallas metroplex, was included in the Texas 1998 Clean Water Act list of impaired water bodies due to elevated concentrations of dissolved lead. Paved and rooftop surfaces also contribute to an increasing trend in nighttime surface temperatures (Gaffen and Ross, 1999). Data from the Urban Heat Island Pilot Project, a joint USEPA/NASA venture, showed that surface temperatures of paved surfaces and rooftops was much higher than the air temperature (111°F vs. 85°F), whereas vegetated areas had lower surface temperatures (83°F) (Johnson, 1999; Lo et al., 1997).

Urban water quality could be improved by increasing the amount of vegetated surfaces within the urban limits. Use of strategically positioned grass-covered permeable surfaces for intermittent parking would decrease the amount of impermeable surfaces in the urban environment and potentially decrease the quantity and pollutant load of runoff water. When runoff water from impermeable pavement passes over a permeable surface, the concentration of pollutants is reduced (Legret et al., 1996; Pratt, 1989; Stotz and Krauth, 1994). Use of grass-covered permeable surfaces for intermittent parking would decrease the amount of impermeable surfaces in the urban environment and decrease the quantity and pollutant load of

runoff water (Barrett et al., 1998). In addition to improving runoff water quality, vegetated surface will help reduce urban heat buildup (Johnson, 1999; Lo et al., 1997).

The objective of our study was to evaluate combinations of expanded shale, sand, peat moss and zeolites as growing mediums for turfgrass. We also evaluated the ability of each mixture to remove heavy metals and phosphorus from contaminated runoff water.

## Materials and Methods

### *Porous Pavement Mixes*

Table 1 shows the ingredients in each of the nine porous pavement mixes evaluated in this study. The major component of each mix (60 to 100% by volume) was a base blend that contained 50% greens-grade sand plus 50% of an equal portion of small (1 to 3 mm) and large (3 to 6 mm) diameter expanded shale (Fig. 1A). The greens-grade sand met the specifications for construction of a U.S. Golf Association putting green, containing mostly medium to coarse grained sand (0.25 to 1.0 mm). Expanded shale is a light-weight porous aggregate made by heating crushed shale to >1200 C. For seven of the nine porous pavement mixes, small and large diameter expanded shale were mixed in ratios of 1:1. The eighth and ninth porous pavement mixes were included in the study to determine the effect of expanded shale particle size on the porous pavement mixes. The eighth base blend was a 50:50 mixture of sand plus small diameter (1 to 3 mm) expanded shale, whereas the ninth was a 50:50 mixture of sand and large diameter (3 to 6 mm) expanded shale.

Table 1. List of ingredients in the base blend of each porous pavement mixture plus the content of peat moss and zeolites added to each base blend.

Mix No.	Base Blend	Peat Moss	Zeolites
1	50/50 Small/Large diameter shale + 50% Sand	0	0
2	50/50 Small/Large diameter shale + 50% Sand	10	0
3	50/50 Small/Large diameter shale + 50% Sand	20	0
4	50/50 Small/Large diameter shale + 50% Sand	0	10
5	50/50 Small/Large diameter shale + 50% Sand	0	20
6	50/50 Small/Large diameter shale + 50% Sand	10	10
7	50/50 Small/Large diameter shale + 50% Sand	20	20
8	50% 100LS + 50% Sand	10	10
9	50% 100SS + 50% Sand	10	10

Sphagnum peat moss is partially decomposed sphagnum moss harvested from peat bogs found mostly in Canada. Peat moss was added to the porous pavement mixes to improve water holding capacity and to provide a source of organic matter for promoting biological activity. Sphagnum peat moss was added to some of the base blends at rates of 0, 10, and 20% by volume.

Natural zeolites are aluminosilicate minerals with a unique interconnecting crystal lattice structure that gives them a large internal surface area and a very high cation exchange capacity. We added zeolites from New Mexico to the porous pavement blends for two reasons. First, we thought they would help retain fertilizer nutrients in the porous pavement mixtures so that the mixes would need less frequent fertilization. Second,

we thought zeolites would absorb heavy metals from contaminated urban runoff water as it percolated through the porous pavement. Zeolites were added to the base blends at rates of 0, 10, and 20% by volume.

The various porous pavement mixes were chosen so that we could test the effect of peat moss and zeolites alone or in combination with each other. Mixes 2 and 3 showed the effects of peat moss, mixes 4 and 5 the effects of zeolites, and mixes 6 and 7 the effects of the combined ingredients. A comparison of mixes 8 and 9 showed the effect of expanded shale particle size.

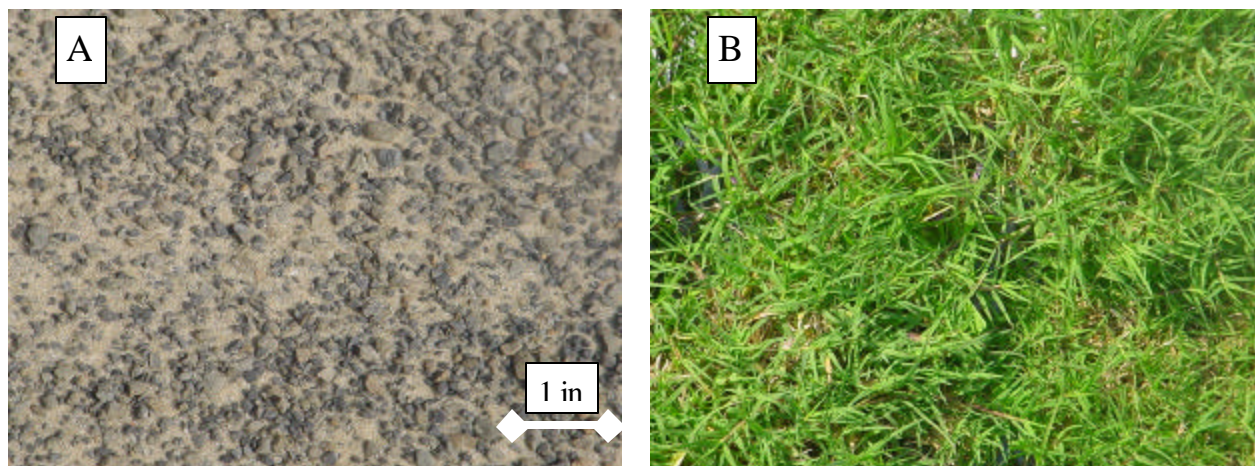


Figure 1. (A) Base blend for porous pavement mixes consisting of 50% sand plus 50% of equal portions of small (1-3 mm) and large (3-6 mm) expanded shale; and (B) bermuda grass growing on the base blend in 5-in pots.

### ***Physical Properties***

A portion of each porous pavement mix was used to determine bulk density and approximate water holding capacity. Each porous pavement mix was placed in a 1 L polyvinyl chloride leaching column of known volume and saturated with water for a period of 24 hours. Then excess water was drained from the porous pavement mix for 24 hours prior to measuring the wet weight. The mixes were then dried at 105°C for 48 hours before measuring the dry weight. Water holding capacity (equivalent to soil field capacity) was calculated on a volumetric basis using a value of 1 g/mL for water. Bulk density was equal to the oven-dry weight divided by the volume of porous pavement mix.

### ***Grass growth***

The porous pavement blends were placed in greenhouse pots measuring approximately 12.5 cm height by 10 cm depth. Bermudagrass sprigs (*Cynodon dactylon* [L.]) were collected from bermudagrass plots on native soil. Sprigs were washed to remove soil prior to planting 3-4 sprigs in each porous pavement pots. During the first 2 weeks after planting the sprigs, each pot received three applications of soluble 20-20-20 fertilizer for a total N, P, and K rate of 0.48, 0.21, and 0.40 g/pot, respectively. After grass was established (Fig. 1B), each pot was periodically fertilized (approximately every 200 to 260 days) with a slow-release form of 18-6-12 fertilizer at a rate of 1.08, 0.16, and 0.60 g/pot of N, P, and K, respectively. Pots were maintained in a greenhouse environment most of the time, but were periodically moved outdoors when mealy bugs (*Pseudococcus Spp.*) became a problem. Growth rates varied depending on the time of year and time after

fertilizer application. Grass tissue was clipped to a 3.8 cm height whenever necessary. Clippings were oven dried at 65°C and weighed to determine biomass production.

### ***Heavy metal and phosphorus leaching***

After grass was well established on each pot, 10 mL of an aqueous solution containing 250 µg each of Cd, Cu, Pb, and Zn was added to the top of each pot. Pots were then leached with 250 mL of deionized water at 1, 3, 7, and 14 days after metal addition. The leachate volume was measured, filtered through a medium grade filter paper, and analyzed for Cd, Cu, Pb, and Zn content by atomic absorption spectroscopy. In most cases, the concentration of these heavy metals was below detection limits of the instrument. Therefore, another 750 µg of the same heavy metals was added to the top of each pot and the pots were leached with 375 mL deionized water 5 days after metal addition. Heavy metal concentrations were still very low, so two months later we added 10 mg each of Cd, Cu, Pb and Zn to each pot and leached them with 375 mL deionized water at 1 and 4 days after metal addition. In all cases, leachate volume was measured and filtered prior to subsequent analyses. To determine the effect of the porous pavement mixes on absorption of heavy metals, we calculated the cumulative amount of heavy metals leached from each pot following the three additions of heavy metals. The cumulative amount was calculated by summing the product of leachate volume and heavy metal concentration for all the leaching events. However, since we did not collect leachate every time we added water to the porous pavement mixes, the cumulative values should be interpreted as qualitative measurements rather than the total flux of heavy metals leached from the porous pavement mixes.

Another purpose for collecting leachate was to determine the fate of fertilizer P added to the porous pavement mixes. An aliquot of the same leachate sample analyzed for heavy metals was also analyzed for dissolved inorganic P content. Inorganic P was determined using the colorimetric method of Olsen and Sommers (1982). Inorganic P measurements should also be interpreted as a qualitative indicator of the ability of the porous pavement mixes to absorb P. Leachate P data was interpreted by considering the number of days the leachate was collected after the last application of fertilizer.

## **Results and Discussion**

### ***Physical properties***

For each physical property, the nine porous pavement treatment means are presented in a single bar graph. However, the data will be discussed in terms of how each specific variable (peat moss content, zeolites content, or expanded shale particle size) affected the physical property of interest. Most treatment means were compared to the simplest porous pavement mix that contained only the base blend without peat moss or zeolites. In the following bar graphs (Figs. 1, 2, and 3), the control treatment is the bar furthest to the left (Mix No. 1) with the other mixes located by increasing mix number (Table 1) to the right. For statistical purposes, the means for all nine treatments were compared simultaneously using Duncan's multiple range test. In general, significant differences among treatment means were easily discerned for all physical properties due to a low degree of variability in the data.

### **Bulk density**

Peat moss was the ingredient that had the greatest effect on soil bulk density (Fig. 2). When added at a 10% rate (v/v), peat moss was no different than the base blend (Mix No. 2 vs. 1), but a 20% addition of peat moss

(Mix No. 3) significantly decreased bulk density. Peat moss is an organic material with a lower bulk density than mineral materials such as soil and expanded shale (Sloan, et al. 2002) Therefore, replacement of the expanded shale/sand base blend by peat moss in the porous pavement mix caused the bulk density to decrease. On the other hand, zeolites have a higher bulk density than expanded shale, which comprised 50% of the base blend, so addition of zeolites to the porous pavement mixes caused the bulk density to increase (Mixes 4 and 5 vs. 1). Addition of 10% peat moss and 10% zeolites did not significantly change bulk density of the porous pavement mix (Mix No. 6 vs. 1), probably because the addition of one negated the effect of the other. Therefore, it was somewhat unexpected to see that the porous pavement mix with the lowest bulk density was the blend that contained 20% peat moss and 20% zeolites (Mix No. 7 vs. 1). With a 20% addition of each of these ingredients, the base blend comprised only 60% of the porous pavement mix. In reality, we did not measure the final volume of the porous pavement mix after we blended the ingredients. The ingredients probably combined in such a way that there was a looser arrangement of individual particles in the final mix, especially the heavier expanded shale and sand particles. Expanded shale particle size had no effect on bulk density of the porous pavement mix (Mix No. 8 vs. 9). The bulk densities for all porous pavement mixes ranged from 1.0 to 1.4 g/cm<sup>3</sup>, which suggested there would be no impediment to root growth.

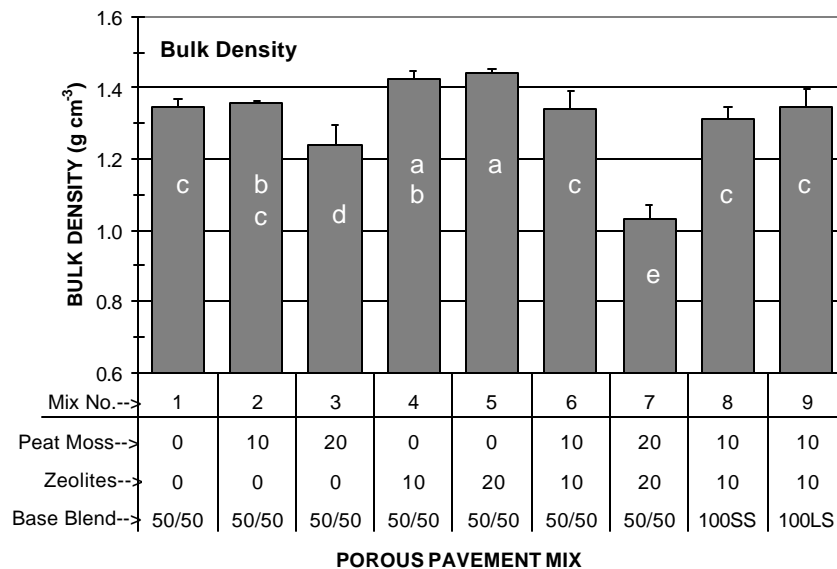


Figure 2. Effect of peat moss and zeolites content or expanded shale particle size on the bulk density of porous pavement blends.

### Water Holding Capacity

Water holding capacity of the porous pavement mixes is equivalent to soil field capacity because it is the amount of water retained in the mix after all excess water has drained gravimetrically. Both the 10% and 20% additions of peat moss increased the water holding capacity of the base blend (Fig. 3) (Mixes 2 and 3 vs. 1). The 20% addition of zeolites (v/v) also increased water holding capacity of the base blend (Mix No. 5 vs. 1), but not the 10% addition (Mix No. 4 vs. 1). However, the increase in water holding capacity due to zeolites was not as great as the increase due to peat moss (Mix No. 5 vs. 3). Nus and Brauen (1991) found

that sand amended with 10 to 20% peat moss retained more moisture than sand amended with equal amounts of natural zeolites. Mix No. 7, which contained 20% peat moss and 20% zeolites, exhibited the highest water holding capacity relative to all other porous pavement blends. This is consistent with the low bulk density for the same mix (Fig. 2). Apparently a combination of 20% peat moss and 20% zeolites has a greater potential to retain water than a 20% addition of either ingredient alone. Once again, it is probably related to the physical arrangement of peat moss and zeolites with the expanded shale/sand base blend. Expanded shale particle size had a small but statistically significant effect on water holding capacity of the porous pavement mix. The porous pavement mix that used only small diameter (1 to 3 mm) expanded shale in the base blend had a higher water holding capacity than the mix that used only large diameter (3 to 6 mm) expanded shale (Mix No. 8 vs. 9). This is consistent with the effect of particle size on water holding capacity of natural soils.

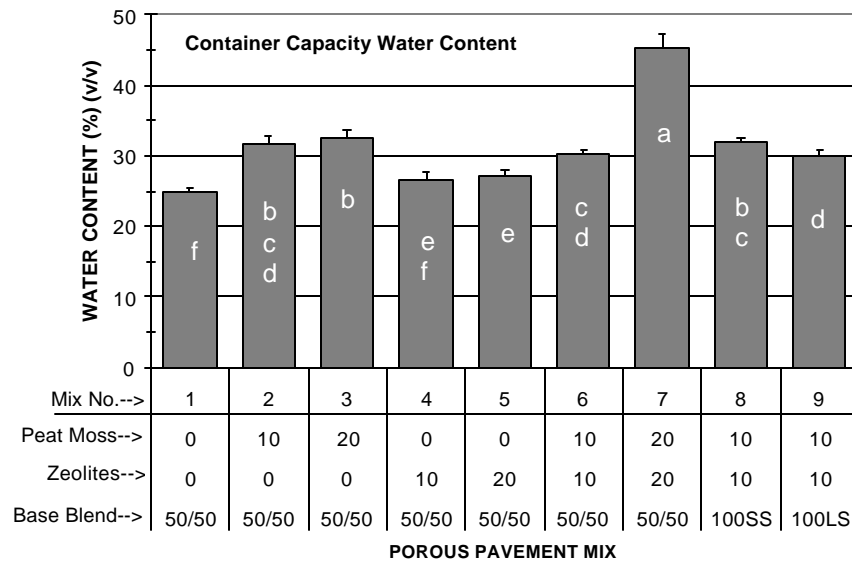


Figure 3. Effect of peat moss and zeolites content or expanded shale particle size on the water holding capacity of porous pavement blends.

### Grass Growth

Bermudagrass clippings were collected twenty two times during a 26-month period. After 15 clippings, we noticed the pots were infected with mealy bugs (*Pseudococcus Spp.*), so we clipped the bermudagrass to the crown level. Mealy bugs continued to be a problem, so after the nineteenth harvest, porous pavement pots were moved outside the greenhouse. Bermudagrass was clipped at intervals ranging from 14 to 65 days, depending on the rate of growth. Since we were interested in the long term ability of the porous pavement blends to sustain plant growth, we calculated the cumulative clipping weights per pot (Table 2). Peat moss was the only ingredient that significantly increased bermudagrass clipping weights compared to the unamended base blend. Zeolites had no effect on bermudagrass growth when added to the base blend alone or with peat moss.

Fertility was the main factor controlling the rate of bermudagrass growth. Bermudagrass required clipping at 2 to 3 week intervals during the first two months after fertilization, but less frequently after that. Pots were fertilized only five times during 26 months. Therefore, the structural soil was probably depleted of nutrients prior to the each fertilization. The length of time between fertilizations ranged from 200 to 260



days. After fertilization, the structural soil blends responded differently to the added nutrients. Those porous pavement blends that contained peat moss or peat moss plus zeolites responded to fertilizer more favorably than those blends that did not in terms of bermudagrass clipping weights (data not shown). In general, there was no difference in bermudagrass clipping weights among the various porous pavement blends beyond 80 to 90 days after the last fertilizer application.

Table 2. Treatments 1 through 7 show the effect of peat moss and zeolite on cumulative bermudagrass clipping rates when mixed with a 50:50 blend of small (1-3 mm) and large (3-6 mm) diameter expanded shale at rates of 10 and 20% (based on volume). Treatments 8 and 9 show the effect of expanded shale diameter on cumulative bermudagrass clipping weights.

TrtNo	Base Blend <sup>†</sup>	Peat Moss Content (%)	Zeolite Content (%)	Cumulative Clipping Weights (g/pot)	SD <sup>‡</sup>
1	50/50	0	0	91.7	17.0
2	50/50	10	0	98.7	9.8
3	50/50	20	0	107.9	9.0
Linear effect of peat moss				**	
4	50/50	0	10	100.9	18.0
5	50/50	0	20	95.1	13.5
Linear effect of zeolites				NS	
6	50/50	10	10	106.2	9.1
7	50/50	20	20	116.9	20.6
Linear effect of combined peat moss and zeolites				**	
8	100SSh	10	10	110.3	6.2
9	100LSH	10	10	106.3	12.0
Linear effect of expanded shale diameter				NS	

NS, \*\* Not significant and significant at the 0.05 level of probability, respectively.

<sup>†</sup> Base blends were mixed in a 50:50 ratio with sand before mixing with the other ingredients.

<sup>‡</sup> Standard deviation of the treatment mean.

## Leachate Chemistry

Leachate was not collected continuously throughout the study, but rather at specific times in relation to the addition of heavy metals to the pots. We generally collected leachate for several days after heavy metals were added. The leachate was analyzed for heavy metals (Cd, Pb, and Zn) and inorganic phosphorus. Additional leachate was periodically collected to assess the effect of fertilization on inorganic P concentration and other nutrients (data not shown). Since we did not collect all leachate from the porous pavement mixes, we cannot calculate a mass balance for the heavy metals and nutrients added to the pots. However, the leachate data is a good indicator of the effect of the porous pavement ingredients on the leaching loss of potential environmental pollutants.

## Heavy metals

Our hypothesis was that the addition of zeolites to the porous pavement mixes would increase their ability to remove heavy metals from contaminated runoff water. The results shown in Figure 4 for Cd, Pb, and Zn are somewhat inconclusive. In most cases, the concentrations of heavy metals in the leachate waters were very close to the analytical detection limits. This introduced a high degree of variability in the data and made it more difficult to discern significant differences among porous pavement mixes. In the case of Cd, neither zeolites nor peat moss affected the amount of Cd in leachate relative to the unamended base blend (Mix Nos. 2 to 7 vs. Mix No. 1). For some reason, the two porous pavement mixes that contained only small or large expanded shale in the base blend (Mix Nos. 8 and 9) resulted in significantly higher Cd concentrations in the leachate water. The reason for this is unclear, but it could be related to the physical arrangement of particles in the porous pavement blend. The results for Zn were very similar to those for Cd. Essentially, peat moss and zeolites did not affect the amount of Zn in leachate water, either when applied alone or together. Only expanded shale particle size affected the amount of Zn. Both small and large diameter expanded shale increased leachate Zn when they were the only form of expanded shale in the base blend.

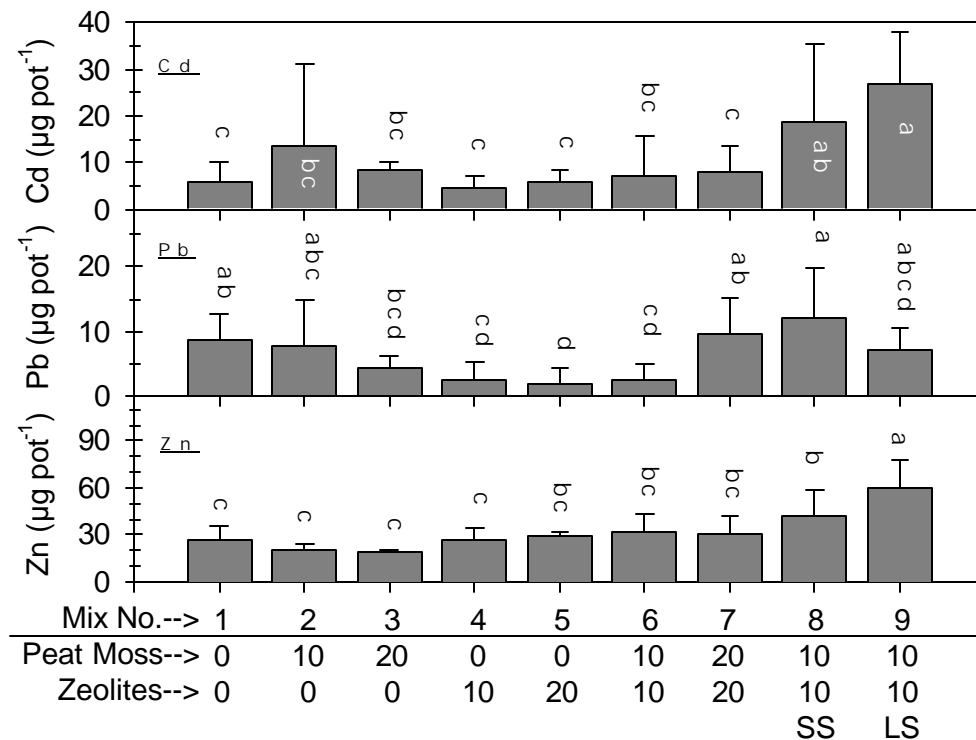


Figure 4. Concentrations of Cd, Pb, and Zn in leachate from the porous pavement mixes after applying 10 mg of each heavy metal to the top of each pot.

Lead was the only heavy metal that appeared to be affected by the presence of zeolites in the porous pavement mix (Fig. 4). Leachate from porous pavement mixes that contained 10% and 20% zeolites without peat moss (Mix Nos. 4 and 5) contained significantly lower concentrations of Pb than the unamended base blend (Mix No. 1). Leachate from the porous pavement mix that contained both 10% peat moss and 10% zeolites (Mix No. 6) also had lower levels of Pb than the unamended base blend, but not the mix that contained 20% of both ingredients (Mix No. 7).

In general, the effect of zeolites on heavy metal removal from leachate water is still unclear based on the results of this study. Zeolites have been used to successfully remove heavy metals from wastewater (Ibrahim et al., 2002), so it is logical to expect them to remove heavy metals from contaminated runoff water. However, there is a high degree of variability in the properties of natural zeolites (Mumpton, 1999), so some zeolites sources may be better than others. In our study, the failure to see definite effects due to the inclusion of zeolites in the porous pavement mixes was probably due to a combination of two factors. First, the amount of zeolites added to the porous pavement blends may have been insignificant compared to the overall porous pavement matrix, and second, the amount of heavy metals added to the top of each column was very low.

### Phosphorus

Grass growing on porous pavement would require periodic fertilization in order to maintain healthy growth. Fertilizer nutrients, especially phosphorus, can be environmental contaminants when present in runoff or drainage water at high concentrations. For that reason, we looked at phosphorus concentrations in leachate water, particularly in relation to when the fertilizer was applied. Table 2 shows concentrations of P in the leachate from each porous pavement blend at times ranging from 5 to 254 days after fertilization. From 5 to 97 days after fertilization, there was a significant difference among porous pavement mixes in the levels of P in leachate water. Peat moss was the ingredient that had the greatest effect on P leaching. Leachate P concentrations increased with the amount of peat moss in the porous pavement mix. Zeolite content and expanded shale particle size had little effect on the amount of P leached from the porous pavement mix. Time after fertilization also had a significant effect on the amount of P leached. The amount of P leached decreased with time and by 162 days after fertilizer application, there was no significant difference among the porous pavement blends. In general, inorganic P concentrations were relatively low in the porous pavement leachate, suggesting that most of the fertilizer P remained in the porous pavement matrix or was removed by grass. Sloan et al. (2000) found that expanded shale has a relatively high capacity to adsorb fertilizer P.

Table 3. Effect of porous pavement ingredients and days after last fertilization application on the P concentration in leachate water.

Mix No.	Base Blend	Peat Moss (%)	Zeo (%)	Leachate P Concentration					
				Days after last fertilizer application					
				5	18	40	97	162	254
1	50/50	0	0	0.192	0.162	0.181	0.447	0.243	0.473
2	50/50	10	0	0.244	0.115	0.141	0.129	0.278	0.483
3	50/50	20	0	0.435	0.316	0.377	0.242	0.425	0.563
4	50/50	0	10	0.274	0.090	0.163	0.198	0.385	0.513
5	50/50	0	20	0.414	0.225	0.295	0.416	0.427	0.494
6	50/50	10	10	0.333	0.149	0.337	0.166	0.306	0.613
7	50/50	20	20	1.203	0.491	0.481	0.658	0.434	0.467
8	100LS	10	10	1.299	0.468	0.403	0.353	0.419	0.652
9	100SS	10	10	0.856	0.191	0.285	0.061	0.220	0.719
	LSD <sup>†</sup>			0.274	0.134	0.188	0.263	0.182	0.184
	p-level <sup>‡</sup>			***	***	**	***	Ns	ns

† Least significant difference between treatment means.

‡ Level of significance.

ns, \*\*, \*\*\* Not significant or significant at the 0.01 and 0.001 level of probability, respectively.

## Conclusions

Our study evaluated the ability of 9 porous pavement mixtures to maintain healthy grass growth and to remove potential contaminants from urban runoff water. Sphagnum peat moss provided the greatest benefits to plant growth but had little effect on the ability of the porous pavement blends to remove contaminants from polluted runoff. Zeolites provided little benefit to plant growth, but showed some potential to remove heavy metals from runoff water. Further testing is needed with higher concentrations of heavy metals. The expanded shale particle sizes tested in this study had no effect on grass growth and there was no effect of particle size on the amount of heavy metals leached. Field scale testing of the porous pavement mixes is needed in order to evaluate their performance under actual environmental conditions and to begin to develop best management practices for turfgrass growing on porous pavement surfaces. Since the porous pavement blends are proposed as temporary parking surfaces, engineering tests are needed to determine load-bearing strengths as it relates to the handling of vehicular weights.

## References

- Barrett, M.E., L.B. Irish Jr., J.F. Malina Jr., and R.J. Charbeneau. 1998. Characterization of highway runoff in Austin, Texas, area. *J. Environ. Eng.* 124:131-137.
- Gaffen, D.J. and R.J. Ross. 1999. Climatology and trends of U.S. surface humidity and temperature. *J. Climate.* 12:811-823.
- Harrison, R. and S. Wilson. 1985. The chemical composition of highway drainage waters I. Major ions and selected trace metals. *Sci. Total Environ.* 43:63-77.
- Ibrahim, K.M., E. Nasser, T. Deen, and H. Khoury. 2002. Use of natural chabazite-phillipsite tuff in wastewater treatment from electroplating factories in Jordan. *Environ. Geol.* 41(5):547-551.
- Johnson, K.V. 1999. Sweaty cities learn natural ways to chill out. *USA Today*. Monday, June 7, 1999.
- Legret, M, V. Colandini, C. le Marc, R.S. Hamilton, and R.M. Harrison. 1996. Effects of porous pavement with reservoir structure on the quality of runoff water and soil. Special issue: Highway and Urban Pollution. Proceedings of the Fifth International Symposium, Copenhagen, Denmark. *Sci. Total Environ.* 189-190:335-340.
- Lo, C.P., D.A. Quattrochi, and J.C. Luvall. 1997. Application of high-resolution thermal infrared remote sensing and GIS to assess the urban heat island effect. *J. Remote Sensing.* 18:287-304.
- Morrison, G., D. Revitt, J. Ellis, G. Svensson, and P. Balmer. 1984. Variation of dissolved and suspended solid heavy metals through an urban hydrograph. *Environ. Technol. Letters.* 7:313-318.
- Mumpton, F.A. 1999. La Roca Magica: uses of natural zeolites in agriculture and industry. *Proc. Natl. Acad. Sci.* 96(7):3463-3470.
- Nus, J.L. and S.E. Brauen. 1991. Clinoptilolitic zeolites as an amendment for establishment of creeping bentgrass on sandy media. *HortSci.* 26:117-119.

Olsen, S.R. and L.E. Sommers. 1982. Phosphorus. In Page, A.L. et al. (eds.) *Methods of Soil Analysis, Part 2 – Chemical and Microbiological Properties*. 2nd ed. Agronomy Mono. No. 9. p. 413-414, 421-422.

Pratt, C.J., J.D.G. Mantle, and P.A. Schofield. 1989. Urban stormwater reduction and quality improvement through the use of permeable pavements. *Water Sci. Technol.* 21:769-778.

Sloan, J.J., W.A. Mackay, and S.W. George. 2000. Growing mediums for porous pavement and rooftop gardens. In W. Burghardt and C. Dornauf (eds.) *Proc. 1<sup>st</sup> Intl. Conf. Soils of Urban, Industrial, and Traffic Mining Areas*. Universität-GH, Essen, Essen, Germany.

Sloan, J.J., S.W. George, W.A. Mackay, P. Colbaugh, and S. Feagley. 2002. The suitability of expanded shale as an amendment for clay soils. *HortTech.* 12:646-651.

Stotz, G. 1987. Investigations of the properties of the surface water run-off from federal highways in the FRG. *Sci. Total Environ.* 59:329-337.

Stotz, G. and K. Krauth. 1994. The pollution of effluents from pervious pavements of an experimental highway section: first results. *Sci. Total Environ.* 146-147:465-470.

## THE WASH PROJECT – THINKING OUTSIDE THE CULVERT

Betty Solek,  
City of Boulder  
Water Quality & Environmental Services  
Boulder, Colorado

David Hollingsworth  
City of Longmont  
Public Works  
Longmont, Colorado

The **Watershed Approach to Stream Health (WASH)** project grew out of a 1999 local storm water round table. Water quality professionals representing various communities in the Boulder Creek and St. Vrain Creek watersheds attended these meetings. The group agreed to develop a way to identify storm water management and data gaps and create consistent storm water quality management approaches throughout Boulder County, which includes much of the Boulder Creek watershed. This effort was initially funded by a grant from the U.S. Environmental Protection Agency (EPA).

The primary goal of the WASH project is to implement a regional storm water management program not only to comply with Phase II regulations but to address broader water quality issues at a watershed scale. The WASH partners recognize the advantages of creation of cost-effective solutions to storm water problems through collaboration on compliance with the Phase II Storm Water Regulations. Countywide collaboration supports and implements the spirit of the watershed approach envisioned in the Federal Phase II Storm Water Regulations. The project has already enjoyed side benefits of increased communication and cooperation, and has created a collaborative process for discussing water quality issues.

There are a number of ways in which WASH uses novel approaches to addressing storm water issues. The WASH Project's implementation strategy provides one example of innovation. WASH Implementation strategy evolved out of the need to allow flexibility within local jurisdictional boundaries. For instance, jurisdictional issues relating to local land-use control were considered when developing programs. The program structure outlined three approaches to collaboration:

1. Shared program elements: common themes and common implementation procedures. An example would be the development of common ordinance language.
2. Individual programs elements: exclusively the responsibility of individual entities to implement. An example would be individual community enforcement of an adopted ordinance that contains the common ordinance language.
3. Shared Program: shared by all entities. An example would be the implementation of one education program servicing all participating communities.

## **A LOCAL WATERSHED APPROACH**

Much has been written about “watershed approaches” to water quality protection. Often these efforts focus on scientific assessments and technical solutions to problems and issues. However, the relationships between entities to achieve a watershed approach are just as important and provide the foundation to tackle technical challenges. In particular, cooperative approaches to compliance with the Phase II Storm Water Quality Regulations involve internal agreements within an organization, agreements between entities within a watershed and between the group of entities and the state agency.

The Watershed Approach to Stream Health (WASH) Project has been operating informally since August 1999. It has made significant strides in building cooperative relationships among municipal, county, and regional water quality professionals in the Boulder Creek and St. Vrain Creek watersheds. The WASH project developed its own unique solution in order to share Phase II programs. The process of developing these programs and the benefits and challenges of program development are described. The WASH process provides an example of a compliance strategy that builds on existing innovative local programs and agreements to create a program that fits local conditions. This paper describes the process of developing the WASH collaborative approach. It also provides a summary of lessons learned from this process that WASH participants hope will be helpful to other efforts.

## **THE WASH PROCESS**

During a storm water round table in April of 1999 and a subsequent focus group in August 1999, it was discovered that there are many gaps in Boulder County storm water data. Initially, the WASH Project provided a forum for Boulder County water quality professionals to identify these data gaps, create workable solutions for filling these gaps, and begin to implement a countywide system of sharing and using storm water quality data to improve water quality in Boulder County.

EPA funding was provided for the WASH project in fiscal year 1999 under the 104(b)(3) grant program. Boulder County used these funds to conduct a workshop on watershed approaches to water quality issues. The grant was also used to facilitate initial exploratory meetings of potential county partners. In the initial WASH meetings, a working agreement and work plan were created between the WASH partners.

The grant also funded a workshop on watershed management presented by the Center for Watershed Protection. This workshop provided information about storm water quality problems and created greater understanding of the issues associated with watershed management strategies. Facilitated meetings of county entities to explore the potential benefits of a watershed approach to storm water permitting followed this workshop. County entities have a history of cooperative, intergovernmental approaches to land management but cooperation on water issues has sometimes been lacking and at times contentious. Thus, facilitation of this discussion was key to identifying common ground and starting the process of developing cooperative programs.

During the first WASH Project meeting, participants came together to discuss the potential benefits of working together and resources that each municipality brings to the table. Participants agreed that in working together, communities would benefit from sharing data, resources, programs, and ideas. Participants were also interested in presenting the public, elected officials and developers with a unified storm water quality message from all Boulder County municipalities.

Participants saw Boulder County municipalities collaborating by:

- Sharing monitoring and data
- Sharing development standards
- Creating a model for accomplishing standards in the basin
- Being unified in defining incentives
- Cooperating between agencies
- Being a model community with respect to water quality

The participants agreed to initiate monthly meetings to explore the opportunities for cooperation. Over the course of a few months, the participants agreed that next steps should include:

1. Create a Memorandum of Understanding/Agreement (MOU)
2. Begin sharing data
3. Educate the public
4. Find additional resources
5. Comply with new regulations

Participants also noted the importance of clearly defining problems, solutions, and common ground at each step in the process, as well as the importance of continuing to build relationships with each other.

### ***Building Common Goals & Objectives***

Participants were asked to break into small groups and answer the following questions together:

- What would it look like if we were successful?
- How would things be different than the current situation?
- What are the possibilities for what a plan like this could create/accomplish?
- What are our “key leverage areas?”
- What specific issues can we focus on to move us forward toward our new vision?

As a result of discussion in the small groups, individuals were asked to jot down thoughts or phrases regarding their needs, desires, values, and goals with respect to the county’s storm water quality. Shared values and goals identified by individuals included:

- enhance and improve water quality
- get councils and boards to believe in enhanced water quality
- educate self and community on Phase II regulations
- use one another as resources; collaborate

Individuals then formed small groups to find any overlap among their shared values and goals and small groups formulated language to describe overlaps. Key words which described the overlaps included:

- stream health
- cost effective
- water quality programs
- improve and protect water quality



- storm water management
- watershed approach
- clearinghouse for education efforts

From these key words, the WASH Project partners developed the following goal and objectives:

**Goal:** Develop a cost-effective watershed approach to enhance and improve water quality through storm water management to protect public and environmental health.

**Objectives:**

- Develop common storm water education programs to raise public awareness and increase public participation in water quality protection.
- Coordinate training and inspection programs for erosion control.
- Coordinate implementation of Best Management Practices (BMPs) to mitigate impacts of storm water runoff.
- Share and coordinate resources to monitor storm water quality throughout the Boulder County watersheds.
- Develop common Phase II programs to ensure cost-effective compliance strategies for WASH communities.
- Provide a forum for coordination of storm water quality concerns and related watershed issues.

The facilitator also led the group in thinking through an agreement regarding the operating ground rules for the project. Following is the working agreement for the project developed by Boulder County participants.

**WASH Project Partners Are:**

- Dedicated to the stated goal and objectives of the project.
- Active participants, attending meetings and voicing opinions equally.
- Willing to share resources and data.
- Clear about their agency’s needs and interest in participating in the project.
- Completing the bulk of WASH Project work in subgroups.

**WASH Project Partners Will:**

- Be prompt to meetings and participate to the highest level of their ability.
- Maintain focus, prioritize all actions, and encourage involvement of all.
- Understand that not all communities have the resources to attend every meeting.
- Complete assigned tasks that are agreed upon in the group.
- Stay informed about discussions and decisions that take place at WASH meetings in their absence.

**WASH Project Partners Are:**

- Participating in good faith and working towards the identified common goal and objectives.
- Committed to the protection of water quality within the Boulder Creek and St. Vrain River watersheds.

- Committed to sharing information and resources with other WASH partners.
- Committed to developing strategies and solution that benefit the general public and represent the shared goal and objectives of the WASH Project.

**WASH Project Decisions:**

- Will be discussed in an organized manner and the process will be open to all.
- Will be made by consensus, an approach to find an inclusive solution that everyone can support.

**WASH Project Partners:**

- Understand compromise may be necessary to reach WASH common goals.
- Show a commitment to mediate disagreements.

The size of the communities involved in WASH varies considerably and the working agreement acknowledged the variable resource pool available due to size differences. It allowed small Boulder County communities to remain involved without committing scarce personnel resources. This was valuable since initially it was not clear that the smaller communities would be designated by the state for compliance with the Phase II permit requirements. When the state finally designated these communities, the smaller communities were linked to the WASH project and the groundwork had already been laid to include them in the project as Partners.

***Memorandum of Understanding: The Power of Non-Binding Agreements***

Early in the process, WASH participants recognized that the six minimum control measures (MCM's) were especially suitable for sharing resources between communities. Thus, exploration of the possibility seemed realistic and appropriate. A MOU was created to document the willingness of the entities involved in the WASH project to explore a watershed approach to compliance with the Phase II permit requirements. The MOU was intended to explain to community decision makers the importance of protecting county streams through a watershed approach. The agreement also pointed to the connection between watershed protection and the opportunity that the Phase II regulations represented. The agreement was a non-binding agreement. However, it created a vehicle for senior management to endorse commitment of staff resources to this approach. The MOU provided formal support for the WASH goals and objectives and the working agreement developed during early WASH work sessions. It also laid the groundwork for development of a formal intergovernmental agreement.

The MOU signature process presented further opportunities to educate decision makers. Senior management of Boulder County entities were informed about Phase II Storm Water Regulations and the benefits of a cooperative, cost effective approach to compliance. Ultimately, a year later, the MOU was signed by the majority of the original WASH participants. Actual signature of the document provided experience in the logistics, which will be useful when a formal agreement is signed.

***Subgroups: The Real Workhorse of the Process***

The WASH participants agreed that meeting once per month for a half-day meeting was a realistic time commitment; however, it quickly became apparent that in order for work products, such as the MOU, to be completed, more frequent meetings of smaller subgroups were needed. During the first year, the subgroups focused on the following tasks:

- **MOU:** develop MOU and obtain signatures
- **Data:** inform WASH Project partners of available storm water resources that can be shared throughout Boulder County
- **Education:** create widespread awareness of water quality issues including implementation of web page, brochures, media products, school materials and presentations
- **Additional Resources:** explore available and applicable funding and resources possibilities in order to secure additional resources for the WASH project
- **Regulations:** inform and educate the WASH project partners about Phase II storm water regulations. This group also investigated the options for a cooperative permit arrangement under the state of Colorado's permit system.

Initially, these work groups focused primarily on gathering information and educating the WASH participants about many issues.

During the second year, one of the most important decisions made by the group was to coordinate compliance under the Phase II Storm Water Regulations. Implementation of the following six "Minimum Control Measures" is required under the Phase II Stormwater Quality Regulations :

1. Public education and outreach on stormwater impacts
2. Public involvement and participation
3. Illicit connections and discharge detection and elimination
4. Construction site stormwater runoff control
5. Post construction stormwater management in development and redevelopment
6. Pollution prevention and good housekeeping in municipal operations

As a result of this decision, the participants re-organized into three workgroups, each workgroup taking on the task of developing two of the above six MCM's called for in the Phase II Storm Water Regulations. These three workgroups each tackled two of the six MCM's as follows:

- Pollution Prevention and Good Housekeeping
- Construction and Post Construction
- Education and Public Involvement

The WASH participants recognized the need for an organized effort to track the progress of the workgroups and prepare an overall schedule for the WASH project in order to coordinate submittal of a joint application for a Storm Water permit. A WASH Project Steering Committee was formed which included representatives from three of the largest jurisdictions in the Boulder Creek/St. Vrain Creek watersheds. These include Boulder County, the city of Boulder and the city of Longmont. The Steering Committee was charged with planning and oversight of the overall WASH Project. Additionally, the Steering Committee developed a schedule for WASH Project activities leading up to storm water permit submittal in March 2003.

The workgroups allowed an interested group of participants to focus on a key aspect of the process. The flexibility of the workgroup tasks allowed the project to progress by making the most of available

personnel. The WASH Programs that resulted from workgroup efforts ultimately became the foundation of the WASH Plan.

### ***Technical Panels: Educating Ourselves***

WASH Project participants organized and attended a series of panel discussions. The WASH Steering Committee invited technical experts to speak on these panels at the WASH general meetings. The panel discussions served to educate all of the WASH participants on the complex issues of storm water quality. These panel presentations began in November 2000 and continued through April 2001.

In May, after the completion of the panel presentations, the WASH Project partners considered all information, which had been gained as a result of the panels. The WASH Project partners answered the question: *What specific storm water problems will the WASH Project address?*

After much group discussion, those present agreed that urbanization is the underlying cause of increased and undesirable storm water runoff issues. While halting urbanization is neither desirable nor practical, urbanization can be accomplished in ways that minimize runoff concerns. In urbanized areas, storm water quality and quantity has been impacted and is different than in non-urbanized areas. The group agreed that by addressing four distinct, yet interrelated areas, the WASH Project could lessen the impact of storm water runoff. The four focus areas are:

1. Sediment
2. Nutrients
3. Spills
4. Erosion

The WASH participants agreed that the WASH project would develop programs to mitigate the impacts of urbanization on the quantity and quality of storm water runoff. This includes the development of programs that address sediment and nutrient loading, illicit discharges (spills), and erosion. The WASH participants agreed that programs would focus on prevention rather than treatment and be easy to implement, enforceable, and cost effective. The WASH Project focus was integrated into draft program proposals under development in each of the workgroups.

### ***Management Transition***

Initially, the Boulder County WASH Project consisted of a group of county and city staff, representatives of non-governmental organizations, university researchers and the regional flood management agency. This diverse group of representatives might have encountered difficulty in coordinating decisions and steps needed to make the WASH project a reality. The EPA grant provided the funding to hire a county facilitator. This facilitator provided a focus for group activities and was a tremendous organizational resource as the group worked through common goals and agreements. Facilitation was also key to developing relationships between WASH participants as the group developed an identity and focus.

The WASH participants recognized that the management system developed over the history of the project was working well. This management system was reflected in the Intergovernmental Agreement (IGA). Part of this management system included establishment of a WASH Project Coordinator to track budgets, program development and permit compliance. This position reflected the importance of the role of the

facilitator in the evolution of the WASH partnership. The Steering Committee also became a formal part of the WASH management system and was incorporated into the IGA.

Over the first two years, the facilitator essentially served as the WASH Project Coordinator. While not initially recognized by the group, the skills and background of a facilitator are substantially different from a project manager. This became apparent as the relationship between the WASH partners became formalized and the skills and focus needed for management of the group changed. The need for different management skills and resulted in a shift of project personnel.

Other shifts in organizational needs also came to light. The informal contribution of staff resources began to shift towards commitment of financial resources for additional WASH staff and consulting resources. This transition time involved some uncomfortable discussions and changes in personnel. In retrospect, this transition from informal to formal organization is predictable and is likely to continue as the group continues to progress towards a formal permit arrangement.

## **GOING BEYOND THE MINIMUM: HOW?**

### ***Building on Previous Successes***

The history of storm water quality management in Boulder County provides an important foundation for the development of the WASH Program. A number of innovative and progressive programs were developed before implementation of the storm water regulations. These programs were already applied regionally through the county and local school district. The existence of these programs quickly was recognized as a resource for development of WASH programs for compliance with the storm water regulations.

In 1989, it appeared that the Storm Water regulations were to be finalized. In anticipation of those regulations, the city of Boulder established a Storm Water Quality Program; however, the Storm Water Quality regulations were not actually finalized until 10 years later. The experience and expertise developed during this interim period were an important foundation for the WASH project.

The city Storm Water Quality program developed and implemented an award winning watershed education program, WatershED. WatershED was developed in cooperation with the Boulder Valley School district and a local watershed organization. The teacher training in the curriculum includes:

- Information on the local watershed
- Classroom and water quality monitoring activities

Community action programs were also developed:

- Storm Drain stenciling
- Raise and release of native species
- Adopt A Stream

The Watershed Outreach program gives adults and kids proactive means to protect, conserve and improve community water. This program was incorporated into the WASH Education program with plans to expand application to another school district located in the Boulder Creek watershed.

Additionally, the city of Boulder and Boulder County have cooperated to develop the Partners for a Clean Environment (PACE) Program. The PACE program offers a voluntary certification of good business practices for environmental protection. To become PACE-certified, businesses must meet industry-specific criteria that reduce hazardous materials and pollution from their routine operations. The certification involves:

- Inspection of business activities for their impacts on the environment.
- Documentation of current business practices which are protective of the environment
- Recommendations to improve practices
- Certification of implementation of protective practices
- Placard announcing PACE certification

Over the years, this certification program has been extended to public entities in addition to businesses. The WASH partners are building on this existing program. Storm water quality protection will be added to the PACE programs. The certification will be extended to all WASH partner municipal and county operations for the WASH Pollution Prevention and Good Housekeeping programs.

### ***Cooperation as Innovation***

In the latter part of 2001, the WASH Project subcommittees completed the proposed programs for each of the six minimum controls measures required by the Phase II Storm Water Regulations. These proposed programs were summarized in tables that outlined the following program components:

- Required Minimum Control Measure
- Program Goals
- Regulatory Compliance
- Community Standards
- Local and National Existing Resources
- Best Management Practices (BMP) Selection
- Implementation Strategy
- Coordination and Responsible Agencies
- Estimated Costs and Funding Options
- Measurable Goals
- Implementation Schedule

Within each of these programs, shared elements, shared programs and individual programs were identified. This approach was developed in recognition of the extent of shared programs that was possible. The WASH implementation strategy evolved out of the need to allow flexibility within the structure of local jurisdictional boundaries. For instance, jurisdictional issues relating to local land-use control were considered when developing programs. The program structure outlined three approaches to collaboration as follows:

1. Shared program elements: common themes and common implementation procedures. An example would be the development of common ordinance language.
2. Individual programs elements: exclusively the responsibility of individual entities to implement. An example would be individual community enforcement of an adopted ordinance that contains the common ordinance language.

3. Shared Program: shared by all entities. An example would be the implementation of one education program servicing all participating communities.

The following graphic shows the relationship between these program elements:

### Watershed Approach to Stream Health (WASH) Program Structure



Sharing programs was recognized as particularly challenging for the Construction and Post Construction programs. The group recognized the challenge of coordinating these two programs in particular due to the variable approaches in regulations and community philosophies. It would not be politically feasible or practical for an entity to relinquish jurisdiction for inspections and approval of development plans.

The work group researched types of ordinances, guidance and enforcement resources currently in place in each community. This provided background on similarities and differences between communities in existing programs. The group identified the following differences:

- Status and patterns of community land development
- Varying levels of funding and resources
- Approaches to storm water quality management

Common elements identified included:

- Guidance manuals
- Challenges in inspection and enforcement
- Management approaches to open space and stream buffers

This analysis allowed the group to realistically identify potential areas of co-operation and sharing between WASH Project partners.

Elements that could be shared included common ordinance language and minimum inspection and enforcement procedures. It was agreed that sharing these elements would create a consistent regulatory environment for businesses in Boulder County. The added benefit of enacting consistent regulations across the county could be expected to protect the health of the Boulder Creek watershed. The common elements of the regulations still allow a regional approach to erosion control and stream protection.

The group agreed that adding a certification of erosion control training to the Construction Program would be an appropriate way to ensure consistency of application of erosion control standards throughout the county. This certification is not a required element of the storm water regulations but was recognized as a cost effective approach to supplement inspection resources available to WASH entities.

The proposed WASH program structure is an innovative, local response that allows maximum sharing of resources for those programs that are readily shared but retains the ability of local jurisdictions to implement their regulations and standards. This flexibility was important for WASH participants, allowing for regional cooperation and maintaining local autonomy. WASH participants recognized that cooperative programs and a regional approach was, in itself, going beyond regulatory requirements.

## **BENEFITS**

The WASH participants recognize and have reaped the benefits of a regional, watershed approach during the three years of program development. The watershed approach employed by the WASH participants as a compliance strategy has generated grant income to support and advance the project. After March 2003, development of programs will no longer be eligible for grant funding because the programs will be considered regulatory requirements. However, since a regional approach is not a regulatory requirement, the WASH participants are hopeful the project will continue to attract grant funding.



More importantly, stream protection benefits are anticipated from the regional, watershed approach. The application of common regulatory requirements will allow for consistent standards to be applied to business, public and construction activities throughout the county. This reduces the potential for one entity to apply lower standards in one portion of a watershed, perhaps undoing the benefits achieved by another entity applying protective standards in another portion of the watershed.

The complete sharing of the WASH Education program is anticipated to provide similar benefits. It is hoped that the power of a consistent message and look from the WASH program will capture the public's attention. This is particularly important given the nature of non-point pollution sources that are literally in everyone's "backyard."

WASH participants have already reaped the benefits of sharing personnel, experience and expertise during development of the WASH programs. The collaborative nature of the process has multiplied the resources available to each entity for development of a permit application. A comparison of the resources available within each entity versus the combined resource base of all county entities quickly shows the power of combining resources.

During the development of the WASH budget for the proposed programs, the WASH consultant's research indicated that a cost savings of 25 percent to 30 percent for program costs could be expected from a collaborative approach. This was confirmed by an analysis which indicated a 25 percent cost savings could be expected by a selected WASH entity.

Further benefits are anticipated from the expansion of innovative existing programs that have already achieved substantial recognition. These programs have been tested and gained the benefit of experience. The programs are now well positioned for expansion.

## **LESSONS LEARNED**

WASH participants have learned a lot of lessons over the course of the project's evolution.

### ***Be Flexible-Adjust Directions***

The evolution of a program can lead in many directions and there are many ways to achieve the same result. Be flexible in order to take advantage of innovative ideas and directions that produce a program that is appropriate for local needs.

### ***Goals are Key-Be Firm***

Achievement of collaboration and a common approach may seem unrealistic in the face of individual regulatory systems. Detailed examination of the components of various options can yield unexpected opportunities. Commitment to agreed upon goals and objectives facilitates is key to progress through these challenges.

### ***Money-Rubber Meets the Road!***

The level of scrutiny of proposals increases when it is time to make financial commitments. Factor in the necessary time and energy to address this additional scrutiny. Additional time will often be required when it seems that development of the program components is final. The commitment of each jurisdiction to the process will be tested as the budget is finalized.

***It Takes Time***

The process of collaboration takes time. It is common to experience a long period for development of a program within one jurisdiction. That time period should be at least doubled for development of a regional program.

***Patience – Don't Force Square Peg into Round Hole***

The time required to develop these collaborative approaches dictates the need for patience during the process. Don't frustrate your efforts further by being rigid. There are many options and it is important to choose those options that work well for your particular group of organizations and individuals.

# **NECESSITY AND OPPORTUNITY: URBAN STORMWATER MANAGEMENT IN ROCKVILLE, MARYLAND**

Lise Soukup, P.E.  
Department of Public Works  
Rockville, Maryland

The City of Rockville, with 50,000 residents and substantial areas of commercial and office development, is located in the Maryland suburbs of Washington, D.C. Rockville began a building boom in the 1940s that continues today (City of Rockville Planning Commission, 2002). The Mayor and City Council encourage residents to take ownership in their local government, and the City prides itself on being responsive to their needs as much as possible. The City government is committed to “enhancing the quality of life in Rockville by providing premium services in response to the needs of everyone who visits, works, and lives in our city”, according to the City’s mission statement.

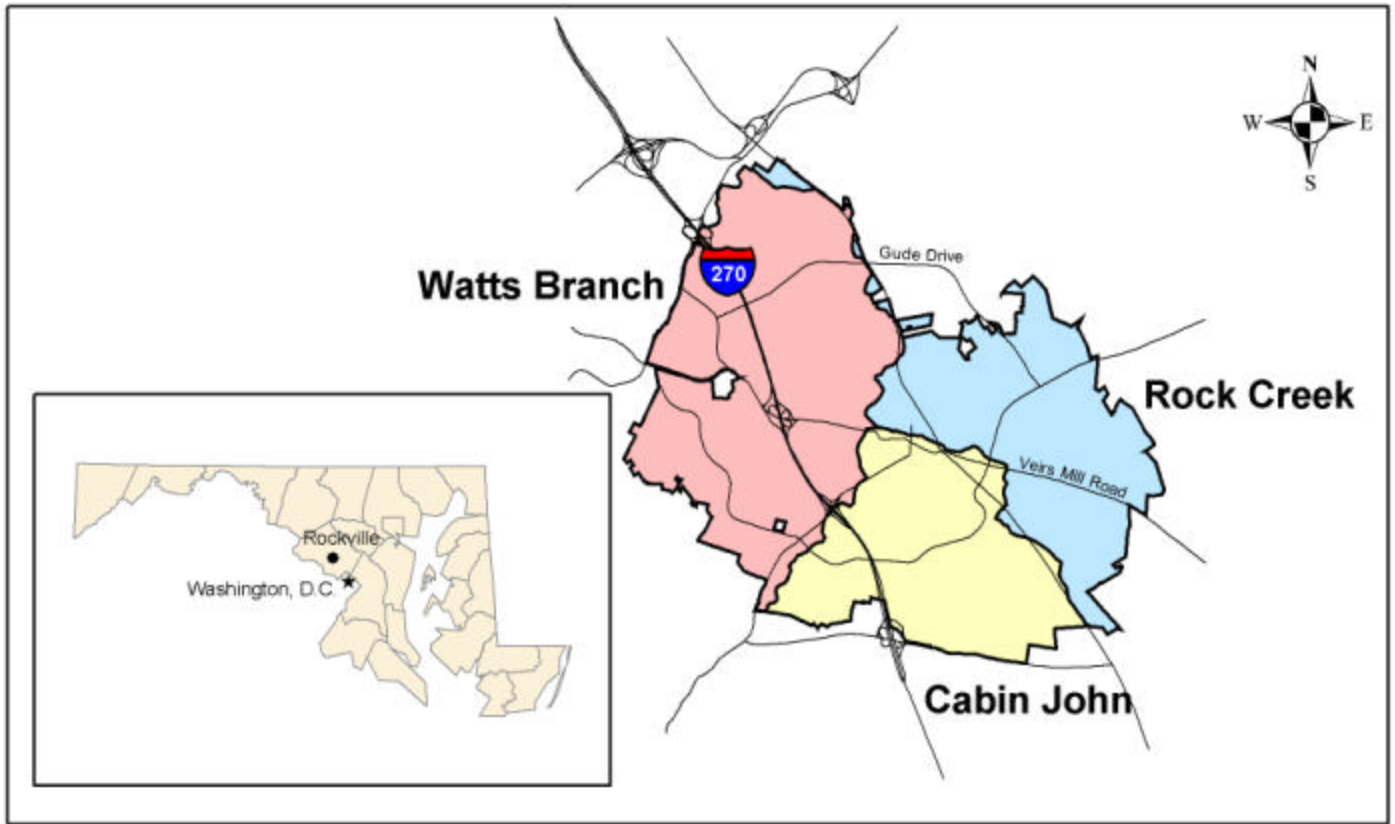
Much of Rockville was built prior to stormwater management (SWM) requirements. Many existing stormwater management systems are ineffective or undersized by today’s standards. The resulting riparian tree loss, stream erosion, siltation and struggling aquatic species in the City’s streams indicate that stormwater management is an ongoing process that continually needs fine-tuning.

Rockville’s Department of Public Works (DPW) has 25 years of experience with comprehensive watershed management, beginning with the first SWM ordinance in the State of Maryland. Current City law and regulations, which mirror the State’s requirements, provide for stringent water quality and quantity control for new development or redevelopment. They also support a strong public stormwater retrofit and stream restoration program. DPW is challenged with creating practical and effective watershed management plans for existing development in a city that is 87% built out. DPW also must demonstrate to residents that the proposed solutions are achievable, effective, safe, attractive, compatible with many other neighborhood needs, and above all, necessary.

## **Rockville’s Watershed Management Plans**

The purpose of the watershed management plans are to make the City’s stream corridors environmentally stable and enjoyable for residents, and to mitigate Rockville’s nonpoint source effects on downstream conditions in the Potomac River and the Chesapeake Bay. These plans recommend projects for subsequent Capital Improvement Program (CIP) implementation that will make a substantial difference to local stream conditions. To work in Rockville, these need to be politically as well as technically viable. The City’s watershed management strategy has evolved into a flexible, opportunistic approach that matches available funding, developers, and complementary projects to needed watershed improvements. The plans also involve stakeholders to an unprecedented degree.

Over the last six years, DPW completed watershed management plan studies for the City’s three watersheds, each more detailed and comprehensive than the last (Figure 1). Each had stream inventories of aquatic conditions and an opportunities assessment to identify possible SWM improvements and stream restoration sites, and each resulted in projects now being implemented through the City’s CIP. The complexity and controversy of the public process varied greatly, however. Residents often had different opinions about stream problems, solutions and acceptable trade-offs, most notably in the last plan.



**Figure 1.** City of Rockville Watersheds

The Watts Branch Watershed Study (Center for Watershed Protection and City of Rockville, 2001) was a lightning rod for controversy. The area had 4,000 acres of residential, office and highway uses, and two major mixed-use developments pending in the headwaters as the study commenced. Vocal residents were protective of their parks and distrustful of the City’s environmental judgement in previous projects. To many, the stream problems lay with the newcomers building upstream, not with their own 30-year old developments. Still, they wanted solutions to the acknowledged erosion and water quality problems through Watts Branch Stream Valley Park, the City’s largest natural area. Table 1 presents data on the City as a whole and on the Watts Branch.

**Table 1.** Rockville at a Glance

CITY OF ROCKVILLE FACTS			WATTS BRANCH FACTS	
Size <sup>1</sup>		13.3 mi <sup>2</sup>	Drainage Area <sup>1</sup>	5.9 mi <sup>2</sup>
Population <sup>2</sup>		47,388	Watershed Imperviousness <sup>4</sup>	28%
Land Use <sup>3</sup>	Residential	73%	Watts Branch Streams <sup>4</sup>	18.7 miles
	Mixed Use	12%	Watts Branch Streams in parkland <sup>4</sup>	7 miles
	Office	7%		
	Industrial	4%		
	Retail	4%		

1: City of Rockville GIS

2: Census 2000

3: City of Rockville Planning Commission, 2002

4: Center for Watershed Protection and City of Rockville, 2001

## Essential Public Process

In previous watershed studies, the City began by studying technical issues. Resident involvement came towards the end of the process when there were recommendations to react to. For Watts Branch, the City needed much earlier involvement and better communication.

Before DPW developed the watershed study’s scope, it held a public meeting to solicit the residents’ watershed and neighborhood concerns. Afterward, staff invited attendees and other stakeholders to join staff for regular meetings to review the study and deal with community concerns about balancing tree loss, appearance, safety and recreation needs against watershed improvements. The City also asked civic associations and developers to send representatives. The resulting Watts Branch Partnership was comprised of residents from across the watershed, City staff from the Recreation and Parks Department, the Planning Department and DPW, and eventually the consultants. The City Manager’s Office had recently established the new Project Implementation Coordinator position to manage the public process for all City projects. This person served as a facilitator at Partnership meetings, and focused on keeping discussions within the ground rules and staying on the agenda. Table 2 lists the stakeholders invited to join; business and development interests did not participate, but residents and institutional agencies were very involved.

**Table 2.** Watts Branch Watershed Stakeholders

Non-agency Stakeholders	Agency Stakeholders
Homeowners Association(s)	Rockville Recreation and Parks Departments
Civic Associations	Rockville Public Works Department
Watts Branch Partnership	Rockville City Forester
Developers (e.g., King and Thomas Farms)	Rockville Environmental Specialist
Watershed Property Owners	State and Federal Regulatory Agencies
Business Interests (industrial, commercial business owners)	Gas, Oil and Utility Companies
Montgomery College	Montgomery County Public Schools
Lakewood Country Club	Rockville Mayor & Council

Center for Watershed Protection and City of Rockville, 2001

The Partnership’s first task was to review the scope of the watershed study. Staff incorporated most suggestions, then had a Partnership resident participate in the consultant selection. The Center for Watershed Protection was selected because of their innovative watershed management approach and experience with local governments. The Center teamed with a local engineering firm and an environmental resource assessment firm to augment their staff (primarily in surveying, stream inventory, and some concept designs).

The Partnership met monthly or more often for two and a half years. City staff set agendas for the meetings and the study schedule, and evaluated and summarized technical information and study results for the Partnership. The Partnership’s resident members acted as liaisons between their civic associations and the City to convey opinions and explain projects, attended lectures to learn about current SWM and stream protection practices, and reviewed drafts of the study report. Partnership members visited existing City SWM facilities and stream restoration sites to see marshes, bio-engineering and gabions that had been in operation for several years.

They used their new knowledge to evaluate the consultant’s analysis and plans. Project details mattered greatly to these members, even seemingly small things. DPW incorporated their advice and comments

wherever feasible, and explained the staff's reasons when we disagreed. This process helped assure the residents that their involvement was productive. It resulted in better integration of important issues for both the residents and the City in the final results, rather than each side losing essential features or issues. It also offered a sense of fairness that is absolutely necessary to belief in good government - even if the residents did not always get what they wanted, they agreed that the study was fair and reasonable.

The City needed residents to support the management plan. It was not only politically difficult to get a controversial set of recommendations adopted, but also complaints of inaccuracies, unresponsiveness and unfairness would cloud unrelated City projects. To demonstrate the City's commitment to working with the residents, staff tried a new process. In 1997, the City had begun training all employees on a new process called Citizen Participation by Objectives (Bleiker, 1995). This process demands that the City convey to all potentially affected interests, or stakeholders, that:

1. There is a serious problem or an important opportunity that must be addressed;
2. The City is the right entity to address it, and that it would be irresponsible for us to ignore it;
3. Our approach is reasonable, sensible and responsible; and
4. We are listening and we care about the costs, the negative effects or the hardships that our actions will cause people.

The Citizen Participation by Objectives approach was time consuming but worthwhile. DPW did not abdicate its responsibility to manage the watershed study or give in on controversial projects. However, staff tried to look at the decision-making process from the residents' point of view as well as from the City's. Sometimes, the staff would argue for a worthy project where the benefits were particularly helpful and the negatives could be overcome or minimized to suit most of the affected people. The Partnership generally saw the same thing and helped design improvements to overcome neighborhood concerns. They advocated the projects and the goals of the Watts Branch study in discussions with their civic associations. This was difficult for some people since they were sometimes viewed as 'selling out', or were caught between displeased neighbors and the City. Nevertheless, the Partnership maintained representation from thirteen out of twenty-one neighborhoods within the watershed. Neighborhoods containing stream valleys or with potential SWM projects tended to participate more. Meetings typically had ten to sixteen residents in attendance.

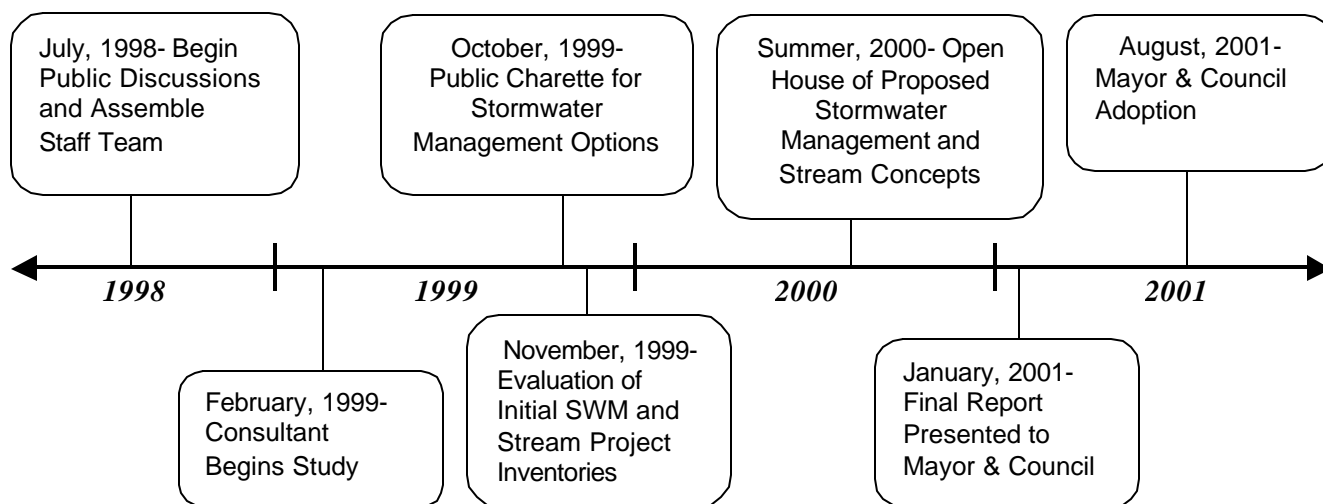
The Partnership did not vote on decisions. It was explained at the beginning of the study that this would be an effort to uncover opinions and concerns, and to look at all reasonable alternatives within the confines of the study assumptions. The Partnership would seek consensus where possible, but dissent was also acceptable. Staff emphasized that the Mayor and Council were the final arbiters of the management plan recommendations, and that the study would try to fairly present both pros and cons of proposed projects. At most key decision points, after discussion had elicited all viewpoints, the large majority of resident members agreed on their recommendations. Those who held opposing positions seemed satisfied that their concerns would be recorded in the final study to be further evaluated when the individual project moved into final design.

In addition to educating the Partnership members, the City also shared the study with the larger Watts Branch community. The Center for Watershed Protection hosted a charette, which was sponsored by the Partnership, for the public early in the study to present findings of existing conditions. Charette participants tried watershed management activities such as creating an educational campaign and designing SWM for several sites. Staff held a month-long Open House to present project concepts and information about the

study, which were also posted on the City’s website for the remainder of the study. Notification postcards were mailed to all homeowners near proposed projects so they would be aware of the study recommendations. Partnership members paired with DPW staff at their own civic association meetings where proposals for local projects were explained. The presence of a neighborhood member who had worked with the City on the study recommendations proved invaluable. With the Partnership in attendance, the Mayor and Council adopted the Watts Branch Watershed Management Plan in 2001.

## Watershed Study Methods

The Watts Branch Study uses the Rapid Watershed Planning Handbook (Center for Watershed Protection, 1998) methods to predict future watershed conditions based on impervious cover, set realistic and measurable goals, and assess whether improvements are working. This generates recommendations based on defensible science and measurement. It emphasizes local commitment by requiring community involvement and an implementation plan adequate to carry out the recommendations. Figure 2 illustrates milestones in the study.



**Figure 2.** Watts Branch Watershed Study Timeline (Center for Watershed Protection and City of Rockville, 2001)

Phase I of the study consisted of the initial data gathering and analysis, leading to a list of needs and opportunities. Rockville was fortunate to have recent GIS-based topographic, property and utility information for the entire city, and 2’ contour topography and tree surveys for almost all parks. The consultants did an RSAT (Rapid Stream Assessment Technique) survey of stream habitat and physical conditions at 400-foot intervals to assess the general health and level of erosion in Watts Branch and its tributaries (Galli, 1996). Potential and existing SWM facilities around the watershed were screened by drainage area and capacity, effectiveness and feasibility of modernization. They were field-checked to evaluate natural resource constraints and expansion concerns.

Data from a Rapid Geomorphic Assessment evaluated physical parameters related to channel widening, downcutting and accretion (Center for Watershed Protection and MacRae, 1999). Based on this data and historic cross-sections from the 1950s-1960s, a new technique developed by the Center for Watershed Protection was used to predict the ultimate size of the channel at various points. It correlated the pre-urbanization and current channel cross-sectional area to imperviousness changes in the sub-watersheds, then

predicts final stream sections for the built-out imperviousness after factoring in the stream's response time (Caraco, 2000). This was considered to be more accurate than short-term monitoring with bank pins.

After the staff and Partnership members evaluated and prioritized the Phase I results, a list emerged of the most promising SWM opportunities and the most significant reaches of stream erosion. Phase II produced a 30% engineering concept design for each of these projects. The SWM concepts provided basic hydrologic and sizing computations, a conceptual grading plan that included maintenance access and limits of disturbance, and a count of significant trees (>12" DBH) that would be removed by the proposed project. Stream concept plans showed proposed restoration techniques, including rock vanes, step pools, coir fiber logs, bank laybacks and planting, and imbricated rip-rap or gabions. Stream plans also showed the limits of disturbance for access paths, stockpiles, and construction to give the Partnership a better sense of whether the stabilization justified the disturbance and tree loss. On several projects, the consultants were asked for alternate SWM concepts to explore Partnership requests that would reduce tree loss or relocate the footprint.

During Phase II, the City met with representatives from Maryland Department of the Environment and the Army Corps of Engineers to consider wetland and waterway permitting issues. Their comments resulted in abandonment of one SWM concept and revisions to several others to better protect existing wetlands and maintain streams through the proposed ponds. The regulatory agencies were very supportive of the management plan's intent to mitigate a developed watershed, and helped identify permitting constraints and acceptable alternatives during the concept process. This is expected to facilitate the later project design stage when Section 401-404 permits will be sought.

Phase III focused on watershed-wide issues. Several Partnership meetings were devoted to discussing members' views on environmental education, watershed outreach and effective ways to change behavior in residents and businesses. The Center for Watershed Protection developed a schematic education/outreach approach based on research into other successful programs (Schueler, 2000a, 2000b). The Center also produced a map of wetland enhancement and forestation opportunity sites that staff will integrate either with specific stream restoration/SWM CIP projects or through developer obligations under the City's Forest Conservation and SWM ordinances. These and other non-structural watershed rehabilitation strategies will be implemented across Rockville in the next few years through the City's upcoming National Pollutant Discharge Elimination System – Phase II (NPDES-II) permit requirements.

## **Study Assumptions**

City staff specified numerous study assumptions that shaped the solutions. The City Department of Parks provided parameters such as no net loss of active playing fields or other recreation features due to SWM or stream projects. The City Forester and Environmental Specialist specified access paths and helped characterize forest and wetland resources to avoid extensive impacts. For cost-effectiveness, DPW chose 25 acres as a desired minimum drainage area for retrofit consideration, although a few opportunities for small facilities were also evaluated. This limitation automatically reduced feasible SWM choices to various forms of ponds and marshes. Bioretention, surface sand filters and underground pipe storage become impractical with drainage areas larger than a few acres, although the City regularly uses these methods for smaller sites.

With erosion and riparian tree loss topping the list of community concerns, water quantity control became the most important SWM parameter to address on a comprehensive scale. Therefore, it was decided in consultation with the Center that the first priority would be to achieve 100% of the Channel Protection Volume (i.e., 1-year, 24-hour extended detention control) in a facility. This has been designated by the



State of Maryland as the most critical SWM control for preventing downstream erosion (Maryland Department of the Environment and CWP, 2000). Water quality treatment was also included to the maximum extent feasible. About half of the recommended SWM sites could accommodate 100% of the water quality volume for 0.5” of runoff over the watershed area, which was consistent with the City’s water quality standards in 2000 and deemed reasonable for a retrofit situation (Center for Watershed Protection and City of Rockville, 2001). One inch of water quality treatment was not practical due to storage limitations.

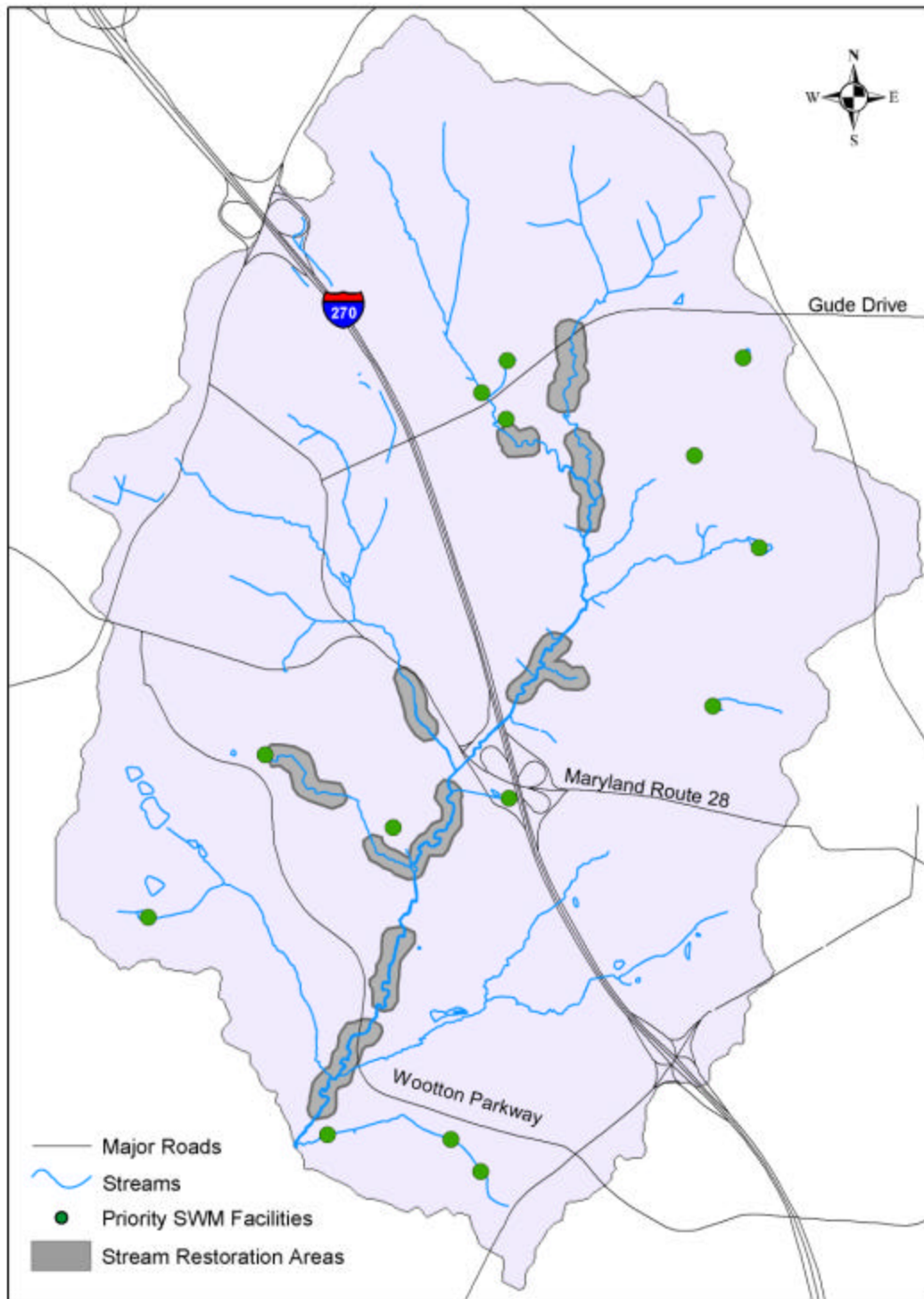
Stream erosion problems were found in almost all tributaries and throughout the mainstem. To help prioritize these, DPW applied an existing City policy that limits use of City funds to improvements on City lands. From the City’s perspective, these funds should be spent on repairs to the City’s first responsibility, its own parks. For stream reaches owned by private homeowners’ associations or residents, this assumption has caused problems. Even if erosion was significant on these reaches, the City’s ranking system discounted the site, resulting in stream restoration recommendations only for publicly owned streams. The City is now debating whether this policy can be modified without incurring large and unplanned financial burdens.

The public process also operated under assumptions. First, staff believed that the Citizen Participation by Objectives methods would be effective in fostering cooperation and open exchange of ideas with residents, so that compromise would be achievable. This assumption was generally met, and resulted in high satisfaction with the study process from both Partnership and non-Partnership residents. Second, staff assumed that the civic and homeowners’ associations were the main conduits to convey information between residents and the City. This tended to work well in active associations, but was ineffective at informing communities where neighborhood meetings were informal and infrequent. This gap was partially filled with the City’s publicity and notification process through local mailings, papers, and City Cable TV shows.

## **Study Findings and Recommendations**

At the end of Phase I, 54 SWM opportunities were considered in Partnership meetings from both the City’s perspective (such as pollutant removal efficiency, capacity to control the drainage area, cost, access and maintenance burden) and from the community perspective (including appearance, safety concerns, impacts to trees and to recreation). Since these perspectives often worked at cross-purposes, staff chose a two-variable system to compare SWM projects. Each project received two scores that were plotted on an x-y coordinate system to graph the relative values of environmental management vs. community impacts. Scores reflected that a project could be neutral or negative in a category, as well as positive. Projects that scored well in both categories were agreed to be worthy of further investigation at the Phase II concept stage. A few projects that were highly rated in one category and had few negative effects in the other category also went to concept stage. This method simplified the comparisons while helping the Partnership visualize distinctions. In all, 18 SWM projects moved forward for Phase II concepts.

Similarly, 62 RSAT sample points, covering 4.7 stream miles, were culled through a ranking system based on severity and extent of erosion, land ownership and forest impacts. 2.7 miles of stream were selected as high priority restoration areas.



**Figure 3.** Adopted Watershed Projects in Watts Branch (Center for Watershed Protection and City of Rockville, 2001)

Some controversial projects moved forward to concept design. The Partnership members agreed that more information was needed before deciding whether these were viable or not. This aided the concept evaluation process at the end of Phase II, since the Partnership could then assess questionable projects with better information.

The City and the Partnership had to balance the impacts of projects against the threat of doing nothing. The Rapid Geomorphic Assessment projections showed that, as a whole, Watts Branch stream cross-sectional area may expand to two to four times its existing size over the next 40-50 years as it adjusts to a new state of equilibrium with the watershed's built-out impervious condition (Center for Watershed Protection and City of Rockville, 2001). This would lead to continued extensive undermining and toppling of large trees along most of the stream valley, add more sediment to the stream system, and degraded the biological activity of the fish and macroinvertebrate populations throughout Watts Branch. Given that the community was clamoring for the City to do something about sediment-laden streams and undermined trees at the start of the study, it became clear to the Partnership that the null alternative would not serve the goals. This made it easier for the Partnership to defend the inevitable tree loss, construction impacts and SWM facility changes they needed to endorse, and helped the members move onto seeking realistic ways to minimize these impacts rather than declare them unacceptable.

The projects adopted in the management plan are shown in Figure 3. The Watts Branch Management Plan established fourteen SWM retrofit projects covering 925 acres of untreated or under-treated development (roughly 25% of the total watershed), of which eleven would be public facilities. The plan provides four new SWM facilities and ten modernizations to existing SWM ponds, as well as nine separate stream restoration projects. Combined with new SWM systems for 700 additional acres of mixed-use development in the Watts Branch headwaters, this represents effective management of a substantial portion of a built-out watershed. Over 50% of the watershed will be treated by modern SWM controls of 1-year, 24-hour extended detention and quality treatment of at least 0.5" runoff.

## **Problem Projects**

Not all projects evaluated in Phase II survived in the final recommendations. In following the Citizen Participation by Objectives method, staff dropped environmentally valuable projects that might create more neighborhood problems than they would solve, such as on a potential pond site that would clear a 200 foot wooded buffer between houses and an interstate highway. Technically, the facility would work; the noise and visual impacts to the houses facing the site were estimated by City staff to be insurmountable and could not be adequately mitigated without the State Highway Administration's commitment to a noise wall. The City maintained credibility by showing that the watershed goals were based not only on environmental benefits but community benefits as well.

Knowing neighborhood history helped the staff and consultant avoid unnecessary impacts. For example, the study recommended a new wet pond at a park site that was just receiving a new playground through the efforts of the Parks Department and a local Girl Scout troop. The proposed pond would necessitate relocation of the playground. DPW decided to schedule the pond project later in the CIP to coincide with the expected lifespan of the playground. This would give the community ten years to enjoy their playground and agree on a satisfactory new location in the same park for the next set of play equipment.

As expected, the most controversial projects were proposals for new ponds in active parks. The College Gardens Park pond produced a long stalemate between the staff and a neighborhood civic association. This

project called for the expansion of a small farm pond to almost three times its current size in a heavily used urban park. This project was popular with the staff and the Partnership because it was fairly neutral in community impacts while providing exceptional water quality and quantity benefits for an 89-acre mixed-use watershed. Although the expansion would remove grassed playing area, all other recreation features and trails could be retained or relocated.

Several residents, including the civic association president, were polarized against any changes to this park, and demanded more ‘innovative’ alternatives be investigated, including underground SWM proprietary measures and moving the pond downstream into a wooded stream valley. Community opposition materialized with the first presentation to the civic association and took fourteen months and eight formal meetings with association representatives before the Watts Branch management plan was finally adopted. Some of the difficulty came from issues of control as people who were not involved in the Partnership tried to negotiate separate oversight of the study.

To counter this, the City followed the original methods of Citizen Participation by Objectives, reiterating the history of the public process. The City also pointed out that several association members had, in fact, been on the Partnership since the beginning, including the association’s president at the start of the Watts Branch study. DPW also obtained a lengthy alternatives analysis from our consultant in the final months of the study that investigated the association’s requests and demonstrated that there were high costs for proprietary treatment and wetland/stream impacts for the in-line alternative that proved unacceptable to the state and federal regulatory authorities.

The project was conditionally recommended in the management plan after an extensive section on benefits and concerns describing the civic association’s issues. At the request of the Mayor and Council, a further alternatives analysis will be completed before selecting a final design. Since traditional SWM approaches have already been investigated, staff will use this required evaluation to look at feasibility and implementation of concepts that were previously outside of the Watts Branch watershed study assumptions. The alternatives analysis will compare expected benefits and disadvantages from a watershed education/behavior modification program for residents, businesses and institutions in this community, a small-scale SWM retrofit program focusing on the high-impervious non-residential uses (about 30% of the watershed), the management plan’s recommended central SWM facility, and stream restoration/storm drain outfall stabilization. DPW hopes this will help clarify the pros and the cons of each choice to find a solution that has both reasonable environmental benefits and acceptable public understanding and support. Staff expects the civic association to be an active participant in this follow-up analysis, much as the Partnership was for the Watts Branch study. This investigation will also assist DPW in testing approaches for the NPDES-II requirements.

## **Post-Study Evaluation of the Public Process**

The Partnership’s two and a half year review period left enough time for watershed education and gathering feedback from the participating neighborhoods. Residents were welcome at any time to start attending meetings, and several active Partnership members joined at the Phase II concept stage. Staff had more difficulty explaining the study’s background, scientific basis and findings to non-Partnership residents & civic associations in the space of only a few meetings. Most associations and residents were able to appreciate the validity of the recommendations and agreed to support their local projects. One neighborhood did not participate at all in public meetings or the Partnership, then protested the proposed

project during the last few months before adoption. The City will need to work closely with these residents when the design stage begins, since they have no previous commitment through the watershed study.

The Partnership members delivered a statement at the final plan's introduction to the Mayor and Council regarding their support of the management plan process and recommendations. Not all controversy could be avoided. The Mayor and Council heard opposing views during the eight months between introduction and adoption of the management plan, but still believed that staff had been fair and objective in making the recommendations. The fact that only two of the recommended projects drew any negative comments showed that there was general satisfaction among the stakeholders. Many residents commented that the projects showed an awareness of collateral neighborhood issues and preserved features important to them.

A year after the Watts Branch Watershed Management Plan was adopted, the Partnership members received a survey from the City asking for their opinions on the effectiveness of the study process, their satisfaction with the study's methods and recommendations, and their viewpoint on whether their involvement made a difference. The responders were extremely pleased with the staff's cooperative efforts and the public process, citing it as much improved over previous City projects and an example of how government should work. They recommended that this process be used for other controversial projects. Although some members felt that solution options were too limited, they agreed that the City had made a valid effort to explore alternate ideas and the final recommendations were compatible with their neighborhood needs. They also liked that SWM and stream concepts had been revised to incorporate most of their project-specific comments.

The public process led to compromise on both parts, a willingness to explore alternatives, and acknowledgement that not every problem could be solved. Once the members could tie watershed goals to community goals, or at least balance conflicts between them, many watershed projects became palatable. In general, residents are much less fearful of the short-term impacts and long-term effects on their quality of life. The study built credibility and support within the neighborhoods that will be essential as DPW continues to work with the residents during design and construction.

## **Implementation - From Paper to Ponds**

A watershed management plan will succeed only if it is implemented. In the past decade, DPW has built at least ten stormwater management retrofit and five stream restoration projects from its watershed studies. Watts Branch Plan projects on City parkland are proceeding through design and construction in the City's CIP over a 10-year period. Non-City projects are also advancing through other mechanisms, such as a low-cost retrofit of a State Highway Administration dry pond in an Interstate-270 interchange that is being designed and constructed through the Recreation and Parks Department to fulfill its SWM obligation for a new bike trail. Through private development, dozens of other SWM and stream projects are built and then turned over to the City to maintain. Although Rockville has had its share of planned SWM projects that were never built due to changing wetland standards, land constraints or public outcry, the City's long-term implementation rate is impressive.

Watershed plans are dynamic documents. They guide CIP planning, but DPW also forwards the watershed goals through cooperative planning with developers and teaming projects that need more immediate attention. The City's watershed management strategy continues to include a bigger toolbox of private/non-parks opportunities. Given Rockville's built-out condition, equivalent SWM alternatives such as stream restoration or stabilization, retrofit of an existing but outdated SWM facility, or control of a different piece

of imperviousness on the site (parking lot instead of rooftop) may offer more environmental benefit than a traditional onsite SWM system. Regular performance monitoring and stream surveys are still needed to identify the solutions that work and the needs that remain. DPW expects to revisit each watershed management plan every ten years to evaluate its progress.

The public process continues through the final design and construction phases for individual projects. Projects in parks or near residences are heavily publicized. Several meetings are held at various points to get feedback on design details and neighborhood concerns. DPW, the Project Implementation Coordinator and other staff make sure residents have access to information. Good groundwork at the management plan level helps to prepare communities for upcoming changes.

The City’s dedicated SWM Fund makes the watershed management program self-supporting (Table 3). Money is primarily collected from monetary contributions collected in lieu of on-site SWM from projects too small to support their own facilities and, to a lesser extent, from developers’ SWM and sediment control permit fees. The fund supports the operating budget expenditures for maintenance on City-owned SWM facilities and for DPW staff who review or inspect SWM and sediment control in both private development and the City’s CIP. The fund also covers design and construction of public SWM facilities and stream restoration, watershed studies, policy planning, and some additional programs that will be needed for the City’s upcoming NPDES-II permit.

The estimated design and construction cost for all of the Watts Branch Management Plan projects is a total of \$2.8 million. Based on a 2000 fiscal analysis, the fund should manage expected costs for the foreseeable future, including full funding of projects from all three watershed management plans. However, as development slows with the City’s near build-out, a SWM utility fee for residential and business owners may become necessary. DPW also solicits and receives limited State grant funding for design and construction of SWM and stream restoration projects.

**Table 3.** City Stormwater Management Fund

Stormwater Management Fund	
Unreserved Fund Balance (FY2002)	\$5.2 million
Monies Earned (FY97-2000)*	\$963,000/year
Operating Expenses (FY97-2000)*	\$290,000/year
Capital Expenses (FY1997-2000)*	\$550,000/year

City of Rockville Department of Finance, 2002

\*Note: Average taken over 4 years for better picture of income and expenditures over time.

## Conclusion

Rockville’s watershed management plans have benefited from a dedicated funding source, a compact and flexible city government, a strong development community, a spirit of teamwork among City staff, and resident interest in streams and parklands that is reflected by the Mayor and City Council. Problems and priorities change, so these plans only capture a snapshot in time of watershed conditions. Therefore, DPW will continue to advance effective and innovative watershed stream protection with a variety of strategies. In watershed management, everything is an opportunity.

## References

- Bleiker, H. and A.M., 1995. Citizen Participation Handbook for Public Officials and Other Professionals Serving the Public, 9<sup>th</sup> ed., Institute for Participatory Management and Planning.
- Caraco, D.S., 2000. The Dynamics of Urban Stream Channel Enlargement, *Watershed Protection Techniques*, 3(3)-729-734.
- City of Rockville Department of Finance, 2002. FY2003 Adopted Budget and FY2003-2008 Adopted Capital Improvements Program.
- City of Rockville Planning Commission, 2002. Comprehensive Master Plan for the City of Rockville, Planning Commission Draft.
- Center for Watershed Protection and City of Rockville, 2001. Watts Branch Watershed Study and Management Plan Final Report.
- Center for Watershed Protection, 1998. Rapid Watershed Planning Handbook.
- Center for Watershed Protection and C.R. MacRae, 1999. State of Vermont Watershed Hydrology Protection and Flood Mitigation Project.
- Galli, J., 1996. Rapid Stream Assessment Technique (RSAT) Field Methods, Final Technical Manual, Metropolitan Washington Council of Governments.
- Maryland Department of the Environment and Center for Watershed Protection, 2000. 2000 Maryland Stormwater Design Manual, Volumes I & II.
- Schueler, T., 2000a. On Watershed Education, *Watershed Protection Techniques*, 3(3)-680-686.
- Schueler, T., 2000b. Understanding Watershed Behavior, *Watershed Protection Techniques*, 3(3)-671-679.

# RE-INVENTING URBAN HYDROLOGY IN BRITISH COLUMBIA: RUNOFF VOLUME MANAGEMENT FOR WATERSHED PROTECTION

Kim A Stephens, PEng, KSA Consultants Ltd<sup>1</sup>, West Vancouver, British Columbia

Ted van der Gulik, PEng, BC Ministry of Agriculture, Food and Fisheries<sup>2</sup>, Abbotsford, British Columbia

Laura Maclean, Environment Canada<sup>3</sup>, North Vancouver, British Columbia

Ed von Euw, PEng, Greater Vancouver Regional District<sup>4</sup>, Burnaby, British Columbia

## ABSTRACT

There is a logical link between changes in hydrology and impacts on watershed health, whether those impacts are in the form of flooding or aquatic habitat degradation. The link is the volume of surface runoff that is created by human activities as the result of alteration of the natural landscape (i.e., through removal of soils, vegetation and trees). When trees, vegetation and soils are replaced by roads and buildings, less rainfall infiltrates into the ground or is taken up by vegetation, which results in more rainfall becoming surface runoff. The key to protecting urban watershed health is to maintain the water balance as close to the natural condition as is achievable and feasible by preserving and/or restoring soils, vegetation and trees. But accomplishing this requires major changes in the way we approach urban drainage and in the way we develop land. Drainage engineers have traditionally thought of reconciling pre- and post-development runoff in terms of flow rates, not volumes. At the site level, however, we need to focus on how much rainfall volume has fallen, how to capture the excess, and what to do with it. The Province of British Columbia in the Pacific Northwest is leading the way in North America in developing and implementing innovative criteria and methodologies for reducing excess runoff volumes at the source, where rain falls. Science-based performance objectives and targets have been established to mimic the hydrology of a natural forest. Performance targets are being implemented through demonstration projects, notably at two large-scale 'sustainable communities':

- **UniverCity** - A high-density urban community that is being developed by Simon Fraser University to house 10,000 people at the top of Burnaby Mountain in the heart of the Greater Vancouver urban region
- **Headwaters** - A medium-density residential community that is being developed to house 14,000 people in the East Clayton area of the City of Surrey, a suburban municipality in the Greater Vancouver region that is the Province's second largest city (with a population 300,000).

Through an Inter-Governmental Partnership, a decision support tool called the *Water Balance Model for British Columbia* is being enhanced to help local governments integrate land use planning with volume-based analysis of stormwater management strategies. The WBM is used to evaluate the potential for developing or redeveloping communities that function hydrologically like naturally forested or vegetated systems. The tool creates an understanding of *how*, and *how well*, stormwater source control strategies for runoff reduction would be expected to achieve watershed protection and/or restoration objectives.



# What Can be Done at the Site Level to Protect Watershed Health

## *The Logical Link*

There is a logical link between changes in hydrology and impacts on watershed health, whether those impacts are in the form of flooding or aquatic habitat degradation. The link is the volume of surface runoff that is created by human activities as the result of alteration of the natural landscape. The key to protecting urban watershed health is to maintain the water balance as close to the natural condition as is achievable and feasible by preserving and restoring soils, vegetation and trees. Accomplishing this requires major changes in the way we approach urban drainage and in the way we develop land. In the future, there will be more runoff volume to manage in the urban regions of British Columbia due to the combination of:

- ❑ **Population Growth** – resulting in more land development plus re-development and densification of existing urbanized areas
- ❑ **Climate/Weather Change** – likely resulting in both increased seasonal rainfall and more frequent ‘cloudbursts’

The financial and staff resources of local government are limited. Therefore, those resources must be invested wisely to maximize the return-on-effort. Common sense says that the best return will be at the site level where local government exerts the most influence, and can therefore make a cumulative difference at the watershed scale. The term ‘source control’ is used in this context to describe the suite of strategies available to capture and retain rainfall volume at the development site.

## *Water Balance Model for British Columbia*

The practice of low impact development often involves efforts to reduce the impacts of stormwater runoff using various types of source controls designed to minimize runoff volumes. The effectiveness of these source controls varies with their design, with precipitation patterns, and with soil type, among other factors. The overall performance of these source controls is obviously of great interest to developers, homeowners and local governments alike.

In June 2002, the British Columbia Ministry of Water, Land and Air Protection published the document *Stormwater Planning: A Guidebook for British Columbia*<sup>5</sup> The Guidebook lays out targets for reducing runoff volume to achieve watershed protection objectives. The Greater Vancouver Regional District (GVRD) recently completed a study to evaluate the effectiveness of a suite of such stormwater source controls with these targets in mind. The results of the GVRD study are incorporated in the Guidebook.

In order to answer questions about the effectiveness of source controls, the GVRD's consultant developed and applied a water balance model, an interactive tool that can simulate the performance of impervious controls, absorbent landscaping, infiltration facilities, green roofs and rainwater harvesting under various development scenarios. After exploring the capabilities of the model, a group of municipal, regional, provincial and federal government representatives saw the potential to use it to integrate volume-based analysis of stormwater management strategies into land use planning throughout British Columbia.

An Inter-Governmental Partnership was struck in the summer of 2002 to secure access to the model and develop a more user-friendly version, to be called the *Water Balance Model for British Columbia*. The Inter-Governmental Partnership is chaired by the BC Ministry of Agriculture, Food and Fisheries, and co-chaired by Environment Canada. The GVRD is the host organization, providing logistical support as required. A number of municipalities are currently engaged in the project, and others who share an interest

are invited to join as the project evolves. The end result will be a user-friendly model that can be used to inform and evaluate land use planning decisions for their ability to meet stormwater management objectives, both at the scale of the individual development site and the watershed.

In Phase 1, to be completed by June 2003, the existing water balance model is being converted to a new operating platform complete with graphical user interface (GUI) that will allow for more efficient data storage procedures, faster performance, increased portability, more flexible output options, and easier technical enhancement as the state-of-the-science evolves.

Members of the Inter-Governmental Partnership are participating actively in enhancement of the model and graphic user interface, and will be the first recipients of the resulting *Water Balance Model for British Columbia* (hereinafter referred to as 'the WBM'). Subsequent project phases may involve field testing and calibration of key model assumptions, and linking the model to regional GIS and precipitation databases.

### ***Project Vision for WBM Application***

A "project vision" is the image or understanding of what the project will accomplish, and what will be different at the end of the project. The British Columbia Guidebook demonstrates how to establish science-based performance objectives to mimic the hydrology of a natural forest. This outcome can be achieved through a combination of rainfall capture and runoff control techniques. The WBM is an extension of the Guidebook, and is intended to be a 'decision support /scenario modeling tool' that will help local governments and landowners make better land development decisions.

The over-arching project goal in enhancing the WBM is to facilitate changes in land development practices so that in future sites and subdivisions will be designed to function hydrologically like a natural forest that has 10% impervious area. To accomplish this goal, the GUI (graphical user interface) for the WBM must be easy to understand and simple to use.

The enhanced WBM will be an *Access*-based, web-accessible platform. There are two audiences for the model output: engineers and planners who want detailed data; and elected councils and the public who want only the big picture. Account access privileges will be tiered as follows:

- ❑ **Public access** will be to the completed product and with limited model flexibility.
- ❑ **Project partners** will have access to developmental models, including opportunities to download model databases.
- ❑ **Scientific authority** will have access to manipulate algorithms, manage and update user profiles.

A distinguishing feature of the WBM is the level of detail that it enables with respect to site design. This provides a significant capability to test 'what if' scenarios related to zoning bylaw changes.

### **Reducing the Volume of Runoff**

Drainage engineers have traditionally thought in terms of flow rates rather than volumes. In fact, at the site level, we need to focus on how much rainfall volume has fallen, how to capture the excess, and what to do with it. British Columbia is leading the way in North America in developing and implementing innovative criteria and methodologies for reducing excess runoff volumes at the source, where rain falls.

## What the Science is Telling Us

A science-based understanding of how land development impacts watershed hydrology and the functions of aquatic ecosystems provides a solid basis for making decisions to guide early action where it is most needed.

The science is explicitly telling us that major biophysical changes occur once the impervious percentage of a watershed reaches about 10%. Beyond this threshold, a change in the water balance may trigger be expected to trigger watercourse erosion, which in turn would degrade or eliminate aquatic habitat. This implies that, where urban land use densities approach this threshold level, the focus should be on what needs to be done at the site level to effectively mimic a watershed with less than 10% impervious area and reduce runoff volumes to similar levels. As documented in the British Columbia Guidebook, the science also indicates that capturing rainfall at the source for the frequent, lower intensity events will in large part help maintain or restore the natural Water Balance.

### *Research on the Effects of Urbanization on Fish*

Aquatic habitats that influence the abundance of salmon and trout are the outcome of physical, chemical and biological processes acting across various scales of time and space. The environmental conditions that result from these processes provide the habitat requirements for a variety of species and life history stages of fish and other stream organisms.

#### **Decline of Wild Salmon**

Whether in pristine or heavily urbanized watersheds, the basic requirements for survival of salmon and trout are the same. These basic requirements include: cool, flowing water free of pollutants and high in dissolved oxygen; gravel substrates low in fine sediment for reproduction; unimpeded access to and from spawning and rearing areas; adequate refuge and cover; and sufficient invertebrate organisms (insects) for food.

Over the past century, salmon have disappeared from over 40% of their historical range, and many of the remaining populations are severely depressed (Nehlsen *et al.* 1991). There is no one reason for this decline. The cumulative effects of land use practices, including timber harvesting, agriculture and urbanization have all contributed to significant declines in salmon abundance in British Columbia (Hartman *et al.* 2000).

#### **Puget Sound Findings**

In the Puget Sound region of Washington State, a series of research projects have been underway for over 10 years to identify the factors that degrade urban streams and negatively influence aquatic productivity and fish survival. The streams and sites under examination represent a range of development intensities from nearly undisturbed watershed conditions to watersheds that are almost completely developed in residential and commercial land uses (Horner 1998).

For each watershed, detailed continuous simulation hydrologic models were prepared and calibrated to rainfall and runoff data. Physical stream habitat conditions, water quality, sediment composition, sediment contamination, and fish and benthic organism abundance and diversity were measured and documented for each site.

The studies found that stream channel instability is a result of the urbanization of watershed hydrology. The alteration of a natural stream's hydrograph is a leading cause of change in instream habitat conditions. The physical and biological measures generally changed most rapidly during the initial phase of watershed

development, as total impervious area changed from 5% to 10%. With more intensive urban development in the watershed, habitat degradation and loss of biological productivity continues, but at a slower rate (Horner 1998).

The role of large woody debris in streams was recognized as a key factor in creating complex channel conditions and habitat diversity for fish. Both the prevalence and quality of large woody debris declined with increasing urbanization. In addition, development pressure has had a negative impact on streamside (riparian) forests and wetlands, which are critical to natural stream functioning.

The impacts of poor water quality and concentrations of metals in sediments did not show significant impact to aquatic biological communities until urbanization increased above approximately 50% total impervious area.

Instream habitat conditions had a significant influence on aquatic biota. Streambed quality, including fine sediment content and channel stability, affected the benthic macro invertebrate community (as measured by the multi-metric Benthic Index of Biological Integrity (B-IBI) developed by Karr (1991)). Negative impacts to fish and fish habitat from sedimentation related to urban development have been documented (Reid *et al.* 1999). The composition of the salmonid community was also influenced by a variety of instream physical and chemical attributes.

### Summary of Puget Sound Findings

Alterations in the biological community of urban streams are a function of many variables representing conditions that are a result of both immediate and remote environmental conditions in a watershed. The research findings clearly demonstrate that the most important impacts of urbanization that degrade the health of streams, in order of importance, are:

- ❑ Changes in hydrology
- ❑ Changes in riparian corridor
- ❑ Changes in physical habitat within the stream, and
- ❑ Water quality

### British Columbia Findings

Within the Georgia Basin of British Columbia, population pressures have caused urban sprawl, resulting in habitat loss (B.C. MELP 2000). Freshwater fish population declines in this region are a partial result of rapidly expanding urban development (Slaney 1996).

The aquatic ecosystems most directly affected by urbanization are the small streams and wetlands in the lowlands of the Georgia Basin and lower Fraser River Valley. These ecosystems are critical spawning and rearing habitat for several species of native salmonids (both resident and anadromous). In the Lower Fraser Valley, 71% of streams are considered threatened or endangered, and a further 15% have been lost altogether as a result of urban growth (B.C. MELP 2000).

## ***A Science-Based Understanding***

The widespread changes in thinking about stormwater impacts that began in the mid to late 1990s reflect new insights in two areas:

- Hydrology, and
- Aquatic ecology

These new insights are the result of improved understanding of the causes-and-effects of changes in hydrology brought about by urban development, and the consequences for aquatic ecology. As we gain new knowledge and understanding of what to do differently, a central issue for watershed protection becomes:

- What is the proper balance of science and policy that will ensure effective implementation and results?

King County in Washington State addressed this question in 1999 as part of the Tri-County response to the listing of chinook salmon as an endangered species in Puget Sound. A significant finding was that scientists and managers think and operate differently. This led to the following recommendations:

- An interface is needed to translate the complex products of science into achievable goals and implementable solutions for practical resource management. This interface is what we now call a science-based understanding.
- A reality for local government is that management decisions need to be made in the face of significant scientific uncertainties about how exactly ecosystems function, and the likely effectiveness of different recovery approaches.
- The best path forward is a dynamic, adaptive management approach that will allow local governments to monitor the effectiveness of their regulatory and management strategies and make adjustments as their understanding grows.
- In a co-evolving system of humans and nature, surprises are the rule, not the exception; hence, resilience and flexibility will need to be built into the management system.

Through a science-based understanding of the relationship between hydrology and aquatic ecology, the British Columbia Guidebook has derived a comprehensive set of water balance, hydrology/water quality and biophysical objectives that provide an over-arching framework for watershed protection.

## ***Eliminate the Source of Problems***

Understanding the cause-and-effect relationship between hydrology and biology has provided the basis for a paradigm-shift in stormwater management in British Columbia - from a traditional approach that only deals with consequences, to one that also eliminates the sources of problems.

Dealing with consequences is the traditional end-of-pipe engineering approach that is reactive in solving problems after the fact. Eliminating the causes of problems involves an integrated approach to source-control that is proactive in preventing problems from occurring.

In addition to being a partner in both the Guidebook and WBM initiatives, the GVRD has also developed *Integrated Stormwater Management Planning - Terms of Reference Template*<sup>6</sup> as part of its regulatory commitment to the Province. The Template supports and encourages the use of the water balance methodology for both greenfield and retrofit watersheds, particularly to assess the effectiveness of stormwater source controls.

## Regulatory Overview

In British Columbia, the *Local Government Act* has vested the responsibility for drainage with municipalities. With the statutory authority for drainage, local governments can be held liable for downstream impacts that result from changes to upstream drainage patterns – both volume and rate. The *Act* also enables local governments to be proactive in implementing stormwater management solutions that are more comprehensive than past practice. Furthermore, a stormwater component is a requirement for approved *Liquid Waste Management Plans* (LWMPs). Guidelines for developing an LWMP were first published in 1992. LWMPs are created by local governments under a public process in co-operation with the Province.

### ***An Official Community Plan Provides the Foundation for a Stormwater Management Plan***

There is a clear link between the land use planning required of local governments in the *Local Government Act* and the LWMP process. In most cases where an *Official Community Plan* (OCP) is in place, the local government planning statement (bylaw) will form the basis for an LWMP. The purposes of an LWMP are to minimize the adverse environmental impacts of the OCP and ensure that development is consistent with Provincial objectives.

OCPs tend to be led by planners, with input from engineers on infrastructure sections. LWMPs tend to be led by engineers, with little or no input from planners. Both processes involve approval by a Local Council or a Regional Board. In some cases, an LWMP process may be a trigger that focuses attention on stormwater management. In other cases, public concern related to flooding or habitat loss may be the trigger. An OCP public process may communicate public interest in raising local environmental and habitat protection standards. Whatever the motivation, at the end of the process an OCP should include goals and objectives for stormwater management. These goals and objectives, or a variant of them, might first reside in an LWMP, and then be adapted to the OCP in the next review process. Or they may originate in the OCP process, and then be detailed through an LWMP. Either approach is entirely acceptable.

### ***Integrated Stormwater Management Planning***

In British Columbia, the term *Integrated Stormwater Management Plan* (ISMP) has gained widespread acceptance by local governments and the environmental agencies to describe a comprehensive approach to stormwater planning. The purpose of an ISMP is to provide a clear picture of how to be proactive in applying land use planning tools to protect property and aquatic habitat, while at the same time accommodating land development and population growth.

## Stormwater Planning: A Guidebook for British Columbia

Stormwater management in British Columbia is a key component of protecting quality of life, property and aquatic ecosystems. The science and practice of stormwater management is constantly evolving, in British Columbia and around the world. Within British Columbia, the range of stormwater management activity varies from completely unplanned in many rural areas, to state-of-the-art in some metropolitan centres. The purpose of *Stormwater Planning: A Guidebook for British Columbia* is to provide a framework for effective stormwater management that is usable in all areas of the province.

The Guidebook presents a methodology for moving from planning to action that focuses the limited financial and staff resources of governments, non-government organizations and the development community on implementing early action where it is most needed. The Guidebook is organized in three parts: Part A defines the problem, Part B provides solutions and Part C defines the process. The Guidebook provides a comprehensive understanding of the issues and a framework for implementing an integrated approach to stormwater management. Case study experience underpins the approaches and strategies that are presented in the Guidebook.

## ***Guidebook Overview***

### **Part A – Why Integrated Stormwater Management?**

Part A identifies problems associated with traditional stormwater management and provides the rationale for a change from traditional to integrated stormwater management. Some guiding principles of integrated stormwater management are introduced. Part A also builds a science-based understanding of how natural watersheds function and how this function is affected by land use change.

### **Part B – Integrated Stormwater Management Solutions**

Part B outlines the scope and policy framework for integrated stormwater management, and presents a three-step, cost-effective methodology for developing stormwater solutions.

*Step #1 - Identify At-Risk Drainage Catchments:* A methodology is presented for identifying at-risk drainage catchments to focus priority action. The methodology relies on a roundtable process that brings together people with knowledge about future land use change, high-value ecological resources and chronic flooding problems. The key is effective integration of planning, engineering and ecological perspectives.

*Step #2 - Set Preliminary Performance Targets:* A methodology is presented for:

- ❑ Developing watershed performance targets based on site-specific rainfall data, supplemented by streamflow data (if available) and on-site soils investigations
- ❑ Translating these performance targets into design guidelines that can be applied at the site level to mitigate the impacts of land development

This portion of the Guidebook also documents British Columbia case studies of stormwater policies and science-based performance targets applied to both greenfield and urban retrofit scenarios.

*Step #3 - Select Appropriate Stormwater Management Site Design Solutions:* Guidance is provided for selecting appropriate site design solutions to meet performance targets source control and runoff conveyance. Case study examples are provided of:

- ❑ Design and performance of stormwater source controls for various land uses
- ❑ Watershed scale modelling of the effectiveness of site design solutions

## Part C – Moving from Planning to Action

Part C describes a process that will lead to better stormwater management solutions. The role and design of action plans are introduced to bring a clear focus to what needs to be done, with what priority, by whom, with related budgets. Tips are provided on processes that produce timely and high-quality decisions. Part C also provides guidance for organizing an administrative system and financing strategy for stormwater management. A final section on building consensus and implementing change describes how to develop a shared vision and overcome barriers to change.

*Two acronyms, ADAPT and CURE, provide a useful summary of the principles and elements of integrated stormwater management, as described below.*

### **ADAPT – The Guiding Principles of Integrated Stormwater Management**

The acronym **ADAPT** summarizes five guiding principles for integrated stormwater management. The Guidebook is based upon these five principles.

- A**gree that stormwater is a resource
- D**esign for the complete spectrum of rainfall events
- A**ct on a priority basis in at-risk drainage catchments
- P**lan at four scales – regional, watershed, neighbourhood & site
- T**est solutions and reduce costs by adaptive management.

#### **Guiding Principle 1 - Agree that Stormwater is a Resource**

Stormwater is no longer seen as just a drainage or flood management issue but also a resource with both benefits and deleterious effects on:

- fish and other aquatic species
- groundwater recharge (for both stream summer flow and for potable water)
- water supply (e.g., for livestock or irrigation)
- aesthetic and recreational uses



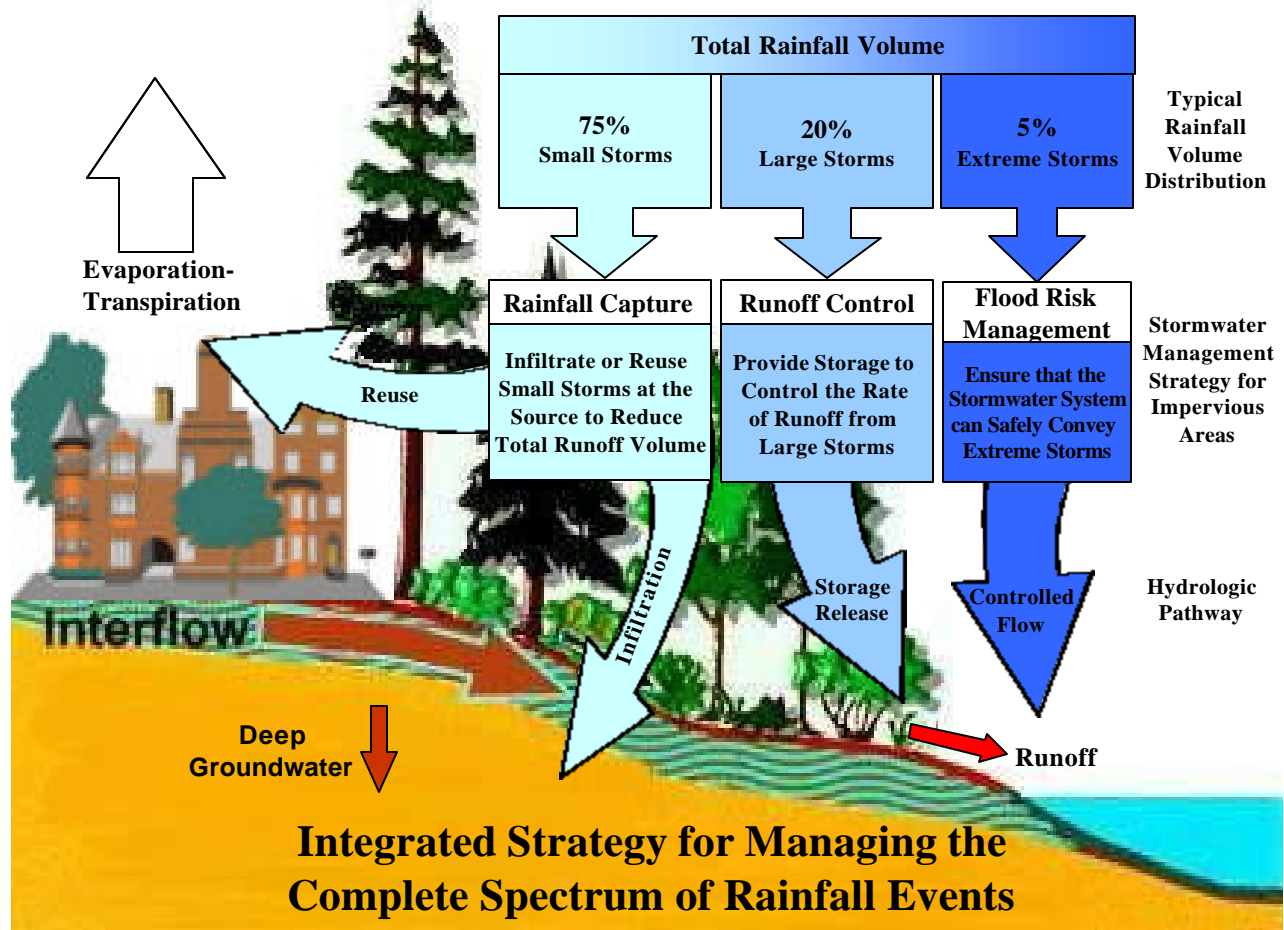
## Guiding Principle 2 - Design for the Complete Spectrum of Rainfall Events

Integrated stormwater solutions require site design practices that provide:

- ❑ **Rainfall Capture for Small Storms (runoff volume reduction and water quality control)** – Capture the low intensity, frequently occurring rainfall events at the source (building lots and streets) for infiltration and/or re-use.
- ❑ **Runoff Control for Large Storms (runoff rate reduction)** – Store the runoff from the infrequent large storms (e.g., a mean annual rainfall), and release it a rate that approximates the natural forested condition.
- ❑ **Flood Risk Management for the Extreme Storms (peak flow conveyance)** – Ensure that the drainage system can safely convey extreme storms (e.g., a 100-year rainfall).

### The Integrated Strategy for Runoff Volume Management

Guiding Principle 2 forms the foundation of integrated stormwater solutions that mimic the most effective stormwater management system of all - a naturally vegetated watershed. The ‘integrated strategy’ for managing the complete spectrum of rainfall events is built around an understanding of the Natural Water Balance. The strategy has three components – *retain* the small frequent events, *detain* the large events, and *convey* the extreme events - as illustrated below.



The WBM enables modelling of all three components of the integrated strategy. It can be used to evaluate how well alternative strategies (including combinations of stormwater source control and off-site detention) can reduce the runoff from development areas, and how this translates into benefits at the watershed level. Source control options include bioretention, infiltration facilities, rainwater capture and re-use, and green roofs. The WBM can also be used to evaluate the impacts of population growth and climate change scenarios.

### ***The Target Condition for a Healthy Watershed***

The target condition for any watershed is defined by the Water Balance, water quality and streamflow characteristics of that watershed with less than 10% impervious area. The target relates to *existing* conditions for relatively undeveloped watersheds (i.e., new development scenarios) and *historical* conditions for developed watersheds (i.e., retrofit scenarios). In order to achieve the target condition, the total annual runoff volume must be limited to 10% (or less) of total annual rainfall volume. This means that 90% of annual rainfall must be returned to natural hydrologic pathways (e.g., infiltration and evapotranspiration) or harvested for re-use. Capturing the frequent small rainfall events at the source will, in large part, maintain or restore the natural Water Balance and achieve the above targets. The Guidebook explains how to achieve the above water balance targets at the site scale, and how to apply the Water Balance Model to assess the feasibility of reducing runoff volume at the watershed scale over time in conjunction with land redevelopment.

### ***Comparison with Conventional Stormwater Management***

Conventional ‘flows-and-pipes’ stormwater management is limited because it focuses only on the fast conveyance of the extreme storms and often creates substantial erosion and downstream flooding in receiving streams. Similarly, a detention-based approach is only a partial solution because it allows the small storms that comprise the bulk of total rainfall volume to continue to create erosion and impacts on downstream aquatic ecosystems. Neither of these approaches fully prevents the degradation of aquatic resources or flooding risks to property and public safety. In contrast, the Guidebook approach is to eliminate the root cause of ecological and property impacts by designing for the complete spectrum of rainfall events. Solutions described in the Guidebook include conventional, detention, infiltration and re-use approaches for rainfall capture, runoff control and flood risk management.

### **Guiding Principle 3 - Act on a Priority Basis in At-Risk Drainage Catchments**

Focus priority action should be focused in at-risk drainage basins where there is both high pressure for land use change and a driver for action. The latter can be either:

- ❑ a high-value ecological resource that is threatened
- ❑ an unacceptable drainage problem

The stormwater management policies and techniques implemented in at-risk catchments become demonstration projects.

#### **Guiding Principle 4 - Plan at Four Scales – Regional, Watershed, Neighbourhood and Site**

Integrated stormwater management must be addressed through long term planning at each of the regional, watershed, neighbourhood and site scales.

- ❑ **At the Regional and Watershed Levels** – Establish stormwater management objectives and priorities
- ❑ **At the Neighbourhood Level** – Integrate stormwater management objectives into community and neighbourhood planning processes
- ❑ **At the Site Level** – Implement site design practices that reduce the volume and rate of surface runoff and improve water quality

#### **Guiding Principle 5 - Test Solutions and Reduce Costs by Adaptive Management**

Performance targets and stormwater management practices should be optimized over time based on:

- ❑ monitoring the performance of demonstration projects
- ❑ strategic data collection and modeling

As success in meeting performance targets is evaluated, the stormwater management program can be adjusted as required.

#### ***CURE – The Elements of an Action Plan***

The acronym **CURE** focuses attention on the four key types of actions that must all work together to implement integrated stormwater management solutions:

- ❑ **CAPITAL INVESTMENT** – Short-term capital investment will be needed to implement early action in at-risk drainage basins. Improvements to existing drainage system are often the most significant capital investments required. A financing plan should provide an ongoing source of funds for watershed improvements.
- ❑ **UNDERSTANDING SCIENCE** – Improved understanding of a watershed, the nature of its problems, and the effectiveness of technical solutions is key to an adaptive approach. Stormwater management practices can be optimized over time through the monitoring of demonstration projects, combined with selective data collection and modeling.
- ❑ **REGULATORY CHANGE** – Changes in land use and development regulations are needed to achieve stormwater performance targets. Changes to land use planning and site design practices are needed to eliminate the root cause of stormwater related problems. These changes must be driven by regulation.
- ❑ **EDUCATION AND CONSULTATION** – Changes to land use planning and site design practices can only be implemented by building support among city staff, the general public and the development community through education and consultation.

## *Translating a Vision into Action*

It is important to establish a long term shared vision at the start of any watershed planning initiative. A vision that is shared by all stakeholders provides direction for a long-term process of change. The vision becomes a destination, and an action plan provides a map for getting there. Action plans must be long term, corresponding to the time frame of the vision. Action plans must also evolve over time. Ongoing monitoring and assessment of progress towards a long term vision will improve understanding of the policy, science and site design components of integrated stormwater management. This improved understanding will:

- ❑ Lead to the evolution of better land development and stormwater management practices
- ❑ Enable action plans to be adjusted accordingly

An adaptive management approach to changing stormwater management practices is founded on learning from experience and adjusting for constant improvement.

### **Building Blocks**

The Guidebook elaborates on three fundamental objectives that become building blocks for a long-term process of change:

- ❑ **Achievable and Affordable Goals** - Apply a science-based approach to create a shared vision for improving the health of individual watersheds over time
- ❑ **Participatory Decision Process** - Build stakeholder consensus and support for implementing change, and agree on expectations and performance targets
- ❑ **Political Commitment** – Take action to integrate stormwater management with land use planning

## **The Water Balance Model: A Tool for Stormwater Source Control Modelling in a Watershed Context**

For the past thirty years, there has been a fixation on peak flow control through the use of detention ponds for all flood events from the 2-year through 100-year floods, and the conveyance of major flood events caused by urban developments of all kinds. The recently developed software focus has been on the user interfaces, but not on the hydrology engine; and certainly not on improvements in the science of infiltration.

Traditional applications of hydrology models reflect “peak flow thinking” at a watershed or macro scale. But the models may not be appropriate for simulating what happens at the site scale, nor for assessing the effects of storm runoff volume changes caused by urban development.

The missing link in urban hydrology has been a tool that quantifies the benefits, in terms of reducing stormwater runoff volume at the site level, of installing source controls under a variety of circumstances. The water balance modeling approach was developed to demonstrate how to meet performance targets for water balance management at the site, neighbourhood, drainage catchment, and watershed scales. The WBM assists local governments to integrate land use planning with volume-based analysis of stormwater management strategies.

The volume-based approach that is being implemented in British Columbia picks up the baton that Dr. Ray Linsley started more than a generation ago. As a professor of Civil Engineering at Stanford University, and later as a consulting engineer, Linsley pioneered the development of continuous hydrologic simulation as the foundation for water balance management. He has received world-wide recognition for his vision and his contributions to the field of hydrology and continuous hydrologic simulation modelling:

- In the 1960s, Linsley championed the paradigm-shift from empirical relationships to computer simulation of hydrologic processes. He had little or no use for “simple hydrology” and the many simple equations that were used to represent the hydrologic cycle.
- Linsley fought a difficult war to replace the established procedures that had been used for many years, and that continue to be used in most urban hydrologic analyses throughout North America and in other locations around the world. He believed that continuous simulation was the only hydrology that should be used for most design and analysis applications.
- Linsley’s pioneering efforts resulted in development of the well-known HSPF Model. This continues to be the hydrologic simulation tool of choice in many parts of North America, notably Washington State where its use is mandated by the Department of Ecology, even though it is a complex model with great data input needs.

Somewhat ironically, the “hydrology engine” for HSPF and other contemporary models (such as SWMM) is based on 1930s and 1940s science. As reported by Linsley in a 1976 article:

- In 1933 - Horton first proposed the concept of infiltration, which is at the heart of continuous simulation.
- In 1934 - Zoch first suggested the use of routing to develop the runoff hydrograph.
- In 1942 - Linsley and Ackerman introduced the idea of continuous soil moisture accounting.

The power of the WBM is in the engine that instantly, interactively, and transparently models hydrologic processes at the site level, including the processes that govern the movement of water through soil and vegetation. This engine incorporates algorithms that simulate how runoff is generated at the site level and generates a continuous simulation of the runoff from a development site, neighbourhood, drainage catchment, or watershed. The WBM simulates five source control categories:

- ❑ Impervious Controls
- ❑ Absorbent Landscaping
- ❑ Infiltration Facilities
- ❑ Green Roofs
- ❑ Rainwater Re-Use

The WBM provides local governments with the means to integrate land use planning with stormwater management. It is a decision support and scenario modelling tool that is used to:

- ❑ Visualize the ‘how to’ details of source control implementation
- ❑ Model scenarios at the site, neighbourhood and watershed scales
- ❑ Make decisions through a scientifically defensible, interactive and transparent process.

The WBM has a wide range of application possibilities, including:

- ❑ Design of volume-based stormwater controls
- ❑ Site performance assessment
- ❑ Evaluating opportunities for urban retrofits
- ❑ Volume-based watershed trading for urban stormwater management
- ❑ Watershed management optimization
- ❑ Analysis of changes in rainfall patterns
- ❑ Public education and outreach

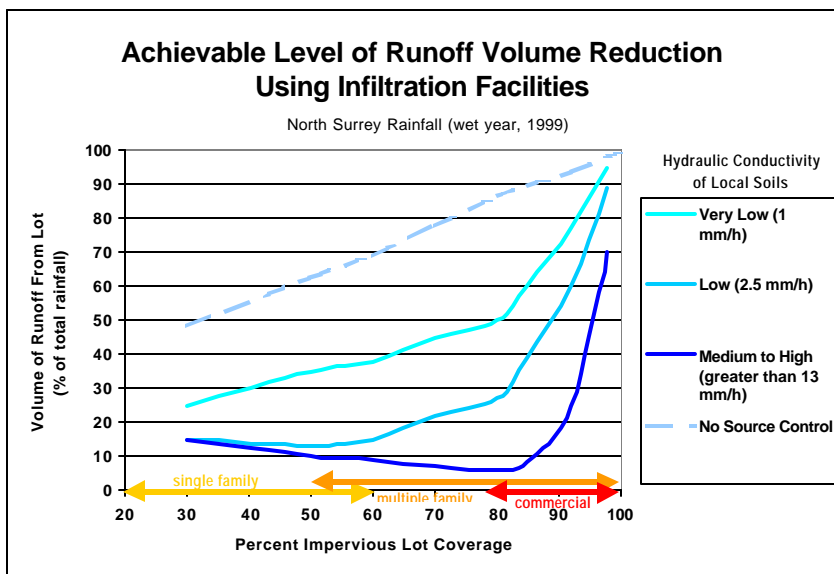
The WBM has enabled evaluation of the hydrologic performance of stormwater source controls (e.g., bioretention, infiltration facilities, rainwater capture and re-use, green roofs) and stormwater detention. It provides a continuous simulation of the runoff, given these inputs:

- ❑ Continuous rainfall data (any time increment)
- ❑ Evapotranspiration data
- ❑ Extent and distribution of land use types
- ❑ Site design parameters for each land use type
- ❑ Soil and groundwater information
- ❑ Information on stormwater controls
- ❑ Seasonal change in rainfall patterns due to climate change

The sensitivity of source control performance to any of these model inputs can be tested by comparing modelled scenarios. The output hydrograph generated by the WBM can become an input to a wide range of hydraulic routing models. WBM hydrographs represent a major improvement over conventional hydrologic simulation. In the Greater Vancouver Region, the WBM has been used to assess the potential for urban watershed restoration over a 50-year timeframe. The WBM has made it possible to:

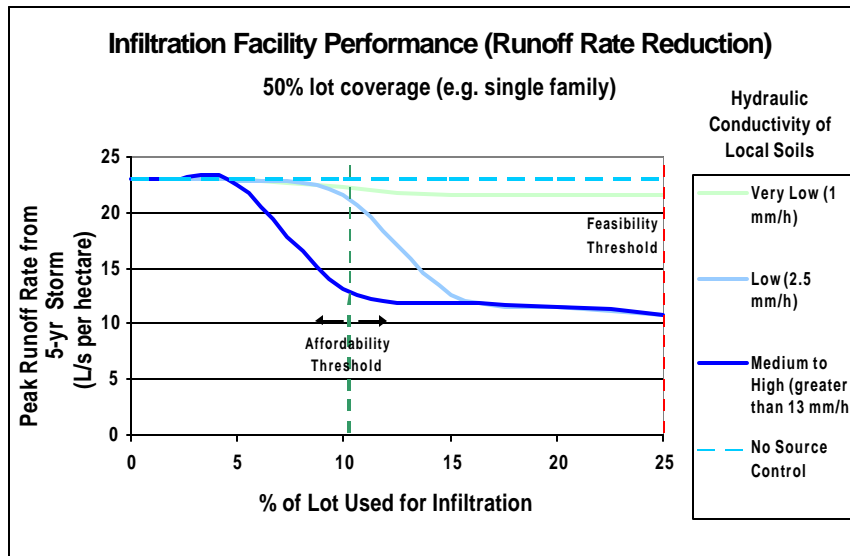
- ❑ Identify affordability and feasibility thresholds
- ❑ Develop evaluation criteria for cost-benefit analysis
- ❑ Generate watershed-specific performance relationships

The following figures illustrate the types of relationships that have been developed using the WBM, and that are presented in the Guidebook:



Where soils have medium or better hydraulic conductivity, runoff volume could be reduced to about 10% of total rainfall for all but the highest coverage land uses.

Significant levels of runoff volume reduction can also be achieved in soils with poor hydraulic conductivity.



Reductions in runoff rates using infiltration facilities depend on the hydraulic conductivity of local soils and the amount of area provided for infiltration.

Affordability thresholds govern infiltration facility sizes for lower surface coverage land uses, and feasibility thresholds govern for higher coverage land uses.

## Summary

Recent stormwater initiatives in British Columbia include:

- ❑ Publication of *Stormwater Planning : A Guidebook for British Columbia*
- ❑ Publication of *Integrated Stormwater Management Planning - Terms of Reference Template*
- ❑ Development of the *Water Balance Model for British Columbia*
- ❑ Evaluation of *Stormwater Source Control Effectiveness* at the site, neighborhood and watershed scales

To protect property, aquatic habitat and water quality, British Columbia has:

- ❑ Recognized the logical link between surface runoff volume and impacts on watershed health
- ❑ Embraced the integration of land use planning with stormwater management
- ❑ Established performance objectives for designing communities that function hydrologically like naturally forested systems

The paradigm-shift from an approach that only deals with consequences, to one that also eliminates the causes, has resulted in a re-invention of urban hydrology:

- ❑ There was a need for a tool that realistically simulates how runoff is actually generated at the site level
- ❑ The WBM is a stormwater planning and site design tool that evolved in two stages:
  - Initially through the Burnaby Mountain Project – to achieve watershed protection objectives
  - Subsequently through the GVRD Project - to evaluate the effectiveness of a range of source control options (e.g., absorbent landscaping, infiltration facilities, rainwater re-use, green roofs) under a range of operating conditions (i.e., land use, soil and rainfall)

## Conclusion

The *Water Balance Model for British Columbia* provides an effective decision support tool for local governments to integrate land use planning with stormwater management, and to evaluate the potential for developing or re-developing *communities that function hydrologically like naturally forested or vegetated systems*. The tool creates an understanding of *how*, and *how well*, stormwater source control strategies for runoff reduction would be expected to achieve watershed protection and/or restoration objectives.

## Bibliography

The following is a partial list of publications on the aquatic impacts from urban development and stormwater in British Columbia and Washington State:

- BC Ministry of Environment, Lands and Parks and Environment Canada. 2000. Water Quality Trends in Selected British Columbia Waterbodies. <http://wlapwww.gov.bc.ca/wat/wq/trendsWQS/index.html>
- BC Ministry of Environment, Lands and Parks. 2000. Environmental Trends in British Columbia, 2000. <http://wlapwww.gov.bc.ca/soerpt/>
- Hartman, G.F., Groot, C., and Northcote, T.G. 2000. The Ball is Not in Our Court. *In Sustainable Fisheries Management: Pacific Salmon. Edited by E. Eric Knudsen, C.R. Stewart, D.D. MacDonald, J.E. Williams and D.W. Rieser.* Lewis Publishers, Boca Raton, FL. pp. 31-49.
- Horner, Richard, and May, C. 1998. Watershed Urbanization and the Decline of Salmon in Puget Sound Streams. *In Salmon in the City May 20-21, 1998, Mount Vernon Washington, Abstracts. Edited by Anonymous.* pp. 19-40.
- Karr, J.R. 1991. Biological Integrity: A long neglected aspect of water resources management. *Ecological Applications* 1(1): 66-84 *in* Horner, Richard, and May, C. 1998. Watershed Urbanization and the Decline of Salmon in Puget Sound Streams. *In Salmon in the City May 20-21, 1998, Mount Vernon Washington, Abstracts. Edited by Anonymous.* pp. 19-40
- Nehlsen, W. Williams, J.E. and J.A. Lichatowich. 1991. Pacific salmon at a crossroads: stocks at risk from California, Oregon and Washington. *Fisheries*. Vol 16, No.2 American Fisheries Society. Bethesda, MD. Pp 4-21.
- Reid G., and Michalski, T. 1999. Status of Fish Habitat in East Coast Vancouver Island Watersheds. *In At Risk. Proceedings of a Conference on the Biology and Management of Species at Risk. Edited by L. Darling.* BC Ministry of Environment, Lands and Parks, Victoria, BC. pp. 355-367.
- Slaney, T.L., Hyatt, K.D., Northcote, T.G., and Fielden, R.J. 1996. Status of Anadromous Salmon and Trout in British Columbia and Yukon. *American Fisheries Society* 21: 20-35.

---

<sup>1</sup> IGP Liaison & Project Coordinator

<sup>2</sup> Chair, British Columbia Inter-Governmental Partnership for Development of a Water Balance Model

<sup>3</sup> Co-chair, Inter-Agency Steering Committee for Stormwater Planning Guidebook; and  
Co-chair, British Columbia Inter-Governmental Partnership for Development of a Water Balance Model

<sup>4</sup> Facilitator, Greater Vancouver Regional District Stormwater Inter-Agency Liaison Group

<sup>5</sup> The Stormwater Planning Guidebook is available on the Ministry's website at :  
<http://wlapwww.gov.bc.ca/epdpa/mpp/stormwater/stormwater.html>

<sup>6</sup> Integrated Stormwater Management Planning Terms of Reference Template, prepared by KWL for the GVRD, 2002.  
<http://www.gvrd.bc.ca/services/sewers/drains/Reports>



## **Development of the San Diego Creek Natural Treatment System**

Eric Strecker, GeoSyntec Consultants, Portland, OR, estrecker@geosyntec.com

Peter Mangarella, GeoSyntec Consultants, Walnut Creek, CA, pmangarella@geosyntec.com

Norris Brandt, Irvine Ranch Water District, Irvine, CA, brandt@irwd.com,

Todd Hesse, GeoSyntec Consultants, Portland, OR, thesse@geosyntec.com

Rachata Muneeppeerakul, GeoSyntec Consultants, Walnut Creek, CA, rmuneeppeerakul@geosyntec.com

Klaus Rathfelder, GeoSyntec Consultants, Portland, OR, krathfelder@geosyntec.com

Marc Leisenring, GeoSyntec Consultants, Portland, OR, mleisenring@geosyntec.com

### **ABSTRACT**

A Natural Treatment System (NTS) Master Plan that includes a watershed-wide network of constructed wetlands was evaluated for treatment effectiveness of dry weather base flows and runoff from smaller more frequent storms in a 120 square mile (311 km<sup>2</sup>), urban watershed. The goal of the 'regional retrofit' wetland network is to serve as an integral component in watershed-wide BMPs for compliance with pollutant loading limits (TMDLs) requiring discharge limits of sediments, nutrients, pathogen indicators, pesticides, toxic organics, heavy metals, and selenium. The NTS Plan was assessed with 'planning-level' water quality models that account for the integrated effects of the planned 44 NTS facilities. The NTS Plan is estimated to achieve total nitrogen (TN) TMDL for base flows and reduce in-stream TN concentrations below current standards at most locations. Total phosphorous TMDL targets would be met in all but the wettest years. The fecal coliform TMDL would be met during the dry season, but not all wet season base flow conditions, and not under storm conditions. The NTS Plan is not designed to meet the sediment TMDL, but would capture, on average, about 1,900 tons/yr (1,724,000 kg/yr) of sediment from urban areas. The wetlands are estimated to remove 11% of the total copper and lead, and 18% of the total zinc in storm runoff. The NTS Plan provides a cost-effective alternative to routing dry-weather flows to the sanitary treatment system.

### **Introduction**

San Diego Creek and Newport Bay in Orange County, California have been identified as having impaired surface water quality under California State and U.S. Environmental Protection Agency (USEPA) regulations. The creek and the bay receive runoff from storm events and from agricultural and urban activities in the San Diego Creek Watershed, in addition to natural flows. Federal regulations for impaired water bodies require the establishment of and compliance with discharge limits for the pollutants that are determined to be causing the impairments. These limits are called total maximum daily loads (TMDLs), and are linked to discharge permits established under the National Pollutant Discharge Elimination System (NPDES).

Orange County and NPDES co-permittees, including the local municipalities, are seeking comprehensive solutions for meeting the TMDL requirements. As a component of this effort, the Irvine Ranch Water District (IRWD) has developed a Natural Treatment System (NTS) Plan. The NTS Plan addresses runoff water quality from a watershed-wide perspective, utilizing a network of constructed wetlands. The NTS Plan would build on IRWD's successful use of constructed wetlands by expanding their use throughout a highly urbanized and nearly fully developed watershed. The NTS Plan, therefore, is viewed as an urban

retrofit using constructed wetlands as an integral component for compliance with TMDL requirements. The advantage of the NTS system to IRWD, the primary provider of sanitary and potable water services for the watershed, is avoiding the increasingly costly trend in Southern California of routing low flows to sanitary treatment systems.

This paper describes the NTS Plan, the evaluation approach, and the evaluation results of the Plan’s effectiveness for contributing to TMDL compliance. An example of the NTS retrofit concept is provided at the end of the paper.

### **Project Area**

*Setting.* The San Diego Creek Watershed is located in Orange County, California (Figure 1) and covers approximately 120 square miles (311 km<sup>2</sup>). The watershed is drained by Peters Canyon Wash and San Diego Creek, and by a number of smaller channels and drainages. San Diego Creek flows into Upper Newport Bay, which contains the 752-acre (3.04 km<sup>2</sup>) Upper Newport Bay Ecological Reserve, one of the largest remaining coastal estuaries in Southern California. The San Diego Creek Watershed drains almost 80% of the 154 square miles (398.9 km<sup>2</sup>) that are tributary to Upper Newport Bay.

The western and central portions of the watershed are a relatively flat alluvial plain, bordered by the Santiago Hills to the northeast and the San Joaquin Hills to the south. The alluvial plain rises gently from sea level at Upper Newport Bay to about 400 ft (122 m) above mean sea level (msl) at the El Toro Marine Base. The peak elevation in the Santiago and San Joaquin Hills is 1,775 ft (541 m) and 1,160 ft (355 m) above msl, respectively.

The climate is characterized by warm dry summers, and cool intermittently wet winters. The main wet season is from November to April during which widespread general winter storms may last for several days. The average annual rainfall is about 13 inches per year, with 90% occurring in the wet season. Average base flows in San Diego Creek are less than 16 cfs (0.45 cms) during dry weather. The estimated peak 100-year flood discharge is 42,500 cfs (1,203 cms) in San Diego Creek at Newport Bay.

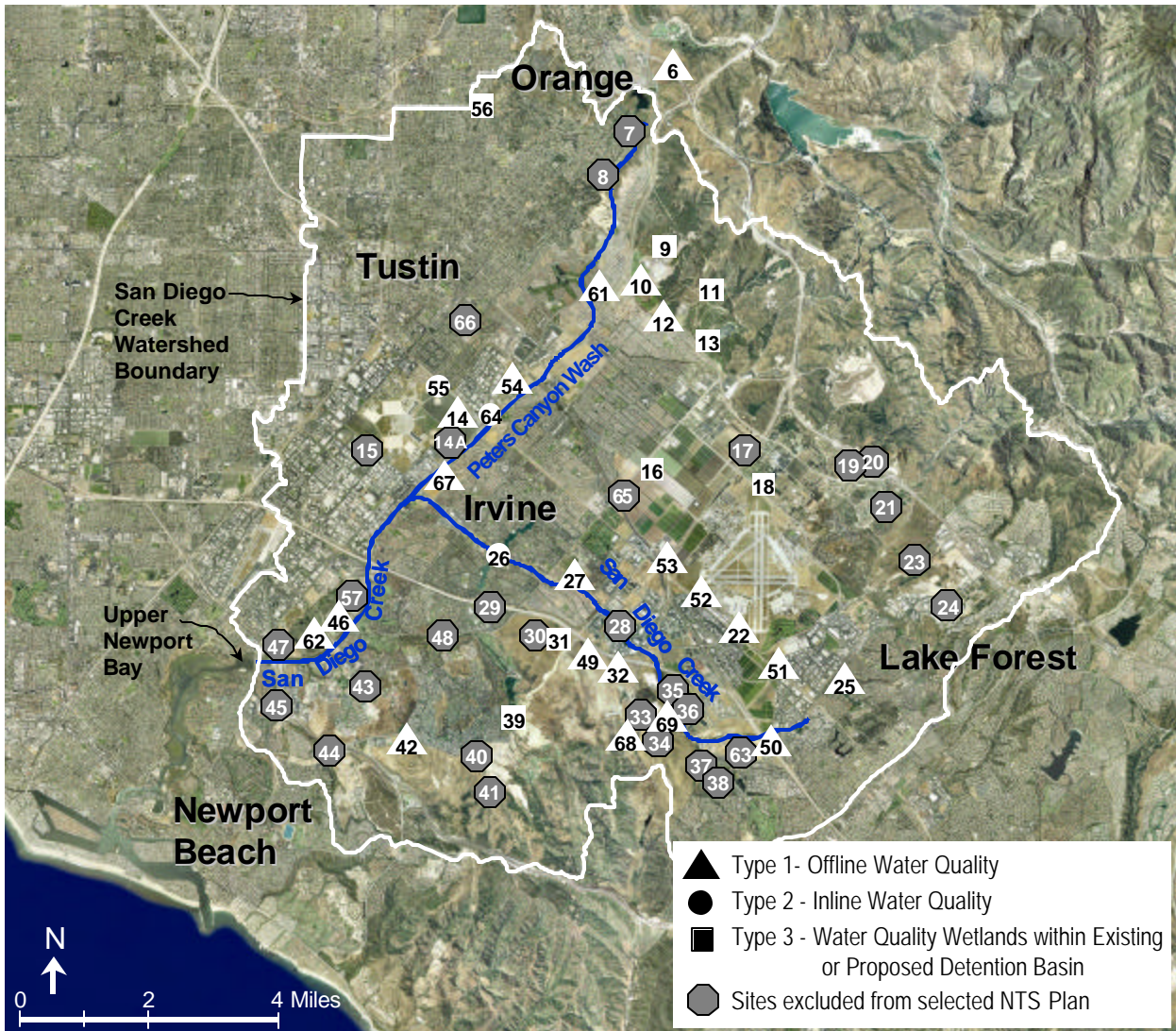
**Table 1:** Estimated existing and fully developed land uses acreages in the San Diego Creek Watershed.

<b>Land Use</b>	<b>Existing (acres)</b>	<b>Estimated when fully developed (acres)</b>	<b>% Change of watershed from existing to fully developed</b>
Agriculture	11,510	1080	-13.7
Urban <sup>1</sup>	40,210	52,160	+15.6
Open <sup>2</sup>	24,690	23,170	-2.0

<sup>1</sup> Urban is the sum of commercial/light industrial, industrial, mixed use, all residential, roads, and transportation corridors.

<sup>2</sup> Open is the sum of open space-preserve, open space-other, parks, golf courses, and water land use categories.

*Land Use.* The San Diego Creek Watershed experienced rapid growth and development after World War II. Land-use estimates show that most of the developable lands in the watershed are currently developed (Table 1), with about 15 percent remaining. Much of remaining development would come from continued conversion of agricultural land and from land-use conversion of recently decommissioned military bases.



**Figure 1:** Aerial photograph of the San Diego Creek Watershed showing the locations of NTS Facilities and the types of wetland facilities.

### ***Water Quality Issues and Regulatory Requirements.***

Coinciding with rapid growth and development over the past 50 years, water quality in San Diego Creek and Newport Bay has been affected by:

- Excessive sediment loads and sedimentation in Upper Newport Bay, impacting beneficial uses of the bay and wildlife habitat;
- Excessive nutrient concentrations, primarily nitrate from fertilizers, which contribute to the formation of algae blooms in Newport Bay;
- Elevated fecal coliform concentrations in the Newport Bay, especially in storm runoff, which impact shellfish harvesting and recreational uses;
- Elevated concentrations of toxics in portions of Newport Bay, primarily the pesticides Diazinon and Chlorpyrifos, which contribute to acute and chronic toxicity;

- Elevated concentrations of heavy metals in portions of Newport Bay, primarily copper, which “may be causing, or contributing to, toxicity to aquatic life” (RWQCB, 2000); and
- Elevated concentrations of selenium in San Diego Creek from natural origins, with the major source thought to originate from groundwater discharge to San Diego Creek in areas of a historic ephemeral lake in Peters Canyon Wash

Water quality has been affected by both low-flows resulting from irrigation return flows, car washing, and groundwater recharge to streams, as well as stormwater discharges. Dry weather flows have increased with urbanization of open space and remained about the same, as compared to agricultural activities. The normal generalization that urbanization dries up base flows is typically not true in southern California because irrigation levels significantly exceed natural rainfall. These low flows have caused leaching of pollutants from soils, as well as transport of dissolved nutrients from planted areas.

As a result of these water quality problems, Newport Bay has been designated as an impaired water body by the State of California. In response, TMDLs have been established or drafted for the impairing pollutants (Table 2) (USEPA, 1998a,b; 2002). To address TMDL requirements, Orange County and local municipalities have implemented an array of Best Management Practices (BMPs) for load reduction, regional monitoring activities for the assessment of BMP effectiveness, and public education and coordination efforts. These activities are generally directed towards source control and do not fully address regional treatment needs for compliance with the TMDL requirements.

**Table 2:** A listing of the constituents included in the San Diego Creek TMDLs, general information about each, and the TMDL loading limits for watershed land uses.

Constituent	General Information	TMDL
Sediment	Load is strongly correlated with rainfall. Annual average load estimate: 250,000 tons; 1998 load was 620,000 tons.	62,500 tons/year to Newport Bay, 62,500 tons/year to the rest of the watershed, based on a 10-year running average.
Nutrients (TN and TP)	Declining trends in 1990's 1986 TN load = 1,448,000 lbs 1998 TN load = 632,000 lbs	Annual total load targets: 298,225 lbs Total Nitrogen/year by 2012 62,080 lbs Total Phosphorus/year by 2007
Pathogens	Fecal coliform bacteria used as an indicator. Goal is to achieve contact recreation standards by 2014.	5 samples/30-days with a geometric mean concentration of 200 organisms /100mL, and no more than 10% of the samples to exceed 400 organisms/100mL
Selenium (draft)	Natural sources from groundwater discharge and surface runoff 1998/99 estimate: 3,248 lbs/year	Annual total load targets = 891.4 lbs. Loads are partitioned into four flow tiers.
Heavy metals	Loads highly variable with rainfall: Total load (lbs) <u>1998</u> <u>1999</u> Copper 15,087 1,643 Lead 10,385 449 Zinc 63,021 3,784	Concentration based TMDLs expressed at four flow tiers. Concentrations are based on the California Toxics Rule objectives using average hardness values of the associated flow tier
Chlorpyrifos & diazinon	Widely used pesticides that are currently being phased out for non-commercial use. Both exceed the chronic concentration criteria in base flow and storm flow conditions.	SD Creek acute and chronic concentration targets, respectively, by 2005: Diazinon - 80 & 50 ng/L Chlorpyrifos - 20 & 14 ng/L
Organochlorine compounds	Legacy compounds that tend to bioaccumulate and have considerable persistence in soils, sediments, and biota. Sources are unknown.	Annual load limits to Newport Bay (g/yr): Chlordane = 346.2; Dieldrin = 287.7; DDT = 475.9; PCBs = 310.3; Toxaphene = 9.8

## **Natural Treatment System Plan**

### ***Plan Development***

Various treatment-type control options were evaluated in developing the NTS strategy, including: (1) on-site controls for new development; (2) complete or partial diversion of dry weather base flows and portions of wet weather discharges to the sanitary sewer system; and (3) a regional treatment approach.

Given the urbanized nature of the watershed, a strategy that focuses on on-site controls for new development (or re-development) could not, by itself, meet regulatory requirements in a timely manner, since that strategy would not address pollutants associated with existing urbanization in the San Diego Creek Watershed, nor disperse sources such as groundwater discharges. Diversion of streamflow to the sanitary sewer was determined to be mostly infeasible, given the stringent total dissolved solids requirements for water recycling (an important IRWD water conservation tool), the cost for providing storage and treatment for the large volumes of water, and the need to maintain in-stream flows for riparian habitat and wildlife.

The NTS approach, based on a regional network of constructed wetlands, was determined to be the best strategy for addressing regional water quality treatment needs because: (1) constructed wetlands are an effective and cost-competitive approach for water quality treatment, based on the experience and success of the existing IRWD constructed wetlands in the San Joaquin Marsh (a low-flow treatment marsh already operated by IRWD near Upper Newport Bay), as well as other wetlands both regionally and nationally; (2) constructed wetlands address pollutant sources from existing and future development, as well as disperse sources; and (3) constructed wetlands can enhance habitat and natural resources in the watershed.

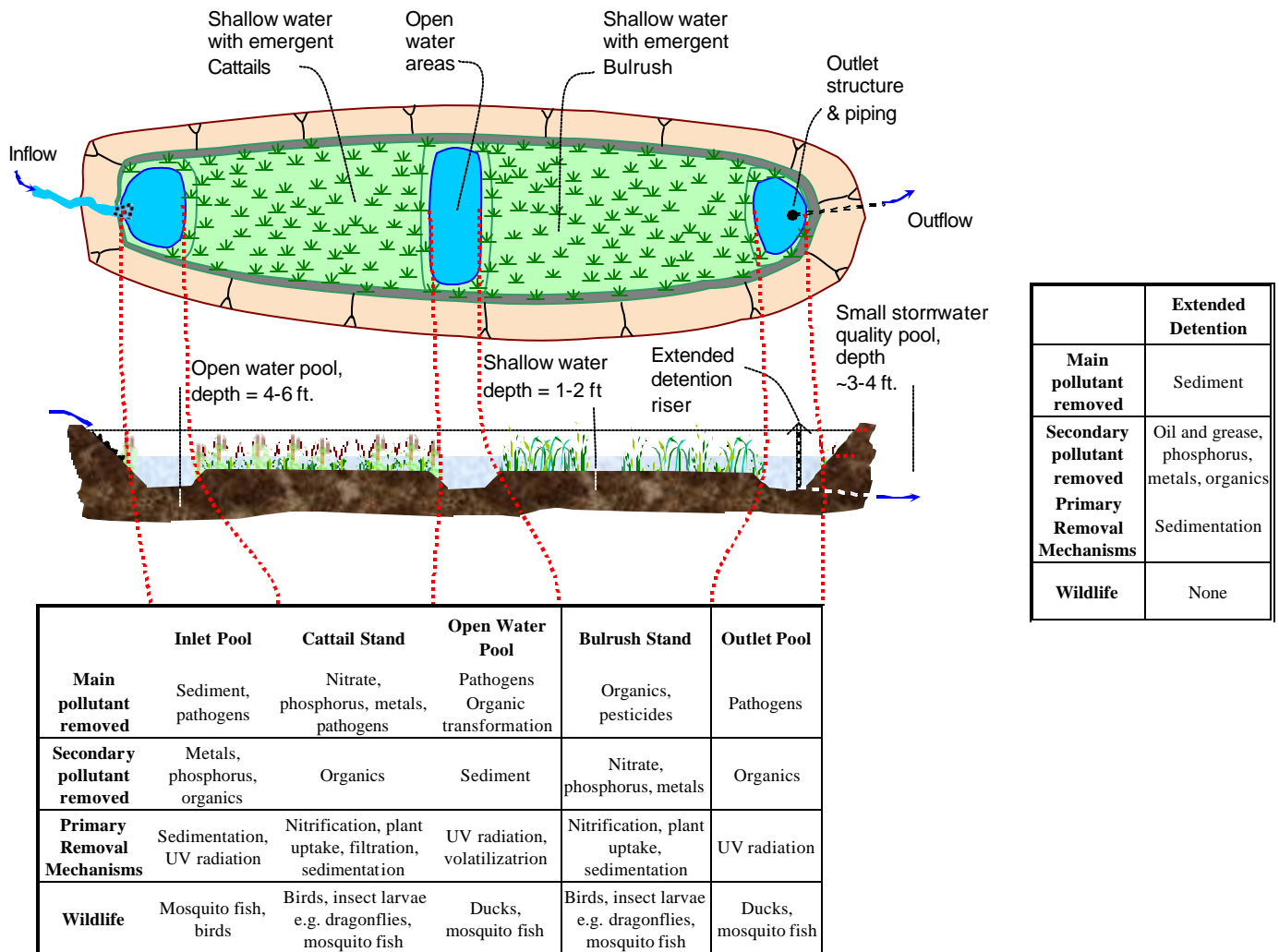
### ***Constructed Wetlands***

The facilities envisioned in the NTS Plan are constructed wetlands to improve the water quality of dry weather base flows and the runoff from smaller storms. Constructed wetlands are engineered systems designed to improve water quality by taking advantage of processes occurring in natural wetlands, but in a more planned and controlled system. Constructed wetlands have evolved and gained acceptance during the past 25 years as a practical and cost-effective means for advanced treatment of municipal wastewater and for treatment of urban runoff (Kadlec and Knight, 1996; Strecker, 1996).

A local example is the IRWD constructed wetlands at the San Joaquin Marsh near the mouth of the San Diego Creek Watershed. The IRWD constructed wetlands consists of five treatment cells with 45 acres of open water and 11 acres of marshland vegetation. Water is pumped from San Diego Creek into the wetlands at an average rate of about 7 cfs and has a retention time of about two weeks. Monitoring data indicate that about 200 lbs (91 kg) of nitrate are removed per day during dry weather, reducing the total load to Upper Newport Bay by about 30%. The strategy of the NTS Plan is to expand the success of the IRWD wetlands throughout the San Diego Creek Watershed.

### ***Facility Designs***

Each of the over 40 NTS facilities will be tailored to local conditions and constraints; however, most of the NTS facilities share common design features (see Figure 2). Throughout most of the year the water quality wetlands will primarily treat low flows because rainfall events are infrequent in Orange County (10-15 events per year over 0.1 inch (0.25 cm)). During non-storm conditions, water levels in the typical wetlands will be in two general regimes:



**Figure 2:** Generic Design and Removal Mechanisms of NTS Facilities, showing a plan view and providing information on intended pollutant removals in each sub-area of the wetland.

**Open water regions** typically 4-6 ft (1.2-1.8 m) deep are intended to help distribute the flow uniformly through the wetland vegetation and to trap coarse sediments. These areas are most effective at removing sediments and pollutants associated with sediments such as phosphorus, metals, and some organic compounds. Open water areas also facilitate destruction of pathogens by exposing them to sunlight.

**Shallow water regions** 1-2 ft (0.3-0.6 m) in depth are intended to support the growth of emergent wetland vegetation, primarily cattails and bulrushes. These areas are most effective at removing nutrients, and to a lesser extent metals, pathogens, and toxic compounds.

The time required to obtain effective pollutant removal during low flows is estimated to be typically 7-14 days, depending on site conditions and temperature (Kadlec and Knight, 1996). Most NTS sites are designed for a 10-day retention time during low flow conditions.

Sediments and pollutants that tend to attach to sediments are primarily transported by higher flows from storm events. Many of the NTS facilities are designed to detain and treat stormwater runoff by means of reduced flow outlets that drain the stormwater over a period of about 36 hours. The depth of the stormwater

quality pool is typically 3-4 ft (0.9-1.2 m) above the normal low flow water level (Figure 2), thus inundating the wetland vegetation. Wetland vegetation would not be destroyed by inundation for short detention periods.

Removal of pollutants from storm runoff will primarily occur by settling processes. Therefore the primary pollutants removed from storm runoff are sediments and pollutants associated with sediments such as phosphorus, metals, and some organic compounds. There will be little or no removal of dissolved nutrients (e.g., nitrate) during detention of storm runoff.

Habitat enhancement is an important aspect of the NTS Plan. The selection and planting of riparian vegetation between the wetlands and the surrounding habitat affects the habitat characteristics of the wetlands. Where feasible, native riparian vegetation will be selected to enhance habitat for endangered avian species.

San Diego Creek has consistently high levels of selenium, which originate from natural sources. A major source of selenium is groundwater discharge to the San Diego Creek in a historical ephemeral lake and marsh region. Selenium was historically immobilized and trapped in the marsh due to the presence of reduced anoxic conditions. Drainage of the swamp in the early 1900's for agriculture allowed oxygenated groundwater to flow through the marsh, creating soluble and mobile forms of selenium that are now being flushed to the creek

Elevated selenium levels must be reduced in accordance with the draft TMDL for selenium. To address the TMDL, the NTS Plan includes one facility for selenium removal (Site 67) located in the historical ephemeral marsh region. The selenium treatment concept is to mimic the selenium sequestering processes that occurred in the historical marsh in a subsurface flow treatment wetland. Stream water would be diverted through organic rich native soils under anoxic conditions, creating reduced forms of selenium that are immobilized by sorption to the soil particles.

### ***Facility Selection***

Potential NTS sites were selected using a simple screening process. Staff at IRWD developed an initial list of potential sites based on their knowledge of the watershed and information contained in their databases. Following field visits, the initially selected sites were assessed by preliminary technical analyses and institutional and community acceptance assessments. This process was followed by successive rounds in which some sites were removed from further consideration, due to technical constraints or other considerations, and replaced with new sites. In total, more than 60 sites were considered for the NTS Plan, of which 44 were retained for detailed assessment. The location of all NTS sites is shown in the aerial photograph in Figure 1.

The NTS facilities are categorized by their location in reference to stream channels and whether they are being added to a flood retarding basin: Type I off-line facilities are adjacent to existing channels and require diversion structures for influent and effluent to the facility; Type II in-line facilities are wetlands that are established within existing stream channels; and Type III facilities are established within existing or planned retarding basins, and make use of the local storm drains.

## Evaluation of the NTS Plan

The NTS Plan was evaluated using planning-level water quality models that primarily rely on local hydrologic and water quality data, and data collected on the performance of local and national wetlands. The purpose of the water quality models was to provide planning-level assessments of the NTS Plan alternatives, and to evaluate the NTS contribution to TMDL compliance. The modeling strategy used to evaluate the NTS Plan is summarized in the following steps:

1. Forecast future land uses: The NTS Plan was evaluated under the assumptions of complete development in the watershed (“build-out” conditions) and full implementation of the NTS facilities. The intent was to obtain a measure of the total effectiveness of the NTS Plan under ultimate watershed conditions. Build-out land use conditions were estimated from zoning maps and local agency land-use plans.
2. Forecast hydrology and pollutant loads under build-out conditions: Estimates of flow conditions and pollutant loads were forecasted for future land use conditions using available monitoring information and statistical correlations between current and projected land uses. In cases where there was insufficient monitoring data, land-use based pollutant load estimates were developed from regional monitoring information.
3. Estimate load reductions in the NTS facilities: Water quality models were developed to estimate pollutant loads and load reductions occurring in individual NTS facilities and as a network of NTS facilities. The water quality models take into account the interrelationships of individual facilities that occur when pollutant removals in up-stream facilities affect pollutant loads at down-stream facilities. Separate models were developed for low flow and storm flow conditions and different pollutants were modeled for different flow regimes, depending on the pollutant characteristics and TMDL requirements.

*Low Flow Conditions:* Load reduction estimates for low flow conditions were modeled as a first order kinetics process using coefficients derived from data collected at local constructed wetlands. Seasonal rate coefficients were used to account for temperature differences. Flow and load estimates included evaporation losses, and pollutant contributions from groundwater discharge to stream channels. Pertinent assumptions are summarized in Table 3..

*Storm Conditions:* The treatment effectiveness of runoff from storm events was assessed on an average annual basis. A 21-year period of recorded rainfall was used to estimate: the annual runoff quantities. Pollutant concentrations were estimated with the event mean concentration (EMC) values from available local and regional monitoring information. Load reduction was estimated with data from the USEPA’s Nationwide BMP database (ASCE, 2001; Strecker et. al., 2001). Pertinent assumptions are summarized in Table 4.



**Table 3:** Approach and Assumptions used in the Low Flow Model.

<b>Parameter / Process</b>	<b>Assumption / Approach</b>
Load reduction	Evaluated with a first-order kinetics model with background concentration.
Steady state	Seasonal average steady state conditions were assumed.
Atmospheric sources	Water and pollutants from atmospheric sources were assumed negligible compared with influents flows and loads.
Stream flow	Estimated with seasonal based empirical relationships that account for projected land-use and groundwater contributions. Equations were developed by regression analysis using available stream flow data and geographical information.
Evapotranspiration	Estimated with available monthly average reference evapotranspiration.
Infiltration	Assumed negligible based on planned use of liners in areas with poor soil conditions.
Background concentration	1 mg/L for total nitrogen; 50 MPN/100 mL for fecal coliform bacteria
First-order rate constant	TN removal: 0.55 and 0.25/day for the dry and wet seasons, respectively. Fecal coliform: 75 m/year (area based)
Residence time	7-14 days
Open water ratio	Open water areas constitute 20% of the wetlands, except near airports where no open water areas were included.
Period of operation	165 days in the dry season; 150 days in the wet season
Influent concentration	Average seasonal concentrations estimated from available monitoring information

**Table 4:** Approach and Assumptions used in the Storm Flow Model.

<b>Parameter / Process</b>	<b>Assumption / Approach</b>
Annual model	Uses annual rainfall depths to estimate annual runoff volume and pollutant loads.
Sediment sources	Post-construction sediment sources from urban and open space areas. Does not address in-stream sediment sources.
Annual rainfall depth	Determined from monthly rainfall records. Rainfall was reduced by a correction factor to account for events that produce no appreciable runoff.
Runoff volume	Estimated as a function of land-use with the rationale formula where the runoff coefficient is expressed as a linear function of percent imperviousness.
Stormwater pollutant concentrations	Estimated with land-use based Event Mean Concentration (EMC) values from available local and regional stormwater monitoring data.
Capture efficiency	Estimated by routing stormwater runoff volumes obtained from hourly rainfall data through the NTS facilities. Different routing rules were used depending on the facility type.
Background concentration	1 mg/L for total nitrogen; 50 MPN/100 mL for fecal coliform bacteria
BMP performance	Data available from the USEPA's Nationwide BMP data was assumed to be representative of the treatment performance in the NTS facilities.

### ***Estimated Nitrogen Removal***

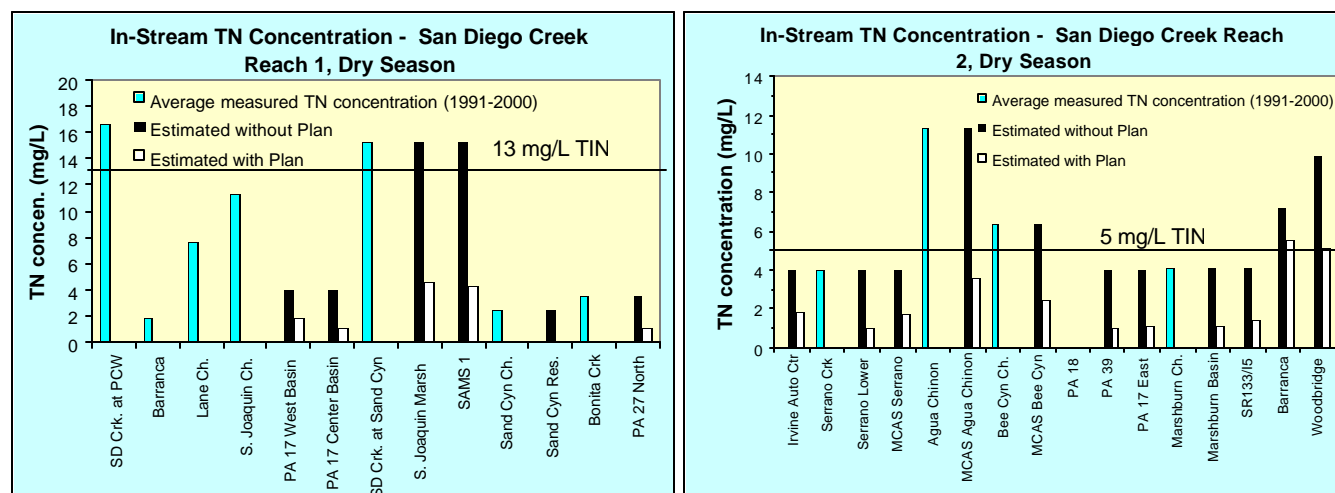
Nitrogen removal was modeled only for low flow conditions, consistent with the TMDL requirements. The modeling results indicate that the NTS facilities would remove about 227,500 lbs (103,200 kg) of total nitrogen (TN) annually, and that both dry and wet season TMDLs would be met (Table 5). In general, wet-season TMDLs are more difficult to achieve because loads are higher in the wet season and removal rates are smaller due to lower temperatures and resulting biochemical activity.

The modeling results reveal that a large proportion of the TN removal occurs at the larger sites located in the downstream reaches of the watershed. Smaller sites distributed in the upstream reaches remove less TN on a percentage basis, but contribute to the improvement of 'local' in-stream water quality. Model

predictions indicate the NTS Plan would significantly reduce in-stream TN concentrations (Figure 3), meeting water quality objectives at nearly all locations.

**Table 5:** Summary of Estimated TN Loads to Newport Bay that show that TMDL loading limits are predicted to be met by implementation of the NTS Plan.

Load to Newport Bay	Dry Season Low Flow	Wet Season Low Flow
<b>Without Plan (lbs/season)</b>	<b>200,000</b>	<b>237,500</b>
<b>Load Removed by NTS (lbs/season)</b>	<b>119,500</b>	<b>108,000</b>
<b>With Plan (lbs/season)</b>	<b>80,500</b>	<b>129,500</b>
<b>TMDL (lbs/season)</b>	<b>153,861 (2007)</b>	<b>144,364 (2012)</b>



**Figure 3.** Measured and estimated In-stream TN Concentrations at various locations throughout the watershed.

***Estimated Sediment and Phosphorus Removal.***

Monitoring data indicate that sediment loads are strongly linked to winter storm flows and that highest sediment loads occur in above average rainfall years. Sediment reduction was therefore modeled only for storm flow conditions. However, not all sediment sources were modeled as indicated in Table 6. By far, the majority of the sediment loads are associated with channel erosion and scouring from in-stream sediment basins, although the TMDLs do not recognize this major source directly. In-stream sediment sources were not modeled because they are being managed through the implementation of the Sediment Control Section 208 Plan. Only urban and open space land surface sources of sediment were included in the model. The land surface sediment loads include sources from urban and agricultural land uses, runoff from open space, and construction activities. Construction related sources, however, were assumed negligible at build-out.

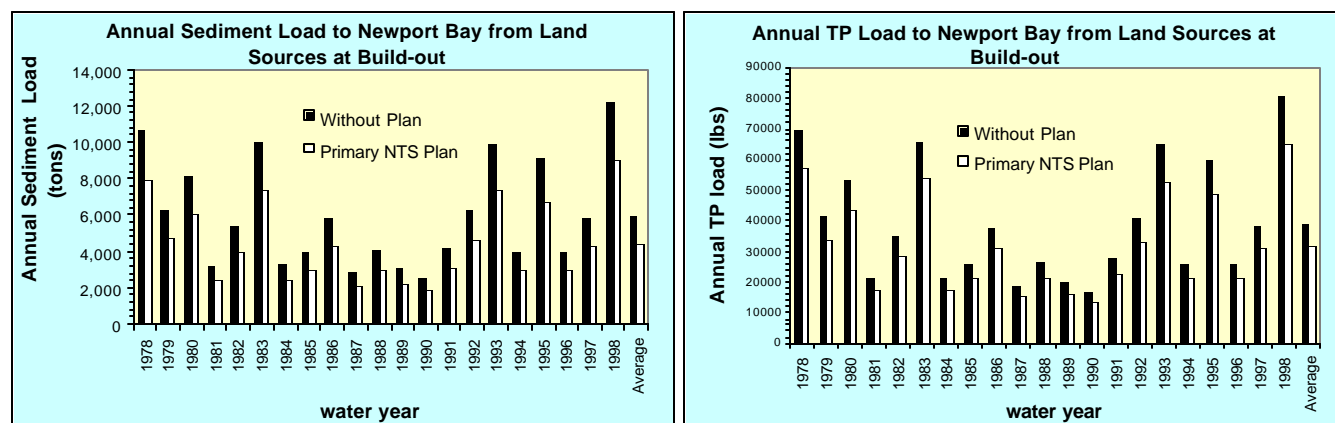
Although the phosphorus TMDL is specified in terms of an annual load to Newport Bay, monitoring data indicate the majority of the phosphorus load is in runoff from storm events. Phosphorus is mainly present in particulate form, attached to sediments transported during winter storm flows. Therefore, phosphorus treatment was modeled only for storm flow conditions consistent with the monitoring information. Average annual phosphorus loads and removals were quantified with the storm flow water quality model, identical to the approach used for sediments. Only urban and open space land-use sources of phosphorus were modeled.

The NTS Plan was not intended to treat in-stream sources of phosphorus; therefore it was assumed that bank stabilization measures and other BMPs would effectively control in-stream sources at build-out.

**Table 6:** Summary of Sediment Sources, TMDL Allocations, and Modeling Approach

Sediment Source	TMDL Allocation (tons/year)	Modeled in NTS Evaluation
In-stream erosion & scouring from In-Line sediment basins	None	No
Dedicated open space	28,000 discharged to Newport Bay 28,000 retained in sediment basins	Yes
Agricultural	19,000 discharged to Newport Bay 19,000 retained in sediment basins	Yes
Urban (commercial, residential, transportation, and industrial)	2,500 discharged to Newport Bay 2,500 retained in sediment basins	Yes
Construction activities	13,000 discharged to Newport Bay 13,000 retained in sediment basins	No

The storm flow model is based on rainfall/runoff relationships for the annual precipitation record from 1978-1998, as well as the average annual rainfall for this 21-year period. Model results estimate that NTS facilities remove about 1,600 tons/yr (1,451,000 kg/yr) of sediment during average rainfall conditions, or about 25 percent of the mean annual sediment load attributed to urban and open space land sources under build-out conditions. The NTS facilities would remove an estimated 7,300 lbs (3,311 kg) of TP per average year (Figure 4), or about 11% of the annual TP load from urban and open space sources. The 2012 TMDL target for TP (62,000 lbs/yr or 28,120 kg/yr) would be met in all but the wettest rainfall years. The two years where the TMDL was not met were the two highest rainfall years in the 21-year record, with 1998 also being a record rainfall El Nino year.

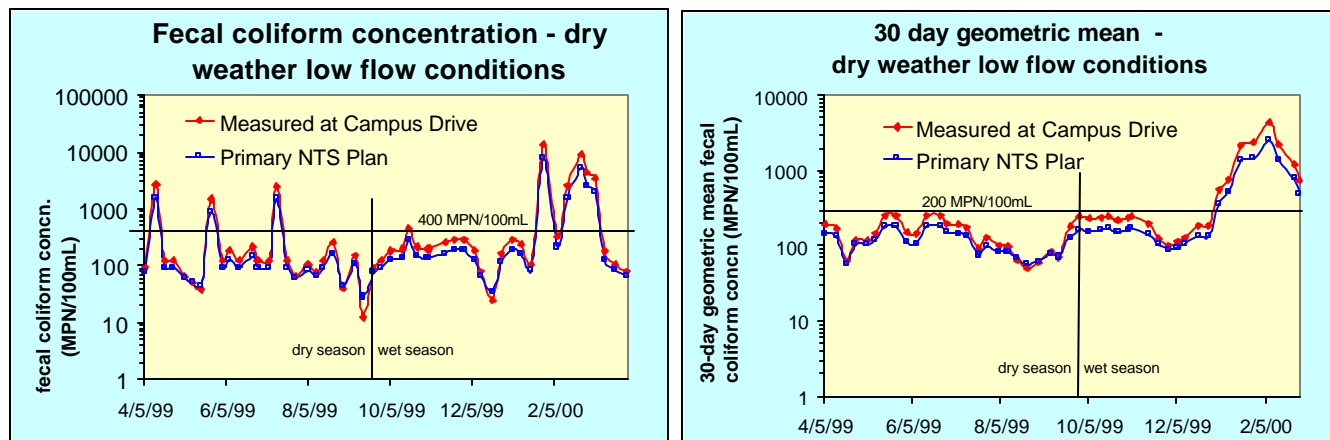


**Figure 4:** Estimated Sediment and TP Loads to Newport Bay from Storm Runoff.

### ***Estimated Coliform Removal***

The TMDL for pathogen indicators (fecal coliform bacteria) is valid throughout the year under all flow regimes. Therefore, fecal coliform removal was modeled for both low flow and storm flow conditions. Low flow conditions were modeled as a time series for comparison with monitoring data from a one-year monitoring period beginning in April 1999. Modeling results (Figure 5) indicate that during dry weather base flow conditions, fecal coliform concentrations would be reduced below the 30-day geometric mean standard of 200 MPN/100mL. The maximum 400 MPN/100mL standard would be met in most, but not all, of the dry season low flows. The standards are not met during the wet season base flow conditions.

The removal of pathogen indicators from storm runoff was modeled as equivalent fecal coliform loads. Modeling results suggest the NTS facilities will reduce fecal coliform concentrations by about 20 percent, but that concentrations entering Newport Bay will remain well above the TMDL targets during storm flow conditions. The inability to meet TMDL targets in the wet season runoff is attributed to the overwhelming pathogen loads generated during storm events.



**Figure 5:** Measured and Estimated Fecal Coliform Concentrations

### ***Estimated Metals Removal***

Monitoring data indicate that the majority of metal loads in San Diego Creek are sorbed metals associated with sediment loads from winter storm events. Therefore, assessment of metal load reduction was carried out for total metal loads under storm flow conditions. Removal of total metals in NTS facilities was evaluated for copper, lead, and zinc. Translators were used (Table 7) to estimate the dissolved metals fraction of the estimated total metal loads for comparison with the draft TMDL.

**Table 7:** Fraction of Dissolved Metals in Total Metal Concentration Measurements

<b>Metal</b>	Estimated Fraction Dissolved – storm flow (1)	Estimated Fraction Dissolved – low flow (2)
Copper	41.4 %	82.8 %
Lead	17.5 %	37.9 %
Zinc	37.3 %	61.8 %

(1) Based on average concentrations in storm monitoring data.

(2) Based on average concentrations in base flow (dry weather) monitoring data.

Average annual loads to Newport Bay from urban and open land sources for total copper, lead, and zinc are estimated at about 2,700, 1,100, and 21,000 pounds, respectively. The NTS Plan is estimated to remove about nine percent of the total copper and lead loads, and about 13 percent of the total zinc load attributable to urban and open land sources. The estimated annual total metal loads were converted to average annual dissolved metal concentrations to allow comparison with the TMDL objectives. Results indicate (Table 8) that the TMDL objective at the large and medium flow regimes is achieved on ‘average’ at build-out for both with and without NTS Plan conditions. The results suggest that TMDL compliance is most easily achieved for lead and zinc and is more difficult to achieve for copper. These ‘average’ results do not indicate the frequency at which occasional exceedances could occur.

**Table 8:** Estimated Average Annual Dissolved Metal Concentration in Storm Flows

Metal	Average annual total metal load in lbs at build-out <sup>(1)</sup>			Average annual dissolved metal concn in storm flow at build-out (ug/L) <sup>(2)</sup>			TMDL for medium flow regime (182-814 cfs)		TMDL for large flow regime (>814 cfs)
	Without Plan	With Plan	Initial Phase	Without Plan	With Plan	Initial Phase	Acute (ug/L)	Chronic (ug/L)	Acute (ug/L)
Copper	2970	2680	2790	12.1	10.9	11.4	30.2	18.7	25.5
Lead	1240	1130	1170	2.1	1.9	2.0	162	6.3	208
Zinc	23800	20400	21600	87.4	74.9	79.3	243	244	135

### ***Selenium Removal***

The design of the selenium treatment wetland at Site 67 was partially based on a successful treatment facility operating near the San Francisco Bay, which has similar site characteristics (Hansen et al., 1998). This facility was able to achieve selenium reduction below the water quality standard of 5 ppb. The proposed selenium treatment wetland at Site 67 is located in the historical marsh region, which is thought to be a significant source area in the watershed. This facility is estimated to remove between 235-500 lbs (107-227 kg) per year, or about 20 to 50 percent of the low flow selenium loads to Newport Bay. While the facility will significantly contribute to the reduction of low flow selenium loads, it may not, by itself, allow for attainment of the proposed TMDL targets. This is because other tributaries also contribute selenium loads to Newport Bay.

As selenium removal is relatively less well-understood, and in particular, is much less well-understood as an anoxic treatment system, the project has conducted column tests of different materials including chopped cattails, coconut shells, and green waste, as potential carbon-providing media for the anoxic treatment design. The next testing that is currently underway is at the mesocosm scale. The media that was chosen for further testing was the chopped cattails. Two side-by-side mesocosm facilities have been built to provide longer-term testing. The latest results of this testing will be presented at the conference and will also be available on the project web site when complete. Initial results are showing that selenium is being reduced to below laboratory detection limits.

### ***Toxics Removal***

The effectiveness of the NTS Plan for removing pesticides and organic compounds was not quantified because there is insufficient information about the sources of these compounds and about their treatment effectiveness in constructed wetlands. A literature review suggests the pesticides diazinon and chlorpyrifos have characteristics amenable for effective treatment in constructed wetlands; namely they are relatively insoluble, they are moderately to strongly sorbing, and they exhibit low to moderate persistence in soils. Limited data from the existing water quality treatment wetlands at the San Joaquin Marsh indicate that a high level of diazinon removal is occurring in the marsh.

### **Elements of NTS Plan**

#### ***Maintenance***

Regular and unscheduled maintenance activities will be required for all NTS facilities. Safe Harbor and access agreements will be processed to ensure that maintenance requirements can be carried out. Maintenance activities will include: trash and debris removal, pump servicing, vegetation removal and planting, sediment removal, installation and removal of seasonal weirs, vector control activities, and

emergency repairs. Minimization measures will be undertaken to limit impacts to wildlife and habitat from maintenance activities.

### ***Monitoring***

Monitoring is a key component of the NTS Plan. There are three aspects to the monitoring program: routine monitoring, site performance monitoring, and TMDL compliance monitoring. Routine monitoring activities include site inspections, sediment accumulation monitoring, vegetation monitoring, monitoring of pollutant accumulation and distribution, and vector pest monitoring. Detailed performance monitoring will be conducted for a few selected NTS facilities to evaluate their treatment effectiveness and operating constraints. Experience gained from these assessments will be used to improve designs and operation practices of the NTS facilities. Regional monitoring will be conducted to assess the performance of the entire NTS network, in combination with other BMPs, for meeting the TMDL and other goals.

### ***Vector Control***

Wetlands can provide breeding habitat for numerous pests and vectors, most notably Mosquitoes. A comprehensive Vector Control Plan was developed, which includes the use of Mosquito Fish and the application of a natural microbial pesticide (*Bacillus thuringiensis israeliensis*, Bti) for the control of mosquitoes. With the increasing attention being paid to West Nile Virus, the control of Mosquito's will be increasingly important. The Vector Control Plan was developed with the local vector control agency. Implementation of the plan will be carried out by the same agency to ensure its success. With the West Nile virus concerns, the Vector Control Plan is receiving additional attention, as it should.

### ***Program Modification***

The NTS Plan is intended to be flexible. The NTS Plan would be formally evaluated on a regular basis to ensure that it is working as intended and to evaluate changes to the program that can improve the overall performance. Sites could be added or deleted in response to new opportunities, needs, or constraints. Site designs and operation practices could be changed as monitoring experience is gained.

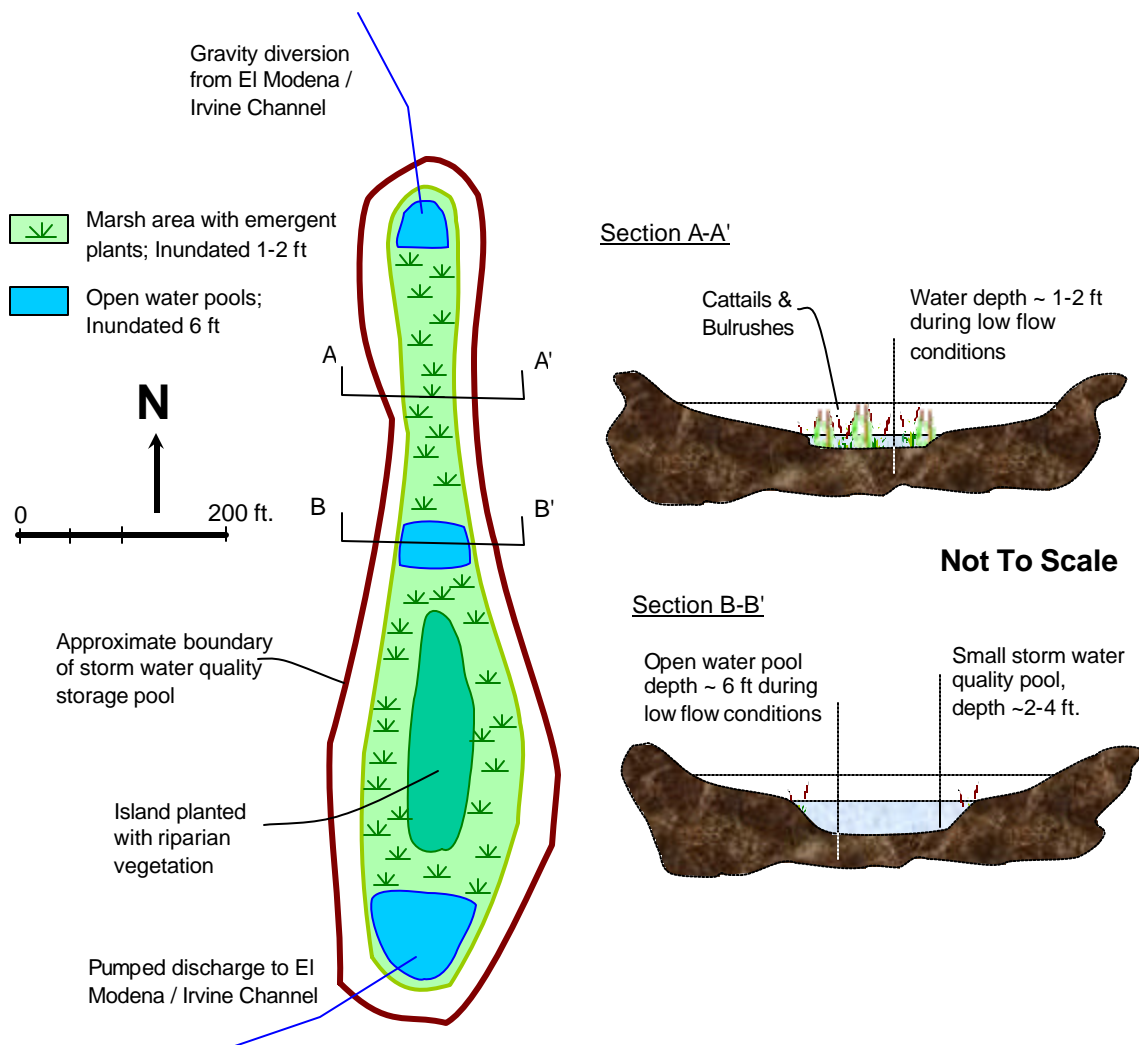
### ***Example Designs***

The first example of an urban retrofit for establishment of constructed wetlands is the El-Modena/Irvine Retarding Basin. This 9.5-acre (2.84 hectare) retarding basin is located within a fully developed residential and highly urban setting. The basin was designed to retard peak flood flows in the adjacent El-Modena/Irvine Channel, which drains approximately 1.6 mi<sup>2</sup> (4.14 km<sup>2</sup>) of residential areas in the upper reaches of the Peters Canyon Watershed.

The basin was originally designed with a water park in the floor of the basin, below the flood allocation pool, which is considered dead storage. The water park was to include a live stream and a waterfall, but was never implemented. The dead storage area is seen as the bare earth region in the photos shown in Figure 6. Notice the mounded area in Photo 2, which was to have been an island in the center of the water park. The basin is dry throughout most of the year, as winter storms of the magnitude that would cause any flow into the basin occur very infrequently. A portion of the flood flows that are infrequently diverted into the basin are retained in the dead storage area below the flood allocation pool. This water either infiltrates or evaporates.



**Figure 6:** El Modena/Irvine Retarding Basin. View in Photo 1 is from the upper end, near the diversion location. View in Photo 2 is from the lower end, near the discharge location.



**Figure 7:** Conceptual Design of a Constructed Wetlands Retrofit in the El Modena/Irvine Retarding Basin.

The retrofit concept is to establish constructed wetlands within the dead storage area in the bottom of the El-Modena/Irvine Retarding Basin. The wetlands would treat nuisance (low) flows, and runoff from smaller storms, as well as the first-flush flows from larger storms. A geotextile clay liner would eliminate infiltration losses from the wetland. Figure 7 shows a conceptual design of the proposed facility. The wetlands consist of 0.66 acres (0.27 hectares) of shallow water marsh with emergent cattails and bulrushes, 0.17 acres (0.07 hectares) of open water areas 4-6 ft (1.2-1.8 m) deep, and 0.5 acres (0.2 hectares) of re-vegetation area for native riparian habitat. The estimated average low flows during the dry and wet seasons are 0.07 cfs (2 L/s) and 0.12 cfs (340 L/s), respectively. The average residence time during low flow conditions is about 10 days. The stormwater quality treatment pool is on top of the low flow water level. The stormwater treatment capacity is about 2.7 acre-ft (3,330 m<sup>3</sup>) (average depth of 2 ft or 0.6 m), with a detention time between 48 and 96 hours (draw-down time).

A second example site includes an “in-line” facility. This is one that will only treat low flows. These facilities will be located with the drainage system and will provide treatment of low flow discharges. During storm events they would not be expected to provide any treatment. One of these sites is the Woodbridge In-line facility. Figure 8 shows several photographs of the existing channel. The channel in much of the reach is an earthen channel with limited habitat value. However, the placement of wetlands within such a system is expected to improve habitat while also improving water quality. In California, the use of “in-stream” treatment facilities has been controversial, with at least one Regional Water Quality Control Board not allowing the use of “regional” treatment systems such as these. It is the author’s opinion that not allowing regional treatment or not allowing treatment within a highly degraded stream such as this one is not a wise ecological approach.



Photo 1 & 2 - San Diego Crk, looking downstream at grade control structure between East Yale Loop and Creek Rd.



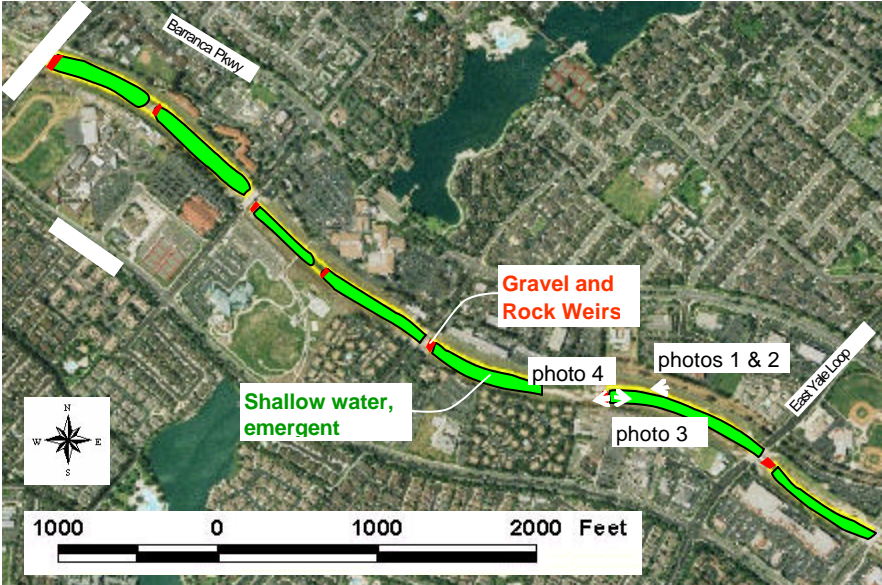
Photo 3 – San Diego Crk, looking upstream from grade control structure toward E. Yale Loop overpass.

Photo 4 – San Diego Crk looking downstream from grade control structure at energy dissipaters.

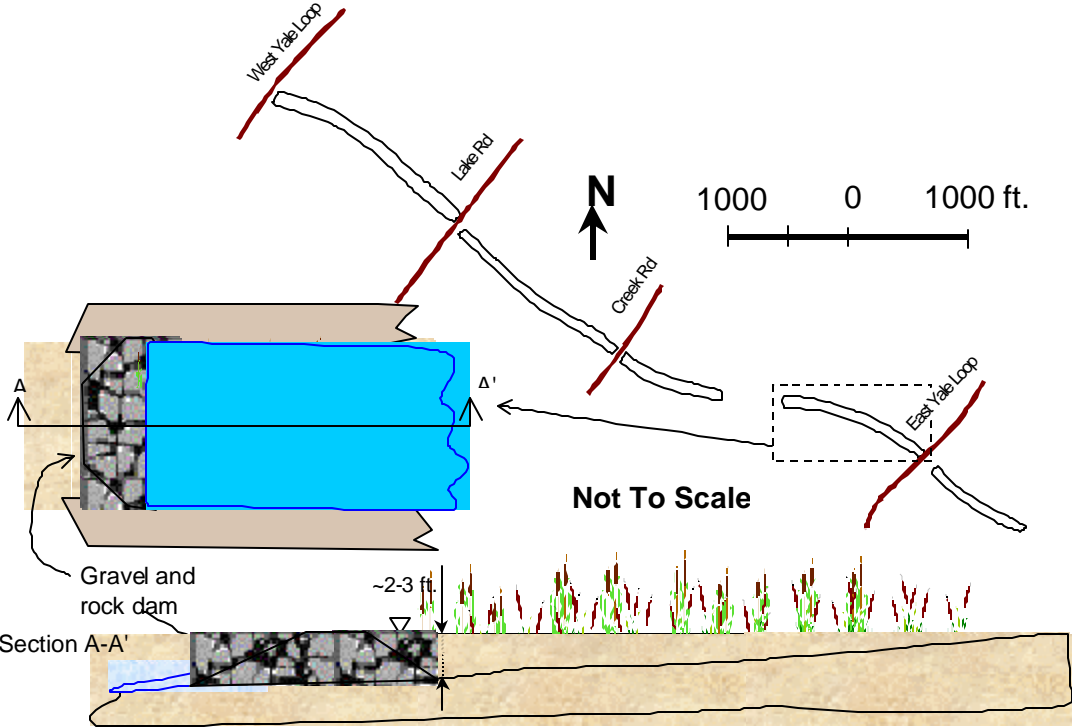
**Figure 8.** Woodbridge Site Photographs



Figure 9 shows an aerial photograph and conceptual layout of the facilities. Figure 10 shows a concept sketch of one of the facilities. The weirs may also require more maintenance than off-line facilities, including removing materials over the course of the year to maintain pooled water above the weirs. In a very space-constrained watershed, however, where dry-weather water quality is an issue, these types of facilities can provide significant benefits.



**Figure 9.** Aerial Photograph and Conceptual Layout of Woodbridge Facility showing the planned series of shallow linear wetlands within San Diego Creek.



**Figure 10.** Conceptual Drawing of In-line Facility, showing a plan view along with cross-sections of the planned gravel and rock dams (2 to 3 feet in height).

Some professionals argue against “in-line” or “in-stream” treatment. However, man-made earthen or riprapped channels with engineered drop structures are not natural streams. Because of the degraded status of these highly maintained flood control channels, the NTS Plan would improve both habitat and water quality. In a highly urbanized watershed such as the San Diego Creek Watershed, in-line treatment such as this may be one of the few options for improvement in water quality over the shorter-term.

## **Discussion**

The estimated cost to provide low-flow treatment of urban runoff in a sanitary treatment plant is greater than \$60 million in construction costs, with annual operation and maintenance costs of about \$5 million. The NTS System is expected to cost about \$12.2 million for first-phase construction of the 13 NTS sites, and \$1.1 million annually for ongoing operations, maintenance, and monitoring. This does not include the cost of projects funded by local developers or costs of second-phase regional project sites. A comparison of the capital cost per unit pollutant removed, indicates that the treatment plant is about three times more costly for TN removal from low flows, and about twice as costly for removal of copper from storm runoff.

The San Diego Creek Natural Treatment Systems Plan has been designed to result in a cost-effective solution that meets many goals. The effectiveness of the NTS Plan will ultimately be determined through the long-term coordinated efforts, spanning the planning, implementation, and program evaluation stages. Observations and conclusions from the development and initial evaluation of the NTS Plan are:

- Retrofit options are necessary to meet water quality goals in watersheds that are highly developed. It is possible to develop cost-effective regional retrofit solutions on a large watershed basis that would result in significant water quality improvements;
- Existing flood control basins and conveyance facilities can be cost-effectively retrofitted;
- The NTS Plan has resulted from a cooperative problem-solving focus by municipalities, development interests, water and sewer providers, and environmental groups. This effort has not focused on just meeting single-purpose requirements, and therefore has resulted in a more robust plan. Consequently, the NTS approach can achieve multiple benefits, including habitat and aesthetic values;
- The NTS Plan was developed in a relatively short 15-month time frame, demonstrating that planning efforts can be accelerated when there are motivated interests; and
- Cost-recovery from other sources of funds is possible when urban runoff treatment requirements include treating dry weather flows.

## **Acknowledgments**

The authors gratefully acknowledge the support of the Irvine Ranch Water District, The Irvine Company, County of Orange, Cities in the San Diego Creek Watershed, and local environmental groups. Efforts from all members of the NTS project team have led to the successful development of the NTS Plan. In particular, we acknowledge the contributions of John Tetterer, Sat Tamaribuchi, Dr. Alex Horne, Dick Diamond, and Bon Terra Consulting.

## References

ASCE, 2001. EPA/ASCE National BMP Database, [www.bmpdatabase.org](http://www.bmpdatabase.org)

Hansen, D., P.J. Duda, A. Zayed, and N. Terry, 1998. Selenium removal by constructed wetlands: Role of biological volatilization, *Environ. Sci & Technol.*, 32, 591-597.

Kadlec, R.H. and R.L. Knight 1996. *Treatment Wetlands – Theory and Implementation*, CRC Lewis Publishers.

RWQCB, 2000. Final Problem Statement for the Total Maximum Daily Load for Toxic Substances in Newport Bay and San Diego Creek, California Regional Water Quality Control Board, Santa Ana Region, December 15, 2000.

Strecker, E.W., Spring 1996. Use of wetlands for stormwater pollution control, *Infrastructure*, 48-66.

Strecker, E.W., M.M. Quigley, B.R. Urbonas, J.E. Jones, and J.K. Clary, 2001. Determining urban storm water BMP effectiveness, *ASCE J. of Water Resources Planning and Management*, 125(3), 144-149.

USEPA (Region 9), 1998a. *Total Maximum Daily Loads for Sediment and Monitoring and Implementation Recommendations; San Diego Creek and Newport Bay, California*

USEPA (Region 9), 1998b. *Total Maximum Daily Loads for Nutrients; San Diego Creek and Newport Bay, California*

USEPA, 2002. Total Maximum Daily Loads for Toxic Pollutants, San Diego Creek and Newport Bay, California. Public Review Draft April 12, 2002, <http://www.epa.gov/region09/water/tmdl/>

# **“SHERLOCKS OF STORMWATER” EFFECTIVE INVESTIGATION TECHNIQUES FOR ILLICIT CONNECTION AND DISCHARGE DETECTION**

Dean C. Tuomari/Susan Thompson  
Wayne County Department of Environment  
Watershed Management Division  
3600 Commerce Court  
Wayne, MI 48184

## **ABSTRACT**

“Come, Watson, Come! The Game is afoot!...” (Doyle, 1930) Wayne County has operated an Illicit Connection and Discharge Elimination Program for over 15 years. Its staff has gained valuable investigative expertise by experimenting with many different methods, committing lots of trial and error, and having a little bit of luck. Investigating for illicit discharges in the field is very similar to Holmes and Watson solving a case - it requires a mix of science, detection, deduction, and persistence.

This paper presents investigation techniques used effectively to identify illicit connections and discharges. These techniques are: Identifying priority areas (i.e. “hot spots”), outfall survey, facility dye testing, televising sewer systems, intensive water sampling, smoke testing, and other creative means. Each technique, its advantages and disadvantages, and the best application for each method are described in detail.

In 1999, the Illicit Connection Discharge Elimination Training Program was created and implemented by the Wayne County Department of Environment, Watershed Management Division (WCDOE-WMD). The program was developed to provide training for local and regional governments responsible for locating and eliminating illicit discharges to surface waters. Wayne County determined that such a program is an effective means of transferring technology to others. The key goals of the training program are: Sharing our expertise with other local units of government involved in stormwater management and collaborating efforts to reduce improper discharges to surface water.

The Wayne County Training Program is consistent with the Illicit Discharge Elimination Plan (IDEP) requirements of the Michigan Voluntary Storm Water Permit (MIG6100000) and the EPA Phase II Stormwater Permit Regulations. The training program consists of five modules and two specialty training sessions. The modules are: Overview, Basic Investigations, Advanced Investigations, Construction Related Illicit Discharges, Combined Basic/Advanced Investigations and two specialty training sessions. The specialty training sessions are titled “Recognizing and Reporting Illicit Discharges” and “Illicit Discharge Investigation Exercise.” Nearly 800 people, representing various local units of government, attended the training sessions through September 23, 2002. As a result of these training efforts, 82 illicit discharges were eliminated, preventing an estimated 3.5 million gallons/year of polluted water from entering Michigan surface waters. Wayne County will explain its experiences and those of other agencies with selected investigative methods. A case study based on an actual investigation exemplifying how some of the techniques are used in the field is presented.

The “Sherlocks of Stormwater” will assist others needing to prepare and implement an Illicit Discharge Elimination Plan.

## **Introduction**

“Come, Watson, Come! The Game’s afoot!’ ....” (Doyle, 1930) Wayne County has operated an Illicit Connection and Discharge Elimination Program for over 15 years. Its staff gained valuable investigative expertise by experimenting with many different methods, committing lots of trial and error, and having a little bit of luck. Investigating for illicit discharges in the field is very similar to Holmes and Watson solving a case - it needs a mix of persistence, science, detection, and deduction. A brief overview of the Rouge River National Wet Weather Demonstration Project, geography of the Rouge River Watershed and illicit connection and illicit discharge definitions are provided. Wayne County’s Illicit Discharge Elimination Program, training program, and the reasons why they are necessary is introduced.

The Illicit Discharge Elimination Plan (IDEP) Training curriculum, formulation and content are outlined. The primary focus of this paper is introducing the variety of techniques used to identify illicit connections and discharges used by Wayne County and other local agencies. Based on Wayne County’s experience in IDEP investigations, each technique is described and the advantages and disadvantages to each method listed. A case study illustrates how the different techniques are used in field investigations. In conclusion, Wayne County presents the successes achieved by the implementation of its IDEP Plan and IDEP Training Program.

## **Rouge River Project Overview**

The Rouge River is located in the southeast region of lower Michigan. It encompasses an area of about 467 square miles and is highly urbanized. Approximately 1.5 million residents of 48 municipalities live and work in the watershed.

The Rouge River is tributary of the Detroit River, a part of the southeast Michigan area identified as an “area of concern”, by the International Joint Commission (IJC). In response to this bleak assessment and demands of local residents for improved water quality, the State of Michigan created a series of Remedial Action Plans (RAP) to address specific sources of pollution of the state surface waters.

The Rouge River Remedial Action Plan (RAP) is an ambitious 20-year plan to clean up and restore the river to a fishable and swimmable state. The RAP focused on sources of pollution such as Combined Sewer Overflows (CSOs), Industrial Pollutant Discharges, and Non-Point Source Pollution. The RAP contains a recommendation that “programs to eliminate improper connections to storm drains should be implemented...” (SEMCOG, 1988). In 1987, Wayne County developed and implemented a program for reducing pollutant loadings to the Rouge River. This program detects and eliminates illicit discharges and/or improper/illegal connections to Wayne County storm sewers and surface waters. An illicit connection is defined as a pipe intended for a sanitary sewer that is directly connected to, or indirectly drains to a storm sewer system or surface water body. An illicit discharge is the indirect migration of pollutants by storm water to a surface water body. Examples of illicit discharges are: failing on-site sewage disposal systems, spilling or dumping of materials, and illicit connections.

In November 1999, the U.S. Environmental Protection Agency (USEPA) promulgated Phase II of the National Pollutant Discharge Elimination System (NPDES) storm water regulations, which affects virtually all communities in southeast Michigan, including Wayne County. Wayne County, through its Rouge River National Wet Weather Demonstration Project (Rouge Project) assisted the Michigan Department of Environmental Quality (MDEQ) in the development of a new watershed-based General Permit for

municipal storm water discharges (General Permit). The MDEQ General Permit was approved by EPA as an option available to local communities and other public agencies to comply with the requirements of the Phase II federal NPDES storm water regulations.

One of the requirements of the federal Phase II NPDES storm water regulations and the MDEQ General Permit is to develop, implement, and enforce a program to eliminate improper connections to the storm sewer system and other improper discharges to surface waters. During 1999, over 45 communities and agencies in the Rouge River watershed, including Wayne County, have received coverage under the MDEQ storm water General Permit and have initiated the illicit discharge elimination program (IDEP) requirements of the permit. Wayne County recognized this as an opportunity to share our considerable expertise in illicit discharge investigations with others.

The Wayne County Illicit Connection/Discharge Elimination Plan (IDEP) Training Program was created and implemented in 1999-2000. The training program was developed to provide training for county and local community staff responsible for locating and eliminating illicit discharges to surface waters, as required under the federal National Pollutant Discharge Elimination System (NPDES) regulations for municipal storm water discharges. The training program consists of five modules and two specialty training sessions. The modules are: Overview, Basic Investigations, Advanced Investigations, Construction Related Illicit Discharges, and Combined Basic/Advanced Investigations. The Specialty Training Sessions are entitled “Recognizing and Reporting Illicit Discharges” and “Illicit Discharges Investigation Exercise”.

This paper provides a basic overview of the Advanced Investigations IDEP Training Module. It introduces the techniques used to effectively identify illicit connections.

## **Finding the Problem Area: “In Quest Of A Solution”**

Where to begin an investigation for illicit discharges?

Wayne County sewer sleuths begin compiling information on the targeted area. Information and data can be gathered from many different sources; outfall surveys, referrals from other departments, known areas of concern, review of existing water quality data, and complaint response. All this data is reviewed and compared with existing data to determine if potential problems (i.e., “hot spots”) exist. The goal of identifying “hot spots” is to isolate the area where the problem exists and then locate the pollutant source. Specifying the problem allows the investigator to select the type of parameters for field measurement. For example, if sewage is the suspect problem, sampling for bacteria is useful in verification. Once the problem is identified, additional sampling is performed, upstream and downstream of the “hot spot.” Data from the sampling events is compared and utilized to determine the area where the values are the highest. Once the suspect pollutant is identified, sampling may be repeated as necessary to narrow down the geographical area to a manageable size.

Outfall survey is also used as a screening tool to define investigation areas. It involves field observations of the stream channel and conditions at outfall locations. If suspicious discharges or signs of past discharges are seen, physical and chemical parameters are selected to identify the type of discharge. If observations at an outfall triggers an investigation, tracking the suspect source moves upstream from the outfall along the storm sewer system. Storm sewer manholes are opened and visual and physical observations for signs of suspicious discharges are made. This process continues upstream and along sewer laterals until signs of a

discharge are found. Once this area is isolated, the investigator can choose from the variety of techniques to help track the source.

## **IDEP Tracking Techniques: “The Science of Deduction”**

Like Sherlock Holmes, modern day IDEP detectives utilize their skills and knowledge to solve their cases. However, there are techniques available to make detection of illicit discharges and connections more than just deduction. There are four techniques commonly used by Wayne County and other local governmental agencies in southeast Michigan when searching for sources of illicit discharges. Each of the techniques has its advantages and disadvantages and there’s no one “right” way. In some cases, a combination of methods may be used in quest of a solution.

## **Investigative Methods: “The Sign of Four”**

### ***Intensive Sampling***

Intensive sampling is defined as one of the two following situations: 1) many samples collected at many locations, and 2) many samples collected at the same location over a specific period of time. This method is effective if intermittent flows in a storm sewer or when a source is active in hours where routine sampling is ineffective. For example, if a suspected source is a residence where persons are not home during the day, peak flows typically occur during early morning or early evening.

Taking many samples at many locations is useful when isolating the area of a suspected illicit discharge, especially when the survey area is large. The sample data can help narrow down an area where a problem may exist, by comparing sampling data from different locations along the storm sewer line or stream channel. Degree of concentration, or presence and/or absence of a pollutant demonstrated in the data, can lead an investigator to an area of the potential source.

Intensive sampling techniques are good for isolating source areas for investigation, completing field data gaps present between sampling events, off-hour sampling events (because staffing is unnecessary for automatic sample collection), and in residential areas where intermittent flows are common.

There are also several disadvantages to the method. For example, it does not pinpoint the pollutant source exactly and data variances may exist which makes it difficult to establish trends. Also, limited holding times for certain parameters make it difficult to time sampling sessions and collecting many samples may be expensive and require laboratory analysis and holding times. Finally, placing flow meters or automatic samplers at a site may involve confined space entry, which requires additional training and equipment.

### ***Dye Testing***

Dye testing is an investigative technique that involves placing tracing dyes in a sewer system to determine path of the flow. This method is effective for determining if illicit connections exist in a facility, or if there are interconnections between sewer systems.

Wayne County extensively uses dye testing for illicit connection detection. When performing a dye test, field staff walk through the facility to determine where the plumbing fixtures are and observe interior and

exterior housekeeping practices. A dye testing plan is prepared and tracing dye is placed into plumbing fixtures. The dye is flushed through the system with running water. A person is stationed at the sanitary manhole down stream of the tested facility and alerts the team member inside the building when the dye is observed in the sanitary sewer. Alternate dye colors are used so multiple fixtures can be tested simultaneously. If dye is not observed in the sanitary sewer, the dye test is repeated until it is confirmed in the sanitary sewer or in a storm sewer, or surface water body. If the dye from a fixture inside the building is discovered in a location other than a sanitary sewer, it is an illicit connection.

Advantages of using dye testing for illicit connection detection are that dye testing is inexpensive, relatively easy to do, points to a specific source, and does not require confined space entry.

Disadvantages to dye testing are that it may be difficult to see the dye in high-flow or turbid conditions, it is time consuming in low flows, and entering a facility is necessary in order to conduct the test.

### ***Televising***

A remote camera with a video recorder is another means to search for illicit connections and discharges. The self propelled camera is placed into the sewer line and the operator can view live footage of the sewer line, so the condition of the sewer line and evidence of illicit taps can be seen. Televising is an effective technique because it views active taps, provides a record of observations, and is the only way to observe pipes between manholes. It can, however, be expensive, ineffective in determining if inactive taps convey illicit discharges, time-consuming to interpret results, and impractical in water-filled or obstructed sewers.

### ***Other Techniques***

There are other methods various agencies use to search for illicit connections. Some municipalities use smoke testing of storm sewers. A non-toxic smoke is introduced into a storm sewer and an illicit tap is suspected if the smoke is observed in a sewer vent from a building. Some communities have sent stout-hearted workers to survey storm sewers big enough to walk into in order to do “up-close” illicit discharge surveys. Searching for illicit discharges is part art and part science. Imaginative ways are created to do investigations often because no specific equipment exists, or because of cost-effectiveness. Ingenuity leads to effective methods like placing a rope with oil-absorbent pads tied at measured intervals into a storm sewer manhole located upstream of a facility where leaky underground oil storage tank was suspected. The rope was pulled out of the sewer, and measured off to where oil was present. The distance was walked off on the surface and the investigators ended up in front of the suspect facility. When presented with the evidence, the owner admitted to the problem and repaired the leaky tank.

### **A Case Study: “Sherlock Holmes Gives a Demonstration”**

“A Study in Scarlet” – Restoring Rouge River Recreational Opportunities

A goal of Wayne County is to return canoeing to selected portions of the Rouge River. To support that goal, water quality must meet the State of Michigan bathing beach standards for *Escherichia coliform* (*E. coli*). This standard is the daily geometric mean of three samples must be less than 300 cfu/100ml of water. The geometric mean of five sample events collected over 30 days must be less than 300 cfu/100mls of water.



Review of available data and additional sampling found two impoundments, and a mile of river between them, safe for canoeing during dry weather. Canoeing on the upstream impoundment became a reality and received an overwhelmingly positive public response. Based on the success upstream, a second goal to extend canoeing downstream of the second impoundment was set. Sampling of this stream section found that *E. coli* levels were very high below the dam of the second impoundment. A nine-foot wide storm sewer outfall discharged at this location, making it a prime target for investigations. Wayne County sewer sleuths were assigned to the case and set out to unravel the matter.

The sewer drainage area is approximately 157 acres, contains over 5.5 miles of enclosed storm sewer and over 350 manholes. The storm sewer has one main line with many connecting branches. The land use in this area is primarily residential.

Samples were collected along the main line at a variety of locations. A branch coming into the main line near the outfall had higher *E. coli* levels than the others. Confirming sampling found very high levels of *E. coli*, indicating a significant bacteria source upstream at this suspected branch. After using a very extensive sample regime designed to narrow the search area, efforts switched to sampling the main line at a variety of locations to isolate the branch that contained the source. One ¼ mile long branch line had significant levels of *E. coli*. Storm sewers from adjacent branches with similar land use had extremely low levels of *E. coli*.

Sampling up the line revealed increasing levels of *E. coli*. Results at one manhole were over 160,000 cfu/100ml. On the basis of this result, it was suspected that this short section of sewer line contained a problem. This suspicion, and supporting data, was shared with the City representatives. During this meeting, the County learned that a storm sewer separation project occurred in this area several years ago. A sewer line or a tap may be misconnected, discharging sewage into the storm sewer and causing the bacteria problem. The City and the County agreed on a plan of action to find the source of the *E. coli*. The City agreed to televise the storm sewers. At one location on the sewer line, the camera dipped below the water. Otherwise, no taps were found. The City agreed to dye test the homes along the sewer line for illicit connections. The County drafted a letter and provided the City educational materials for mailing to the homeowners. Dye testing did not uncover any illicit connections.

Subsequent sampling of the sewer line found very low levels of *E. coli*. Repeated sampling up to two years later found extremely low *E. coli* levels. The problem seemed to disappear. What happened? The theory is that someone in the neighborhood owned a recreational vehicle and discharged its holding tank into the storm sewer or performed some other inappropriate action. With all of the activity in the neighborhood, the County and City staff interacting with the residents, and the public education mailing, the culprit realized their actions caused a problem and stopped. This is an investigation where a blend of intensive sampling, sewer televising, dye testing and public education techniques were used in attempting to resolve the problem.

## **Success of Wayne County's IDEP and Training Program**

From October 1987, when the Illicit Discharge Elimination Plan was implemented, through December 2001, Wayne County inspected 4,887 commercial, retail and industrial facilities for illicit connections. During these inspections, field staff discovered 1,243 illicit connections at 326 facilities. Finding and eliminating these illicit connections prevents and estimated 18 million gallons/year of polluted water and 4,600

pounds/year of biological oxygen demand (BOD) and 16,000 pounds/year of total suspended solids (TSS) from entering Wayne County surface waters.

Nearly 800 people, representing various agencies and communities throughout Michigan, and two neighboring states, attended training sessions conducted by the County through September 30, 2002. Ninety-eight percent of training session participants surveyed encourage persons with similar responsibilities to attend the training course(s). One participant commented “This is the best training session I have had in 20 years.” The information these individuals gained from attending the training session helped them in creating their own IDEPs. Successful programs include those implemented by neighboring counties. Eighty-two illicit discharges were identified by IDEP investigations performed in the Counties of Oakland, Washtenaw, and Wayne. The pollutant load into Michigan’s surface waters from these discharges is estimated to be 3.5 million gal/year of polluted water, 7,200 lbs/yr BOD, and 25,000 lbs/yr TSS.

### **Conclusion: “Light In The Darkness”**

There is no “cookbook” or standard operating procedure for investigating illicit discharges and connections. A combination of using the techniques presented here and ingenuity, plus a little luck, will go far in the “Quest of a Solution.”

“Eliminate all other factors, and the one which remains must be the truth.” – Sherlock Holmes (Doyle, 1930).

Happy Hunting!

## ACKNOWLEDGEMENTS

We want to express our thanks to all those who helped in the development of the IDEP Training Program, including Glenn Brown, P.E., John O'Meara, P.E., and Kelly A. Cave, P.E.. A special thanks to those who took the time to share their expertise with IDEP training session attendees: James W. Ridgway, P.E., John O'Meara, P.E., Annette Demaria, Earl Friese, Tom McNulty, P. E., Glenn Brown, P.E., Bonnie Pawloske, Thomas Williams, Patrick Cullen, Noel Mullett, Gary White, and Steve Lichota.

Production support provided by Chris O'Meara, Judy Holt, and Latisha Martin. Appreciation to those took the time out of their busy schedule to participate in the "Ad-Hoc" committees. In addition, recognition is extended to the Wayne County staff who supported the effort by helping with a multitude of tasks. Special Acknowledgement goes to Sir Arthur Conan Doyle, whose fictional detective inspired investigators to use "the Science of Deduction" in their IDEP Activities.

This paper represents a summary of select elements from the ongoing efforts of many individuals and organizations who are involved in the restoration of the Rogue River. The Rouge River National Wet Weather Demonstration Project is funded, in part, by the United States Environmental Protection Agency (EPA) Grant #XP995743-01, 02, 03, 04, 05, and 06 and #C995743-01. The views expressed by individual authors are their own and do not necessarily reflect those of EPA. Mention of trade names, products, or services does not convey, and should not be interpreted as conveying, official EPA approval, endorsement, or recommendation.

### **References:**

Conan Doyle, Sir Arthur "*The Complete Casebook of Sherlock Holmes*", Double Day, 1930.

Note: All sections with titles in quotations are either titles of Sir Arthur Conan Doyle's short stores or novels.

*Remedial Action Plan for the Rouge River Basin*, (SEMCOG), 1988)

# Low Impact Development Strategies for Rural Communities

Neil Weinstein, Executive Director  
Low Impact Development Center  
Beltsville, Maryland

John Tippet, Executive Director  
Friends of the Rappahannock, Inc.  
Fredericksburg, Virginia

## Abstract

The Friends of the Rappahannock and the Low Impact Development Center, Incorporated (both non-profit organizations) are developing guidance and strategies for rural communities in Virginia to incorporate LID into their local resource protection and regulatory programs. This project was funded by the National Fish and Wildlife Foundation, under a grant from the Chesapeake Bay Program. The Town of Warsaw, Virginia is the municipal partner in the grant. The first part of this effort includes evaluating state and local codes to determine what, if any, necessary legislative, code, or local regulations need to be modified to include LID. Identifying areas in the Town and land uses that are appropriate for LID technologies follow this effort. The next step will be to develop materials for developers and plan reviewers to help guide them through the development process when the use of LID is appropriate. The final step will be to design and implement a small demonstration project that showcases LID features, such as rain gardens, soil amendments, permeable pavers, and infiltration devices. This paper will document this effort and identify key issues that other communities should consider when contemplating the use of LID.

## Background

The Town of Warsaw, Virginia is a rural locality in Virginia's Northern Neck, located between the Rappahannock and Potomac Rivers. Figure One shows the vicinity of the town in the watershed. The Town and County have historically had strong economic ties to the surrounding rivers, although this has declined in recent years due in particular to the decline of oyster harvests. The Town does not have a strong economic base, and recently lost a major employer, a Levi's plant. The Town recently annexed a portion of its "parent" County for the purposes of economic development. This former agricultural land is highly suitable for development, and is situated along the area's major 4-lane highway. The nature of future development in Warsaw is currently unclear, although current trends tend toward assisted-living and retirement communities, along with supporting services. Town officials expressed an interest in Low Impact Development strategies after seeing presentations at various local government and watershed management conferences. They were concerned about the stormwater infrastructure costs associated with new development in the annexed land, as well as with the aesthetic and environmental impacts of conventional pond treatment of stormwater runoff. The Town currently has only one stormwater management pond, that was recently put in as part of a new shopping center. There have been numerous complaints by the property manager and adjacent property owners about the maintenance and aesthetics of the facility. The town is also concerned about the inspection, ongoing maintenance, and potential rehabilitation costs of conventional end of pipe pond systems. This has caused the town to reevaluate its existing stormwater program. Figure 2 is a map of the annexed areas and drainage master plan that shows existing drainage problems and projected stormwater pond locations. The Town views LID strategies as a means of reducing costs while also increasing community aesthetics and environmental protection. The Low Impact Development Center, the Friends of the Rappahannock, and the Town of Warsaw teamed up on

a joint grant proposal to the EPA Chesapeake Bay Program (through the national Fish and Wildlife Foundation) to develop a model approach for incorporating LID in rural communities.

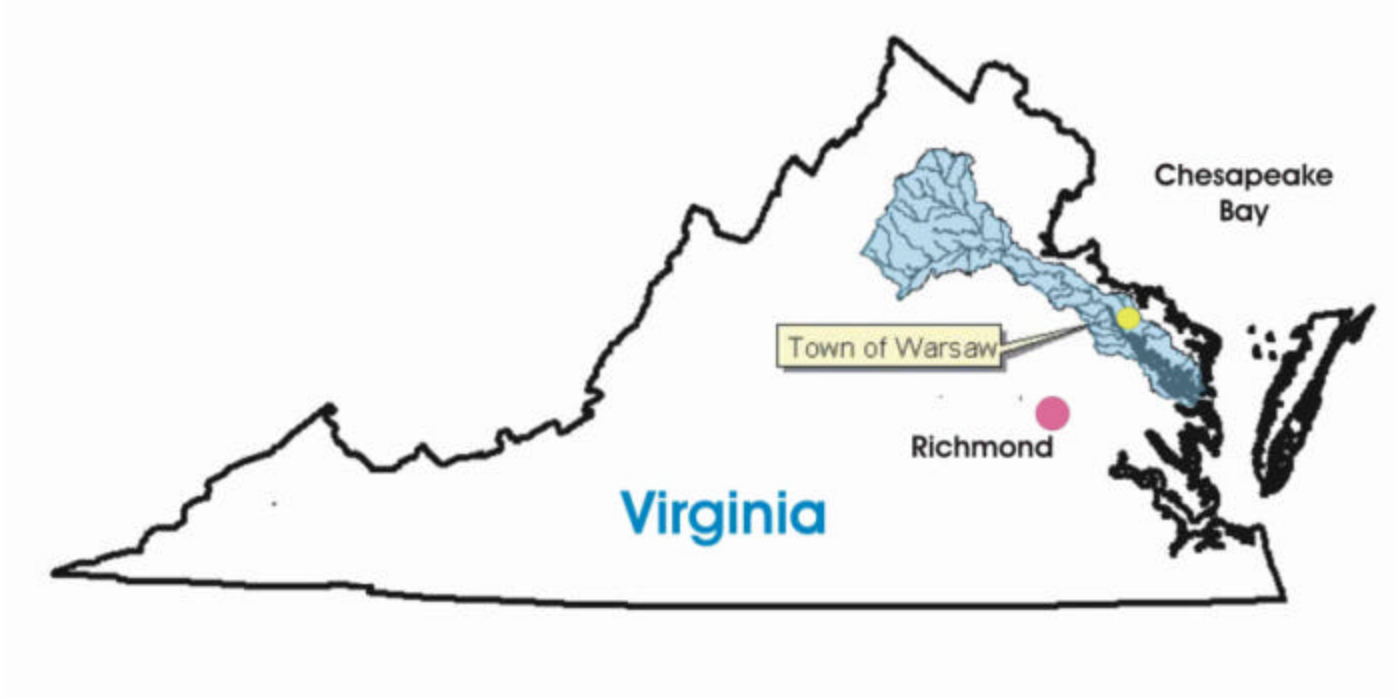


Figure 1: Rappahanock Watershed

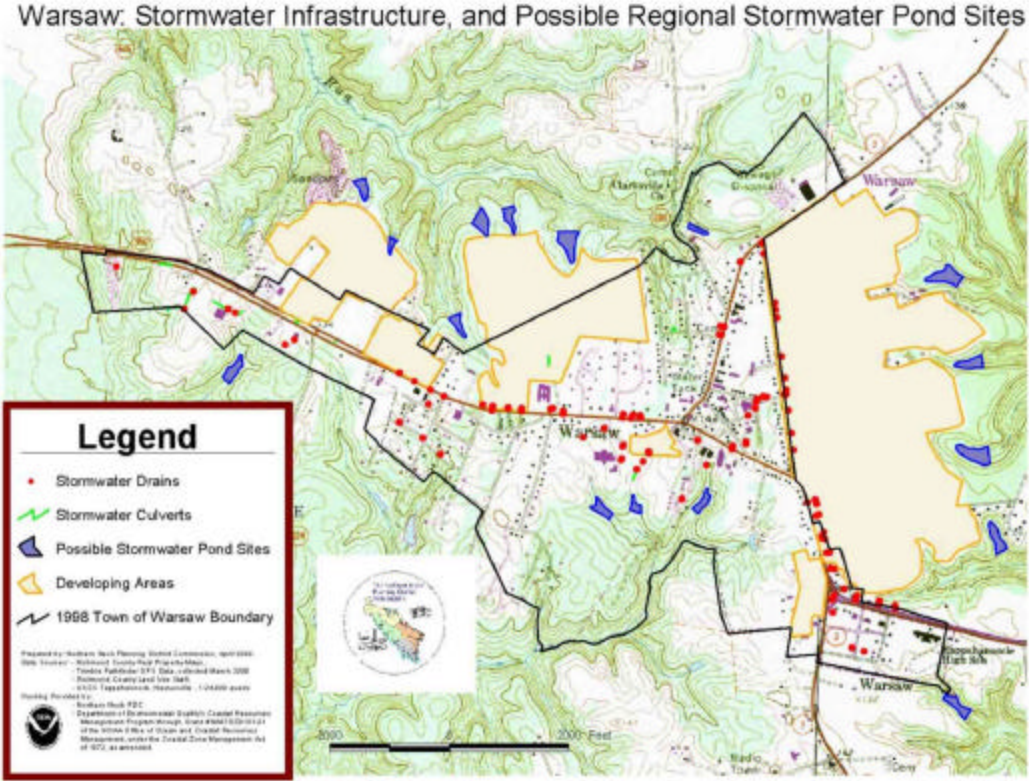


Figure 2: Potential Pond Locations

## **Evaluation of Local Codes**

The project initiated with an evaluation of local (Town and County) codes and ordinances to determine compatibility with LID. Most local governments, especially rural ones, reference the State BMP design manual and Stormwater handbooks for guidance (VADCR 2001). A review of the local and state guidance indicated that the codes allowed the use of many (though not all) types of LID stormwater management practices. However, there were no mechanisms in the language to promote LID designs in lieu of conventional approaches. Additionally, the conventional approach was designed around detention/retention of the 2-year storm, while the LID approach is designed around the replication of pre-development hydrology, which focuses on infiltration of the increase in “initial abstraction” on a site, and maintaining pre-development Time of Concentration.

While practices such as bioretention were permissible in the state guidance, there were other practices without design guidelines or standards by which to calculate pollutant removal or water volume detention. Most notable was the LID practice of “amended soils.” Another deficiency in the stormwater guidance was a table used to determine appropriate BMPs for a site. The guidance recommended using bioretention only on projects with low levels of impervious cover. Another weakness was a specific recommendation against the use of infiltration practices under parking lots.

Project leaders met with Commonwealth of Virginia officials to discuss these barriers. Most were agreed upon for revision in subsequent volumes of the stormwater guidance. On the issue of the conventional versus LID approach to stormwater management design, it was generally agreed that the LID approach meets or exceeds the Commonwealth water quality and quantity requirements, as long as the designs also meet the Commonwealth’s provision for having an “adequate receiving channel” (Minimum Standard 19 VADCR).

## **Assessing Local Government Needs**

The Town Manager’s interest in LID stemmed from a desire to reduce infrastructure and maintenance costs, to increase community aesthetics, and to reduce impacts to the local aquatic resource. Figure Four is a map of the potential number of conventional ponds that could be constructed at the ultimate buildout of the community under conventional stormwater management scenario. Based on the towns maintenance and construction experience with the recently conventional management pond it recognized that the pond strategy would potentially be unsustainable and would be impact other funded programs. Consequently, the project was designed around developing a plan to institute LID as the standard development approach Town-wide, and possibly to be expanded to the county in which the Town resides.

Project staff conducted meetings with Town and County officials to determine their needs in regard to instituting an LID development program. The issue that emerged in the forefront was the lack of criteria that local government plan reviewers had for assessing an LID site design. There were significant concerns, based on prior experience, that “token LID” plans would be submitted (i.e., plans that included some LID practices, but did not achieve the quantitative LID goals) and that staff would not have the means by which to evaluate the merits of the plans. Additionally, there concern on the parts of local officials that the development community was unfamiliar with the LID approach to site design and stormwater management, and that it would be difficult to have quality LID plans submitted.

This project has far reaching implications for many rural Virginia communities. It demonstrates how local governments can work with regulatory agencies to develop and implement a stormwater program that meets

both regulatory requirements and community environmental and fiscal programs. For a relatively small cost, communities can develop their own programs, obtain resources to train review and maintenance personnel to deal with more complex stormwater design and construction issues, and gain acceptance by political, business, and citizens within the community for innovative programs.

### **Developing an Action Plan**

Based on the evaluation of codes and local government needs, the following action items were developed:

1. Develop policy language for instituting LID as the standard practice for project site design and stormwater management
2. Create easy-to-use LID review guidelines for local plan review staff
3. Create a reference document for developers to use in designing LID plans
4. Create an LID educational brochure targeted to citizens
5. Develop a list of specific recommendations for changes to Commonwealth stormwater design guidelines to better support LID at the local level

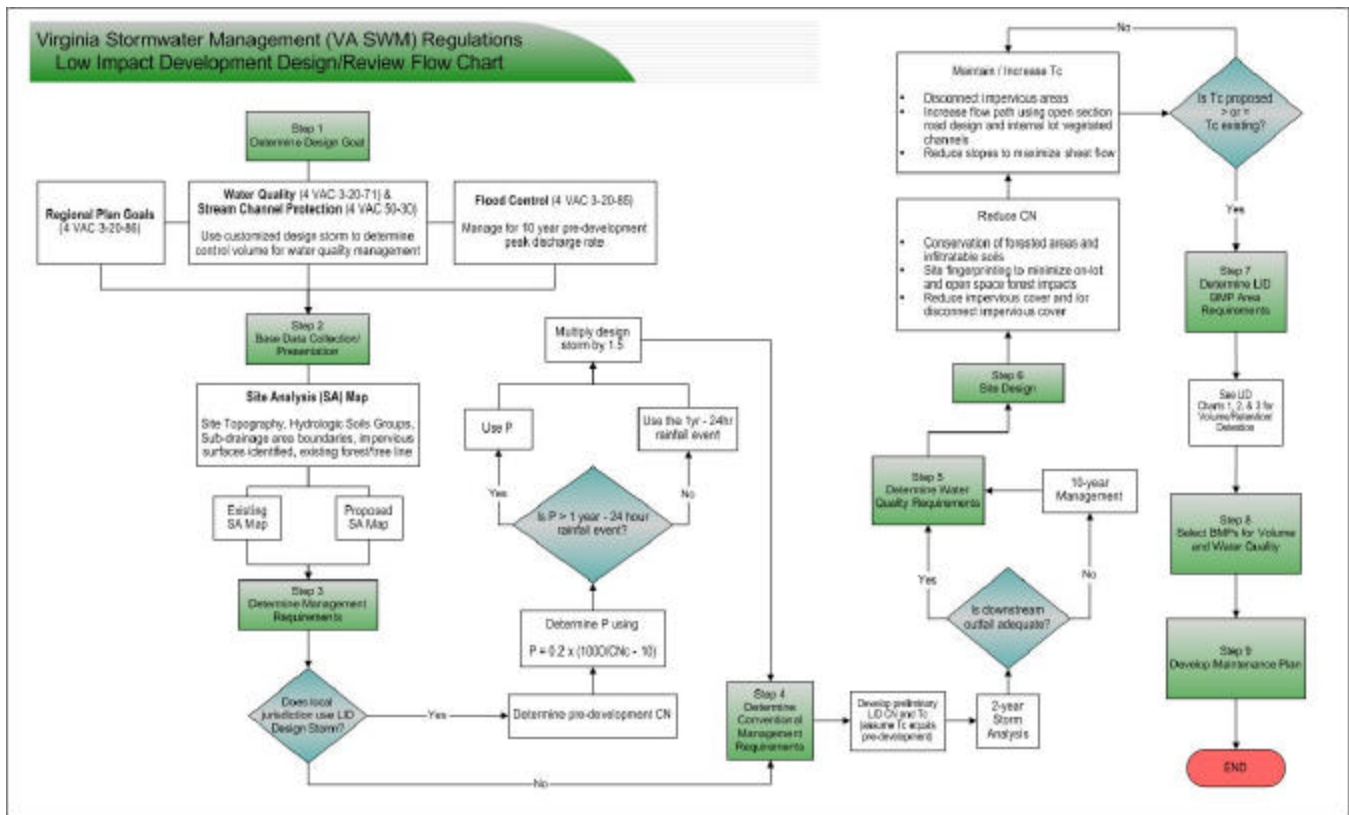
### **Demonstration Project**

A demonstration project to model the LID design approach is planned for a Virginia Department of Transportation (VDOT) Commuter parking lot. A rain garden and pervious pavers are planned for the demonstration. The project is currently pending funding from VDOT.

### **Project Products**

The policy language developed for the Town establishes the LID approach as the standard methodology within the jurisdiction for stormwater management methodology for new developments. The language includes references to the LID National Manual for design guidelines, and to other guidance products created under this project. The language is currently under review by the Town and County officials for inclusion in the local stormwater management ordinance.

The guidelines for developers and plan reviewers underwent an iterative process of revision between the project leaders, state stormwater management officials, and town staff. The resulting guidelines are designed to lead a developer with little familiarity of LID through the process of creating a viable LID site design. These guidelines are outlined through a series of checklists, flow charts, and references to guidance documents and technical information that can be incorporated into the development process. Figure 3 is a design process flow chart that was developed as part of the guidelines. The goal is the development of a site to mimic pre-development levels of infiltration, runoff, and Time of Concentration. The guidelines include the development of pre-, post- and “LID” curve numbers, and recommended means of accounting for volume storage achieved by practices such as bioretention and amended soils. Also included is a flowchart depicting the LID design process. An option for a hybrid approach (using conventional practices to make up for excess volume not managed by LID practices) is built in to the guidelines, but is discouraged.



**Figure 3: LID Flowchart**

**Project Follow Through**

The projects have just been delivered to the local government and are currently being evaluated for formal adoption in the ordinance. The rate of development in the Town is currently very low. The first project to be reviewed under the new LID approach is expected to be completed within the next several months. The products of this project are being made available to other local governments to help guide their adoption of LID strategies. Additionally, a multimedia CD is currently being developed which chronicles the Warsaw project and includes the project deliverables. Project products are available on the web at <http://for.communitypoint.org>.

**Background and References**

Friends of the Rappahannock Website, <http://for.communitypoint.org>

Low Impact Development Center. 2002, Low Impact Development Stormwater Resource Website. <http://www.lid-stormwater.net>

Prince George’s County Maryland, 1999, Low Impact Development Design Strategies, Prince George’s County, Maryland

Virginia Department of Conservation and Recreation, 2001. Virginia Stormwater Management Handbook, Richmond Virginia. <http://www.dcr.state.va.us/sw/stormwat.htm>



# **AN ASSESSMENT AND PROPOSED CLASSIFICATION OF CURRENT CONSTRUCTION AND POST CONSTRUCTION STRUCTURAL BEST MANAGEMENT PRACTICES (BMPs)**

David A. Woelkers  
Hydro Compliance Management, Inc.  
Ann Arbor, Michigan

Marc S. Theisen, M.S., CPESC  
SI Geosolutions  
Chattanooga, Tennessee

Jerald S. Fifield, Ph.D., CPESC  
Hydrodynamics, Inc.  
Parker, Colorado

## **Abstract**

The more stringent NPDES Phase II Storm Water regulations of the US Environmental Protection Agency (EPA) Clean Water Act are set to take effect in March of 2003. This legislation will require a growing number of municipalities, construction and industrial sites to develop, implement, and enforce storm water management programs to reduce the discharge of pollutants to the “maximum extent practicable” to protect water quality. Compliance with these enhanced EPA policies will lead to an inevitable increase in the development and use of sediment control measures and other storm water treatment Best Management Practices (BMPs).

During the past few years a growing number of sediment control and storm water treatment devices have entered the market. Unlike products or techniques designed only to limit or control erosion, these devices are intended to help filter, capture and contain sediment transport (the by-product of erosion) and other pollutants that are generated and transported during and after construction related activities. As with many emerging technologies, confusion may develop as appropriate applications for specific products or families of products are not yet clearly developed and/or sufficiently defined. This may result in end-users lacking clear direction on the proper selection and/or use of these devices for specific applications.

This paper will propose a comprehensive and logical system to organize into classifications the growing range of BMPs and techniques for specific prescribed functions or applications while integrating these applications into the pre-construction, construction and post-construction phases of land disturbing, site development activities. This classification system is intended to assist planners, contractors, designers, and regulatory agencies so that they may have a better understanding of BMP selection based on application needs for protecting the environment from the negative impacts of construction and post-construction storm water runoff. It is hoped that these proposed classifications combined with increased field experience will evolve into practical and cost-effective methods of BMP selection for an increasingly diverse array of storm water treatment measures and applications.

## **Background**

With the application deadline for National Pollutant Discharge Elimination System (NPDES) Phase II Storm Water Permit coverage rapidly approaching storm water professionals, contractors, and end-users will need a systematic and logical method for establishing techniques, management tools and classifications of Best Management Practices (BMPs) to be integrated into the construction phase for storm water management. The new requirements of Phase II lower the threshold for permit coverage for construction activities from 5 acres to 1 acre. In addition, regulations affecting municipalities and public entities with Municipal Separate Storm Sewer Systems (MS4s), within urbanized areas may also result in additional local construction requirements.

Regulators have two primary concerns that will underlie storm water requirements in the site plan approval processes. These are the control of water *quantity* and *quality* both during and after the construction phase. Water quantity outputs from sites will generally be limited to pre-development levels. Water quality issues will focus on the reduction of contaminants from the runoff prior to its discharge from the site. Sediment has been recognized by EPA and others as the most prevalent constituent of concern for US receiving waters. (Northcutt 1992 and Theisen 1991). It will be the focus of most of the BMPs discussed in this paper. Other problematic constituents include nutrients, metals, hydrocarbons and other organic compounds, bacteria, and others, and each site must be analyzed to determine specific application needs. Understanding what types of structural BMPs are available and how they interact with one another will help provide guidance in selecting the right mix for a specific site.

A major consideration to be determined is how maintenance will be assured and performed over the long run. Thus, planners need to think of BMP selection as a revolving process of Installation, Inspection, Maintenance and Enforcement (I<sup>2</sup>ME). While this paper focuses on the selection aspects, decision maker need to consider the latter three components to insure quality-based selections of appropriate BMPs. Many techniques and technologies may involve lower upfront costs, but maintenance costs over time must be factored into the equation.

In order to ensure that the maximum benefit is achieved planners will need to evaluate various BMPs in the pre-construction, construction, and post-construction phases to ensure their plans are approved in a timely and cost-effective manner.

## **Phases of Construction**

### ***Pre-Construction***

The pre-construction phase will require a careful analysis of the specific site. The first step will be to gain a clear understanding of what storm water controls are required by state regulations, local ordinances and site plan approval processes. Nearly all will require controls during the construction phase to control sediment and to limit runoff from the site in order to ensure minimum impacts on downstream receiving waters. The primary construction concern will be sediment control and a wide range of both temporary and permanent BMPs will be needed. Each application must be examined to determine site specific needs for laying out the sequence of selecting both temporary and permanent BMP's. This sequence is commonly referred to as the "treatment train" and a clear understanding of all available options is critical for a successful site plan.

According to EPA's Preliminary Data Summary of Urban Storm Water Best Management Practices an urban storm water BMP is a "technique, measure or structural control that is used for a given set of conditions to manage the quantity and improve the quality of storm water runoff in the most cost-effective manner." Many people only have a vague understanding of the range of BMPs available, and with ongoing research, new BMPs are constantly emerging. In fact, the term 'Best Management Practices' would be more accurately phrased as 'Better Management Practices' because what is 'best' varies with each situation

In devising an effective organization of BMPs to assist planner and end users in the selection process several factors must be considered. First, the proposed land use of a project must be determined. These possible uses include industrial, commercial, residential, and streets and highways. For each of these various uses the specific site application needs must be determined. Consideration should be given to whether the project is new or re-development. A detail review of receiving water concerns along with an analysis of the potential pollutants of concern that might be generated on the site and that could have a negative impact also needs to be completed prior to BMP selection.

Once a review of the land use and receiving water concerns is completed then a review of the appropriate BMP options can be evaluated. The wide range of BMP options can be organized into several classifications by determining what the BMP can accomplish. Many are designed to control erosion and contain sediment transport. This is particularly important in the active construction phase where site stabilization has not yet occurred. Other BMPs deal with controlling the quantity of run-off that will occur as a result of both construction activities and post-construction changes in flow that will occur as a result of increased imperviousness on the completed site. Again, this will be a factor of the intended land use. Finally, many BMPs are utilized for treatment of run-off to reduce pollutants that are generated during the construction and post-construction phases.

Many quality and quantity issues can be resolved through efficient site designs that incorporate practices that prevent the transport of water and pollutants from increasing as a result of development. These preventive measures can greatly reduce the need for reactive designs and technologies that are needed to contain water and remove pollutants of concern. It is, however, beyond the scope of this paper to analyze Better Site Designs. Instead the focus will be on the organization of structural BMPs and related Storm Water Treatment Devices (SWTDs). SWTDs are structural or non-structural BMPs that positively impact Storm Water quality before, during or after construction or construction related, land-disturbing activities. SWTDs may be temporary or permanent depending upon their desired application or function.

Structural BMPs can be divided into three primary types. These include Vegetative Techniques and Open Space Designs, Designed Structures, and Manufactured Technologies. The following chart lays out a proposed organization of BMPs based on type and function.

## **Classification of Structural BMPs**

### **Vegetative Techniques and Open Space Designs**

- Constructed Wetlands
- Bio-retention Systems
- Swales
- Filter Strips
- Rain Gardens
- Green Roofs

### **Structural Designs**

- Porous Pavement
- Below Surface Chamber Systems
- Infiltration Basins/Trenches
- Drywells
- Detention Basins
- Oversized Pipes
- Retention Ponds (Wet Ponds)
- Design-Sand Filters

## **Manufactured or “Proprietary” Devices**

- Hydrodynamic Separator Systems
- Filtration Systems
  - In-Line Filtration Systems
  - Catch Basin Inserts – Long Term/Short Term
  - Exterior Treatments
- Storm Water Underground Storage Tanks
- Fabricated Underground Piping Systems

A broad overview of various BMP types is provided below in the post-construction phase section to help clarify the assessment and selection process for meeting construction and post-construction requirements.

## ***Active Construction***

### **Sediment-Containment Systems**

The role of sediment control systems is to create conditions for sedimentation, allowing for the settlement of soil particles that are held in suspension. When soil-particle transport mechanisms flow at slow rates, particles may settle out of suspension. How deposition occurs may depend upon several parameters.

Sediment-control systems are generally hydraulic controls that function by modifying the storm-runoff hydrograph and slowing water velocities. This allows for the deposition of suspended particles by gravity. Some of the more common names for these structures are sediment basins, sediment ponds and sediment traps. When designed correctly, sediment-containment systems should provide containment storage volume sufficient to handle incoming waters, create uniform flow zones within the containment storage volume for deposition of suspended particles and discharge water at a controlled rate.

When all runoff waters are captured, efficiency of the containment system is near 100%. However, the feasibility of retaining all runoff waters from a construction site is usually impossible since large containment areas and volumes are required. In addition, evaporation and infiltration might not be sufficient to drain the system before the next storm event occurs, which may cause flooding problems. Finally, retained waters may hamper maintenance of the system since removal of captured sediments becomes more complicated with the presence of water.

Due to the above concerns, rather than attempting to retain all runoff waters, a containment system should provide sufficient volume for capturing suspended particles while allowing discharge to occur. This provides the advantage of detaining incoming runoff to control the discharge of suspended particles while not requiring large areas to store runoff waters. Flooding problems from sequential storm events are reduced since contained waters will usually be drained from the system between events. Finally, frequent maintenance is facilitated because the sediments do not remain saturated with water.

If detention of runoff from construction sites is to be effective in removing suspended particles, contained waters must remain long enough for deposition of suspended particles within the system. Since outflow from the system will occur, 100% reduction of all incoming suspended particles will not be possible. However, high efficiencies can occur for sediment-containment systems developed for design-sized particles. (Fifield, 1995 and 1996.)

Sediment-containment systems may be characterized using the following assumptions. Goldman (1986) defined a structure that treats runoff from 2.0 ha (5.0 ac) or less as a “sediment trap.” When the contributing area to the structure exceeds 2.0 ha, then a “sediment basin” is used. Both structures are “sediment-containment systems” that function on the principles discussed previously.

EPA has suggested that the design of any sediment-containment system be based upon capturing the volume of runoff resulting from a 2-year, 24-hour storm event (US EPA 1992 and 1998). The problem with considering only the

volume from a contributing area is that it does not take into account the size of the particles generated by upstream eroding soils. Table 1 provides suggested definitions for sediment-containment systems.

**Table - 1** - Defining Sediment-Containment Systems Using Particle Diameters (Fifield, 2001)

<b>Sediment-Containment System Type</b>	<b>Design Particle Size</b>
Type- 1 Sediment-Containment System	Design- Size Particle $\leq 0.045\text{mm}$
Type- 2 Sediment-Containment System	$0.045 \text{ mm} < \text{Design-Size Particle} \leq 0.14 \text{ mm}$
Type- 3 Sediment-Containment System	Design-Size Particle $> 0.14 \text{ mm}$

***Type- 1 Sediment-Containment Systems***

A Type-1 sediment-containment system will require development of a structure to capture the maximum possible number of medium silt and smaller suspended particles. Since particles of this size have low settling velocities, large storage volumes, long flow-path lengths, and controlled discharges are required. Type-1 systems are designed to have the highest possible net efficiency and are best represented by the traditional sediment basin and trap.

***Type-2 Sediment-Containment Systems***

The Type-2 sediment-containment system will capture suspended particles having higher settling velocities than particles requiring Type-1 structures. Consequently, smaller storage volumes and shorter flow-path lengths can be used. As with a Type-1 structure, these sediment control systems will also have controlled discharges. While their net effectiveness for the entrapment of all suspended solids may be low, Type-2 systems will still have a high apparent effectiveness.

***Type-3 Sediment-Containment Systems***

The least effective methods to control suspended particles in runoff waters are represented by Type-3 sediment-containment systems. These are not necessarily design structures, but are often temporary BMPs found on construction sites. Examples include straw or hay bales and silt-fence barriers, inlet control structures, and drainage ditch check structures.

Whenever significant runoff occurs, all Type-3 systems have very low net and apparent effectiveness to control suspended particles. However, when runoff quantity is low, the Type-3 sediment control systems can be effective in reducing suspended particles as long as they are continuously maintained.

**The Effectiveness and use of Sediment-Containment Systems**

Documentation on the effectiveness of containment systems for trapping suspended solids is limited, and there are conflicting opinions on their actual effectiveness. However, if properly designed, constructed, inspected, and maintained, containment systems are effective in trapping some sediment.

This discussion will focus on selected, man-made non-structural Type-3 sediment-containment systems that act as barriers or filters. Since their effectiveness is minimal for large runoff events, they do not require the detailed designs needed for Type-1 and Type-2 containment systems. These devices must be carefully installed and in conjunction with Type-1 and Type-2 systems to minimize downstream problems since their usefulness is generally limited to low

volume flows from smaller storm events. As such, these systems are typically only used and installed during the pre- and active-construction phases of a project.

A barrier is any structure that obstructs or prevents the passage of water. If runoff cannot pass through a barrier, then water will either be contained or flow over the structure. Consequently, small sediment barriers may function as a Type-3 system or as a method to reduce flow velocity. Commonly used man-made barrier devices include silt fences, continuous geotextile-wrapped berms, turbidity barriers, and geosynthetic silt dikes. An example of a silt fence is shown in Figure 1.

**Appropriate places to use sediment control barriers include:**

- Along sections of a site perimeter
- Below disturbed areas subject to sheet and rill erosion
- Below the toe of exposed and erodible slopes
- Along the toe of stream and channel banks
- Low flow swales and ditches
- Around area drains or inlets located in a sump
- Turbidity barriers are used in low flow streams, tidal areas or lakes

**Inappropriate places to use sediment control barriers include:**

- Parallel to a contour when installed on a hillside
- In channels where concentrated flows occur, unless properly reinforced
- Upstream or downstream of culverts where concentrated flows occur
- In front of or around inlets where concentrated flows occur and sump conditions do not exist
- In continuously flowing streams or ephemeral channels

Other Type-3 devices designed to provide filtration include geotextile catch basin inserts, geosynthetic drainage and curb inlet filters, geotextile tubes, and geotextile filter bags. These materials allow water to flow through them while filtering or capturing sediment. Selection of the correct geotextile or fiber consistency will reduce the possibility of blinding or clogging of the device with excessive sediment. An example of a Type I geotextile catch basin insert is shown in Figure 2.

Appropriate places to use geosynthetic filters would be in front of or around gutters and drain inlets where *sump conditions exist* and areas of de-watering of detention/retention ponds or dredging of construction and/or industrial spoils.

Inappropriate places to use geosynthetic filters would include in front of or around inlets where concentrated flows occur and *sump conditions do not exist* in channels where concentrated flows occur or in continuously flowing streams or ephemeral channels.

Man-made geosynthetic Type-3 barriers and filters have numerous advantages over traditional sediment control practices derived from natural materials. They are normally easier to transport, install and maintain versus straw and hay bales or soil and rock structures. Manufacturing and fabrication consistencies enable performance of geosynthetic devices to be more predictable and generally superior to natural materials. In many cases these devices may be washed and reused which makes their usage highly cost effective versus using traditional practices or nothing at all. Thus the acceptance and usage of geosynthetic sediment- and erosion-control devices has increased dramatically over the past few years (Theisen, 1991, Theisen and Hunt, 2001).



**Figure 1** – Example of Silt Fence Containing Sediment -- Geotex<sup>®</sup> by SI Geosolutions



**Figure 2** – Example of Type 1 Geotextile Catch Basin Insert -- Siltsack<sup>®</sup> by ACF Environmental

## ***Post-Construction***

Structural BMP's are techniques that can be used to address flow quantity control and pollutant removal in wet weather runoff. These BMPs can include site-specific engineered designs as well as proprietary systems. The challenge with any attempt to organize or classify BMPs by type or function is that many fit into multiple categories. However, in the interest of clarity structural BMPs can be grouped into several subcategories by function that includes the following.

- Infiltration systems
- Detention systems
- Retention systems
- Vegetated systems
- Filtration systems
- Hydrodynamic separation systems

### **Infiltration Systems**

Infiltration systems are designed primarily to reduce the quantity of storm water runoff from a particular site. Increasing urbanization and percentage of impervious surfaces has resulted in substantial increases of surface runoff, causing serious degradation of urban streams and the corresponding negative impacts on aquatic health BMPs for Phase II. The use of infiltration techniques can reduce the amount of surface flow and direct the water back into the ground. Advantages of infiltration techniques include the recharging of groundwater supplies and the removal of certain pollutants such as sediments. Care must be exercised, however, in determining whether infiltration is best for a specific application, especially when groundwater is the source of drinking water in the area. Infiltration can result in groundwater contamination since soils that allow good infiltration also allow rapid migration of certain pollutants. In these situations, infiltration should not be used without effective pretreatment. Conversely, poorly permeable soils can prevent an infiltration system from functioning.

Infiltration techniques can be divided into several different classifications depending on site needs. Regardless of the classification a careful understanding of the soil type is necessary since certain soils, such as clays, are poor infiltration types. If the soil type is appropriate for infiltration then the next step in the evaluation is determining which method is most appropriate. A site with minimal land space would be a likely candidate for porous pavement, and sub-surface chamber systems that can store water below impervious surfaces and allow for slow infiltration after the end of a wet-weather event. Conversely, sites with sufficient space should utilize infiltration basins, vegetative practices, constructed wetlands and open space designs.

### **Detention Systems**

These BMPs are designed to temporarily hold storm water runoff for gradual release into receiving waters. Detention systems are used primarily to reduce peak discharges to prevent flooding, stream bank erosion, and channel alterations. Straight up Detention systems are generally not very effective for removing pollutants unless combined with other BMPs. Many detention systems incorporate characteristics normally utilized with retention ponds, such as permanent pools, to prevent subsequent scouring. Examples of detention systems include detention basins, underground tanks, oversized pipes, and fabricated underground high-density polyethylene piping systems such as Storm Compressor<sup>TM</sup>.

### **Retention Systems**

Retention systems are intended to capture and hold runoff from entering receiving waters. Because retention systems are designed for permanent containment of storm water, they can also be a good infiltration and or filtration BMP



with the right conditions, thus providing both water-quantity and water-quality control. Retention systems can be in a variety of forms such as green roofs, but most retention systems are in the form of ponds or basins, (also commonly referred to as wet or detention basins) and when certain types of aquatic vegetation or aerators are added, the systems can actually provide further water treatment (see figure 3 below). As with all BMPs, regular maintenance is essential to maintain a healthy retention pond. Clay siltation can result in a substantial loss of infiltration, resulting in a sharp increase in overflow from the basin during wet-weather events. Without maintenance, retention ponds will eventually fill in and become ineffective. In addition, certain pollutants can become concentrated in the area, potentially requiring remediation.

Most storm water collection ponds are in fact combinations of retention and detention applications. While these ponds are designed to hold most flows they are usually equipped with some sort of overflow system to prevent flooding over their banks. These overflow systems are either reset in the middle or end of the ponds or a spillway of rip-rap, other coarse materials or vegetated turf reinforcement mats. When the runoff into the pond is from an impervious area with high vehicle traffic, post-treatment devices in the riser can provide initial management of floating oils and other toxins prior to discharge into the receiving waters.



**Figure 3** – Example of Wet Pond (courtesy of Hydro Compliance Management, Inc.)

## **Vegetative Systems**

### ***Constructed Wetland Systems***

Constructed wetlands are a very effective BMP for both pollutant removal and runoff storage (see figure 4 below). When properly designed, they incorporate the processes of sediment removal, microbial decomposition, and aquatic plant uptake. Sites for constructed wetlands must be carefully selected to ensure that sufficient waters are available in dry weather to sustain the wetlands. Areas with shallow groundwater levels are ideal. Heavy sediment loads can quickly degrade a constructed wetland. Pretreatment of sediment flows must be considered if this is the case.

Generally, natural wetlands should be preserved and not used as a BMP because changing hydrology can significantly degrade a natural wetland.

Other wetland BMPs include wetland basins and channels. These BMPs do not necessarily require open waters and can instead be in the form of wetland meadows that have surface water only for short periods of time after precipitation events.



**Figure 4** - Example of Constructed Wetland (courtesy of Ingham County, Michigan, Drainage Commission)

### ***Bio-retention and other Vegetated Systems***

Bio-retention and vegetated systems, such as buffers and swales, are variations of infiltration and filtration systems. The media in these systems are actually natural vegetation and soil beds that allow ponding and gradual infiltration. The vegetation and underlying soils can filter a variety of pollutants from runoff. In addition, these systems can be used to reduce the quantity of flow. This category of BMP includes large bio-retention systems, swales, rain gardens, grass filter strips, and even green roofs. The use of these "natural" systems in site development can significantly cut down on surface runoff and reduce the need for other more costly structural BMPs. An example is shown in Figure 5 below.



**Figure 5** – Example of Bio-retention Swale (courtesy of Hydro Compliance Management, Inc.)

### **Filtration Systems**

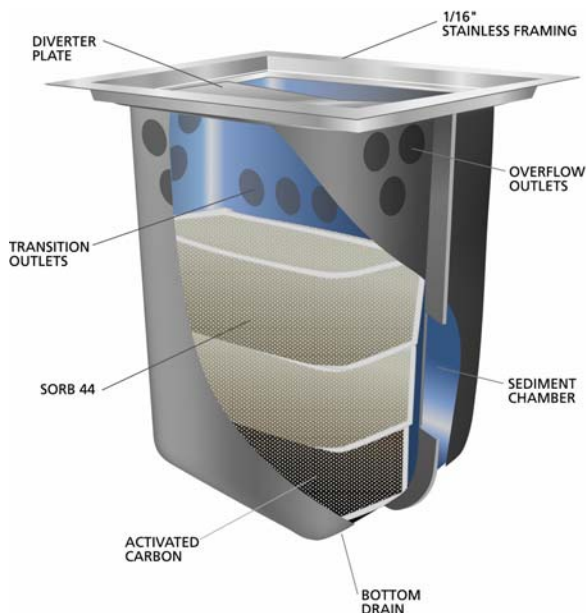
Filtration systems are BMPs that use media to remove particulates from runoff. They are typically used when circumstances limit the use of other types of BMPs, such as where space is limited—particularly in a highly urbanized setting—or when it is necessary to capture particular industrial or commercial pollutants such as hydrocarbons or metals. In these circumstances, other BMPs might be cost-prohibitive or not as effective. Filtration devices can also work well as pretreatment systems for other types of BMPs. For example, infiltration systems that move water directly to ground aquifers might require pre-treatment for certain contaminants to maintain effective well-head protection of drinking-water supplies.

Filtration systems can be either designed into a site plan, such as sand filter systems, or be manufactured technologies such as catch-basin inserts or in-pipe systems. An example of a filtration device is shown in Figure 6. Many different filtration media are available, such as sand, peat, absorbents, and activated carbon. The choice depends on the particular application.

When considering filtration systems, planners need to consider flow rates. As a result of the volume of water being moved in a wet-weather flow, filters generally need to focus on treating at least the first quarter inch of runoff and allow bypass for high-flow events. Filters should incorporate pre-settling sediment chambers to remove sediments that can clog the filters and reduce flow rates and effectiveness. An effective filtration system should be able to demonstrate removal efficiencies for specific contaminants. Again, as with all BMPs, regular maintenance is essential.

Proprietary filtration devices are catch-basin inserts or in-pipe designs that remove various pollutants. Effective designs should use non-leaching media, incorporate pre-filtration sediment removal chambers or other measures to reduce plugging, and be accessible for regular maintenance. In addition, filtration devices need to be designed with overflow bypasses to prevent flooding caused by high flow rates or plugging of the filters. A properly designed

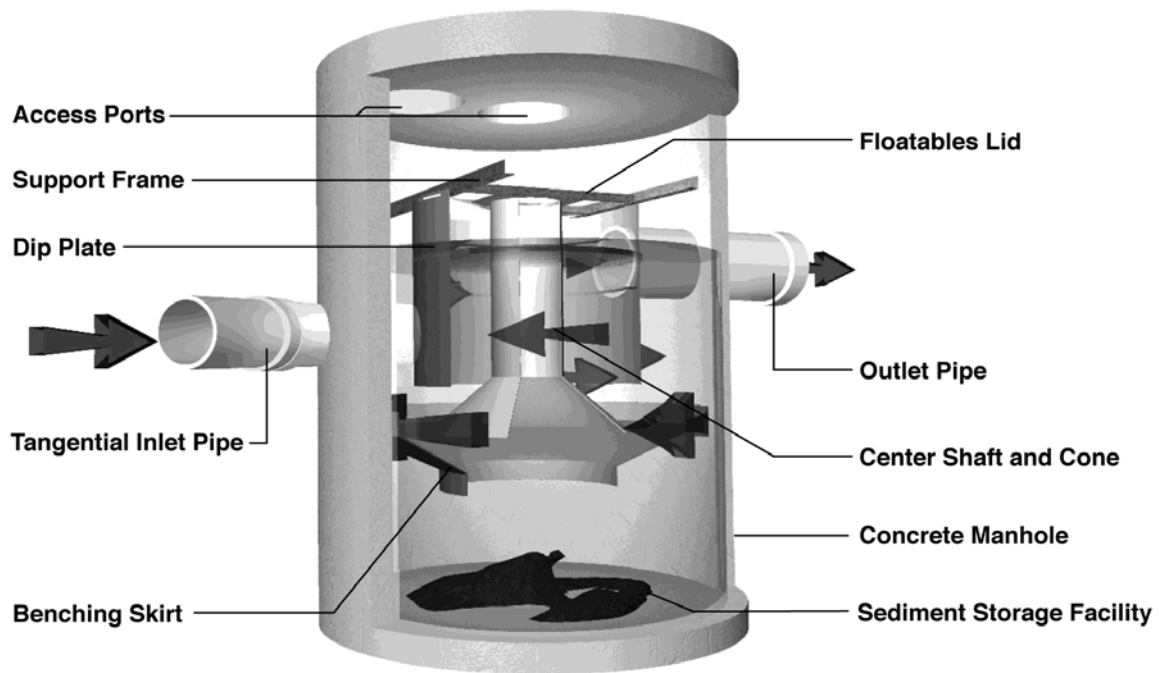
filtration system can be a useful device for urban hot-spot applications where a particular pollutant is being targeted. It also can be cost-effective where land use does not allow other economical BMP options. This is particularly true with existing sites in urban settings. Proprietary systems can be effective pre-treatment or post-treatment devices for infiltration systems and other BMPs.



**Figure 6** - Example of Catch-Basin Filtration System -- Hydro-Kleen™ Storm Water Filtration System

### Hydrodynamic Separator Systems

These systems remove sediment, debris, and surface oils and grease through various hydrodynamic designs. Effective separator systems trap and separate pollutants to prevent them from being reintroduced into runoff, which can result from "scouring" or other actions prompted by the powerful energies created from heavy volumes of storm water runoff. Effective systems have protective zones for pollutant storage to prevent re-suspension or washout of contaminants and stabilize the flow regime to minimize turbulence. Systems with stabilized rotary flow regimes tend to have smaller footprints than conventional gravity separators. An example is shown in Figure 7.



**Figure 7** - Example of Hydrodynamic Separator System -- Downstream Defender® -- Hydro International, Inc.

## Functions of Storm Water Treatment Devices

SWTDs may be “proactive” or “reactive” in their approach or application. Examples of proactive SWTDs include erosion control practices, green roofs, vegetative filter strips, or rain barrels. Reactive techniques might employ sediment control practices, in-line treatment devices, sedimentation ponds, and detention/retention systems.

Basic functions of SWTDs may be grouped into five major categories. These are Sediment Containment, Filtration, Separation, Infiltration, and Underground Detention. Again, it is beyond the scope of this paper to describe and classify all the BMPs that may be used to fulfill these functions. Various manufactured SWTDs may be grouped by primary function as shown below.

### Basic Functions of Storm Water Treatment Devices

- Sediment Containment
- Filtration
- Separation
- Infiltration
- Underground Detention

It is beyond the scope of this paper to describe and classify any and all BMPs or SWTDs that may be used to fulfill these functions. This paper, however, does describe various man-made SWTDs may be grouped by primary function as shown below.

**Sediment Containment**

- Silt Fences (SF)
- Continuous Berms (CB)
- Wattles (W)
- Drain Inlet Barriers (DIB)
- Channel Silt Dikes (CSD)
- Turbidity Barriers (TB)
- Geotextile Filter Bags (GFB)
- Geotextile Tubes (GTT)

**Filtration**

- Catch Basin Inserts (CBI)
  - Type I – Geotextile Filtration Systems (GFS)
  - Type II – Multi-Chamber Permanent Structures (MPS)
- Curb Inlet Filters (CIF)
  - Type I – Exterior - Geotextile Filtration Systems (GFS)
  - Type II – Interior - Multi-Chamber Interior Filtration Systems (MIF)

**Separation**

- Hydrodynamic Separation Devices (HSD)

**Infiltration**

- Infiltration Chamber Systems (ICS)

**Detention**

- Underground Piping Systems (UPS)

Once the function required of a SWTD has been determined, it is then time to consider when and where it should be employed. These two considerations are as important as the selection of the correct SWTD to be used. Failure to properly install a SWTD in the correct location or sequence of a land-disturbing activity may result in failure or compromised performance.

Once the application or function and appropriate construction phase of the required storm water treatments have been determined, these parameters may be coupled to facilitate selection of the most appropriate SWTD. Table 2 presents a matrix that combines function with construction phases for identifying potential SWTDs for selection consideration.

**Table 2** – Function and Typical Construction Phase(s) for Application of Manufactured Storm Water Treatment Devices

<b>Function</b>	<b>Construction Phase</b>		
	<b>Pre-Construction</b>	<b>Active Construction</b>	<b>Post-Construction</b>
<b>Sediment Containment</b>	SF, CB, TB	SF, CB, CBI, DIB, CIF, CSD, TB, GFB, GTT	CBI, CIF, HSD
<b>Filtration</b>		CBI, CIF, GFB, GTT	GFB, GTT, HSD
<b>Separation</b>			HSD
<b>Infiltration</b>			ICS
<b>Detention</b>			UPS

Finally, where to use a SWTD must be considered. Again, it is beyond the scope of this paper to present specific site locations for the vast potential variances of SWTD applications. Good discussions for placement of several of these materials during active construction may be found in publications by Fifield as well as in EPA publications. Table 3 below presents a matrix coupling site location with the various construction phases. Combining Tables 2 and 3 may help end users to make informed decisions when considering SWTDs for various functions, construction phases and site locations.

**Table 3** – Site Location and Typical Phase(s) of Construction for Application of Manufactured Storm Water Treatment Devices

Site Location	Construction Phase		
	Pre-Construction	Active Construction	Post-Construction
Perimeter	SF, CB	SF, CB	
Catch Basin Inlet, Curb Inlet		CBI – Type 1 & II, DIB, CIF, HSD	CBI – Type II, CIF, HSD
Channel		CSD	
Slopes	SF, CB, W	SF, CB, W	
Waterway	TB	GTT	GTT
Sediment Basin/Trap		GFB, GTT	
Below Impervious Surfaces			ICS UPS

## Conclusion

In order to insure that regulators, planners, engineers and contractors have a clear picture of what techniques and measures can be utilized in the various construction phases for proper BMP management, a solid understanding of the options is essential. By classifying the various sediment controls and post-construction BMPs into proper applications, storm water professionals are far more likely to develop efficient yet cost-effective storm water plans for specific projects. The result will be cleaner water and a more satisfied general public. A thorough understanding of the Installation, Inspection, Maintenance, and Enforcement requirements will also result in a more comprehensive and realistic cost analysis of the project.

## Literature Cited

Goldman, Steven J., Jackson, K, and Bursztynsky T.A. 1986. Erosion and Sediment Control Handbook. McGraw-Hill Book Company, New York, NY.

Fifield, Jerald S. 2001. Designing for Effective Sediment and Erosion Control on Construction Sites. Forester Press.

Fifield, Jerald S. 2002. Field Manual on Sediment and Erosion Control – Best Management Practices for Contractors and Inspectors. Forester Press.

Northcutt, Ben. 1992. The Erosion Control Industry – A Look at It’s Past, Present and Future. Proceedings: High Altitude Revegetation Workshop No. 10, Ft. Collins, CO USA, 1992.

Theisen, Marc S., 1991. "The Role of Geosynthetics in Erosion and Sediment Control: An Overview", *Proceedings of the 5th GRI Seminar*, Philadelphia, PA, pp. 188-203.

Theisen, Marc S. and Hunt, Daniel L., 2001. "An Overview of Current Rolled Erosion Control Product (RECP) Design Practices – Science with a Bit of Art", *Proceedings of the 15th GRI Conference*, Houston, TX, pp. 130-154.

US Environmental Protection Agency, 1992. "Final NPDES General Permits for Storm Water Discharge from Construction Activities." *Federal Register*, Part II, Notice. US Government Printing Office, Washington, D.C. September 9.

US Environmental Protection Agency, 1998. "Reissuance of NPDES General Permits for Storm Water Discharges from Construction Activities." *Federal Register*, Part II, Notice. US Government Printing Office, Washington, D.C. February 17.

US Environmental Protection Agency, 1999. *Storm Water Technology Fact Sheet: "Hydrodynamic Separators"*, EPA-832-F-99-017.

US Environmental Protection Agency, 2000. "*Storm Water Phase II Final Rule, An Overview*", EPA 833-F-00-001.

US Environmental Protection Agency, 2000. "*Storm Water Phase II Final Rule, Small MS4 Storm Water Program Overview*", EPA 833-F-00-002.



# **OVERCOMING CHALLENGES IN ESTABLISHING A REGIONAL PUBLIC EDUCATION AND OUTREACH PARTNERSHIP**

Michael A. Worlton, PE and J. Ryan Christensen  
RBF Consulting  
Phoenix, Arizona

## **ABSTRACT**

Over the past twelve years, many Phase I Municipal Separate Storm Sewer System (MS4) operators have established programs for public outreach. Often these programs have focused on specific municipalities using varying approaches. With the implementation of the National Pollutant Discharge Elimination System (NPDES) Phase II rules by USEPA, smaller municipalities are faced with the challenge of creating effective public outreach programs. Although Phase II rules provide more comprehensive guidance, Phase II municipalities typically have fewer resources at their disposal.

Phase II rules emphasize the importance of forming partnerships for public outreach and education. These partnerships can provide the benefits of pooled resources, reduced costs, and a more consistent and effective outreach program. While there are clear benefits of forming regional public outreach and education partnerships, many challenges must be overcome to establish an effective and equitable program.

This paper discusses key issue areas that were addressed in the successful establishment of a regional public outreach partnership involving ten municipalities in the metropolitan Phoenix, Arizona area. These include issues related to membership, local perceptions, funding, the decision-making process, and leadership.

## **Introduction**

The USEPA's National Pollutant Discharge Elimination System (NPDES) Stormwater Permit Program was introduced to reduce the number of impaired surface water bodies within the United States. When one considers the requirements of the Phase I and Phase II programs, one may simply envision BMPs being put into place to minimize polluted stormwater runoff flowing into our nation's treasured streams and lakes. These water bodies not only serve as a valuable natural resource, but also may enhance quality of life.

When applied to the desert southwest, this vision of the NPDES program is not so easy to grasp. First, very little rainfall is received in desert areas. Secondly, in the desert, the term river is more commonly associated with a dry riverbed than a flowing body of water. These realities play a significant role in influencing public opinion about stormwater pollution.

With these realities in mind, regulated MS4s throughout the Phoenix Metropolitan area recently came together to form a regional public outreach organization. This paper describes how Phase I and Phase II municipalities worked together to change the way stormwater quality concerns are perceived in an area where some view these concerns on the same level as UFO sightings. This paper discusses the methods used, challenges encountered, and lessons learned in forming a stormwater public outreach group in the Phoenix Metropolitan area.

## History

NPDES permit requirements implemented in 1990 brought new connotations to the word “stormwater” in Arizona, as larger municipalities were faced with the challenge of regulating stormwater quality. When speaking of stormwater, in an arid climate that only receives an average rainfall of about six-inches per year (<http://ag.arizona.edu/oals/watershed/highlands/climate.html>), pollution is not the first issue that comes to mind. Nonetheless, Arizona’s Phase I municipalities worked diligently to successfully implement effective stormwater programs. Representatives from these municipalities often shared ideas and information, but their respective NPDES permit applications and programs varied from municipality to municipality. For example, permitted municipalities each developed unique programs to address public outreach, inspections, enforcement, representative rainstorms, and other program requirements.

This individual approach to NPDES issues in Arizona would change in 1997, when Pima County and the cities of Tempe, Tucson, Mesa, and Phoenix petitioned against numeric limitations on water quality standards (Case Name: Defenders of Wildlife V. Browner; Case Number: 98-71080; Date Filed: 09/15/99). The submission of the petition, and its subsequent defense in a lawsuit brought by Defenders of Wildlife, helped these municipalities form strong working relationships and unify their visions. In the late 1990’s, the cities of Glendale and Scottsdale were also issued NPDES permits, and began to interact with representatives from other Phase I communities in Arizona. By this time, Phase I communities had organized themselves to form a fairly cohesive unit, with a unified voice.

In early 2000, the State of Arizona’s Department of Environmental Quality (ADEQ) began working toward NPDES Permitting program approval (<http://www.adeq.state.az.us/environ/water/permits/azpdes.html#quest>). This event sparked the interest of other municipalities, many of which would be designated as regulated MS4s under the Phase II NPDES program. Many of the larger municipalities throughout the state worked together as stakeholders in ADEQ’s quest for NPDES. This process resulted in building a working relationship among the Phase I communities and several of the larger Phase II communities.

These events, which helped form the foundation for the NPDES Program in Arizona, played an important role in bringing municipalities together as partners. Relationships were developed, ideas were shared, and assistance was offered. This atmosphere provided a good foundation for the creation of a regional public outreach group. Several communities realized the benefits of working together on a regional level, and they began exploring the idea of a regional public outreach program.

## Forming a Regional Public Outreach Group

The first recommendation in the EPA’s Phase II Rule for developing public education and outreach programs is to form state or regional partnerships (EPA 2000). The EPA Fact Sheet on Public Education and Outreach (*Fact Sheet 2.3, Public Education and Outreach Minimum Control Measure, January 2000, EPA*) suggests that regional programs are more cost-effective since they utilize shared resources and existing education and outreach materials. As will be discussed later, there are additional benefits to regional public outreach groups. These benefits stem from the collective creativity and the variety of experience and interests shared by the group.

The concept of regulated communities in Arizona forming partnerships was not new, but, when public works planners from the City of Scottsdale met with the City of Phoenix’s chief water quality inspector to talk about public education and outreach, a new enthusiasm was generated. This enthusiasm was translated

into action, including the coordination of a meeting among several regional MS4s to discuss developing a cooperative public outreach and education effort.

### ***Identifying Membership***

The first challenge faced in organizing a regional public outreach group was identifying membership. Before the first meeting could be convened, a list of potential group members had to be created. It made the most sense to select municipalities affected by the regulation and located within a common geographical region and influenced by the same television and radio stations. It was also important to consider the communities that intermingle within the region. For example, a person who lives in Mesa may work in Phoenix, and shop in Scottsdale. Someone from Peoria may work in Glendale and watch Cactus League baseball games within the City of Surprise. Maricopa County was generally identified as the region of focus for the public outreach group. The original list of potential members included all known Phase I and Phase II municipalities in the selected region, Maricopa County Flood Control District, Maricopa Association of Governments (MAG), ADEQ, and various municipalities that were potential Phase II candidates. Key contacts for each municipal stormwater program were invited to attend. Once the potential members were identified, it was important that everyone had the opportunity to participate. Meeting announcements were distributed via email, and RSVPs were requested. When a municipality did not respond, a follow up call was made.

### ***Maintaining Focus***

The idea of this first meeting was to identify the level of interest for participation in the group, provide background information about the Public Education and Outreach requirements of the NPDES stormwater program, and discuss the viability of implementation. The inaugural meeting was held in June of 2001. Twelve municipalities participated. This meeting marked the commencement of a public outreach organization for the Phoenix Metropolitan area, now known as STormwater Outreach for Regional Municipalities (STORM). Enthusiasm at the meeting was very encouraging, and many municipalities showed an interest in participating.

Although there was consensus support at the meeting for forming a regional organization, there was no decision regarding where to go from there or immediate follow-up. Consequently, Phase I municipalities forged ahead with their permit reapplications independently, while Phase II communities attended NPDES-related seminars, began to budget, and contracted with consultants to prepare for completing their individual permit applications. Other priorities and lack of follow through from this initial meeting caused a loss of focus. This loss of focus was the second challenge to the establishment of the regional public outreach group. It would be almost another year before a second meeting was held.

## ***Establishing Leadership***

One key to moving forward with the formation of STORM was establishing leadership. At first, several people seemed willing to fill the leadership role. As time passed, however, it became apparent that someone would need to assert him or herself as the leader. This person needed to take the initiative and assume the role of coordinating with the selected municipalities and planning meetings. While the majority of the representatives from the municipalities were willing to participate in the organization, they did not have extra time needed to perform leadership duties such as setting a meeting time, arranging for meeting space, inviting members to attend, and establishing an agenda. A consultant who has represented several Phase I and Phase II communities in the region assumed this role. This leader ensured that the organization was established, interest did not wane, and that the group would move forward.

In May of 2002, a second meeting was held to reinitiate the regional public outreach effort. The goal of this meeting was to reconvene the group and establish a plan for the future. Some of the participants had changed, so this meeting brought new faces and new questions. The meeting was very well attended and the results were encouraging. During this meeting, it became clear that this was the first exposure to NPDES program requirements for some municipalities in attendance. It was necessary, therefore, to provide background information about the requirements of the Phase II Program and the associated responsibilities of the affected municipalities. The meeting also served as forum to identify common goals and outline advantages to the group members. It quickly became apparent that some of the municipalities desired to have a high level of participation, while others wanted to become involved only after the group had been established.

Both the Phase I and Phase II communities shared a desire to make this regional public outreach effort a success. The Phase I municipalities saw an immediate need to begin a regional partnership so they could integrate it into their existing programs, and the Phase II municipalities wanted to capitalize on the experience and resources of the Phase I municipalities. Many were interested in the group's success because there was a feeling that this group could truly have a positive impact on their community, and that those who participated in organizing this group would be part of something great. Another perceived benefit of the group was that it could reduce the public outreach burden on the individual municipalities. The Phase I municipalities with years of public outreach experience played a significant role in guiding the group.

## ***Making Decisions***

As subsequent meetings were held, more issues began to surface. One of the first issues to be tackled was determining the process by which the group would make decisions. Buy-in from the group as a whole was important, but there was always some disagreement among members about what the best decision might be. Consequently, the organization established a policy of majority rule and general consensus. This meant that decisions were narrowed down to the point where a vote could be taken, followed by a poll to ensure that all members could live with the results. This process was tested in the selection of a name and mission statement for the group. The group decided to adopt "STormwater Outreach for Regional Municipalities," or STORM, as the name. The mission statement agreed to was "*STORM promotes regional stormwater public education through outreach.*"

Another major issue addressed was financing the organization. This was a very difficult issue because it involved city budgets, intergovernmental cooperation, financial management, and finding an equitable way to distribute the projected costs of the program. Discussion among regional Phase II municipalities revealed common concerns about acquiring the resources to pay for the new program. Their budgets for the entire NPDES stormwater program ranged from \$10,000 to \$500,000. Most of the Phase I communities had already established budgets for public education and outreach, but there was concern about how much could be allocated to the group.

The City of Phoenix had already made a significant investment in outreach and educational materials. They freely shared all of the information and materials they had developed with other group members. These materials included a storm drain marker design, BMP pamphlets, and a comic book series detailing the adventures of “Storm Drain Dan,” a stormwater quality superhero. Phoenix also volunteered to send electronic copies of their printed materials so that other municipalities could customize them by changing the logos and contact information. While these materials came at no cost, another goal of STORM was to enable member municipalities to capitalize on the buying power of the group, and to share the costs of developing television and radio spots.

Because most budgets for the 2002-2003 Fiscal Year had already been established at the time the group got started, STORM members had some time before the next budget cycle to consider the benefits of participating on the group and determine their levels of commitment. Before the group could publish any materials, they needed to identify funding mechanisms. The following funding ideas were considered.

- Base membership fees on distinct population categories; similar to what is done by the National Association of Flood and Stormwater Management Agencies.
- Assess membership fees on a per capita basis. (i.e., \$0.05 per person within the municipality).
- Establish in-kind contributions in lieu of membership fees.
- Assess a flat membership fee for all members of the group.
- Pay as you go. Develop public education and outreach materials that municipalities can buy individually.
- Provide no funding. Use the group to share resources and ideas.

After much discussion, the group decided that the most equitable funding method was a fee-based approach, set according to each municipality’s population. Table 1 lists the first-year fees for the members of STORM. These fees are subject to change based on the programs the group chooses to implement in the future.

**Table 1.** STORM Population Based Fee Structure

<b>Population</b>	<b>Fee</b>
0 – 25,000	\$1,000
25,001 – 50,000	\$1,500
50,001 – 100,000	\$2,000
100,001 – 250,000	\$2,500
Greater than 250,000	\$5,000

Another issue involved dealing with perceptions by some of the local governments that stormwater pollution prevention is insignificant and a low priority. These perceptions were shared by the public and even some potential members of STORM. When City Managers and Councils do not consider stormwater runoff a high priority, it is unlikely that sufficient funding will be dedicated to stormwater quality programs.

An independent effort was initiated by Maricopa Association of Governments (MAG), an established regional planning organization, to educate and offer assistance to city managers. Another approach to educating decision-makers was for group members to work individually with their municipality's management. This presents an additional opportunity for the group to make an impact. The group discussed these issues and provided recommendations that would assist members in approaching decision-makers.

The group also addressed the issue of public perception. These perceptions will govern the types of outreach activities that each of the municipalities conducts. Group members stressed that the stormwater pollution prevention message had to be tailored to meet the needs of the area. While many areas of the country can use storm drain markers with slogans such as "No dumping... Drains to River," a more appropriate slogan for the Phoenix area would be "No dumping... drains to dry river bed." Therefore, more creative solutions must be presented, such as "Only Rain in the Drain" or "Storm Drains... No Dumping." The general feeling was that the message had to strongly target pollution prevention and have stormwater under tones. A regional group speaking to the public with a common voice and a consistent message has a much better chance of educating the public than inconsistent messages from independent sources.

The municipalities also expressed concern about how the group would be controlled. Members have to be committed to STORM either financially or through in-kind service in order to accomplish the organization's mission. Decisions will be made as a group, but someone has to be responsible for following through. The Flood Control District of Maricopa County (FCDMC) expressed a willingness to be the fiscal agent for the group, and will handle the funding through letter agreements with the member municipalities.

In order to address these concerns, a subcommittee of STORM has researched several models for the management of the funds and coordination of contracts. These models include several existing programs administered by the City of Phoenix, FCDMC, and various non-profit organizations. Based on these models a structure was established for the administration of STORM.

In establishing the organizational model for STORM, the members agreed that a board would be elected which would be responsible for organizing and facilitating the meetings, developing the meeting agendas, maintaining meeting minutes, and managing the group's money. The STORM board now consists of four members, including a chairman, a vice chairman, a secretary, and a fiscal agent. The board members are elected annually, and can serve for an unlimited number of terms.

The contractual agreement among the organizations was also addressed. Two different methods for the administering the contracts were put forth, a formal intergovernmental agreement, and an informal agreement. The members of STORM decided that the informal agreement would be easier and more effective to administer, since it would bypass the need for City Council approval. The informal agreement will be administered through the fiscal agent (FCDMC) who will submit a letter each year to the group's members assessing the fees due.

## **Lessons Learned**

Many challenges have been faced in the establishment of STORM, and many lie ahead. In the process of overcoming these challenges various lessons were learned that might assist others in developing a regional education and public outreach program.

### ***Understanding Needs***

Since the needs of each municipality dictate the direction of the regional education and public outreach group, it is important that these needs be identified. It was interesting to observe that the goal of some of the municipalities was to utilize the efforts of STORM to totally fulfill the public outreach requirements of their permits. Other municipalities only desired a minimal amount of participation, seeing the organization as merely a purchasing entity that would allow them additional buying power. Respecting and understanding these and other group needs lead to a balanced approach in establishing the objectives of the group. Understanding the needs of the group members also helped the group to remain focused on the issues that are most important.

### ***Taking the Initiative and Sustaining the Effort***

A lesson learned from the year-long lag in between the first and second meeting of STORM, was that finding someone to take the initiative in assuming leadership of the group was critical to establishing the organization. Additionally, if the effort is not sustained over time, little will be gained. Leaders and members of the group must be committed to the effort. Success in sustaining the organizational effort for STORM was realized through the following processes.

- Prepare and organize meeting details and agendas. It is important to meet in a central location and have an agenda that catches the attention of potential members.
- Identify and Invite potential members. A key to getting such a strong showing of Phase II municipalities, was getting the larger Phase I municipalities involved.
- Follow up on invitations personally. When a municipality neglected to RSVP, a personal follow up call was made to extend the invitation.
- Make assignments. When the members participate there is a sense of ownership and greater buy-in.
- Sustain the effort for future meetings. This was done by setting a date and time for the next meeting before adjourning.

The process of creating a successful regional public education and outreach organization does not happen over night. It takes careful planning, consistent effort, discipline, and cooperation to build the foundation of an organization that will have a lasting impact. STORM has found success in applying these principles.

## ***Realizing Results***

This stormwater public outreach organization that began as a dream is now thriving. Great momentum has been growing, and though the trail has been rough and the path ahead is long, the results are truly amazing to see. Some of the group's key accomplishments along the way are listed below:

- Existing Resources from Phase I MS4s have been shared with Phase II MS4s
- An Organizational Model, Strategic Plan, and Funding Mechanism have been formally adopted
- A Fiscal Agent has been assigned
- A Governing Board has been elected
- A grant application for \$250,000 in funding has been submitted to EPA on behalf of STORM
- A STORM website is being created
- STORM has been recognized as the cover story in the November/December issue of Stormwater Magazine
- Municipalities are budgeting for participation in the group by July 2003
- A new bond has been forged among participating municipalities

Each step toward these accomplishments was small. But steadily these steps moved STORM down the path to monumental accomplishments. The future of STORM is looking brighter all the time, and the leadership of STORM on regional stormwater education has been significant.

## **References**

ADEQ's Quest for NPDES Program Approval, 2002. Retrieved August 20, 2002 from Arizona Department of Environmental Quality Web site: <http://www.adeq.state.az.us/enviro/water/permits/federal.html#quest>

Climate, 2002. Retrieved August 20, 2002 from University of Arizona Web site: <http://ag.arizona.edu/oals/watershed/highlands/climate.html>

Environmental Protection Agency, 2000. Fact Sheet 2.3 Public Education and Outreach Minimum Control Measure, Storm Water Phase II Final Rule Fact Sheet Series.

**Michael A. Worlton, P.E.** and **J. Ryan Christensen** work in the water resources department of RBF Consulting's Phoenix office. They have assisted in the development of stormwater management programs for multiple NPDES Phase I and Phase II municipalities throughout Maricopa County, Arizona. Mr. Worlton led the establishment of STORM and is currently serving as facilitator of the organization.



# The WaterShed Partners: An Education Collaboration That Works.

Tracy Fredin,  
Director, Hamline University's Center for Global Environmental Education.  
Founding Steering Committee Member, WaterShed Partners

## **Executive Summary**

The WaterShed Partners is a coalition of over 50 non-profit and public organizations in the Twin Cities metropolitan area. Its mission is to promote public understanding that inspires people to act to protect water quality in watersheds. Formed in 1995, it is directed by a Steering Committee appointed from its member organizations that operates on a consensus basis. The activities of the WaterShed Partners are coordinated through Hamline University's Center for Global Environmental Education.

The WaterShed Partners' hallmark work over the past seven years has been the development of a traveling educational exhibit that has been viewed by over 750,000 people. Additional projects have extended the reach of the Partners' conservation messages to a total estimated audience of 2.5 million people—an audience that continues to grow. Most recently, the Partners have begun work with a collaboration of over 100 Minnesota cities under the direction of League of Minnesota Cities and the Minnesota Pollution Control Agency to develop a guide plan for implementing the NPDES Phase II in Minnesota. We are also developing an integrated education initiative that will address the six minimum control education measures with multimedia, printed materials, exhibits, community outreach and education, and K-12 education projects.

## **Introduction**

The WaterShed Partners has grown from a small group of educators into a collaborative of over 50 nonprofit organizations, universities, businesses, and government agencies (local, regional and national). This consensus-based coalition continues to grow and create new projects. We have six main programming areas that take differing approaches to educating the public about watersheds and non-point source pollution. Over the past seven years, our educational messages have reached over 2.5 million people and we have administered over \$1.5 million in grant funds—all without existing as an official entity!

The WaterShed Partners' education initiatives help citizens make informed, environmentally conscious decisions and take responsible actions. These efforts target a key underlying issue that makes non-point source pollution (NPS) such a challenge: few people are aware of the impacts of their own daily activities on their watershed. There is a tendency to think it is the "other person" who is

responsible for NPS. WaterShed Partners' projects emphasize that we are all potential polluters and that there are some basic things that can be done to minimize the pollution of our rivers. Toward this end, we are guided by three primary goals:

1. Educate the public about what a watershed is and how a watershed functions
2. Provide the public with an understanding of their personal connection to their watershed and their impact on NPS
3. Provide motivation to act in support of a healthy watershed

To achieve our goals, the WaterShed Partners have created six integrated programs that have a cumulative effect greater than the sum of their parts. Our program growth has resulted from a combination of strategic planning and entrepreneurship. These six programs include: the WaterShed Exhibit, the Metro Media Campaign, the Volunteer Stream Monitoring Partnership, Project NEMO, The WaterShed Education Network, and the League of Minnesota Cities NPDES Phase II Education Initiative.

### **Watershed Exhibit**

The Watershed Exhibit is a suite of museum-quality, hands-on interactive educational modules that may be used independently or together that has engaged more than 750,000 people over the past seven years. Four exhibit elements, each of which occupies a collapsible 8-foot table against a colorful fabric banner backdrop, focus on the following topics:

- What is a Watershed?
- What is your Watershed Address?
- Your Street Flows to the River
- Clean Water Starts with You

In addition, an interactive multimedia kiosk program (in English, Spanish, and Hmong) with six modules that reinforce the messages conveyed through the four table displays can be incorporated into the exhibit or used separately. The exhibit can be set up under a specially designed tent. A van has been dedicated to transporting the exhibit.

The goal of this interactive exhibit is to educate participants so that they will leave it knowing what a watershed is, understanding their personal connections to their watershed, and being motivated to take stewardship actions. For example, the interactive kiosk effectively delivers the message to participants that polluted runoff from their homes and yards flows, untreated, directly to the Mississippi River.

The development and implementation of the exhibit was made possible by significant funding from the Metropolitan Council and by other WaterShed Partners.

This past year, the WaterShed Exhibit accomplished the following:

- Served over 160,000 people
- Increased capacity through WaterShed Ambassadors, WaterShed van and multimedia kiosk system has proved successful
- Created new urban sprawl education module for the multimedia kiosk
- Developed new models to use local students as educators and distribute kiosks to public buildings as a service learning project
- Conducted national marketing survey to explore market for NPS education tools
- Expanded impact at the Minnesota State Fair by integrating exhibit into MN Pollution Control Agency booth

### **“Think Clean Water” Campaign**

In 1999, Metro WaterShed Partners implemented the “Think Clean Water” communications campaign that used broadcast media to communicate two main messages: 1) Keep grass clippings, leaves and fertilizer out of the street, and 2) Use low phosphorus lawn fertilizer. Evaluation at the conclusion of the campaign showed that 57% of individuals surveyed heard or read information about using low phosphorus fertilizer and 49% heard or read information about keeping grass clippings and leaves out of the street. Over 2 million media exposures were created by this campaign. The campaign was supported by a \$200,000 grant from the Metropolitan Council and untold in-kind labor of Metro WaterShed Partner members.

Additionally, this past year the following has been accomplished:

- Minnesota has passed a no phosphorus bill at the state legislature
- WaterShed Partners have created an educational brochure that addresses the no phosphorous fertilizer regulation
- \$90,000 has been secured to initiate another media campaign

### **Volunteer Stream Monitoring Partnership (VSMP)**

In the past five years, interest in volunteer monitoring has exploded in the Twin Cities area, with 39 volunteer monitoring groups identified in a recent inventory having begun their activities after 1994. In November 1999, the WaterShed Partners coordinated the development of a strategic plan for coordination of volunteer stream monitoring in the seven-county Twin Cities metropolitan area. Representatives from 15 organizations participated in the development of the strategic plan.

Volunteer stream monitoring programs are based on three experience-tested principles:

1. Volunteers can collect reliable, meaningful data that can be used by decision makers in watershed planning and management
2. Volunteer monitoring programs promote watershed stewardship by engaging volunteers in understanding and managing natural resources
3. Successful volunteer monitoring is a blend of education and science, supported by local units of government, educators, agencies, industry, and non-profits

The goals of the Volunteer Stream Monitoring Partnership are as follows:

- To facilitate the collection and management of quality volunteer stream monitoring data
- To effectively involve local, regional, and state agencies, including encouraging them to use volunteer generated data
- To engage volunteers

In the process of achieving these goals, we anticipate that the public will become more aware of river issues and more inclined to protect water resources. We also expect that water quality-monitoring resources will expand as the quality and amount of data available for decision-making improves at the state, community, and individual level. Finally, we anticipate that a centralized data management system with a watershed perspective will be developed and made accessible to agencies and volunteers.

Quality assurance and quality control of the collection of data is an important component of this partnership. All data collection is based on standard EPA protocol in coordination with the Minnesota Pollution Control Agency and the Metropolitan Regional Council. Data is collected by volunteer students and their teachers. The data is then checked by the county coordinators and double-checked by the VSPM coordinator. At that time the data is entered into a database coordinated by the Metropolitan Council. This information has been used by various counties in their year end reports and in developing their water plans.

In the past year the VSMP has:

- Convened first official year of operation focusing on ensuring quality data, strengthening partner collaboration and expanding outreach, securing funds and increasing capacity
- Worked with nearly 1,900 citizen volunteers
- Hosted a River Summit for over 230 students and professionals
- Provided 13 trainings for local partners

- Monitored 57 different stream sites in the five-county metro area

### **WaterShed Education Network for Teachers**

The Metro WaterShed Education Network uses communication, coordination and collaboration to educate youth about NPS; integrate watershed education into school systems; and leverage the energy created by the award-winning WaterShed traveling exhibit. The WaterShed Education Network Project has successfully increased the capacity of teachers and schools to integrate water quality education into their students' learning activities.

The WaterShed Education Network has:

- Developed a WaterShed Education Network Web site with educational resources and calls for stewardship action
- Integrated water issues into the Sharing Environmental Education Knowledge (SEEK) Web-based environmental education clearing house
- Created a WaterShed Listserve for over 180 educators
- Created a WaterShed Hotline for individuals
- Recruited and trained teachers as WaterShed Ambassadors through hands-on summer institutes, the watershed training sessions, and online graduate course work
- Created an award-winning graduate course for 20 St. Paul educators that infused watershed education into the St. Paul Chamber of Commerce's Teacher in the Work Place program
- Created the framework for the WaterShed Partners to act as watershed content experts
- Infused watershed education into the St. Paul, Minneapolis, and suburban schools systems, and the Grand Excursion 2004 Special Event

### **Project NEMO (Nonpoint Education for Municipal Officials)**

Project NEMO is an educational program for land-use decision-makers that addresses the relationship between land use and natural resources protection, with a focus on water resources. NEMO was created in 1991 at the University of Connecticut and, due to the success of the program, has grown to become a national network of projects in 15 states. "Linking Land Use to Water Quality and Linking Town Hall to Technology" is the NEMO motto.

Land use in the United States is largely decided locally by elected and appointed officials serving on county and municipal boards and commissions who have not been chosen for their knowledge of natural resource protection and often have little or no professional staff to support them. As a result, local land-use decision makers have been largely left out of the nonpoint source pollution reduction equation. A primary goal of Project NEMO nationwide is to provide education for these officials and to inspire them to take action.

For the Minnesota NEMO program, the first goal of the project is to develop and provide locally adapted NPS educational materials for a targeted audience of local land-use officials and thereby enable them to plan for growth while addressing water quality through wise land-use decisions. The second goal is to incorporate this educational message into actual changes in policies, practices, and plans at a local level. The third goal is to bring together and develop relationships between regional and state agencies, water management organizations, conservation districts and other associations interested using land-management decisions to protect water quality and natural resources. The fourth goal is to establish a coordinator position that will be responsible for implementation and expansion of the NEMO program in the Twin Cities Metropolitan area and the achievement of goals 1-3.

Project NEMO has successfully:

- Presented Project NEMO programs to over 40 cities
- Received additional funds from the Met Council
- Been identified by the Minnesota Environmental Quality Advisory as a major initiative for next year
- Received EPA 319 funds
- Impacted over 200 city council members and decision makers

#### **League of Minnesota Cities NPDES Phase II Guide Plan and Educational Initiative**

Hamline University and WaterShed Partners have recently worked with the over 100 cities, coordinated through the League of Minnesota Cities and the Minnesota Pollution Control Agency, to assist in developing the NPDES Phase II Guide Plan. This plan provides cities a template to develop their Phase II plans in Minnesota. It is an attempt to provide guidance and standardization for the cities in order for them to best meet their needs. The WaterShed Partners has focused on the educational component's six minimum control measures, while the engineering firms of Boonestro and Associates and AMEC have provided the primary structure of the document and other technical information.

In the past year we have:

- Assisted in writing the education component of the Phase II Guide Plan, with an emphasis on educational components of the six minimum control measures
- Provided training sessions for over 80 cities
- Made plans to develop an integrated campaign with media, printed materials, exhibits, community outreach and education and K-12 education projects

## Results

Over the past seven years, over 2.5 million people have been impacted in the Twin Cities Metro Area by WaterShed Partners projects. Since the WaterShed Partners programs differ, not all of the impacts have been the same, nor can they all be measured by the same gauge. While we are still in the formative evaluation stage of these initiatives, evaluations from two independent sources have begun to document impacts.

An independent evaluation of the WaterShed Exhibit by the Wilder Research Center has indicated:

- 75% of the visitors to the WaterShed are able to accurately describe what a watershed is
- 60% of the visitors to the WaterShed exhibit gain ideas for keeping their watersheds healthy and reducing their NPS pollution contributions

An independent evaluation of the WaterShed Partners' Media Campaign indicates that:

- 57% of individuals surveyed heard or read information about using low-phosphorus fertilizer
- 49% heard or read information about keeping grass clippings and leaves out of the street

One of the most interesting components of this project is comparing the level of NPS awareness in Minnesota to the nation at large. Using the National Environmental Education Training Foundation's National Report Cards on Environmental Knowledge, Attitudes and Behaviors as a guide, Hamline University conducted a survey of the citizens of the State of Minnesota and compared it to the national standard. In most categories, Minnesotans scores were similar to national averages. Regarding knowledge of non-point source pollution, however, Minnesotans scored over 100% higher than the national average. That is to say, only 24% of the nation understood NPS, while 52% of Minnesotans understood this concept.

While this cannot be directly correlated to the work of the WaterShed Partners, we believe our efforts have played a small role in this outcome.

## Conclusion

The WaterShed Partners is a collaboration that is effective in many different ways. By engaging educators and organizations in the Twin Cities that have a stake in educating the public about watersheds and non-point source pollution, we have been able to build on and greatly magnify the impacts of our partner organizations.

Three critical components for success can be identified:

1. Information Sharing—Monthly meetings provide a forum for the Partners to share information, network, and gain new knowledge. Sometimes, a lot of business gets done during the informal time before and after the meetings. There is much less “reinventing the wheel” in local areas.
2. Pooled Resources—By working together in a coordinated fashion, the Partners are able to create products and services that would be difficult to create individually. This system provides incentive for collaboration. For example, the WaterShed Exhibit is a resource that can be used by any of the partners when they need it, and they do not all need to own a \$100,000 exhibit.
3. Coordinated Efforts—By coordinating efforts, organizations can more effectively focus on their particular niches and put forward an integrated effort to educate the public about how to protect their watersheds. Synergies can be built around programming and fund-raising opportunities.

Through collaboration and consensus, the WaterShed Partners has been able to serve over 2.5 million people in the Twin Cities Metro Area in rich and diverse ways. Our hope is to be able to leverage this partnership to assist others in the local, regional and national setting to better educate the public and get them to take action about important watershed issues.



# Metro WaterShed Partners Milestones

## 1992-3

An idea by naturalist Karen Kobey of Hennepin Parks stimulates a network of agencies, non-profits and educators interested in the future of the Mississippi River to collaborate on a conference, “The Ever Changing Mississippi” held in Feb, 1993.

## 1994-5

“Summer of the River,” coordinated by Shelley Shreffler of Macalester College, and an informal partner network provides exhibits at outdoor events under banner entitled “WaterShed” (term coined by Ron Erickson of National Park Service). Displays include historical and water quality topics.

## 1995

A fall conference entitled “Awakening the Watershed,” sponsored by Summer of the River and the Mississippi National River & Recreation Area (MNRRA) is held in Red Wing, and provides a springboard for educational partnership development.

In December, a group is convened by MNRRA to further develop a watershed education partnership and an interactive watershed exhibit. (Exhibit Goal agreed: “The visitor to the WaterShed will leave with the knowledge of what a watershed is, an understanding of their personal connections to their watershed, and the motivation to act in support of a healthy watershed.”)

First regular meeting attendees: Anoka County Parks, Army Corps of Engineers, Center for Global Environmental Education (CGEE), Friends of the Mississippi River, Greening the Great River Park, Metropolitan Council Environmental Services, Minnesota Valley National Wildlife Refuge, MNRRA, Science Museum of Minnesota.

## 1996

Monthly meetings established, convened and facilitated by MNRRA.

Group name and Mission Statement established: “The *WaterShed Partners* is an informal association of organizations committed to addressing shared goals pertaining to *watershed education* through educational projects, networking and sharing resources.” Focus is on educating to prevent runoff pollution.

Prototype exhibits developed and utilized at outdoor, summer events.

First \$100,000 grant received from Metropolitan Council to create WaterShed interactive, mobile exhibits. CGEE coordinates grant process for WSP.

Internal processes and structures established, including consensus decision making and Steering Committee.

First Steering Committee members include: Cliff Aichinger, Marie Asgian, Tracy Fredin, Pauline Langsdorf, and Lyndon Torstenson.

Exhibit design development begins facilitated by Science Museum of Minnesota (SMM), and involving a committee of the WaterShed Partners.

Magnets and set of brochures created by NEC, CBE, MNRRA & WSP.

### **1997**

New “WaterShed” exhibits built by Science Museum of Minnesota are completed. Four tables include: 1) What is a WaterShed? 2) What is your watershed address? 3) Your street flows to the river, and 4) Clean water begins with you. Custom modified tent is purchased to house exhibits in events.

New mission established: “The WaterShed Partners promote a public understanding that inspires people to act to protect water quality in their watershed.”

150,000 people interact with WaterShed exhibits in 1997, including over 45,000 at the Minnesota State Fair.

Number of partners grows from 12 to 32.

Committees include steering, exhibits, education, evaluation, public outreach.

### **1998**

Public media campaign (“Water Quality Action Campaign”) undertaken in collaboration with Board of Water & Soil Resources reaches 2.5 million households.

Computer interactive developed.

Staffing support for exhibits and partnership established through CGEE.

Exhibit evaluation conducted by Wilder Foundation reveals notable learning occurring in response to exhibit interactions: 92% correctly define watershed.

CGEE establishes WaterShed Partners website.

WSP receive Partnership Minnesota award.

Metro WaterShed Education Network initiated at CGEE with \$35,000 grant for the Metropolitan Council

### **1999**

“Water Education Resource” book of ready-to-use educational materials created.

WSP awarded top honors by the Minnesota Environmental Initiative.

WSP receive MN GREAT award (Minnesota Government Reaching Environmental Achievements Together.)

Water Quality Monitoring initiative undertaken.

Partners number over 40; monthly meeting attendance regularly over 25.

Sponsorship of national conference considered.

Watershed Stewards Curriculum established and modeled at Farnsworth Elementary School.

### **2000**

Volunteer Stream Monitoring Project receives \$500,000 grant over 3 yrs from Met Council.

LCMR funding proposals developed and presented to Legislative committee.

“Project NEMO” (Nonpoint Education for Municipal Officials) launched.

### **2001**

McKnight awards \$150,000 two-year grant to CGEE for WSP programs.

Over \$1.5 million in grants have been successfully administered by the WSPs.  
First annual River Summit held for stream monitoring volunteers.  
Project NEMO gets \$93,000 grant from Metropolitan Council.  
Van purchased and outfitted for exhibits and events use, thanks to 50/50 matching challenge grant from Ramsey Washington Metro Watershed District.  
Name “Metro WaterShed Partners” (MWSP) adopted and officially registered after “Watershed Partners” name is found to be already registered by a real estate company.  
MWSP officially becomes project of CGEE, providing liability and other benefits.

## **2002**

State phosphorus legislation passes, thanks to MN Dept of Agriculture, and several WSPs.  
Over half a million people have interacted with the WaterShed exhibits since 1997; the exhibits have been displayed at national conferences and have been a national model.  
Nearly 100,000 people interact with WaterShed exhibits at State Fair alone.  
Project NEMO receives \$125,000 “319” grant from MN Pollution Control Agency, and \$50,000 from Metropolitan Council.  
\$50,000 grant for “Think Clean Water” media campaign from Metropolitan Council  
\$40,000 grant for “Think clean Water” media campaign from Office of Environmental Assistance.

# **EDUCATING THE LAS VEGAS COMMUNITY ABOUT STORM WATER POLLUTION**

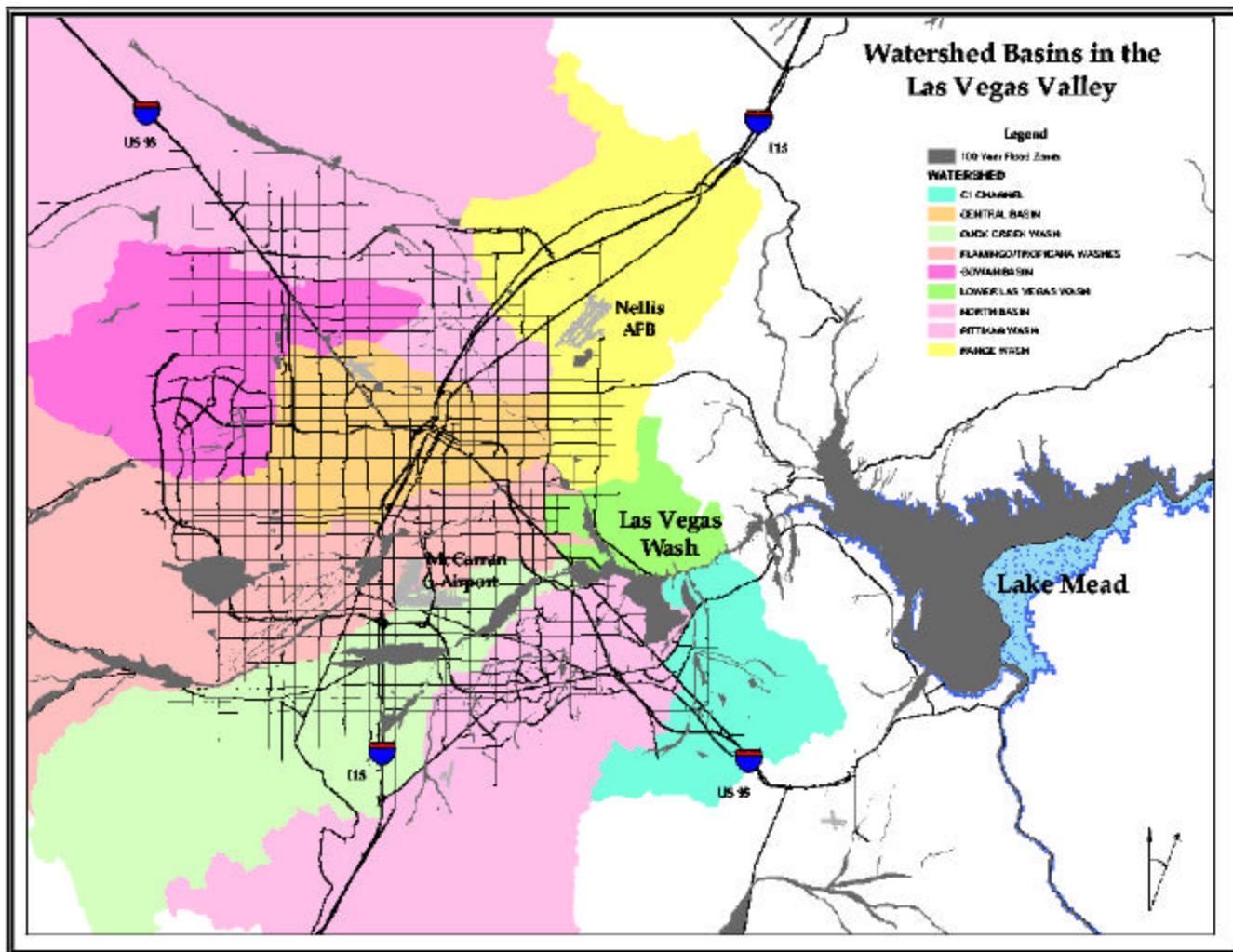
Betty Hollister, APR  
Clark County Regional Flood Control District  
Las Vegas, Nevada

## **Abstract**

The Clark County Regional Flood Control District, located in Las Vegas, Nevada, is the umbrella agency that administers the region's National Pollutant Discharge Elimination System (NPDES) permit. While the majority of the District's outreach efforts have been focused on flood safety education, the District has moved forward with increased public outreach about urban runoff and storm water pollution in the last two years. The Las Vegas Valley drains to the Las Vegas Wash, which drains to Lake Mead, the area's primary source of drinking water. With more than 6,000 new residents moving to the community each month, the education process about flood safety and storm water quality are continuous. New and innovative measures are needed to provide multiple impressions and reminders to the community about the impact their behavior can have on the environment.

## **Background**

The current population of the Las Vegas Valley is 1.5 million, with only 24% of those residents being born in Nevada. An average of 6,000 new residents move to the Valley each month, making Las Vegas one of the fastest growing cities in the nation. Almost one-half of the area's residents have lived in Las Vegas less than 10 years, and one-third of those have lived in the Valley less than five years (Las Vegas Perspective, 2002). To put this growth into perspective, in 1950 the city's population was 47,000, and every 10 years since, the population has doubled. The area is experiencing all of the challenges associated with other major metropolitan areas. In addition, the arid desert climate and drought conditions facing many of the western states make water quality and water availability major concerns for the area.



**Figure 1** Las Vegas Valley Watersheds

The average annual rainfall for Las Vegas is approximately 4 inches. However, in 2002, the area received less than 1.5 inches of rain (Historical Rainfall Data, 2002). The geography of the Valley slopes from the west to east with seven major washes passing through the urban area (Figure 1). All of these washes converge on the east side of town at the Las Vegas Wash, which drains to Lake Mead, the area’s primary source of drinking water. Five percent of the flow through the Las Vegas Wash into Lake Mead is from storm water; 5% is from over-irrigation, surface and groundwater; the remaining 90% is highly treated wastewater.

In accordance with the Federal Water Pollution Control Act, the Clark County Regional Flood Control District, as lead agency, was granted a National Pollutant Discharge Elimination System (NPDES) permit in December 1990. The Nevada Division of Environmental Protection issued the permit to six co-permittees representing the various city, county and state agencies owning and operating municipal separate storm sewer systems in the Las Vegas Valley.

The Storm Water Quality Management Committee was formed with the Regional Flood Control District as the umbrella organization funding the majority of storm water activities, like dry and wet weather testing of water entering Lake Mead through the Las Vegas Wash. Public outreach activities until recently were limited primarily to environmental “fairs” like Earth Day events. With the addition of a Public Information Manager in 2000, the Regional Flood Control District placed more emphasis on public outreach and education about storm water quality.

## **Research**

An initial brainstorming session was held with members of the Storm Water Quality Management Committee to determine the focus each of these organizations hoped to take with the outreach efforts. From this two-hour session, it became clear that this group of 20 people had differing opinions about the content of the information campaign and the target audiences to be reached.

## **Mall Intercept Survey**

An informal survey was taken at the area’s three largest shopping malls to determine residents’ awareness level of the problem. While this was a non-scientific survey, it was hoped the results would point the communication efforts in a certain direction.

After surveying 150 residents, the results showed that approximately 50% of the respondents were not aware that floodwater and urban runoff flowed through the storm drain network untreated to Lake Mead. Discussions also showed that residents were unaware of proper disposal of various pollutants, especially how to drain their swimming pool. Most of those surveyed were aware that Lake Mead was the Valley’s primary source of drinking water.

By partnering with the Southern Nevada Water Authority the following year, the District was able to include two questions on their next telephone survey of residents at no charge. These questions were similar to the mall intercept questions and the results were also similar. While 71% of respondents knew Lake Mead was the area’s primary source for drinking water, 32% said they believed urban runoff was treated before entering the Las Vegas Wash and Lake Mead. Thirteen percent did not know. From this survey, it was determined that the first step in public outreach should be education about untreated runoff and stormwater.



**Figure 2** Storm Water Logo

## Website/Logo Creation

Other environmental websites were researched and evaluated. Information was compiled and edited using information from several sources. A member agency staff person agreed to construct a storm water website as a volunteer service. The Regional Flood Control District paid registration costs associated with the site. The logo that was used prior to the website creation did not clearly communicate that water flowing through storm drains was untreated. The committee, with permission, modified a logo from a California community so that it better represented the Las Vegas environment. (Figure 2).

**Lesson Learned:** Research, evaluate, coordinate and borrow ideas (with permission). Feel free to borrow any of our ideas at <http://www.lvstormwater.com/>. We were also fortunate to have a volunteer Webmaster who is highly capable and dedicated to the effectiveness and accuracy of our site.

## Public Service Announcements

The primary objective of our mall intercept survey was to first educate the community that urban runoff and storm water are not treated before entering Lake Mead. The concept of a toy boat floating through gutter water, falling into a storm drain and being “found” in Lake Mead was used. The 30-second spot was produced at no charge by Clark County’s Communication Team who operate the county’s government access station. They were enthusiastic about producing a commercial that allowed a large amount of creativity and clever camerawork. An award-winning public service announcement (PSA) resulted that has received five first-place local and national awards.

**Lesson Learned:** While the Toy Boat spot was clever and award winning, it had no news or event hook for the television stations. Each of our local network affiliate stations are bombarded with about 35 new public service announcements each month, many of which are tied to an event or are co-sponsored by the TV station. Consequently, the Toy Boat PSA saw very little airtime. The District recognized that the next PSA must have some “hook” for it to be used by the media.

The District also explored producing 10 or 15 second spots but learned that there are only so many “natural” breaks of these shorter time slots with the network affiliates – that would have limited even more the possibility of airtime. In addition, production costs would have been essentially the same.

Two other public service announcements were produced following the Toy Boat educational spot. Each PSA was produced at a negotiated rate of \$2,300. These spots focused on behavior changes that could help improve the quality of urban runoff and storm water. One pointed out proper fertilization and irrigation of landscaping and was distributed in April to coincide with the Las Vegas Valley Water District’s water conservation campaign. This PSA was aired by all three network affiliates in both April and May, 2002. The “hook” was two-fold: 1) The fertilizer/irrigation PSA was distributed in the Spring during a time when people begin working in their yards, and 2) The Las Vegas Valley Water District’s water conservation campaign (paid advertising) was running heavily during this time.

Only one television station in Las Vegas provides documentation of PSA airtime, KVVU-Fox 5. With a program called PR-Trak, the District was able to document – just from this one station – that the fertilizer spot aired 70 times in a two-month period and was viewed by several hundred thousand people. This program uses actual Neilson ratings for individual markets. This program is also helpful in summarizing media coverage, both quantitative and qualitative, and provides accountability for the communications effort.

The third PSA focused on proper disposal of pet waste and was distributed in June. Knowing that the news or event “hook” was missing, television advertising departments were contacted about placement of the spot as a commercial. A “bonus” schedule was agreed to that gave free and extra placement of the spot in July for paid time in June. A competitive advertising rate request (Request for Avails) was conducted to ensure the best available television schedule, ratings and prices. Each of the three stations received \$3,000 from the Regional Flood Control District.

All three PSAs can be viewed from the [www.lvstormwater.org](http://www.lvstormwater.org) website.

### **Homeowners’ Associations**

A one-page camera-ready article was produced and mailed to a database of 300 Homeowners’ Associations. A cover letter from the Storm Water Quality Management Committee explained the importance of educating the community about how they could help protect Lake Mead, which is our primary source for drinking water. The same article was also sent to the neighboring cities and county for inclusion in newsletters they mail to residents.

**Lessons Learned:** The one-page camera-ready article was apparently not widely used by the Homeowners’ Associations. The District received seven phone calls thanking it for the information, but did not put in place a method to secure a copy of the next newsletter from each Association. While the text and layout were standard and “ready-to-use,” it appears that personal phone calls to the major associations may have worked to build better response than just a blind mailing. The article was, however, widely used in the newsletters produced by the cities and county. The District also revised the text of the article to focus on business best management practices and sent the mailing to related businesses. In response to this mailing, 11 businesses called to discuss concerns they had regarding their policies and to ensure that they were in compliance. The District plans to work with Homeowners’ Associations again in the spring of 2003. This will coincide with new and more expensive watering rates that go into effect along with stricter water conservation guidelines and citations.





**Figure 3** Storm Drain Plaques

### **Storm Drain Markers**

Various types of markers were evaluated based on the hot, desert climate. A plastic version was chosen that used a special adhesive. A \$65,000 grant from the state and the local conservation district funded the purchase of 12,000 plaques (along with other collateral material) to be distributed to the five city and county entities (Figure 3).

**Lesson Learned:** The funding did not include the installation of the plaques. The job for installation fell on the Public Works/Maintenance Departments to “fit in” as they had time. After a year, only a few hundred plaques had been installed in violation of the terms of the grant. Meetings were held to determine alternative ways of installation. Because of the toxic nature of the glue and liability issues (some students had been killed while picking up trash on a roadside), the only alternative was to contract the job out or seek direction from top management. A combination of the two was used with the Regional Flood Control District assisting with contract labor costs. All the storm drain makers were placed by December 2002.

### **The Flood Channel Television Program**

The District produces six 30-minute television programs each year under consultant contract for \$15,000 per episode. Two programs in the last 1½ years were devoted to storm water quality – education and behavior change. Several awards were received for the “Protecting the Environment” episode. These programs air on our two local government access television stations and receive about 40 airings each month. The County Government Access Station (C-4) airs its programming on the Internet via the county’s website, [www.co.clark.nv.us](http://www.co.clark.nv.us). The Flood Channel television program can be viewed from the county’s website.

**Lessons Learned:** Segments of the program educated the community about environmentally friendly businesses and the actions they were taking to conserve and protect the environment. Other segments showed what actions residents could take to improve water quality. The interviews with businesses were difficult to obtain because they were reluctant to go on camera – perhaps they were not doing all they could do or were afraid of repercussions from regulators. These companies included pool cleaners, carpet cleaners, mobile dog groomers, automotive service and car washes. With the second environmental episode, the District made the initial phone calls using public relations contacts and other relationships built over the years.



**Figure 4** Bus Stop Shelter Ad

### **Bus Stop Shelter Ads**

The City of North Las Vegas received a grant for public outreach about storm water quality. It chose to focus on proper disposal of pet waste as a reinforcement of the public service announcements. The city produced 25 bus stop shelter posters (Figure 4) that were in place from September through December 2002 (four months). The size of the posters was 4 feet by 6 feet. Total cost of artwork, production and placement was \$8,000. A similar version of this message was also distributed to North Las Vegas residents via utility bills one month prior to the bus stop shelter posters being put in place.

**Lessons Learned:** The artwork for this effort was incredibly eye-catching. An out of focus woman held a bag of pet waste (in focus) with the words “Do Your Doody” written on the bag. The sub-heading was “Protect the Environment” (our tag line for all the PSAs) and the words “Pick Up After Your Pet.” While the District did not receive any feedback from residents, those associated with the campaign were really grabbed by the artwork. One change would be to downplay the woman’s fingernails (they were emphasized

in such a way that they distracted from the pet waste bag). A copy of the artwork is also on the [www.lvstormwater.com](http://www.lvstormwater.com) website.

## **Brochures**

The District is currently finalizing a best management practices brochure for those wash water and urban runoff related businesses seeking new licenses. This two-color brochure was created with simple graphics and examples of various low to high impact activities. Funding for this effort was shared with the Southern Nevada Water Authority. A limited number of brochures are being printed (5,000) and an evaluation of its success will determine if more should be produced and if any revisions are needed. A copy of the brochure is available on the [www.lvstormwater.com](http://www.lvstormwater.com) website.

**Lessons Learned:** Because this was a committee effort, with many agencies and government entities involved, the process of producing this brochure took about six months. The committee met once a month. Additional reviews were required for every suggested change. Moreover, one entity would suggest a change that was not in agreement with the regulations of another community, which would necessitate further changes. Because of such difficulties, the committee decided to print and distribute only a limited number of copies.

## **Community Events and Collateral Material**

The Regional Flood Control District takes part in spring and summer environmental fairs, as well as events geared toward pet owners. The District has produced several collateral materials for distribution: pet food lids, pooper scoopers, sponges, stickers and coloring books to name a few. It also uses an enviroscape model (a landscape topographical model) that shows how various pollutants are carried by rainwater into a lake. These are all helpful in getting the message out about storm water quality.

**Lessons Learned:** It is best to participate in smaller, organized events that provide the crowd a schedule of when demonstrations (like with the enviroscape) will be held. This allows for coordinated presentations with better audience participation. While brochures are a standard in these events, we believe that focusing our participation helps to more effectively get the message out.

## **School Outreach**

A four-page school curriculum was produced after a year of research to determine how much information was needed and in what format. The curriculum focuses mainly on flood safety, but storm water and the pollutants it contains are also included. Personal school presentations last year reached 45 schools and approximately 8,000 elementary students. As requested by teachers, the material was also mailed to schools, reaching 15,000 additional elementary students. A six-minute video and student activity book were also included.

**Lessons Learned:** The research was crucial to ensuring that the curriculum met both local and state education requirements. The curriculum met both science standards and health and safety requirements. Four pages of teacher information, a student test and teacher evaluation helped ensure teachers' use of the material and gave the District immediate feedback. From the feedback, the District saw a need to produce the video in Spanish for schools with higher populations of non-English speaking students. The District also included an interactive version of the activity book on its website at [www.ccrfd.org](http://www.ccrfd.org).

## **Conclusion**

Because of the tremendous growth the Las Vegas Valley has been experiencing, the District's two major audiences are new residents and construction companies. The Nevada Division of Environmental Protection is stepping up enforcement of construction best management practices in Las Vegas and the District will be assisting them with their education efforts. The District is also exploring the next focus of its Public Service Announcements. One possible topic is boating on Lake Mead, because of new regulations restricting certain types of watercraft on the lake.

Currently, three sanitation districts discharge highly treated wastewater into the Las Vegas Wash that flows into Lake Mead. The sanitation districts contribute approximately 90% of the annual flow in the Las Vegas Wash. The sanitation districts are now considering systematically eliminating their Las Vegas Wash discharges by piping their flows farther into the lake or to the Colorado River. If and when this occurs, the capacity for dilution of urban runoff and storm water pollutants in the Las Vegas Wash will be decreased, thus resulting in greater concentrations of these pollutants as they reach Lake Mead. While the various agencies involved with the Wash are building grade control structures and wetlands in the Lower Las Vegas Wash to help improve water quality, the District continues to evaluate how to most effectively educate the public on behavioral changes that have positive impacts on the environment.

## References

Historical Rainfall Data, 2002, [www.ccrfcd.org](http://www.ccrfcd.org) compiled from the National Weather Service official gage at McCarran International Airport.

Metropolitan Research Association, 2002, Las Vegas Perspective.

# **ILLICIT AND INDUSTRIAL STORM WATER CONTROLS: A MUNICIPAL PERSPECTIVE**

Michael J. Pronold, Industrial Stormwater Manager  
Ali Dirks, Illicit Discharge & Spill Protection Environmental Technician  
Bureau of Environmental Services  
City of Portland  
Portland, Oregon

## **Abstract**

As part of the Environmental Protection Agency (EPA) Phase 1 storm water requirements, the City of Portland, Oregon (City) was responsible for developing a program to monitor and control pollutants in storm water runoff from industrial facilities to the municipal separate storm sewer system (MS4). In addition, certain classes of industries are required to obtain National Pollutant Discharge Elimination System (NPDES) Industrial Storm Water permits. The EPA, or a State Agency that has been delegated by EPA, administers these permits. Addressing storm water runoff from industries under these separate programs can result in redundant efforts and a less than efficient program. EPA and/or State agencies may not have the resources to adequately administrate and enforce the permitting program while still leaving the municipality liable for the discharges from the MS4.

The City chose to meet the requirement in their municipal storm water permit to control industrial storm water sources of pollution by developing a Memorandum of Agreement (MOA) with the Oregon Department of Environmental Quality (DEQ), (which is the delegated authority) to administrate the permit program. The MOA outlines the responsibilities of the City and DEQ for the implementation of the program, including notification of permit requirements, inspections, compliance, and enforcement issues.

To implement the provision of the Illicit Discharge Elimination Program, the City identified and prioritized 109 major outfalls in the MS4. Maps were developed that outlined the drainage basin and over 3,000 industrial and commercial facilities were researched using building and plumbing records to identify illicit connections. Outfalls are inspected monthly during dry weather and flows sampled to detect the presence of illicit discharges. The City has also developed a citizen complaint program to facilitate the reporting of spills and illicit discharges.

## **Industrial Storm Water Program**

Storm water discharges have been increasingly identified as a significant source of water pollution in numerous nationwide studies on water quality. To address this problem, the Clean Water Act Amendments of 1987 required EPA to publish regulations to control storm water discharges under NPDES. EPA published storm water regulations (55 FR 47990) on November 16, 1990 which require certain dischargers of storm water to waters of the United States to apply for NPDES permits. The regulations include NPDES permit application requirements for storm water discharges associated with industrial activity. EPA has defined this phrase in terms of 11 categories of industrial activity. The DEQ has been delegated by EPA to administrate the program and started issuing Industrial Stormwater permits in 1991.

As a Phase 1 city, Portland was required to develop a program to monitor and control pollutants in storm water runoff from industrial facilities in accordance with 40 CFR 122.26(d)(2)(iv)(C). This creates the potential for redundant efforts and an inefficient program. The City is ultimately responsible for discharges from their MS4. To meet the requirement in their municipal storm water permit and to provide the oversight necessary to protect itself from liability, the City developed the legal authority and entered into an MOA in 1994 with the authorized NPDES state authority (DEQ), to administrate the permits for those discharges to the MS4. The City also inspects and notifies industries that may be required to obtain a permit. The program is administered by a dedicated work group in the City because of the large industrial base and number of NPDES Industrial Storm Water permits (approximately 250) within the City.

## ***Program Elements***

### **Legal Authority**

Code was developed in March 1994 to allow the City to have legal authority over storm water discharges to the MS4. Key elements of the code included the requirement for permit holders to submit their Storm Water Pollution Control Plan (SWPCP) and monitoring results to the City, the authority for the Director to adopt administrative rules, inspection authority, and enforcement capability. It was important that the City reviewed the NPDES Industrial Storm Water permit when code was developed to ensure that any City identified inadequacies of the state issued permit were addressed. One example would be the requirement to submit SWPCP and monitoring results to the City as this was not included in the permit.

Another provision that was critical was the ability of the City to implement measures to address facilities that may not be required to obtain a permit. Currently, federal regulations base the requirement for obtaining a permit based on Standard Industrial Classification (SIC) Code and exposure. City experience has shown this to be cumbersome as certain facilities that have activities similar to those facilities that are required to obtain a permit fall under an unregulated SIC Code. There are provisions in the federal regulations to request that the permitting authority issue a permit but this could require that the City undertake sampling and additional work to prove this. This reduces the efficiency of the program in terms of resources and uniformity. This matter was partly addressed by including provisions in the code that allows the City to develop its own permit. However, because of concerns about confusion for the regulated community, plus the current workload of inspecting facilities that may need a permit under the SIC Code criteria, the City has not pursued this effort to date. Other measures, including the requirement for secondary containment and the development of Accidental Spill Prevention Plans, are included in code and used to address non-permitted sites.

Enforcement capabilities, including fines, have been developed for violations of the City's code. Provisions of the code include general discharge prohibitions, reporting requirements, right of entry, inspections, and sampling by City staff, and measures to prevent the entry of wastes to the MS4. Enforcement capability by the City is especially important for "low level" violations, such as late reports. The DEQ is reluctant to enforce on those "low level" violations, other than with notification letters, because the minimum fine is \$1,000. Where the City does not have enforcement capability, the City must seek voluntary compliance and refer those violations to DEQ when they are unable to obtain compliance. Failure to apply for a permit and/or develop a SWPCP in a timely manner are referred to DEQ for formal enforcement. This has worked to date, but requires coordination between the City and DEQ. To make this effective, the City worked with DEQ to identify which violations merited referral to DEQ's formal enforcement process.

## Memorandum of Agreement

The City entered into a MOA with the DEQ in March 1994, which was revised in 1999. The MOA delineates the responsibilities for the implementation of the program between the two agencies. Language is broad enough to not constrict how the City implements the program. There were two key provisions in the 1999 update of the MOA. One was the submittal of the permit application materials to the City. The City reviews the applications for completeness and then forwards them to the DEQ. This allows the City to track the industries' compliance with applying for a permit once the City has notified them. Previously, the application was submitted directly to the DEQ which proved cumbersome for the City to track compliance with submittal deadlines. In addition, if the application was incomplete, it was returned by the DEQ to the applicant with no clear submittal deadline. Another benefit of submittal to the City is the facilitation of obtaining the Land Use Compatibility Statement (LUCS), which is issued by the City Planning Department. This allows the applicant to submit all the materials at once as opposed to obtaining a LUCS separately. The second provision was the authority granted the City to administrate the permits for those facilities within the City limits but that had storm water discharges through private outfalls. Prior to this, these facilities were rarely inspected nor was there the level of oversight as with the other permittees. To account for the added workload, the MOA included provisions for revenue sharing of permit fees. With approximately 250 permits citywide, this provided adequate funding for one additional City staff person.

**Table 1. Oregon DEQ and City of Portland Select Responsibilities and Funding Allocations Under the MOA for City Administration of the NPDES Industrial Storm Water Permit**

MOA Element	Oregon DEQ	City of Portland
Permit Application and Review	Review for applicability	Track application submittal, review for completeness, forward to DEQ. Notification of non-compliance and referral to DEQ for enforcement.
Permit Issuance	DEQ responsibility, notify City	
Permit termination	DEQ responsibility, consult City	Confer with action
Site Inspections	Upon request, at discretion	Annual at a minimum
Storm Water Monitoring		Annual, weather permitting
Review of Self Monitoring Data		Review for compliance, notification of non-compliance, and referral to DEQ for enforcement.
SWPCP		Track submittal, review for completeness, notification of non-compliance and referral to DEQ for enforcement.
Enforcement	Upon referral	Enforce City Code, seek voluntary compliance where City doesn't have authority and refer to DEQ when unable to achieve voluntary compliance.
Staffing	1 FTE Northwest Region of Oregon	Approximately 3.0 FTE
Application Fee (\$670)	50%	50%
Annual Fee (\$275)	25%	75%

## Permitted Industries

When the City took over the administration of the permits in 1994, 66 facilities were permitted and less than half of them had developed the required Storm Water Pollution Control Plan (SWPCP). Since that time, the City has identified, through inspections, facilities that are required to obtain a permit. At the

time of this report, approximately 250 facilities were permitted. Therefore, the rate of compliance for obtaining a permit has increased dramatically.

Inspections are performed after a review of the SWPCP and other pertinent information in the industry’s file. The City utilizes a checklist that includes all the required elements of the SWPCP. This provides a very succinct evaluation to provide to industry. Inspections are usually scheduled in advance with the facility operator but can be performed without notice. Inspection forms are filled out during the inspection and any readily noticeable issues addressed during a post inspection meeting. Inspectors provide technical assistance and information in the form of recommendations, including best management practices (BMPs), using flyers that the City has developed. Each flyer addresses a specific BMP, such as storage of waste materials, sandblasting, employee education, and catch basin maintenance. This allows the City to target specific activities on site and reduces printing costs. Facilities are also evaluated for the presence of illicit discharges. Approximately 15% of the industries had illicit discharges, primarily washwater, identified during the initial inspection. All inspections are followed up with correspondence outlining the findings of the inspection and expectations of the industry. Any item where the industry is not in compliance with the permit is highlighted with a deadline to meet compliance before escalating enforcement is pursued. It is the goal of the program to perform annual inspections, at a minimum, of all permitted facilities.

**Table No. 2** Number of Industrial Storm Water Permits Administered by the City of Portland, Oregon

Fiscal Year	94/95	95/96	96/97	97/98	98/99	99/00	00/01	01/02
No. Permitted Facilities	66	70	100	110	125	200	245	259

Storm water sampling of permitted facilities is performed by collecting grab samples at the sample point(s) identified in the facility’s SWPCP. Analyses are performed by the City lab and include the parameters listed in the permit. This includes pH, total suspended solids, copper, lead, zinc, and oil and grease. The City may also test for additional parameters that are not included in the general storm water permit. The City’s sampling does not relieve the facility from their storm water sampling responsibilities. The results are relayed to the industry and used as a basis to assess the effectiveness of the SWPCP. The City strives to obtain at least one sample annually, weather permitting.

For the City’s situation, placing the responsibilities within a dedicated work unit has worked very well. The work section is able to develop expertise in the area while having access to existing information from other City programs, including the City’s Pretreatment Program for discharges to the sanitary sewer. Approximately 25% of the facilities that have storm water permits also have industrial pretreatment permits issued by the City. There are currently five staff members that administrate the program for the City, but approximately one-half of their time is spent conducting other activities for the City including addressing non-storm water discharges and source investigation work for programs addressing contaminated sediment.

Other municipalities have adopted this approach while others have incorporated the responsibility into the pretreatment program or other existing programs including fire and safety inspections. The municipality needs to consider several items when determining who will be responsible for implementing a program like this, including the number and type of industries, level of oversight, and oversight of industries by existing programs within the municipality (e.g., pretreatment, hazardous materials, etc.).



## Non-Permitted Industries

Industries are also inspected if they are identified as potentially needing a permit. There are approximately 3,000 facilities within the City that have the SIC Code listed in the federal regulations. To perform a general survey of all facilities would have generated much more work than resources allowed. Each site would have to be evaluated prior as the City is a mixture of combined sewers, sumps, and separated storm sewers. Staff spends a considerable amount of time determining where the storm water from the facility discharges to. A municipality may be able to perform a survey if the industrial base is smaller. The City chose to prioritize the search in a systematic manner. Federal guidance states that a system-wide approach to establishing priorities for inspections should be developed.

Initially, the City identified facilities to inspect by searching storm water outfall basins. The basins were prioritized using criteria such as size of outfall, land use (industrialized), water quality concerns of the receiving water, and reported pollution complaints. The basins were delineated for drainage, the industrial facilities identified using our database, and facilities selected by SIC Code. It became readily apparent from these inspections that for the City, certain classes of industries pose more of a pollution risk than others. Auto wreckers, recycling facilities, and certain manufacturing facilities were identified as an inspection priority. Certain light manufacturing, including leather products, electronic equipment, printing, and warehousing and storage facilities posed a much lower risk as their activities are typically indoors. Therefore, the City has adopted an approach that includes sweeps of industries based on SIC Code. Inspections are also performed in response to referrals, field observances, complaints, and an industrial survey performed in support of the pretreatment program. The City has identified approximately 150 additional facilities since 1994 that were required to obtain storm water permits.

In addition, investigation efforts by the City identified the Wholesale Distribution of Construction Equipment (5082) and Heavy Construction Equipment Rental (7353) as significant sources of pollutants. The City identified 20 of these facilities as impacting the MS4 and petitioned the DEQ to issue NPDES General Storm Water permits. These classes are not included in the federal regulations but any municipal program should evaluate these facilities and consider including them in their programs. The number of inspections varies each year depending on the number of permitted industries, staff vacancies, and requests for source investigation work. Generally, each staff member is able to inspect about the same number of non-permitted facilities as permitted facilities. However, as the number of permitted facilities increase, the efforts in this area will decrease.

**Table No. 3** Inspection Priorities for the City of Portland, Oregon

Higher Priority SIC Codes		Lower Priority SIC Codes	
5015	Motor Vehicle Parts, Used	23--	Apparel and Other Finished Products
5093	Scrap and Waste Materials	25--	Furniture and Fixtures
33--	Primary Metals Industry	27--	Printing, Publishing and Allied Industries
347-	Coating, Engraving and Allied Services	31--	Leather and Leather Products
7353	Heavy Construction Equipment Rental and Leasing	38--	Measuring, Analyzing, and Controlling Instruments; Photographic, Medical...
20--	Food and Kindred Products		
40--, 41--, 42--	Transportation		
5082	Construction and Mining Machinery and Equipment		

The City has developed several “partnerships” to expand the inspection program. Informational flyers and a poster were developed for Multnomah County Sanitarians to use when they inspect restaurants. A

simple storm water checklist was developed for City commercial recycling staff to use when inspecting retail establishments. In both of these cases, it is important to note that the facilities targeted would not ordinarily be inspected for storm water issues (unless a complaint was received), and that any follow-up issues are then addressed by storm water staff.

## **Phase II NPDES Storm Water Program**

The Phase II regulations did not expand on the category of industries for inclusion in the permitting program. However, there were two significant changes that impact industry. Previously, operators of certain facilities within category eleven (xi), commonly referred to as “light industry,” were exempted from the definition of “storm water discharge associated with industrial activity,” and the subsequent requirement to obtain an NPDES permit, provided their industrial materials or activities were not “exposed” to storm water (EPA 2000). A light industry operator was expected to make an independent determination of whether there was “exposure” of industrial materials and activities to storm water and, if not, simply not submit a permit application.

As revised in the Phase II Final Rule, the conditional no exposure exclusion applies to ALL industrial categories listed in the 1990 storm water regulations, except for construction activities (category (x)). In addition, an operator seeking to qualify for the revised conditional no exposure exclusion, including light industry, must submit written certification that the facility meets the definition of “no exposure” to the NPDES permitting authority once every five years. A No-Exposure Certification (NEC) form which contains guidance on determining whether a condition of no-exposure exists was developed by EPA (2000) for use in those states where they are the permitting authority. The DEQ has adopted a similar form for use in Oregon, which is a delegated state. It serves as the necessary certification provided they are able to answer all of the questions in the negative. Regulated industrial operators need to either apply for a permit or submit a NEC form in order to be in compliance with the NPDES storm water regulations.

The City is in the process of re-inspecting facilities that previously were not required to obtain a permit because a condition of no exposure existed. Based on inspection results, approximately 20% of the facilities that previously were not required to obtain a permit had exposure of industrial materials and activities to storm water. These sites were then required to apply for a permit or remove the exposure. The City and DEQ have agreed that any submitted no exposure certification would have to be verified with an inspection by the City. The City is also evaluating whether certain facilities and/or sites will need to be inspected prior to the five-year re-certification period.

The Phase II program for municipalities do not include a specific requirement for an industrial storm water control program. However, since municipalities are ultimately responsible for discharges to their MS4, if they have significant industries present, they should consider programs such as described here.

## **Illicit Discharge Elimination Program (IDEP)**

The IDEP program was developed as part of the City’s response to 40 CFR 122.26(d)(2)(iv)(B), which requires the municipality to describe a program, including a schedule, to detect and remove (or require the discharger to the municipal separate storm sewer to obtain a separate NPDES permit for) illicit discharges and improper disposal into the storm sewer. The specific elements addressed in the City’s IDEP include conducting on-going field screening activities during the life of the permit, investigating the storm sewer system when the results of the field screening or other appropriate information indicate a probable

presence of illicit discharge, procedures to contain and respond to spills, and procedures to promote and facilitate public reporting of the presence of illicit discharges.

## ***Program Elements***

### **Outfall Prioritization**

A plan was developed to rank outfalls on the potential for the presence of pollutants found to commonly contaminate receiving waters. Criteria included land use, pipe size, historical problems, pollution complaints and information from outfall monitoring data (both analytical and visual). The prioritization process made it possible for the City to utilize staff and resources in an effective manner by focusing on the outfalls that have the highest potential for pollutant problems. From a total of over 300 storm water outfalls, the City used the criteria to identify 109 on an Outfall Priority List. The list allows the City to develop a reasonable schedule for Dry Weather Outfall Monitoring. After the creation of the outfall priority list, maps of each outfall's drainage basin were created. Maps were made using existing sewer maps, public work as-builts and field inspection records. The largest outfall basin is 475 acres while the smallest is 15 acres. There are approximately 30,000 acres within the MS4 area.

### **Connection Verification**

The Connection Verification Program is a methodical search and documentation of current City building and plumbing records on connections to the MS4. The research was conducted to evaluate all connections to the MS4 from individual property. It took two years, using staff part-time and a summer intern, to evaluate all the properties located in the drainage area of the priority outfalls. Information collected was reviewed looking for questionable connections to the storm sewer system (example – wash racks, trench drains, or loading dock drains going to the storm sewer). If questions arose from a review of the records, a site inspection was performed or referral made to the agency responsible for building inspections. The City identified 15 businesses (out of approximately 3,000) with questionable connections. The process was very time consuming for the results achieved. If a Phase II municipality is considering this work, they need to understand that most illicit connections are mistakes made during the construction phase and reviewing records does not identify these. A benefit of the creation of these records is that it provides information when trying to identify the source of illicit discharges identified at the storm water outfall, and to industrial storm water or similar inspection programs. In addition, once the task is completed, building plan review is in place to address any new development.

### **Dry Weather Outfall Monitoring**

This program has been developed to collect and analyze samples from storm water outfalls using portable field test kits for pollutants that the EPA determined commonly contaminate storm water. This is an effort to obtain defensible evidence of illicit connections and discharges. Monitoring and analysis are conducted on “dry days” (>24 hours with no measurable rainfall) due to the fact that increased flows caused by transient rainfall related storm water runoff dilute pollutant concentrations and make analytical detection and pollutant tracing difficult. The outfall sampling schedule for any given dry day is established by the Outfall Priority List. Outfalls are inspected/sampled at least once a month during the dry weather season (June through September). Outfalls that have tested positive for pollutant(s) are tested more frequently during the month.

The analyses for commonly found storm water pollutants are performed using field meters and test strips. Emphasis during dry weather monitoring is on looking for indicators of pollutants, instead of a long list of individual pollutants. The City currently samples for the following pollutants: pH, temperature, conductivity, copper, iron, residual chlorine and E Coli. All samples are analyzed in the field except for E Coli. This has been scaled back from a much longer list than the City originally analyzed for. This was necessary because of the excessive time required to analyze for the pollutants on the original list. Additional pollutants may be sampled for, depending on the observed or suspected pollutants in the flow. When pollutants are detected at concentrations that indicate the presence of illicit connections or discharges, procedures to identify the source of the pollutant are implemented. Of the 109 storm water outfalls monitored, approximately 40% have flow present. Many times the flow is from groundwater infiltration or stream and ditch diversions. Of the outfalls that have flow, analyses indicate pollutants high enough to warrant an upstream investigation approximately 25% of the time.

### **Pollutant Discharge Investigation**

This program was developed to investigate problems identified through the Connection Verification and Dry Weather Outfall Monitoring. If an outfall tests positive for a pollutant, an upstream investigation is conducted to track and identify the source of the pollutant. Investigations consist of going upstream of the outfall and checking manholes for similar flow and/or visual inspection of streets, driveways and parking lots looking for runoff. Once the discharge is identified, the next step is to determine the severity of the discharge and proceed accordingly.

The City has identified and corrected six illicit connections and twenty illicit discharges. Illicit connections include wastewater from a photo processing lab, two improperly connected bathrooms, and a zamboni pit connected to a storm sewer. Illicit discharges include discharge from a produce company, a broken City sanitary sewer line infiltrating into the storm sewer, a commercial building with a failing septic system leaking to the storm sewer and a steel manufacturing facility with a broken potable water line leaking into City storm sewer. Even though outfalls are inspected monthly, illicit discharges have proven hard to identify. This is most likely due to the number of outfalls and the intermittent nature of the discharges. The City currently has one staff person that utilizes approximately 50% of their time performing the tasks identified with the IDEP. The program has resulted in reduced illicit discharges overall.

### **Spill Protection and Citizen Response**

The City has also developed a citizen complaint program to facilitate the reporting of spills and illicit discharges. A dedicated phone number is staffed 24 hours a day. After hour reporting is recorded on voice mail and the duty officer is paged to retrieve the information. This allows the duty officer to screen the calls and respond accordingly. The duty officer carries a limited amount of spill materials, but works directly with the appropriate agencies, including the City's Fire and Maintenance Bureau's, Coast Guard, and a City contractor to provide containment and clean-up. On average, the City receives approximately 1,500 calls to the complaint line per year. Of these, nearly 50% are registered as water pollution complaints. The remaining calls are referred to the appropriate agency and include noise and nuisance complaints, air quality concerns, etc. Approximately 300 (20%) of the calls come after normal working hours with 25% of these requiring an on scene response either immediately or the next day. The City staffs the position with one full time employee for regular business hours, and utilizes staff on a rotating basis from the Industrial Storm Water, Industrial Pretreatment, and IDEP for after-hours response.

## Conclusions

The development of an industrial stormwater program is not one of the six BMPs that Phase II permit holders will be required to be developed. This may be due, in part, to the assumption that all industrial permits would be in place because of Phase I requirements. However, our efforts have shown that only 25-30% of the industries requiring permits had applied prior to the administration of the program by the City.

A municipality may become co-applicants with Phase 1 permit holders. If this occurs, the applicant will become subject to an industrial control program but may be able to utilize the existing program of the permit holder. If a municipality does not develop a program, it is recommended that they work with the permitting authority to identify who has a permit and the status of their compliance. The municipality should also evaluate the industrial base in the MS4 and provide this information to the permitting authority if they identify a facility that may be subject to the program. It may be prudent to incorporate these activities into the illicit discharge elimination program, which is a requirement of the Phase II permit. Whatever the municipality chooses, they need to understand that they are ultimately responsible for discharges from their MS4.

Work to date in the implementation of the IDEP has shown that researching building and plumbing records of facilities was a very time intensive use of resources with very little benefit in identifying illicit connections. Most illicit connections are the result of in-field errors in connections during construction. Time would be better spent conducting dry weather monitoring to identify illicit discharges, although identifying them can be difficult due to the intermittent nature of the discharge. In addition, some illicit discharges may be low in volume and never reach the storm water outfall. These pollutants would then be discharged with the next storm event. Based on this, it may be necessary to move the inspection program upstream in the collection system. However, this would dramatically increase the points of inspection. An alternative would be to monitor storm water quality at the outfall and identify where there are water quality concerns. Upstream inspections of facilities could then be used to identify illicit discharges. The City's Industrial Storm Water program has identified illicit discharges in approximately 15% of their facility inspections.

## References

EPA 2000. Guidance Manual for Conditional Exclusion from Storm Water Permitting Based On "No Exposure" of Industrial Activities to Storm Water, U.S. EPA, Office of Water, EPA 833-B-00-001.

# A Reassessment of the Expanded EPA/ASCE National BMP Database

Eric W. Strecker, P.E. \*, Marcus M. Quigley, P.E. \*\*, and Ben Urbonas, P.E. \*\*\*

- \* Principal, GeoSyntec Consultants, 838 SW First Avenue, Suite 430, Portland, OR 97204; PH 503-222-9518; [estrecker@geosyntec.com](mailto:estrecker@geosyntec.com)
- \*\* Project Engineer, GeoSyntec Consultants, 629 Massachusetts Avenue, Boxborough, MA 01719; PH 978-263-9588; [mquigely@geosyntec.com](mailto:mquigely@geosyntec.com)
- \*\*\* Chief, Master Planning and South Platte River Programs, Urban Drainage and Flood Control District, 2480 West 26<sup>th</sup> Avenue, Suite 156-B, Denver, CO 80211, PH 303-455-6277; [burbonas@udfed.org](mailto:burbonas@udfed.org)

## ABSTRACT

The USEPA/ASCE National BMP Database has grown significantly since the first evaluation of BMP performance data in the database was completed in 2000. The project team is currently performing a re-evaluation of the data contained in the database to assess the overall performance of BMPs as well as compare BMP design attributes to performance. Although this analysis has not been fully completed, several initial results are presented in this paper.

The evaluations include the assessment of various BMP types as categorized in the database with regards to their ability to reduce runoff volumes as well as improve effluent quality. Certain BMP types may reduce the volume of runoff through evapotranspiration and/or infiltration, as opposed to BMPs that are more “sealed,” such as wet ponds, wetlands, and vaults. Runoff reductions directly reduce pollutant loading as does improved effluent quality. On average, dry detention basins were found to reduce runoff volumes by an average of 30% (comparison of inflow to outflow), while biofilters reduced volumes by almost 40%. As expected, wet ponds, wetlands, and hydrodynamic devices, and retention ponds show little or no runoff volume reductions. BMP types vary with regards to effluent quality that is achieved. BMPs such as wet ponds and wetlands appear to achieve lower concentrations in effluent quality than other BMPs such as detention ponds (dry) and hydrodynamic devices. These differences vary with pollutant type. With more data available, analyses of BMP design versus performance show statistically valid results. For example, a relationship (ratio) between the treatment volume of retention ponds (with wet pools) versus the average size storm event volume monitored has been established, showing that those with a ratio of 1 or greater have been observed to achieve significantly better effluent quality.

This paper also briefly overviews the Urban Stormwater BMP Performance Monitoring (“Manual”) (Strecker, et. al., 2002) that was developed by integrating experience gleaned from field monitoring activities conducted by members of ASCE’s Urban Water Resource Research Council and through the development of the ASCE/EPA National Stormwater Best Management Practices Database. The Manual is intended to help achieve stormwater BMP monitoring project goals through the collection of more useful and representative rainfall, flow, and water quality information.

## INTRODUCTION

The USEPA (Environmental Protection Agency)/ASCE (American Society of Civil Engineers) National Stormwater BMP (Best Management Practice) Database has been under development since 1994, under a USEPA grant project with the Urban Water Resources Research Council (UWRRC) of ASCE (Urbonas, 1994). The project has included the development of recommended protocols for BMP performance (Urbonas, 1994 and Strecker 1994), a compilation of existing BMP information and loading of suitable data into a specially designed database ([www.bmpdatabase.org](http://www.bmpdatabase.org)), and an initial assessment of the results of the analyses of the database (Strecker et. al., 2001). In addition a detailed guidance document on BMP monitoring has been developed, entitled “Urban Stormwater BMP Performance Monitoring: A Guidance Manual for Meeting the National Stormwater BMP Database Requirements” (available for download at: [www.bmpdatabase.org](http://www.bmpdatabase.org)).

Many studies have assessed the ability of stormwater treatment BMPs (e.g., wet ponds, grass swales, stormwater wetlands, sand filters, dry detention, etc.) to reduce pollutant concentrations and loadings in stormwater. Although some of these monitoring projects conducted to date have done an excellent job of describing the effectiveness of specific BMPs and BMP systems, there has been a lack of standards and protocols for conducting BMP assessment and monitoring work. These problems become readily apparent for persons seeking to summarize the information gathered from a number of individual BMP evaluations. Inconsistent study methods, lack of associated design information, and varying reporting protocols make wide-scale assessments difficult, if not impossible. (Strecker et al. 2001; Urbonas 1994) For example, individual studies often include the analysis of different constituents and utilize different methods for data collection and analysis, as well as report varying degrees of information on BMP design and flow characteristics. The differences in monitoring strategies and data evaluation alone contribute significantly to the wide ranges of BMP “efficiency” (typically percentage removal) that has been reported in literature to date.

Municipal separate storm sewer system owners and operators, industries, and transportation agencies need to identify effective BMPs for improving stormwater runoff water quality. Because of the current state of the practice, however, very little sound scientific data are available for making decisions about which structural and non-structural management practices function most effectively under what conditions and designs; and, within a specific category of BMPs, to what degree design and environmental static and state variables directly affect BMP performance. The protocols developed under this project and the Urban Stormwater BMP Performance Monitoring guidance addresses this need by helping to establish a standard basis for collecting water quality, flow, and precipitation data as part of a BMP monitoring program. The collection, storage, and analysis of this data will ultimately improve BMP selection and design.

One of the major findings of the EPA/ASCE BMP Database efforts to date has been that BMP pollutant removal performance for most pollutants is believed best assessed by the following: (Strecker et. al., 2001):

- How much stormwater runoff is prevented? (Hydrological Source Control)
- How much of the runoff that occurs is treated by the BMP or not?
- Of the runoff treated, what is the effluent quality?

For some pollutants, the amount of material captured could also be important, as well as how the BMP mitigates temperature and/or flow changes. Percent removal of pollutants is a highly problematic method for assessing performance and has resulted in some significant errors in BMP performance reporting (Strecker, et. al., 2001).

Urban Stormwater BMP Performance Monitoring: A Guidance Manual for Meeting the National Stormwater BMP Database Requirements (available for download at: [www.bmpdatabase.org](http://www.bmpdatabase.org)) is intended to improve the state of the practice by providing recommended methods for meeting the EPA/ASCE BMP Database protocols and standards (Urbonas 1994) for collecting, storing, analyzing, and reporting BMP monitoring data that will lead to better understanding of the function, efficiency, and design of urban stormwater BMPs. Furthermore, it provides insight into and guidance for strategies, approaches, and techniques that are appropriate and useful for monitoring BMPs. The overall focus of the document is on the collection, reporting, and analysis of water quantity and quality measurements for quantitative BMP performance studies. It does not address, in detail, sediment sampling methods and techniques, biological assessment, monitoring of receiving waters, monitoring of groundwater, streambank erosion, channel instability, channel morphology, or other activities that in many circumstances may be as, or more, useful for measuring and monitoring water quality for assessing BMP performance under some circumstances.

## **RE-EVALUATION OF THE NATIONAL BMP DATABASE**

The project team is completing a detailed assessment of the expanded database. Table 1 presents an overview of the BMPs currently in the database, including the number of data records for each BMP type. New BMP information is being provided to the database team at about a rate of 15 to 20 studies per year. These are studies that meet the protocols established for BMP monitoring and reporting. The 170 studies now in the database compares with the total of just over 60 BMP studies in the database during the initial evaluation.

Each study has again been analyzed in a consistent manner as described in Strecker, et. al. (2001) and on the project web site. The data being produced includes lognormal distribution based summary statistics, comparisons of influent and effluent water quality through parametric and non-parametric hypothesis tests, and a large number of other summary statistics. In this evaluation, the project team has been investigating the effects of BMPs on hydrology and effluent quality. The project team is currently working on evaluation of the design attributes versus BMP performance, which will be highlighted in more detailed at in the presentation.



**Table 1. Number of BMPs and Data Records (events or event mean concentrations) in the National BMP Database as of 11/01/02**

<b>BMP Type</b>	<b># of BMPs in Category with Design Information</b>	<b>Precipitation Records for BMP type</b>	<b>Flow Records for BMP Type</b>	<b>Water Quality Records for BMP Type</b>
Detention Basins	24	129	229	4209
Grass Filter Strips	32	227	385	6,251
Media Filter	30	187	327	6,144
Porous Pavement	5	5	5	55
Retention Pond	33	378	817	14,293
Percolation Trench and Dry Well	1	3	3	21
Wetland Channel and Swale	14	53	113	1,241
Wetland Basin	15	221	681	7,320
Hydrodynamic Devices	16	169	309	6,186
<b>Total</b>	<b>170</b>	<b>1372</b>	<b>2,869</b>	<b>45,720</b>

### **Hydrology Evaluation**

One of the goals of the data base was to provide better information on the effects of BMPs on hydrology and whether some BMPs may have some benefits over others in terms of reducing volume of runoff (Hydrological Source Control-HSC). For example, one would expect that a wet pond might not significantly decrease the volume of runoff, but a biofilter might, given the contact with more frequently drier soils and resulting evapotranspiration and/or infiltration. Accurately measuring flow during storm conditions is very difficult (EPA, 2002). In a field test of over 20 different flow measurement technologies and approaches, FHWA (2001) found that flow measurements can be upwards of 50% or more off of the expected true flow. Therefore assessments of the database will likely show some variability in flow changes due to measurement errors.

Figure 1 presents plots of inflow versus outflow for Biofilters (Swales and filter strips), Detention Basins (dry ponds), Retention Ponds (wet ponds) and Wetland Basins. Biofilters showed an average of 20% less volume of runoff on a storm-by-storm basis and were consistently lower for almost all storm events. The other BMPs showed a large scatter, but generally showed an increase in runoff volumes. While showing an increase on a storm-by-storm basis, dry ponds tended to have many more storms that were lower in outflow.

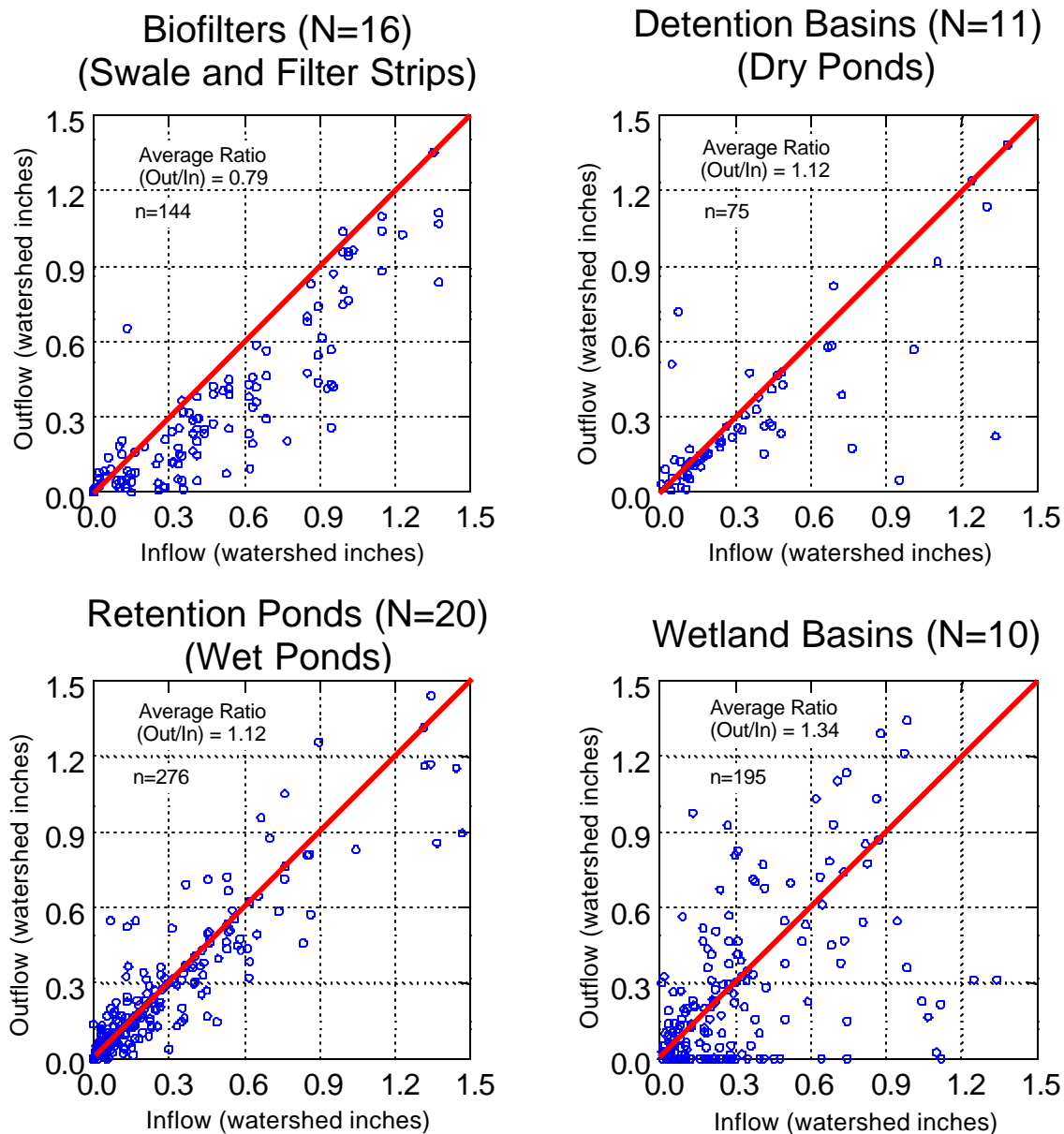
Table 2, presents the results of removing the smaller more insignificant storms from the analyses (storms resulting in flows less than 0.2 watershed inches removed). The term “watershed inches” refers to an area-normalized volume (the total volume divided by the total watershed area). From these analyses, it is apparent that detention basins (dry ponds) and biofilters (vegetated swales, overland flow, etc.) appear to contribute significantly to volume reductions, even though they were likely not specifically designed to do so. One needs to note that although in our protocols we ask for the total storm volume of the influent and effluent over the entire event, it is possible that some studies may have cut-off effluent sampling before the BMP returned to pre-storm conditions. Based upon the recommended criteria above for assessing BMP performance, it appears that there is a basis for factoring in volume and resulting pollutant load reductions into BMP performance. This has significant implications for Total Maximum Daily Loads (TMDLs) implementation planning and other stormwater management planning. It is also expected that as BMPs that are specifically designed to reduce runoff volumes (e.g., lower impact development, etc.) are tested and information added into the database, that these results will improve.

### **Water Quality Performance**

The analysis of water quality performance data of the BMPs that we are being conducted by the authors performing is comprised of three levels: 1) a comprehensive evaluation of effluent versus influent water quality; 2), comparisons of effluent quality amongst BMP types; and 3) comparisons of performance versus design attributes for BMP types and individual BMPs. Even with the increase in data in the database since the last evaluation, the total number of BMPs in any one category is still small as compared to the number of design parameters that can be potentially investigated. The approach that the team has taken is to develop groupings of BMPs by Design Factors. That is, our approach has been to develop categories of design parameters that are expected to affect performance, group BMPs into those that meet all or most of the factors (e.g., length to width ratios; volume of facility as compared to average storm inflow, etc.) and then explore if a difference in performance can be established and potentially explained by these assessments of these grouped design factors.

Figure 2 presents plots shows a box plot of the fractions of reported Total Suspended Solids (TSS) concentrations removed and the box plots of effluent quality of BMP types. As has been found previously (Strecker et. al., 2001), the effluent quality is much less variable than fraction removed. It appears that percent removal is more or less just a function of inflow concentration. Recent analysis of the expanded database shows that effluent quality can be assumed to be different among different BMP types. It appears that Retention Ponds (wet ponds) and Wetlands can achieve lower concentrations of TSS than other BMPs, while hydrodynamic devices were the lowest performers (higher effluent concentrations) on average. Similar results have been found for other constituents with some variations. One should note (discussed below) that there are serious questions regarding the validity of TSS as an accurate measure of suspended solids. However, the problems with TSS methods are likely not large with effluent quality as most of the potentially missed larger fractions would likely have been removed if the BMP is “working” at all.

Figure 3 shows the result for comparing Total Phosphorus and Total Copper concentrations for the same BMP categories. Wetlands and wet ponds are more consistent performers, while the other BMPs vary with regards to effluent quality results. The lowest effluent quality achieved for Phosphorus is on the order of 50 to 60 ug/l. This contrasts with some water quality efforts where the ultimate phosphorus goal has been selected to be in the range of 10 to 20 ug/l and then showing achievement of such goals by misapplication of percent removal approaches.



**Figure 1. Comparison of Individual Storm Inflow and Outflow Volumes for Indicated BMPs (N= number of BMPs included; n= number of storm events)**

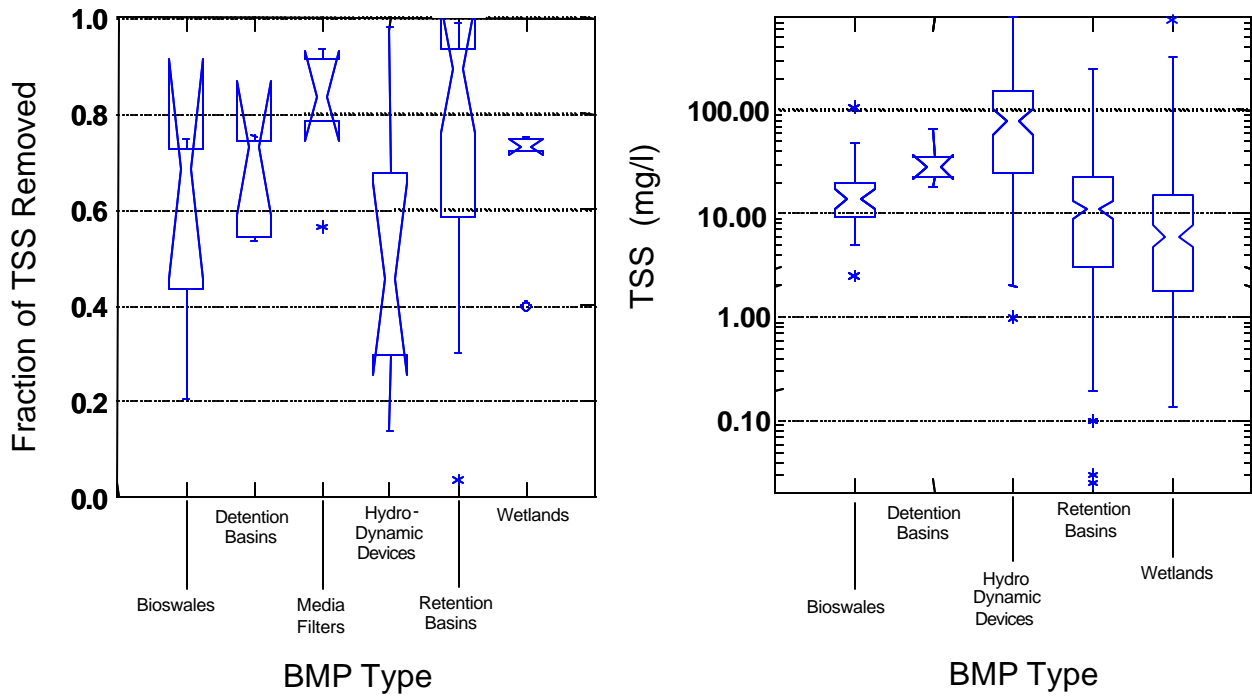
As mentioned above, we are exploring individual BMP designs (sizing, etc.) relative to performance. Some initial results of the expanded database have been encouraging. For example, the previous effort during the initial work was not able to statistically find a potential relationship between performance of retention ponds and wetlands and their treatment volume relative to measured storm events. Figure 4 shows a scatter plot of Retention Ponds (with a permanent pool) effluent quality versus the ratio of the treatment volume to mean monitored storm event volume, and a box plot of Retention Pond mean effluent quality for sites with ratio less than one and greater than one ratio of the treatment volume to mean monitored storm event volume. The plots clearly demonstrate that at those sites where the treatment volume was greater than the average size storm event monitored, the effluent quality was significantly lower. In addition, the variability of effluent quality for the larger retention ponds was lower. These results are expected, but it is one of the first times that they have been demonstrated statistically.

**Table 2. Ratio of Mean Monitored Storm Event Outflow to Inflow for Storms Greater than 0.2 watershed inches.**

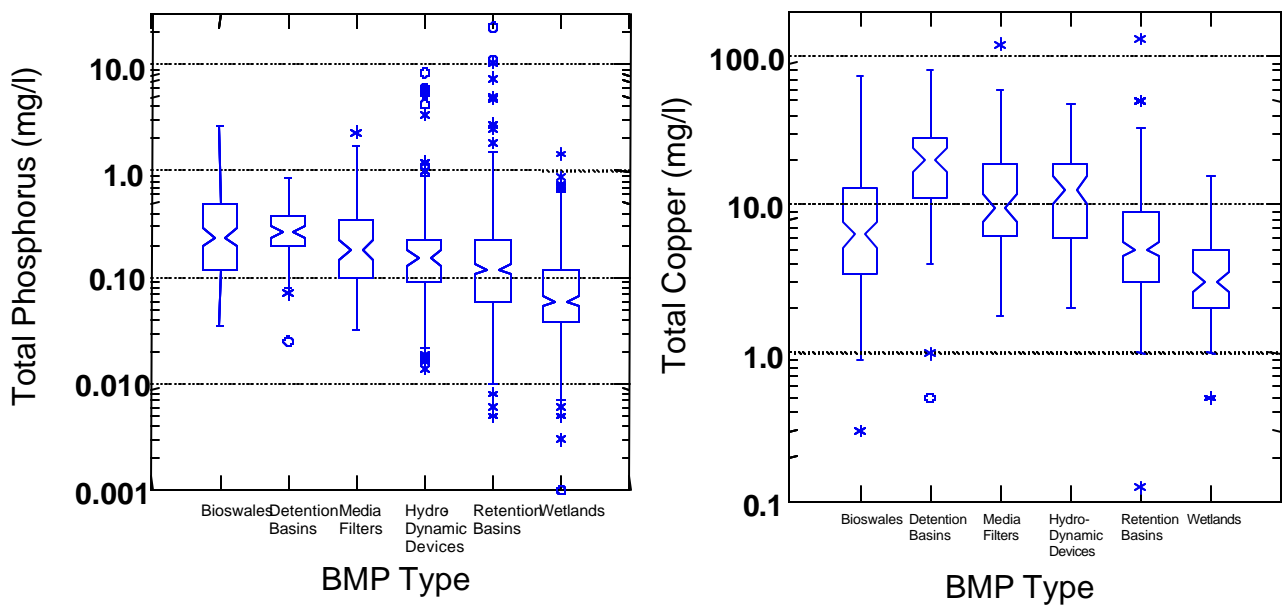
<b>BMP Type</b>	<b>Mean Monitored Outflow/Mean Monitored Inflow for Events Where Inflow is Greater Than or Equal to 0.2 Watershed Inches</b>
<b>Detention Basins</b>	<b>0.70</b>
<b>Biofilters</b>	<b>0.62</b>
<b>Media Filters</b>	<b>1.00</b>
<b>Hydrodynamic Devices</b>	<b>1.00</b>
<b>Wetland Basins</b>	<b>0.95</b>
<b>Retention Ponds</b>	<b>0.93</b>
<b>Wetland Channels</b>	<b>1.00</b>

Some of the other assessments that are being performed are the potential reductions in toxicity of heavy metals by BMPs. More recent BMP studies have been collecting data on water hardness and therefore there is the ability to assess potential toxicity issues via comparisons of effluent quality with EPA acute and chronic criteria values (as benchmarks as the criteria apply in receiving waters). One trend that we have noticed in the data is that for many BMPs, hardness levels are increased in effluent versus the influent and therefore this could contribute along with concentration reductions to reduce toxicity (as defined by EPA's Acute Criteria for Aquatic Life). We will also be looking at the effects of BMPs on load

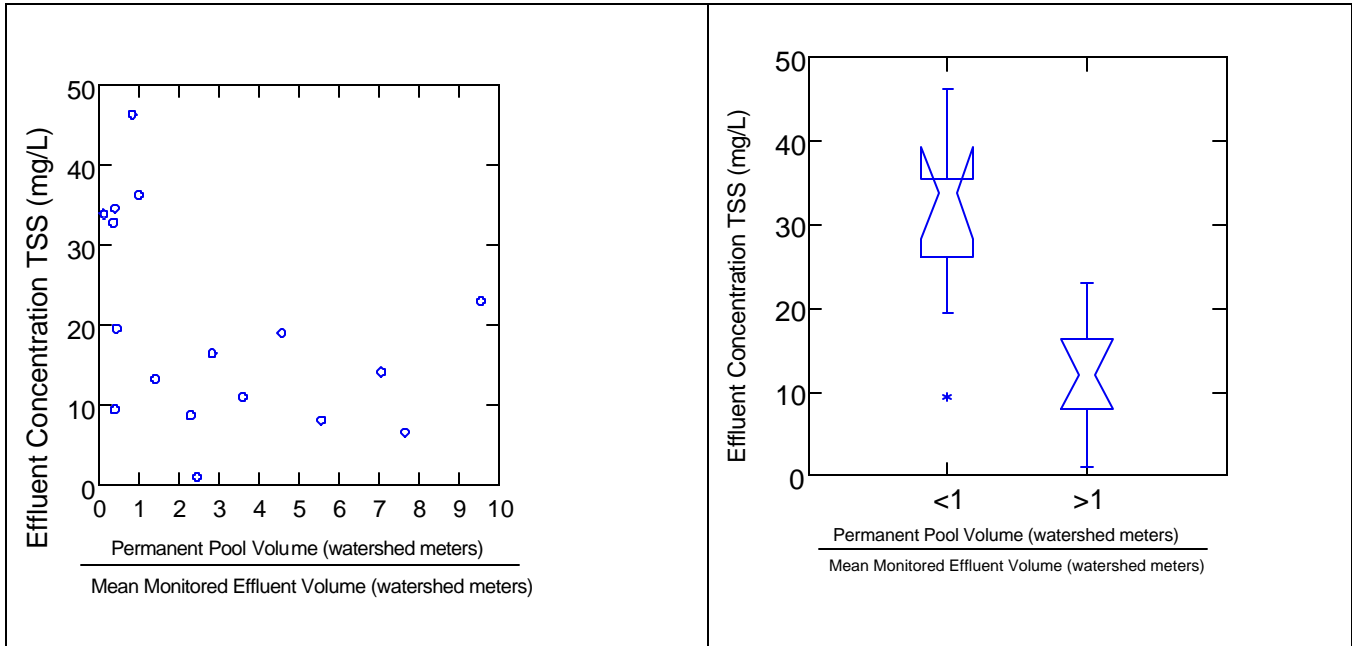
reductions considering both hydrological source control performance as well as effluent quality.



**Figure 2. Box plots of the fractions of Total Suspended Solids (TSS) removed and of effluent quality of selected BMP types**



**Figure 3. Box plots of effluent quality of selected BMP types for Total Phosphorus and Total Copper.**



**Figure 4. Scatter plot of 1) Retention Pond (with permanent wet pool) TSS effluent quality versus the ratio of the permanent pool volume to mean monitored effluent volume and 2) Box plots of the TSS effluent quality of sites grouped by a ratio of less than or greater than 1 for the ratio of the permanent pool volume to mean monitored effluent volume. (Note: watershed meters are calculated by dividing the volume by the total watershed area)**

## AN OVERVIEW OF THE URBAN STORMWATER BMP PERFORMANCE MONITORING

The Manual contains two main sections following the introduction:

**Overview of BMP monitoring.** A detailed discussion is provided on the context of BMP monitoring, difficulties in assessing BMP performance, and understanding the relationship between BMP study design and the attainment of monitoring program goals. Useful analysis of data collected from BMP monitoring studies is essential for understanding and comparing BMP monitoring study results. A summary of historical and recommended approaches for BMP performance data analysis is provided in this section to elucidate the relationship between the details and subtleties of each analysis approach and the assessment of performance. A recommended approach focusing on effluent quality and the amount of runoff treated (and not) is specified.

**Developing and Implementing a Monitoring Program.** This section provides specifics on how to develop a monitoring program, including selecting monitoring methods and equipment, installing and using equipment, implementing sampling approaches and

techniques, and reporting information consistent with the National Stormwater Best Management Practices Database.

***Supporting Materials.*** In addition, four appendices that focus on statistical methods for improving BMP monitoring studies and data reporting have been included in the guidance document. The first appendix describes detailed methods for estimating potential errors in field measurements. The second provides detailed information about the estimating the number of samples expected to be necessary to obtain statically significant monitoring data. The third appendix includes charts for estimating the number of samples required to observe a statically significant difference between two populations (e.g., inlet and outlet water quality) for a various levels of confidence and power. The final appendix is a table for estimating arithmetic descriptive statistics based on descriptive statistics of log-transformed data.

### **Understanding Variability and Sources of Error in BMP Performance Monitoring**

Based on a review of existing studies, it is apparent that much BMP research in the past has not considered several key factors. The most frequently overlooked factor is the number of samples required to obtain statistically valid assessments of water quality. The Manual provides direct and applicable guidance on approaches to integrating quantitative evaluations of potential sample results variability to improve attainment of study goals via the collection of adequate data. As the National Stormwater Best Management Practices Database is founded on the quantitative assessment of water quality performance of BMPs, the Manual focuses on providing practitioners with firm statistical footing for study design and implementation within that context. Specifically the manual focuses on the four factors that influence the probability of identifying a significant temporal and/or spatial changes in water quality, including:

- 1) Overall variability in BMP influent and effluent water quality data.
- 2) Minimum detectable change in water quality (difference in the mean and variability of concentrations).
- 3) Number of influent and effluent samples collected.
- 4) Desired confidence level from which to draw conclusions.

The manual recommends that statistical analyses should be conducted to estimate how many events need to be monitored to achieve a specified level of confidence in a desired conclusion (i.e., power analysis). Performing a power analysis requires that the magnitude of acceptable error in effluent quality and/or detectable change in pollutant concentration, the confidence level, the estimated variability of future samples collected and the statistical power or probability of detecting a difference are defined or can be estimated. A complete set of nomographs provided by Pitt (2001) were included in the Manual.

In addition to drawing attention to the need to better integrate improved understanding of the inherent variability found in water quality data, the authors would like to emphasize the

importance of collecting accurate flow data. Flow measurement data is often one of the most often overlooked sources of error and variability in BMP monitoring studies. In nearly all studies involving assessments of water quality, flow is used as a primary factor underlying all collected data. Not only are flow measurements used directly to calculate loads and event mean concentrations (depending on approach taken), flows are often used to pace samplers for collection of flow-weighted samples. They are also used in an attempt to understand watershed hydrology and effects of BMPs on flow reduction and/or attenuation. Very few studies look quantitatively at the likely errors introduced into BMP performance studies as a result of flow measurement errors. Errors in flow measurements are most often caused by field conditions that are inconsistent with the conditions under which rating curves for flow devices were calibrated, improperly installed or selected equipment, or poor maintenance.

However, even under ideal conditions, errors in flow measurement can be significant. Quantitative analyses should be conducted to determine the likely errors associated with lower flow rates that in many climates result in the majority of total runoff volumes. Flow equipment should be designed to accurately quantify flows that may be orders of magnitude above and below the mean flow rate. This is particularly the case for very small watersheds (less than an acre) which have extremely peaky flows and are receiving increased monitoring attention with the growing installation of “in watershed” controls. Many flumes and depth measurement approaches which work for large watersheds do not function well when the flow rates rapidly vary by more than three orders of magnitude with extremely low flows occurring during light rainfall periods. It is recommended that primary devices be used where possible and their selection be made carefully with full knowledge of the magnitude of likely errors associated with the selection. For example in cases in which there is a need for measurement of extreme flow ranges and a free overflow (no backwater conditions exist down stream) is available, the H, HS, or HL flumes should be considered. The range of flows that can be measured relatively accurately using H-type flumes can exceed three orders of magnitude; for example, a 3 ft H flume can measure flows between 0.0347 cfs at 0.10 ft of head to 29.40 cfs at 2.95 feet of head. H flumes are also not prone to issues associated with sediment build-up and are relatively unaffected by upstream turbulence.

Weirs are generally recognized as more accurate than flumes (Grant and Dawson 1997). A properly installed weir can typically achieve accuracies within 2 to 5% of the actual rate of flow, while flumes can typically achieve accuracies of 3 to 10% (Spitzer 1996). The ASTM cites lower errors for weirs ranging from about 1 to 3% and Parshall and Palmer-Bowlus flumes with typical accuracies around 5%. However, the overall accuracy of the flow measurement system is dependant on a number of factors, including proper installation, proper location for head measurement, regular maintenance, sediment accumulation within storms, the accuracy of the method employed to measure the flow depth, approach velocities (weirs), and turbulence in the flow channel (flumes). It should be noted, however, that the largest source of error in flow measurement of stormwater results from inaccuracies related to low flow or unsteady flow. Improper construction, installation, or lack of maintenance can result in significant measurement errors. A silted weir or inaccurately constructed flume can have associated errors of  $\pm 5$  to 10% or more (Grant and Dawson 1997). Circumstances present in many stormwater monitoring locations can result in errors well in excess of 100%.



There is a potential that certain BMPs could be more difficult to monitor accurately, as well as the outflow of some BMPs (those with significant storage) may be less peaky and therefore easier to measure. These both could affect the Qout/Qin (Table 2) results.

### ***Other Sources of Error***

A number of other sources of error are important to obtaining and reporting monitoring program data effectively. These errors should be specifically addressed in the QA/QC plan to increase awareness and potentially reduce their occurrence.

In many cases error is introduced in the process of transferring or interpreting information from the original data records. These errors most likely result from typographical errors or format and organizational problems. In most cases, water quality data are returned from the lab in some tabular format. Data are then entered into a database (or transferred from an electronic data deliverable-EDD), typically with separate records for each monitoring station and each storm event. Inconsistencies of data formats between monitoring events can considerably increase the potential for errors in entering data into the database and subsequently interpreting and using the processed (digital) data. Newly emerging tools for field data collection and observation such as personal digital assistant (PDA) deployed databases, which close the “paper gap” in collecting field data hold promise for decreasing some of the sources of these types of errors.

In addition to these “paper” errors, many other opportunities abound for introduction of other errors, including errors in interpretation and reporting of supporting information (e.g., misreading of maps, poor estimates of design, watershed, and environmental parameters, etc.) and reporting of information from previous studies that may have been originally incorrect.

In addition to the sources of error described above, all field collected and/or laboratory analyzed data on flow and water quality are subject to random variations that cannot be completely eliminated. These variations are defined as either “chance variations” or “assignable variations.” Chance variations are due to the random nature of the parameters measured; increased testing efforts and accuracies cannot eliminate these variations. Although assignable variations cannot be eliminated altogether, these variations can be reduced and the reliability of the data increased. Assignable variations are those errors that result from measurement error, faulty machine settings, dirty containers, etc. As discussed previously in this paper, increasing both the length of a study and/or the number of storms sampled can reduce the assignable variations and increase the reliability of the data (Strecker 1992). Many monitoring studies take place over relatively short periods and have a small number of monitored storms during those periods. Thus the resultant data sets are often susceptible to both of these types of variations.

### **Data Analysis Methods**

The ASCE/EPA project team reviewed available methodologies for data analysis as part of the publication of the first comprehensive analysis of data stored in the National Stormwater Best

Management Practices Database (available on the project website at [www.bmpdatabase.org](http://www.bmpdatabase.org)) and continues to look at more recent methods that have been proposed which are being used to re-evaluate the much more complete data set now available in the Database. In the manual, the authors recommend an effluent focused approach to efficiency evaluations labeled the Effluent Probability Method.

The Effluent Probability Method quantifies BMP efficiency in two steps. The first of these steps is to determine if the BMP is providing treatment (that the influent and effluent mean EMCs are statistically different from one another). The second step then focuses in on an examination of either a cumulative distribution function of influent and effluent quality or a standard parallel probability plot (essentially the same information in two different formats).

It is recommended that before any plots are generated, appropriate non-parametric (or if applicable parametric) statistical tests should be conducted to indicate if any perceived differences in influent and effluent mean event mean concentrations are statistically significant (the level of significance should be provided, instead of just noting if the result was significant, assume a 95% confidence level and 80% power).

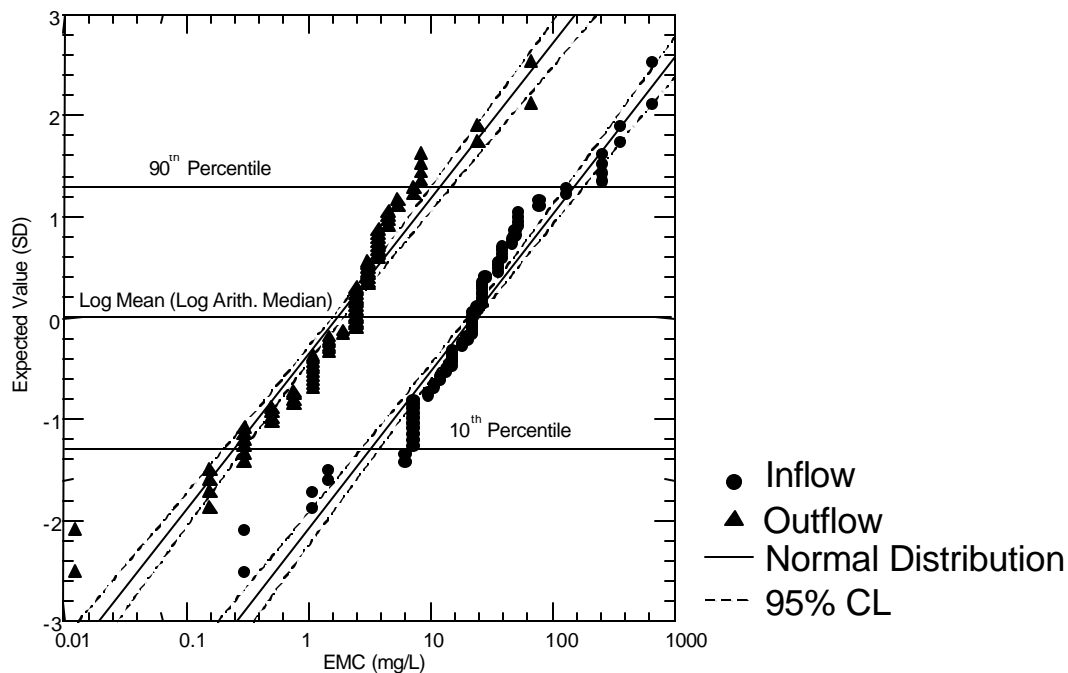
The Effluent Probability Method is straightforward and directly provides a clear picture of one of the ultimate measures of BMP effectiveness, effluent water quality. Curves of this type may be the single most instructive piece of information that can result from a BMP evaluation study. Although an exact format has yet to be agreed upon, the authors of this paper strongly recommend that the stormwater industry accept this approach as a standard “rating curve” for BMP evaluation studies. An example in the recommended format is shown in Figure 5, alternately the y axis can include “percent less than” instead of the expected value of the standardized normal distribution. It is critical that the BMP study also report on how much of the runoff is actually treated versus bypassed as well as infiltrated or evapotranspired as appropriate for some BMPs. This is the hydraulic performance of the BMP and effects evaluation of the effectiveness of various BMP sizes.

The Urban Water Resources Research Council and the Co-Principal Investigators for the ASCE/EPA National Stormwater Best Management Practices Database at the time of the writing of the paper are in the process of recommending a final format or standard “cut sheet” that will be recommended for inclusion in any BMP monitoring study to clearly and succinctly provide vital information to practitioners on the performance of a particular BMP. This standard “cut sheet” will be posted on the project website ([www.bmpbatabase.org](http://www.bmpbatabase.org)) both in generic format with guidelines for use and will be created for each BMP study that is included in the National Database.

### **Selecting Parameters**

Stormwater runoff may contain a variety of substances that can adversely affect the beneficial uses of receiving water bodies. The Manual recommends that the following factors are important to examine when selecting parameters to be included in a BMP monitoring program:

- Permit requirements (if any). Monitoring to comply with a permit may specify the parameters that must be measured in stormwater discharges. However, monitoring for additional parameters may help attain overall program objectives.



**Figure 5. Example Normal Probability Plot Recommended for Inclusion in All BMP Monitoring Studies as Part of the Effluent Probability Method.**

- Land uses in the catchment area. Land use is a major factor affecting stormwater quality. Developing a list of the pollutants commonly associated with various land uses is helpful for deciding what to look for when monitoring.
- Existing monitoring data (if any) for the catchment area. Previous monitoring data can be helpful in refining the parameter list and developing estimates of the potential variability of the BMP influent data. However, if there is uncertainty about the monitoring methods and/or analytical data quality, or if the existing data pertain to baseflow conditions or only one or two storms, caution should be used in ruling out potential pollutants. For example, an earlier study may have used outdated analytical methods which had higher detection limits than current methods.
- Beneficial uses of the receiving water. Information on water quality within a stormwater drainage system often is used to indicate whether discharges from the system are likely to adversely affect the receiving water body. For example, if a stormwater system discharges to a lake, consider analyzing for nitrogen and phosphorus because those constituents may promote eutrophication.
- Overall program objectives and resources. The parameter list should be adjusted to match resources (personnel, funds, time). If program objectives require assessing a large number of parameters (based on a review of land uses, prior monitoring data, etc.),

consider a screening approach where samples collected during the first one or two storms are analyzed for a broad range of parameters of potential concern. Parameters that are not detected, or are measured at levels well below concern, can then be dropped from some or all subsequent monitoring events. To increase the probability of detecting the full range of pollutants, the initial screening samples should be collected from storms that occur after prolonged dry periods.

A recommended list of constituents (along with recommended method detection limits for comparing stormwater samples to water quality criteria) for BMP monitoring has been developed and is presented in Table 3 below. Refer to Strecker (1994) and Urbonas (1994) for more information on BMP monitoring parameters. The choice of which constituents to include as standard parameters is subjective. The following factors were considered in developing the recommended list of monitoring parameters:

- The pollutant has been identified as prevalent in typical urban stormwater at concentrations that could cause water quality impairment (NURP 1983; FHWA 1990; and recent Municipal NPDES data).
- The analytical result can be related back to potential water quality impairment.
- Sampling methods for the pollutant are straightforward and reliable for a moderately careful investigator.
- Analysis of the pollutant is economical on a widespread basis.
- Controlling the pollutant through practical BMPs, rather than trying to eliminate the source of the pollutant (e.g., treating to remove pesticide downstream instead of eliminating pesticide use).

Although not all of the pollutants recommended here fully meet all of the factors listed above, the factors were considered in making the recommendations. When developing a list of parameters to monitor for a given BMP evaluation, it is important to consider the upstream land uses and activities.

The base list represents a basic set of parameters. There may be appropriate applications where other parameters should be included. For a discussion of why some parameters were not included, see Strecker (1994).

### ***Dissolved versus Total Metals***

Different metal forms (species) show different levels of toxic effects. In general, metals are most toxic in their dissolved, or free ionic form. Specifically, EPA developed revised criteria for the following dissolved metals: arsenic, cadmium, chromium, copper, lead, mercury (acute only), nickel, silver, and zinc. Chronic criteria for dissolved mercury were not proposed because the criteria were developed based on mercury residuals in aquatic organisms (food chain effects) rather than based on toxicity. For comparisons with water quality criteria, it is advised that the dissolved metals fraction be determined, along with total metals. If selenium or mercury is of concern, total concentrations should be measured to enable comparison with criteria based on bioaccumulation by organisms.

**Table 3: Typical urban stormwater runoff constituents and recommended detection limits**

<b>Parameter</b>	<b>Units</b>	<b>Target Detection Limit</b>
<b>Conventional</b>		
pH	pH	N/A
Turbidity	mg/L	4
Total Suspended Solids	mg/L	4
Total Hardness	mg/L	5
Chloride	mg/L	1
<b>Bacteria</b>		
Fecal Coliform	MPN/100ml	2
Total Coliform	MPN/100ml	2
Enterococci	MPN/100ml	2
<b>Nutrients</b>		
Orthophosphate	mg/L	0.05
Phosphorus – Total	mg/L	0.05
Total Kjeldahl Nitrogen (TKN)	mg/L	0.3
Nitrate – N	mg/L	0.1
<b>Metals-Total Recoverable</b>		
Total Recoverable Digestion	µg/L	0.2
Cadmium	µg/L	1
Copper	µg/L	1
Lead	µg/L	5
Zinc	µg/L	
<b>Metals-Dissolved</b>		
Filtration/Digestion	µg/L	0.2
Cadmium	µg/L	1
Copper	µg/L	1
Lead	µg/L	5
Zinc	µg/L	
<b>Organics</b>		
Organophosphate Pesticides (scan)	µg/L	0.05 - .2

**Note:** This list includes constituents found in typical urban stormwater runoff. Additional parameters may be needed to address site specific concerns.

The distribution of pollutants between the dissolved and particulate phases will depend on where in the system the sample is collected. Runoff collected in pipes with little sediment and organic matter will generally have a higher percentage of pollutants present in the dissolved form. Runoff collected in receiving waters will generally have a higher percentage of pollutants present in particulate form due to higher concentrations of suspended solids and organic matter that acts as adsorption sites for pollutants to attach to. It is difficult to

determine how much of the dissolved pollutants found in storm system pipes will remain in the dissolved form when they are mixed with suspended sediments in receiving waters. As a result, it is difficult to determine the ecological significance of moderate levels of dissolved pollutants present within the conveyance system. In addition, hardness values for receiving waters are often different than those for stormwater. Hardness affects the bio-availability of heavy metals, further complicating the ecological impact of dissolved heavy metals. Hardness values are typically higher in hardened conveyance systems than in receiving waters or earthen channels.

If loads to the receiving waters are of concern (e.g., discharge to a lake known to be a water quality limited water body) than analyzing for total recoverable metals is particularly recommended. Finally, total recoverable metals data together with dissolved metals data can be used to assess potential metals sediment issues.

### ***Measurements of Sediment Concentration***

A variety of methods have been employed in stormwater quality studies for quantifying sediment concentrations. The most frequently cited parameter is “TSS” or total suspended solids. The “TSS” label is used, however, to refer to more than one sample collection and sample analysis method. The “TSS” analytical method originated in wastewater analysis as promulgated by the American Public Health Association.

The USGS employs the suspended-sediment concentration (SSC) method (ASTM 2000), which was originally developed for the Federal Interagency Sedimentation Project (USGS 2001). SSC data is often described as TSS data, when in many cases results from the two methods can be significantly different. The difference between methods is sample size – the SSC method analyzes the entire sample while the TSS method uses a sub-sample. The process of collecting a representative sub-sample containing larger sediment particles is problematic as large sediment particles (e.g., sand) often settle very quickly. Differences between the results obtained from SSC and TSS analytical methods become apparent when sand-sized particles exceed 25% of the sample sediment mass (Gray et al. 2000). Gray demonstrates that at similar flow rates, sediment discharge values from SSC data can be more than an order of magnitude larger than those from TSS data (USGS 2001) due primarily to larger particles that are often missed in the TSS method. “The USGS policy on the collection and use of TSS data establishes that TSS concentrations and resulting load calculations of suspended material in water samples collected from open channel flow are not appropriate” (USGS 2001).

The authors recommend that both TSS (for comparison to existing data sets) and SSC be measured for BMP monitoring studies. The difference between TSS and SSC in samples from BMPs that are even mildly performing should be minimal (e.g., if the BMP is functioning at all then the sands and larger particles should be removed. Therefore, assessing effluent data from past BMP performance studies, rather than percent removal eliminates, is likely to be a much more valid approach.

The discrepancies in sampling methodologies currently employed in the field highlight the importance of particle size distribution (PSD) analysis as an essential component of any BMP monitoring study. PSD data provide the information necessary to meaningfully interpret the ability of a BMP to remove suspended materials. However, PSD methods are varied even within a given technique and include (USGS 2001):

- Dry sieve.
- Wet sieve.
- Visual accumulation tube (VA).
- Bottom withdrawal tube.
- Pipet.
- Microscopy.
- Coulter counter.
- Sedigraph (x-ray sedimentation).
- Brinkman particle size analyzer.
- Laser diffraction spectroscopy.
- Light-based image analysis

At this time the authors recommend selecting and using a consistent and appropriate method from the above (i.e., no single method has been established as the standard).

Specific gravity (SG) of sediments is also an important component in determining the settleability of sediments and is recommended for sediment analysis by ASTM (1997). For BMP studies where PSD data are being collected, SG provides additional useful information about the ability of a particular BMP to remove sediment.

In addition, settling velocities of sediments are highly important and can be either measured directly or calculated theoretically from SG and PSD data. Settling velocities give the most useful information for quantifying BMP sediment removal efficiency.

The difficulty of collecting accurate sediment samples underscores the need to fully understand the conditions under which sediment data were collected and analyzed. Regardless of the analytical methods used, the sampling methodology often introduces the largest bias to sediment data. For example the depth at which the sample was collected can significantly impact results. Again, the impacts would be much greater on influent data rather than effluent data due to the fact the BMP should be removing the larger particles.

## CONCLUSIONS

An evolving tool is available to practitioners who are assessing the performance of BMPs via the National Stormwater Best Management Practices Database Project. Practitioners can perform their own evaluations by downloading information from the web site.

Results of the analyses of the now expanded database have reinforced the initial finding that BMPs are best described by how much they reduce runoff volumes, how much of the runoff that occurs is treated (and not) by the BMP, and of the runoff treated what effluent quality (concentrations and potential toxicity) is achieved. These basic BMP performance descriptions can then be utilized to assess effects on total loadings, frequency of potential exceedances of water quality criteria or other targets, and other desired water quality performance measures. The results show that the effluent quality of various BMP types can

be statistically characterized as being different from one another. Additionally, some design parameters may be statistically significant with regards to performance.

A new guidance tool is available to practitioners who are conducting BMP monitoring studies and wish to comply with the standards established as part of the National Stormwater Best Management Practices Database Project. The Manual contains a comprehensive and practical discussion on all elements of water quality, flow, and precipitation monitoring and discusses them within the specific framework of the National Database.

## **ACKNOWLEDGEMENTS**

The project team would like to thank Jesse Pritts, P.E. and Eric Strassler of the Environmental Protection Agency for their support for and participation in the ASCE/EPA National Stormwater Best Management Practices Database Project. The authors would also like to thank the following members of ASCE's Urban Water Resources Research Council for their thorough reviews and contributions to the Database Project: Robert Pitt, P.E., Ph.D. (University of Alabama, Birmingham), Eugene Driscoll, P.E., Roger Bannerman, P.E. (Wisconsin Department of Natural Resources), Shaw Yu, P.E., Ph.D. (University of Virginia), Betty Rushton (Southwest Florida Water Management District), Richard Field (EPA), P.E., Jonathan Jones, P.E. (Wright Water Engineers), Jane Clary (Wright Water Engineers), and Tom Langan (Wright Water Engineers). The initial database evaluation findings discussed in this paper are those found by the authors only and not the listed individuals above.

## **REFERENCES**

- American Society for Testing and Materials. (2000). *Standard Test Method for Determining Sediment Concentration in Water Samples*. ASTM Designation D 3977-97, 395-400.
- EPA. (1997). *Monitoring Guidance for Determining the Effectiveness of Nonpoint Source Controls*. EPA 841-B-96-004. U.S. Environmental Protection Agency, Office of Water, Washington, D.C. September.
- EPA (2002). *Urban Stormwater BMP Performance Monitoring: A Guidance Manual for Meeting the National Stormwater BMP Database Requirements*. EPA 821-C-02-005. U.S. Environmental Protection Agency, Office of Water, Washington, D.C. April.
- FHWA. (2001). *Guidance Manual for Monitoring Highway Runoff Water Quality*. FHWA-EP-01-022. Federal Highway Administration, U.S. Department of Transportation. Federal Highway Administration. Washington, D.C.
- Grant, D.M. and B.D. Dawson. (1997). *ISCO Open Channel Flow Measurement Handbook*. ISCO Environmental Division. Lincoln, NE.



Gray, J.R., G.D. Glysson, and L.M. Turcios. (2000). "Comparability and reliability of total suspended solids and suspended-sediment concentration data". *U.S. Geological Survey Water-Resources Investigations Report 00-4191*. U.S. Geological Survey.

National Urban Runoff Program. (1983). *Final Report*. U.S. Environmental Protection Agency Water Planning Division, Washington, D.C.

Pitt, R. (2001). Personal Correspondence. Peer review meeting, August.

Spitzer, DW (ed.) (1996). *Flow Measurement Practical Guides for Measurement and Control*. Instrument Society of America. NC.

Strecker, E.W., M.M. Quigley, B.R. Urbonas, J.E. Jones, and J.K. Clary. (2001). "Determining Urban Storm Water BMP Effectiveness". *Journal of Water Resources Planning and Management*, 127(3), 144-149.

Strecker, E.W., J.M. Kersnar, E.D. Driscoll, and R.R. Horner. (1992). The use of wetlands for controlling storm water pollution. The Terrene Institute, Washington, D.C.

Strecker, E.W. (1994). Constituents and Methods for Assessing BMPs. In *Proceedings of the Engineering Foundation Conference on Storm Water Monitoring*. August 7-12, Crested Butte, CO.

Urbonas, B.R. (1994). Parameters to Report with BMP Monitoring Data. In *Proceedings of the Engineering Foundation Conference on Storm Water Monitoring*. August 7-12, Crested Butte, CO.

USGS. (2001). *A Synopsis of Technical Issues for Monitoring Sediment in Highway and Urban Runoff*. Open-File Report 00-497. U.S. Geological Survey, Northborough, MA.



## EPA's Management Measures Guidance to Control Nonpoint Source Pollution from Urban Areas

*It's Time to Develop and Implement Your Storm Water  
Management Program...Are You Ready?*

Rod Frederick and Robert Goo  
U.S. Environmental Protection Agency  
Nonpoint Source Control Branch (4503F)  
1200 Pennsylvania Avenue, NW  
Washington, DC 20460

Martina Keefe  
Tetra Tech, Inc.  
10306 Eaton Place, Suite 340  
Fairfax, VA 22030

Poster Session for *Urban Storm Water:  
Enhancing Programs at the Local Level*  
February 17-20, 2003  
The Westin Michigan Avenue  
Chicago, Illinois



# EPA's Management Measures Guidance to Control Nonpoint Source Pollution from Urban Areas

*It's Time to Develop and Implement Your Storm Water Management Program...Are You Ready?*

## Introduction

Urban runoff/storm sewers were listed among the top three sources of water quality impairment in rivers, lakes, and estuaries, according to the *National Water Quality Inventory: 1998 Report to Congress* (USEPA, 2000). This indicates that urban areas have been a substantial contributor to the decline of water resources in the U.S. As population continues to grow and urban areas expand (see Figure 1), the quality of water bodies near urban centers will continue to be threatened unless actions are taken to reduce the impact of everyday human activities on water resources.

This is not just an issue of pollutant loading, although urban areas can be a significant source of several pollutants, especially nutrients, sediments, heavy metals, and toxic chemicals. Also of concern are the increase in the volume of runoff and the change in runoff timing that results when land in a predominantly pervious condition (i.e., forested or meadow) is converted to impervious surfaces—buildings, streets, sidewalks, parking lots, or other infrastructure.

The complicating factor in mitigating urban storm water is that the sources of pollution are diffuse and are therefore difficult to locate and manage. For example, nutrient pollution in urban areas can come from a variety of sources that include failing septic systems, improper connections to the storm drain system, overfertilization of lawns, and poorly managed pet waste. Each source can require a different strategy for elimination, which can seem overwhelming to small programs faced with pollution problems.

Because managing urban storm water is not a simple task, EPA has developed guidance to help watershed managers put together a comprehensive and effective program to address a myriad of urban sources. The most recent guidance, called *National Management Measures to Control Nonpoint Source Pollution from Urban Areas—Draft*, is an update of Chapter 4 of the 1993 *Guidance Specifying Management Measures for Sources of Nonpoint Pollution in Coastal Waters*.

The 1993 document was designed to aid coastal states in developing nonpoint source control programs to meet the requirements of the Coastal Zone Act

Reauthorization Amendments of 1990. The 2002 guidance document is intended to provide technical assistance to state and local program managers and other practitioners on the best available, most economically achievable means of managing urban storm water. It describes how to develop a “comprehensive runoff management program” that deals with all phases of development—from predevelopment watershed planning and site design, through the construction phase of development, to the operation and maintenance of structural controls. It also provides information for other situations such as retrofitting existing development, implementing nonstructural controls,

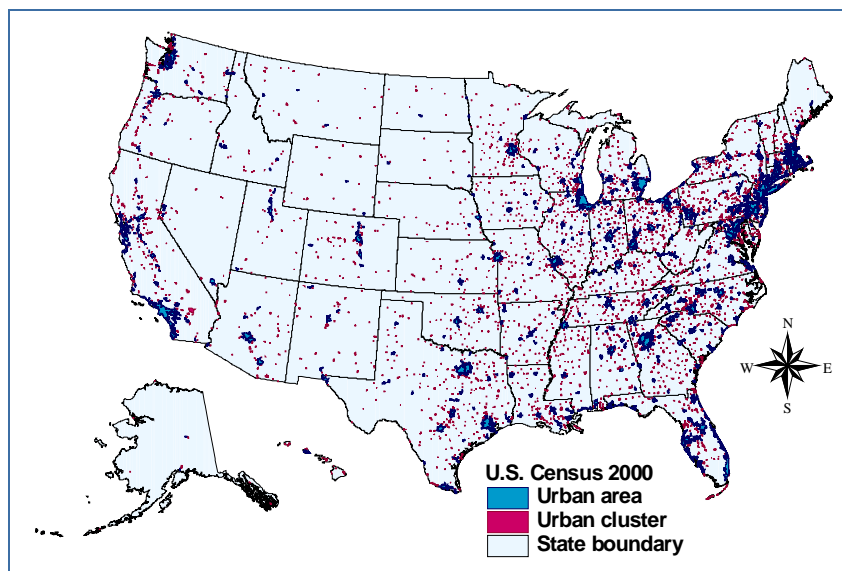


Figure 1. Urban areas and urban clusters according to the 2000 U.S. Census (USCB, 2002)

and reevaluating the storm water management program (see Figure 2).

## How Does This Relate to NPDES Phase II Storm Water?

The publication of the guidance is timely because thousands of small municipalities (with a population between 1,000 and 10,000 with a population density of at least 1,000 people per square mile) and other entities (e.g., private institutions, Department of Defense facilities) that own and operate separate storm sewer systems will need to apply for a permit to discharge municipal storm water under Phase II of the National Pollutant Discharge Elimination System (NPDES) Storm Water Program. NPDES permit coverage must be obtained by March 10, 2003. To meet the



Figure 2. Comprehensive Runoff Management Program

### Box 1. NPDES Storm Water Phase II Program Requirements

Regulated municipalities must develop and implement a **Storm Water Management Program (SWMP)** that will reduce pollutants in storm water to the **Maximum Extent Practicable (MEP)**. The SWMP must include **BMPs** for each of the **6 Minimum Control Measures**, which are:

1. Public Education and Outreach on Storm Water Impacts
2. Public Involvement/Participation
3. Illicit Discharge Detection and Elimination
4. Construction Site Runoff Control
5. Post-Construction Storm Water Management in New Development and Redevelopment
6. Pollution Prevention/Good Housekeeping for Municipal Operations

In addition to BMPs, regulated municipalities will also have to develop **Measurable Goals** that will allow both the municipality and the permitting authority to gauge whether each BMP was successful. Municipalities also need to develop a timeline for implementation of each element of the program and identify the party or parties responsible.

requirements outlined in the Phase II Storm Water Rule (Box 1), regulated municipalities must implement a storm water management program that includes best management practices (BMPs) and measurable goals for six minimum control measures.

### How Can Your Storm Water Management Program Be Both Comprehensive and Cost-Effective?

*The National Management Measures to Control Nonpoint Source Pollution from Urban Areas—Draft* presents a comprehensive process for developing a program from scratch or from existing programs. The guidance includes information about establishing institutional frameworks, securing funding sources, conducting assessments, working with stakeholders, and implementing structural and non-structural BMPs.

The process is presented in a stepwise fashion that is organized by management measures, which each cover a distinct topic area such as roads and highways, construction sites, pollution prevention, etc. The management measures provide a framework for grouping BMPs based on their role in mitigating the effects of urban runoff. Storm water managers can use this organizing framework to ensure that their program addresses the entire range of pollutants and sources with a set of BMPs that work together in a streamlined, cost-effective way.

Each management measure also describes a set of performance objectives or goals for a specific area of storm water management. These goals are somewhat

broader in scope than what EPA intends for measurable goals under the NPDES Phase II Storm Water Program, but they can be adapted for use in the storm water management program. For example, the Site Development Management Measure states the following:

Plan, design, and develop sites to

- Maintain predevelopment site hydrology by using site design techniques that store, infiltrate, evaporate, or detain runoff.
- Protect areas that provide important water quality benefits or are particularly susceptible to erosion and sediment loss.
- Limit increases of impervious areas unless predevelopment site hydrology is maintained (Figure 3). Limit land disturbance activities, such as clearing and grading and cut-and-fill, to reduce erosion and sediment loss.
- Limit disturbance of natural drainage features and vegetation.

Some BMPs that were considered appropriate for meeting this management measure are:

- Promoting the use of cluster and open space development
- Providing incentives to developers to reduce impervious areas
- Conducting site assessments to identify ecologically or historically significant areas for preservation and locate key opportunities for storm water management and ground water recharge.
- Reducing the size of impervious surfaces by using green roofs or modifying sidewalk, driveway, or road standards

Some measurable goals that can be derived from this management measure are as follows:

- Conduct a study, to be completed by the 3rd year of the 5-year permit, to determine an appropriate



Figure 3. Urban areas contain a great deal of impervious surface that accumulates pollutants and transports runoff rapidly to receiving waters

minimum storm water infiltration rate for practices installed in new development. Also examine ways that impervious area or density credits can be offered for innovative and highly effective storm water management practices.

- Describe a protocol for developers to use to determine the amount of infiltration and detention practices needed to maintain predevelopment hydrology and publish this protocol in a report to be distributed to all developers working within the NPDES-permitted area or to be included in a local ordinance.
- Conduct a survey to identify areas that provide water quality benefits (e.g., ground water recharge areas, areas with steep slopes or highly erodible soils, ecologically significant areas) in the 1st year of the permit. Conduct a study that examines alternatives for protecting the priority lands identified above by the 3rd permit year. Incorporate this into guidance provided to the development community.

### How Can the Manual Help You Meet the 6 Minimum Control Measures?

Below is a matrix showing how each section of *National Management Measures to Control Nonpoint Source Pollution from Urban Areas—Draft* relates to the 6 minimum control measures of NPDES Phase II Storm Water.

## How Do the Management Measures Compare to the 6 Minimum Control Measures of NPDES Phase II?

	Public Education	Public Involvement	Illicit Discharge	Construction Site ESC	Post-construction	Pollution Prevention
<b>Program Framework and Objectives</b>						
Establish Legal Authority			✓	✓	✓	✓
Develop an Institutional Structure						
Provide Adequate Funding and Staffing						
Foster Input From Technical Experts, Citizens, and Stakeholders		✓				
Establish Intergovernmental Coordination		✓				
Develop Training and Education Programs and Materials	✓	✓				
<b>Watershed Assessment</b>						
Characterize Watershed Conditions						
Establish a Set of Watershed Indicators						
<b>Watershed Protection</b>						
Identify Critical Conservation Areas					✓	
Preserve Environmentally Significant Areas					✓	
Establish and Protect Stream Buffers					✓	
Promote Urban Forestry					✓	
Encourage Waterbody & Natural Drainage Protection When Siting Developments					✓	
<b>Site Development</b>						
Site Planning Practices					✓	
On-Lot Impervious Surfaces					✓	
Residential Street and Right-of-Way Impervious Surfaces					✓	
Parking Lot Impervious Surfaces					✓	
Xeriscaping Techniques					✓	
<b>New Development Runoff Treatment</b>						
Detention Ponds or Vaults					✓	
Ponds					✓	
Wetlands					✓	
Infiltration Practices					✓	
Filtering Practices					✓	
Open Channel Practices					✓	
Miscellaneous Practices					✓	
<b>New and Existing On-Site Wastewater Treatment Systems</b>						
Permitting and Installation Programs			✓			✓
Operation and Maintenance Programs			✓			✓
<b>Bridges and Highways</b>						
Site Planning and Design Practices					✓	
Structural Runoff Controls for Highways					✓	
Structural Runoff Controls for Bridges					✓	
Bridge Operation and Maintenance Controls						✓
Nonstructural Runoff Control Practices						✓
<b>Construction Site Erosion, Sediment, and Chemical Control</b>						
Erosion and Sediment Control Programs				✓		
Erosion Control Practices				✓		
Sediment Control Practices				✓		
Develop/Implement Programs to Control Chemicals/Construction Materials				✓		✓

	Public Education	Public Involvement	Illicit Discharge	Construction Site ESC	Post-construction	Pollution Prevention
<b>Pollution Prevention</b>						
Household Hazardous Wastes	✓	✓				✓
Lawn, Garden, and Landscape Activities	✓	✓				✓
Commercial Activities	✓	✓	✓			✓
Proper Disposal of Pet Waste	✓	✓				
Trash	✓	✓				✓
Nonpoint Source Pollution Education for Citizens	✓	✓				
<b>Existing Development</b>						
Identify, Prioritize, and Schedule Retrofit Opportunities					✓	
Implement Retrofit Projects as Scheduled					✓	
Restore and Limit the Destruction of Natural Runoff Conveyance Systems					✓	
Restore Natural Streams					✓	
Preserve, Enhance, or Establish Buffers					✓	
Revitalize Urban Areas					✓	
<b>Operation and Maintenance</b>						
Establishing an Operation and Maintenance Program					✓	✓
Source Control Operation and Maintenance					✓	✓
Treatment Control Operation and Maintenance					✓	✓
<b>Evaluate Program Effectiveness</b>						
Assess the Runoff Management Program Framework						
Track Management Practice Implementation						
Gauge Improvements in Water Quality						

## References

U.S. Environmental Protection Agency (USEPA). 2000. *National Water Quality Inventory: 1998 Report to Congress*. <http://www.epa.gov/305b/98report>. Last updated and accessed September 26, 2002.

U.S. Census Bureau (USCB). 2002. *Urbanized Areas: Cartographic Boundary Files*. <http://www.census.gov/geo/www/cob/ua2000.html>. Last updated May 23, 2002. Accessed September 26, 2002.

## For More Information

NPDES Phase II Storm Water Program  
<http://cfpub.epa.gov/npdes/stormwater/swphase2.cfm>

EPA Office of Wetlands, Oceans, and Watersheds  
 Nonpoint Source Branch  
<http://www.epa.gov/owow/nps/>

## How To Obtain A Copy

To obtain a copy of the *National Management Measures to Control Nonpoint Source Pollution From Urban Areas—Draft*, visit [www.epa.gov/owow/nps/urbanmm/index.html](http://www.epa.gov/owow/nps/urbanmm/index.html) to download it in PDF format or contact Rod Frederick at

### U.S. Postal Service Requests:

Assessment and Watershed Protection Division  
 (4503-T)  
 U.S. Environmental Protection Agency  
 1200 Pennsylvania Avenue, NW  
 Washington, DC 20460

### Non-U.S. Postal Service Requests:

Assessment and Watershed Protection Division  
 U.S. Environmental Protection Agency  
 EPA West, Room 7417A  
 1301 Constitution Ave., NW  
 Washington, DC 20004

Phone: 202-566-1197

Fax: 202-566-1331

**EVALUATING INNOVATIVE STORMWATER TREATMENT  
TECHNOLOGIES UNDER THE ENVIRONMENTAL TECHNOLOGY  
VERIFICATION (ETV) PROGRAM**

Author: Donna B. Hackett, NSF International  
Co-Authors: John Schenk, NSF International  
and Mary Stinson, USEPA/NRMRL

NSF International and USEPA/NRMRL  
Ann Arbor, MI and Edison, NJ respectively



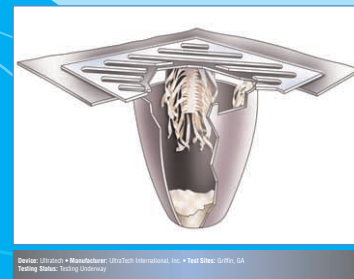
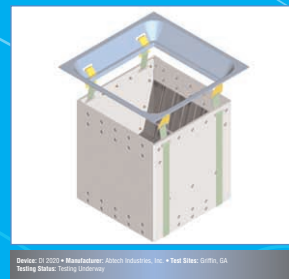
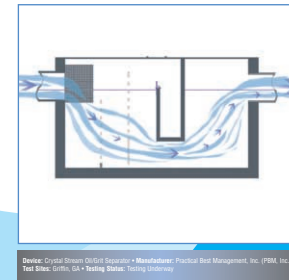
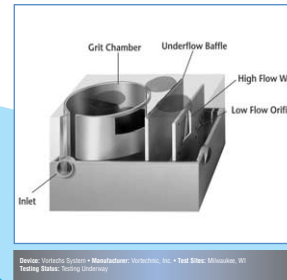
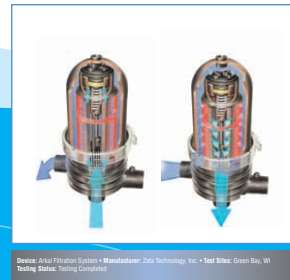
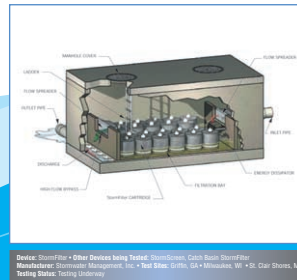
# ETV Stormwater Devices

USEPA and NSF International have partnered through the Environmental Technology Verification (ETV) Program's Water Quality Protection Center (WQPC) to verify the performance of innovative, commercial ready technologies designed to protect ground and surface waters from contamination. The WQPC evaluates technologies using technically sound protocols and appropriate QA/QC, thereby providing technology users and permittees with independent and credible assessments of technologies. These assessments will be posted on the NSF and EPA ETV Web-sites, [www.nsf.org/etv](http://www.nsf.org/etv) and [www.epa.gov/etv](http://www.epa.gov/etv) Stormwater treatment technologies are one of five wet weather flow technology areas being addressed in this ETV program. The following devices are either being presently tested, or have completed testing:

Sponsored By



## Stormwater Treatment Technologies



Authors: Donna B. Hackett, NSF International and John Schenk, PE, PhD, NSF International and Mary Stinson, US EPA/NRMRL

## **Managing Storm Water in Wisconsin: A Local Partnership Protects the Kinnickinnic River**

D. Kent Johnson and Andy Lamberson  
Trout Unlimited, Kiap-TU-Wish Chapter

### **Setting:**

Some of the best trout fishing in the Midwest can be found in St. Croix County, one of the fastest-growing counties in Wisconsin. The City of River Falls, located on the southern edge of St. Croix County and in the heart of the Kinnickinnic River Watershed (Map 1), is home to 12,000 people. Because of its close proximity to the major metropolitan area of Minneapolis-St. Paul, MN, River Falls is a rapidly growing community, with a 20% population increase during the past decade. Growth estimates project a population of 16,500 by the year 2010 (Ayres and Associates, 1987). This estimate may be conservative, however, since it does not include growth in the surrounding townships, where agricultural lands are rapidly being converted to rural residential uses (SEH, 1995).

The Kinnickinnic River, a state “outstanding resource water”, flows through River Falls in west-central Wisconsin. A premiere trout stream, the “Kinni” is renowned for its dense populations of wild brown trout. Approximately 2,000-8,000 trout per mile reside in the river, with no stocking needed to sustain this naturally reproducing fishery. According to fisheries biologists, a trout population of 1,000 fish per mile is considered excellent.

### **Scientific Assessment of Local Storm Water Impacts:**

The Kinnickinnic River is a valuable cold-water resource representing a major natural amenity of the River Falls community. Although trout populations in the river are currently high, the effect of growth in the City of River Falls and surrounding townships has the potential to degrade the physical, chemical, and biological characteristics of the Kinnickinnic River and its tributaries. As growth occurs, the creation of impervious surfaces like roofs, sidewalks, driveways, streets, and parking lots generates a substantial amount of storm water runoff that can significantly affect a river. Storm water impacts include higher stream flows, thermal pollution, chemical pollution, and sedimentation (Schueler, 1994), all of which pose threats to aquatic habitat, trout, and other cold-water organisms.

### **Biological and Habitat Impacts**

In the early 1990s, the local Kiap-TU-Wish Chapter of Trout Unlimited (Kiap-TU-Wish) and the Wisconsin Department of Natural Resources (WDNR) began noting differences in trout populations and habitat quality in the Kinnickinnic River, above and below the City of River Falls. Likely due to storm water runoff, trout populations were

significantly lower and stream bank erosion was increasing downstream from River Falls. Thermal impacts were also suspected.

### **Thermal Impacts**

In response to the concern about thermal pollution, Kiap-TU-Wish established a temperature monitoring network in 1992, at four locations on the Kinnickinnic River (Map 2) and two locations on major tributaries. With funding provided by Kiap-TU-Wish and the Wisconsin Council of Trout Unlimited, Ryan TempMentor® data-logging thermometers were purchased and installed at river locations upstream and downstream from City of River Falls storm water discharges and two local hydropower dams. The data logging thermometers record river temperatures at 10-minute intervals during the April-September period, thereby documenting any thermal impacts associated with storm water runoff during summer rains. Significant thermal impacts have been apparent downstream from River Falls storm water discharges and hydropower dams. Rapid increases in river temperature (up to 10 degrees Fahrenheit) are frequently evident at locations downstream from storm water discharges during summer rainfalls (Figures 1 and 2), and storm water temperatures may exceed 78 degrees Fahrenheit (Figures 3 and 4), the upper lethal limit for brown trout. The thermal impact of the two city hydropower dams produces downstream temperatures that are at least 3-6 degrees Fahrenheit warmer than upstream temperatures during the summer months (Figure 5). Conversely, downstream temperatures are significantly cooler during the winter months, with possible impacts on incubating eggs in the trout redds.

### **Sediment and Nutrient Impacts**

To evaluate the possible impacts of sediment and other urban pollutants in River Falls storm water runoff, storm event-based composite sampling of residential, commercial, and industrial areas of River Falls was conducted in 1992 by Short Elliott Hendrickson (SEH), a local water resources management firm (SEH, 1995). A comparison of River Falls monitoring results to EPA (1983) NURP monitoring results (Table 1) indicates that sediment and nutrients are of particular concern in River Falls storm water runoff, with total suspended solids, total Kjeldahl nitrogen, and total phosphorus concentrations substantially higher than the NURP median concentrations.

### **Using Scientific Assessment Information to Initiate and Support Storm Water Planning and Management Efforts:**

One of the goals of the Kiap-TU-Wish temperature monitoring project was to obtain sound scientific information on the local impacts of storm water runoff. Using this monitoring information, Kiap-TU-Wish initiated a discussion with River Falls planners and policy-makers about the need for storm water management tools that would enable the city to grow while protecting the Kinni.

## **Leveraging the Ideas and Resources of Local Partners:**

### **City of River Falls Storm Water Management Plan**

In 1993, the City of River Falls, through the WDNR, applied for and received federal 205J funding to develop a storm water management plan. Short Elliott Hendrickson (SEH) was selected by the city to prepare the plan, in partnership with Kiap-TU-Wish, local townships, the WDNR, the Kinnickinnic River Land Trust, and the University of Wisconsin-River Falls. The “City of River Falls Water Management Plan for the Kinnickinnic River and Its Tributaries” (Figure 6) was completed in 1994, at a cost of \$115,000, with a portion of the funding provided by the city and Kiap-TU-Wish. The plan, adopted by the River Falls City Council in April 1994, provides a “blueprint” for the city’s storm water management efforts to protect the Kinnickinnic River as the city grows (SEH, 1995).

Shortly after adoption of the storm water management plan, the City of River Falls established a storm water utility to generate funding for storm water management projects that protect and enhance the Kinnickinnic River. The storm water utility charges a fee to city residents and businesses according to the amount of storm water running off a property. As an incentive to residents and businesses that reduce the amount of storm water runoff from their properties, the City of River Falls reduces their annual storm water utility fee proportionately.

In 2002, River Falls adopted a storm water management ordinance (Figure 7). The ordinance, prepared with input from the partners, is another key element of the city’s storm water management plan, and requires all developers to use storm water management practices that entirely infiltrate the first 1.5 inches of runoff from all storm events. Among the options for developers is the low impact development approach, which uses biotechnology (rain gardens, swales, constructed wetlands, and buffers of native vegetation) to distribute and infiltrate storm water across the landscape, rather than concentrating and conveying it to the river with conventional storm water infrastructure (curb and gutter, storm sewers, and detention ponds).

### **Kinnickinnic River Priority Watershed Project**

In 1995, efforts to protect the Kinnickinnic River expanded watershed-wide when the WDNR selected the Kinnickinnic River as a part of the state’s Priority Watershed Program. The Priority Watershed Program provides annual funding, over a ten-year period, for cost-shared projects in both agricultural and urban areas of the watershed that protect and enhance the quality of the Kinnickinnic River. Prior to receiving state funding, however, a watershed plan had to be developed so that the state and local cost-share funding could be appropriately directed to areas of the watershed in greatest need of agricultural and urban best management practices (BMPs). The WDNR worked in partnership with Kiap-TU-Wish, two counties, six townships, three cities (including River Falls), the University of Wisconsin-River Falls, the Kinnickinnic River Land Trust, and SEH to develop the “Nonpoint Source Control Plan for the Kinnickinnic River

Priority Watershed Project” (WDNR, 1999) (Figure 8), which was approved by the Wisconsin Natural Resources Board in April 1999. The plan is unique in that it is among the first priority watershed plans in the state to incorporate an urban storm water management component, applying the approach used in the City of River Falls storm water management plan to other cities and townships across the watershed. A list of eligible agricultural and urban BMPs and associated cost-share rates is presented in Table 2.

### **Local Environmental Education is Important:**

In 1998, recognizing the need for an educational tool that can be used to protect cold-water resources in urbanizing areas, Kiap-TU-Wish, in partnership with Palisade Productions of Minneapolis, MN, produced a video entitled: “A Storm on the Horizon” (Figure 9 and display). Using the Kinnickinnic River as the backdrop, this 15-minute video describes the value of a cold-water resource, discusses the potential threats posed to cold-water resources by urban growth, and also describes some tools available to communities for protecting these resources while accommodating growth. The video won a Silver Screen Award in the “Environmental Issues and Concerns” category at the Chicago International Film Festival in 1999. Kiap-TU-Wish members have distributed nearly 3,000 copies of the video nationwide, to local planners and policy-makers, engineers, scientists, elementary, middle school, high school, and college educators and students, nonprofit organizations, and other Trout Unlimited members and chapters.

### **Translating a Storm Water Plan to Action in River Falls:**

In 2000, the City of River Falls and the River Falls School District took advantage of an opportunity to implement some of the new storm water management techniques described in the city’s storm water management plan. The school district was planning to build a new high school near the South Fork of the Kinnickinnic River, a tributary to the main river. After learning that a preliminary site plan had already been designed for the new high school, several Kiap-TU-Wish members showed “A Storm on the Horizon” to school officials and city planners, and stressed the need for good storm water management practices on the site. Kiap-TU-Wish members, the City of River Falls, SEH, and Kinnickinnic River Priority Watershed Project participants worked with the school district’s landscape architect to redesign the site. A large, expansive parking lot in the original design was changed to smaller, separated lots buffered with native vegetation that infiltrates storm water runoff from these impervious surfaces. Native buffers were also established between the athletic fields, to trap soil and nutrients. Three storm water detention ponds on the site contain and infiltrate excess runoff, including the runoff from the building roof. With funding provided by the Priority Watershed Project, an innovative irrigation system was also installed to pump storm water from the detention ponds to the athletic fields. As originally designed, the new high school site would have cost the River Falls School District \$8,000 per year in storm water utility fees paid to the City of River Falls. With the redesign work, it is anticipated that no storm water will leave the site, saving the school district \$8,000 per year while protecting the South Fork and Kinnickinnic River. With completion of the new high school in the fall of 2001,

Kiap-TU-Wish members and Kinnickinnic River Priority Watershed Project participants plan to help the school district install interpretive signs that explain the various storm water management components of the site. It is hoped that these components can be incorporated into the educational curriculum at the high school. Funding for the signage will also be provided by the Priority Watershed Project.

### **The Benefits of Effective Storm Water Management:**

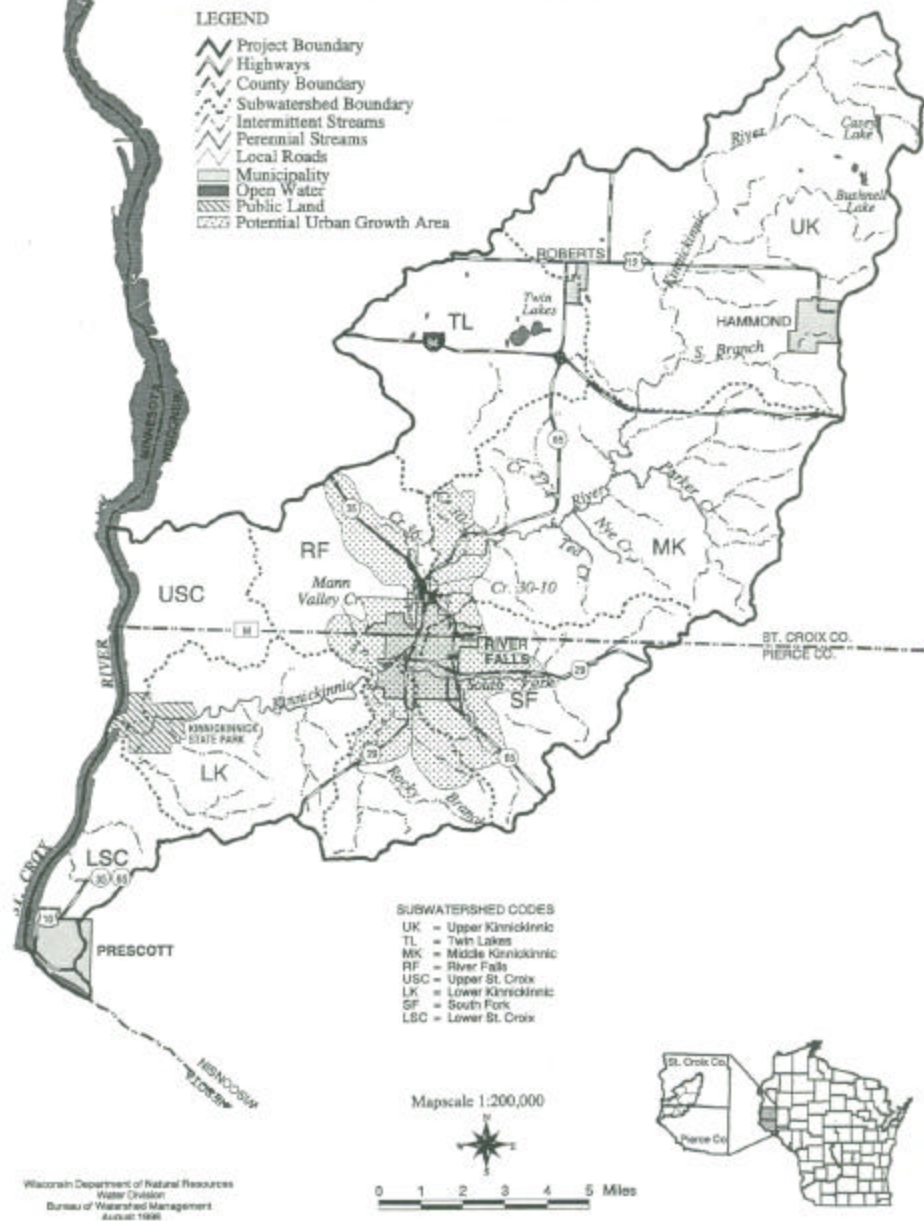
Trout are an important indicator species of environmental quality, especially in an urbanizing area. As such, protection of the Kinnickinnic River is critical to help ensure the environmental, cultural, and economic future of River Falls and surrounding communities. With nearly 200 members, the Kiap-TU-Wish Chapter of Trout Unlimited has been instrumental in protecting the Kinnickinnic River during the past decade. The chapter has raised the awareness of planners, policy-makers, and residents with regard to storm water issues, and has helped to change the way River Falls manages an outstanding cold-water resource in Wisconsin, thereby ensuring that the Kinni will be available for the enjoyment of future generations.

### **For more information, please contact:**

Kent Johnson  
Kiap-TU-Wish Chapter, Trout Unlimited  
P.O. Box 483  
Hudson, WI 54016  
Phone: 715-386-5299  
FAX: 715-386-6065  
E-mail: kentjohnson@presenter.com

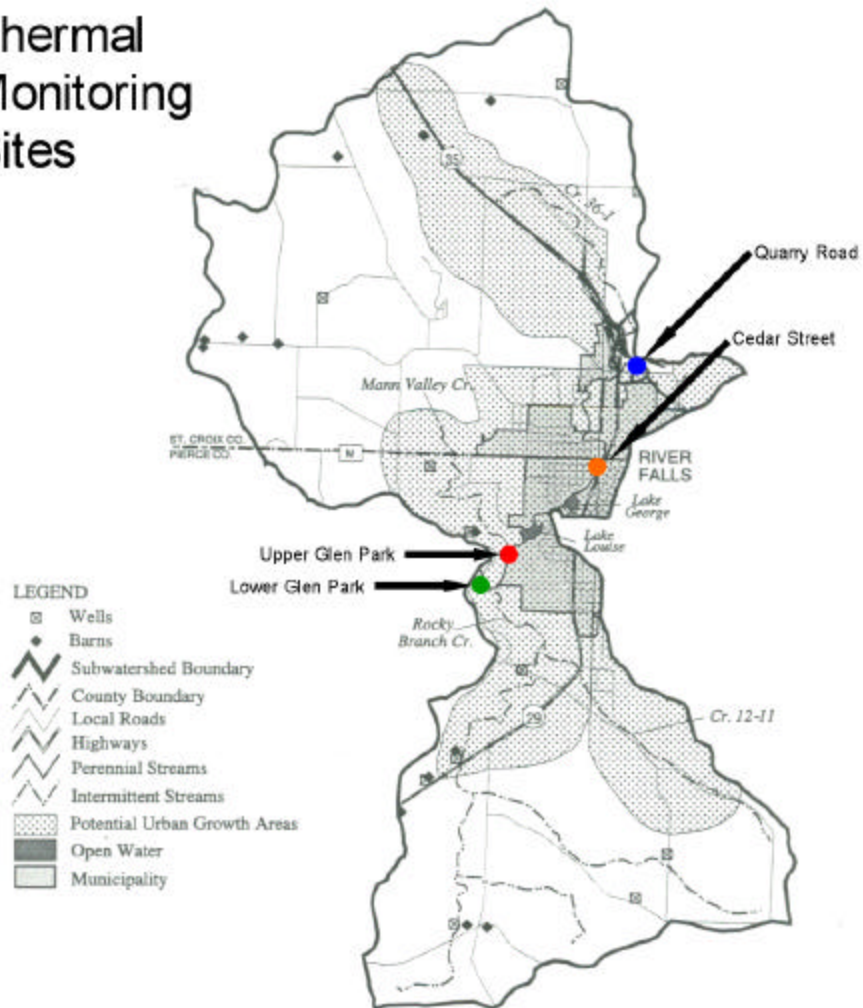
Kiap-TU-Wish Website: <http://www.lambcom.net/kiaptuwish/>

# Map 1 Kinnickinnic River Subwatersheds and Tributaries



## Map 2 River Falls Subwatershed

### Thermal Monitoring Sites



Mapscale 1:63,851



### STUDY AREA



Wisconsin Department of Natural Resources  
Water Division  
Bureau of Watershed Management  
September 1998



## Map 2 Additional Information on the Kinnickinnic River Thermal Monitoring Sites:

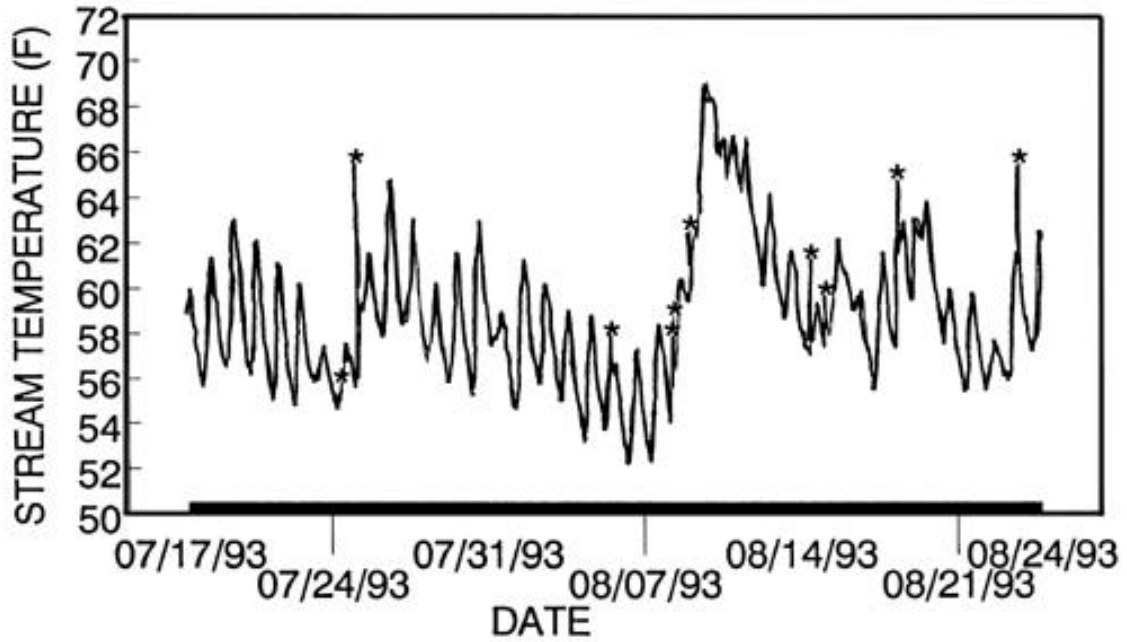
**Quarry Road:** The Quarry Road site is located along Quarry Road in the River Falls Subwatershed, at the upper (NE) River Falls city limit. This upstream location is unaffected by River Falls storm water discharges and the two city hydropower impoundments (Lake George and Lake Louise).

**Cedar Street:** The Cedar Street site is located near the former Cedar Street Bridge in the River Falls Subwatershed. This urban location is immediately downstream from four direct storm water discharges draining residential and commercial areas of River Falls. The site is also immediately upstream from Lake George and Lake Louise.

**Upper Glen Park:** The Upper Glen Park site is located in the upper part of Glen Park in the River Falls Subwatershed. This location is approximately 0.1 mile downstream from a large storm water discharge (Bartosh Canyon) draining a residential area of River Falls. The site is also 0.1 mile downstream from Lake George and Lake Louise.

**Lower Glen Park:** The Lower Glen Park site is located in the lower part of Glen Park in the River Falls Subwatershed, at the lower (WSW) River Falls city limit. This location is approximately 0.9 mile downstream from Bartosh Canyon and the two impoundments. The site is also 0.2 mile downstream from the Rocky Branch tributary.

Figure 1 Cedar Street Thermograph With Storm Water-Induced Temperature Spikes (\*), July-August 1993



Stream Temperature Summary: Average= 58.8 F Minimum= 52.3 F Maximum= 69.1

\*= Rain Event

Figure 2 Cedar Street Thermograph With Storm Water-Induced Temperature Spike July 25, 1993

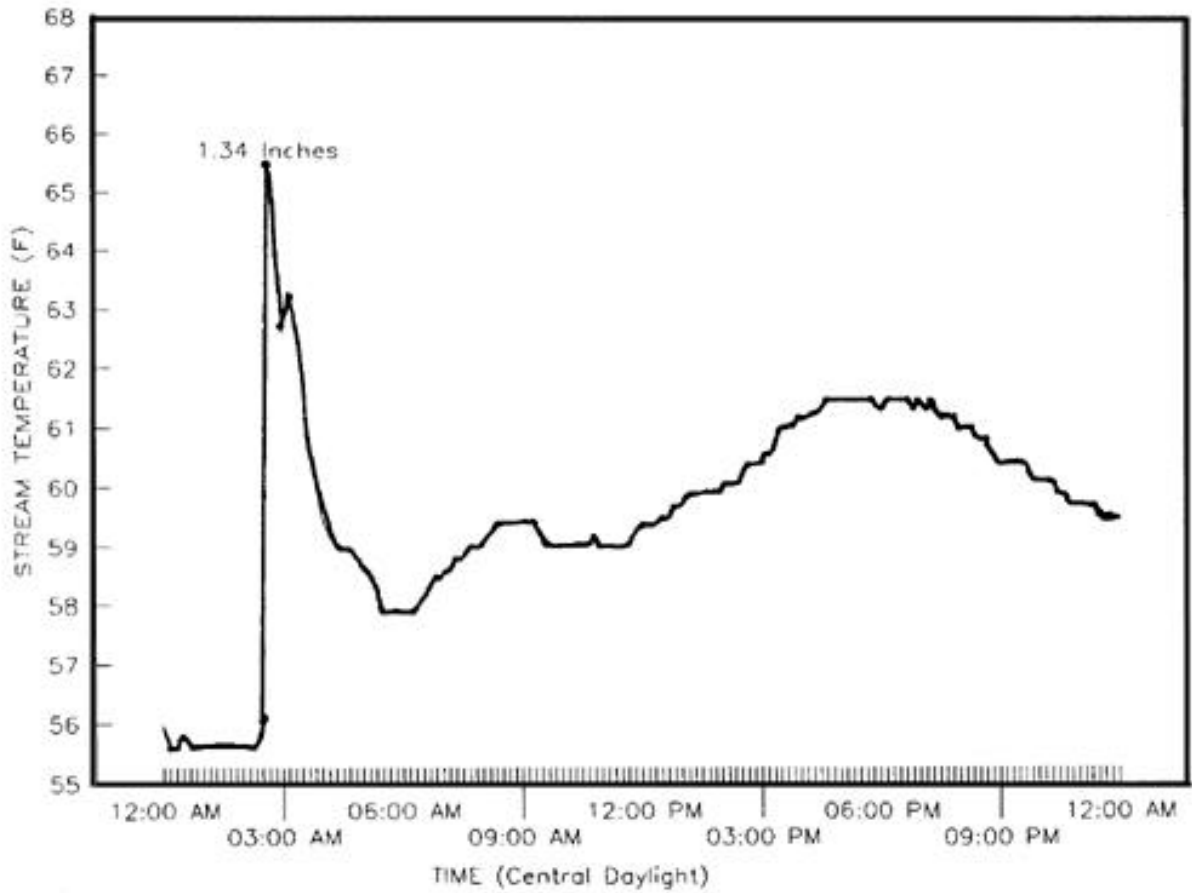
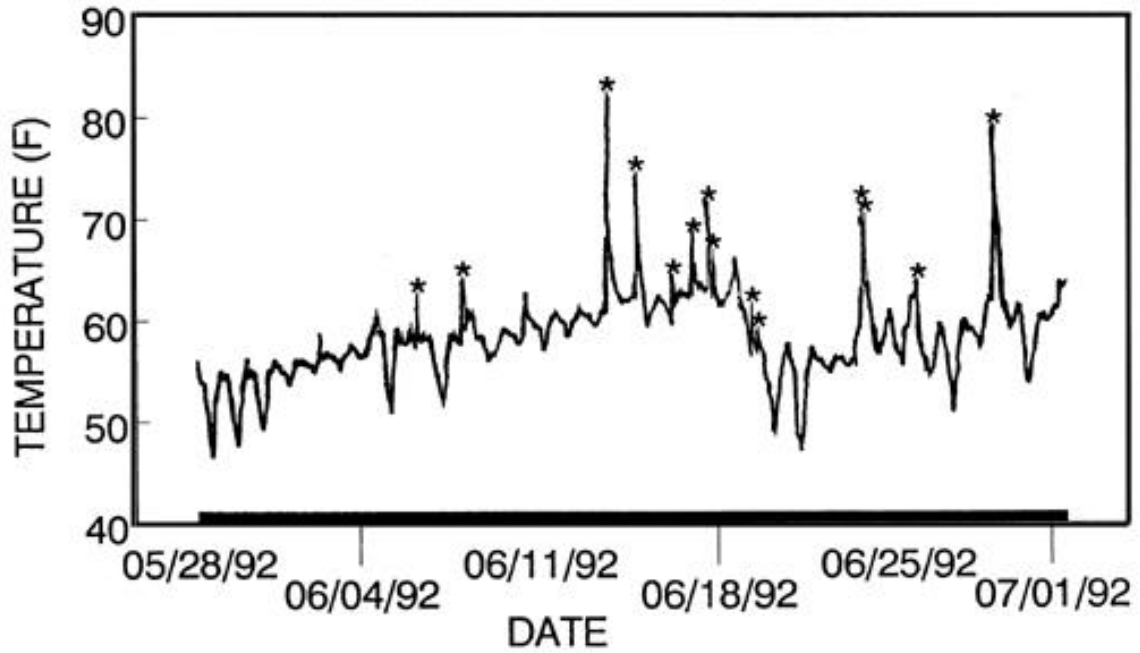


Figure 3 Storm Water Temperatures (\*)  
in a Commercial River Falls Subwatershed,  
June 1992



\*= Rain Event

Figure 4 Storm Water Temperatures During Four Rain Events in a Commercial River Falls Subwatershed, June 1992

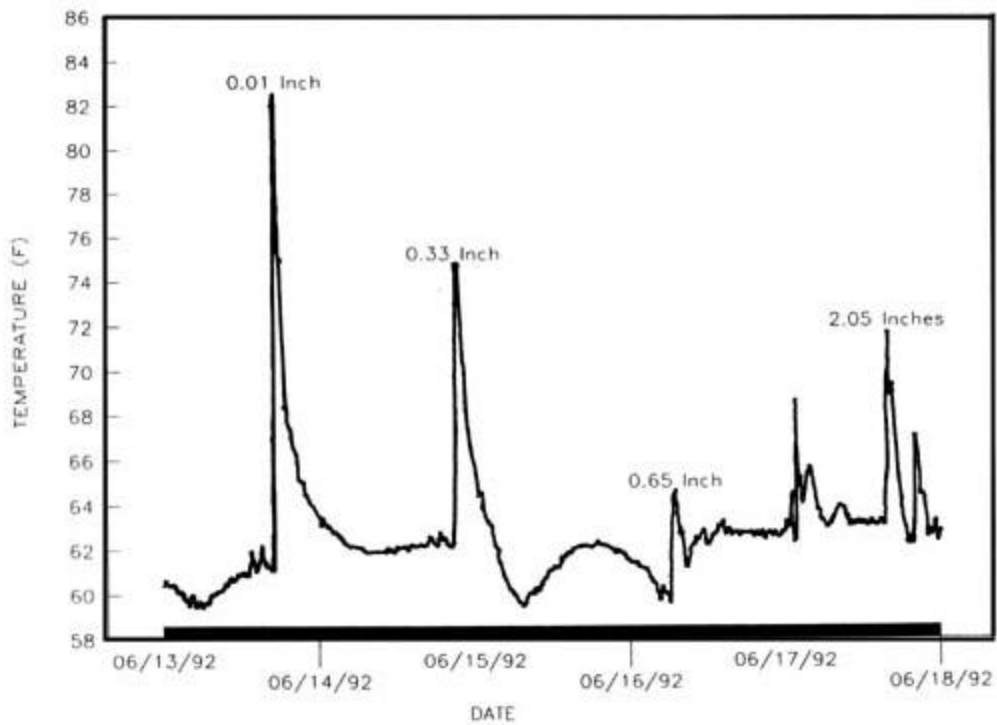
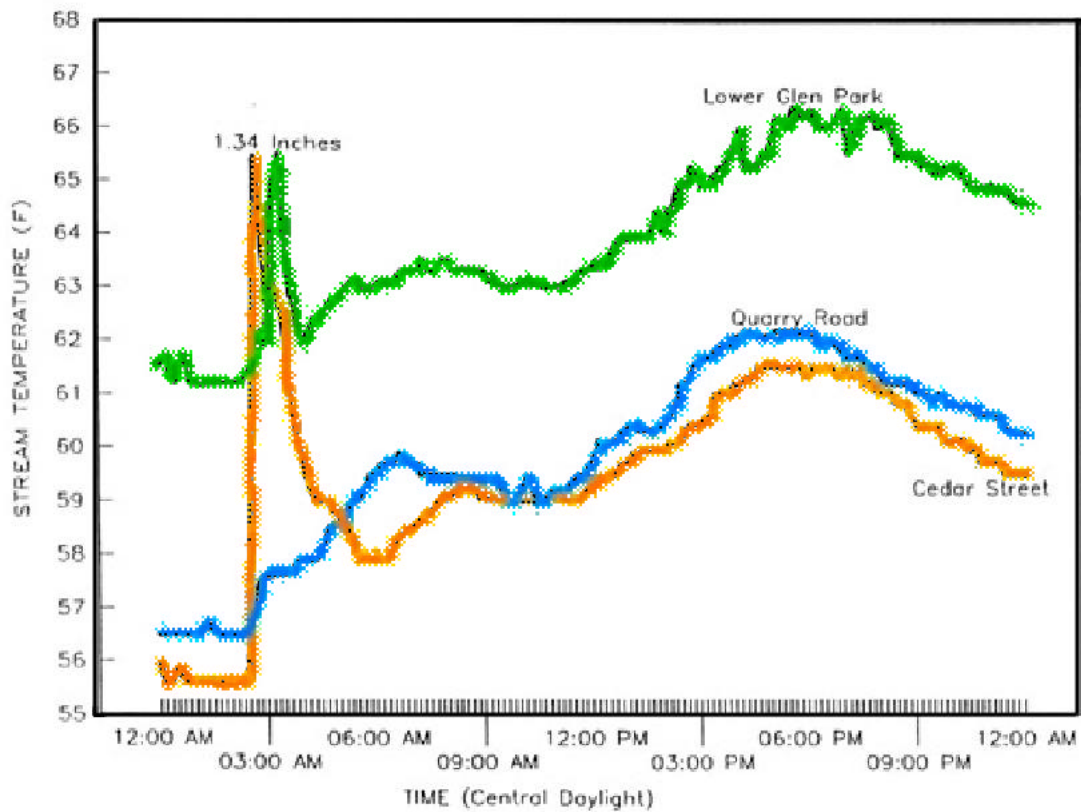


Figure 5 Comparison of Quarry Road, Cedar Street, and Lower Glen Park Thermographs, July 25, 1993



**Table 1 River Falls Storm Water Quality (1992)  
Compared to NURP Monitoring Results**

<b>Residential Subwatershed</b>			<b>Commercial Subwatershed</b>		
<u>Water Quality Variable (mg/l)</u>	<u>River Falls Median</u>	<u>NURP Median</u>	<u>Water Quality Variable (mg/l)</u>	<u>River Falls Median</u>	<u>NURP Median</u>
TSS (Total Suspended Solids)	240.0	101.0	TSS (Total Suspended Solids)	150.0	69.0
TKN (Total Nitrogen)	2.6	1.90	TKN (Total Nitrogen)	2.1	1.20
TP (Total Phosphorus)	0.75	0.38	TP (Total Phosphorus)	0.50	0.20
Cu (Copper)	0.030	0.033	Cu (Copper)	0.030	0.029
Pb (Lead)	0.015	0.144	Pb (Lead)	0.080	0.104
Zn (Zinc)	0.110	0.135	Zn (Zinc)	0.190	0.226
<b>Industrial Subwatershed</b>			<b>All Subwatersheds</b>		
<u>Water Quality Variable (mg/l)</u>	<u>River Falls Median</u>		<u>Water Quality Variable (mg/l)</u>	<u>River Falls Median</u>	<u>NURP Median</u>
TSS (Total Suspended Solids)	250.0		TSS (Total Suspended Solids)	200.0	100.0
TKN (Total Nitrogen)	2.5		TKN (Total Nitrogen)	2.6	1.50
TP (Total Phosphorus)	0.50		TP (Total Phosphorus)	0.50	0.38
Cu (Copper)	0.030		Cu (Copper)	0.030	0.034
Pb (Lead)	0.050		Pb (Lead)	0.050	0.140*
Zn (Zinc)	0.210		Zn (Zinc)	0.140	0.160
These data represent only one storm event. No NURP data are available for direct comparison			*NURP monitoring was completed prior to the decrease in leaded gasoline use.		

Figure 6

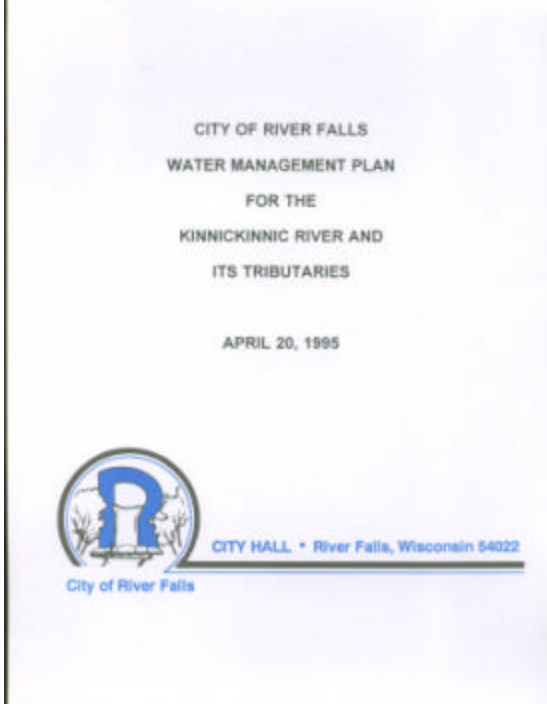


Figure 7

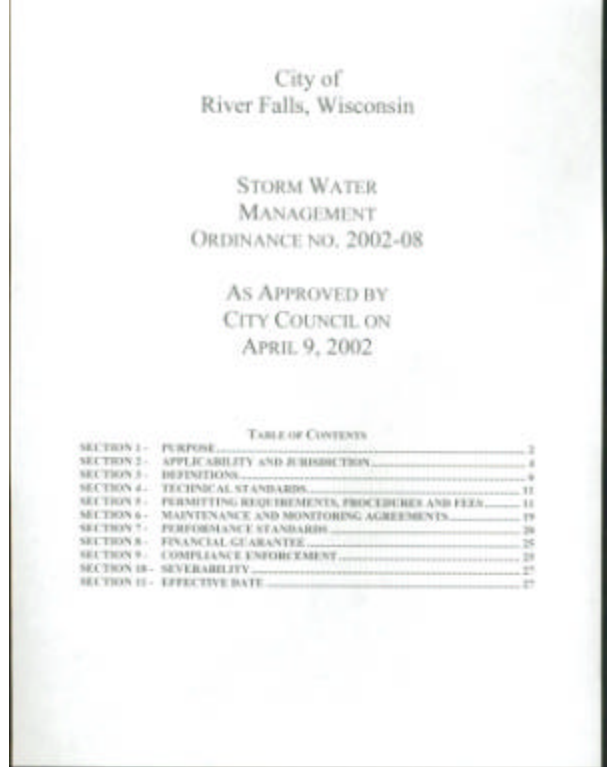
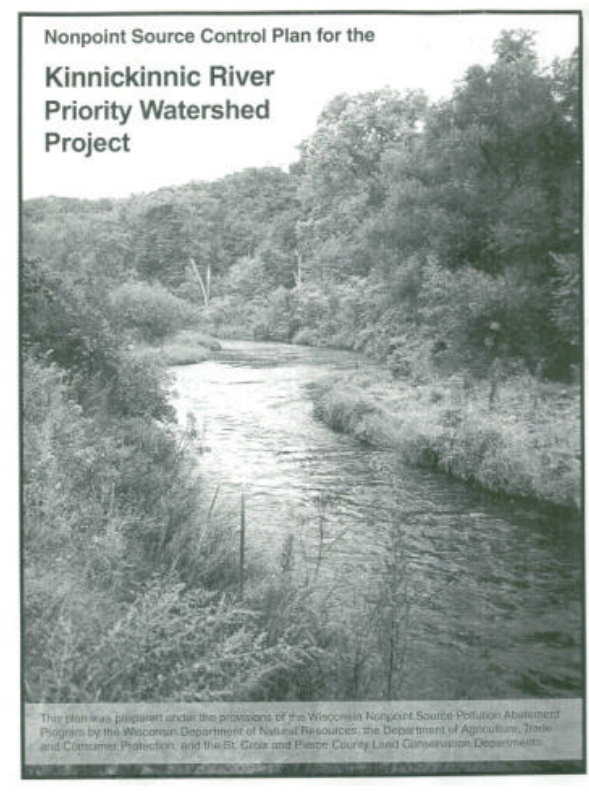


Figure 8





**Table 2. Eligible Cost-Shared Agricultural and Urban BMPs**

**Agricultural BMPs**

<b>BEST MANAGEMENT PRACTICE</b>	<b>STATE COST-SHARE RATE</b>
Nutrient and Pesticide Management	50%
Pesticide Handling Spill Control Basins	70%
Livestock Exclusion from Woodlots	50%
Intensive Grazing Management	50%
Manure Storage Facilities	70% and 50%
Manure Storage Facility Abandonment	70%
Field Diversions and Terraces	70%
Grassed Waterways	70%
Critical Area Stabilization	70%
Grade Stabilization Structures	70%
Agricultural Sediment Basins	70%
Shoreline and Streambank Stabilization	70%
Shoreline Buffers	70%
Wetland Restoration	70%
Barnyard Runoff Management	70%
Barnyard Abandonment or Relocation	70%
Roofs for Barnyard Runoff Management and Manure Storage Facilities	70%
Milking Center Waste Control	70%
Cattle Mounds	70%
Land Acquisition	70%
Lake Sediment Treatment	70%
Well Abandonment	70%

**Urban BMPs**

<b>BEST MANAGEMENT PRACTICE</b>	<b>STATE COST-SHARE RATE</b>
Critical Area Stabilization	70%
Grade Stabilization Structures	70%
Streambank Stabilization	70%
Shoreline Buffers	70%
Wetland Restoration	70%
Structural Urban Practices	70%
High Efficiency Street Sweeping	50%, 5 years only

Figure 9

## A Storm on the Horizon



### **A 1999 Chicago International Film Festival Silver Award Winner Category: Environmental Issues and Concerns**

The purpose of the video is to educate the public about the effects of storm water on our lakes, streams and rivers. This educational video discusses the issues surrounding urban development and its impact on water quality. The story of the Kinnickinnic River in western Wisconsin is told, and the prospect for the river's long-term health is discussed. The video is a must see for anyone interested in land use issues and the health of our water resources. The video:

1. Establishes the value of a cold water resource and its importance to the community.
2. Demonstrates the impact of storm water on water resources.
3. Outlines what can be done to enable development to occur while protecting water resources.

Professionally produced by Kiap-TU-Wish and Palisade Productions of Minneapolis, MN, the video is 15 minutes in length and is geared toward educating the general public, land use planners, and decision makers about the impacts of storm water on our water resources.

The video is available for a donation of \$15, which includes shipping and handling. To receive the video, please contact us at:

Kent Johnson or Andy Lamberson  
Kiap-TU-Wish Chapter of Trout Unlimited  
P.O. Box 483  
Hudson, WI 54016  
Or e-mail us at [lamberson@attbi.com](mailto:lamberson@attbi.com)

## References:

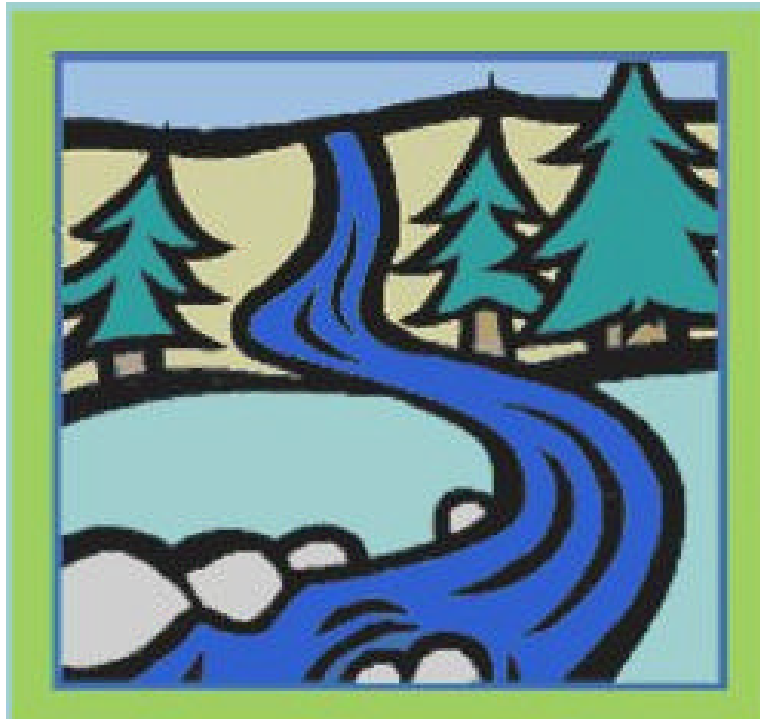
Ayres and Associates. 1987. *River Falls Master Plan Report: A Policy Guide for Growth*.

EPA. 1983. *Results of the Nationwide Urban Runoff Program: Volume 1. Final Report*. U.S. Environmental Protection Agency, Washington, D.C. 197 p.

Schueler. 1994. *The Importance of Imperviousness*. In: *Watershed Protection Techniques 1 (3)*: 100-111. Center for Watershed Protection, Silver Spring, MD.

SEH. 1995. *City of River Falls Water Management Plan for the Kinnickinnic River and its Tributaries*. Short Elliott Hendrickson, St. Paul, MN. 286 p.

WDNR. 1999. *Nonpoint Source Control Plan for the Kinnickinnic River Priority Watershed Project*. Wisconsin Department of Natural Resources, Bureau of Water Resources Management, Madison, WI. 279 p.



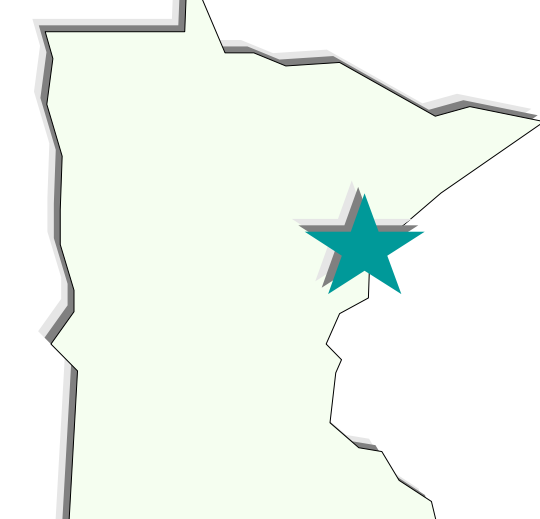
# Duluth Streams: Community partnerships for understanding urban stormwater and water quality issues at the head of the Great Lakes

Marion Lonsdale<sup>1</sup>, Richard Axler<sup>2</sup>, Cynthia Hagley<sup>3</sup>, George Host<sup>2</sup>, Carl Richards<sup>3</sup>, and Bruce Munson<sup>3</sup>

<sup>1</sup> Duluth Public Works and Utilities, Duluth, MN; <sup>2</sup> Natural Resources Research Institute, U. Minnesota-Duluth; <sup>3</sup> Minnesota Sea Grant, U. Minnesota-Duluth



## BACKGROUND



### Setting

- 42 named streams; one of the highest densities of stream corridors in any US metro area
- Urban and rural development impact these streams by increasing water volume, temperature, suspended sediments, road salts, organic matter and nutrients

### Partnership

- City, UMD researchers, education and outreach professionals, local resource agencies and other educational institutions

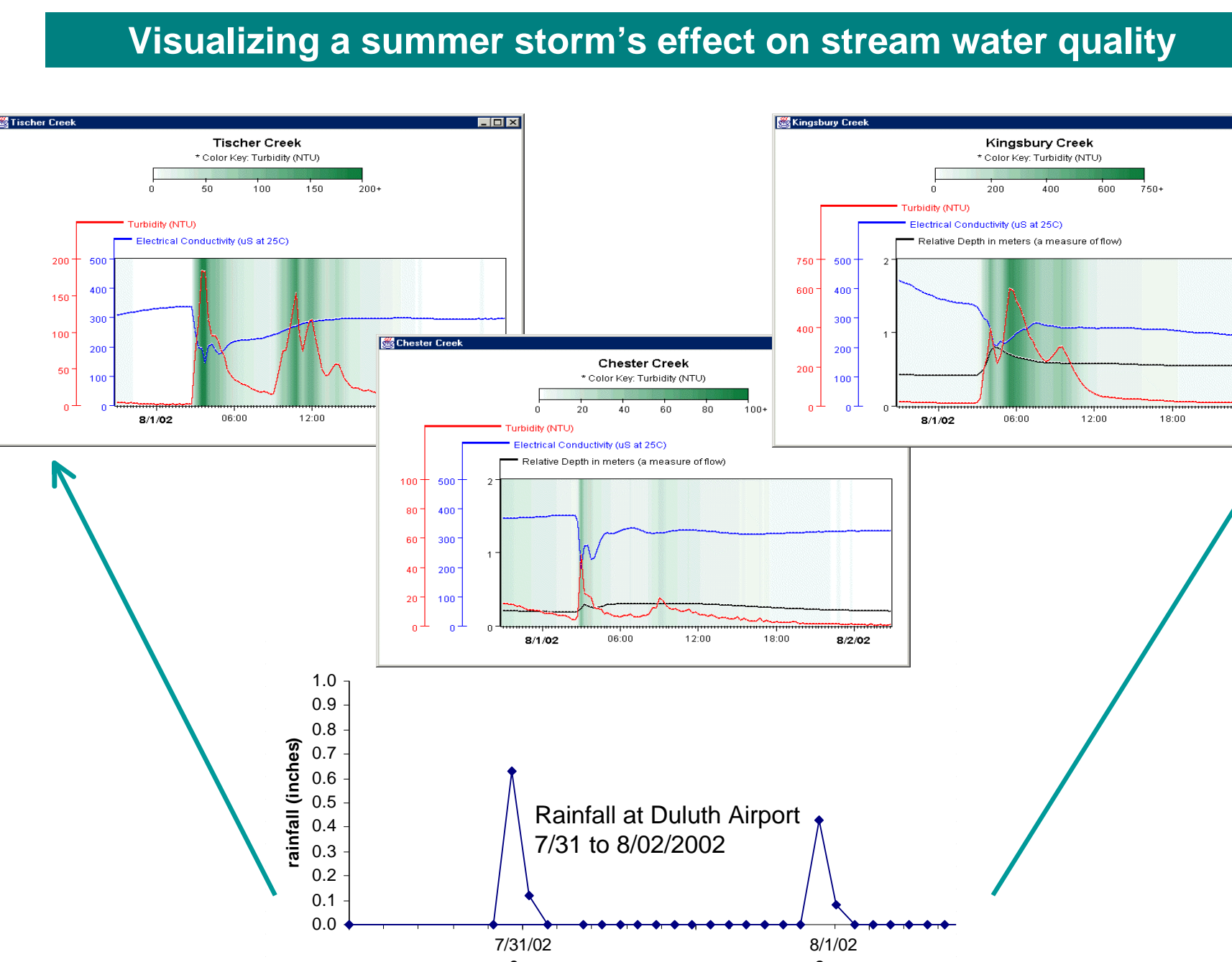
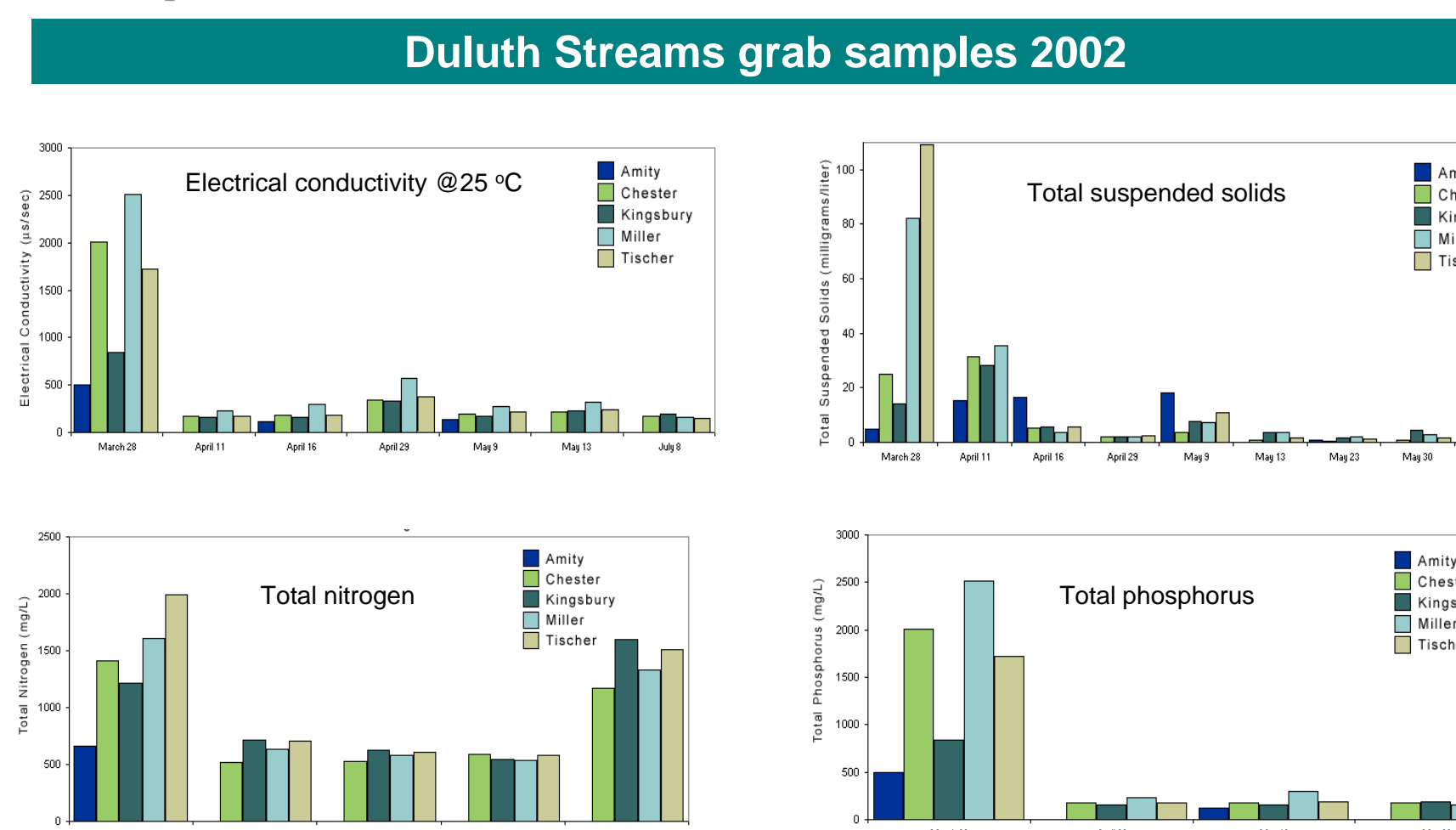
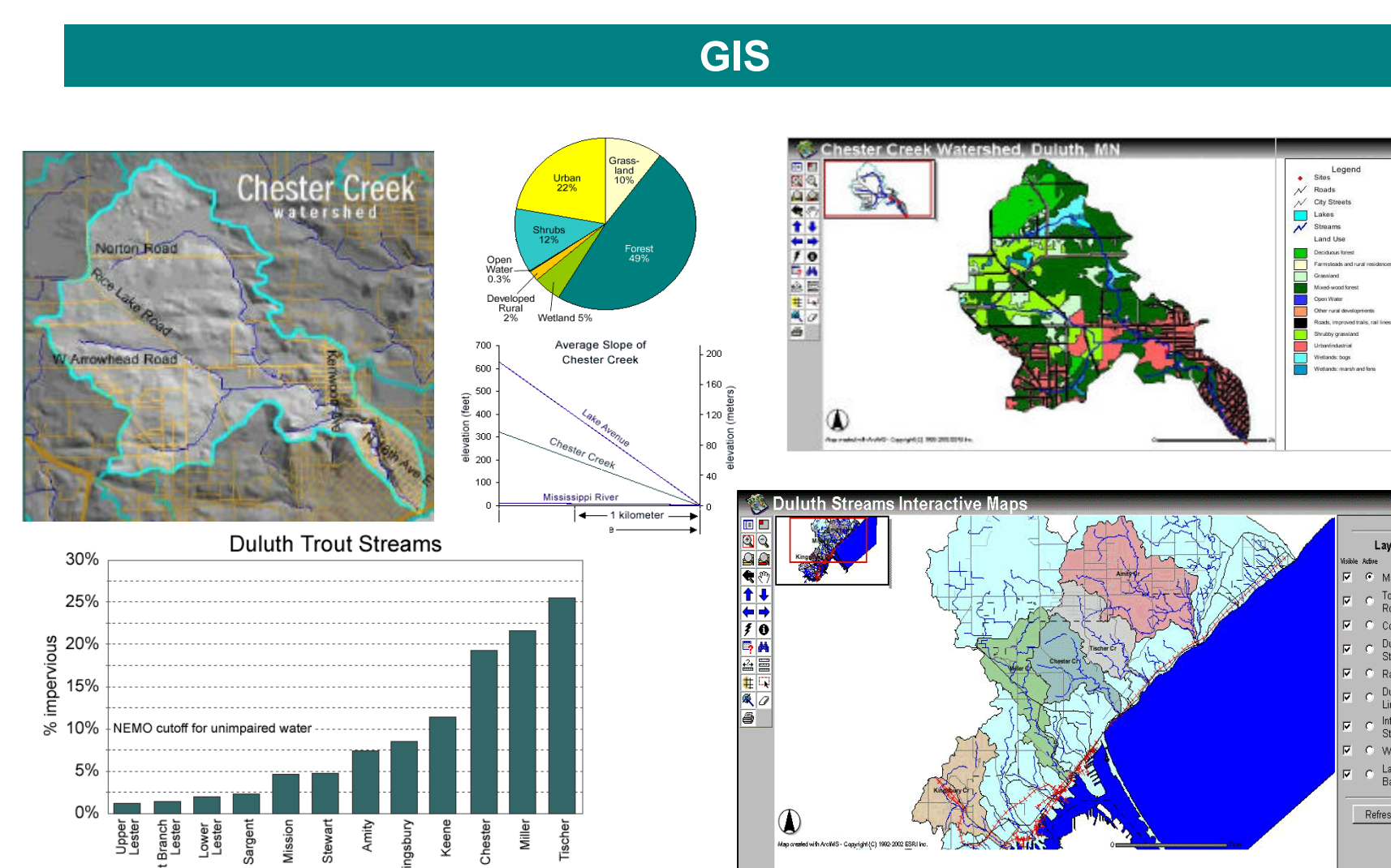
### Chief Goal

- Enhance public understanding of aquatic ecosystems and their connections to watershed land use to provide both economic and environmental sustainability.

### Objectives

1. Link real-time remote water quality sensing in 4 urban streams and GIS technology to current and historic WQ and biological databases using advanced data visualization tools in a website and information kiosks;
2. Incorporate visually engaging interpretive text, animations and videos into the website to illustrate the nature and consequences of degraded stormwater and the real costs to society;
3. Engage the public in the stormwater issue to facilitate development and implementation of the Duluth Stormwater Management Plan by:
  - Establishing high school stewardship of 3 streams
  - Adapting the Nonpoint Education for Municipal Officials (NEMO) program to the greater Duluth Metropolitan Area
  - Developing high school and college curricula
  - Hosting a Duluth Streams congress as a community forum for presenting all project results

## DATA



## WEBSITE



- Principal investigators, staff and collaborators**
- **Duluth Utility Operations Stormwater Utility**  
Marnie Lonsdale, Jerry Walker, Todd Carlson, Richard Bunton
  - **NRRI-UMD**  
Rich Axler, George Host, Jerry Henneke, Jane Reed, Elaine Ruzycy, Norm Will, Gerry Sjerven
  - **MN Sea Grant-UM**  
Carl Richards, Cindy Hagley, Bruce Munson, Jesse Schomberg
  - **MN Extension Service** – Nate Meyer
  - **MN Pollution Control Agency** – Jesse Anderson
  - **Western Lake Superior Sanitary District** – Keith Anderson, Mike Guite
  - **Lake Superior Zoo** – Mike Janis
  - **Great Lakes Aquarium**



# Maximum Utility for Minimum Cost: Simple Structural Methods for Stormwater Quality Improvement

T. J. Mullen  
President, Best Management Products, Inc.

## Abstract

Stormwater runoff is characterized by the United States Environmental Protection Agency as “one of the greatest remaining sources of water pollution” in America (United States Environmental Protection Agency, November 1999). Thus, efforts to implement stormwater quality improvement regulations are accelerating across the United States, compelling municipalities and land developers to maximize the usefulness of stormwater infrastructure as never before. With simple modifications to current designs, common catch basins and other stormwater structures can be more effectively utilized as pollution control devices, rather than merely as a way to move stormwater. Future systems must drain runoff which cannot be infiltrated to areas where it can be appropriately managed, and simultaneously, reduce the environmental impact of the ultimate discharge to the receiving waters. Adding a deep sump to catch basins, a common feature in some areas of the country, has been shown to remove some sediments and gross particles. As an additional benefit, these structures allow the use of an outlet hood or baffle, which can drastically reduce the discharge of floatable debris and trash, and aid in the removal of free oil and grease. This “cleaner” runoff can also extend the service life of a traditional stormwater detention facility, such as a pond, or a retention facility, such as a groundwater recharge area. This paper addresses a group of low-cost components which comprise the SNOUT<sup>®</sup> Stormwater Quality Control System, manufactured by Best Management Products, Inc. (BMP, Inc.) The applications include a deep sump catch basin with an outlet hood, a structure with an outlet hood and flow restrictor, structures configured to bypass high flows, and outlet controls which can accommodate extreme flow conditions while retaining captured pollutants.

## Background

Catch basins, stormwater inlets, and other specialized structures have a long history of use as part of municipal separate storm sewer systems (MS4s) in controlling stormwater runoff. So too have the many devices used with them to aid in the removal of pollutants, such as grates, traps, hoods, and sumps. With the aid of new appurtenances based on older concepts, these simple structures are being more effectively used and maintained as a first line of defense against non-point source pollution in urbanized areas to improve stormwater quality.

In its simplest form, a stormwater inlet's primary function is to intercept sheet flows in order to prevent the accumulation of stormwater in an area where flooding could impede traffic or pedestrians, cause property damage, or otherwise present a nuisance. However, these inlets to MS4s or combined sewer systems (CSSs) are often the entry point of pollutants from diffuse sources found in stormwater runoff. As a result, pollution is often discharged untreated, directly into our surface waters.

The use of deep sumped structures, as part of the stormwater system along with simple components essentially creates numerous "micro-detention" nodes throughout a stormwater conveyance, and allows moderate levels of pollutants to be captured in an economical manner. Typically, this method requires much lower on-going maintenance needs than traditional "tray-type" catch basin inserts or baskets, and a significantly lower capital cost than most "end-of-pipe" controls. Further, the ability of sufficiently sumped structures to intercept gross-pollutants and finer particles such as suspended solids (SS) has been well documented. A recent study in New Jersey found an average SS capture rate of 32 percent over several storm events (Pitt and Field, 1998).

Capture of trash, floatables and other gross-pollutants have also been widely recognized as a benefit of an inlet with a hood. A 1995 study of New York City catch basins compared the relative effectiveness of structures with and without hoods. The hooded structures captured 85 percent of the litter that entered the combined sewer inlets compared to 30 percent for the catch basins without hoods (New York City Department of Environmental Protection, 1995, cited in EPA Doc. 832-F99-008 September 1999). The nation's first Total Maximum Daily Load (TMDL) for trash, being established for the Los Angeles River Basin, calls for reductions in gross-pollutant loading. Other areas of the country are expected to follow this lead (Will Shuck, Long Beach Press-Telegram, 2001).

Until recently, the devices available for use as hoods or traps were mainly limited to metal hoods, metal or PVC elbows, and tees. While many of these devices have been in service for decades, little design effort was given to these appurtenances in terms of pollutant removal performance, hydraulic efficiency, or ease of installation. That situation has changed with a versatile product line available from Best Management Products, Inc. of Lyme, CT. Relative to the traditional hoods or fittings, which lack an oil-proof gasket or an anti-siphon vent, the new design transforms the hood concept into a higher performance, multi-task stormwater quality and quantity control system. This system, the SNOUT<sup>®</sup> Stormwater Quality Control System (US Patent # 6126817), uses vented plastic-composite hoods and related components to improve water quality and control flow quantity.

### *System Advantages*

- SNOUT<sup>®</sup> hoods use an oil tight gasket sealing system around perimeter of unit.
- Anti-siphon vent prevents pollutants from being drawn downstream in full flows.
- Watertight access port allows easy pipe inspection and maintenance.
- Light Weight/High Strength composite construction is durable and easy to install.
- Sizes to fit over outlet pipes up to 96" outside diameter.
- Highly flexible low-cost component system with a variety of accessories including Flow Restrictors, Oil Absorbents, Flow Deflectors, and Odor Filters.
- SNOUT<sup>®</sup> components can be used to construct a wide variety of stormwater quality structures including those with high flow bypass, swirl chambers, and outlet flow control.
- Use of sumps and SNOUT<sup>®</sup> hoods keeps pipes cleaner, thus reducing pipe maintenance.

Since this system became commercially available in 1999, more than 7,000 SNOUT<sup>®</sup> hoods have been installed. Initial results have been quite favorable. SNOUT<sup>®</sup> systems have been or will be installed as part of research or monitoring projects in the following locations:

Washington, D.C., Navy Yard, Center for Low Impact Development  
Bryn Mawr, PA, Regional Stormwater Facility, Yerkes Associates, Designer  
Harvey's Lake Demonstration Project, Harvey's Lake, PA, PA DEP and Princeton Hydro, LLC

Data collected from these and other projects will be incorporated on an on-going basis on the BMP, Inc. website at [www.bmpinc.com](http://www.bmpinc.com), along with selected case studies and photos from a variety of projects.

## Applications

A variety of applications and SNOUT<sup>®</sup> system configurations exist in the field. Each has its advantages and disadvantages, which are outlined below. These systems include:

*Catch Basin with an Outlet Hood-* This is the most basic application. This system combines a sumped catch basin with a hood. It is useful for capturing trash and floatables, and modest levels of free oils, and sediment. These structures can be inlet-only, or in-line with other structures. To increase oil retention, oil absorbent booms can be placed in the structure. This application has limitations based primarily on the volume and sump depth of the structure itself. To minimize re-suspension of finer captured solids, a deep sump, with a minimum depth of 4 feet, or a depth equal to 3X the outlet pipe inside diameter is recommended. (see Figure 1)

*In-line Catch Basin with a Hood and Flow Restrictor-* This application is useful for limiting the discharge rates down stream. A micro-detention node can be created using a flow restrictor, making use of the storage volume in pipes upstream or ponding areas above the inlet. It is also used in outlet structures in detention basins. Discharge rates can be accurately controlled by slot or orifice dimensions in the riser pipe shielded inside a SNOUT<sup>®</sup> hood, making it difficult to clog with floating debris. The structure must receive periodic maintenance to ensure that sediment accumulation does not reach entrance to riser pipe. is designed to provide absolute flow control. A caution to the designer is that this in-line application does not provide for overflow other than that which can flow over the open top of the riser pipe. For installations where occasional flooding cannot be tolerated, the design shown in Figure 5, *Outlet Structure with Overflow*, should be used. (see Figure 2)

*Structures in Series with Oil Absorbent is and Flow Deflector Plates-* This application is intended for use as a terminal structure on a site where higher than normal pollutant loads may be present. Stormwater makes a "multiple pass" through deep sump structures with hoods and accessories. Accessories include oil absorbent booms for increased oil retention, and deflector plates for increased solids removal. This application is also an excellent pre-treatment design prior to discharge to a conventional stormwater BMP. Limitations are based primarily on structure sizes, whereby larger structures with deeper sumps will yield better removals. (see Figure 3)

*Bypass Structure Configuration-* This design combines the features of structures in series, but allows for high flows to be bypassed from the primary treatment structures. All stormwater receives some treatment however, as the terminal structure contains a large SNOUT<sup>®</sup> hood and a deep sump. Limitations are primarily that multiple structures must be utilized to perform the

bypass, but they can be configured in a wide variety of ways such that hydraulic grade lines are maintained. (see Figure 4)

*Outlet Structure with Overflow-* This design combines accurate outlet control with the SNOUT<sup>®</sup> flow restrictor as well as an overflow mode that maintains capture of floatable pollutants and trash. Limitations may be based primarily on the outlet structure size, as to accommodate large flows, large size SNOUT<sup>®</sup> hoods must be used which require large structures that can be costly to build. (see Figure 5)

Cost Savings Note: Structures for all SNOUT<sup>®</sup> systems are non-proprietary and obtained locally from pre-casters or built in place by local contactors. SNOUT<sup>®</sup> components and designs are low-cost, but are protected by a US Patent with international patents pending. The combination of low-cost components in non-proprietary structures can reduce overall installed systems costs dramatically.

Following are application drawings of the systems mentioned above:



Figure 1- Catch Basin with Hood

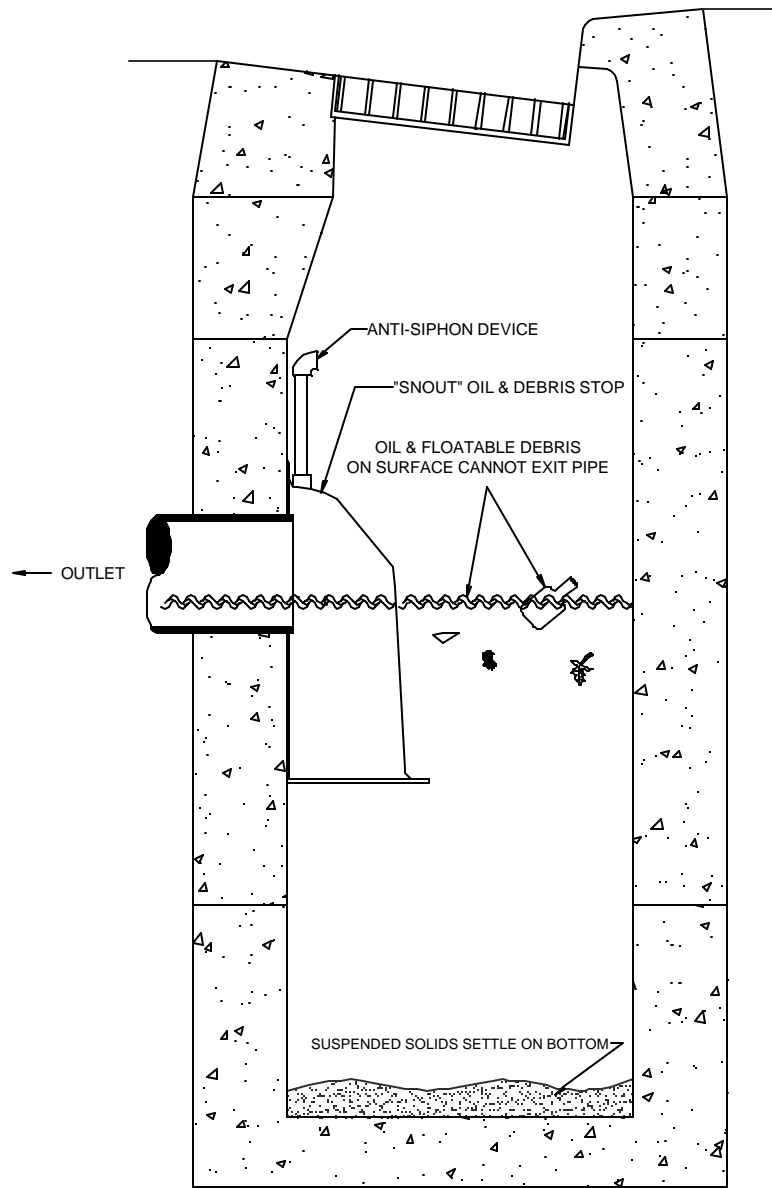
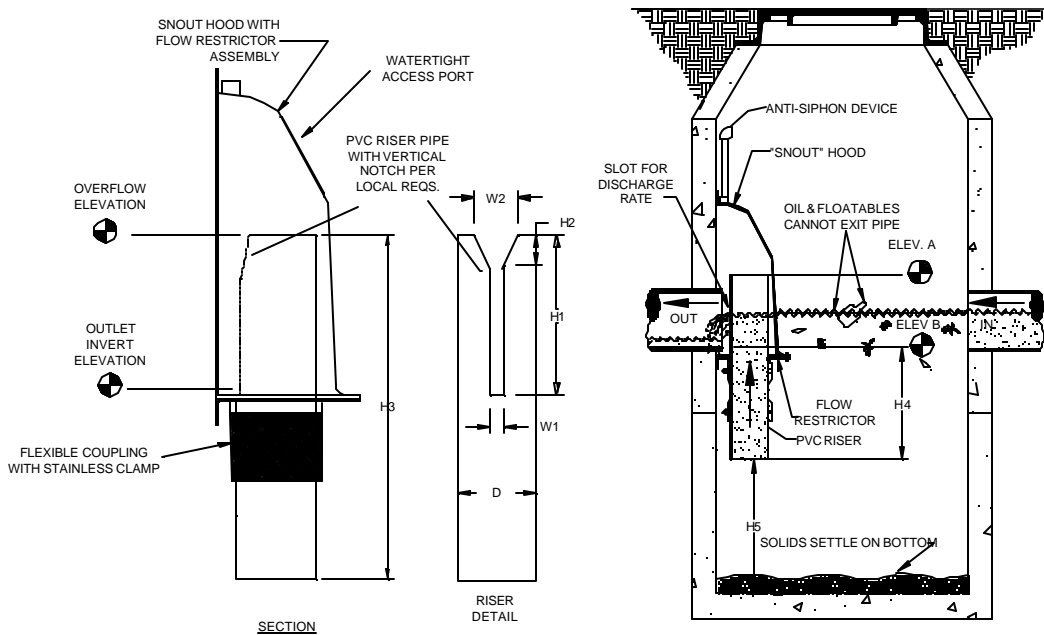


Figure 2- In-line Catch Basin with Hood and Flow Restrictor



DIMENSION REQUIREMENTS

- ⊕ ELEVATION A: \_\_\_\_\_ (OVERFLOW)
- ⊕ ELEVATION B: \_\_\_\_\_ (OUTLET INVERT)

RISER DIMENSIONS

- D= RISER ID: \_\_\_\_\_
- W1= SLOT WIDTH: \_\_\_\_\_
- W2= NOTCH WIDTH: \_\_\_\_\_
- H1= SLOT LENGTH: \_\_\_\_\_
- H2= NOTCH LENGTH: \_\_\_\_\_
- H3= RISER LENGTH: \_\_\_\_\_
- H4= SUBMERGE DEPTH: \_\_\_\_\_ (MIN. 18")
- H5= DEPTH TO BOTTOM: \_\_\_\_\_ (MIN. 24")

HOOD SIZE DETERMINED BY MANUFACTURER  
BASED ON RISER DIAMETER.

ADDITIONAL SKIRT PIECES AVAILABLE TO  
INCREASE HEIGHT OF HOOD.

Figure 3- Structures in Series with Oil Absorbents and Deflector Plates

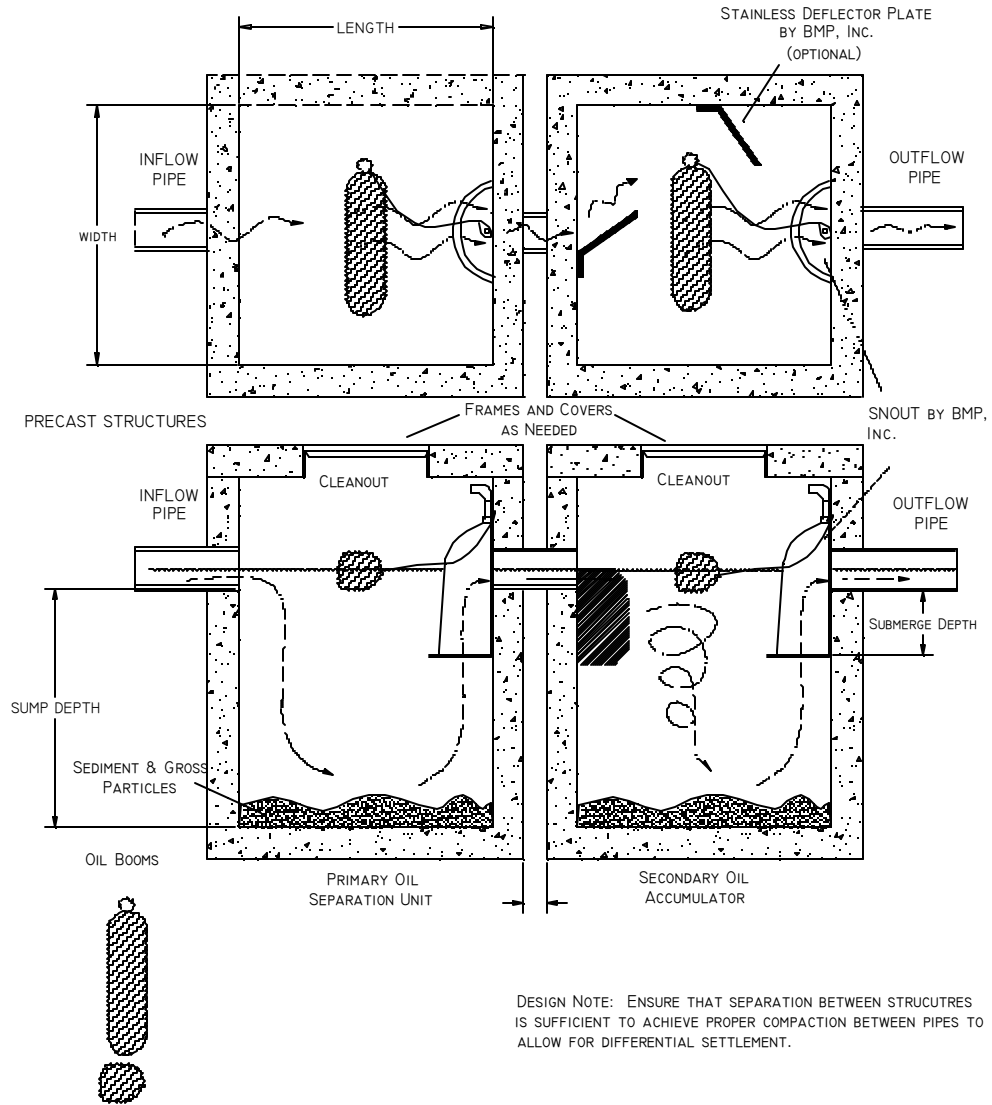


Figure 4- Bypass Structure Configuration

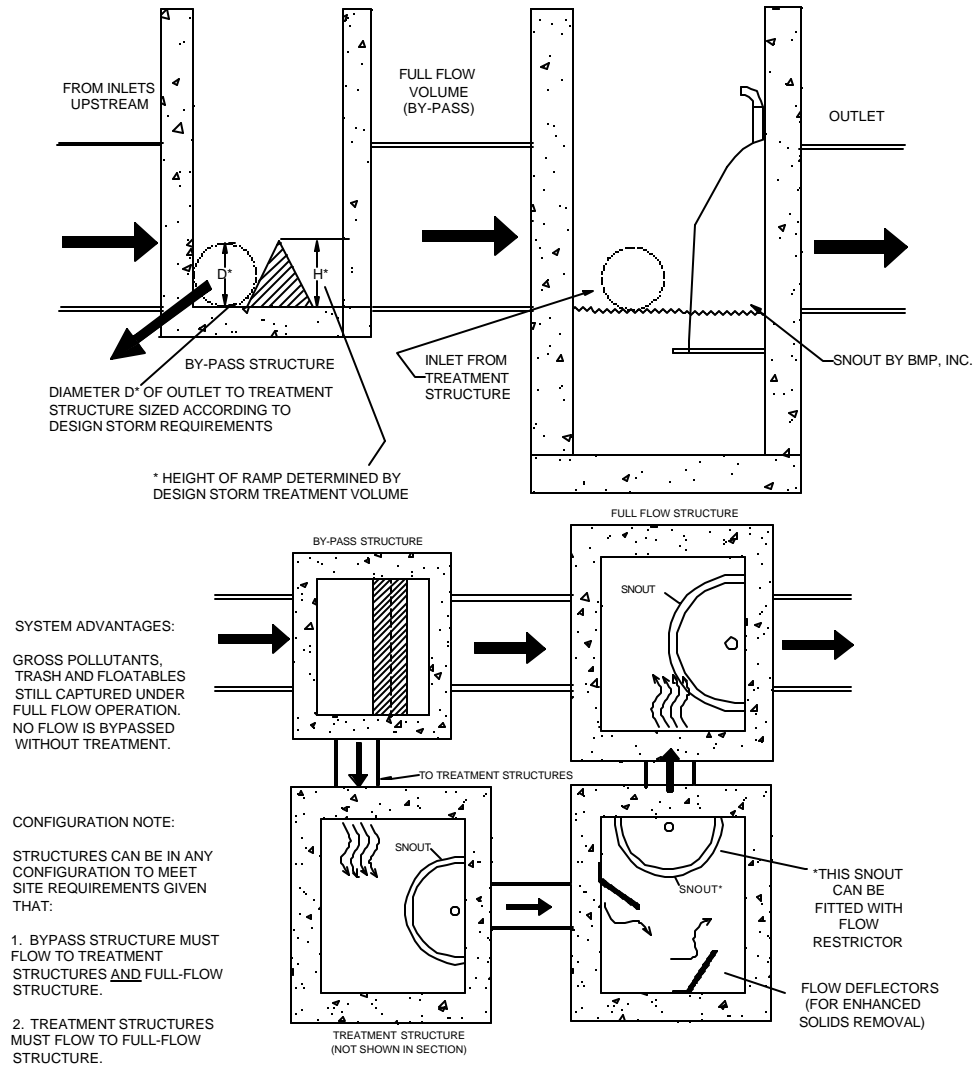
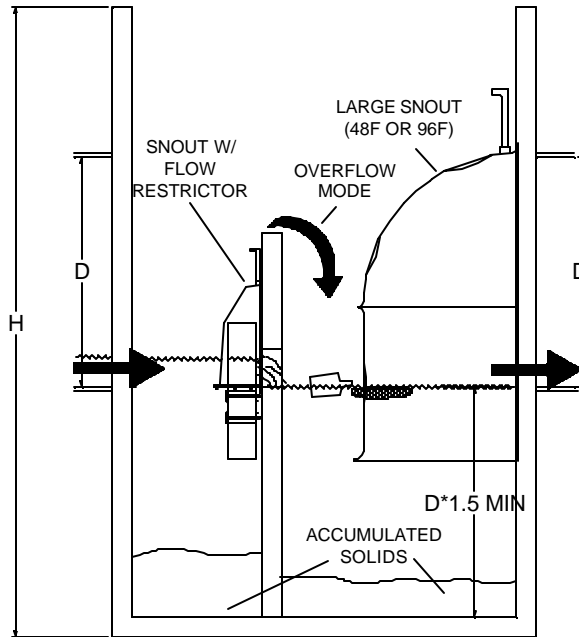


Figure 5- Outlet Structure with Overflow

SYSTEM ADVANTAGES:

FLOW DISCHARGE RATE ACCURATELY CONTROLLED WITHOUT CLOGGING WITH SNOUT FLOW RESTRICTOR

OVERFLOW MODE STILL CONTAINS FLOATING POLLUTANTS

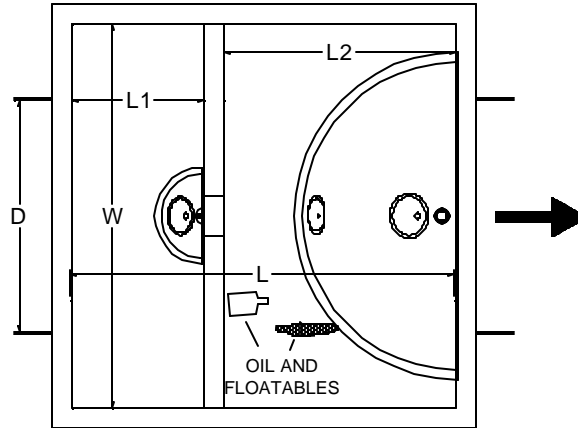


INFLOW FROM POND OR STORMWATER DETENTION FACILITY



DIMENSIONS:

D= PIPE DIAMETER  
 H= HEIGHT OVER ALL  
 L= LENGTH INSIDE  
 L1= LENGTH TO PARTITION  
 L2= LENGTH TO BACK WALL  
 W= WIDTH INSIDE



## Design and Maintenance Considerations

The SNOUT<sup>®</sup> system from BMP, Inc. is based on a vented hood that can reduce floatable trash and debris, free oils, and other solids from stormwater discharges. In its most basic application, a SNOUT<sup>®</sup> hood is installed over the outlet pipe of a catch basin or other stormwater quality structure which incorporates a deep sump. The SNOUT<sup>®</sup> forms a baffle in the structure which collects floatables and free oils on the surface of the captured stormwater, while permitting heavier solids to sink to the bottom of the sump. The clarified intermediate layer is forced out of the structure through the open bottom of the SNOUT<sup>®</sup> by displacement from incoming flow. The resultant discharge contains considerably less unsightly trash and other gross pollutants, and can also offer modest reductions of free-oils and finer solids.

As with any structural stormwater quality Best Management Practice, design and maintenance considerations will have a dramatic impact on SNOUT<sup>®</sup> system performance over the life of the facility. The most important factor to consider when designing structures which will incorporate a SNOUT<sup>®</sup> is the depth of the sump (the sump is defined as the depth from beneath the invert of the outlet pipe to the bottom of the structure). Simply put, the deeper the sump, the more effective the unit will be in terms of removing pollutants, preventing resuspension, and reducing frequency of maintenance. More volume in a structure means more quiescence, thus allowing the pollutant constituents a better chance to separate out. Secondly, more volume means fewer cycles between maintenance operations, because the structure has a greater capacity.

### Design Notes:

- As a rule of thumb, BMP, Inc. recommends *minimum* sump depths based on outlet pipe inside diameters of 2.5 to 3 times the outlet pipe size.
- Special Note for Smaller Pipes: A minimum sump depth of 36 inches for all pipe sizes 12 inches ID or less, and 48 inches for pipe 15-18 inches ID is required if collection of finer solids is desired.
- The plan dimension of the structure should optimally be 6 to 7 times the flow area of the outlet pipe.

### Example Calculation:

*A SNOUT<sup>®</sup> equipped structure with a 15 inch ID outlet pipe (1.23 sqft. flow area) will offer an optimal combination of cost-effectiveness and pollution removal with a minimum plan area of 7.4 sqft. and minimum 48 inch sump. Thus, a readily available 48 inch diameter manhole-type structure, or a rectangular structure of 2 feet x 4 feet will offer sufficient size when combined with a sump depth of 48 inches or greater.*

Therefore, it follows that larger pipe sizes will require larger structures and/or deeper sumps to maintain optimal effectiveness.

As for long term structural maintenance practices, BMP, Inc. recommends the following:

- Monthly monitoring for the first year of a new installation after the site has been stabilized.
- Measurements of sediment depth and observations of floating pollution should be taken after each rain event of .5 inches or more, or monthly, as determined by local weather conditions.
- Checking sediment depth and noting the surface pollutants in the structure will be helpful in planning maintenance. The pollutants collected in SNOUT<sup>®</sup> equipped structures will consist of floatable debris and oils on the surface of the captured water, and grit and sediment on the bottom of the structure.
- It is best to schedule maintenance based on the solids collected in the sump. To achieve a reasonable compromise between practicality and pollution removal effectiveness, the structure should be cleaned when the sump is half full (e.g. when 2 feet of material collects in a 4 foot sump, clean it out). The more often it is cleaned, the better the performance will be as the structure will maintain a greater "effective volume." Of course, depending on resources available for maintenance, some performance may have to be sacrificed due to budgetary constraints.
- Structures should also be cleaned if a spill or other incident causes a larger than normal accumulation of pollutants in a structure.
- Maintenance is best done with a vacuum truck.
- If oil absorbent hydrophobic booms are being used in the structure to enhance hydrocarbon capture and removals, they should be checked on a monthly basis, and serviced or replaced when more than 2/3 of the boom is submerged, indicating a nearly saturated state.
- All collected wastes must be handled and disposed of according to local environmental requirements.
- To maintain the SNOUT<sup>®</sup> hoods themselves, an annual inspection of the anti-siphon vent and access hatch are recommended. A simple flushing of the vent, or gentle rodding with a flexible wire are all that's typically needed to maintain the anti-siphon properties. Opening and closing the access hatch once a year assists a lifetime of trouble-free service.

Further structural design guidelines, maintenance recommendations and site inspection field report sheets are available from BMP, Inc. Please contact us if we can offer further assistance.

### **Summary**

Municipal engineers and stormwater designers are grappling to adapt a pollution control function to traditional drainage systems, recognizing that fundamental changes in traditional stormwater infrastructure design will be required. Presently, the primary function of most MS4s are to evacuate stormwater from point A to point B as quickly and efficiently as possible, often with minimal regard of the impact to receiving waters. As such, compliance with the stormwater quality regulations that are being promulgated across the United States could be difficult for impacted municipalities. Fortunately, implementation of simple design changes, and low-cost technologies, such as those manufactured by Best Management Products, Inc., can make complying with new regulations mandating reductions in the discharge of trash, floatable debris, oil and grease, and sediment easier. Updated structure designs are particularly easy to implement for new construction. In areas where catch basins already have sumps, installing an outlet hood is quick work which can yield substantial benefits. Retrofits to systems without sumped structures,

especially at strategic nodes, are still cost-effective as they make the existing conveyance systems more efficient, and can extend the service life of traditional stormwater facilities. While the work remaining to improve our stormwater infrastructure is daunting, the benefits of reducing pollutants from stormwater runoff will be numerous. Benefits include improved surface water quality, reduced impacts to wildlife habitat, and a healthier environment for recreation and enjoyment of our natural resources.

## References

Pitt, Robert and Field, Richard. "An Evaluation of Storm Drainage Inlet Devices for Stormwater Quality Treatment." The University of Alabama at Birmingham, Department of Civil and Environmental Engineering, United States Environmental Protection Agency, Wet Weather Flow Research Program, pp. 3-4, 1998.

United States Environmental Protection Agency., Environmental News, "EPA expands controls on polluted runoff to further protect Nation's drinking water and waterways." R-134, p. 1, November, 1999.

HydroQual, Inc., "City-Wide Floatables Study." New York City Department of Environmental Protection, Bureau of Environmental Engineering, Division of Water Quality Improvement. As cited in "CSO Technology Fact Sheet, Floatables Control". United States Environmental Protection Agency, Washington, D. C. Document EPA 832-F99-008, p. 5, September 1999.

Shuck, W., "Waterway trash limits considered", Long Beach Press-Telegram, p. A3, Nov. 29, 2000.

SNOUT® is a registered trademark of Best Management Products, Inc.

53 Mt. Archer Rd., Lyme, CT 06371

Phone: 800-504-8008 Fax: 860-434-3195 Web Site: [www.bmpinc.com](http://www.bmpinc.com)

The SNOUT® is protected by US Patent # 6126817, international patents pending.