

Assessing Arsenic Removal by Metal (Hydr)Oxide Adsorptive Media Using Rapid Small Scale Column Tests

by

Paul K. Westerhoff and Troy M. Benn

**Arizona State University
Tempe, Arizona 85287-5306**

and

**Abraham S.C. Chen
Lili Wang
Lydia J. Cumming**

**Battelle
Columbus, OH 43201-2693**

**Contract No. 68-C-00-185
Task Order No. 0025**

for

**Thomas J. Sorg
Task Order Manager**

**Water Supply and Water Resources Division
National Risk Management Research Laboratory
Cincinnati, OH 45268**

**National Risk Management Research Laboratory
Office of Research and Development
U.S. Environmental Protection Agency
Cincinnati, OH 45268**

DISCLAIMER

The work reported in this document is funded by the United States Environmental Protection Agency (EPA) under Task Order (TO) No. 0025 of Contract No. 68-C-00-185 to Battelle. It has been subjected to the Agency's peer and administrative reviews and has been approved for publication as an EPA document. Any opinions expressed in this paper are those of the author(s) and do not, necessarily, reflect the office positions and policies of the EPA. Any mention of products or trade names does not constitute recommendation for use by the EPA.

FOREWORD

The U.S. Environmental Protection Agency (EPA) is charged by Congress with protecting the Nation's land, air, and water resources. Under a mandate of national environmental laws, the Agency strives to formulate and implement actions leading to a compatible balance between human activities and the ability of natural systems to support and nurture life. To meet this mandate, EPA's research program is providing data and technical support for solving environmental problems today and building a science knowledge base necessary to manage our ecological resources wisely, understand how pollutants affect our health, and prevent or reduce environmental risks in the future.

The National Risk Management Research Laboratory (NRMRL) is the Agency's center for investigation of technological and management approaches for preventing and reducing risks from pollution that threaten human health and the environment. The focus of the Laboratory's research program is on methods and their cost-effectiveness for prevention and control of pollution to air, land, water, and subsurface resources; protection of water quality in public water systems; remediation of contaminated sites, sediments and ground water; prevention and control of indoor air pollution; and restoration of ecosystems. NRMRL collaborates with both public and private sector partners to foster technologies that reduce the cost of compliance and to anticipate emerging problems. NRMRL's research provides solutions to environmental problems by: developing and promoting technologies that protect and improve the environment; advancing scientific and engineering information to support regulatory and policy decisions; and providing the technical support and information transfer to ensure implementation of environmental regulations and strategies at the national, state, and community levels.

This publication has been produced as part of the Laboratory's strategic long-term research plan. It is published and made available by EPA's Office of Research and Development to assist the user community and to link researchers with their clients.

Sally Gutierrez, Director
National Risk Management Research Laboratory

ABSTRACT

The lowering of the maximum contaminant level (MCL) for arsenic in drinking water from 50 to 10 $\mu\text{g/L}$ has posed significant technical and financial challenges to water treatment facilities throughout the nation. To assist small water systems (<10,000 customers) in meeting the new standard, U.S. Environmental Protection Agency (EPA) announced in October 2001 an initiative, i.e., the Arsenic Rule Implementation Research Program, to conduct, among others, a series of full-scale, on-site demonstrations of arsenic removal technologies, process modifications, and engineering approaches applicable to small systems. Of the 40 project sites under the Round 1 and Round 2 demonstration program, 23 selected adsorptive media technology because of its ease of operation.

The conventional way of selecting adsorptive media has been based on the results of long-term pilot-plant studies. To reduce time required and save cost, it was desirable to develop new or utilize existing rapid, small-scale methods to evaluate media performance. Preliminary studies have been recently conducted using a rapid small-scale column test (RSSCT) method that was originally developed for evaluating the performance of granular activated carbon. The results of these studies have shown that the RSSCT method, which usually requires only three to four weeks of testing, has the potential to predict the performance of full-scale systems. If proven to be true, this method would provide the water industry with a lower cost alternative to develop performance data necessary for full-scale system design.

Battelle was contracted by EPA to evaluate the usefulness of this short-term predictive method. Side-by-side tests were conducted using RSSCTs and pilot/full-scale systems either in the field or in the laboratory. The test locations included six EPA arsenic removal technology demonstration sites and one EPA pilot-scale test site. For each location, RSSCTs were conducted using at least three parallel test columns packed with different adsorptive media to compare arsenic breakthrough of the small-scale columns to the pilot/full-scale systems.

A total of eight commercially available, NSF International (NSF)-certified adsorptive media were tested, including three iron oxide-based media (i.e., E33, ARM 200, and KemIron), one iron hydroxide-based media (i.e., granular ferric hydroxide or GFH), one iron modified activated alumina (i.e., AAFS50), two titania-based media (i.e., MetsorbG and AdSorbsia granular titania oxide [GTO]), and one hybrid ion exchange resin (HIX)-based media (i.e., ArsenX^{np}). Virgin media were crushed and sieved to obtain the 100 \times 140 mesh fraction, which was packed in 1.1 cm \times 30.5 cm glass columns. The amount of media packed into each column was determined through the use of proportional diffusivity scaling equations (see Equations 1.1 and 1.2 in Table 1-1). The columns were thoroughly backwashed to remove media fines and entrained air before use.

Of the media tested, full-scale performance data were available for direct comparison for AAFS50, E33, GFH, and ArsenX^{np}. RSSCTs proved to be a reasonably reliable approach for comparing media run lengths and adsorptive capacities for arsenate (As[V]), but over-predicted the capacities to remove arsenite (As[III]). Key operational parameters, including reduced Reynolds-Schmidt product (ReSc) values and empty bed contact time (EBCT), were evaluated to minimize the run time and volume of water required to conduct RSSCTs. Under the conditions tested for most media, an ReSc value of 2,000 appeared to be appropriate for RSSCT column design. A reduced ReSc value of 1,000 was needed for titania-based media to cope with operational difficulties related to excessive pressure buildup, bed compaction (up to 50%), and media disintegration. RSSCT columns scaled to a reduced full-scale EBCT of 2.5 to 3.0 min could produce similar results as those scaled to the whole-length full-scale EBCTs.

Water quality at each test site varied and, consequently, the ability to remove arsenic by a given media also varied. Arsenic occurred as As(V) at concentrations of 21.5 to 61 $\mu\text{g/L}$ in five of the seven source

waters tested and pH values were between 7.2 and 7.7. The two source waters containing As(III) had pH values of 8.1 and 8.5 and As(III) concentrations of 64 and 22.5 µg/L. (One site utilized a solid-phase oxidizing media to convert the As(III) into As(V) and RSSCTs were conducted to study both As(V) and As(III) removal.) All the waters contained arsenic plus at least one other important element of interest, such as uranium, antimony, vanadium, silica, and/or phosphate. Arsenic adsorption capacities across the different source waters and different media tested, based on reaching an RSSCT effluent concentration of 10 µg/L, ranged from 0.05 to 2.0 mg As/g of dry media. The influent pH value as well as the presence of silica, vanadium, phosphate, and/or calcium all appeared to impact the relative performance of media on different source waters. By conducting side-by-side RSSCTs, significant differences were observed among the media to remove arsenic and these co-occurring elements.

CONTENTS

DISCLAIMER	ii
FOREWORD	iii
ABSTRACT.....	iv
FIGURES	vii
TABLES	viii
ACRONYMS AND ABBREVIATIONS	ix
ACKNOWLEDGEMENTS.....	xii
1.0 INTRODUCTION	
1.1 Background.....	1
1.1.1 Arsenic Interaction with Metal (Hydr)Oxide Surfaces.....	1
1.1.2 Mass Transport of Ions in Porous Adsorptive Media.....	3
1.1.3 Rapid Small Scale Column Tests for Arsenic Removal by Porous Adsorbents.....	3
1.2 Objectives	5
1.3 Report Organization	5
2.0 SUMMARY AND CONCLUSIONS	
3.0 MATERIALS AND METHODS	
3.1 RSSCT Apparatus.....	9
3.2 Preparation of RSSCT Adsorptive Media	9
3.3 Preparation of RSSCT Columns.....	9
3.4 RSSCT Field Setup.....	14
3.5 RSSCT Laboratory Setup	14
3.6 Sampling and Analyses	16
4.0 RESULTS AND DISCUSSION.....	
4.1 Source Water Quality	19
4.2 Valley Vista, AZ (Site1).....	19
4.2.1 Field RSSCTs (Site 1F)	19
4.2.2 Laboratory RSSCTs (Site 1L)	21
4.2.3 Comparison of Field/Laboratory RSSCT and Full-Scale System Results.....	24
4.3 Rimrock, AZ (Site 2).....	24
4.3.1 Arsenic Removal	24
4.3.2 Removal of Other Elements	26
4.4 Licking Valley High School in Newark, OH (Site 3).....	26
4.4.1 Comparison of As(III) Removal by RSSCT and Pilot-Scale Columns	26
4.4.2 Removal of Other Elements	28
4.5 Village of Lyman in NE (Site 4).....	28
4.5.1 Arsenic Removal	30
4.5.2 Uranium Removal.....	30
4.5.3 Removal of Other Elements	30
4.6 Upper Bodfish in Lake Isabella, CA (Site 5).....	30
4.6.1 Arsenic Removal	33
4.6.2 Uranium Removal.....	33
4.7 South Truckee Meadows General Improvement District (STMGID) in Washoe County, NV (Site 6).....	36
4.7.1 Arsenic Removal	36
4.7.2 Antimony Removal.....	38

4.7.3	Removal of Other Elements	39
4.8	Spring Brook Mobile Home Park in Wales, ME (Site7)	41
4.8.1	Arsenic Removal	41
4.8.2	Removal of Other Elements	43
4.9	Media Adsorptive Capacity for Arsenic	46
4.10	Comparison of Arsenic Removal for Different Source Waters	46
5.0	REFERENCES	49

FIGURES

Figure 1-1.	Arsenate (As[V]) and Arsenite (As[III]) Speciation.....	2
Figure 3-1.	Illustration of Stand-Alone RSSCT Apparatus Dimensions (upper) and Layout with Column and Pump (lower).....	10
Figure 3-2.	Schematic (upper) and Photograph (lower) of Typical Packed Columns.....	11
Figure 3-3.	Photographs of Water Delivery System (Including Inlet Piping, Fiber Glass Filter Cartridge [top] and Five-Port Manifold [bottom]) for Licking Valley High School RSSCT Columns.....	15
Figure 3-4.	Photograph of RSSCT System and Sampling Points at Spring Brook Mobile Home Park in Wales, ME.....	16
Figure 3-5.	Schematic Arrangement for RSSCT System and Sampling Points	17
Figure 4-1.	As Breakthrough Curves from Field RSSCT Columns at Valley Vista, AZ.....	21
Figure 4-2.	Breakthrough of V, P, Si, and Al from Field RSSCT Columns at Valley Vista, AZ	22
Figure 4-3.	As Breakthrough Curves from Valley Vista, AZ Laboratory RSSCT Columns	23
Figure 4-4.	Comparison of Field and Laboratory RSSCT Results for Valley Vista, AZ.....	23
Figure 4-5.	Comparison of Field/Laboratory RSSCTs with Full-Scale AAFS50 System at Valley Vista, AZ.....	24
Figure 4-6.	As Breakthrough Curves from Laboratory RSSCT Columns and Full-Scale E33 System at Rimrock, AZ	25
Figure 4-7.	Breakthrough of V, P, Si, and Al from Rimrock, AZ Laboratory RSSCT Columns.....	27
Figure 4-8.	Comparison of RSSCT and Pilot Results at Licking Valley High School in Newark, OH.....	28
Figure 4-9.	Breakthrough of P, Si, Fe, and Al from Field RSSCT Columns at Licking Valley High School in Newark, OH.....	29
Figure 4-10.	Arsenic Breakthrough Curves from Lyman, NE Laboratory RSSCT Columns	31
Figure 4-11.	Comparison of Two ReSc Values on Lyman, NE Titania-Based Media RSSCTs.....	31
Figure 4-12.	Breakthrough of U, V, Fe, and Mn from Lyman, NE Laboratory RSSCT Columns	32
Figure 4-13.	Arsenic Breakthrough Curves from Upper Bodfish, CA Laboratory RSSCT Columns	34
Figure 4-14.	Comparison of Two ReSc Values on Upper Bodfish, CA Titania-Based Media RSSCTs.....	34
Figure 4-15.	Uranium Breakthrough from Upper Bodfish, CA Laboratory RSSCT Columns	35
Figure 4-16.	Comparison of Two ReSc Values on Upper Bodfish, CA Titania-Based Media RSSCTs.....	35
Figure 4-17.	Arsenic Breakthrough Curves from STMGID, NV Laboratory RSSCT Columns.....	37
Figure 4-18.	Comparison of GFH RSSCT and Full-Scale System Results for STMGID in Washoe County in NV	37
Figure 4-19.	Antimony Breakthrough Curves from STMGID, NV Laboratory RSSCT Columns.....	39
Figure 4-20.	Breakthrough of V, P, Si, and Fe from STMGID, NV Laboratory RSSCT Columns Scaled to a Full-Scale EBCT of 3 min.....	40

Figure 4-21. As(V) Breakthrough Curves from Field RSSCT Columns at SBMHP in Wales, ME (Part 1)	42
Figure 4-22. As(V) Breakthrough Curves from Field RSSCT Columns at SBMHP in Wales, ME (Part 2)	42
Figure 4-23. As(III) Breakthrough Curves from Field RSSCT Columns at SBMHP in Wales, ME	43
Figure 4-24. Breakthrough of Si and P from Field As(V) RSSCT Columns at SBMHP in Wales, ME	44
Figure 4-25. Breakthrough of Si and P from Field As(III) RSSCT Columns at SBMHP in Wales, ME	45
Figure 4-26. Total and Soluble Ti Breakthrough Curves from As(III) RSSCT Columns at SPMHP in Wales, ME	46

TABLES

Table 1-1. RSSCT Scaling Equations	4
Table 1-2. RSSCT Site-Specific Study Objectives	6
Table 3-1. Physical Properties of Eight Commercially-Available Adsorptive Media Evaluated	12
Table 3-2. Design Conditions of Pilot- and Full-Scale Systems and Corresponding RSSCT Columns	13
Table 3-3. Summary of Sampling Frequency and Analysis	17
Table 3-4. Analytical Methods, Sample Volumes, Containers, Preservations, and Holding Times.....	18
Table 4-1. Average Influent Water Quality Data	20
Table 4-2. Throughput Before Reaching Arsenic and Uranium MCLs for Upper Bodfish Groundwater in Lake Isabella, California.....	36
Table 4-3. Throughput Before Reaching Arsenic and Antimony MCLs for STMGID, NV Groundwater	39
Table 4-4. Comparison of Throughput for As(III) and As(V) Removal from SBMHP Groundwater in Wales, ME	43
Table 4-5. Summary of Arsenic Adsorption Capacities.....	47
Table 4-6. Summary of Media Life at Six Arsenic Demonstration Sites.....	48

ACRONYMS AND ABBREVIATIONS

ρ_b	apparent bulk density (g/L)
Al	aluminum
As	arsenic
As(III)	arsenite
As(V)	Arsenate
As_0	initial arsenate concentration ($\mu\text{g/L}$)
As	final arsenate concentration ($\mu\text{g/L}$)
As_b	arsenate concentration in the bulk solution ($\mu\text{g/L}$)
As_s	arsenate concentration at solid/liquid interface
ASU	Arizona State University (Tempe, AZ)
ATS	Aquatic Treatment Systems
Bi	Biot number = $\frac{K_f * R_p * As_0}{D_s * \rho_a * Q}$
BV	bed volume
C_{As}	equilibrium concentration between solid and liquid phase ($\mu\text{g/mg}$)
Ca	calcium
Cl ⁻	chloride
d_p	media particle diameter (cm)
D_p	pore diffusion coefficient (cm^2/sec)
D_s	surface diffusion coefficient (cm^2/sec)
D_L	free liquid diffusivity (cm^2/sec)
E33	granular ferric (hydr)oxide (product of Severn Trent Services)
EBCT	empty bed contact time
EPA	United States Environmental Protection Agency
Fe	iron
GAC	granular activated carbon
GFH	granular ferric hydroxide (product of Siemens, formally US Filter)
gpm	gallons per minute
GTO	granular titania oxide (product of DOW Chemical)
HCl	hydrochloric acid
HDPE	high-density polyethylene
HIX	hybrid ion exchange
HNO ₃	nitric acid
ICP-MS	inductively coupled plasma-mass spectrometry
ID	identification
K	Freundlich coefficient
K_f	external mass transfer coefficient (cm/sec)

LVHS	Licking Valley High School
<i>m</i>	mass of the media
MCL	maximum contaminant level
MDL	method detection limit
Mn	manganese
<i>n</i>	Freundlich coefficient
NO ₃ ⁻	nitrate
NOM	natural organic matter
NSF	NSF International
P	phosphorous
PO ₄ ³⁻	phosphate
PVC	polyvinyl chloride
<i>q_{avg}</i>	average adsorptive capacity (µg/mg)
<i>q</i>	adsorptive capacity (µg/mg)
<i>q_m</i>	maximum solid phase concentration (µg/mg)
QA/QC	quality assurance/quality control
QAPP	quality assurance project plan
<i>r</i>	radial coordinate from the center of the particle
<i>R_p</i>	radius of particle (cm)
<i>Re</i>	Reynolds Number = $\frac{2 * R_p * \rho * v}{\mu}$
ReSc	Reynolds-Schmidt Number
RPD	relative percent difference
RSSCT	rapid small scale column test
<i>Sh</i>	Sherwood Number = $\frac{2 * R_p * K_f}{D_{mol}}$
<i>Sc</i>	Schmidt Number = $\frac{\mu}{\rho * D_{mol}}$
<i>St</i>	Stanton Number = $\frac{K_f * (1 - \epsilon) * \tau}{\epsilon * R_p}$
Sb	antimony
SBMHP	Spring Brook Mobile Home Park
Si	silicon
SiO ₂	silica
SO ₄ ²⁻	sulfate
STMGID	South Truckee Meadows General Improvement District
<i>t</i>	time
TO	task order
TOC	total organic carbon
U	uranium
USS	US Sieve Size

ϵ	void fraction
V	vanadium
μ	viscosity
V_r	volume of the reactor (L)
v	interstitial velocity (cm/sec)

ACKNOWLEDGEMENTS

We wish to thank the water operation staff of several water systems for their support in obtaining water samples for the study. The water systems involved included Valley Vista and Rimrock with Arizona Water Company in Arizona, Licking Valley High School (LVHS) in Ohio; Village of Lyman in Nebraska; Upper Bodfish (Lake Isabella) with California Water Service Company (Cal Water) in California; South Truckee Meadows General Improvement District (STMGID) in Nevada, and Spring Brook Mobile Home Park (SBMHP) in Wales, Maine. Mohammad Badruzzaman worked as a graduate student at the Arizona State University (ASU) at three of the sites. Inductively Coupled Plasma-Mass Spectrometry (ICP-MS) analytical assistance for samples collected by ASU was provided by Panjai Prapaipong in Professor Shock's Laboratory at ASU.

1.0 INTRODUCTION

Mini-columns were scaled to mimic the performance of continuous-flow, full- and pilot-scale arsenic treatment systems using a rapid small scale column test (RSSCT) approach originally developed for removal of organic compounds by granular activated carbon (GAC) and recently verified for arsenic removal by porous metal (hydr)oxides (Crittenden et al., 1991; Badruzzaman et al. 2004; Westerhoff et al., 2005). Several commercially available adsorptive media including iron-, alumina-, titania-, and hybrid ion exchange resin-based products were evaluated in parallel RSSCT columns using a common influent water source. Water for the testing was obtained from sites where the U.S. Environmental Protection Agency (EPA) had installed or planned to install adsorptive media arsenic removal systems as part of the Arsenic Treatment Technology Demonstration Program (Wang et al., 2004) under EPA's Arsenic Rule Implementation Research Program. This report describes the fabrication and testing of the RSSCTs and results from their use for removing arsenic and other inorganic constituents/co-contaminants from groundwater at seven different sites.

1.1 Background

Battelle is currently contracted by EPA to conduct 50 full-scale, long-term, on-site demonstrations of arsenic removal technologies applicable to small systems. This project is part of an EPA initiative to assist small community water systems (<10,000 customers) in complying with the new arsenic standard. Twenty-three of the 40 demonstration sites use adsorptive media arsenic removal technology, which was selected because of its ease of use for treating water in small systems. The conventional means for selecting adsorptive media has been based upon the results of long-term pilot-plant studies. Because the time required for evaluating the capacities of new adsorptive media usually is lengthy (e.g., nine to 12 months), the cost for the pilot plant studies can be substantial. To reduce the cost and time to evaluate media performance, several preliminary research studies have been conducted using the RSSCT method for arsenic removal (Thomson and Anderson, 2004; Westerhoff et al., 2005). The results of these preliminary studies have shown that the RSSCT method, which usually requires only three to four weeks of testing, has the potential to predict the performance of full-scale systems. If this proves true, the method would provide the water industry with a lower cost method to develop performance data necessary for full-scale design of arsenic adsorptive media systems. To evaluate the usefulness of this short-term predictive method, side-by-side tests using RSSCTs and pilot/full-scale systems are required.

1.1.1 Arsenic Interaction with Metal (Hydr)Oxide Surfaces. Arsenate (H_3AsO_4 , H_2AsO_4^- , HAsO_4^{2-} , or AsO_4^{3-}) is the dominant species in oxygenated water, present in anionic forms over the pH range of 2 to 14 (Figure 1-1). Over the pH range of most groundwater, arsenate is present as H_2AsO_4^- and HAsO_4^{2-} . Arsenite occurs under more reducing conditions and is present in a non-ionic form (H_3AsO_3) below pH around 9.2 (McNeill and Edwards, 1997a; McNeill and Edwards, 1997b). Chlorine, permanganate, or ozone readily oxidizes arsenite to arsenate, while oxidation by monochloramine, chlorine dioxide, or oxygen is less effective (Ghurye and Clifford, 2001).

Arsenic (i.e., arsenate and arsenite) can associate with iron surfaces either by forming inner-sphere or outer-sphere complexes (Goldberg and Johnston, 2001; Raven et al., 1998; Wilkie and Hering, 1996). Surface chemistry is important in arsenic removal by metal oxides. The surfaces of metal oxides are collections of unfilled metal-oxygen bonds that hydrate in water. Electrostatic attraction of anionic species is favored onto positively charged surface sites. At the pH of zero point of charge (pH_{ZPC}), an equal number of positively and negatively charged surface sites exist, and proportionally more positively charged surface sites at pH levels below pH_{ZPC} . Therefore, pH_{ZPC} is one indicator for the potential of removing anionic arsenic species. Iron (hydr)oxides have $\text{pK}_{\text{a}1}$ and $\text{pK}_{\text{a}2}$ values of ~7.3 and 8.9, respectively, resulting in a pH_{ZPC} on the order of 8.0. For aluminum and titanium oxides, the pH_{ZPC}

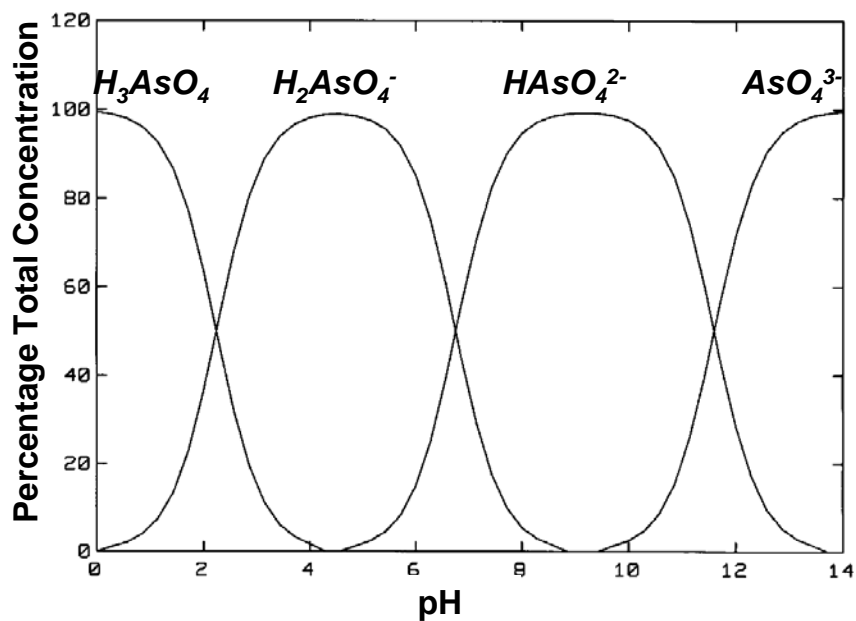
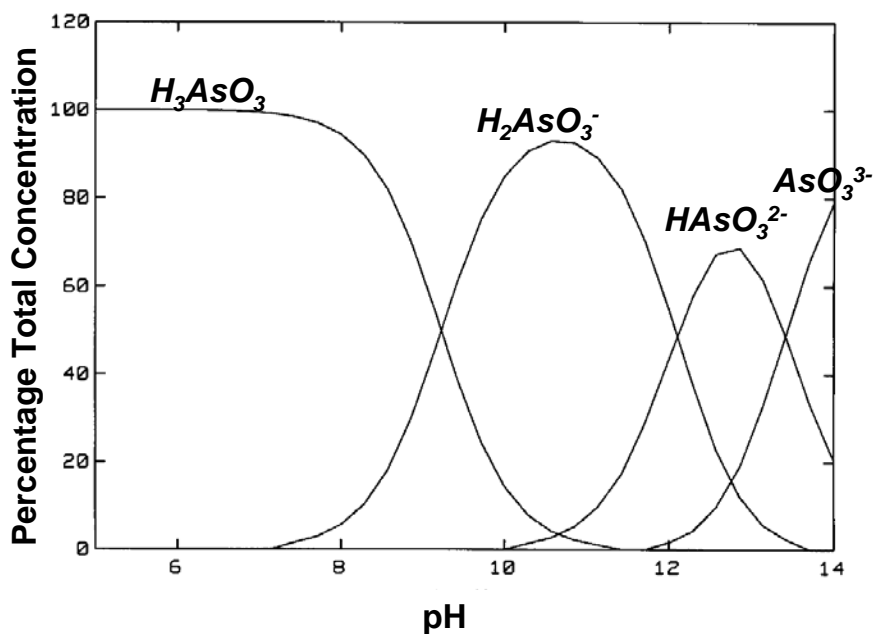

Figure 1-1. Arsenate (As[V]) and Arsenite (As[III]) Speciation

values are around 7. Anionic arsenic species are generally removed more effectively than non-ionic arsenic species by most metal-oxide adsorbents.

Coulombic forces favor association of anionic arsenate with positively charged sites on metal oxides (e.g., $MeOH_2^+$). In addition to electrostatic bonding, arsenic also forms with some surfaces covalent bonds including monomolecular monodentates and bidentates. Whereas electrostatic bonds form rapidly (in

seconds) and depend largely on the charge difference between arsenate and the media surface, covalent bonds form less rapidly and depend on their respective molecular structure. Covalent bonds are irreversible and stronger than electrostatic attractions. As covalent bonds form, surface sites can become available for electrostatic bonding again. The kinetics of bond formation may affect the optimal contact time required for a specific media in a column operation.

Silica is a major anion that exerts significant impact on arsenate removal by porous metal-oxide adsorptive media (Smith and Edwards, 2005). A few batch and column studies document that silica reduces arsenic adsorptive capacity of ferric oxides/hydroxides and activated alumina (Meng et al., 2002; Meng et al., 2000). Several mechanisms have been proposed to describe the role of silica in iron-silica and iron-arsenic-silica systems, including that (1) adsorption of silica may change the surface properties of adsorbents by lowering the iso-electric point or pH_{zpc} ; (2) silica may compete for arsenic adsorption sites; (3) polymerization of silica may accelerate silica sorption and lower the available surface sites for arsenic adsorption; and (4) reactions of silica with divalent cations such as calcium, magnesium and barium may form precipitates.

1.1.2 Mass Transport of Ions in Porous Adsorptive Media. Iron, aluminum, titanium, zirconium, and other metal oxide-based adsorptive media have been manufactured to remove arsenic from water supplies over the past decade. Most of these media have surface areas over $100 \text{ m}^2/\text{g}$ and have a continuum of micro- and macro-pores (Badruzzaman et al., 2004). Mass transport of arsenic from solution onto these porous adsorptive media has been described by film diffusion and intraparticle surface and/or pore diffusion (Badruzzaman et al., 2004; Lin and Wu, 2001). Despite the formation of strong bonds between arsenic and metal oxides, surface diffusion is still possible (Axe and Trivedi, 2002). However, intraparticle transport is probably a combination of surface and pore diffusion.

Intraparticle mass transport is believed to be the rate limiting step in adsorption removal of arsenic. As a result, adsorbed arsenic concentrations (i.e., mg As/g of adsorbent) are the highest on the external surface of an adsorbent particle and decline towards the center of the particle. The concentration gradient causes arsenic to migrate from the external surface into the porous particle. Over time, adsorbed arsenic concentrations in the particle increase, thus decreasing the concentration gradient and, therefore, decreasing the arsenic removal from solution. In a packed-bed adsorptive media system, a mass transfer zone, where active adsorption occurs, is established initially at the inlet of the bed and gradually migrates deeper into the bed. Arsenic eventually breaks through the bed with increasing concentrations in the system effluent.

1.1.3 Rapid Small Scale Column Tests for Arsenic Removal by Porous Adsorbents.

Procedures have been developed and applied over the last two decades for RSSCTs that simulate pilot- and full-scale performance of GACs for organic micropollutants and natural organic matter (NOM) removal. RSSCT bench-scale testing is a method where dimensionless mathematical parameters are used to scale down a pilot- or a full-scale adsorber based on applicable adsorbate transport mechanisms. The advantage of RSSCTs is that breakthrough curves can be obtained in a fraction of time with a fraction of water that would be required for pilot-scale testing. Theoretically, RSSCT and pilot/full-scale adsorbents would produce identical breakthrough curves, but in reality, they differ based on water quality, biological processes, and/or RSSCT scaling assumptions.

In the development of scaling equations, three conditions are required in order to maintain similarity between large- and small-scale systems (Crittenden et al., 1991; Crittenden et al., 1987; Crittenden et al., 1986). First, boundary conditions for the large- and small-scale systems must occur at the same dimensionless coordinate values in dimensionless differential equations. Second, dimensionless parameters in the differential equations must be equal for the large- and small-scale systems. Finally, no

Table 1-1. RSSCT Scaling Equations

Scaling Assumption	Relationships	Equation No.
Proportional Diffusivity (PD: x = 1)	$\frac{D_{SC}}{D_{LC}} = \left[\frac{d_{p,SC}}{d_{p,LC}} \right]^{2-x}$	1.1
	$\frac{EBCT_{SC}}{EBCT_{LC}} = \left[\frac{d_{p,SC}}{d_{p,LC}} \right] = \frac{t_{SC}}{t_{LC}}$	1.2
Constant Diffusivity (CD: x = 0)	$\frac{EBCT_{SC}}{EBCT_{LC}} = \left[\frac{d_{p,SC}}{d_{p,LC}} \right]^{2-x} = \frac{t_{SC}}{t_{LC}}$	1.3
	$\frac{V_{SC}}{V_{LC}} = \left[\frac{d_{p,LC}}{d_{p,SC}} \right]$	1.4
General Relationships	$\frac{V_{SC}}{V_{LC}} = \left[\frac{d_{p,LC}}{d_{p,SC}} \right] \times \frac{Re_{SC} \times Sc}{Re_{LC} \times Sc}$	1.5
	$Re = \frac{V \times \rho_L \times d_p}{\mu}$	1.6
	$Sc = \frac{\mu}{D_L \times \rho_L}$	1.7
	$Re Sc = \frac{V \times d_p}{D_L}$	1.8

Note: Subscripts “SC” and “LC” indicating small column (i.e., RSSCT column) and large column (i.e., pilot/full-scale column), respectively.

EBCT = empty bed contact time ρ_L = liquid density
 d_p = media diameter μ = viscosity
t = time D_L = liquid diffusivity of arsenic
V = loading rate D = effective surface diffusivity
Re = Reynolds number ReSc = Reynolds-Schmidt product
Sc = Schmidt number

change in mechanism may occur while reducing the size of the system. RSSCTs may be designed using equations 1.3 and 1.4 in Table 1-1 if the effective surface diffusivity is independent of particle size and, therefore, identical between the large-scale and RSSCT columns. If the effective surface diffusivities are not identical between the large-scale and RSSCT columns, perfect similarity cannot be guaranteed. However, if it is assumed that the effective surface diffusivity is linearly proportional to the particle radius and that the intraparticle diffusion is the controlling mechanism, an RSSCT may be designed using equations 1.1 and 1.2 and perform similarly to the large-scale column. The Reynolds number, Re, is a dimensionless ratio of the inertial forces over the viscous forces in a fluid and the Schmidt number, Sc, is a dimensionless ratio of the diffusion of momentum over the diffusion of mass. The product of the Reynolds number and the Schmidt number (ReSc) may be used to determine the minimum Reynolds number for the RSSCT such that the effects of dispersion are not important (dispersion is not important if

ReSc is in the mechanical dispersion region from 200,000 to 200). Equations 1.5 through 1.8 are used to reduce loading rates in the small column and minimize potential for bed compaction, while maintaining a minimum Reynolds-Schmidt product.

Both proportional and constant diffusivity scaling relationships have recently been applied for arsenic removal by porous metal (hydr)oxide adsorptive media (Badruzzaman, 2005; Badruzzaman and Westerhoff, 2005; Sperlich et al., 2005; Westerhoff et al., 2005; Badruzzaman et al., 2004). Each research group appears to make different assumptions and scale to different types of larger scale loading rates and other design parameters. Based upon ASU's work with multiple comparisons between pilot-scale and RSSCT arsenic breakthrough curves, proportional diffusivity scaling equations appear to accurately mimic performance of larger-scale columns without leading to excessive pressure development within the RSSCT columns, as is the case with constant diffusivity-based RSSCTs. As such, proportional diffusivity scaling relationships were used in this study.

The size of an RSSCT column is based on the scaling approach (constant or proportional diffusivity) and the ratio of the adsorptive media size used in the large-scale column to that in the RSSCT column. Selecting smaller media sizes or a lower ReSc value for the RSSCT columns would decrease the volume of water and duration of the test. However, smaller media sizes can significantly increase pressure drop across the RSSCT columns. Excessive pressure accumulation can compress "softer" media and lead to failure of the RSSCT testing. In previous work, 100×140 and 140×170 mesh sizes performed well for most media (Westerhoff et al., 2005). Another assumption for the use of RSSCT is that the media is homogeneous. Therefore, crushing the media would not alter the mechanisms governing the adsorption on the uncrushed media. This assumption appears to be valid for most of the commercially available metal (hydr)oxide adsorptive media.

1.2 Objectives

The overall objective of this project is to evaluate the usefulness of RSSCT by performing side-by-side comparison between the results of RSSCT and pilot- or full-scale adsorptive media systems either in the field or in the laboratory. The test locations included six EPA arsenic removal technology demonstration sites (i.e., Valley Vista and Rimrock in Arizona; Village of Lyman in Nebraska; Upper Bodfish in Lake Isabella, California; South Truckee Meadows General Improvement District [STMGID] in Washoe County, Nevada; and Spring Brook Mobile Home Park [SBMHP] in Wales, Maine) and one pilot-scale test site at Licking Valley High School (LVHS) in Newark, Ohio. The LVHS test site was selected because extensive pilot-scale tests had been performed for various commercially available adsorptive media and because the groundwater at LVHS contained high levels of arsenite (i.e., 60 to 80 $\mu\text{g/L}$), whereas the other technology demonstration sites had mostly arsenate. For each location, RSSCT tests were conducted using three to four parallel columns packed with different adsorptive media. Specific objectives were developed for each site as shown in Table 1-2.

1.3 Report Organization

This report is organized into four chapters. Chapter 1 is the introduction. Chapter 2 summarizes the conclusions from the study. Chapter 3 describes the methodologies for sizing, preparing, and operating RSSCTs, and for sampling and analyses. Chapter 4 presents the key results from the study.

Table 1-2. RSSCT Site-Specific Study Objectives

Site No.	Location	Objectives
Site 1	Valley Vista, Arizona	1) To predict the performance of the full-scale AAFS50 system for arsenic removal, 2) to compare AAFS50 arsenic removal capacity to that of two iron-based media, i.e., E33 and GFH, 3) to evaluate the validity of conducting RSSCTs in the laboratory – a controlled environment – by collecting and transporting water from the field, and 4) to examine the use of a lower ReSc value (i.e., 500 versus 2,000) for RSSCT column design
Site 2	Rimrock, Arizona	1) To compare the performance of laboratory RSSCT columns against that of the full-scale E33 system, 2) to compare E33, AAFS50, GFH, and ArsenX ^{np} for arsenic removal, and 3) to examine the use of a lower ReSc value (i.e., 1,000 versus 2,000) for RSSCT column design
Site 3	LVHS in Newark, Ohio	To compare results of RSSCT with those of several previously performed pilot-scale tests on AAFS50, GFH, E33 and ArsenX ^{np} for arsenite removal
Site 4	Village of Lyman, Nebraska	1) To evaluate the removal of co-occurring uranium and arsenic by titania-based and other media, and 2) to evaluate an approach (i.e., by reducing ReSc values) that could help reduce operational problems associated with titania-based media
Site 5	Upper Bodfish in Lake Isabella, California	To evaluate the removal of co-occurring uranium and arsenic by hybrid ion exchange resin (HIX)-based media, ArsenX ^{np} , and other media
Site 6	STMGID in Washoe County, Nevada	1) To predict the full-scale GFH system performance for arsenic and antimony removal, 2) to evaluate multiple adsorptive media for arsenic and antimony removal, and 3) to examine the use of a shorter-than-full-scale EBCT for RSSCT scaling (a technique that can significantly shorten the required RSSCT run time)
Site 7	SBMHP in Wales, ME	1) To simulate the full-scale system, 2) to evaluate alternative media for full-scale implementation, and 3) to evaluate the removal capacity of four adsorptive media to remove arsenite

2.0 SUMMARY AND CONCLUSIONS

The following summarizes the key findings from this study related to the use of RSSCTs to predict/evaluate the ability of metal hydr(oxide) media to remove arsenic and other co-contaminants.

Key operational parameters, including reduced ReSc values and EBCT, were evaluated to minimize the run time and volume of water required to conduct RSSCTs. The ReSc parameter essentially fixes mass transfer within the packed bed. All previous work had been conducted with an ReSc value of 2,000. Decreasing the ReSc value would decrease the volume of water and run time required for the RSSCTs and shorten the length of packed columns, hence leading to less pressure drop across the packed beds. For iron-based media, decreasing the ReSc value from 2,000 to 1,000 or 500 resulted in pre-matured arsenic breakthrough; therefore, a ReSc value of <2,000 would not be recommended. For titania-based media, an ReSc value of 2,000 or 1,000 gave comparable results, thus a reduced value could be used to cope with operational problems, such as excessive pressure buildup and bed compaction, due to inherent media properties.

In addition to ReSc values, the selection of the full-scale EBCT to scale the RSSCT column would affect the RSSCT run time and volume of water required. In parallel tests, EBCTs of 6.3 and 3 min with GFH resulted in nearly identical arsenic breakthrough curves when plotted against throughput. In separate parallel tests with titania-based media (MetsorbG), EBCTs of 5.3 and 2.5 min resulted in nearly identical arsenic breakthrough curves. Along with related work on other projects, it appears that selection of a shorter full-scale EBCT can be used for scaling RSSCT columns.

RSSCTs conducted in the field at the well site corresponded reasonably well with those conducted in the laboratory. The laboratory setting offered a more controlled environment. Because water was generally collected just one time for laboratory RSSCTs, these RSSCT tests had less varying, but less representative, influent water quality than those conducted in field where influent water was refilled every one to three days.

Water quality at each site tested varied and consequently the ability to remove arsenic by a given media also varied. The removal of arsenic from water by adsorptive media was affected by the pH and presence of other metals and competitive anions, such as silica and phosphorous. Arsenic occurred as As(V) at concentrations of 21.5 to 61.0 µg/L and pH values between 7.2 and 7.7 in five of the seven source waters tested. Two source waters containing As(III) had arsenic concentrations of 64 and 22.5 µg/L and pH values of 8.1 and 8.5.

For As(V), the RSSCT method proved to be a reliable approach for comparing the ability of different adsorptive media for its removal. RSSCT arsenic breakthrough curves corresponded reasonably well with those observed in full-scale systems installed as part of the EPA arsenic removal demonstrations in Valley Vista and Rimrock in Arizona, the Village of Lyman in Nebraska, Upper Bodfish in Lake Isabella, CA, and STMGID in Washoe County, Nevada.

For As(III), the number of bed volumes (BV) treated to reach 10 µg/L in the RSSCT effluent was notably higher than that for As(V) and that of the pilot-scale system performance at LVHS in Newark, OH. The results, however, did predict the relative performance of the media to one another based on the results of the pilot tests conducted at LVHS. Additional work is needed to determine if the scaling equations that are proven adequate for As(V) need to be modified for A(III) RSSCTs.

RSSCT may be used as a standard testing protocol to assess media performance for different source waters, compared to the inherent variability experienced by pilot tests. For the six demonstration

locations, five source waters had pH values ranging from 7.2 to 7.7, while the other one had a much higher pH value which averaged 8.6. All waters had varying concentrations of other constituents, which could pose detrimental effects on arsenic removal. For example, the source water at STMGID was considered the most difficult water to treat because of the presence of the highest phosphate and silica concentrations in that water. The source water at Lyman, NE also was difficult to treat due to the presence of the highest amount of vanadium, sulfate, and TOC and the second highest phosphorous concentration. The SBMHP site had a high pH (i.e., 8.7), which significantly reduced the arsenic removal capacity.

The source water at STMGID contained arsenic and antimony, both of which were above their respective MCLs of 10 and 6 µg/L. Co-removal of antimony essentially did not occur, with antimony breaking through before arsenic. Although operational problems were encountered, it appeared that the only media that exhibited the potential for antimony removal was titania-based media. It was not clear if antimony removal was inhibited by competing ions present or if the media tested, in fact, were not capable of significant antimony removal.

The source water at Lyman and Upper Bodfish had levels of arsenic and uranium above the respective MCLs. The only media that exhibited removal capacity for uranium was ArsenX^{pp}, which removed uranium most likely via the anion exchange sites on its resin matrix. Uranium began to break through from the Lyman column after 20,000 BV and never broke through from the Upper Bodfish column as the study ended at about 50,000 BV. The difference probably was due to the presence of competing anions in the Lyman water.

All media tested removed some vanadium. GFH media removed more vanadium than any other media. Phosphate was present at concentrations ranging from 15 to 162 µg/L. All media removed some phosphate. GFH media removed more phosphate than any other media. None of the media removed any significant amount of the nitrate, chloride, fluoride or silica present in the waters under the conditions tested.

3.0 MATERIALS AND METHODS

This section discusses the materials and methods used for the design and operation of RSSCTs in the field and laboratory.

3.1 RSSCT Apparatus

A series of stand-alone RSSCT apparatuses, each consisting of a glass column packed with adsorptive media and a piston pump (Figure 3-1), were fabricated for the laboratory and field testing. The 1.1-cm (inner diameter) \times 30.5 cm (length) glass column (Ace Glass, Vineland, NJ) was used to house a media bed packed between the top and bottom layers of glass wool and 5 mm-diameter borosilicate glass beads and sealed by a Teflon[®] end cap on each end. The piston pump (Model QG150 or QG50, FMI Inc., Syosset, NY) equipped with a stainless steel or ceramic pump head (Model Q2CSC, FMI Inc., Syosset, NY) was used to deliver water via 3.2 mm Teflon[®] tubing. The glass beads in the column helped disperse the incoming flow from the top of the column and provide a base layer of support for the media bed. Figure 3-2 shows a schematic of a packed RSSCT column and a photograph of four typical packed columns.

3.2 Preparation of RSSCT Adsorptive Media

Table 3-1 provides the physical properties of eight adsorptive media evaluated in this study. The types of media tested include iron oxide-based media (i.e., E33, ARM 200, and KemIron), iron hydroxide-based media (GFH), iron modified activated alumina (AAFS50), titania-based media (MetsorbG and GTO), and hybrid ion exchange resin (HIX)-based media (ArsenX^{np}). Arithmetic means were used to calculate respective media diameters unless noted. Virgin media (as received) were crushed using a mortar and a pestle. Crushed media were sorted using a series of stainless steel U.S. standard mesh sieves to obtain the 100 \times 140 mesh fraction. The media in the 140 mesh sieve were rinsed with distilled water until fines no longer filtered through the sieve. The washed media in the 140 mesh sieve were transferred to Nalgene bottles containing distilled water and stored until use.

An assumption for the use of RSSCT is that the media is homogeneous. Crushing the media, therefore, would not alter the adsorption mechanisms that govern the adsorption on the uncrushed media. While it is valid for most of the commercially-available metal (hydr)oxide media, this assumption may not be valid for ArsenX^{np}, which is an iron-impregnated anion exchange resin. Recent work at ASU suggests that iron concentrations might be significantly higher near the exterior surface of resin beads than at the center of the beads. As such, crushing the ArsenX^{np} media for RSSCT would redistribute the iron concentrations, thus effectively “normalizing” the iron contents throughout the crushed fractions. It is possible that higher iron contents near the exterior surface of the uncrushed beads could create a more favorable adsorbed arsenic concentration gradient, thus causing better arsenic removal by a pilot- or full-scale packed bed than by a RSSCT column. It is also possible that some of the impregnated iron particles were sloughed off from the resin beads during media crushing and washed away along with media fines during media washing, thereby causing less arsenic removal by an RSSCT column.

3.3 Preparation of RSSCT Columns

Each RSSCT column was prepared by placing an appropriate amount of a washed and sieved 100 \times 140 mesh adsorptive media into a glass column containing layers of glass beads and glass wool in the bottom of the column. The amount of media packed into the column and the corresponding bed depth was determined through the use of proportional diffusivity scaling equations (i.e., Equations 1.1 and 1.2 in Table 1-1).

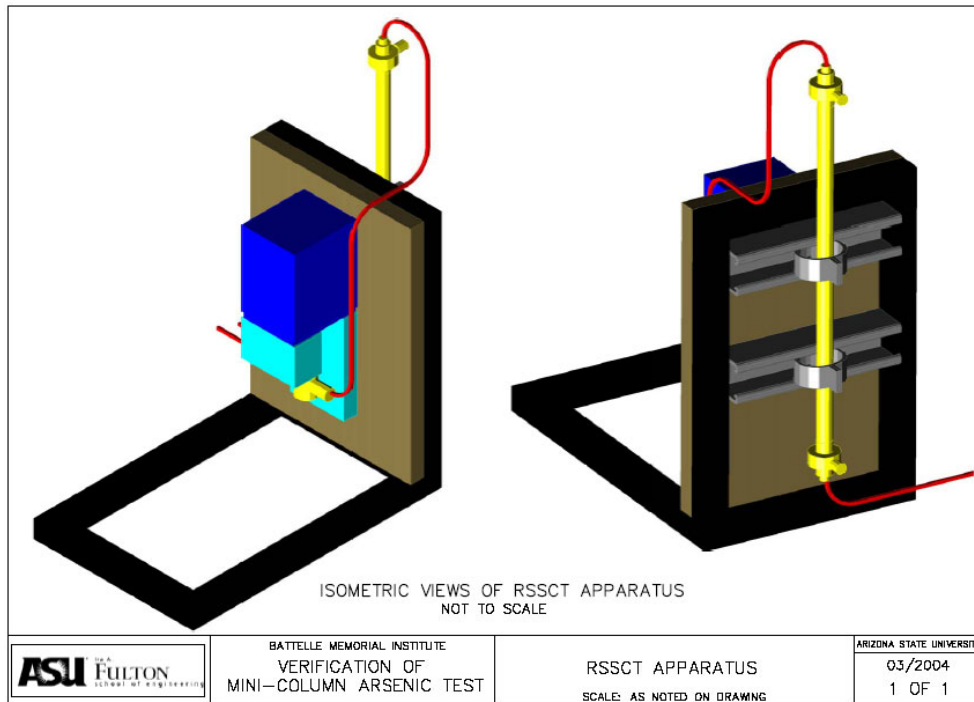
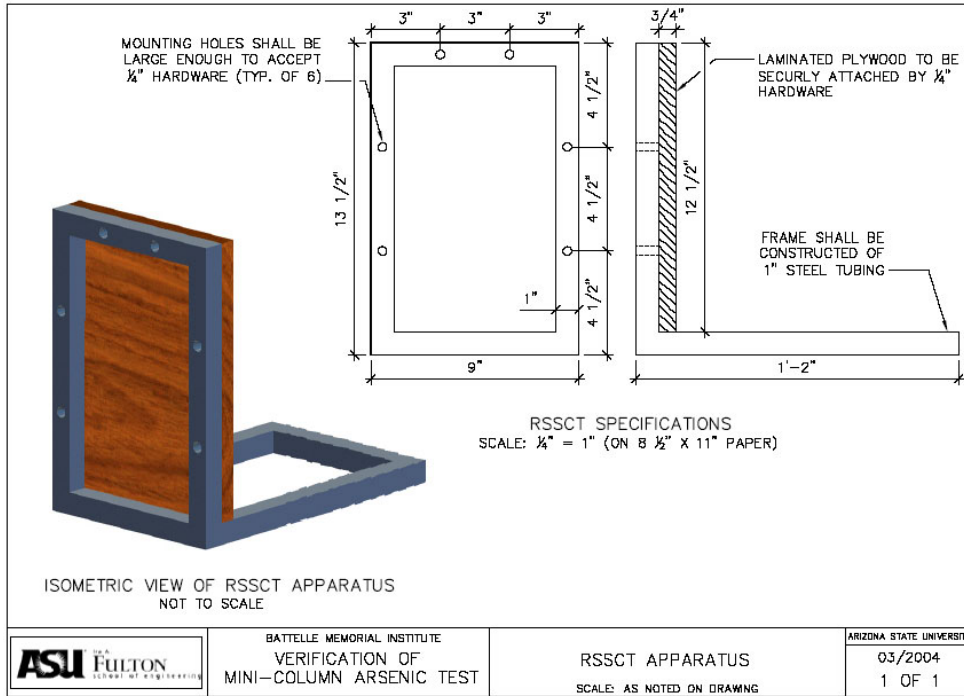

Figure 3-1. Illustration of Stand-Alone RSSCT Apparatus Dimensions (upper) and Layout with Column and Pump (lower)

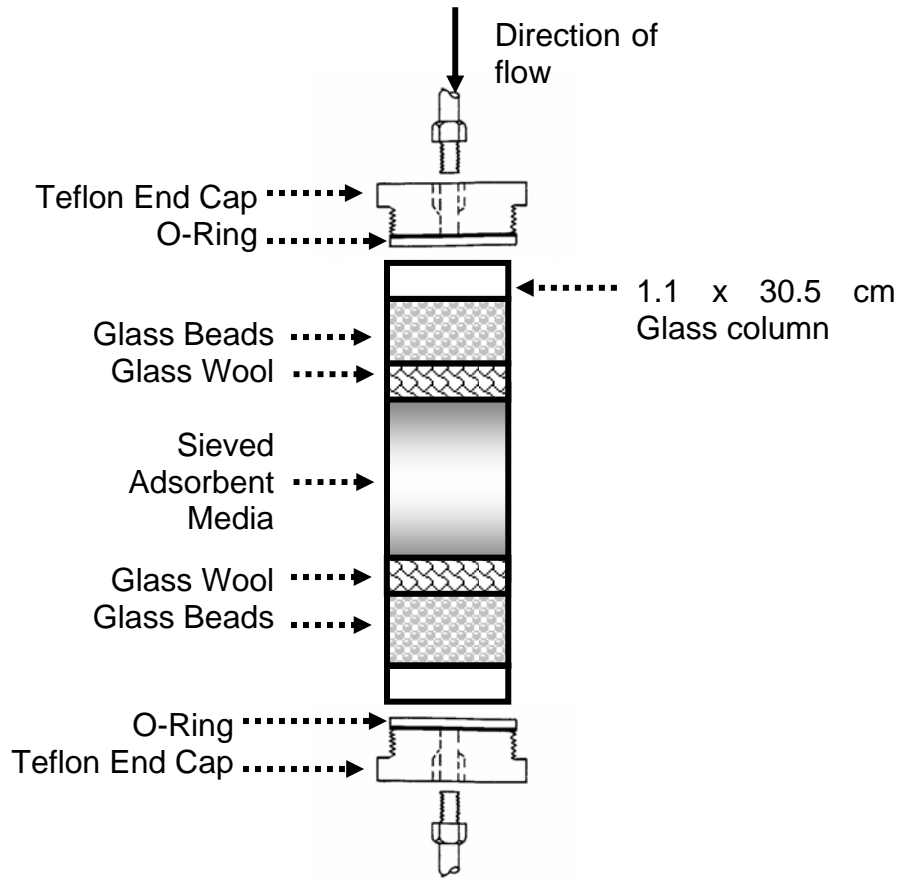

Figure 3-2. Schematic (upper) and Photograph (lower) of Typical Packed Columns

Table 3-1. Physical Properties of Eight Commercially-Available Adsorptive Media Evaluated

Media Type	Media	Supplier/ Manufacturer	Media Diameter		BET Surface Area ^(b) (m ² /g)
			Product Literature	RSSCT Design ^(a) (mm)	
Iron oxide-based	E33	Severn Trent Services	0.5-2.0 mm (10×35 USS)	1.16*	133 (142)
	ARM 200	Engelhard	0.42-1.68 mm (12×40 USS)	1.06	NA
			0.30-1.68 mm (12×50 USS)	1.0	
KemIron CFH-12	KemIron	1.0-2.0mm (10×18 USS)	1.5	NA	
Iron hydroxide-based	GFH	Siemens (formally USFilter)	0.32-2.0 mm (~10×50 USS)	1.16	259 (127)
Iron-modified, alumina-based	AAFS50	Alcan	0.3-0.6 mm (28×48 Tyler)	0.85*	267 (220)
Titania-based	MetsorbG	Graver/Hydroglobe	0.3-1.19 mm (16×50 USS)	0.67*	125
	Adsorbsia GTO	DOW Chemical	0.25-2.0 mm (10×60 USS)	0.67*	70 (200-300)
Hybrid ion exchange resin-based	ArsenX ^{np}	Purolite/Solmetex	0.3-1.2 mm (16×50 USS)	0.75, 0.57 ^(c)	82

USS = US Sieve Size, NA = Not Available

(a) Values calculated by taking arithmetic mean, except for those denoted by *

(b) Data in parentheses reported in product literature

(c) 0.57 mm used in laboratory Reno test and 0.75 mm used in others. ASU measured particle diameter to be 0.53 to 0.61 mm with an arithmetic mean of 0.57 mm.

To prevent entrainment of air during column preparation, the media were transferred to the RSSCT column filled with water. The media in the column were thoroughly backwashed until the effluent was visibly clear of fines. To compress the media, the exterior of the glass column was gently tapped while the media particles settled. Additional media were added and backwashed until the desired bed depth was achieved. The mass of the media added to the column was estimated from the bulk density and the volume of the packed bed. Layers of glass wool and glass beads were then placed on top of the column before the top Teflon[®] end-cap was carefully attached.

The flowrate of each piston pump was calibrated prior to connecting it to a column. Distilled water was pumped through the column for approximately 15 min to confirm the flowrate and to allow additional compaction of the media bed. After the valves on the top and bottom end-caps had been tightly closed, the preparation of the RSSCT column was complete and the column was ready for use (the valves on the top and bottom end-caps had to be tightly closed to prevent drainage during storage or transport of RSSCT columns). If air bubbles were observed in a packed media bed, the packing procedure had to be repeated to remove the entrapped air.

Table 3-2 summarizes the key design and operational parameters for the pilot- and full-scale systems and the corresponding RSSCTs for all media. In most cases, an ReSc value of 2,000 was used for column design. In selected tests with E33, this parameter was adjusted to a value of 500 and 1,000 for comparison. For MetsorbG and Adsorbsia GTO, it was necessary to use an ReSc value of 1,000 to minimize bed compaction. In some cases, reduced EBCTs of a full-scale system had to be used in the scaling equations to overcome operational difficulties, such as a 30 to 50% decrease in bed depth

Table 3-2. Design Conditions of Pilot- and Full-Scale Systems and Corresponding RSSCT Columns

Site ID	Site Location Test Duration	Adsorptive Media Tested	Pilot- and Full-scale Design Conditions ^(a)						RSSCT Design Conditions							
			Effective Media			Vessel			Effective Media			Vessel			BV Processed (#)	
			Diameter (mm)	Loading Rate (m/h)	EBCT (min)	ReSc	Diameter (cm)	Bed Depth (cm)	Diameter (mm)	Loading Rate (m/h)	EBCT (min)	ReSc	Diameter (cm)	Bed Depth (cm)		Mass of Media (g)
Site 1F	Valley Vista, AZ (field tests) 09/25/04-10/22/04	AAFS50	0.85	12.8	4.5	12085	91	85	0.128	14.1	0.68	2000	1.1	15.9	23.1	64,462
		GFH	1.16	12.8	4.5	16500	91	85	0.128	14.1	0.50	2000	1.1	11.6	16.9	75,579
		E33	1.16	12.8	4.5	16500	91	85	0.128	14.1	0.50	2000	1.1	11.6	16.1	93,905
Site 1L	Valley Vista, AZ (lab tests) 10/20/04-11/24/04	AAFS50	0.85	12.8	4.5	12085	91	85	0.128	14.1	0.68	2000	1.1	15.9	23.1	51,191
		GFH	1.16	12.8	4.5	16500	91	85	0.128	14.1	0.50	2000	1.1	11.6	16.9	80,102
		E33	1.16	12.8	4.5	16500	91	85	0.128	14.1	0.50	2000	1.1	11.6	16.1	88,627
Site 2	Rimrock, AZ (lab tests) 01/27/05-03/03/05	AAFS50	0.85	15.6	4.5	14700	91	85	0.128	14.1	0.68	2000	1.1	15.9	23.1	64,552
		GFH	1.16	15.6	4.5	20059	91	85	0.128	14.1	0.50	2000	1.1	11.6	16.9	92,293
		E33	1.16	15.6	4.5	20059	91	85	0.128	14.1	0.50	2000	1.1	11.6	16.1	92,293
Site 3	Licking Valley School District, OH (field tests) 05/25/05-06/05/05	AAFS50	0.85	3.7	5.0	3489	5	31	0.128	14.1	0.75	2000	1.1	17.6	25.6	17,238
		GFH	1.16	3.7	5.0	4761	5	31	0.128	14.1	0.55	2000	1.1	12.9	18.8	23,269
		E33	1.16	3.7	5.0	4761	5	31	0.128	14.1	0.55	2000	1.1	12.9	17.9	23,269
		ArsenXnp	0.75	3.7	5.0	3078	5	31	0.128	14.1	0.85	2000	1.1	20.0	25.5	25,242
Site 4	Lyman, NE (lab tests) 05/31/05-06/27/05	ArsenXnp	0.75	17.0	3.0	14175	244	85	0.128	14.1	0.51	2000	1.1	11.9	14.7	54,147
		E33	1.16	17.0	3.0	21924	244	85	0.128	14.1	0.33	2000	1.1	7.7	8.0	47,694
		Adsorbisia GTO	0.67	17.0	3.0	12663	244	85	0.128	7.0	0.57	1000	1.1	6.6	9.4	48,251
		MetsorbG	0.67	17.0	3.0	12663	244	85	0.128	7.0	0.57	1000	1.1	6.6	9.4	48,251
		Adsorbisia GTO	0.67	17.0	3.0	12663	244	85	0.128	14.1	0.28	2000	1.1	6.6	18.8	65,979
		MetsorbG	0.67	17.0	3.0	12663	244	85	0.128	14.1	0.28	2000	1.1	6.6	18.8	55,265
Site 5	Lake Isabella, CA (lab tests) 09/23/05-11/09/05	E33	1.16	9.7	5.3	12435	107	85	0.128	14.1	0.58	2000	1.1	13.7	19.4	74,123
		GFH	1.16	9.7	5.3	12435	107	85	0.128	14.1	0.58	2000	1.1	13.7	19.4	74,123
		ArsenXnp	0.75	9.7	5.3	8040	107	85	0.128	14.1	0.90	2000	1.1	21.2	30.0	50,927
		Adsorbisia GTO	0.67	9.7	2.5	7182	107	85	0.128	11.7	0.48	1000	1.1	5.6	7.9	62,990
		Adsorbisia GTO	0.67	9.7	2.5	7182	107	85	0.128	14.1	0.48	2000	1.1	11.2	15.8	45,759
		MetsorbG	0.67	9.7	2.5	7182	107	85	0.128	14.1	0.48	1000	1.1	5.6	7.9	23,649
Site 6	STMGID, NV (lab tests) 01/24/06-02/10/06	ARM 200	1.06	10.0	3.0	11745	168	103	0.128	14.1	0.36	2000	1.1	8.5	8.9	39,695
		Adsorbisia GTO	0.67	10.0	3.0	7424	168	103	0.128	7.0	0.57	1000	1.1	6.7	7.0	20,397
		ArsenXnp	0.57	10.0	3.0	6316	168	103	0.128	14.1	0.67	2000	1.1	15.8	19.5	31,803
		GFH	1.16	10.0	3.0	12853	168	103	0.128	14.1	0.33	2000	1.1	7.8	9.6	43,440
		GFH	1.16	10.0	6.2	12853	168	103	0.128	14.1	0.68	2000	1.1	16	19.8	31,317
Site 7	Wales, ME (field tests) 01/24/06-01/31/06 Test 1 03/14/06-03/23/06 Test 2 05/10/06-05/23/06 Test 3	AAFS50	0.85	24.2	2.2	23262	25	85	0.128	14.1	0.3	2000	1.1	7.3	8.7	66,177
		Adsorbisia GTO	0.67	24.2	2.2	18336	25	85	0.128	7.0	0.38	1000	1.1	5.1	4.5	45,730
		ARM 200	1.06	24.2	2.2	29009	25	85	0.128	14.1	0.24	2000	1.1	5.9	5.9	80,643
		ARM 200	1.00	24.2	2.2	27367	25	85	0.128	14.1	0.26	2000	1.1	6.1	6.3	68,937
		AsXnp	0.75	24.2	2.2	20525	25	85	0.128	14.1	0.34	2000	1.1	8.3	9.9	58,132
		GFH	1.16	24.2	2.2	31746	25	85	0.128	14.1	0.22	2000	1.1	5.2	6.4	86,516
		KemIron	1.5	24.2	2.2	41050	25	85	0.128	14.1	0.17	2000	1.1	4.1	4.9	102,697
		E33	1.16	24.2	2.2	31746	25	85	0.128	14.1	0.22	2000	1.1	5.3	5.7	80,284

(a) Actual field conditions may vary from design conditions for loading rate, EBCT, and bed depth

observed over the duration of RSSCT tests. The cause of the bed compaction and/or loss of media from the column might be attributed to excessive pressure development within the columns. These operational problems were experienced only with titania-based media, which have significantly lower structural integrity as compared to iron-based media. The scaling adjustments of titania-based media columns will be justified by the results of RSSCT tests in Sections 4.5 to 4.8. The results of several unsuccessfully operated titania-based columns are not included in this report.

3.4 RSSCT Field Setup

RSSCT tests were conducted in the field at Valley Vista, LVHS, and SBMHP. The Valley Vista site had a full-scale arsenic treatment system consisting of two 36 in × 72 in columns in series, each packed with 16.7 ft³ of AAFS50 media (Valigore et al., 2006). The average flowrate to the system was 36 gal/min (gpm) and the average EBCT per column was 3.5 min (not 4.5 min as designed). Three sets of RSSCT apparatus were set up in the immediate vicinity to the full-scale system inlet piping and media vessels under a sun shed. Water to the RSSCT columns was pumped continuously from a 50-gal Nalgene container wrapped with a tarp to minimize temperature variations and algae growth. The 50-gal container was refilled every three days with water after pre-chlorination and filtered with a 10-μm glass fiber cartridge filter. Effluent from the RSSCT columns was discharged to an on-site holding tank used to reclaim backwash wastewater to the head of the treatment train.

At LVHS, four sets of RSSCT apparatus were placed in the school's utility room by a polyurethane-coated unistrut frame on which a pilot system consisting of six 2 in × 4 ft glass columns (in parallel) was mounted. The average flowrate to the pilot system was 0.033 gpm (which yielded a hydraulic loading of 1.5 gpm/ft²) and the average EBCT was 5 min. Water from the pilot system inlet piping was directed to a 10-μm glass fiber cartridge filter and a five-port polyvinyl chloride (PVC) manifold. Water was then pumped continuously from four of the five ports on the manifold to four RSSCT columns. The fifth port on the manifold was used for pressure release and influent water sampling. The RSSCT effluent was discharged directly to the sewer. Figure 3-3 presents photographs of the RSSCT water delivery system.

At SBMHP, four sets of RSSCT apparatus were installed adjacent to the full-scale adsorptive media system, which consisted of two parallel treatment trains, each consisting of one 25-μm cartridge filter, one 10 in × 54 in oxidation column, and three 10 in × 54 in adsorption columns (Lipps et. al., 2006). The average flowrate through each train was 5.2 gpm and the average EBCT per column was 2.2 min. A 55-gal polypropylene tank was used to store water withdrawn every one to two days from either the raw water tap (that contained mostly As[III]), or one of the oxidation columns (that contained mostly As[V]). A 10-μm glass fiber cartridge filter was used to filter raw water from the well during the test on As (III) removal. Water was pumped from the storage tank to the four RSSCT columns and then discharged to the sewer. A photograph of the RSSCT setup is presented in Figure 3-4.

3.5 RSSCT Laboratory Setup

Additional RSSCT tests were conducted in the ASU laboratories at a constant ambient temperature of about 18°C. Water samples were collected and transported to ASU from Valley Vista, Rimrock, the Village of Lyman, Upper Bodfish, and STMGID. The Rimrock system consisted of two 36 in × 72 in columns in series, each packed with 22 ft³ of E33 media (Wang et al., 2005). The average flowrate to the system was 31.5 gpm and the average EBCT per column was 5.2 min (not 4.5 min as designed). Although never installed due to lack of adsorptive capacity for uranium, the Metsorb system proposed for the Lyman site had two 96 in × 96 in vessel in series, each loaded with 140 ft³ of Metsorb media. The average system flowrate was 350 gpm and the EBCT was 3 min per vessel. The system installed at Upper Bodfish had one 42 in × 60 in work column and one 42 in × 60 in standby column, each loaded with 27 ft³ of ArsenX^{np}. The design flowrate to the system was 38 gpm and the EBCT was 5.3 min. The

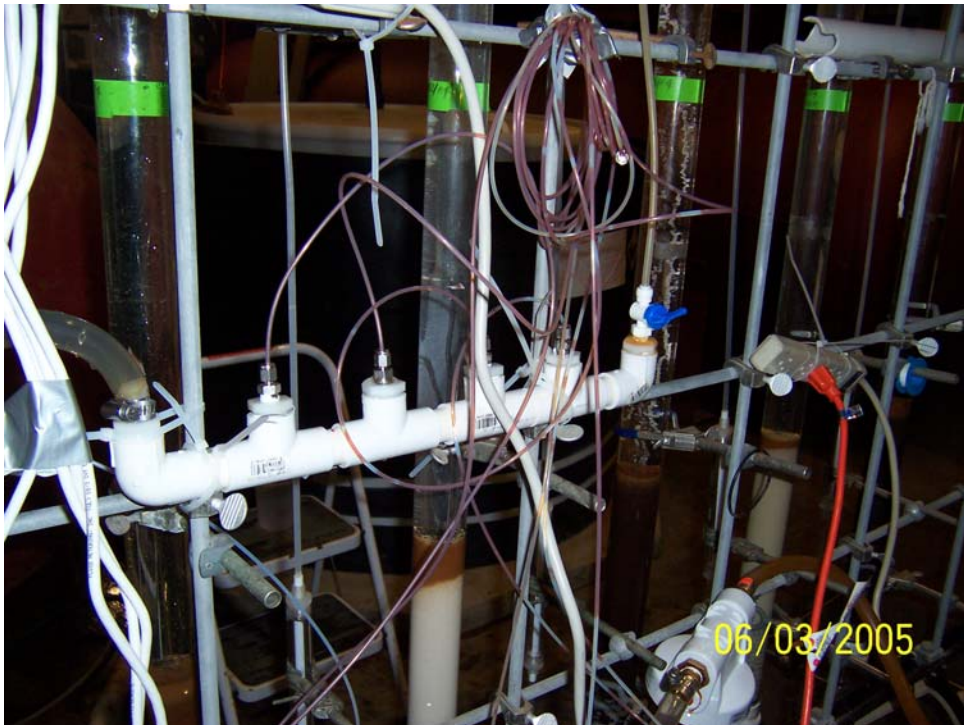

**Figure 3-3. Photographs of Water Delivery System (Including Inlet Piping
Fiber Glass Filter Cartridge [top] and Five-Port Manifold [bottom])
for Licking Valley High School RSSCT Columns**

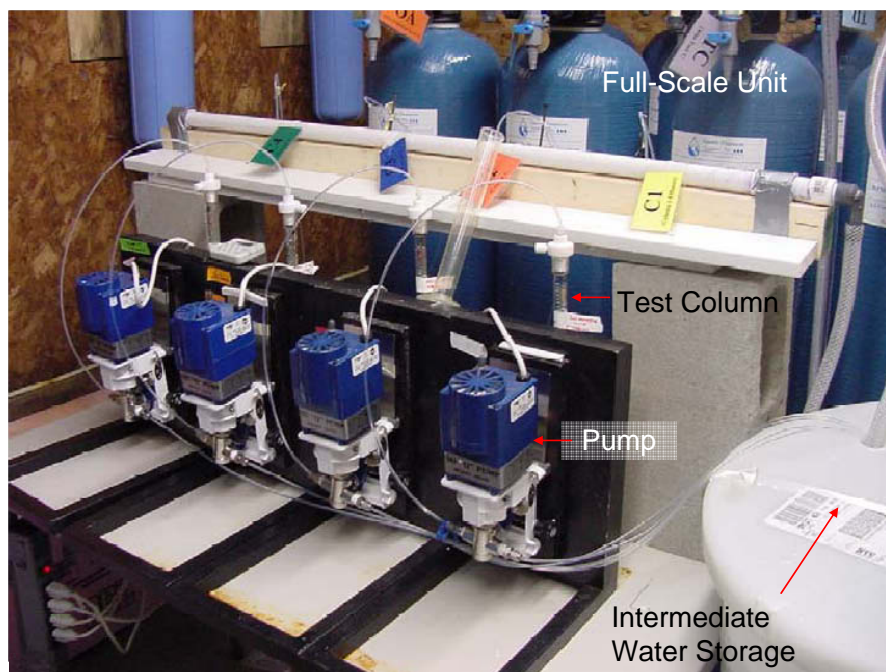

Figure 3-4. Photograph of RSSCT System and Sampling Points at Spring Brook Mobile Home Park in Wales, ME

STMGID system had three parallel 66 in × 72 in columns, each bedded with 80 ft³ of GFH for arsenic and antimony removal. The average system flowrate was 275 gpm and the average EBCT was 6.5 min.

For each laboratory RSSCT test, approximately 500 to 1,000 gal of groundwater was collected from a field location. The groundwater was pumped from a well site, filtered using an in-line, 10- μ m glass fiber cartridge filter, stored in 55-gal drums double-lined with high-density polyethylene (HDPE) containment bags, and shipped with drum liners sealed and drums securely closed via trucks to ASU laboratories. The drums were stored at room temperature in ASU laboratories and sealed until use. In the laboratory, water was supplied to RSSCT columns either directly from the containment bags inside the 55-gal drums or from a 330-gal Nalgene tank with water transferred from the 55-gal drums via a peristaltic pump. RSSCT effluent was discharged to the sewer.

3.6 Sampling and Analyses

Water samples were collected from the inlet to the RSSCT columns and effluent from each RSSCT column over the duration of each test. Figure 3-5 illustrates the schematic arrangement of a typical RSSCT system and sampling points. Unless mentioned otherwise, influent samples were taken directly from the respective influent water containers and effluent samples taken from the exit tubing of each column. Sampling location, frequency, and analytes are presented in Table 3-3. In most cases, samples were collected three times per week during the test. Co-contaminants, such as antimony, uranium, and vanadium, were analyzed if present in inlet water.

Table 3-4 summarizes the analytical methods, sample volumes, container types, preservations required, and holding times for all analytes. Samples for pH and temperature were taken in clean wide-mouth plastic containers and measured immediately using an YSI 60 (by ASU) or WTW Multi 340i (by Battelle)

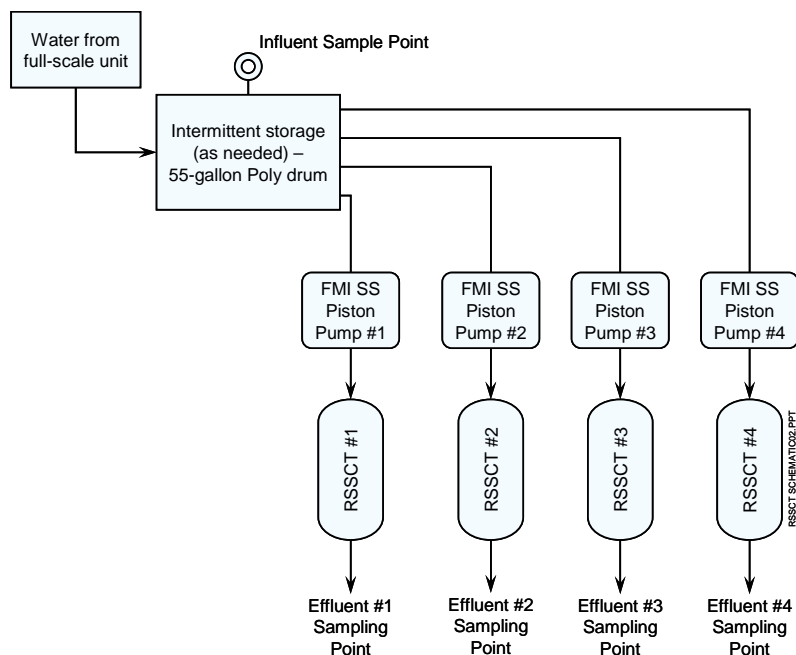

Figure 3-5. Schematic Arrangement for RSSCT System and Sampling Points

Table 3-3. Summary of Sampling Frequency and Analysis

Sample Location	No. of Samples	Sampling Frequency	Analytes
Inlet to RSSCT Columns	3	3 times/week	On-site: pH, temperature Off-site : As, Fe, Mn, Al, Si, P, Ca, Sb ^(a) , U ^(a) , V ^(a)
	1	Weekly	Off-site: Alkalinity, Cl, F, sulfate, TOC
	1	Once during first and last week of test	On-site/Off-site: As speciation
Effluent from Each RSSCT Column	3	3 times/week	On-site: pH, temperature Off-site : As, Fe, Mn, Al, Si, P, Ca, Sb ^(a) , U ^(a) , V ^(a)
	1	Weekly	Off-site: Alkalinity, Cl, F, sulfate, TOC
	1	Weekly	On-site/Off-site: As speciation ^(b)

TOC = total organic carbon

(a) Analyzed only if contaminant present in groundwater

(b) Performed weekly only if arsenite was the predominating arsenic species in influent

handheld meter. Samples for alkalinity, chloride, fluoride, sulfate, and silica were collected in a single 1-L Nalgene bottle without preservative. Samples for total organic carbon (TOC) were collected in 40-mL glass vials containing hydrochloric acid (HCl) for preservation. Samples for metals including As, Fe, Mn, Al, P, Ca, Sb, U, and/or V were collected in 60-mL Nalgene (by ASU) or 250-mL HDPE bottles (by Battelle) containing ultra pure nitric acid (HNO₃) for preservation. Arsenic speciation was performed using arsenic speciation kits prepared at Battelle or ASU laboratories according to the procedures detailed in Appendix A of the EPA-endorsed Quality Assurance Project Plan (QAPP) for this project (Battelle, 2004).

Table 3-4. Analytical Methods, Sample Volumes, Containers, Preservations, and Holding Times

Analyte	Analytical Method	Sample Volume	Sample Container	Preservation	Holding Time
As, Fe, Mn, Al, P, Ca, Sb, U, V	EPA 200.8 (Battelle)	250 mL	HDPE bottles	Cool, 4°C HNO ₃ for pH <2	6 months
	EPA 200.9 and SM3111 (Ca only) (ASU)	10 mL	HDPE bottles	Cool, 4°C HNO ₃ for pH <2	6 months
As Speciation ^(a)	EPA 200.8 (Battelle)	125 mL	Certified clean HDPE bottles	Cool, 4°C HNO ₃ for pH <2	6 months
	EPA 200.9 (ASU)	125 mL	Certified clean HDPE bottles	Cool, 4°C HNO ₃ for pH <2	6 months
pH	YSI 60 handheld meter or equivalent ^(b)	50 mL	Plastic	None	Immediately
Temperature	YSI 60 handheld meter or equivalent ^(b)	50 mL	Plastic	None	immediately
Alkalinity	EPA 310.1 (ASU/AAL)	200 mL	Plastic	Cool, 4°C	14 days
Cl	EPA 300.0 (ASU/AAL)	50 mL	Plastic	Cool, 4°C	28 days
F	EPA 300.0 (ASU/AAL)	50 mL	Plastic	Cool, 4°C	28 days
SO ₄	EPA 300.0 (ASU/AAL)	50 mL	Plastic	Cool, 4°C	28 days
Si	EPA 200.7 (AAL)	200 mL	Plastic	Cool, 4°C HNO ₃ for pH <2	6 months
	SM3111 (ASU)	200 mL	Plastic	Cool, 4°C	28 days
TOC	SM5310B (ASU/AAL)	40 mL	Glass	Cool, 4°C HCl for pH<2	14 days

HDPE = high density polyethylene; SM = Standard Methods (APHA and WEF, 1998); AAL = American Analytical Laboratory (Columbus, OH); TOC = total organic carbon

(a) After on-site speciation using a field speciation sampling kit

(b) Analysis performed on site using an handheld meter

All the samples collected from the laboratory RSSCTs were taken to ASU's laboratories for analyses immediately after sample collection. For the samples collected in the field for off-site analyses, they were packed carefully in sample coolers with wet ice. Samples taken at Valley Vista and LVHS were shipped to ASU for analysis. Samples collected at SBMHP were shipped overnight via FedEx to Battelle. Upon receipt, the respective sample custodians verified that all samples indicated on the chain-of-custody forms were included and intact and the samples were logged into the laboratory sample receipt logs.

The analytical procedures described in Section 4.0 of the EPA-endorsed QAPP were followed by ASU and Battelle ICP-MS laboratories and relevant wet chemistry laboratories. Laboratory quality assurance/quality control (QA/QC) of all methods followed the prescribed guidelines. Data quality in terms of precision, accuracy, method detection limits (MDL), and completeness met the criteria established in the QAPP (i.e., relative percent difference [RPD] of 25%, percent recovery of 75 to 125%, and completeness of 80%). Field measurements of pH and temperature were conducted by each sampler using an YSI 60 or WTW Multi 340i handheld meter, which was calibrated following the procedures provided in the user's manual.

4.0 RESULTS AND DISCUSSION

This section presents the results of RSSCTs conducted with multiple commercially available adsorptive media. The focus is on arsenic removal, although removal of other elements also is discussed to aid in the understanding of arsenic removal.

4.1 Source Water Quality

Table 4-1 presents the inlet water quality data for the seven test locations where pilot/full-scale system results were compared with RSSCT results. The data presented in the table represent the average of RSSCT influent results sampled over the course of each test.

4.2 Valley Vista, AZ (Site 1)

The objectives of the Valley Vista, AZ RSSCT tests were (1) to predict the performance of the full-scale AAFS50 system to remove arsenic, (2) to compare AAFS50 arsenic removal capacity to that of two iron-based media, i.e., E33 and GFH, (3) to evaluate the validity of conducting RSSCTs in the laboratory – a controlled environment – by collecting and transporting water from the field, and (4) to examine the possibility of using a lower ReSc value for the design of RSSCT columns. The comparison of field and laboratory RSSCT results was accomplished by conducting equivalent sets of RSSCT experiments both in the field and in the laboratory.

4.2.1 Field RSSCTs (Site 1F). Figure 4-1 presents arsenic breakthrough curves from the RSSCT columns packed with AAFS50, E33, and GFH adsorptive media. Although scattered rather extensively, the AAFS50 breakthrough data showed a trend of reaching complete arsenic breakthrough after approximately 20,000 BV of throughput. In contrast, effluent arsenic concentrations were $<1 \mu\text{g/L}$ for both E33 and GFH at 20,000 BV and reached $10 \mu\text{g/L}$ after approximately 44,000 and 48,000 BV, respectively. Two data points on the E33 arsenic breakthrough curve had abnormally high arsenic concentrations; both of these samples also contained unusually high iron concentrations. Iron particles containing arsenic might have been sampled following the RSSCT column due to different sampling practices or migration of iron particles out of the packed bed. During the field RSSCT test, the 50-gal Nalgene feed tank was refilled every three days. Natural variations in water quality over the course of the test might have resulted in somewhat different water quality in the feed tank, as evidenced by different pH values, ranging from 7.45 to 8.02, measured in the feed tank. These variations in influent water quality might explain some of the data scattering observed.

While E33 and GFH had very similar arsenic breakthrough curves, these two media exhibited differences in their abilities to remove vanadium (Figure 4-2). While vanadium concentrations following the E33 column reached the influent level of $15 \mu\text{g/L}$ at approximately 56,000 BV, the concentrations following the GFH column remained as low as $1 \mu\text{g/L}$ after 76,000 BV. Differences among the media were less apparent for phosphorous and silica. GFH removed slightly more phosphorous than E33 and AAFS50. All three media had little ability to remove silica, with effluent silica levels reaching the influent level of 18.5 mg/L within the first few thousand BV. It is interesting to note that slightly lower calcium and alkalinity levels and pH values (~ 0.3 pH units) were observed across the E33 and GFH columns during the first few thousand BV of RSSCT operations. This observation was consistent with prior work performed at ASU when calcium silicates formed on the surface of iron (hydr)oxide media during the first part of column operations. AAFS50 had somewhat higher aluminum concentrations in its effluent (6 to $14 \mu\text{g/L}$) compared to the influent concentration of $6 \mu\text{g/L}$ (Figure 4-2). None of the media removed chloride, fluoride, sulfate, or TOC.

Table 4-1. Average Influent Water Quality Data

Analyte	Unit	Site 1F	Site 1L	Site 2	Site 3	Site 4	Site 5	Site 6	Site 7		
		Valley Vista, AZ (Well 2)		Rimrock, AZ (Well #2)	LVHS, OH	Lyman, NE (Well #3)	Upper Bodfish, CA (Well CH2-A)	STMGID, NV (Well #9)	SBMHP, Wales, ME		
		After Oxidation (Part 1)	After Oxidation (Part 2)	Raw Water							
<i>Sampling Date</i>		09/25/04-10/22/04	NA	01/27/05-03/03/05	05/25/05-06/05/05	05/11/05	09/13/05	01/03/06	01/24/06-01/31/06	05/10/06-05/23/06	03/14/06-03/23/06
As(III)	µg/L	0.5		1.0	64.0	<1.0	<1.0	<1.0	0.8 ^(a)	0.1 ^(a)	22.5 ^(a)
As(V)		39.5		61.0	1.5	21.5	43.0	51.0	40.2 ^(a)	40.8 ^(a)	13.0 ^(a)
As(total)		40.0	NA	62.0	65.5	21.5	43.0	51.0	39.2 ^(a)	38.6 ^(a)	34.3 ^(a)
Fe	µg/L	4	NA	3	1,420	38	5	9	<25	<25	<25
Mn	µg/L	0.2	NA	0.4	183	70	1.2	<1.0	<0.1	<0.1	7.1
Al	µg/L	6	NA	2	5	8	4	4	37	28	<10
P	µg/L	19	NA	23	51	54	15	162	33	30	24
Ca	mg/L	40	NA	79	57	77	30	5.1	18	14	16
Sb	µg/L	NA	NA	NA	NA	NA	2.1	13	NA	NA	NA
U	µg/L	NA	NA	NA	NA	40	56	<1	NA	NA	NA
V	µg/L	15	NA	9.0	<1.0	37	0.1	4.0	NA	NA	NA
pH	S.U.	7.8	8.0	7.5	8.1	7.7	7.2	7.4	8.6	8.7	8.5
Temperature	°C	20	15	19	18	17	18	18	10	10	7
Alkalinity	mg/L ^(b)	160	NA	370	505	342	87	83	69	68	64
Cl	mg/L	12	NA	32	9	36	12	10	8	11	8
F	mg/L	0.2	NA	0.1	<0.1	0.1	1.3	<0.1	0.4	0.5	0.5
SO ₄	mg/L	11	NA	11	8	476	39	12	17	19	19
Si (as SiO ₂)	mg/L	18	NA	27	6	NA	8	23 ^(c)	11	10	11
TOC	mg/L	1.9	NA	1.6	NA	3.8	0.4	0.9	NA	NA	NA

NA = Not analyzed; LVHS = Licking Valley High School; SMHP = Spring Brook Mobile Home Park

(a) As(III) and As(V) averaged based on two sets of speciation data; As(total) averaged based on entire dataset

(b) as CaCO₃

(c) Data lower than those measured at influent to full-scale system by Battelle, i.e., 73.6 mg/L (as SiO₂) on average

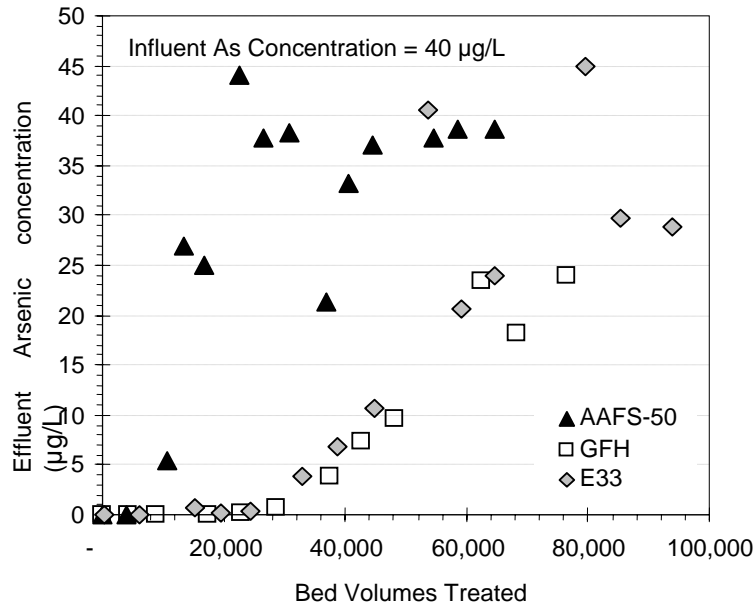

Figure 4-1. As Breakthrough Curves from Field RSSCT Columns at Valley Vista, AZ

4.2.2 Laboratory RSSCTs (Site 1L). Arsenic breakthrough curves from four RSSCT columns (including one each for AAFS50, E33, and GFH, and one additional for E33 with a lower ReSc value) using Valley Vista, AZ source water were obtained in the laboratory and are presented in Figure 4-3. Comparison of these to the field-produced breakthrough curves (Figure 4-1) showed the same pattern of arsenic breakthrough. (Throughput for both E33 and GFH media at 10 µg/L was 40,000 BV, somewhat shorter than the 44,000 and 48,000 BV observed in the field). However, the curves produced in the laboratory were much smoother than those from the field. The smoother curves obtained might be caused by the use of only two separate batches of water in the laboratory, compared to the many batches of influent water refilled every three days in the field. Thus, laboratory-operated RSSCT columns would have more consistent pH, temperature, arsenic concentration, and other constituents in the feed water compared to the field-operated RSSCT columns.

Figure 4-4 overlays the field and laboratory breakthrough curves for both E33 and GFH media. At a 95% confidence level and excluding the two E33 outliers in the field, there was no statistical difference between the two sets of curves. Therefore, transporting groundwater to a centralized laboratory for RSSCT tests would be as valid as conducting the tests on site, provided that representative samples may be collected and transported to the laboratory.

To conduct RSSCTs in the laboratory, it would be beneficial if the volume of water to be collected and transported could be significantly reduced. Two RSSCT columns packed with E33, therefore, were conducted with a ReSc value of either 2,000 or 500. A value of 500 reduces the volume of water needed for treating the same number of bed volumes by a factor of four. As shown in Figure 4-3, arsenic breakthrough at 10 µg/L occurred at approximately 26,000 BV with a ReSc value of 500, compared to approximately 40,000 BV with a ReSc value of 2,000. Thus, reducing the ReSc value from 2,000 (equivalent to a Reynolds number of 2.2) to 500 would not be recommended for E33. Similar work was previously performed for GFH and led to a similar conclusion (Badruzzaman, 2005).

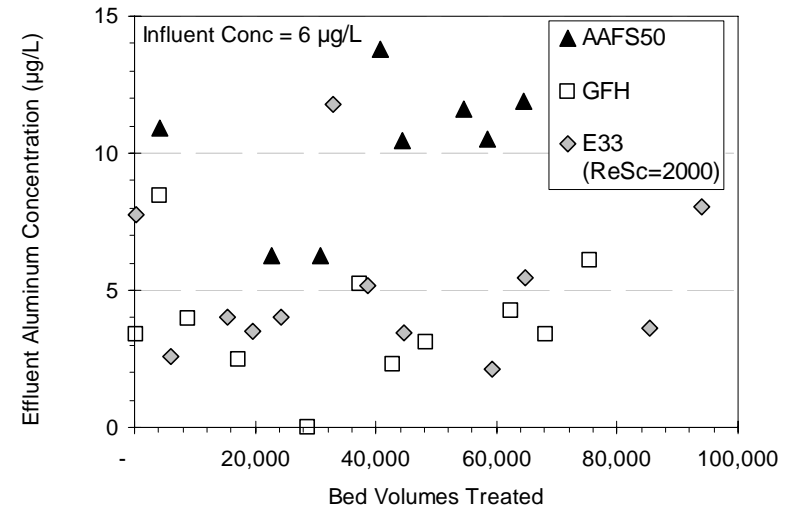
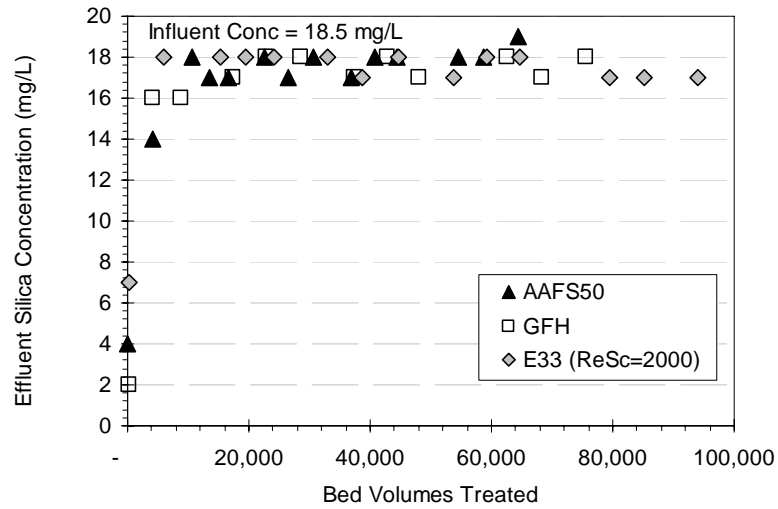
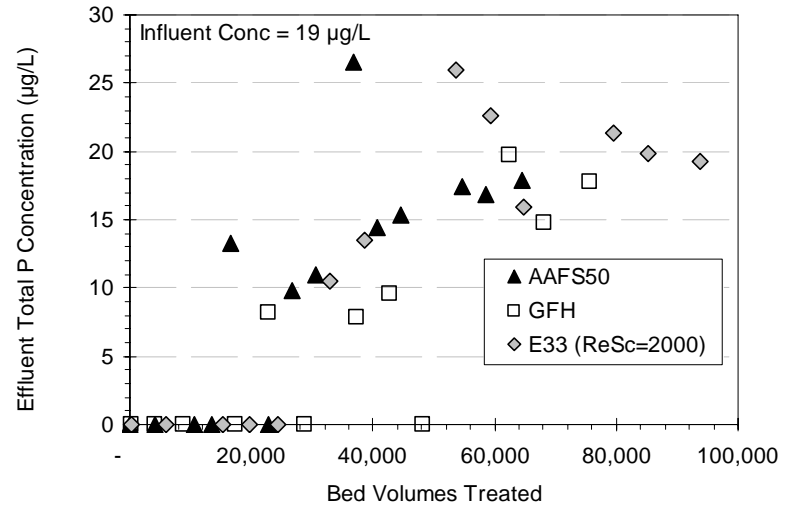
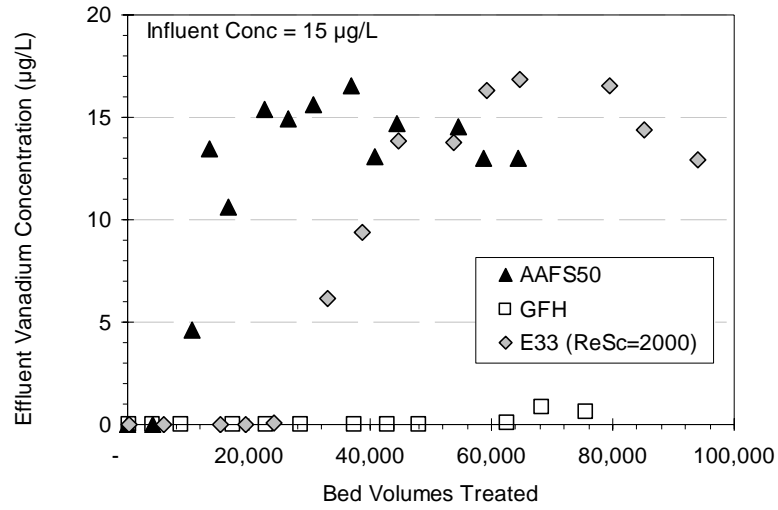

Figure 4-2. Breakthrough of V, P, Si, and Al from Field RSSCT Columns at Valley Vista, AZ

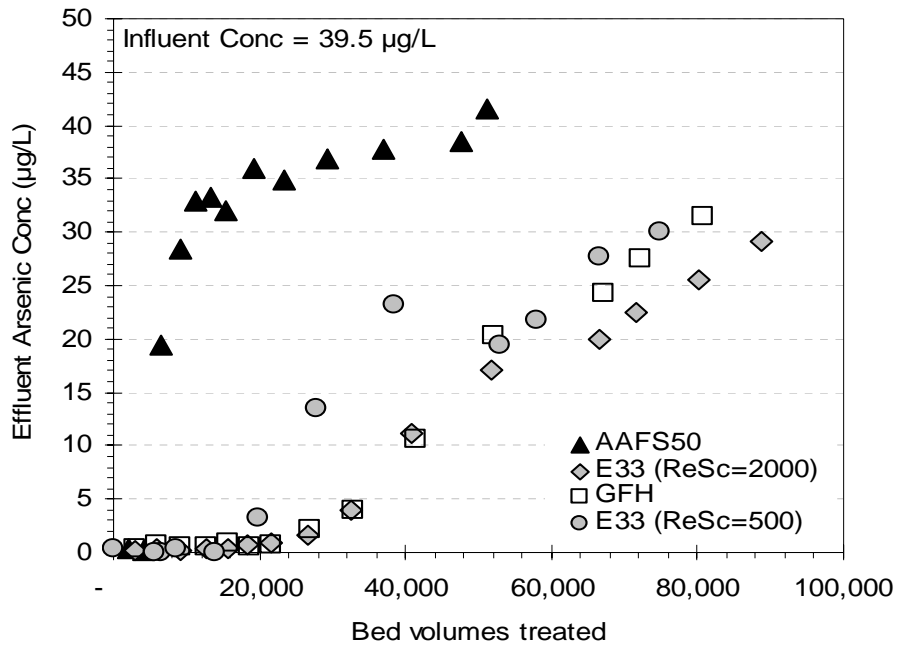

Figure 4-3. As Breakthrough Curves from Valley Vista, AZ Laboratory RSSCT Columns

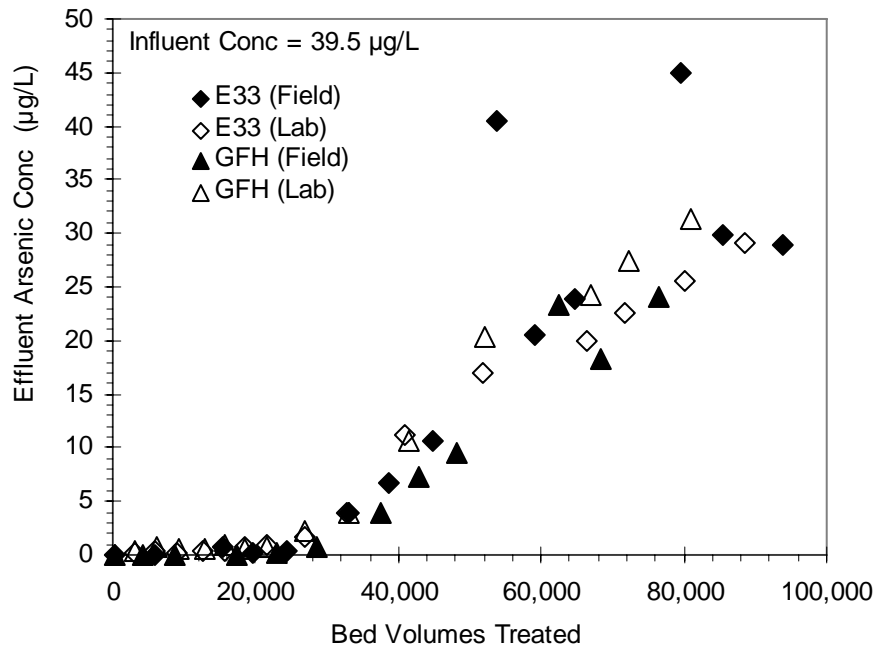

Figure 4-4. Comparison of Field and Laboratory RSSCT Results for Valley Vista, AZ

4.2.3 Comparison of Field/Laboratory RSSCT and Full-Scale System Results. Figure 4-5 overlays and compares the arsenic breakthrough curves for AAFS50 from the field and laboratory RSSCT columns and the full-scale system. Although the lab and field RSSCT data were scattered more than those of the full-scale system, both of them predicted rapid arsenic breakthrough across the lead tank of the full-scale system at 10 µg/L between 5,000 and 10,000 BV. Note that for the breakthrough curve produced by the full-scale treatment system, acid addition was applied after approximately 30,000 BV of system operations, thereby reducing the pH of the influent and improving arsenic removal (data not plotted on the figure). pH adjustment was not applied to the RSSCT columns, thus no enhanced arsenic removal was observed.

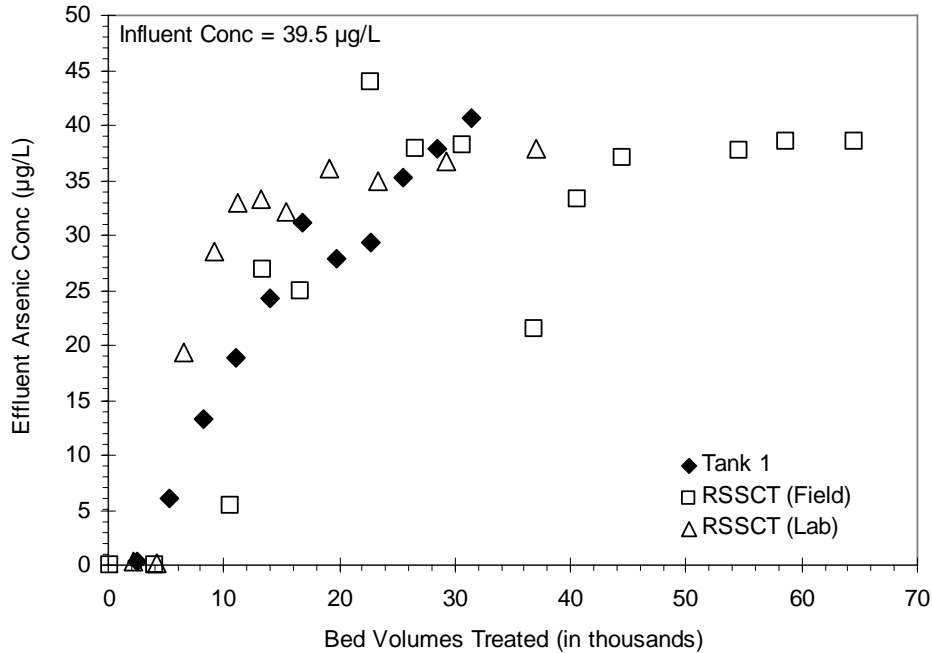

Figure 4-5. Comparison of Field/Laboratory RSSCTs with Full-Scale AAFS50 System at Valley Vista, AZ

4.3 Rimrock, AZ (Site 2)

The purpose of the Rimrock, AZ tests was to compare arsenic breakthrough from laboratory RSSCT columns against the full-scale E33 system. To compliment the results of the Valley Vista tests, RSSCT columns using AAFS50, GFH, and ArsenX^{np} also were performed for this site. Similar to the Valley Vista tests, the effect of a lower ReSc value on arsenic breakthrough also was investigated.

4.3.1 Arsenic Removal. Figure 4-6 presents arsenic breakthrough curves from E33, GFH, and AAFS50 RSSCT columns and from the lead vessel of the full-scale E33 system. The E33 and GFH RSSCT columns were operated for nearly 100,000 BV before shutdown. Arsenic broke through at 10 µg/L from the E33 RSSCT column after approximately 40,000 BV, which was nearly identical to that through the full-scale system. GFH performed better than E33, removing arsenic to the 10 µg/L level for about 52,000 BV. AAFS50 showed comparatively little arsenic removal capacity, reaching 46 µg/L (the first data point) at approximately 8,000 BV.

In addition to the two iron-based and one iron-modified alumina-based media, an RSSCT column packed with ArsenX^{np} containing 25% iron was tested. The arsenic breakthrough curve for ArsenX^{np} is presented in Figure 4-6 and compared with those of other adsorptive media. ArsenX^{np} exhibited a sharp arsenic breakthrough at 10 µg/L after approximately 30,000 BV, slightly less than the 40,000 BV for E33.

An additional E33 RSSCT column also was conducted to evaluate an ReSc value of 1,000 (data in Figure 4-6 used a ReSc value of 2,000 for E33 and other media). Similar to the laboratory results using Valley Vista source water, the lower ReSc value resulted in earlier arsenic breakthrough and was, therefore, not valid (especially given the excellent comparison between the RSSCT and the full-scale system results). Interestingly, a ReSc value of 500 for E33 using Valley Vista source water had approximately the same net effect as a value of 1,000 using Rimrock source water; both shortened the number of BV at 10 µg/L by approximately 45 to 50%. This suggests that the length of the packed bed using a lower ReSc value is not long enough to capture the mass transfer zone.

To summarize, the full-scale and RSSCT arsenic breakthrough curves for E33 were nearly identical, thus supporting the use of the RSSCT approach to predict the full-scale performance of iron-based adsorptive media. The iron-based adsorptive media treated a significantly larger number of BV than alumina-based media. Furthermore, GFH outperformed E33 for arsenic removal by about 12,000 BV. ArsenX^{np} media was found to have a treatment capacity much higher than that of AAFS50, but less than GFH and E33. Noteworthy of the ArsenX^{np} media is the steepness of its arsenic breakthrough curve compared to that of an iron-based media. This suggests relatively fast movement of the mass transfer zone through the packed resin-based media bed.

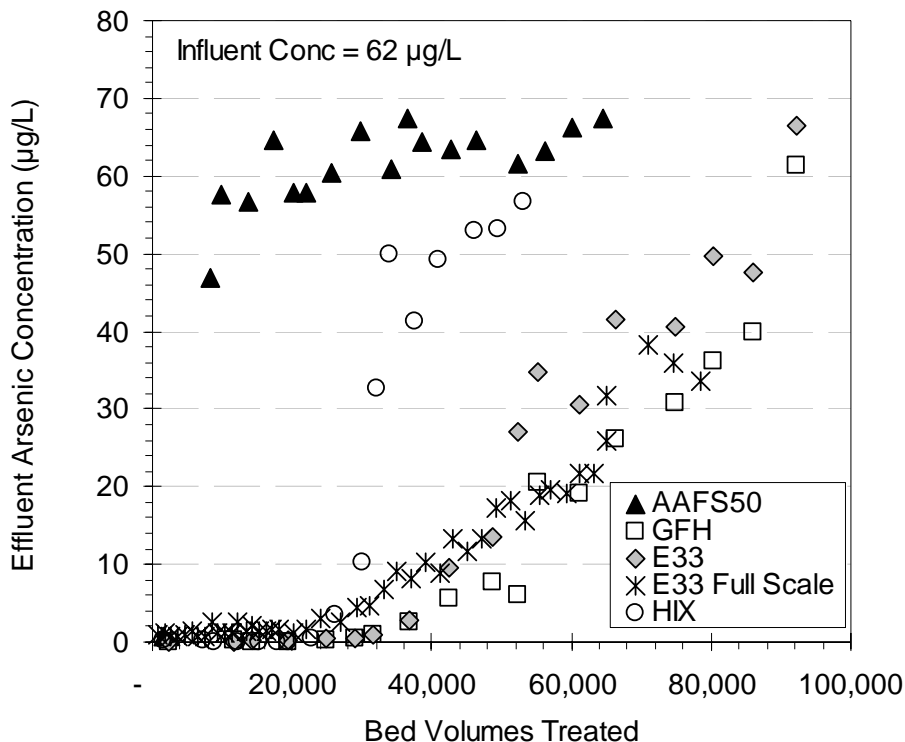

Figure 4-6. As Breakthrough Curves from Laboratory RSSCT Columns and Full-Scale E33 System at Rimrock, AZ

4.3.2 Removal of Other Elements. Breakthrough curves for vanadium, phosphorous, silica and aluminum are presented in Figure 4-7. Similar to the Valley Vista RSSCT results, GFH removed nearly all vanadium throughout the entire RSSCT test. However, complete vanadium breakthrough (i.e., full exhaustion of vanadium adsorption capacity) was observed at approximately 64,000 BV for E33 and less than 20,000 BV for AAFS50. All media removed some phosphorous, with iron-based media having much more capacities than alumina-based media. Some silica was removed immediately after the column runs but it reached nearly complete breakthrough soon after. Aluminum was released from the AAFS50 media throughout the entire RSSCT run, producing 9 to 20 µg/L of aluminum in the column effluent. The iron-based media did not release aluminum. There was no removal or release of fluoride, chloride, or sulfate by any of the media.

4.4 Licking Valley High School in Newark, OH (Site 3)

A unique characteristic of the LVHS groundwater was that arsenic was present almost entirely in the reduced form (Table 4-1). The objective of the RSSCT tests was to compare RSSCT results with those of the previous pilot-scale tests on several adsorptive media for As(III) removal. Therefore, RSSCTs were conducted on-site to ensure that water containing As(III) was fed to the columns for testing.

4.4.1 Comparison of As(III) Removal by RSSCT and Pilot-Scale Columns. RSSCTs were conducted with AAFS50, GFH, E33 and ArsenX^{np}. As shown in Figure 4-8, arsenic broke through at 10 µg/L after approximately 2,500 BV for AAFS50, 11,000 BV for E33, and > 23,000 BV for GFH. Although the RSSCTs predicted the same order of performance as the pilot tests, they appeared to have significantly over-predicted the run length for all media. For example, the corresponding BV obtained from the pilot-scale tests was 650 BV for AAFS50, 6,500 BV for ArsenX^{np}, 4,700 BV for E33, and 21,000 BV for GFH. The discrepancies observed could be due to a number of factors, including varying influent water quality, different loading rates, and improper use of scaling relationship for As(III) removal. The average influent As(III) and As(V) concentrations through the duration of the tests from May 25 to June 5, 2005 were 64.0 and 1.5 µg/L, respectively, which were comparable to the historical data since 2000. The average influent iron concentration of 1,420 µg/L was within the range of 1,077 to 1,725 µg/L reported historically since 2000. Since the samples were not filtered on site, it was suspected that the soluble iron (not measured) might be lower due to aeration and precipitation of some soluble iron in the leaky water supply/delivery system, as evidenced by the iron precipitates found in the plastic and Teflon[®] tubing, in-line glass fiber cartridge filter, and the five-port manifold as shown in Figure 3-3. Nonetheless, partial aeration of the influent water did not appear to have impacted the amount of As(III) in that water.

The loading rate for the pilot tests was 1.5 gpm/ft² (or 3.7 m/hr), which was significantly lower than that commonly used for full-scale systems (i.e., 4 to 8 gpm/ft² or 9.8 to 19.6 m/hr) for which the RSSCTs were initially validated against. The lower loading rate was caused by the pilot column design, which used a 2 in diameter by 12 in long media bed to achieve an intended EBCT of 5 min. To maintain this EBCT but increase the loading rate (for example, three times) would require the bed depth to increase three times. As a result, the throughput to reach the 10 µg/L breakthrough level should remain the same even with a three-time higher loading rate.

It is possible that the logarithms developed for scaling down a pilot- or a full-scale arsenic removal system may be applied only to arsenate, which is a charged species as discussed in Section 1.1.1. Arsenite, at an average pH value of 8.1 at LVHS, is not charged and, thus, may involve a different set of transport mechanisms for its adsorption on porous metal (hydr)oxides. Future studies are warranted to determine how different arsenic species may affect the validity of the scaling equations discussed in Section 1.1.3 and if any modifications would be required to better predict pilot- and full-scale performance involving As(III).

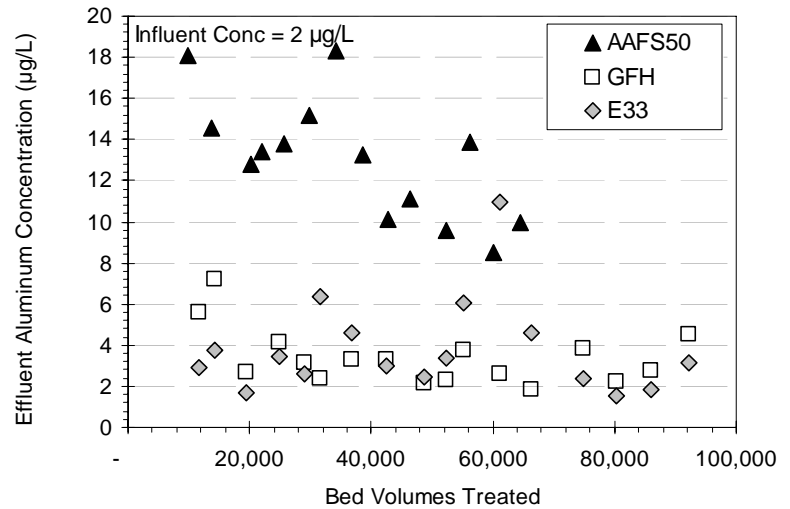
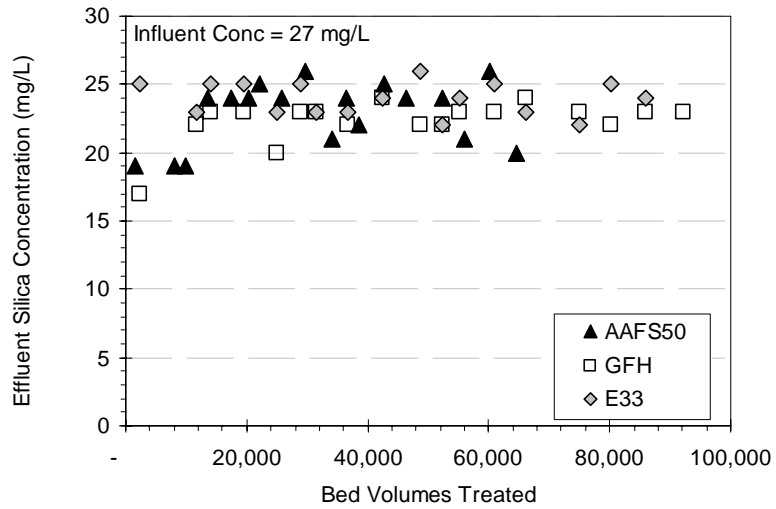
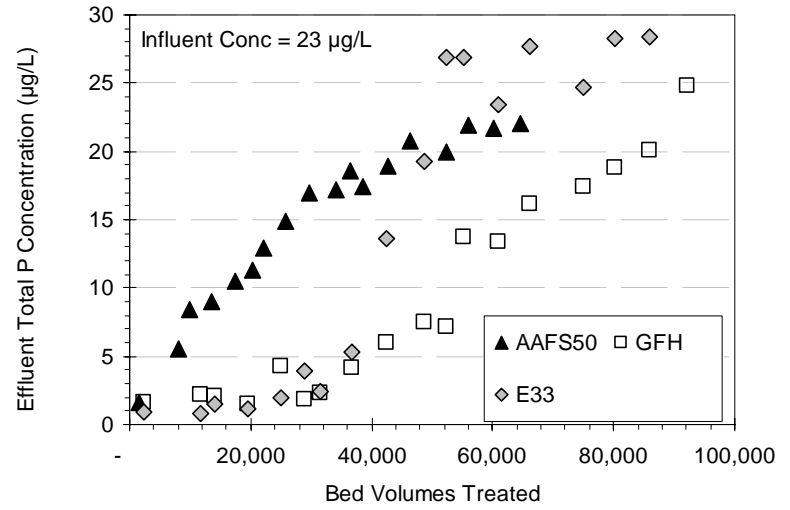
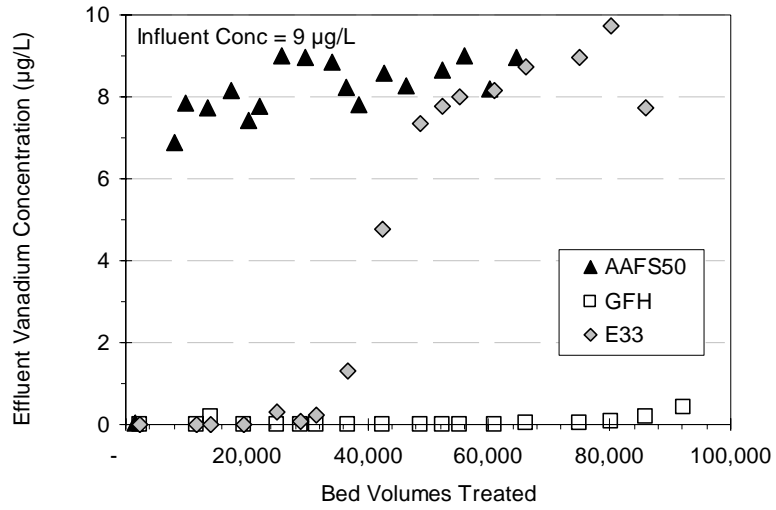

Figure 4-7. Breakthrough of V, P, Si, and Al from Rimrock, AZ Laboratory RSSCT Columns

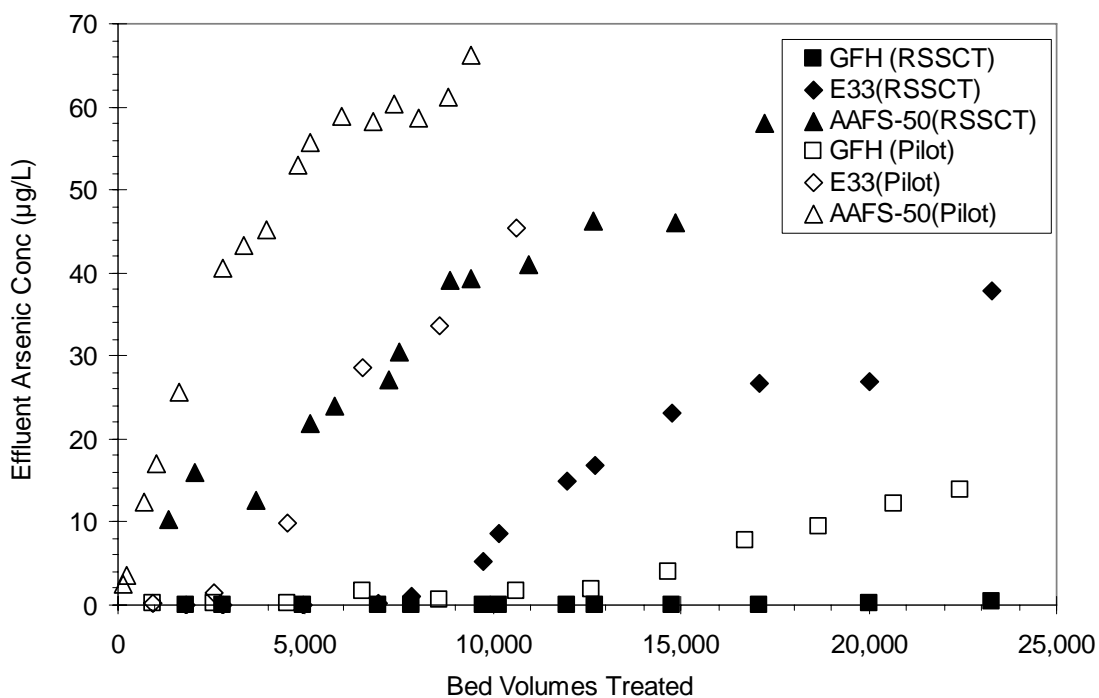

Figure 4-8. Comparison of RSSCT and Pilot Results at Licking Valley High School in Newark, OH

4.4.2 Removal of Other Elements. Figure 4-9 presents the breakthrough curves for phosphorous, silica, iron, and aluminum. Vanadium concentrations at this site were $<1 \mu\text{g/L}$ and, therefore, not plotted. Phosphorous was removed by all media from 51 to $<4 \mu\text{g/L}$. The average influent silica concentration was 6 mg/L, while the effluent silica concentrations varied between 1 and 8 mg/L and did not exhibit a clear breakthrough pattern. The average influent iron concentration was 1,420 $\mu\text{g/L}$. As shown previously by the corresponding pilot-scale tests, iron, existing almost entirely in the soluble form, was removed initially by all media and began to break through after certain run length. Iron concentrations remained extremely low for E33 and GFH even after 20,000 BV. It is not clear how the iron removed would affect arsenic removal over time.

4.5 Village of Lyman in NE (Site 4)

Groundwater at the Lyman, NE arsenic removal demonstration site contained naturally occurring arsenic and uranium, both above their respective MCLs of 10 and 30 $\mu\text{g/L}$. The water also had high concentrations of alkalinity (342 mg/L [as CaCO_3]) and sulfate (476 mg/L). The vendor selected for the demonstration study proposed to install an adsorption system using MetsorbG, a titania-based media manufactured by Graver/Hydroglobe, to remove both arsenic and uranium. Before installing the system, a decision was made to use RSSCTs to test the efficiency of MetsorbG and three other adsorptive media (i.e., E33, ArsenX^{np}, and Adsorbisia GTO) to remove uranium in concert with arsenic. Therefore, the RSSCTs conducted on Lyman, NE water had the primary goal of evaluating the co-removal of arsenic and uranium. A secondary goal was to evaluate an approach (i.e., by reducing ReSc values) that could help reduce operational problems associated with the titania-based media tested; the operational problems were encountered when the RSSCT columns experienced increased pressure drop and lost $> 40\%$ of the beds resulting from bed compaction and/or loss of media into the RSSCT effluent.

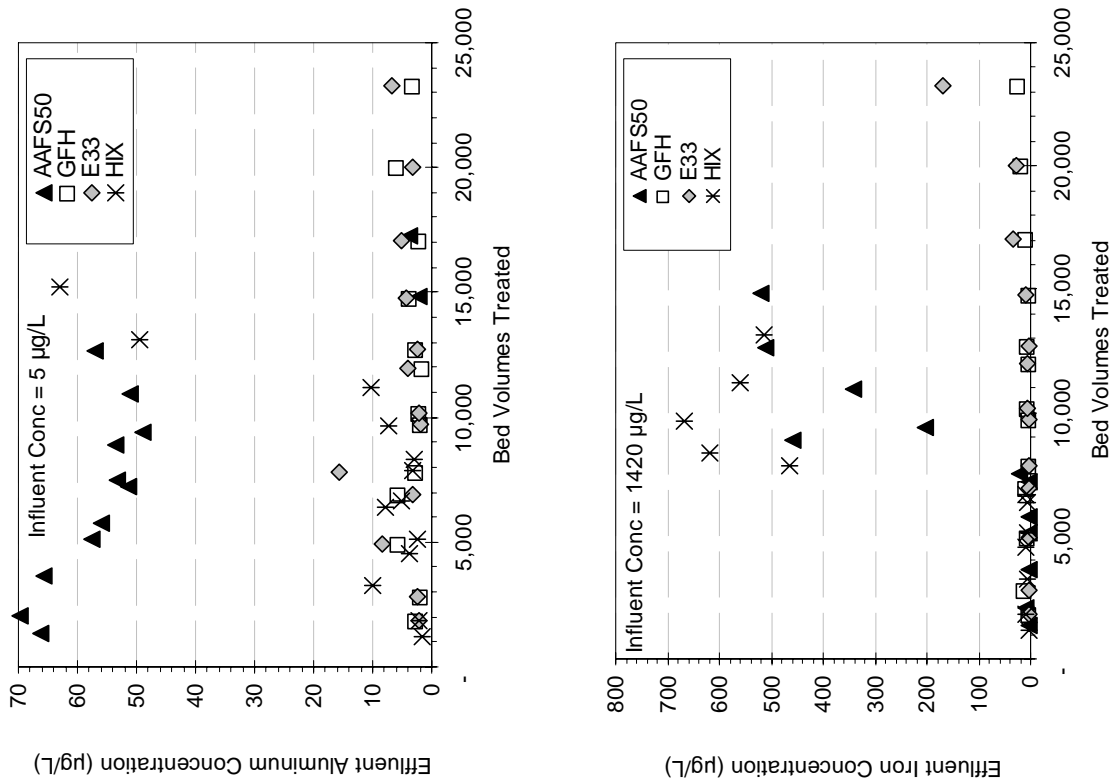

Figure 4-9. Breakthrough of P, Si, Fe, and Al from Field RSSCT Columns at Licking Valley High School in Newark, OH

4.5.1 Arsenic Removal. Four adsorptive media were evaluated, including two titania-based media, i.e., MetsorbG and Adsorbsia GTO, and E33 and ArsenX^{np}. E33 exhibited the best arsenic removal (approximately 25,000 BV at 10 µg/L), followed closely by Adsorbsia GTO (approximately 22,000 BV) and more distantly by ArsenX^{np} and MetsorbG (approximately 16,000 BV) (Figure 4-10). The Adsorbsia GTO and MetsorbG media were run at ReSc values of 2000 (Figure 4-10) and 1000 (comparison in Figure 4-11). Unlike the iron-based media studied for Valley Vista and Rimrock, reducing the ReSc value from 2,000 to 1,000 for titania-based media had minimal effect on the resulting arsenic breakthrough curves, suggesting that the length of the mass transfer zone probably is shorter with Adsorbsia GTO and MetsorbG than with E33 and GFH.

4.5.2 Uranium Removal. Of particular interest in the Lyman water was the co-occurrence of arsenic and uranium above their MCLs. Figure 4-12 presents uranium breakthrough curves along with those for vanadium, iron, and manganese. Contrary to the claims made by the vendor, MetsorbG did not show much adsorptive capacity (i.e., < 500 BV to reach 30 µg/L) for uranium. The other titania-based media, Adsorbsia GTO, and the only iron-based media tested, E33, also did not show any adsorptive capacity for uranium. ArsenX^{np}, however, exhibited a significant capacity for uranium, treating approximately 20,000 BV before reaching the 30-µg/L MCL. A chromatographic-like peaking of uranium in the column effluent occurred between 20,000 to 50,000 BV, where the uranium concentrations in the RSSCT effluent were greater than those in the influent. This suggests that the uranium previously removed was displaced into the column effluent by other anionic species with higher selectivity or higher concentrations, such as sulfate (476 mg/L). It is hypothesized that uranium was removed mainly by the anionic resin via an ion exchange process and that competing anions, such as sulfate, might have displaced the uranium on the resin.

As noted above, the groundwater at this site contained a relatively high level of alkalinity (i.e., 342 mg/L [as CaCO₃]). Uranium might have reacted with carbonate to form uranium carbonate complexes (Fuller et al., 2002; Gu et al., 2004), thus limiting its adsorbability on titanium oxide surface.

4.5.3 Removal of Other Elements. As also shown in Figure 4-12, the two titania-based media removed significantly more vanadium than E33 or HIX did. Vanadium began to break through from E33 and ArsenX^{np} at approximately 17,000 BV, but did not breakthrough from MetsorbG and Adsorbsia GTO until approximately 44,000 BV. No discernable trends in iron removal were observed. Manganese exhibited unique trends as its removal began to increase later during the tests (Figure 4-12). During tests at the other sites, low manganese concentrations precluded any discernable trends. At this site, GTO and MetsorbG removed a significant portion of the manganese, while E33 and HIX did not.

4.6 Upper Bodfish in Lake Isabella, CA (Site 5)

Similar to Lyman, NE, the groundwater from Upper Bodfish, CA contained arsenic and uranium at 43 and 56 µg/L, respectively, which were above the respective MCLs. Therefore, the main objective of the RSSCT tests was to evaluate media capacities (including ArsenX^{np}, MetsorbG, and Adsorbsia GTO) to remove both arsenic and uranium. The data produced were used to assess the applicability of installing a full-scale ArsenX^{np} arsenic removal system, as proposed by the selected vendor for this arsenic removal demonstration site. The average alkalinity value of the groundwater was 87 mg/L (as CaCO₃ at pH = 7.2) and the average sulfate concentration was 39 mg/L, which were considerably lower than the 342 mg/L (as CaCO₃ at pH = 7.7) and 476 mg/L present in the Lyman groundwater. Another objective of these RSSCTs was to evaluate the capacity of two iron-based media, i.e., E33 and GFH, to remove arsenic and uranium. Due to pressure buildup and media compaction with the titania-based media, only data from the RSSCT columns scaled to a 2.5 min full-scale EBCT (rather than the 5.3 min EBCT) were included in Table 3-2 and discussed in Sections 4.61 and 4.62.

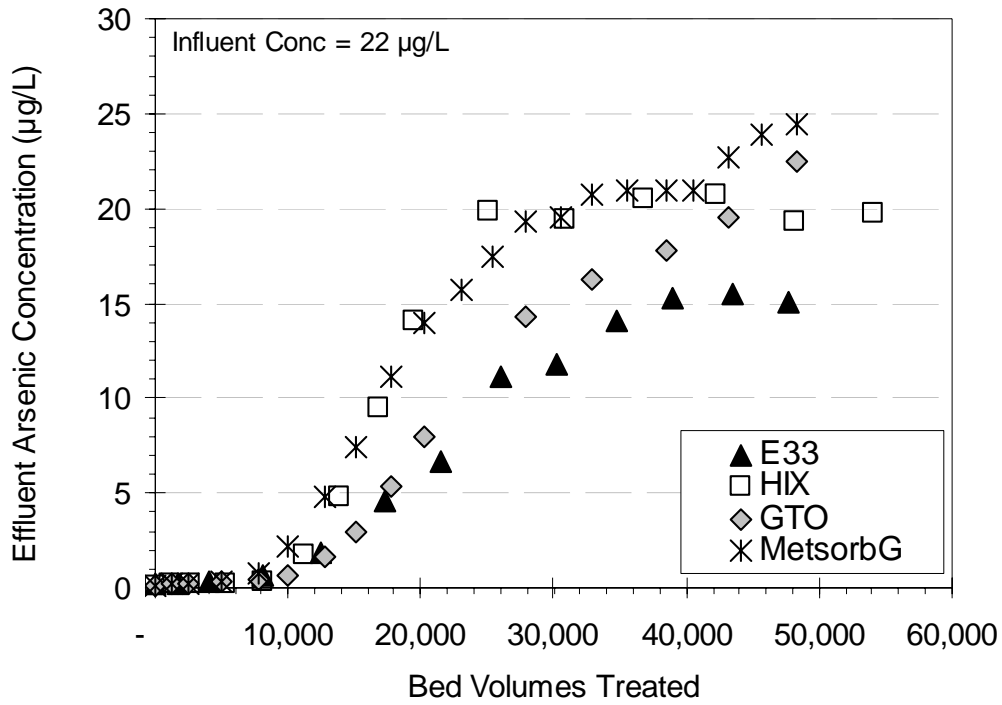

Figure 4-10. Arsenic Breakthrough Curves from Lyman, NE Laboratory RSSCT Columns

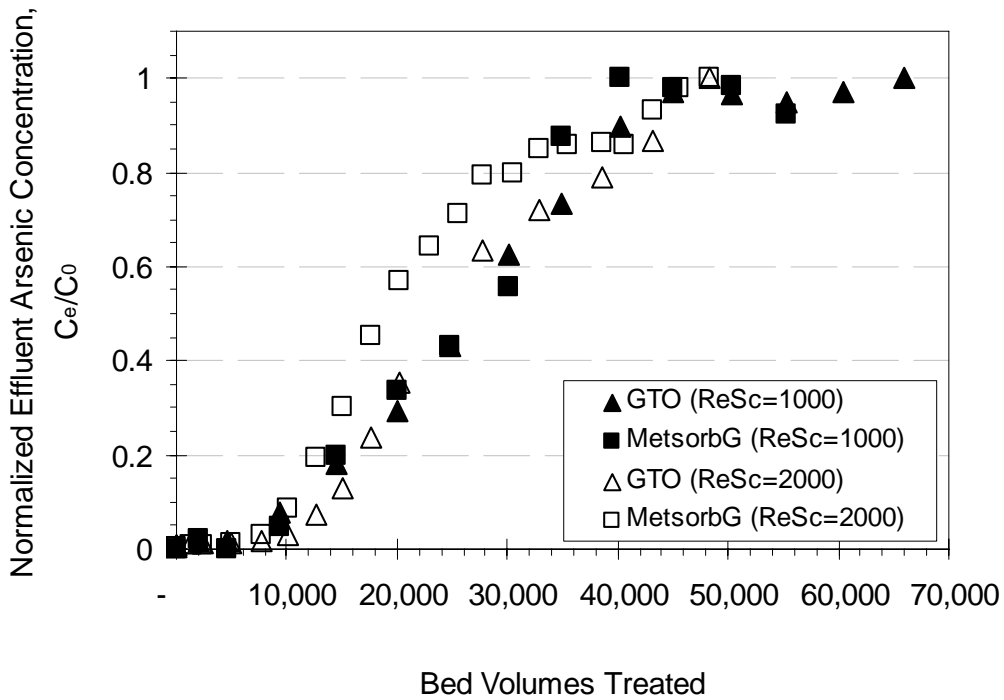

Figure 4-11. Comparison of Two ReSc Values on Lyman, NE Titania-Based Media RSSCTs

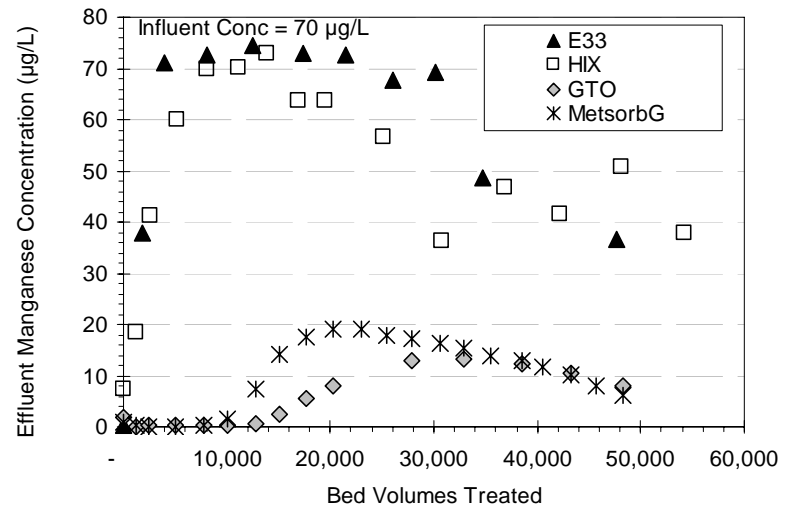
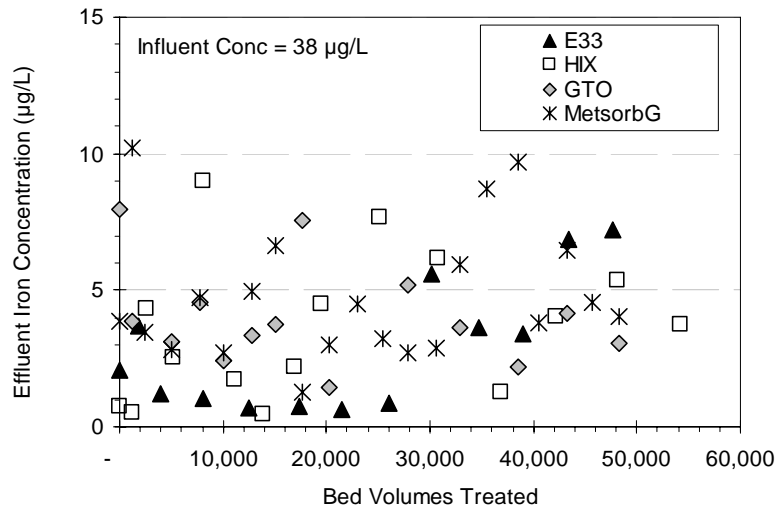
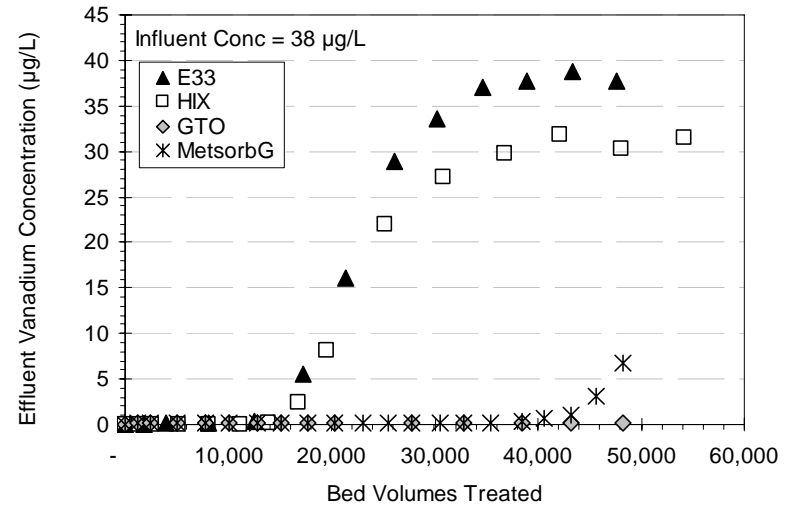
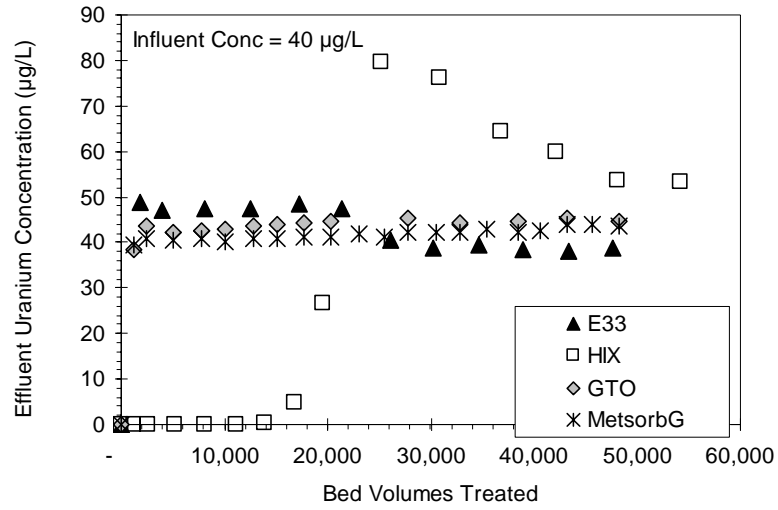

Figure 4-12. Breakthrough of U, V, Fe, and Mn from Lyman, NE Laboratory RSSCT Columns

4.6.1 Arsenic Removal. Figure 4-13 presents the arsenic breakthrough curves from ArsenX^{np}, E33, GFH, MetsorbG, and Adsorbsia GTO. All RSSCT columns were scaled to a 5.3 min full-scale EBCT except for the two titania-based media, which were scaled to 2.5 min. As expected, the two iron-based media, i.e., GFH and E33, exhibited the best arsenic removal, with the run length extending to approximately 50,000 BV by GFH and 44,000 BV by E33 at 10 µg/L. ArsenX^{np} reached the 10 µg/L level at approximately 28,000 BV. Similar to what was observed at Rimrock and LVHS (Figures 4-6 and 4-8), ArsenX^{np} exhibited a sharp breakthrough curve. MetsorbG and Adsorbsia GTO had the lowest adsorptive capacities, reaching 10 µg/L at approximately 21,000 and 16,000 BV, respectively. Once again, different ReSc values for the titania-based media did not significantly influence arsenic breakthrough; arsenic broke through from both Adsorbsia GTO RSSCT columns at about 15,000 to 17,000 BV (Figure 4-14). Lowering the ReSc value from 2000 to 1000 alleviated the excess pressure problem in the Adsorbsia GTO RSSCT column, while producing equivalent arsenic breakthrough curves.

4.6.2 Uranium Removal. Figure 4-15 presents the uranium breakthrough curves from ArsenX^{np}, E33, GFH, and MetsorbG. As shown in the figure, ArsenX^{np} continued to remove uranium to less than 1 µg/L as sampling was discontinued at about 50,000 BV when arsenic, which was monitored daily, had completely broken through from the column. It is well known that anionic exchange resin (the resin matrix used for producing ArsenX^{np}) has very large exchange capacity for uranium, especially when the concentrations of competing anions, such as sulfate and bicarbonate/carbonate, are low in the influent water. As noted above, the Upper Bodfish groundwater had only 39 mg/L of sulfate and 87 mg/L (as CaCO₃) of alkalinity, compared to the 476 and 342 mg/L, respectively, found in the Lyman groundwater. This probably explains why the chromatographic-like uranium peaking observed previously for the Lyman groundwater did not occur for the Upper Bodfish groundwater.

Effluent uranium concentrations from GFH and E33 exceeded the 30 µg/L MCL at 25,000 and 12,000 BV, respectively. Sampling of effluent uranium concentrations from the MetsorbG RSSCT column discontinued after approximately 24,000 BV due to excessive pressure accumulation and media compaction in the column, even though the column was designed using a reduced ReSc value of 1,000. At 24,000 BV, the effluent uranium concentration was 24 µg/L, indicating higher adsorptive capacity than that of GFH and E33. Additional RSSCTs conducted with two separate ReSc values (i.e., 1,000 and 2,000) for Adsorbsia GTO indicated that uranium breakthrough at 30 µg/L would not occur until 26,000 (with ReSc = 2,000) to 40,000 BV (with ReSc = 1,000) of operation (Figure 4-16). Therefore, while scaling Adsorbsia GTO RSSCT columns to lower ReSc values could produce matching arsenic breakthrough curves, this approach might not be valid for predicting uranium adsorption.

Unlike the observations made for the Lyman groundwater, the RSSCT tests on the Upper Bodfish groundwater demonstrated that several media were capable of removing arsenic and uranium simultaneously. Whereas ArsenX^{np} was the only media capable of remove uranium from the Lyman groundwater, the other iron- and titania-based media exhibited significant removal capacities for uranium from the Upper Bodfish groundwater. ArsenX^{np} removed uranium better than the other adsorptive media, although GFH or E33 removed arsenic better. The ArsenX^{np} RSSCT predicted rather accurately the performance of the full-scale system, which reached the arsenic MCL at approximately 33,000 BV and never had any detectable uranium breakthrough (i.e., < 0.1 µg/L). Table 4-2 summarizes the number of BV for each media before exceeding the respective MCLs for uranium and arsenic. E33 and GFH removed comparable amounts of arsenic, but GFH removed more uranium than E33.

As uranium is removed from the source water, it is concentrated onto the adsorptive media and may ultimately affect the transportation and disposal of the spent media. Accumulation of over 0.05% (by weight) of uranium on a media, known as “Unimportant Limit”, may require a licensed broker to transport the spent media to a special disposal facility, such as an U.S. Ecology burial site in Grandview,

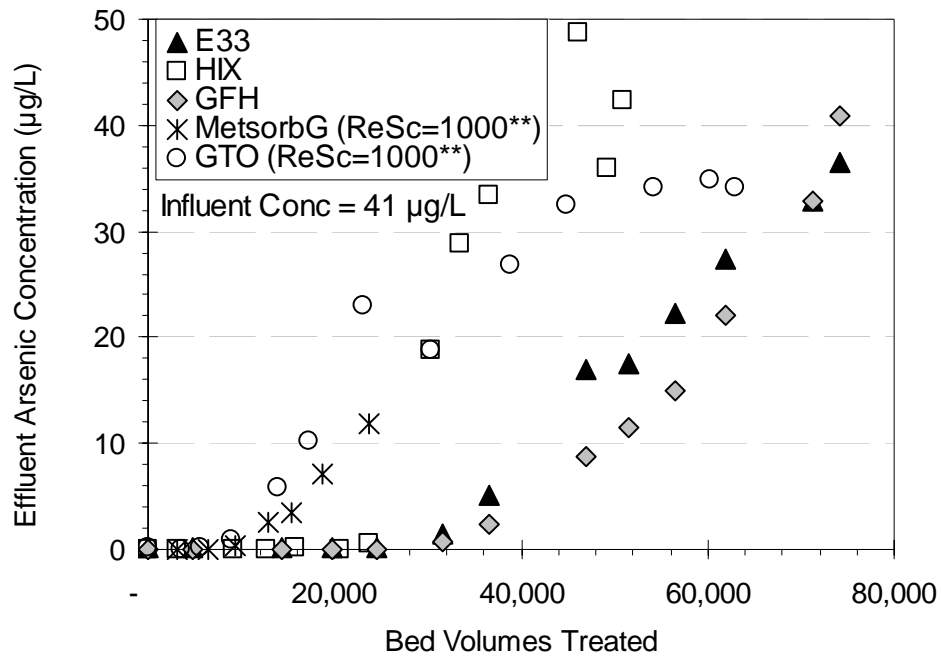

Figure 4-13. Arsenic Breakthrough Curves from Upper Bodfish, CA Laboratory RSSCT Columns

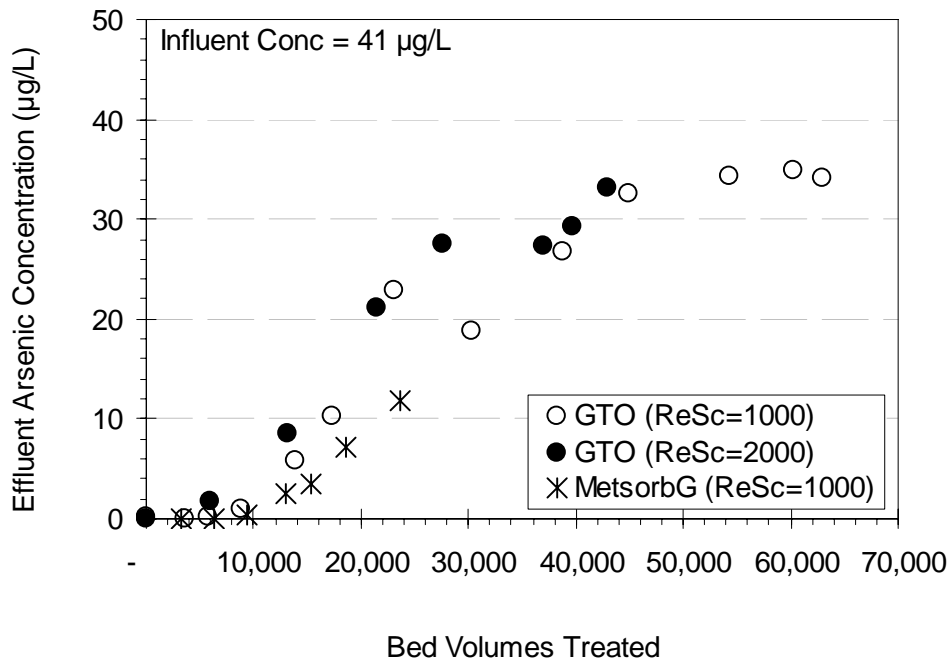

Figure 4-14. Comparison of Two ReSc Values on Upper Bodfish, CA Titania-Based Media RSSCTs

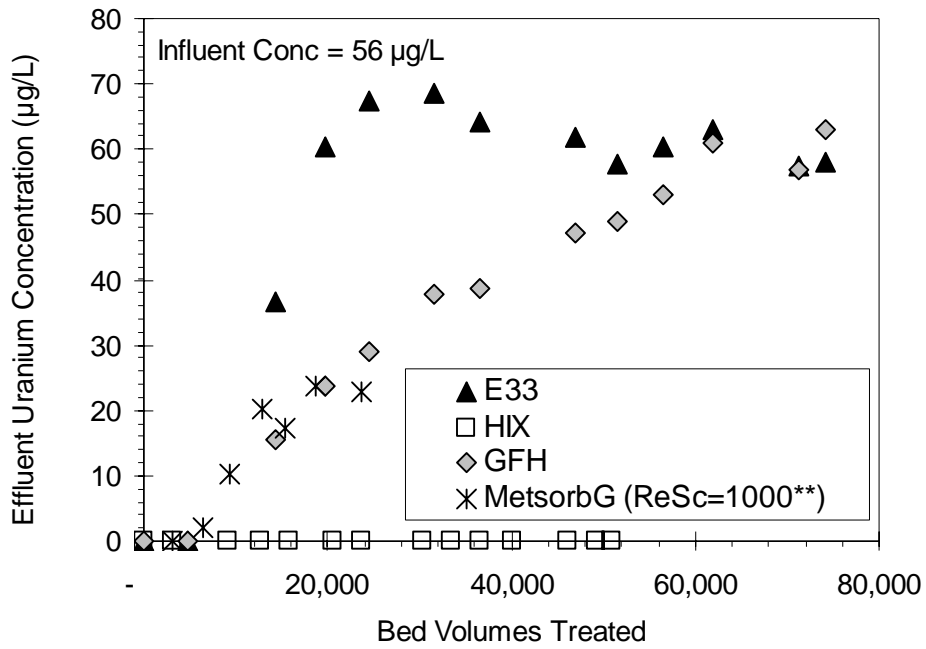

Figure 4-15. Uranium Breakthrough from Upper Bodfish, CA Laboratory RSSCT Columns

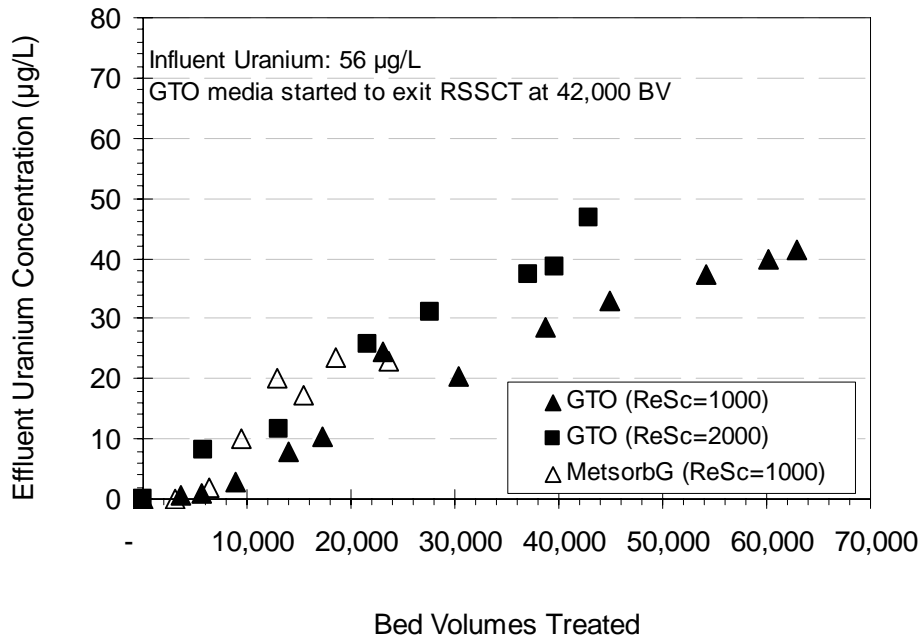

Figure 4-16. Comparison of Two ReSc Values on Upper Bodfish, CA Titania-Based Media RSSCTs

Table 4-2. Throughput Before Reaching Arsenic and Uranium MCLs for Upper Bodfish Groundwater in Lake Isabella, California

Media	Throughput (BV)	
	Arsenic	Uranium
ArsenX ^{np} (HIX)	28,000	> 50,000
E33	44,000	12,000
GFH	50,000	25,000
MetsorbG	21,000	> 24,000 ^(a)
Adsorbsia GTO	16,000	26,000

(a) Column failed at approximately 24,000 BV due to pressure buildup and bed compaction

Idaho. Over 50,000 BV of uranium removal would result in approximately 2 mg U/g of ArsenX^{np} (or 0.2%) accumulated on the media, exceeding the 0.05% “Unimportant Limit”. Alternatively, the spent media may be regenerated in situ, which would produce a uranium-laden brine that also would require special disposal at a licensed burial site.

4.7 South Truckee Meadows General Improvement District (STMGID) in Washoe County, NV (Site 6)

The well (No. 9) that supplies water to the GFH adsorption system at the STMGID facility, an EPA arsenic removal demonstration site in Washoe County, Nevada, requires treatment to remove both arsenic and antimony. The MCL for antimony is 6 µg/L, and the average influent antimony concentration in the Well No. 9 groundwater is 13 µg/L. Because the antimony concentrations are relatively low and because the facility has some blending capacity with arsenic and antimony-free groundwater, the GFH adsorption system is used primarily to remove arsenic, which fluctuates in concentration between 40 and 70 µg/L. The objectives of the RSSCT tests were to predict the performance of the full-scale GFH system for both arsenic and antimony removal and to compare the adsorptive capacities and run lengths for four adsorptive media, i.e., GFH, ArsenX^{np}, ARM 200, and Adsorbsia GTO. The comparison of media capacities and run lengths was prompted by the unexpected early arsenic breakthrough from the full-scale GFH system, i.e., around 8,000 BV at 10 µg/L. Another objective of the tests was to demonstrate that arsenic breakthrough curves for GFH would not be affected by scaling the RSSCT columns to a shorter full-scale EBCT, a technique that can significantly shorten the required RSSCT run time.

4.7.1 Arsenic Removal. Figure 4-17 presents the arsenic breakthrough curves from four RSSCT columns scaled to a short full-scale EBCT of 3 min. As shown by the breakthrough curves, all four media had a rather short run length before reaching 10 µg/L. The longest run length was 11,000 BV, which was achieved by GFH, the media that is being evaluated at the STMGID, NV site. Although somewhat longer, the RSSCT accurately predicted the unexpectedly short run length (i.e., 8,000 BV) experienced by the full-scale system. The run lengths achieved by the other three media were progressively shorter, decreasing from approximately 9,000 BV for ArsenX^{np}, to 8,000 BV for ARM 200, and to 4,000 BV for Adsorbsia GTO. Similar to the problems encountered elsewhere, the Adsorbsia GTO RSSCT column experienced pressure buildup and bed compaction. Therefore, the column run had to be ceased at about 21,000 BV.

To validate the short full-scale EBCT used, one additional RSSCT was conducted with GFH using a full-scale EBCT of 6.2 min, which was close to the average EBCT of 6.5 min experienced at the site. In doing so, the loading rates to both columns were equal and only the media bed depth was changed from 7.7 cm (for 3 min EBCT) to 16 cm (for 6.2 min EBCT). Figure 4-18 demonstrates that, on a bed volume

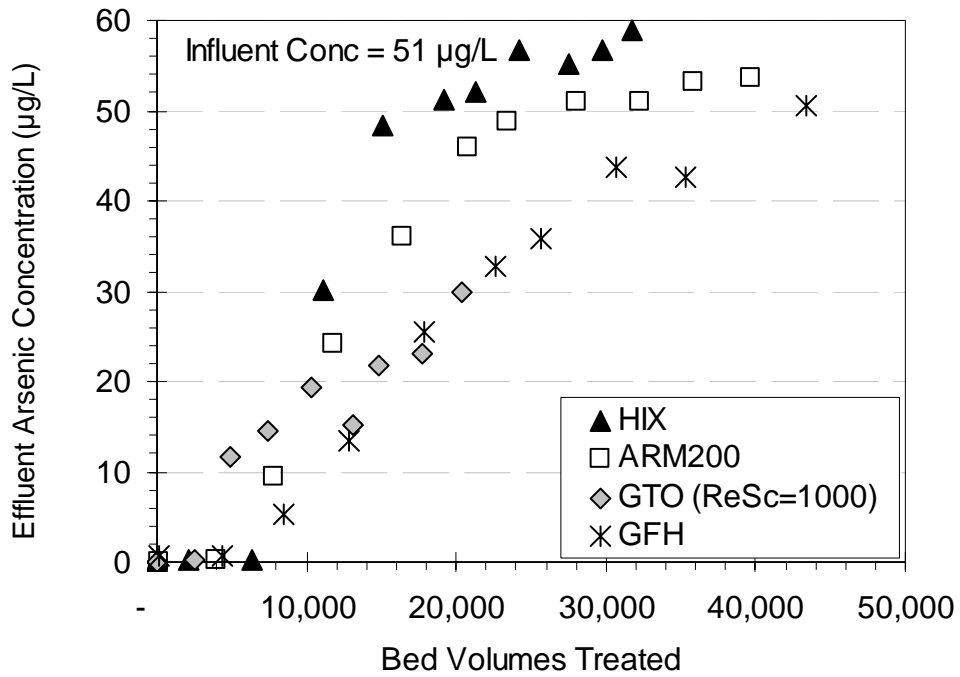

Note: Scaled to a full-scale EBCT of 3 min

Figure 4-17. Arsenic Breakthrough Curves from STMGID, NV Laboratory RSSCT Columns

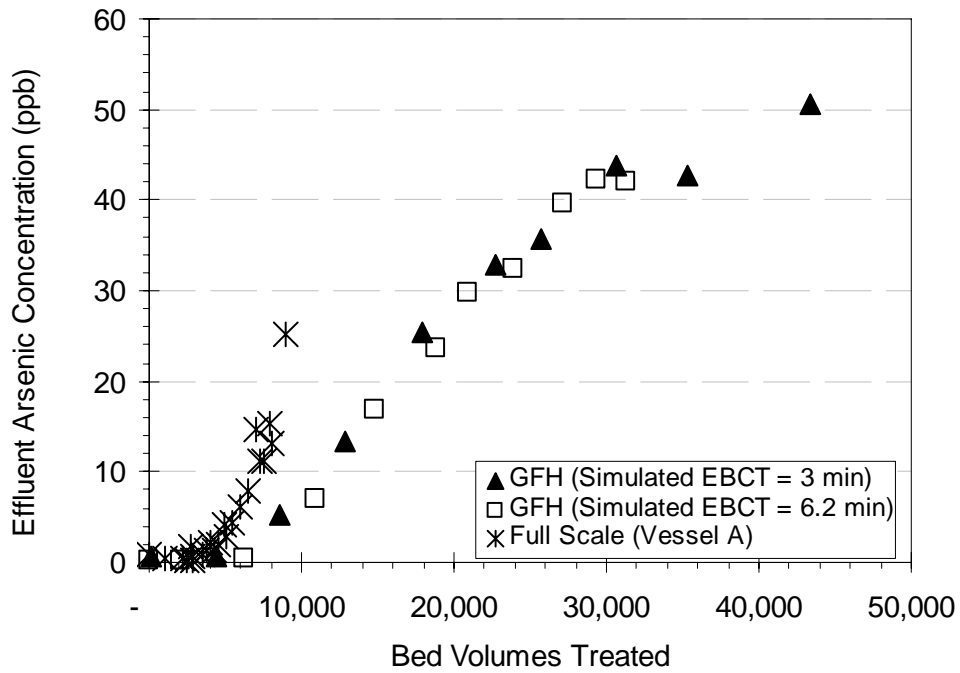

Figure 4-18. Comparison of GFH RSSCT and Full-Scale System Results for STMGID in Washoe County in NV

treated basis, there was no difference between the two arsenic breakthrough curves; similar results also were observed for other oxy-anions (data not shown). RSSCTs conducted with shorter EBCTs would require less water to be collected and transported and shorter operational run time. For example, the RSSCT that simulated a 3-min full-scale EBCT had a RSSCT EBCT_{sc} of 20 sec and required 10 days of operation to complete the experiment, compared to a RSSCT EBCT_{sc} of 40 sec and 17 days of operation for the RSSCT scaled to the 6.2 min full-scale EBCT. Therefore, as long as it is within the applicable range, a shorter full-scale EBCT may be utilized to scale the RSSCT experiments.

Also plotted in Figure 4-18 is the arsenic breakthrough curve from the full-scale system, which reached the 10- $\mu\text{g/L}$ level at about 8,000 BV. The slight difference between the laboratory RSSCT and full-scale results most likely were caused by the varying influent water quality. The water sample collected during the laboratory RSSCT testing contained 51 $\mu\text{g/L}$ of arsenic (existing entirely as As[V]), 0.16 mg/L of phosphorous, and 23 mg/L of silica (as SiO₂) and had a pH value of 7.4 (the silica analysis was suspected to be inaccurate due to instrumentation problems). The influent water fed to the full-scale system from system startup through just before reaching 10 $\mu\text{g/L}$ arsenic breakthrough during September 27, 2005 through March 28, 2006 contained 35.0 to 80.1 $\mu\text{g/L}$ (averaged 62.9 $\mu\text{g/L}$) of arsenic, 0.25 to 0.46 mg/L (averaged 0.35 mg/L) of phosphorous, and 51.5 to 95.1 mg/L (averaged 72.5) of silica; the pH values during this period ranged from 6.5 to 7.9 and averaged 7.2. The lower arsenic and phosphorous levels in the RSSCT influent very likely have resulted in the later arsenic breakthrough from the RSSCT column.

The RSSCT and full-scale system results clearly indicated that the Well No. 9 water at STMGID was difficult to treat. Careful review of the influent water quality data suggested that the only constituents that could have exerted such a strong impact on arsenic adsorption were silica and phosphorous. As noted above, silica and phosphorous concentrations in raw water averaged 72.5 and 0.35 mg/L, respectively. Silica at high concentrations, as reviewed in Section 1.1.1, can significantly impact arsenate adsorption by porous metal-oxide media (Smith and Edwards 2005; Meng et al., 2000; Meng et al., 2002). The mechanisms involved may include changes of media surface properties, such as lowering the iso-electric point or pH_{zpc} due to silica adsorption; competitive adsorption of silica on available adsorption sites; loss of available adsorption sites caused by polymerization of silica; and reactions of silica with divalent cations such as calcium, magnesium and barium to form precipitates. Phosphorous if charged also can compete with arsenic for available adsorption sites. The full-scale system data indicated that phosphorous was completely removed by GFH during the first 4,500 BV and partially removed when arsenic breakthrough had reached the 10 $\mu\text{g/L}$. The removal of phosphorous is further discussed in Section 4.7.3.

An additional RSSCT was later conducted for MetsorbG. The 100 \times 140 mesh RSSCT media was prepared by sieving, without crushing, a 60 \times 150 mesh material supplied by the vendor (note that a 16 \times 50 mesh material was used for full-scale applications). The RSSCT column was scaled to a full-scale EBCT of 3 min and operated with a ReSc value of 1,000. There was no bed compaction or other operation problems over the 8-day RSSCT run. Arsenic did breakthrough relatively early, i.e., < 1 $\mu\text{g/L}$ at 44 BV, 4 $\mu\text{g/L}$ at 1,050 BV, 29 $\mu\text{g/L}$ at 2,500 BV, 37 $\mu\text{g/L}$ at 8,200 BV, and 43 $\mu\text{g/L}$ at 11,000 BV. Thus, MetsorbG treated even fewer BV than the four media already tested.

4.7.2 Antimony Removal. Figure 4-19 presents the antimony breakthrough curves from the four RSSCT columns discussed above. In addition to the 3 min EBCT, GFH also was scaled to a full-scale EBCT of 6.2 min. As shown by the breakthrough curves, GFH, ARM 200, and ArsenX^{np} exhibited little or no adsorptive capacity for antimony. GFH reached the 6 $\mu\text{g/L}$ MCL within only 2,000 BV, similar to that (i.e., 3,000 BV) observed at the full-scale demonstration site. Adsorbis GTO was the only media that appeared to have significant adsorptive capacity for antimony, removing it to the 6 $\mu\text{g/L}$ level at approximately 20,000 BV. However, because of the operational difficulties experienced by this media, the observed capacity might not be representative of the true capacity that the media would possess. Table 4-3 summarizes the number of BV treated until breakthrough for arsenic and antimony.

4.7.3 Removal of Other Elements. Figure 4-20 presents the breakthrough curves for vanadium, phosphorous, silica, and iron. The water contained low levels of vanadium (i.e., 4 µg/L) and all media except Adsorbisia GTO removed vanadium almost completely during the entire RSSCT study period. The water contained moderately high levels of phosphate (0.16 mg/L). Partial to complete phosphorous removal was achieved by all media during the first 10,000 to 20,000 BV, consistent with what was observed for the full-scale system. The shape of the breakthrough curves was similar to that for the arsenic breakthrough curve for each media, although phosphorous broke through at least 5,000 to 10,000 BV earlier than arsenic. This suggests that phosphorous may compete with arsenic for adsorption sites on the media. Silica levels were moderately high (23 mg/L [as SiO₂]) – note that average influent silica concentration to the full-scale system was 73.6 mg/L) and all the media removed some silica during the first few thousand BV of operation (Figure 4-21). Silica removal by the media will change the surface chemistry properties (i.e., lower the zeta potential on the media) and in general will detrimentally impact arsenic removal. Iron concentrations in the RSSCT effluent were comparable among the different media.

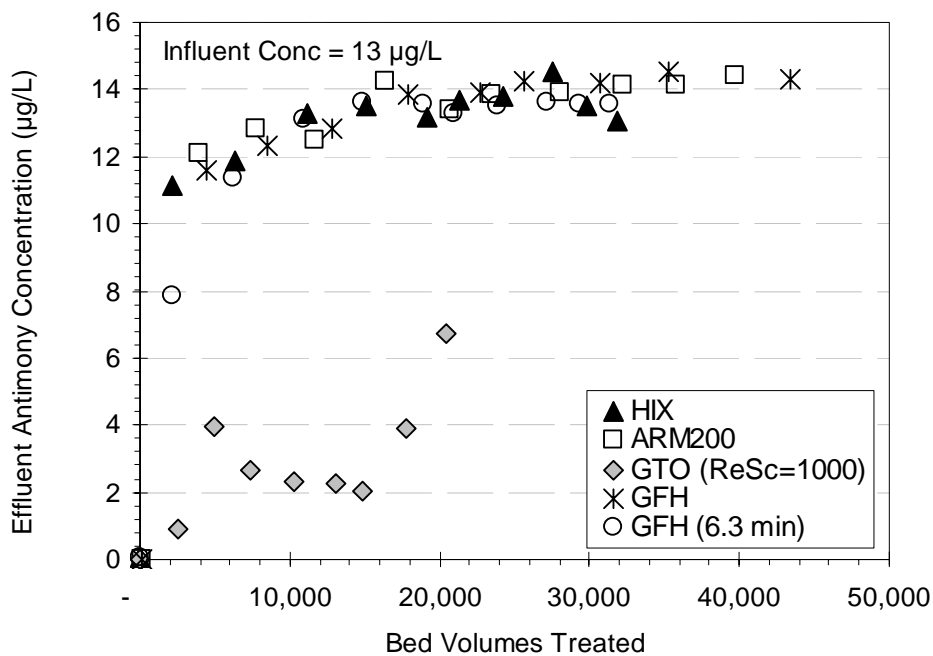

Note: Scaled to a Full-Scale EBCT of 3 min unless mentioned otherwise

Figure 4-19. Antimony Breakthrough Curves from STMGID, NV Laboratory RSSCT Columns

Table 4-3. Throughput Before Reaching Arsenic and Antimony MCLs for STMGID, NV Groundwater

Media	Throughput (BV)	
	Arsenic	Antimony
GFH	11,000	< 2,000
ArsenX ^{np}	9,000	Low
ARM 200	8,000	Low
Adsorbisia GTO	4,000	20,000 ^(a)
MetsorbG	< 2,000	NA

(a) Result unreliable due to operational difficulties with RSSCT column

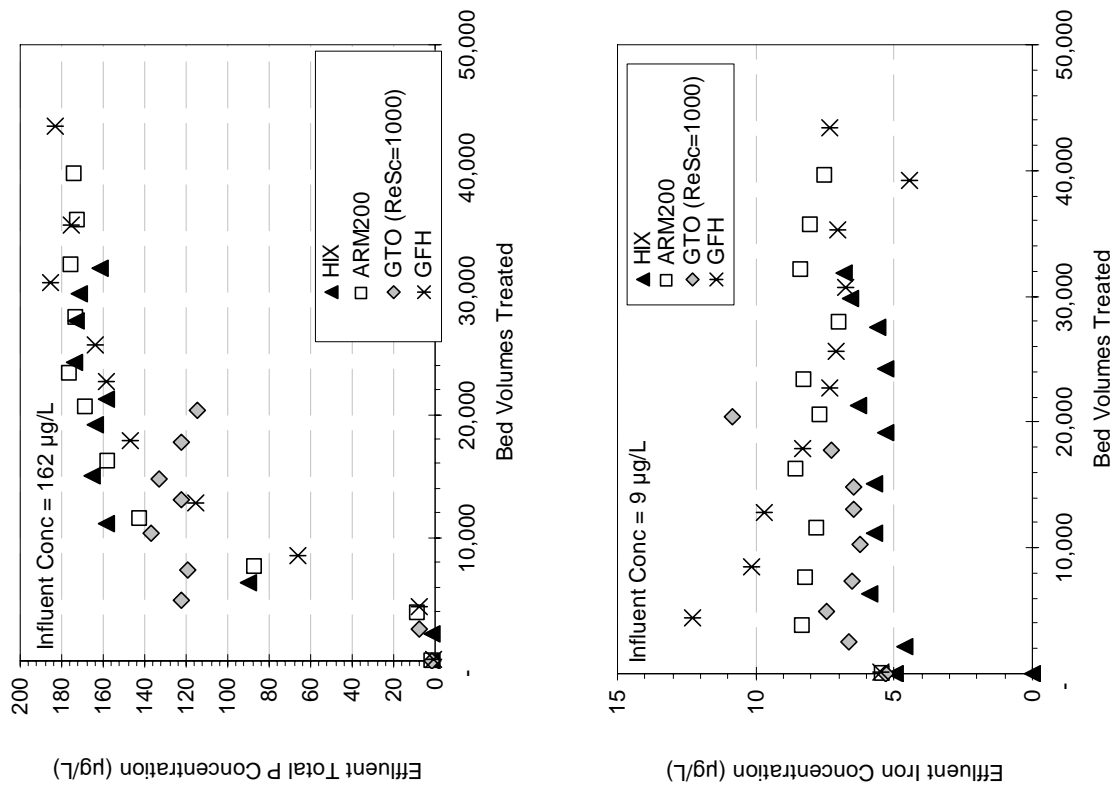

Figure 4-20. Breakthrough of V, P, Si, and Fe from STMGID, NV Laboratory RSSCT Columns Scaled to a Full-Scale EBCT of 3 min

4.8 Spring Brook Mobile Home Park in Wales, ME (Site 7)

Three rounds of field RSSCTs were conducted at SBMHP in Wales, ME, where groundwater had a high average pH value of 8.7. One objective of the RSSCTs was to simulate the full-scale system, which uses a solid-phase oxidizing media (A/P Complex 2002) to convert As(III) to As(V), followed by arsenic adsorption via A/I Complex 2000 media. The A/I Complex 2000 media consists of an activated alumina substrate onto which a ferric oxide coating is chemically “grafted.” Because of the proprietary nature of the full-scale media, AAFS50, an iron modified activated alumina media, was used in place of the A/I Complex 2000 media. Another objective of the RSSCTs was to evaluate alternative media for full-scale implementation. Arsenic removal capacities were evaluated for four iron-based media (GFH, E33, ARM 200, and KemIron), one HIX-based media (ArsenX^{np}), and one titania-based media (Adsorbsia GTO). The ARM 200 was tested a second time because the vendor had reduced the media particle size and bulk density and it was desired to use the new media for the RSSCT. Additionally, RSSCTs were used to evaluate the removal capacity of four adsorptive media (i.e., GFH, ARM 200, and KemIron, and Adsorbsia GTO) for arsenite removal. This was accomplished by conducting one round of RSSCTs with filtered well water prior to the treatment with the solid-phase oxidizing media.

4.8.1 Arsenic Removal. Two rounds of RSSCTs were performed on As(V) removal. Figure 4-21 shows the breakthrough curves for AAFS50, ARM 200 (12 × 40 mesh; 46 to 50 lb/ft³), ArsenX^{np}, and Adsorbsia GTO (Part 1) and Figure 4-22 shows the breakthrough curves for E33, GFH, ARM 200 (12 × 50 mesh; 35 to 40 lb/ft³), and KemIron (Part 2). For the most part, the iron-based adsorptive media achieved the highest number of BV until breakthrough at 10 µg/L (i.e., 25,000 BV with KemIron, 23,000 BV with GFH, and 20,000 BV with E33). The number of BV for ARM 200 was significantly lower, ranging from 17,500, for the old media, to 13,000 BV, for the new media. ArsenX^{np} achieved 18,000 BV, which was better than the 6,700 BV achieved by the iron modified activated alumina. Both ArsenX^{np} and AAFS50 exhibited steep arsenic breakthrough curves compared to that of the iron-based media. This suggests relatively short mass transfer zone through the ArsenX^{np} and AAFS50 media beds. It should be noted that there were operational difficulties with the Adsorbsia GTO media, resulting in the media breaking down and particles exiting the RSSCT column. By the end of the test, the volume of the media present in the column was reduced by 40%. Based on discussion with the media vendor, the process of grinding the media appeared to affect the binding agent. The full-scale system using the Aquatic Treatment Systems (ATS) A/I Complex 2000 media produced a similar breakthrough curve to that of AAFS50, which was selected to represent the media. The full scale performance curve for A/I Complex 2000 media is included in Figure 4-21 for comparison. The AAFS50 RSSCT appears to be able to predict the full-scale performance of the A/I Complex 2000 iron-modified activated alumina media, which reached 10 µg/L after approximately 7,000 BV.

The RSSCT and full-scale test results indicate that the number of BV achieved by all media was significantly less than that observed previously at other demonstration sites. The low removal capacity is attributed to the high pH value of the SBMHP groundwater of 8.7, which is close to the respective pH_{zpc} of the metal (hydr)oxides tested.

Figure 4-23 presents the breakthrough curves from the RSSCT performed using water containing arsenite. Table 4-4 compares the bed volumes treated until breakthrough at 10 µg/L for As (V) and As (III). As shown in the table, for GFH, ARM 200, and KemIron, the number of BV until the 10 µg/L breakthrough was greater for As(III) than As(V). Although site-specific full-scale performance results are not available for comparison, it is highly unusual for metal (hydr)oxide adsorptive media to show higher adsorptive capacities for As(III) than for As(V). Similar to the results obtained at LVHS (Site 3), it is believed that the RSSCT method overestimated the media’s adsorptive capacities for As (III) removal. It appears that the scaling equations used to design the columns need to be modified to account for the different sorption properties/mechanisms between As(III) and As(V). Additional study is required to resolve this issue.

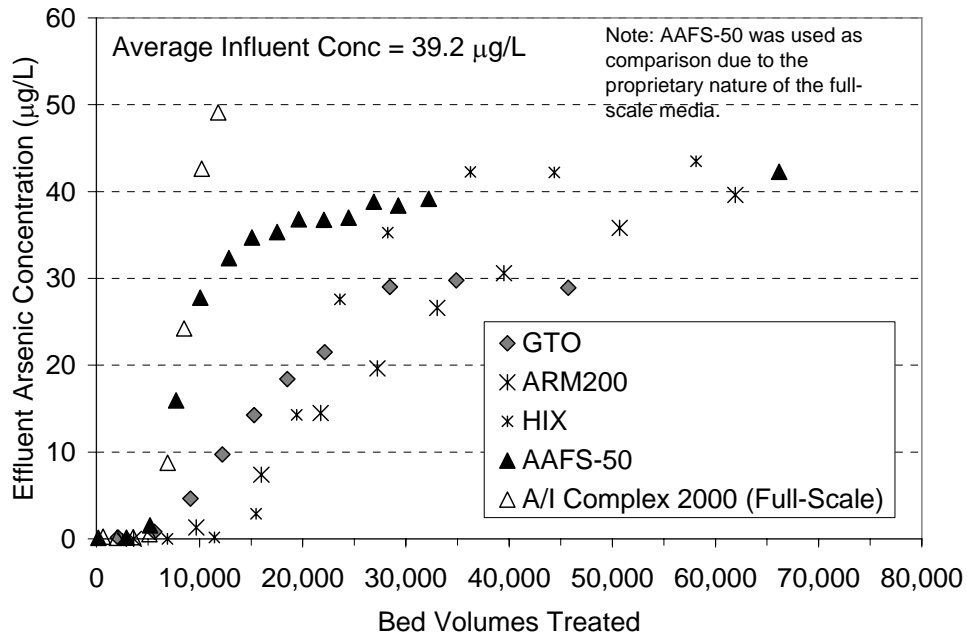

Figure 4-21. As(V) Breakthrough Curves from Field RSSCT Columns at SBMHP in Wales, ME (Part 1)

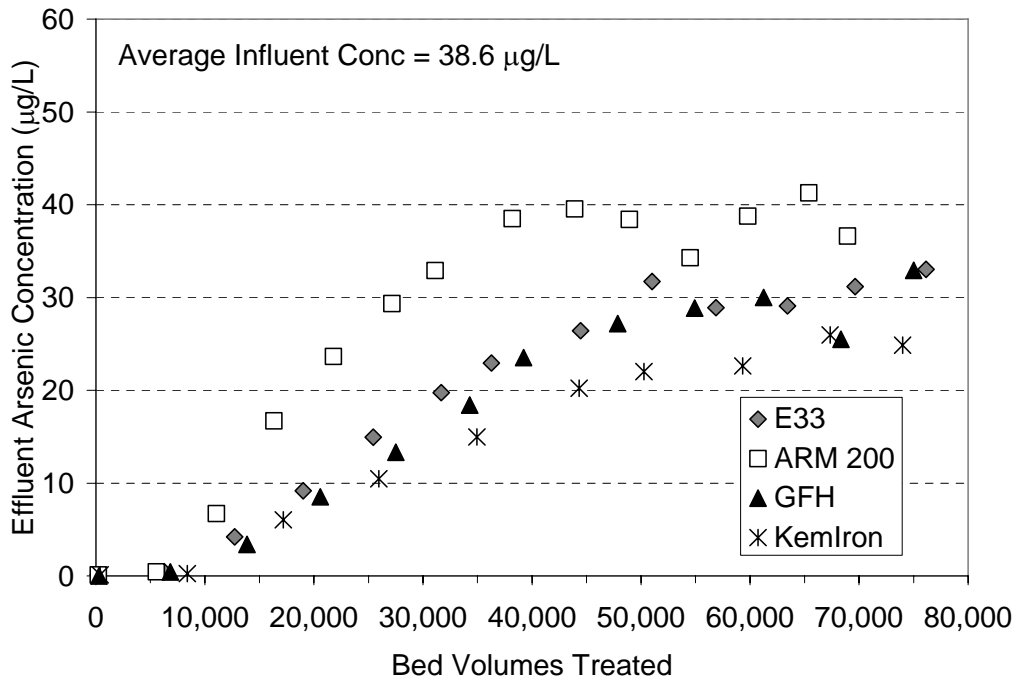

Figure 4-22. As(V) Breakthrough Curves from Field RSSCT Columns at SBMHP in Wales, ME (Part 2)

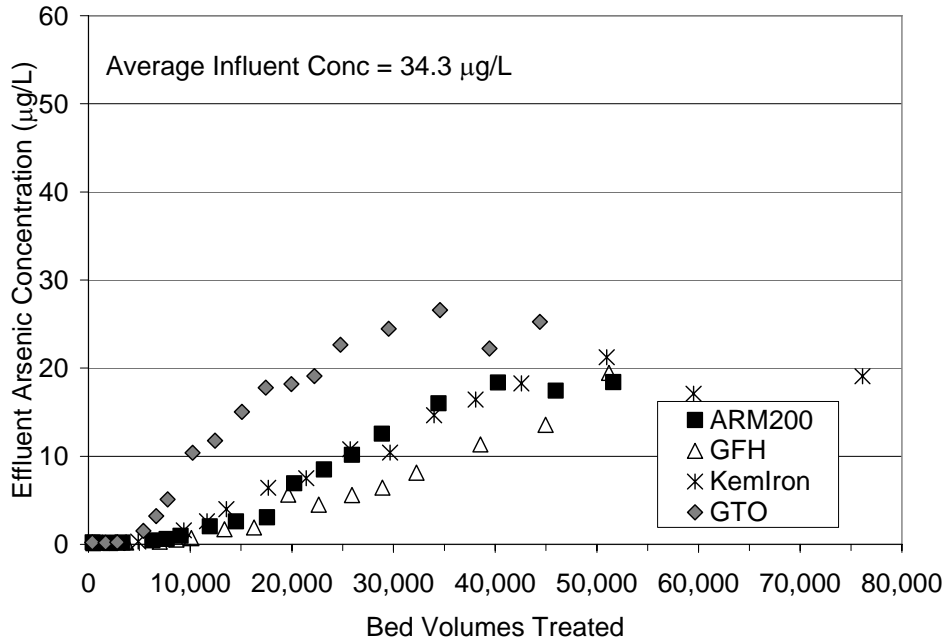

Figure 4-23. As(III) Breakthrough Curves from Field RSSCT Columns at SBMHP in Wales, ME

Table 4-4. Comparison of Throughput for As(III) and As(V) Removal from SBMHP Groundwater in Wales, ME

Media	Throughput (BV)	
	As(V) Removal	As(III) Removal
Kemiron	25,000	24,600
GFH	23,000	36,000
ARM 200	17,500 ^(a) /13,000 ^(b)	26,000 ^(a)
Adsorbsia GTO ^(c)	12,500	10,000

- (a) Old media with 12 × 40 mesh size and 46 to 50 lb/ft³ bulk density
- (b) New media with 12 × 50 mesh size and 35 to 40 lb/ft³ bulk density
- (c) Although present, data not reliable because of operational difficulties encountered

4.8.2 Removal of Other Elements. Breakthrough curves for phosphorous and silica for the three rounds of RSSCT tests are presented in Figures 4-24 (for As[V]) and 4-25 (for As[III]). As shown by the figures, all media removed some phosphorous. Silica was partially removed during the first few thousand BV. There was no removal or release of fluoride, chloride, or sulfate by any of the media. In light of the significant bed loss, the influent and effluent of the Adsorbsia GTO column also were monitored for total and soluble titanium. Filtered samples showed a slight increase in dissolved titanium (average 2 µg/L), but the majority of the titanium measured in the effluent was particulate (Figure 4-26), which could be visibly observed in the effluent of the RSSCT column. The data confirmed the field observation that the media in the RSSCT column disintegrated during the course of RSSCT test. As noted above, grinding of the media might have affected the integrity of the media, causing the crushed factions to fall apart.

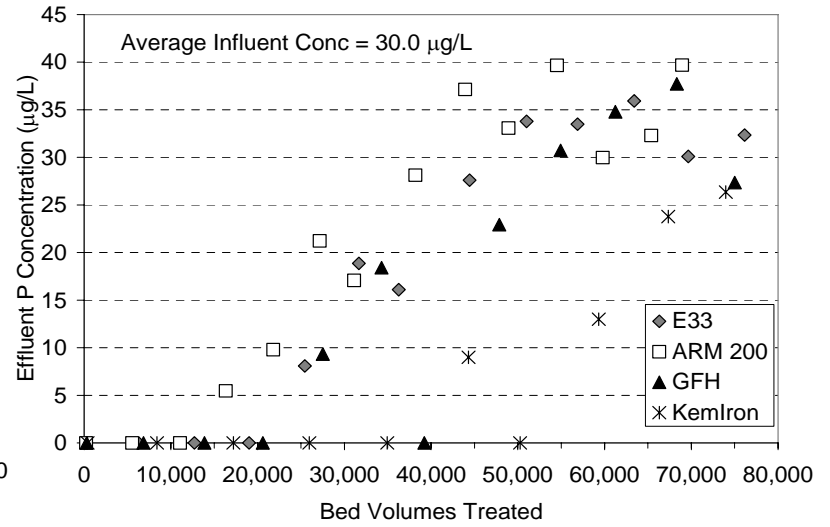
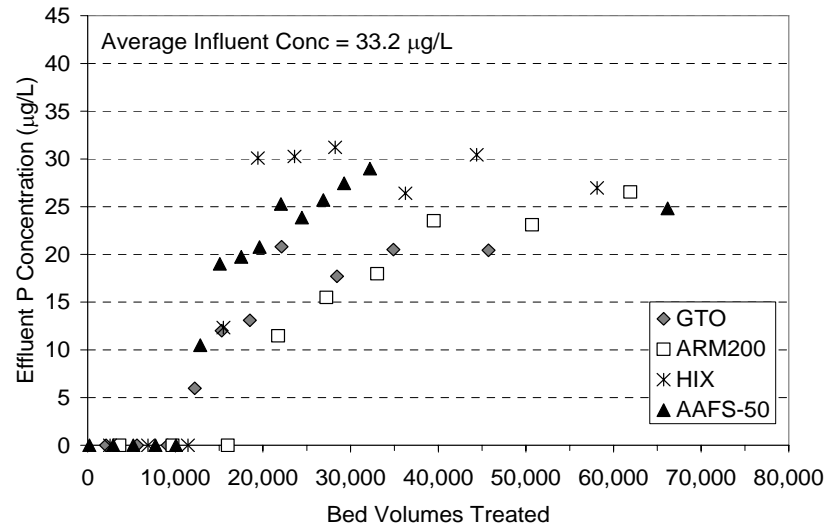
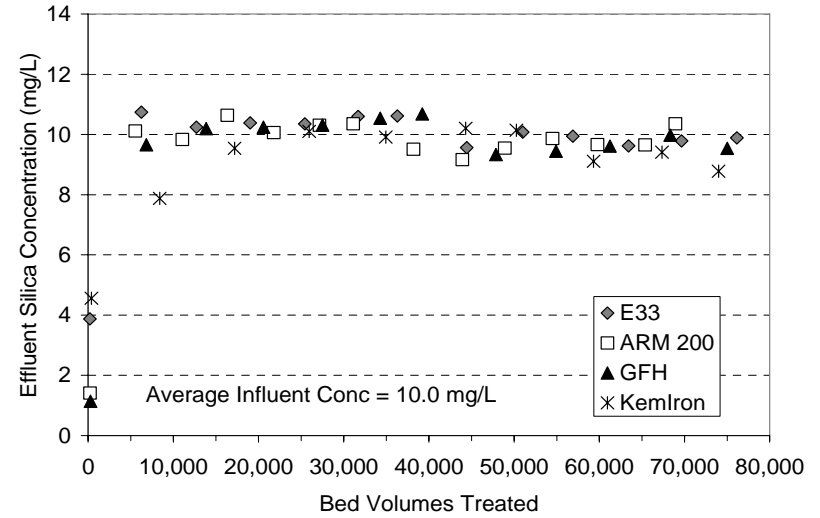
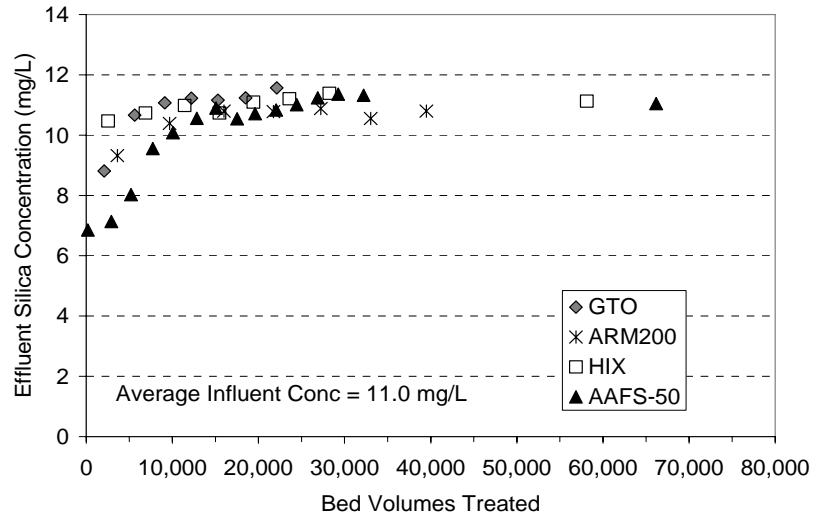

Figure 4-24. Breakthrough of Si and P from Field As(V) RSSCT Columns at SBMHP in Wales, ME (Part 1 on Left; Part 2 on Right)

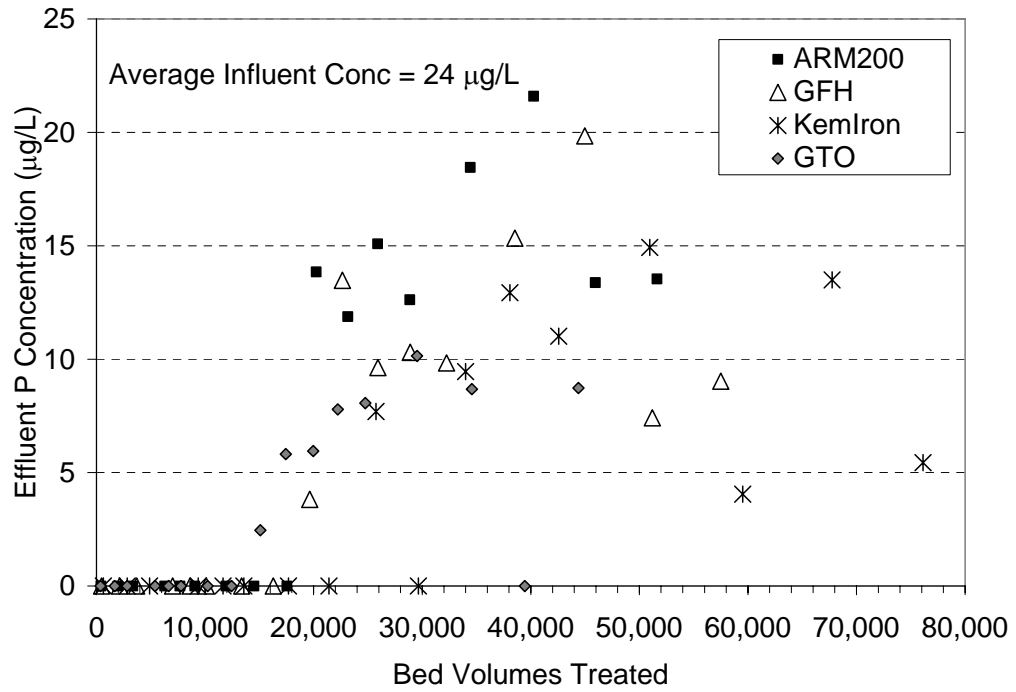
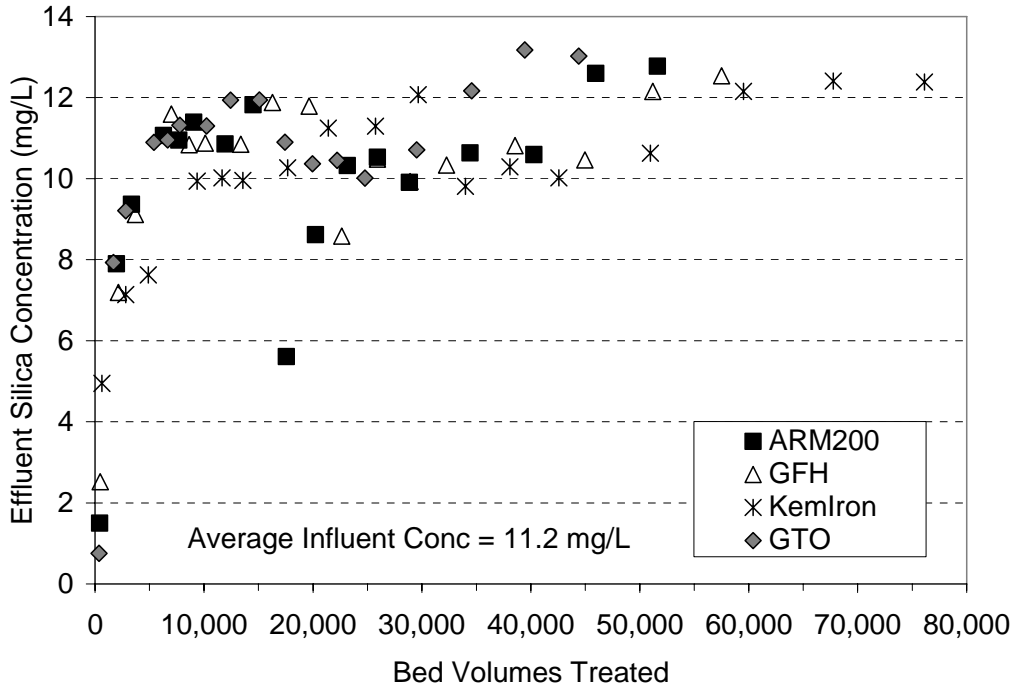

Figure 4-25. Breakthrough of Si and P from Field As(III) RSSCT Columns at SBMHP in Wales, ME

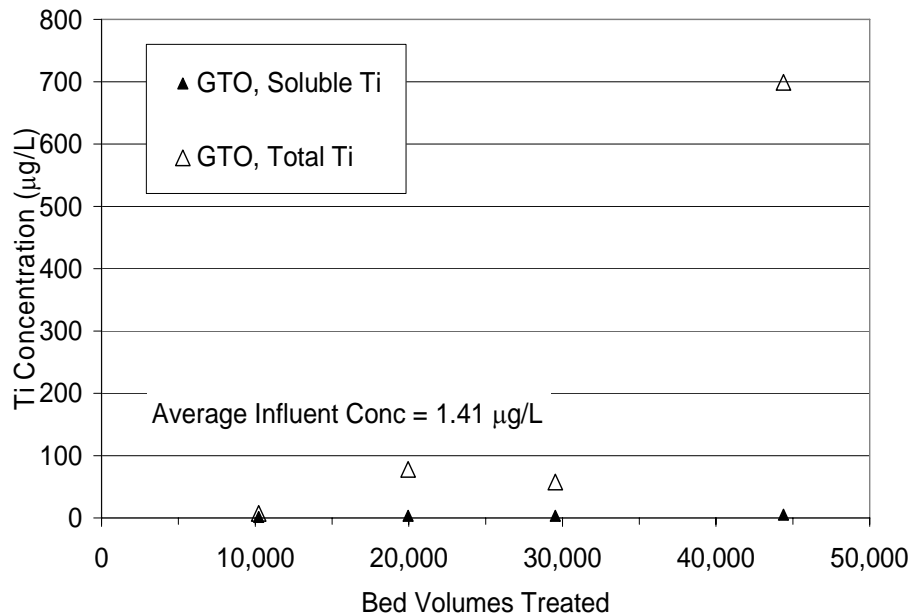

Figure 4-26. Total and Soluble Ti Breakthrough Curves from As(III) RSSCT Columns at SPMHP in Wales, ME

4.9 Media Adsorptive Capacity for Arsenic

To further analyze the data, the adsorptive capacity of each media ($\mu\text{g As/mg}$ of dry media) was calculated using the arsenic breakthrough curve. Because breakthrough curves finished at varying degrees of complete arsenic breakthrough (i.e., different As/As_0 values), the adsorptive capacity associated with an effluent arsenic concentration of $10 \mu\text{g/L}$ was selected for comparison among media. The area above the arsenic breakthrough curve but below the influent level was integrated and divided by the mass of media in a RSSCT column. The mass of dry media in the RSSCT column was based upon drying the media for 24 hr at 105°C or estimated based on packed bed geometry and dry bulk density of each media (reported in Table 3-2). Loss of media during the tests was not accounted for. The mass of media in a pilot- or full-scale system was estimated in a similar way.

Table 4-5 summarizes the number of BV treated and arsenic adsorptive capacities for the media tested at all sites. Adsorptive capacities ranged from 0.05 to 2.0 mg As/g of dry media. For the iron media, based upon independent measurements of iron content in the media, E33 and GFH contained 177 mg Fe/g of dry media and 228 mg Fe/g of dry media, respectively. For the sites where E33 and GFH were tested side-by-side, both media exhibited similar arsenic adsorptive capacities on the order of 3 to 10 mg As/g of Fe (dry weight).

4.10 Comparison of Arsenic Removal for Different Source Waters

One benefit of conducting RSSCT is its ability to assess media performance for different source waters using a standard testing protocol, compared to the inherent variability experienced in pilot tests. Based on the throughput data in Table 4-5 for water containing As(V), a rank order may be established

Table 4-5. Summary of Arsenic Adsorption Capacities

Site	Adsorptive Media	RSSCT vs. Full-/Pilot-Scale System	Throughput to Reach 10 µg/L Effluent Concentration (BV)	Adsorptive Capacity at 10 µg/L Effluent Concentration (mg As/g)
Valley Vista, AZ	AAFS50	RSSCT	5,000 – 10,000	0.3
	AAFS50	Full-Scale	7,000	0.12 ^(a)
	E33	RSSCT	44,000	1.1
	GFH	RSSCT	48,000	1.2
Rimrock, AZ	AAFS50	RSSCT	a few thousand	0.13
	E33	RSSCT	40,000	1.8
	E33	Full-Scale	40,000	1.2 ^(a)
	GFH	RSSCT	52,000	2.0
	ArsenX ^{np}	RSSCT	30,000	1.3
Licking Valley High School, Newark, OH	AAFS50	RSSCT	2,500	0.05
	AAFS50	Pilot-Scale	650	
	E33	RSSCT	11,000	1
	E33	Pilot-Scale	4,700	
	GFH	RSSCT	> 23,000	> 1
	GFH	Pilot-Scale	21,000	
	ArsenX ^{np}	RSSCT	7,000	0.3
Village of Lyman, NE	E33	RSSCT	25,000	0.4
	ArsenX ^{np}	RSSCT	16,000	0.2
	MetsorbG	RSSCT	16,000	0.2
	Adsorbsia GTO	RSSCT	22,000	0.3
Upper Bodfish, Lake Isabella, CA	E33	RSSCT	44,000	1.4
	GFH	RSSCT	50,000	1.4
	ArsenX ^{np}	RSSCT	28,000	0.9
	ArsenX ^{np}	Full-Scale	33,000	
	MetsorbG	RSSCT	21,000	0.6
	Adsorbsia GTO	RSSCT	16,000	0.5
South Truckee Meadows General Improvement District, Washoe County, NV	GFH	RSSCT	11,000	0.4
	GFH	Full-Scale	8,000	
	ARM 200	RSSCT	8,000	0.3
	ArsenX ^{np}	RSSCT	9,000	0.3
	Adsorbsia GTO	RSSCT	4,000	0.2
Spring Brook Mobile Home Park, Wales, ME	A/I Complex 2000	Full-Scale	7,000	0.28
	AAFS50 ^(b)	RSSCT	6,700	0.19
	E33 ^(b)	RSSCT	20,000	0.62
	GFH ^(b)	RSSCT	23,000	0.61
	GFH ^(c)	RSSCT	36,000	
	ARM 200 ^{(b) (d)}	RSSCT	17,500	0.57
	ARM 200 ^{(b) (e)}	RSSCT	13,000	0.41
	ARM 200 ^{(c) (d)}	RSSCT	26,000	
	KemIron ^(b)	RSSCT	25,000	0.65
	KemIron ^(c)	RSSCT	24,600	
	ArsenX ^{np(b)}	RSSCT	18,000	0.51
	Adsorbsia GTO ^(b)	RSSCT	12,500	0.40
	Adsorbsia GTO ^(c)	RSSCT	10,000	

(a) Full-scale estimates based upon approximate masses of media in the vessel and a density of 2.5 g/cm³

(b) Influent containing primarily As(V)

(c) Influent containing primarily As(III)

(d) Old media with 12 × 40 mesh size and 46 to 50 lb/ft³ bulk density

(e) New media with 12 × 50 mesh size and 35 to 40 lb/ft³ bulk density

among the source waters at the six EPA demonstration sites from the easiest to treat (most BV treated) to the most difficult to treat (fewest BV treated) (Table 4-6).

Five of the six source waters had pH values ranging from 7.2 to 7.7, while the other one had a much higher pH value which averaged 8.6. All waters had varying concentrations of other constituents (see Table 4-1). For example, the most difficult water to treat at STMGID had the highest phosphate and silica concentrations, which are known to have significantly decreased arsenic adsorption capacities for all media tested. The water also had the lowest calcium concentration; calcium can increase media surface charge and possibly improve arsenic removal (Smith and Edwards, 2005). The second most difficult to treat group included water at Lyman, NE and SBMHP in Wales, ME. The Lyman, NE water had the highest vanadium, sulfate, and TOC concentrations and the second highest phosphorous concentration. Vanadium and phosphorous directly compete with arsenic for available adsorption sites. Sulfate at high concentrations also may be detrimental to media adsorption. The challenge to adsorptive media technology at the SBMHP site was the high pH value of the source water, which significantly reduces the amount of charged sites available for arsenic adsorption. Therefore, the three most difficult water to treat appeared to have more challenging water chemistry for adsorptive media.

Two RSCCTs were performed on water containing arsenic primarily in the form of As(III). In both cases, the number of BV to reach 10 µg/L in the RSSCT effluent was notably higher than that achieved by the respective pilot-scale system. Although full-scale performance results were not available for comparison, it is highly unusual for adsorptive media to show a higher adsorptive capacity for As (III). As a result of these two tests, it is believed that the RSSCT method over estimated the media life for pilot/full-scale application for As (III) treatment with the adsorptive technology.

Table 4-6. Summary of Media Life at Six Arsenic Demonstration Sites

Ranking for Ease to Treat	Demonstration Site	Influent As (V) Concentration (µg/L)	Throughput to 10 µg/L (BV)
1	Rimrock, AZ	61.0	A few thousand to 52,000
	Valley Vista, AZ	39.5	7,000 to 48,000
	Upper Bodfish in Lake Isabella, CA	43.0	16,000 to 50,000
2	Spring Brook Mobile Home Park in Wales, ME	40.8 ^(a)	6,700 to 25,000
	Village of Lyman, NE	21.5	16,000 to 25,000
3	South Truckee Meadows General Improvement District, Washoe County, NV	51.0	4,000 to 11,000

(a) As(III) in raw water converted to As(V) using a solid-phase oxidizing media prior to removal via adsorptive media

5.0 REFERENCES

- APHA, A. and WEF. 1998. "Standard Methods for the Examination of Water And Wastewater (19th Edition)." American Public Health Association, Washington, D.C.
- Axe, L. and Trivedi, P. 2002. "Intraparticle Surface Diffusion of Metal Contaminants and Their Attenuation in Microporous Amorphous Al, Fe, and Mn Oxides." *Journal of Colloid and Interface Science*, 247(2): 259-265.
- Badruzzaman, M. 2005. "Mass Transport Scaling and the Role of Silica on Arsenic Adsorption onto Porous Iron Oxide (Hydroxide)," Ph.D. Dissertation, Arizona State University, Tempe, AZ.
- Badruzzaman, M. and Westerhoff, P. 2005. "The Application of Rapid Small-Scale Column Tests in Iron-Based Packed Bed Arsenic Treatment Systems." *Advances in Arsenic Research*, 268-283.
- Badruzzaman, M., Westerhoff, P., and Knappe, D.R.U. 2004. "Intraparticle Diffusion and Adsorption of Arsenate onto Granular Ferric Hydroxide (GFH)." *Water Research*, 38(18): 4002-4012.
- Battelle. 2004. "Quality Assurance Project Plan for Verification of Mini-Column Arsenic Test (QA ID No. 355-Q-2-1)." Prepared under Contract No. 68-C-00-185, Task Order No. 0025, for U.S. Environmental Protection Agency, National Risk Management Research Laboratory, Cincinnati, OH.
- Battelle. 2005. "Quality Assurance Project Plan for Verification of Mini-Column Arsenic Test (QA ID No. 355-Q-2-1) - Addendum No.1." Prepared under Contract No. 68-C-00-185, Task Order No. 0025, for U.S. Environmental Protection Agency, National Risk Management Research Laboratory, Cincinnati, OH.
- Crittenden, J. C., Berrigan, J. K., and Hand, D. W. 1986. "Design of Rapid Small-Scale Adsorption Tests For a Constant Diffusivity." *Journal Water Pollution Control Federation*, 58(4), 312-319.
- Crittenden, J. C., Berrigan, J. K., Hand, D. W., and Lykins, B. 1987. "Design of Rapid Fixed-Bed Adsorption Tests for Nonconstant Diffusivities." *Journal of Environmental Engineering-ASCE*, 113(2), 243-259.
- Crittenden, J.C., Reddy, P.S., Arora, H., Trynoski, J., Hand, D.W., Perram, D.L., and Summers, R.S. 1991. "Predicting GAC Performance with Rapid Small-Scale Column Tests." *Journal American Water Works Association*, 83(1): 77-87.
- Fuller, C.C., Bargar, J.R., Davis, J.A., and Piana, M.J. 2002. "Mechanisms of Uranium Interactions with Hydroxyapatite: Implications for Groundwater Remediation." *Environmental Science & Technology*, 36(2):158-165.
- Ghurye, G. and Clifford, D. 2001. "Laboratory Study on the Oxidation of Arsenic III to Arsenic V." EPA/600/R-01/021, U.S. Environmental Protection Agency, National Risk Management Research Laboratory, Cincinnati, OH.
- Goldberg, S., and Johnston, C. T. 2001. "Mechanisms of Arsenic Adsorption on Amorphous Oxides Evaluated Using Macroscopic Measurements, Vibrational Spectroscopy, and Surface Complexation Modeling." *Journal of Colloid and Interface Science*, 234(1), 204-216.
- Gu, B.H., Ku, Y.K., and Jardine, P.M. 2004. "Sorption and Binary Exchange of Nitrate, Sulfate, and Uranium on an Anion-Exchange Resin." *Environmental Science & Technology*, 38(11): 3184-3188.
- Lin, T.F. and Wu, J.K. 2001. "Adsorption of Arsenite and Arsenate Within Activated Alumina Grains: Equilibrium and Kinetics." *Water Research*, 35(8): 2049-2057.
- Lipps, J.P., Chen, A.S.C., and Wang, L. 2006. "Arsenic Removal from Drinking Water by Adsorptive Media. U.S. EPA Demonstration Project at Spring Brook Mobile Home Park in Wales, ME. Six-

- Month Evaluation Report." EPA/600/R-06/090. U.S. Environmental Protection Agency, National Risk Management Research Laboratory, Cincinnati, OH.
- McNeill, L.S. and Edwards, M. 1997a. "Arsenic Removal during Precipitative Softening." *Journal of Environmental Engineering-ASCE*, 123(5): 453-460.
- McNeill, L.S. and Edwards, M. 1997b. "Predicting As Removal during Metal Hydroxide Precipitation." *Journal American Water Works Association*, 89(1): 75-86.
- Meng, X.G., Bang, S., and Korfiatis, G.P. 2000. "Effects of Silicate, Sulfate, and Carbonate on Arsenic Removal by Ferric Chloride." *Water Research*, 34(4): 1255-1261.
- Meng, X.G., Korfiatis, G.P., Bang, S.B., and Bang, K.W. 2002. "Combined Effects of Anions on Arsenic Removal by Iron Hydroxides." *Toxicology Letters*, 133(1): 103-111.
- Raven, K. P., Jain, A., and Loeppert, R. H. 1998. "Arsenite and Arsenate Adsorption on Ferrihydrite: Kinetics, Equilibrium, and Adsorption Envelopes." *Environmental Science & Technology*, 32(3), 344-349.
- Smith, S.D. and Edwards, M. 2005. "The Influence of Silica and Calcium on Arsenate Sorption to Oxide Surfaces." *Journal of Water Supply: Research and Technology - AQUA*, 54(4): 201-211.
- Sperlich, A., Werner, A., Genz, A., Amy, G., Worch, E., and Jekel, M. 2005. "Breakthrough Behavior of Granular Ferric Hydroxide (GFH) Fixed-Bed Adsorption Filters: Modeling and Experimental Approaches." *Water Research*, 39(6): 1190-1198.
- Thomson, B. and Anderson, J. 2004. "Evaluation of Two Arsenic Adsorption Media Using a Rapid Small Scale Column Testing (RSSCT) Procedure." Final report to Kemiron Corporation.
- Valigore, J.M., Wang, L., and Chen, A.S.C. 2006. "Arsenic Removal from Drinking Water by Adsorptive Media. U.S. EPA Demonstration Project at Valley Vista, AZ. Six-Month Evaluation Report." EPA/600/R-06/083. U.S. Environmental Protection Agency, National Risk Management Research Laboratory, Cincinnati, OH.
- Wang, L., Condit, W.E., and Chen, A.S.C. 2004. "Technology Selection and System Design. U.S. EPA Arsenic Removal Technology Demonstration Program, Round 1." EPA 600-R-05-001. U.S. Environmental Protection Agency, National Risk Management Research Laboratory, Cincinnati, OH.
- Wang, L., Valigore, J.M., and Chen, A.S.C. 2005. "Arsenic Removal from Drinking Water by Adsorptive Media. U.S. EPA Demonstration Project at Rimrock, AZ. Six-Month Evaluation Report." EPA/600/R-05/159. U.S. Environmental Protection Agency, National Risk Management Research Laboratory, Cincinnati, OH.
- Westerhoff, P., Highfield, D., Badruzzaman, M., and Yoon, Y. 2005. "Rapid Small-Scale Column Tests for Arsenate Removal in Iron Oxide Packed Bed Columns." *Journal of Environmental Engineering-ASCE*, 131(2): 262-271.
- Wilkie, J. A., and Hering, J. G. 1996. "Adsorption of arsenic onto hydrous ferric oxide: Effects of Adsorbate/Adsorbent Ratios and Co-occurring Solutes." *Colloids and Surfaces a-Physicochemical and Engineering Aspects*, 107, 97-110.