



Development of a Hazardous Waste Incinerator Target Analyte List of Products of Incomplete Combustion

Prepared for:
Office of Solid Waste

Prepared by:
National Risk Management Research Laboratory
Research Triangle Park, NC 27711

FOREWORD

The U.S. Environmental Protection Agency is charged by Congress with protecting the Nation's land, air, and water resources. Under a mandate of national environmental laws, the Agency strives to formulate and implement actions leading to a compatible balance between human activities and the ability of natural systems to support and nurture life. To meet this mandate, EPA's research program is providing data and technical support for solving environmental problems today and building a science knowledge base necessary to manage our ecological resources wisely, understand how pollutants affect our health, and prevent or reduce environmental risks in the future.

The National Risk Management Research Laboratory is the Agency's center for investigation of technological and management approaches for reducing risks from threats to human health and the environment. The focus of the Laboratory's research program is on methods for the prevention and control of pollution to air, land, water, and subsurface resources; protection of water quality in public water systems; remediation of contaminated sites and groundwater; and prevention and control of indoor air pollution. The goal of this research effort is to catalyze development and implementation of innovative, cost-effective environmental technologies; develop scientific and engineering information needed by EPA to support regulatory and policy decisions; and provide technical support and information transfer to ensure effective implementation of environmental regulations and strategies.

This publication has been produced as part of the Laboratory's strategic long-term research plan. It is published and made available by EPA's Office of Research and Development to assist the user community and to link researchers with their clients.

E. Timothy Oppelt, Director
National Risk Management Research Laboratory

EPA REVIEW NOTICE

This report has been peer and administratively reviewed by the U.S. Environmental Protection Agency, and approved for publication. Mention of trade names or commercial products does not constitute endorsement or recommendation for use. This document is available to the public through the National Technical Information Service, Springfield, Virginia 22161.

**DEVELOPMENT OF A HAZARDOUS WASTE INCINERATOR TARGET
ANALYTE LIST OF PRODUCTS OF INCOMPLETE COMBUSTION**

FINAL REPORT

Prepared by:

Paul M. Lemieux and Jeffrey V. Ryan
U.S. Environmental Protection Agency
National Risk Management Research Laboratory
Air Pollution Prevention and Control Division
Research Triangle Park, NC 27711

Prepared for:

U.S. Environmental Protection Agency
Office of Research and Development
Washington, DC 20460

ABSTRACT

Pilot-scale incineration experiments were performed to develop a comprehensive list of products of incomplete combustion (PICs) from hazardous waste combustion (HWC) systems. The goals of this project were: 1) to develop an expanded list of HWC target analytes for EPA's Office of Solid Waste (OSW) to use as a basis for a PIC-based regulatory approach; 2) to identify the total mass of organic compounds sufficiently to estimate the toxicity of the complex mixture; and 3) to enable OSW to assess the relative importance of polychlorinated dibenzo-p-dioxins and polychlorinated dibenzofurans (PCDDs/PCDFs) to other PICs.

These tests were performed under varied combustion conditions feeding a mixed surrogate waste, resulting in the generation of numerous PICs. While many of these PICs were identified as target analytes using standardized sampling and analytical methods, the majority of PICs present in the incineration emissions were not target analytes. Although a substantial number of PICs have been tentatively identified, a considerably larger number have not been identified at this time. It can be concluded from these experiments that the current sampling and analytical schemes for characterizing HWC emissions provide an incomplete picture of the emission profile.

Innovative analytical techniques, such as multi-dimensional gas chromatography (MDGC) appear to show great promise for identifying the unknown compounds present in the stack gases. In many cases, "clean" chromatographic peaks were not able to be identified via mass spectral search algorithms because what appeared to be a single peak was really many compounds co-eluting off the column. When these types of peaks were analyzed using the MDGC system, the co-eluting compounds were resolved and identified.

As a result of these experiments, an expanded list of PIC target analytes has been developed. This list is by no means complete or comprehensive. This list should be viewed in context with this particular set of experiments; i.e., waste mix. The PICs generated from the incineration of other mixed waste streams have not been evaluated.

The PICs identified fall into several chemical classes. A wide variety of chloro, bromo, and mixed bromochloro alkanes, alkenes, alkynes, aromatics, and polyaromatics were detected. In addition, nonhalogenated hydrocarbon homologues along with oxygenated, nitrogenated, and sulfonated organics were detected. Analytical methods specifically suited to identify these chemical classes are needed to enhance PIC characterizations. Of the non-target semivolatile organic compounds that were detected but not identified, the vast majority were large alkanes (with more than 10 carbons), esters of high molecular weight carboxylic acids, and phthalates. The authors believe that improved analytical methodologies emphasizing validation and quantification of these compounds would provide the greatest opportunity to reduce uncertainty in risk assessment calculations.

Other secondary goals of this project were also realized. It was observed that increases in feed bromine concentration could dramatically impact emissions of many chlorinated organics, including PCDDs/PCDFs. It was also observed that concentrations of chlorinated alkenes dropped as residence time in the secondary combustion chamber increased, while ring growth reactions were observed in-flight in moderate temperature regions prior to gas quenching. Finally, evidence has been found to support the use of certain easily measured volatile organic PICs as surrogates for PCDD/PCDF emissions.

Some goals of this project were not attained. A mass balance between identified PICs and total hydrocarbon (THC) measurements was not established. THC concentrations were in the very low ppm range, within the analytical accuracy of the instruments. Attempts to measure non-chlorinated alkanes, alkenes, and alkynes via bag sampling did not detect measurable levels of those compounds.

ACKNOWLEDGMENTS

This work was performed by Acurex Environmental Corp., under EPA Contract No. 68-D4-0005, under the direction of EPA Work Assignment Manager Paul Lemieux. The authors would like to thank Kevin Bruce, J. Frank Day, Tony Lombardo, Mark Calvi, Ray Thomas, and Eric Squier, Acurex Corp. for their dedication in performing these tests. The authors would also like to thank Senior Environmental Employees (SEE) John Dawkins, Robert King, and Bob Frazier for operating the continuous emission monitoring systems. The authors would also like to thank Wayne Rubey of the University of Dayton Research Institute for his invaluable help in performing the multi-dimensional gas chromatography analyses.

TABLE OF CONTENTS

ABSTRACT.....	ii
ACKNOWLEDGMENTS.....	iii
LIST OF FIGURES.....	vi
LIST OF TABLES.....	vii
1.0 INTRODUCTION.....	1-1
1.1 - Focus.....	1-1
1.2 - Regulatory Basis.....	1-1
1.3 - Surrogate Indicators.....	1-2
1.4 - Emission Characterization.....	1-2
1.5 - Limitations.....	1-3
2.0 EXPERIMENTAL APPROACH.....	2-1
2.1 - Focus.....	2-1
2.2 - Experimental Equipment.....	2-1
2.2.1 - Rotary Kiln Incinerator Simulator.....	2-1
2.2.2 - Flue Gas Cleaning System.....	2-2
2.3 - Waste Feed.....	2-3
2.4 - Sampling Approach.....	2-4
2.4.1 - General Sampling Information.....	2-4
2.4.2 - Continuous Emissions Monitors.....	2-7
2.4.3 - On-Line GC.....	2-7
2.4.4 - Volatile Organics.....	2-8
2.4.5 - Semivolatile and Non-Volatile Organics.....	2-9
2.4.6 - PCDDs/PCDFs.....	2-10
2.5 - Analytical Approach.....	2-10
2.5.1 - General Analytical Information.....	2-10
2.5.2 - Volatile Organics.....	2-10
2.5.3 - Semivolatile and Non-Volatile Organics.....	2-11
2.5.4 - PCDDs/PCDFs.....	2-12
3.0 RESULTS AND DISCUSSION.....	3-1
3.1 - Results from Continuous Measurements.....	3-1

3.2 - Volatile Organic Results.....	3-3
3.2.1 - On-Line GC Results.....	3-3
3.2.2 - VOST and Tedlar Bag Results.....	3-5
3.3 - Semivolatile and Non-Volatile Organics.....	3-16
3.3.1 - Conventional GC/MS Analytical Results.....	3-16
3.3.2 - Multi-Dimensional GC/MS Analytical Results.....	3-22
3.4 - PCDDs/PCDFs and PBDDs/PBDFs.....	3-23
3.5 - Surrogate Performance Indicators.....	3-25
4.0 CONCLUSIONS.....	4-1
4.1 - Target Analyte List.....	4-1
4.2 - Effect of Presence of Bromine.....	4-2
4.3 - Surrogate Performance Indicators.....	4-2
4.4 - Implications of These Results.....	4-3
4.5 - Recommendations.....	4-3
5.0 REFERENCES.....	5-1
APPENDIX A: QUALITY CONTROL EVALUATION REPORT.....	A-1
A.1 - Continuous Measurement Results.....	A-1
A.2 - Volatile Organic Compound Analyses.....	A-2
A.2.1 - VOST Samples.....	A-2
A.2.2 - Tedlar Bag Samples.....	A-3
A.3 - Semivolatile Organic Compound Analyses.....	A-3
A.4 - PCDD/PCDF and PBDD/PBDF Analyses.....	A-4
A.5 - Online GC Samples.....	A-5

LIST OF FIGURES

Figure 2-1. Rotary kiln incinerator simulator.....	2-2
Figure 2-2. Flue gas cleaning system.....	2-3
Figure 2-3. Metal solution injection system.....	2-6
Figure 2-4. On-line GC system.....	2-8
Figure 2-5. MDGC-MS Setup (Courtesy of UDRI).....	2-12
Figure 3-1. OLGc results of tetrachloroethylene concentrations at choke and SCC exit.....	3-3
Figure 3-2. OLGc results of 1,2 dichlorobenzene concentrations at choke and SCC exit.....	3-5
Figure 3-3. Average concentrations of analogous C ₁ and C ₂ halogenated compounds.....	3-15
Figure 3-4. MDGC/MS Analysis of Methylene Chloride Extract from Run 10. The upper trace is for the single-column, "one-dimensional" analysis. "Two dimensional" resolution of a singlet and a doublet are shown. (Courtesy of UDRI).....	3-22
Figure 3-5. Trichloroethylene vs. Total PCDDs; $R^2=0.6476$	3-25
Figure 3-6. Trichloroethylene vs. Total PCDFs; $R^2=0.6956$	3-26
Figure 3-7. Trichloroethylene vs. Total PCDDs+PCDFs; $R^2=0.6915$	3-26

LIST OF TABLES

Table 2-1. Waste Feed Composition.....	2-5
Table 2-2. Test Conditions.....	2-6
Table 2-3. Samples Taken During Each Test for Which Analytical Results Are Available.....	2-7
Table 3-1. Temperature Results (°C).....	3-1
Table 3-2. CEM Emissions Results.....	3-2
Table 3-3. On-line Gas Chromatograph Results for Volatile Organic PICs ($\mu\text{g}/\text{m}^3$).....	3-4
Table 3-4. Tedlar Bag Results: Target Compounds ($\mu\text{g}/\text{m}^3$).....	3-6
Table 3-5. Tedlar Bag Results: Tentatively Identified Compounds ($\mu\text{g}/\text{m}^3$).....	3-7
Table 3-6. VOST Results ($\mu\text{g}/\text{m}^3$).....	3-8
Table 3-7. Target Volatile Organic Compounds Detected.....	3-10
Table 3-8. Tentatively Identified VOST Compounds.....	3-11
Table 3-9. Combinations of Detected C ₁ and C ₂ Compounds.....	3-12
Table 3-10. C ₁ & C ₂ Halogenated Hydrocarbons ($\mu\text{g}/\text{m}^3$).....	3-14
Table 3-11. Halogenated Aromatic VOC Results ($\mu\text{g}/\text{m}^3$).....	3-16
Table 3-12. Semivolatile Organic Target Results ($\mu\text{g}/\text{m}^3$).....	3-17
Table 3-13. Semivolatile Organic Tentatively Identified Compounds ($\mu\text{g}/\text{m}^3$).....	3-20
Table 3-14. Compounds identified via MDGC/MS.....	3-23
Table 3-15. Polychlorinated and Polybrominated Dioxins and Furans.....	3-24
Table A-1. Data Quality Indicator Summary for Critical Measurements.....	A-2

1.0 INTRODUCTION

1.1 - Focus

Assessing the risk posed by combustor emissions requires sampling and analysis of what is leaving the stack. The chemical analysis must be compound specific in order to consider the toxicity of each compound. Efficient and cost effective sampling and analysis for routine regulatory control requires a target analyte list to focus the effort. A list of Products of Incomplete Combustion (PICs) suitable for focusing this effort is not well developed. The primary goal of this project is to develop such a list. This list will help serve as a basis for EPA's Office of Solid Waste (OSW) to pursue a PIC-based regulatory approach.

In the past, the Appendix VIII¹ list of hazardous compounds has become the *de facto* list for hazardous waste combustor (HWC) investigations. The Appendix VIII list was generated by appending lists of chemicals that were previously regulated by other government agencies (U.S. Department of Transportation (DOT) shipping labels, etc.). And, as such, it is not a list of compounds well focused to HWC stack emissions. Moreover, this list focuses on compounds possessing hazardous characteristics that are most often the Primary Organic Hazardous Constituents (POHCs). As a result, existing required analytical methodologies focus on measuring the POHC. Very few PICs that are formed are targeted by current analytical methodologies. Analytical methodologies capable of identifying and quantifying PICs are required. This effort avoids the focus provided by Appendix VIII by approaching the task with an open mind in order to establish a list of compounds of importance to HWC emissions.

As a starting point, this study used existing trial burn data, laboratory-scale research literature, and, where relevant, target analyte lists based on Appendix VIII and the hazardous air pollutant (HAP) list from the 1990 Clean Air Act Amendments². It must be stressed, though, that this was only a starting point. The vast majority of the effort for this study was consumed in identification and quantification of unknown compounds.

1.2 - Regulatory Basis

HWCs have been regulated by the Resource Conservation and Recovery Act (RCRA),³ based on the destruction and removal efficiency (DRE) of POHCs as defined in a trial burn. This approach used the initial decomposition of the POHC, the first step in converting the organic POHC molecule to carbon dioxide (CO₂) and water (H₂O), as a surrogate for the extent of complete conversion to CO₂ and H₂O. The goal of reducing the toxicity of the hazardous constituents requires many reactions (chlorobenzene has 12 bonds to break and 18 new bonds to make) to completely react to CO₂ and H₂O. If the reaction sequence goes to completion, the toxicity is reduced completely (i.e., CO₂ and H₂O are not toxic). However, partial destruction can mute the reduction in toxicity, and reformation reactions can occur that cause molecular size growth; these can also mute the reduction in toxicity or, in some cases, increase the toxicity from that of the original organic molecule being incinerated⁴. Additionally, chlorine from the hazardous waste, released in the form of hydrochloric acid (HCl) or diatomic chlorine (Cl₂), can react with naturally occurring hydrocarbons in the cool end of some incineration facilities (e.g., cement kilns) and generate potentially toxic hazardous organic compounds⁵. A new PIC-based approach can potentially avoid these problems associated with the POHC DRE approach.

Current regulatory approaches use carbon monoxide (CO) as a surrogate for PICs. This approach is based on the assumption that the oxidation of CO to CO₂ is the final step in the long chain of complex combustion reactions. Minimization of CO thus is assumed to minimize PICs. Unfortunately, this assumption does not hold up well when polychlorinated dibenzo-p-dioxins and polychlorinated dibenzofurans (PCDDs/PCDFs), which are generally formed in the cooler regions of the incinerator, are taken into account. In the case where PCDDs and PCDFs constitute a significant component of the organics-based toxicity of the mixture, the "CO-as-a-PIC-surrogate" approach breaks down. CO appears to be a viable surrogate to distinguish between "poor" combustion and "good" combustion, but as emissions limits get lower and lower, CO is not a reliable surrogate to distinguish between "good" combustion and "great" combustion. At that point, other parameters have a much more significant influence on the emissions of PCDDs/PCDFs, such as the temperature at which the particulate control device operates.⁶ In other words, minimization of CO is a necessary, but not sufficient condition for PIC minimization.

1.3 - Surrogate Indicators

A surrogate incinerator performance indicator is an easily measured parameter, compound, or group of compounds whose variance can account for the variance in the measurements of a more difficult-to-measure compound, such as PCDDs/PCDFs. Although this work will not be used directly to develop surrogate indicators of performance, it will lay ground work for that purpose. The task of choosing a surrogate indicator of performance implies that a significant PIC of concern (one that can significantly influence the results of a risk assessment) is known. PCDDs/PCDFs have gained notoriety as being potentially significant PICs in many cases, although some critics have suggested that PCDDs/PCDFs are the most important PICs simply because they are the class of PICs most frequently investigated. The problem that exists is that PCDDs/PCDFs are present at the low parts-per-trillion (ppt) levels in the stacks of a well-operated combustion facility. Sampling and analytical procedures to measure PCDDs/PCDFs are expensive and time consuming. If an easily measured surrogate were available that gave a strong correlation with PCDDs/PCDFs, routine compliance tests could potentially be replaced by continuous or semi-continuous monitoring of that surrogate. In addition, the process could be optimized based on continuous measurements of that surrogate.

1.4 - Emission Characterization

An additional issue this work may help to address is that of "what fraction of the emissions are toxic and what fraction are low or non-toxic?" By attempting to quantify as large a percentage of the mass of organic emissions as possible (in a research level effort) it may be possible to get a better handle on the question. The public has been quick to assume that the unidentified compounds are hazardous; since they have not been identified it is not possible to assure the public that they are of low toxicological significance. This research effort and the Omnibus regulatory effort intend to identify and quantify both the toxic and low/non-toxic compounds to the extent possible. It is expected that the bulk of the emissions will be low molecular weight low/non-toxic compounds.

Although PCDDs/PCDFs, due to their high toxicity⁷, are likely to be the most toxic organic hazard in the HWC stack, they are typically present in minute quantities. In addition, there may be entire classes of PICs that are not even being measured, some of which could potentially influence the risk assessment calculations. The conservative nature of risk assessment assumes that unknown

compounds are toxic. Because of this, risk assessment uncertainties can be influenced not only by not detecting PICs that are important from a toxicological point of view, but also by not detecting harmless compounds that potentially comprise much of the mass of stack emissions. Sampling and analytical methodologies may not be sufficiently developed to generate reliable emissions data. Compounds that fall into this category are the brominated and bromochloro analogs to PCDDs/PCDFs (the polybrominated dibenzo-p-dioxins and polybrominated dibenzofurans [PBDDs/PBDFs] and mixed bromochloro dibenzo-p-dioxins and mixed bromochloro dibenzofurans [PXDDs/PXDFs]), and polycyclic aromatic hydrocarbons (PAHs) substituted with various species (oxygen, chlorine, sulfur)⁸. Another issue is the measurement of compounds such as phthalates, which are frequently detected in HWC emissions, but may be artifacts of sampling and analytical treatments.

1.5 - Limitations

The experiments were performed on EPA's rotary kiln incinerator simulator (RKIS) located in Research Triangle Park, NC. Exact quantification of concentrations was not a primary goal for this study. A more important goal was to derive a detailed list of target compounds that can be found at levels above the detection limits. The existing database of PIC data from bench, laboratory, pilot, and full-scale was used as a starting point for development of this list.

It is critical to understand that all quantified PICs generated in this study are based on the pilot-scale RKIS, burning the chosen waste mix, at the given conditions, prior to any flue gas cleaning equipment. The RKIS is a small pilot-scale kiln, and many of the fluid mechanical features of full-scale kilns that can produce excess emissions are not present in the RKIS. As such, the system sometimes needs to be operated slightly outside what would constitute normal incinerator operating conditions in order to properly quantify important emission trends and measure subtle phenomena. It is believed that this system generates qualitatively applicable data, although emissions results from the RKIS should not be quantitatively compared to full-scale systems.

2.0 EXPERIMENTAL APPROACH

2.1 - Focus

The emphasis of this effort was placed on analytical operations rather than sampling operations. The sampling methods selected were appropriate for the quantitative capture of volatile, semivolatile, and non-volatile organics. The issue was how to retrieve and analyze the organic compounds captured by these methods. Both standard and non-routine approaches were used. Methods development/validation was not within the scope of this project. It must be reiterated that the emphasis of this project was to identify PICs that are not routinely identified by conventional methodologies. Once these PICs have been identified and their relative toxicological importance evaluated, emphasis can more appropriately be placed on method development and validation.

Certain samples, such as those collected using SW-846 Draft Method 0040⁹ (Tedlar bags) or Method 0030¹⁰ (VOST), must be analyzed soon after the samples have been taken. These analyses were performed within 24 hours. Other samples, though, such as Method 0010¹¹ (MM5) or Method 23¹², can be stored for a longer time after extraction of the sampling media. In addition, since this effort was directed at identification of the multitude of unknowns in the semivolatile and non-volatile fraction, the majority of the effort was directed at the higher molecular weight compounds.

2.2 - Experimental Equipment

2.2.1 - Rotary Kiln Incinerator Simulator

The incineration tests were performed using the RKIS facility at the EPA's Air Pollution Prevention and Control Division's (APPCD's) combustion laboratory in Wing-G of the EPA's Environmental Research Center (ERC) located in Research Triangle Park, NC. The facility has a RCRA Research, Development, and Demonstration (RD&D) permit to burn actual and surrogate hazardous waste. The RKIS, shown in Figure 1, consists of a 73 kW (250,000 Btu/hr) rotary kiln section, a transition section, and a 73 kW (250,000 Btu/hr) secondary combustion chamber (SCC). The RKIS was designed for the testing of liquid and solid surrogate hazardous waste materials.

The RKIS was designed to contain the salient features of full-scale kilns, but still be sufficiently versatile to allow experimentation by varying one parameter at a time or controlling a set of parameters independently. The rotating kiln section contained a recess which contains the solid waste during incineration. The recess was designed with a length to diameter (L/D) ratio of 0.8, which is 20 to 25% of a full-scale system. The main burner, based on an International Flame Research Foundation (IFRF) variable swirl design, was the primary heat source for the system. Natural gas was used as the primary fuel during startup and idle, then was switched over to the surrogate waste feed used throughout testing.

From the kiln section, the combustion gases entered the transition section. The gases then flowed into the SCC. The SCC consisted of three regions: the mixing chamber, the plug flow section, and the stack transition section. A replaceable choke section separated the mixing chamber from the plug flow section.

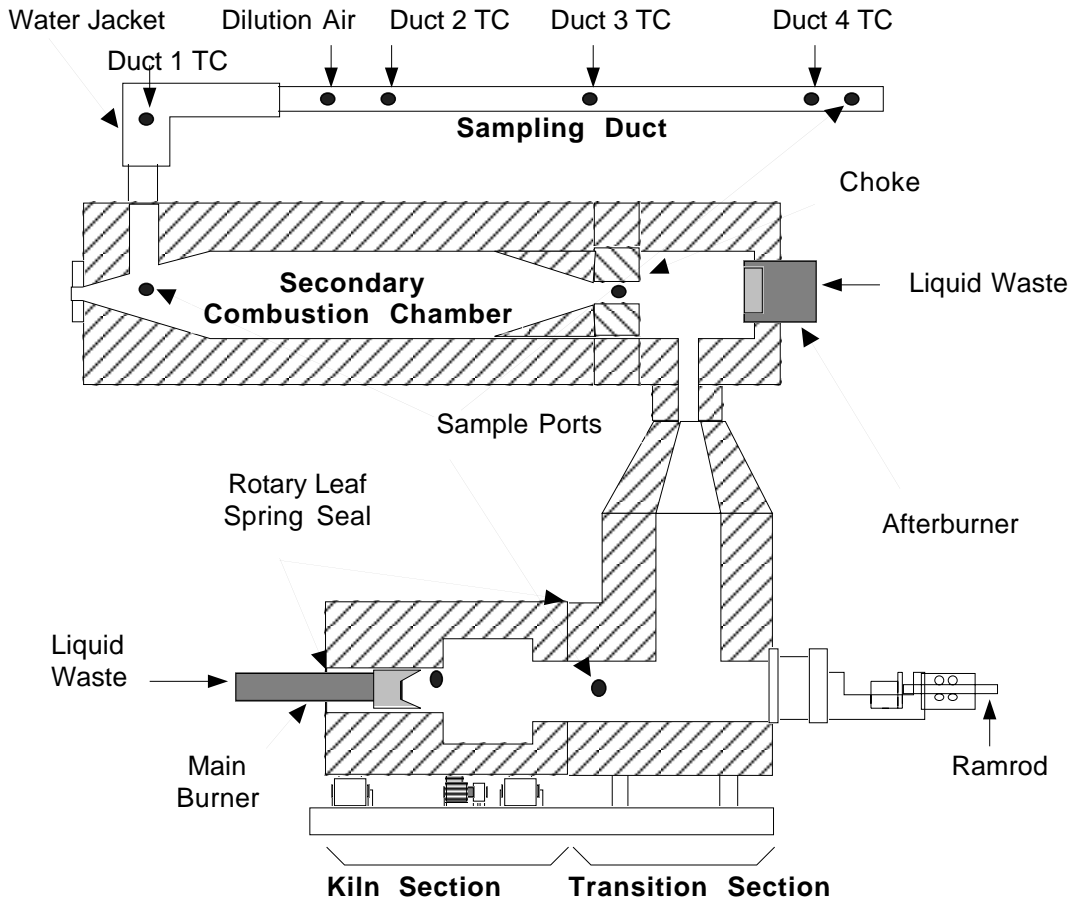

Figure 2-1. Rotary kiln incinerator simulator

A conical refractory insert was installed into the first plug flow sub-section to provide a gradual divergence from the choke diameter to the plug flow section diameter and minimize recirculation zones downstream of the choke. The afterburner, also based on an IFRF variable swirl design, provided heat and flame to the SCC, and was also fired with natural gas during startup and idle times, then switched to the liquid surrogate waste during the tests.

Combustion gases exiting the afterburner passed through a water-jacketed convective cooling section of 20.3 cm (8-in nominal pipe thread [NPT]) diameter stainless steel (SS) ducting. Further cooling was achieved by adding ambient dilution air via a dilution damper located upstream of the 9.9-m (35-ft) sampling duct. Emissions samples were collected at sampling locations 66.7-cm (169.5-in) and 98.6-cm (250.5-in) downstream of the dilution damper. These sampling locations were oriented to meet isokinetic sampling requirements.

2.2.2 - Flue Gas Cleaning System

All of the research combustors in the Wing-G combustion research facility were manifolded into a common flue gas cleaning system (FGCS). The FGCS consisted of a 1.02 MW (3.5×10^6 Btu/hr) afterburner followed by a water quench, baghouse, and wet scrubber. The purpose of the

FGCS was to take exhaust gases from the research combustors, destroy any unburned organic material, and remove any particulates and acid gases from the effluents prior to their release to the atmosphere.

A roof-mounted induced-draft (ID) fan pulled exhaust gases from research combustors into a manifold. Flow direction of emissions was then determined by the position of a three-way valve. By-pass (vent fumes mode) flow feeds directly to the draft fan. The flow of fumes (permit mode) feeds through the afterburner, quench, baghouse, scrubber and draft fan.

Exhaust gases were oxidized at temperatures of 1000 °C (1,832 °F) or greater for at least 2 s in a natural-gas-fired Hirt afterburner. The exhaust gases of the afterburner were then cooled by a controlled water spray that is air-aspirated through a nozzle in the quench section. Particulate matter was then removed by filter cartridges in a baghouse. Acid gases were removed in the scrubber by a sodium hydroxide caustic solution that is sprayed into the exhaust stream. After exiting the draft fan, exhaust emissions are continuously monitored for CO₂, CO, and oxygen (O₂). The FGCS is depicted in Figure 2-2.

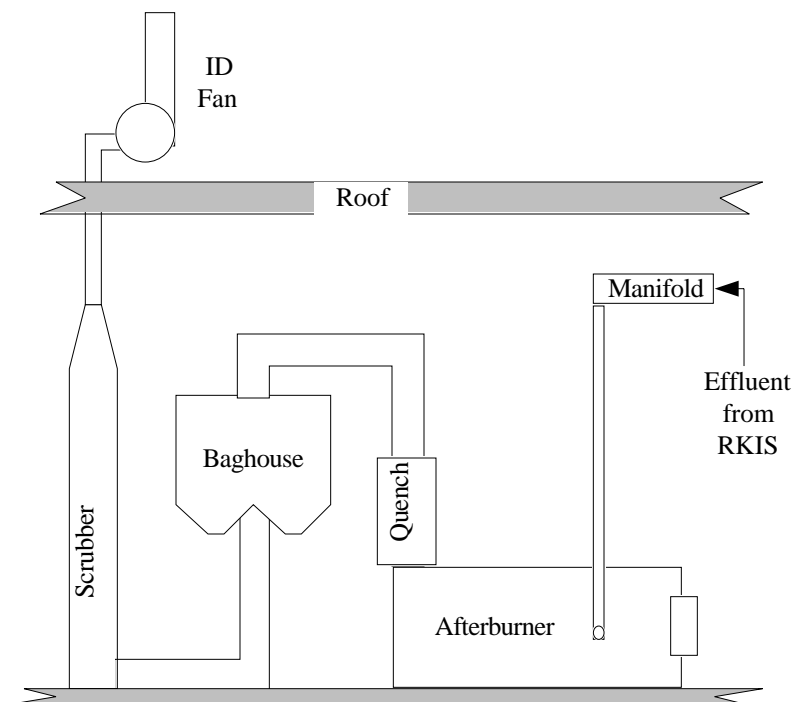

Figure 2-2. Flue gas cleaning system.

2.3 - Waste Feed

The surrogate hazardous waste that was fed during tests was designed to possess representative compounds from many common classes of organic hazardous wastes. The composition of the surrogate hazardous waste feed was developed based on recommendations from members of OSW and the Regional Permit Writers. Table 2-1 lists the composition of the surrogate waste feed. In addition to the organic surrogate waste, an aqueous mixture of metal salts, including zinc nitrate•hexahydrate, nickel nitrate•hexahydrate, and copper nitrate•hexahydrate, was also fed into

the kiln. The purpose of the metals injection was to provide a representative supply of metal catalyst to promote any heterogeneous reactions forming PCDDs/PCDFs. Copper (Cu), nickel (Ni), and zinc (Zn) were fed as metal nitrate hexahydrate compounds dissolved in 100 mL/hr of water with sufficient metal present to reach the target gas-phase concentrations of $60 \mu\text{g}/\text{m}^3$ (Cu), $40 \mu\text{g}/\text{m}^3$ (Ni), and $90 \mu\text{g}/\text{m}^3$ (Zn).

Hazardous wastes are burned in blended mixtures of many waste streams. These tests were designed to mimic this complexity. The principal purpose of this work was to establish a list of possible compounds that should be investigated as PICs from hazardous waste incineration. In order to have as many compounds on the list as possible, the feed stream was designed to have several organic compounds of several different classes in its makeup. Additionally, since as much of the effort as possible was to be directed at analysis, the cost of the waste feed was designed to be held to as low a level as possible. In addition, it was required that personnel safety be maximized.

With the exception of runs where batch feeding occurred, all runs were performed using the same standard mix of compounds. The nominal chlorine (Cl) content of the waste was 10 % by weight. The waste consisted of a mixture of several compounds co-fired with No. 2 fuel oil. Some brominated organic compounds were substituted for a fraction of the chlorinated compounds. The composition of the waste that was fed is shown in Table 2-1. Note that too much dibromoethane was inadvertently added in Run 10, resulting in a bromine (Br) mass percent 3 times the intended level.

In addition, some of the tests involved batch charging of containerized liquid wastes. The charges consisted of 0.9 L (1 qt) polyvinyl chloride (PVC) containers filled with No. 6 fuel oil that had been doped with hexachlorobenzene (1000 ppm). This waste was fed in 10 minute intervals with the kiln rotating at 0.5 rpm.

During all runs, the kiln and afterburner burned the standard mix of wastes in both the primary and secondary burners, by pumping the makeup fuel (No. 2 fuel oil) from 55 gal. drums, and mixing it with the stream of waste compounds that are being pressure-fed from a 5 gal. container using pressurized nitrogen. The entire system was tied into the flame safety interlock system so that any flameout resulted in the waste feed's being cut off. Flow rates were measured using rotameters. The nominal experimental descriptions that were used are listed in Table 2-2. The combustion blanks consisted of samples taken while no waste was being fed.

The metals solution was injected into the primary combustion chamber using the apparatus shown in Figure 2-3.

2.4 - Sampling Approach

2.4.1 - General Sampling Information

The sampling methodologies and procedures used to conduct this study followed EPA-standardized test methods for the collection of volatile, semivolatile, and non-volatile organics. In general, the test procedures were followed as described in the reference method. Analytical results are not available for all runs for which sampling occurred. Table 2-3 lists the samples taken during the tests for which analytical results are available. With the exception of the continuous emission

monitors (CEMs), all extractive samples were taken at the sample ports in the horizontal duct between the RKIS and the FGCS. As shown in Figure 2-1, one set of CEMs sampled at the port located near the kiln exit; another set of CEMs sampled at the port located near the SCC exit; and the HCl CEM sampled just downstream of the sample port where all of the extractive organics sampling trains were located.

Table 2-1. Waste Feed Composition

Class	Compound	Formula	Mass %
carrier liquid	No. 2 fuel oil	n/a	50.0
chlorinated non-aromatic	methylene chloride	CH ₂ Cl ₂	8.0
	chloroform	CHCl ₃	4.5
	carbon tetrachloride	CCl ₄	2.4
chlorinated aromatic	monochlorobenzene	C ₆ H ₅ Cl	3.3
	dichlorobenzene	C ₆ H ₄ Cl ₂	3.8
	chlorophenol	C ₆ H ₅ ClO	1.5
non-chlorinated aromatic	toluene	C ₇ H ₈	5.2
	xylene	C ₈ H ₁₀	5.2
alcohol	isopropanol	C ₃ H ₈ O	2.4
ketone	methyl ethyl ketone	C ₄ H ₈ O	4.8
nitrated waste	pyridine	C ₅ H ₅ N	5.9
PAH ^a	naphthalene	C ₁₀ H ₈	1.5
brominated waste	bromoform	CHBr ₃	0.75
	ethylene dibromide	C ₂ H ₄ Br ₂	0.75 ^b

a - Polycyclic aromatic hydrocarbon.

b - On Run 10, too much ethylene dibromide was inadvertently added.

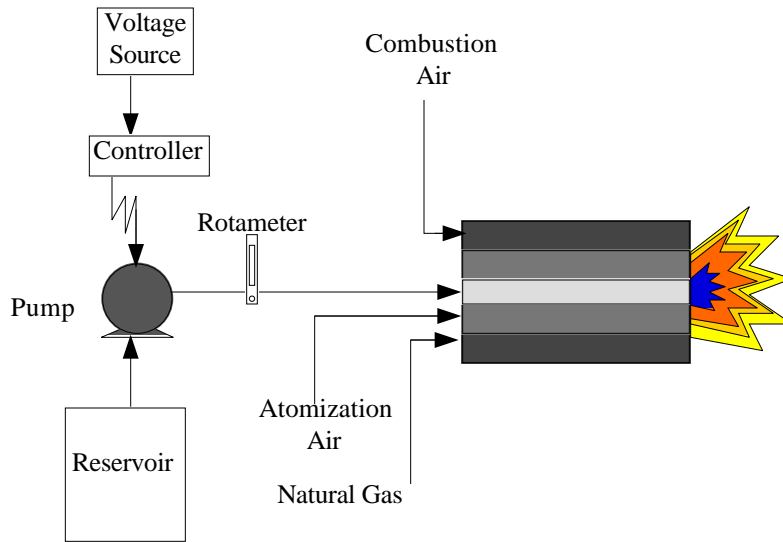

Figure 2-3. Metal solution injection system.

Table 2-2. Test Conditions.

Run	Description	Date
1	Combustion Blank	4/13/95
2	Combustion Blank	4/18/95
3	High Temperature	4/20/95
4	High Temperature	4/26/95
5	Baseline	5/3/95
6	Baseline	5/4/95
7	SCC Off	5/9/95
8	SCC Off	5/10/95
9	Low Temperature	5/12/95
10	Low Temperature	5/16/95
11	Fuel-Rich	5/23/95
12	Fuel-Rich	5/31/95
13	Fuel-Rich	8/14/95
14	Fuel-Rich	8/16/95
15	Batch Charging	8/21/95
16	Batch Charging	8/23/95

Table 2-3. Samples taken during each test for which analytical results are available.

Run	CEMs	Method 0040 Tedlar Bags	Method 0023 Dioxins	Method 0030 VOST	Method 0010 MM5	OLGC
1	X				X	
2	X				X	
3	X				X	X
4	X				X	X
5	X	X	X	X	X	
6	X	X	X	X	X	X
7	X			X		X
8	X			X		X
9	X	X	X	X	X	
10	X		X	X	X	
11	X			X	X	
12	X			X		
13	X		X	X	X	
14	X	X	X	X	X	
15	X			X	X	
16	X			X	X	

2.4.2 - Continuous Emissions Monitors

Two separate CEM benches provided simultaneous gas monitoring of O₂, CO₂, CO, nitric oxide (NO), and THC before and after the SCC. In addition to the two CEM benches, a Perkin Elmer/Bodenseewerk MCS 100 Emission Monitoring System (which is capable of measuring HCl, CO₂, and H₂O simultaneously and continuously under wet conditions) was available throughout most of the tests.

2.4.3 - On-Line GC

Volatile organic PIC emissions were measured on selected runs using an on-line gas chromatograph (OLGC) system, shown in Figure 2-4. The OLGC analytical system^{13,14} contained a heated sample delivery system, a purge and trap sample concentrating system, and the GC analytical system. The sample concentrating device was a Tekmar LSC-2000 thermal desorption unit that had been modified to accommodate the direct collection of combustion samples. The GC analytical system was a HP 5890 series II GC equipped with both flame ionization detector (FID) and an electron capture detector (ECD). The effluent of the column is split (ratio 9:1, respectively) to deliver sample to both the FID and ECD simultaneously. Nineteen individual volatile organic PICs can be quantified at concentration levels of about 1 ppbv. The OLGC sampled at two different locations: 1) at the choke in the SCC, and 2) near the exit of the SCC where the other CEMs sampled, in an attempt to measure changes in PICs as a function of residence time.

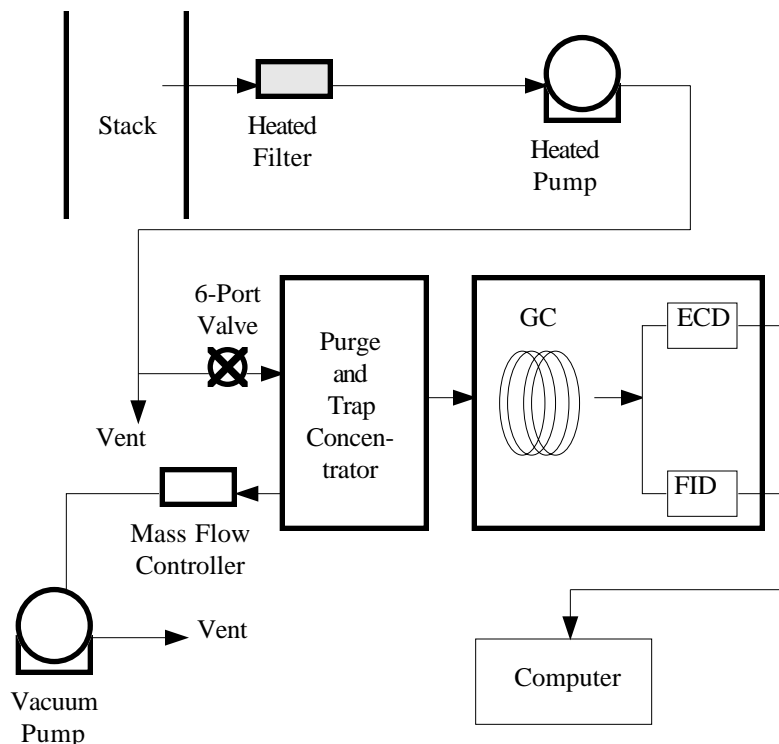

Figure 2-4. On-line GC system.

2.4.4 - Volatile Organics

Volatile organic compounds (VOCs) were collected using both the Volatile Organic Sampling Train (VOST – SW-846 Method 0030)¹⁰ and Tedlar bags (SW-846 Draft Method 0040)⁹. The VOST method is intended to be used for VOCs with boiling points (BPs) ranging from 30 to 110 °C. For the more volatile VOCs (BPs < 30 °C), Tedlar bag samples were collected.

VOST samples were collected as described in SW-846 "Test Methods for Evaluating Solid Waste" Method 0030 "Volatile Organic Sampling Train." Four sets of samples were collected for each test condition (two sets per test day). A total volume of ~ 20 L was collected for each sample. Sampling was performed at 0.5 L/min for 40 min. Liquid condensate samples were also collected daily for separate analysis.

The VOST tube sets were quality control (QC) checked for background contaminants by GC/MS under the same conditions used for actual sample analysis. The acceptable blank level was less than 10 ng for any single target analyte per tube. There is no established level for total VOC contamination. VOST tubes were conditioned in batches of seven sets. At least one set of tubes out of each batch of seven (14.3%) was QC checked.

Once the tubes were QC checked, the Tenax-only tubes were spiked with known quantities of D⁶-labeled benzene and bromofluorobenzene (BFB) as part of the quality assurance (QA) procedure for the sampling. The tubes were then individually placed in metal cigar tube-type containers which were secondarily placed in a metal container or glass jar containing activated charcoal. The secondary container was then kept in a refrigerator maintained near 0 °C until delivery for sampling. Following sampling, the tubes were returned to their respective individual containers

and then placed in a separate secondary container, also containing activated charcoal, and kept refrigerated until analyzed. All samples were analyzed within 30 days of collection.

Tedlar bag samples were collected as described in SW-846, "Test Methods for Evaluating Solid Waste," and Draft Method 0040, "Sampling of Principal Organic Hazardous Constituents from Combustion Sources Using Tedlar Bags." Only one sample was collected for each test condition. A total volume of ~ 20 L was collected for each sample. The liquid condensate was also collected for separate analysis.

The Tedlar bags were conditioned for use by sequentially filling the bags with nitrogen and then evacuating them with a vacuum pump. This conditioning process was performed at least three times or until the bags were demonstrated to be free of background contaminants. The bags themselves were QC checked for background contamination as described above. The nitrogen used for conditioning was also tested for background contamination. All bags used for sampling were QC checked. Once the bags were demonstrated to be free from background contamination, they were once again evacuated and stored at ambient temperature until used for sampling. Following sampling, the bags were resealed. All samples were analyzed within 72 h of collection.

2.4.5 - Semivolatile and Non-Volatile Organics

Semivolatile organic compounds (SVOCs) were collected using the Modified Method 5 (MM5)¹¹ train train as described in SW-846 "Test Methods for Evaluating Solid Waste" Method 0010 "Modified Method 5 Sampling Train." Two MM5 samples were collected for each test condition. Samples were collected on separate test days. The trains were operated isokinetically as required by the method. As stipulated in EPA 40 CFR Part 60 Method 1A, the Pitot tube was not attached to the probe. Radial sampling locations were based on the preliminary velocity traverse. A post-test velocity traverse was also performed. The pre- and post-test velocity traverses were used to assess isokinetic variation. The run times were increased to maximize the total volume sampled. A nominal run time of 4 hours was used. As no particulate measurements were made from this train, filters were not weighed. No other method deviations are anticipated.

The MM5 trains were recovered so as to generate five separate components for analysis:

1. The particulate filter (labeled Container 1)
2. The front-half rinse (labeled Container 2)
3. The back-half rinse – all train components between filter and sorbent module (labeled Container 5)
4. The XAD-2 module (labeled Container 3)
5. The condensate and condensate rinse of 1st empty impinger (labeled Container 4)

Note: Container labeling is consistent with Method 0010.

Given the high acid concentration of the sample stream, flushing the XAD-2 sorbent modules with high performance liquid chromatography (HPLC) grade water to remove the concentrated acid was required. This rinse was combined with the contents of Container 5.

The XAD-2 was cleaned and QC checked as described in Method 0010 with several additional solvents. The methylene chloride extraction was followed by acetone, toluene, and once again

methylene chloride extractions, respectively. The cleaned XAD-2 was subjected to background contamination quality control checks. Although the method requires that the XAD-2 blank exhibit a TCO level less than 10 µg/g, experience has shown that we can also outperform the recommended level of 4 µg/g, typically demonstrating background levels in the 1 µg/g range. The XAD-2 was also QC checked by GC/MS to screen for any target analyte background contaminants. No QC acceptance criteria have been established for this additional QC check, although less than 5 µg/sample (based on ~30 g sample) has been achieved for individual target analytes. Prior to sampling, 40 g of XAD-2 was packed into the sorbent modules, capped with glass stoppers, the ends wrapped in cleaned aluminum foil, and stored, refrigerated at 4° C until use. Following sample retrieval, the XAD-2 modules were stored in an identical manner. All samples were extracted within 30 days of sample collection.

2.4.6 - PCDDs/PCDFs

PCDDs/PCDFs were collected as described in 40 CFR, Part 60, Appendix A, Method 23 "Determination of Polychlorinated Dibenzo-p-dioxins and Polychlorinated Dibenzofurans from Stationary Sources"¹². This method is virtually identical to California Air Resources Board (CARB) Method 428 "Determination of Polychlorinated Dibenzo-p-dioxin (PCDD), Polychlorinated Dibenzofuran (PCDF), and Polychlorinated Biphenyl Emissions from Stationary Sources"¹⁵. The only real differences are in the analytical approach. The MM5 sampling train location and operation criteria presented above also apply to Method 23. The run times were increased to maximize the total volume sampled. All samples were extracted within 45 days of collection.

2.5 - Analytical Approach

2.5.1 - General Analytical Information

The analytical approach considered both screening and analyte-specific analytical techniques. A literature review of bench-, laboratory-, and pilot-scale incineration studies was used to help establish an expanded target analyte list. Similarly, target compound classes such as PAHs, that are made up of many more than the 16 or so compounds routinely targeted, were expanded to include alkylated, chlorinated, and nitrogenated PAHs that have harmful health effects. Sulfonated, oxygenated, and nitrogenated heterocyclic compounds were also targeted.

2.5.2 - Volatile Organics

The VOST and Tedlar bag samples collected were analyzed by gas chromatography/mass spectrometry (GC/MS) following the procedures described in SW-846 Methods 5040/8240^{16,17}. This method was suitable for the analysis of both sample types. Method 8240 quantifies compounds with BPs ranging from ~-30 to ~ 200 °C, encompassing the capabilities of both sampling methods. The Method 8240 target analyte list was modified/expanded to include additional potential PICs.

The resulting GC/MS total ion chromatograms were analyzed to identify peaks that were not target analytes. Nontarget PICs were identified by comparing spectral data of the unknown to spectral data contained in the National Institute of Standards and Technology (NIST) and Wiley mass spectral databases. A probability-based spectral matching algorithm assigned tentative

identification. The quality of the match, along with investigator spectral interpretation and physical data (e.g., boiling point vs. retention time) was used to assist in identification. Where possible, additional standards containing tentatively identified compounds were prepared and analyzed to confirm identification. Following Method 8240, these unknowns are quantified based on the internal standard closest in retention time and a relative response factor (RRF) of 1. A multiconcentration calibration was performed using standards of the identified compounds to establish RRFs specific to each compound to enhance quantitative accuracy.

The Tedlar bag samples were also analyzed to characterize the highly volatile organic species. The bag samples were analyzed by gas chromatography/flame ionization detector (GC/FID) to quantify such compounds as methane, ethane, propane, chloromethane, and acetylene. The FID response to nontarget analytes was also reported.

2.5.3 - Semivolatile and Non-Volatile Organics

A detailed chemical characterization was performed on the MM5 samples. MM5 analyses were performed quantitatively; however, the main emphasis was on qualitative identification of major emissions components.

Following collection, the MM5 samples were Soxhlet extracted sequentially with several solvents of decreasing polarity. The samples were extracted sequentially with methylene chloride, acetone, and toluene. The individual sample extracts were concentrated to a known volume and archived for analysis. The five containers from each sample train were extracted so as to generate three separate sample components. For each solvent, separate sample extracts were generated from each train. The filter and front-half rinse (Containers 1 and 2) were composited as a single extract as were the XAD-2 sorbent and back-half rinse (Containers 3 and 5). The condensate and condensate rinse (Container 4) is the third sample component. For methylene chloride, the extractions were performed as described in SW-846 Draft Method 5060, "Preparation of MM5 Train Components for Analysis by SW-846 Method 8270." The acetone and toluene extractions were performed similarly with only the filters and XAD-2 being extracted. Surrogates were added only to the MM5 train components.

After initial analyses were performed using conventional GC/MS, and significant unidentified peaks were found, an alternative analytical approach was taken. The methylene chloride extracts from Run 10 were sent to the University of Dayton Research Institute (UDRI), where the technique of multi-dimensional GC/MS (MDGC/MS) was used to further characterize the samples.

The MDGC/MS system used^{18,19} is shown in Figure 2-5. The uniqueness of the MDGC technique lies in the ability to further resolve coeluting peaks from the primary column on a secondary column. This system uses a "Deans switching mechanism" for obtaining narrow fractions (heartcuts) from a primary chromatogram. It uses a low-temperature cryogenically cooled trap at -80 °C and uses two 30 m X 0.25 mm open tube columns (OTCs) with a 0.25 µm film thickness. The primary column contained a non-polar 5% phenylmethylsiloxane stationary phase, while the secondary column used a moderately polar 1701 cyanosiloxane stationary phase. Using the second column with a stationary phase of differing polarity enables better separation of compounds that were not cleanly separated in the first column. The effluent from the secondary OTC was passed directly into an HP 5970B mass selective detector. Both OTCs were mounted inside an HP 5890 GC system.

2.5.4 - PCDDs/PCDFs

PCDDs/PCDFs were quantified from the Method 23 sampling train. This procedure is described in CARB Method 428. The PCDD/PCDF analyses were performed as described in Method 23 with only one exception: the analyses were performed by low resolution mass spectrometry (LRMS) as opposed to high resolution mass spectrometry (HRMS). The use of LRMS can generally quantify only different PCDD/PCDF congener groups, rather than individual isomers within the congener groups.

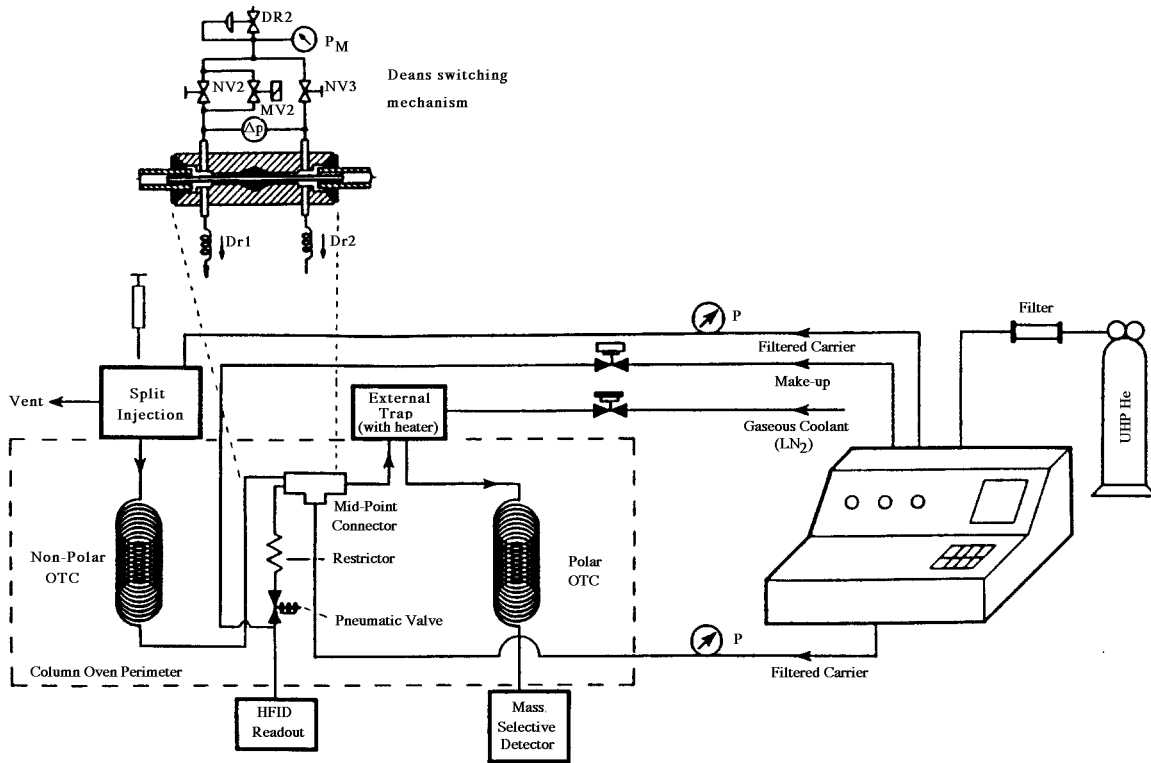

Figure 2-5. MDGC-MS Setup (Copyright © 1996; reproduced with permission of UDRI).

3.0 RESULTS AND DISCUSSION

3.1 - Results from Continuous Measurements

Results from temperature measurements made during the incineration tests are shown in Table 3-1. Note that the thermocouple at the kiln exit broke and was not operational for some of the tests. Also note that we had only mixed success in maintaining constant temperatures in the transition duct. This inability to hold the duct temperatures constant from run to run impacted our ability to develop surrogate performance indicators for PCDDs/PCDFs that are explicitly based on only combustion parameters. The temperatures labeled Duct 1, 2, 3, and 4 represent thermocouples placed at axial positions in the duct leaving the SCC. The Duct 1 thermocouple is just downstream of the water jacket, and the Duct 4 thermocouple is near where the extractive sampling was performed.

Table 3-2 lists the results from the conventional gas CEMs. The columns labeled CO Low and CO High represent the high- and low-range CO analyzers. For runs where CO values were within the normal operating range of the CO Low CEM, the data for the high-range CO analyzer were labeled n/a. The high concentration of acid gases damaged both THC CEMs, eventually resulting in the failure of both instruments (note the n/a's near the end of the test matrix). The HCl CEM was not available for the test days during August 1995. Note that the Duct CO₂ concentrations are approximately 50% of the CO₂ concentrations at the SCC Exit. This is due to dilution air's being added in the transition duct leading to the FGCS. Extractive samples were sampled downstream of the addition of dilution air.

Table 3-1. Temperature Results (°C)

Run	Kiln	SCC Mix	SCC Exit	Duct 1	Duct 2	Duct 3	Duct 4
1	886	890	1006	674	534	327	301
2	865	851	1054	701	552	334	305
3	698	796	1049	712	568	348	320
4	618	778	1007	681	543	333	307
5	470	592	863	548	433	259	236
6	554	632	932	589	462	277	251
7	532	517	497	339	280	218	193
8	495	492	459	313	264	210	186
9	n/a	485	624	387	302	228	193
10	n/a	457	578	352	272	211	181
11	n/a	697	845	488	369	280	243
12	n/a	695	899	548	406	297	258
13	911	567	856	524	370	279	240
14	939	612	867	520	362	263	230
15	925	574	836	554	397	312	272
16	945	562	848	559	403	312	273

Table 3-2. CEM Emissions Results

Run	Kiln Exit						SCC Exit						Duct		
	O2 (%)	CO2 (%)	CO Low (ppm)	CO High (%)	NO (ppm)	THC (ppm)	O2 (%)	CO2 (%)	CO Low (ppm)	CO High (%)	NO (ppm)	THC (ppm)	CO2 (%)	HCl (ppm)	H2O (%)
1	4.53	12.18	33	n/a ^a	190	0	4.25	11.84	41	n/a	148	0	6.69	0	6.59
2	3.79	12.8	27	n/a	217	0	3.51	13.07	46	n/a	150	0	6.98	2	4.93
3	7.73	10.19	25	n/a	540	0	7.09	10.63	30	n/a	454	1	3.13	1259	3.96
4	7.75	10.29	28	n/a	432	1	5.86	11.57	27	n/a	367	0	2.39	1034	2.55
5	9.96	8.3	107	n/a	439	13	8.54	8.91	42	n/a	371	0	5.44	2295	5.5
6	10.53	8.06	41	n/a	364	4	8.89	8.82	11	n/a	478	0	5.76	2577	6.01
7	7.68	10.2	35	n/a	439	3	13.4	5.53	40	n/a	265	10	6.24	2783	3.21
8	9.73	8.6	25	n/a	310	2	14.24	4.84	19	n/a	245	0	5.96	3289	3.78
9	13.77	5.58	37	n/a	162	7	13.15	5.51	306	0.05	229	8	6.34	2436	4.49
10	15.02	4.73	448	0.05	189	3	12.86	5.92	1310	0.14	290	0	5.44	2896	5.81
11	3.73	12.43	1917	0.65	116	33	1.33	14.26	968	0.22	186	59	11.53	5163	11.63
12	3.83	11.98	1891	0.92	108	0	1.47	13.89	1473	0.3	131	0	9.4	4084	9.95
13	2.76	13.2	1770	0.68	231	0	2.64	11.77	1011	0.25	183	0	0	n/a	n/a
14	0.93	14.69	1912	0.82	242	0	1.24	13.67	607	0.11	208	0	0	n/a	n/a
15	4.08	12.34	583	0.35	270	n/a	5.04	16.07	319	0.13	251	n/a	0	n/a	n/a
16	2.45	12.56	524	0.28	215	n/a	4.67	10.58	231	0.15	227	n/a	0	n/a	n/a

a - Not available

3.2 - Volatile Organic Results

3.2.1 - On-Line GC Results

OLGC sampling results are shown in Table 3-3. There are several interesting observations made from these measurements. First, all of the samples taken while no waste was being fed into the RKIS still showed measurable levels of many of the OLGC target analytes. This is likely due to residual contamination of the RKIS itself with some of the chlorinated PICs of interest.

Another observation is that the measurements made at the SCC choke are generally higher than the measurements at the SCC exit, particularly with respect to the chlorinated target analytes. The exception is on Runs 7 and 8, where the SCC's afterburner was off. It is likely that some ring growth was occurring as the gases from the kiln passed through the SCC when no flame was present in the SCC. This observation is illustrated in Figure 3-1, showing the concentration of tetrachloroethylene. Measured values of tetrachloroethene at the choke are consistently higher than at the SCC exit. Figure 3-2 shows this observation for 1,2-dichlorobenzene, a potentially important precursor to PCDDs/PCDFs. Note how the concentration of 1,2-dichlorobenzene is higher at the SCC exit for those runs where the afterburner was off. This shows the potential for significant ring growth to occur in the moderate temperature region of incinerators after the combustion sections, but prior to any heat recovery or rapid quenching.

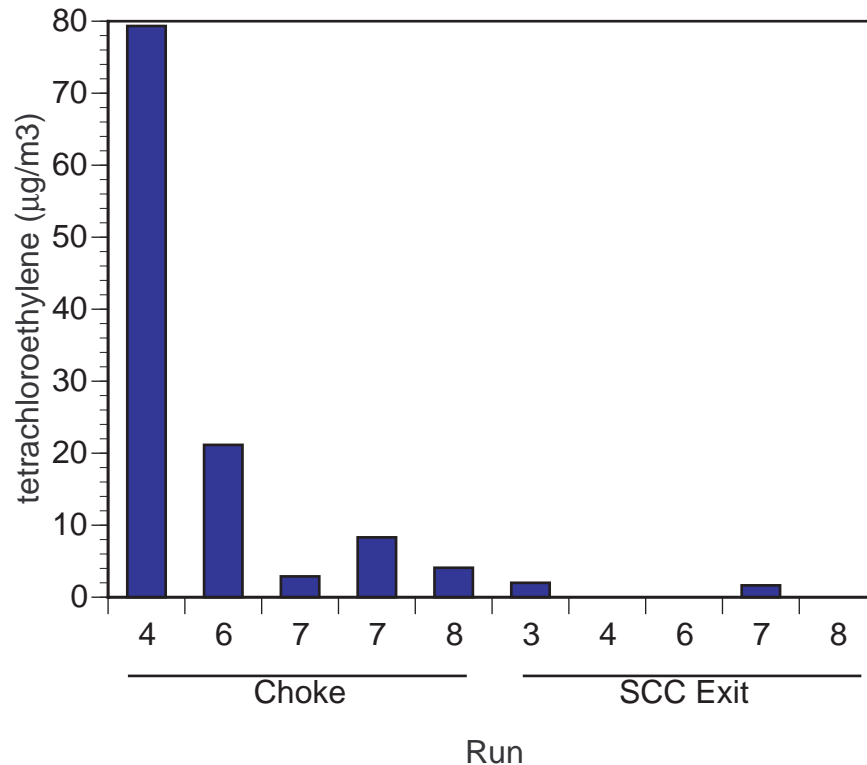

Figure 3-1. OLGC results of tetrachloroethylene concentrations at choke and SCC exit.

Table 3-3. On-line Gas Chromatograph Results for Volatile Organic PICs ($\mu\text{g}/\text{m}^3$)

Run	chloromethane	vinyl chloride	1,1 dichloroethene	methylene chloride	t-1,2 dichloroethylene	chloroform	1,1,1 trichloroethane	carbon tetrachloride	benzene	1,2 dichloroethane	trichloroethylene	toluene	tetrachloroethylene	chlorobenzene	ethyl benzene	m,p xylenes	styrene	1,3 dichlorobenzene	1,2 dichlorobenzene
3B ^a	32.0	ND ^b	ND	ND	6.0	ND	ND	ND	ND	ND	ND	3.0	2.0	ND	ND	ND	1.6	ND	ND
3	24.8	ND	ND	ND	9.0	ND	ND	ND	ND	ND	ND	4.4	2.0	ND	ND	2.0	2.9	2.7	1.1
4	3.8	23.4	ND	ND	ND	2.0	0.9	ND	ND	ND	ND	ND	ND	ND	ND	ND	2.1	ND	ND
4C ^c	23.6	ND	9.6	ND	ND	37.5	ND	38.3	4.3	ND	15.9	4.3	79.3	1.7	ND	ND	7.3	30.2	75.9
6B	ND	ND	6.8	ND	ND	ND	ND	ND	ND	ND	ND	ND	ND	ND	ND	ND	ND	ND	ND
6	ND	ND	13.0	ND	ND	ND	16.1	ND	ND	ND	ND	11.1	ND	ND	ND	3.5	ND	ND	ND
6C	ND	44.9	17.4	ND	ND	ND	ND	25.6	5.0	ND	11.6	ND	21.2	14.3	ND	ND	ND	25.9	150.9
7B	ND	ND	ND	ND	ND	ND	ND	ND	ND	ND	1.17	ND	1.7	ND	ND	ND	ND	ND	ND
7	ND	ND	ND	ND	ND	26.6	5.8	8.5	ND	ND	1.9	ND	1.7	5.6	ND	ND	ND	6.2	6.8
7C	ND	ND	ND	ND	ND	22.9	10.6	27.7	ND	ND	3.4	ND	8.3	ND	ND	ND	ND	ND	ND
7C	ND	ND	ND	ND	ND	21.9	2.3	17.7	3.5	ND	0.7	ND	2.9	ND	ND	ND	ND	8.6	ND
8B	ND	ND	ND	ND	ND	ND	ND	ND	ND	ND	ND	ND	ND	ND	ND	ND	ND	ND	ND
8BC	ND	ND	ND	ND	ND	ND	11.0	9.0	ND	ND	3.1	ND	11.0	ND	ND	3.4	ND	ND	15.3
8	ND	ND	ND	ND	ND	ND	ND	ND	3.7	ND	ND	6.8	ND	11.8	ND	3.2	ND	ND	49.1
8C	ND	ND	ND	ND	ND	ND	8.0	66.8	ND	ND	3.8	ND	4.1	ND	ND	ND	ND	ND	16.2

a - sample taken as combustion blank prior to initiation of waste feed.

b - not detected.

c - sample taken at SCC choke.

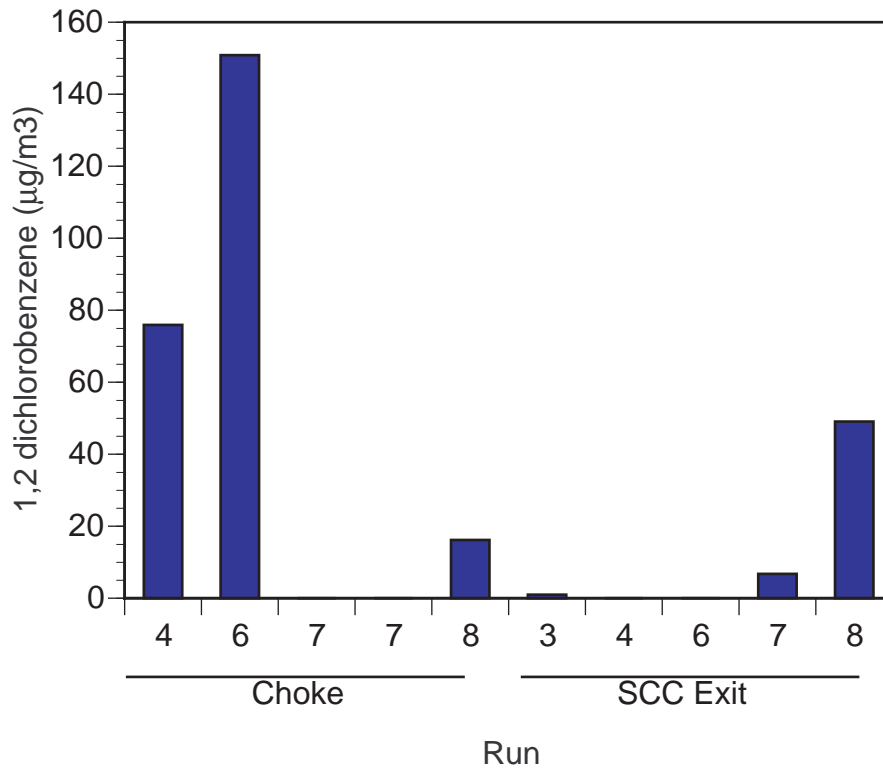

Figure 3-2. OLGC results of 1,2 dichlorobenzene concentrations at choke and SCC exit.

3.2.2 - VOST and Tedlar Bag Results

Analyses of the Tedlar bag samples for C₁ and C₂ non-halogenated alkanes, alkenes, and alkynes resulted in none of those compounds being detected. Estimated minimum detection limits are on the order of 1 - 2 ppm, and apparently none of these compounds were present at these levels. This is consistent, however, with our measured THC concentrations on the order of 1-2 ppm.

The VOST and Tedlar bag analytical results indicate that a significant number of VOC PICs have been identified both as target analytes and as tentatively identified compounds (TICs). Table 3-4 shows the Tedlar bag results for the target analytes, and Table 3-5 shows the Tedlar bag TIC results. VOST results are shown in Table 3-6. The VOST target analyte results are displayed qualitatively in Table 3-7, showing which of the VOST target analytes were detected. Table 3-8 qualitatively lists the VOST TICs. Although differences exist in quantitation levels between VOST and the Tedlar bags, it must be remembered that VOST samples are taken over longer periods of time. Of the 44 target analytes, 38 were detected. It should be noted that several of these compounds are POHCs. Over 50 nontarget analytes were tentatively identified as PICs. However, a large number of PICs present in the VOST samples were not identified. To aid in perspective, at least 82 compounds were detected in a single sample. Of those, 28 were identified as target analytes, 21 were tentatively identified, and 33 remained unidentified.

Table 3-4. Tedlar Bag Results: Target Compounds ($\mu\text{g}/\text{m}^3$)

Run	5	6	9	14
chloromethane	18742	2827	1	55
vinyl chloride	ND	ND	ND	ND
bromomethane	8304	667	ND	29
chloroethane	ND	18	ND	ND
1,1-dichloroethene	ND	ND	ND	ND
iodomethane	ND	ND	ND	ND
carbon disulfide	ND	ND	6	33
acetone	ND	1703	137	288
methylene chloride	ND	116	ND	28
1,2-dichloroethene	ND	ND	ND	ND
1,1-dichloroethane	ND	ND	ND	ND
chloroform	ND	50	ND	ND
1,2-dichloroethane	ND	ND	ND	ND
2-butanone	569	232	46	28
1,1,1-trichloroethane	ND	ND	ND	ND
carbon tetrachloride	75	65	ND	ND
benzene	232	64	5	11
trichloroethene	19	ND	ND	ND
1,2-dichloropropane	ND	ND	ND	ND
dibromomethane	ND	5	ND	ND
bromo dichloromethane	15	16	ND	ND
cis-1,3-dichloropropene	ND	ND	ND	ND
2-hexanone	ND	ND	ND	ND
trans-1,3-dichloropropene	ND	ND	ND	ND
1,1,2-trichloroethane	ND	ND	ND	ND
dibromochloro-methane	ND	17	ND	ND
1,2-dibromoethane	ND	7	ND	ND
bromoform	15	22	ND	ND
4-methyl-2-pentanone	ND	ND	ND	ND
toluene	27	16	ND	21
tetrachloroethene	ND	ND	ND	20
chlorobenzene	ND	20	ND	ND
ethylbenzene	9	3	ND	ND
1,1,1,2-tetrachloroethane	ND	ND	ND	ND
m,p-xylene	30	8	ND	ND
o-xylene	12	4	ND	ND
styrene	14	4	10	ND
1,1,2,2-tetrachloroethane	ND	ND	ND	ND
1,2,3-trichloropropane	ND	ND	ND	ND
trans-1,4-dichloro-2-butene	ND	ND	ND	ND
pentachloroethane	ND	ND	ND	ND
1,2-dibromo-3-chloropropane	ND	ND	ND	ND

Table 3-5. Tedlar Bag Results: Tentatively Identified Compounds ($\mu\text{g}/\text{m}^3$)

Run	5	6	9	14
1,1-dimethoxy ethane	ND	489	ND	ND
1,2-dichlorobenzene	ND	71	ND	ND
1-pentene 3-methyl 2-ethyl	ND	ND	19	357
1-phenyl ethanone	443	296	ND	ND
2-methyl 1-propene	ND	ND	9	175
2-nitrophenol	81	ND	ND	ND
3-methylene pentane	ND	ND	ND	130
3-methyl heptane	ND	ND	6	80
3-methyl pentane	ND	ND	20	2490
3-methylene nonane	ND	ND	7	ND
acetaldehyde	ND	ND	ND	164
benzaldehyde	481	218	ND	ND
benzoic acid methyl ester	325	68	ND	ND
benzonitrile	122	194	ND	ND
cyclohexane	ND	ND	ND	339
dodecane	ND	ND	17	ND
hexane	2402	ND	661	3904
methyl cyclopentane	4850	ND	ND	4896
nitromethane	1223	ND	ND	ND
tetrahydrofuran	7836	ND	96	ND
tridecane	ND	61	ND	ND
trimethyl hexane	ND	ND	77	ND
undecane	103	ND	32	ND

Table 3-6. VOST Results ($\mu\text{g}/\text{m}^3$)

	5	6	7	8	9	10	11	12	13	14	15	16
	Run											
dichlorodifluoromethane	819.6	418.5	50.2	257.9	2.3	0.1	0.6	14.7	2.3	11.4	169.0	1.9
chloromethane	1066	2.0	0.8	4.8	12.6	2.7	5.6	142.8	16.2	3.5	41.5	19.1
vinyl chloride	1.7	0.1	0.7	0.9	11.3	42.3	1.8	94.8	4.5	3.6	44.0	20.0
bromomethane	197.4	6.2	4.1	9.9	27.6	1.7	12.5	74.3	2.3	2.4	12.0	11.0
chloroethane	7.5	0.4	0.1	1.7	0.8	0.1	1.1	2.3	0.1	0.4	1.7	0.9
trichlorofluoromethane	5.9	12.3	0.6	0.7	0.3	ND	0.03	0.2	ND	ND	0.1	0.1
1,1-dichloroethene	6.6	ND	0.9	2.0	46.3	15.4	1.9	56.1	0.7	0.6	5.6	4.8
iodomethane	0.3	0.3	ND	ND	ND	ND	0.1	0.2	0.1	ND	ND	0.6
carbon disulfide	17.4	2.5	1.3	4.7	1.7	0.3	4.6	3.6	1.2	1.5	81.7	31.6
acetone	15.8	8.4	7.1	6.0	2.4	0.3	3.2	37.3	1.6	2.4	4.6	3.5
methylene chloride	26.9	42.7	10.3	15.8	3.3	2.3	3.8	59.5	10.5	13.5	73.6	39.0
1,2-dichloroethene	1.0	ND	0.2	0.4	15.9	1.9	3.6	44.3	1.1	4.6	26.6	23.5
1,1-dichloroethane	ND	0.1	ND	0.1	ND	ND	0.03	0.1	ND	ND	0.1	0.1
chloroform	15.9	26.7	5.5	7.7	9.9	6.3	11.7	19.5	2.1	4.8	19.9	30.8
1,2-dichloroethane	0.7	0.4	ND	0.2	0.2	1.0	1.1	11.0	1.4	1.0	5.5	8.4
2-butanone	2.6	2.4	0.6	0.6	ND	1.0	0.7	0.7	0.7	0.7	ND	1.3
1,1,1-trichloroethane	0.3	0.5	0.1	0.2	0.1	0.1	0.1	0.2	ND	ND	ND	0.1
carbon tetrachloride	6.7	22.7	5.0	29.6	152.4	297.9	8.5	13.9	1.4	1.9	24.5	28.8
benzene	1.9	1.1	1.2	2.1	1.4	268.9	26.0	7.0	36.6	226.7	218.6	221.2
trichloroethene	1.7	0.3	0.7	2.0	40.1	96.2	13.8	54.2	24.4	32.3	52.4	54.8
1,2-dichloropropane	ND	0.1	ND	0.1	ND	ND	0.03	0.1	1.7	1.9	0.1	0.2
dibromomethane	1.4	0.8	4.0	12.2	3.8	201.1	7.4	11.5	1.7	0.8	8.3	9.2
bromodichloromethane	2.4	2.6	5.3	9.5	35.1	165.2	12.6	13.0	2.2	4.4	19.7	27.5
cis-1,3-dichloropropene	ND	0.1	ND	ND	0.1	ND	0.2	0.2	ND	ND	0.7	0.9
2-hexanone	ND	0.2	ND	ND	ND	ND	ND	ND	ND	0.4	ND	ND
trans-1,3-dichloropropene	ND	0.2	ND	ND	0.4	ND	0.3	0.3	ND	ND	0.6	0.8
1,1,2-trichloroethane	0.1	ND	ND	ND	ND	ND	ND	0.7	0.1	ND	ND	ND
dibromochloromethane	3.1	3.3	6.4	14.2	43.4	223.2	11.2	5.1	0.4	2.1	15.0	26.4
1,2-dibromoethane	1.6	8.0	0.3	1.9	1.9	109.7	1.9	7.6	1.2	0.5	62.8	39.6
bromoform	16.7	19.4	37.8	44.1	73.0	817.4	40.7	18.0	0.2	0.4	31.7	43.9

(continued)

Table 3-6 (cont). VOST Results ($\mu\text{g}/\text{m}^3$)

	Run															
	5	6	7	8	9	10	11	12	13	14	15	16				
4-methyl-2-pentanone	ND	0.9	ND	ND	ND	ND	ND	ND	ND	ND	ND	ND				
toluene	15.6	32.6	2.0	2.2	1.4	2.6	0.8	24.1	2.8	1.5	23.1	25.1				
tetrachloroethene	5.4	1.5	1.0	5.8	97.0	750.5	20.7	90.2	25.1	31.7	52.5	59.4				
chlorobenzene	3.5	36.3	2.1	3.9	46.3	8530	4.3	15.3	5.8	4.7	75.6	72.0				
ethylbenzene	1.6	7.2	0.2	0.1	0.4	ND	0.2	0.2	1.3	ND	0.9	1.3				
1,1,1,2-tetrachloroethane	ND	0.1	ND	ND	0.1	ND	ND	ND	ND	ND	ND	ND				
m,p-xylene	5.4	23.2	0.6	0.4	1.5	3.0	0.8	0.6	5.8	0.6	1.3	2.0				
o-xylene	1.6	9.7	0.2	0.1	ND	1.2	0.3	ND	0.9	ND	0.6	0.9				
styrene	0.2	ND	0.03	0.2	ND	ND	0.1	ND	1.8	1.4	12.0	23.3				
1,1,2,2-tetrachloroethane	ND	0.2	0.1	0.1	0.3	ND	0.2	0.03	ND	ND	0.1	ND				
1,2,3-trichloropropane	ND	0.3	ND	ND	ND	ND	ND	ND	ND	ND	ND	ND				
trans-1,4-dichloro-2-butene	ND	ND	ND	ND	ND	ND	ND	ND	0.2	ND	4.8	13.6				
pentachloroethane	ND	0.1	ND	ND	ND	ND	ND	ND	ND	ND	ND	ND				
1,2-dibromo-3-chloropropane	0.1	0.4	ND	0.4	0.8	237.1	ND	1.3	ND	ND	ND	ND				

Table 3-7. Target Volatile Organic Compounds Detected

Dichlorodifluoromethane	1,2-Dichloropropane
Chloromethane	Dibromomethane
Vinyl chloride	Bromodichloromethane
Bromomethane	cis-1,3-Dichloropropene
Chloroethane	trans-1,3-Dichloropropene
Trichlorotrifluoromethane	Dibromochloromethane
1,1-Dichloroethene	1,2-Dibromoethane
Carbon disulfide	Bromoform
Acetone	4-Methyl-2-pentanone
Methylene chloride	Toluene
1,2-Dichloroethene	Tetrachloroethane
1,1-Dichloroethane	Chlorobenzene
Chloroform	Ethylbenzene
1,2-Dichloroethane	1,1,1,2-Tetrachloroethane
2-Butanone	Xylene (m, p)
1,1,1-Trichloroethane	Xylene (o)
Carbon tetrachloride	Styrene
Benzene	trans-1,4-Dichloro-2-butene
Trichloroethene	1,2-Dibromo-3-chloropropane

Table 3-8. Tentatively Identified VOST Compounds

Bromotrichloromethane	Propene
Chloroethyne	Methyl propene
Bromoethyne	Methyl butane
Bromochloroethyne	Butadiyne
Dichloroethyne	Butadiene
Bromoethene	Pentene
Bromochloroethene	Pentane
Dibromoethene	Hexene
Bromodichloroethene	Hexane
Dibromochloroethene	Methylcyclohexane
Tribromoethene	Heptane
Bromotrichloroethene	Methylheptane
Tribromochloroethene	Dimethylheptane
Dibromodichloroethene	Octane
Tetrabromoethene	Nonane
Bromochloroethane	Decane
Bromopropyne	Methyldecane
Bromochloropropyne	Undecane
Bromodichloropropyne	Methylfuran
Bromopropene	Benzaldehyde
Pentachloropropene	Methylpentenal
Dibromopropane	Benzonitrile
Hexachlorobutadiene	Chlorothiophene
Pentachlorobutadiene	Tetrachlorothiophene
Chlorobutane	Dibromothiophene
Bromoheptane	
Chlorooctane	
Benzylchloride	
Bromobenzene	
Bromomethylbenzene	
Bromodimethylbenzene	
Bromochlorobenzene	
Dibromobenzene	
Bromodichlorobenzene	

An interesting comparison was made of the C₁ and C₂ halogenated alkanes, alkenes, and alkynes. A table was made of the possible chloro, bromo, and mixed bromochloro organics with one and two carbons (Table 3-9). With only a few exceptions, each compound was detected in at least one sample. These C₁ and C₂ compounds are of particular interest: they are considered to be precursors in aromatic ring propagation reactions leading to higher molecular weight PICs²⁰.

Table 3-9. Combinations of Detected C₁ and C₂ Compounds

	Target Analyte	Compound Detected
C ₁ Hydrocarbons		
	chloromethane	• ^a
	bromomethane	•
	dichloromethane	•
	dibromomethane	•
	bromochloromethane	•
	trichloromethane	•
	tribromomethane	•
	bromodichloromethane	•
	dibromochloromethane	•
	tetrachloromethane	•
	tetrabromomethane	•
	bromotrichloromethane	•
	dibromodichloromethane	•
	tribromochloromethane	•
C ₂ Alkynes		
	chloroethyne	•
	bromoethyne	•
	dichloroethyne	•
	dibromoethyne	•
	bromochloroethyne	•
C ₂ Alkenes		
	chloroethene	•
	bromoethene	•
	dichloroethene (total)	•
	dibromoethene	•
	bromochloroethene	•
	trichloroethene	•
	tribromoethene	•
	bromodichloroethene	•
	dibromochloroethene	•
	tetrachloroethene	•
	tetrabromoethene	•
	bromotrichloroethene	•
	dibromodichloroethene	•
	tribromochloroethene	•

(continued)

Table 3-9 (cont). Combinations of Detected C₁ and C₂ Compounds

	Target Analyte	Compound Detected
C ₂ Alkanes		
chloroethane	Yes	•
bromoethane	No	
dichloroethane	Yes	•
dibromoethane	Yes	•
bromochloroethane	No	•
trichloroethane	Yes	•
tribromoethane	No	
bromodichloroethane	No	
dibromochloroethane	No	
tetrachloroethane	Yes	•
tetrabromoethane	No	
bromotrichloroethane	No	
dibromodichloroethane	No	
tribromochloroethane	No	

a - Detected, but not quantified.

The results of analysis (from both VOST and Tedlar bags) for halogenated C₁ and C₂ VOCs are listed in Table 3-10. The list contains possible chloro, bromo, and bromochloro organics with one or two carbons. Note that dichloromethane (CH₂Cl₂) was found as a contaminant in some of the blanks, possibly as a laboratory contaminant. Also, it is not known why the chloromethane concentration was so high on one of the VOST tubes for Run 5. The Tedlar bag measurements of chloromethane were also very high for that run. An interesting observation is that, with few exceptions, almost all of these possible compounds were detected in at least one of the runs. If the data are further analyzed, by simply averaging the concentrations of all identified compounds for all of the reported runs, Figure 3-3 can be constructed. Figure 3-3 shows the concentrations of some of the halogenated C₁ and C₂ compounds grouped together, with the chlorinated and brominated analogs compared side by side. Note that the concentrations of the brominated and chlorinated analogs are similar in most cases, even though Br was present in the feed at a mass fraction of only about 10 % of the level of the Cl. This observation indicates that the presence of relatively small amounts of Br can potentially produce quantities of brominated PICs at levels comparable to those of the chlorinated PICs. Table 3-10 also shows that significant quantities of mixed bromochloro PICs were also measured. These low-carbon halogenated PICs are participants in aromatic ring growth reactions leading to the larger organic PIC molecules, such as the chlorinated benzenes and phenols, and possibly PCDDs/PCDFs.

Table 3-11 lists the concentrations of the aromatic VOCs found in the tests. Although the aromatic compounds are not identified as commonly throughout all the runs as the smaller molecules were, a similar pattern is found. The data from Run 10, which had the increased Br feed concentration, show the highest concentration and highest number of identified aromatic brominated and bromochloro PICs. The concentrations of brominated compounds are generally on the same order of magnitude as their chlorinated analogs.

Table 3-10. C₁ & C₂ Halogenated Hydrocarbons (µg/m³)

Compound	Run 5	Run 6	Run 9	Run 10	Run 13	Run 14
chloromethane	1066	2.6	12.7	2.8	16.3	3.5
bromomethane	197	7.7	27.6	1.8	2.3	2.4
dichloromethane	26.9	69.3	3.3	2.3	10.5	13.6
dibromomethane	1.35	1.3	3.8	208	1.7	0.8
bromochloromethane	0	0	0	0	0	0
trichloromethane	16.0	24	9.9	6.6	2.1	4.8
tribromomethane	16.7	30.7	73	846	0.17	0.4
bromodichloromethane	2.4	2.2	35.1	171	2.2	4.4
dibromochloromethane	3.1	6.0	43.4	231	0.4	2.1
tetrachloromethane	6.7	19.2	152	308	1.4	1.9
tetrabromomethane	0	0	0	0	0	0
bromotrichloromethane	0	0	12.2	42.1	0	0
dibromodichloromethane	0	0	0	0	0	0
tribromochloromethane	0	0	0	0	0	0
chloroethyne	0	0	0	0	21.1	10.6
bromoethyne	0	0	0	0.8	13.4	9.1
dichloroethyne	0	0	0	0	0	0
dibromoethyne	0	0	0	0	0	0
bromochloroethyne	0	0	0	0	6.5	2.3
chloroethene	1.7	0.2	11.25	43.8	4.5	3.6
bromoethene	0	0	0	2.6	0	0
dichloroethene (total)	7.5	0.15	62.2	17.9	1.8	5.2
dibromoethene	0	2.1	0	0.8	0	6.7
bromochloroethene	0	0	2.3	46.7	1.5	0
trichloroethene	1.7	0.5	40.1	99.6	24.4	32.5
tribromoethene	0	0	0	3.1	8.5	9.1
bromodichloroethene	0	0	0	0	0	38.6
dibromochloroethene	0	0	0	0	14.8	25.9
tetrachloroethene	5.5	1.9	0	0	0	31.9
tetrabromoethene	0	0	0	0	0	0
bromotrichloroethene	0	0	2.4	0	0	0
dibromodichloroethene	0	0	0	5.2	32.4	28.9
tribromochloroethene	0	0	0	0	0	9.5
chloroethane	7.5	0.5	0.8	0.1	0.1	0.4
bromoethane	0	0	0	0	0	0
dichloroethane	0.8	0.5	0.2	1	1.4	1
dibromoethane	1.6	6.3	1.9	114	1.8	0.5
bromochloroethane	0	2.3	7.5	187	2.8	0

(continued)

Table 3-10 (cont). C₁ & C₂ Halogenated Hydrocarbons (µg/m³)

Compound	Run 5	Run 6	Run 9	Run 10	Run 13	Run 14
trichloroethane	0.5	0.6	0.1	0.2	ND	ND
tribromoethane	ND ^a	ND	ND	ND	ND	ND
bromodichloroethane	ND	ND	ND	ND	ND	ND
dibromochloroethene	ND	ND	ND	ND	ND	ND
tetrachloroethane	ND	0.2	97.1	ND	11.2	ND
tetrabromoethane	ND	ND	ND	ND	ND	ND
bromotrichloroethane	ND	ND	ND	ND	ND	ND
dibromodichloroethane	ND	ND	ND	ND	ND	ND
tribromochloroethane	ND	ND	ND	ND	ND	ND

a - none detected

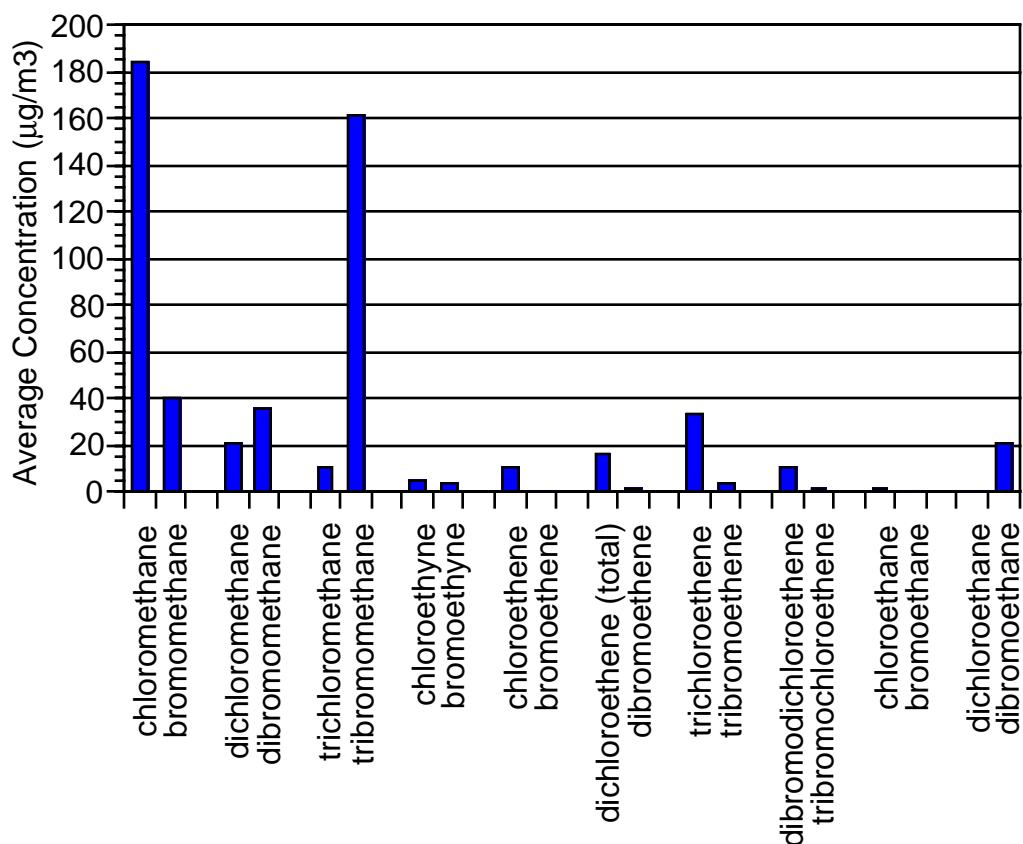

Figure 3-3. Average concentrations of analogous C₁ and C₂ halogenated compounds

Table 3-11. Halogenated Aromatic VOC Results ($\mu\text{g}/\text{m}^3$)

Test Condition	Baseline				Low SCC Temp			SCC Fuel Rich			
	5	5	6	6	9	9	10 ^a	13	13	13	14
chlorobenzene	4.2	2.7	36.3	14.8	16.8	75.8	8828	3.7	0	13.7	4.7
bromobenzene	0	0	0	0	0	0	13.2	0	0	1.6	0
dichlorobenzene	0	0	3.8	8.1	0	36.7	37.4	3.5	0	2.8	0.9
bromochlorobenzene	0	0	0	0	0	3.9	38.1	0	0	0.6	0
dibromobenzene	0	0	0	0	0	0	4.0	0	0	0	0
trichlorobenzene	0	0	0	0	2.6	8.7	32.7	0	0	0	0
bromodichlorobenzene	0	0	0	0	0	0	5.7	0	0	0	0
dibromochlorobenzene	0	0	0	0	0	0	0	0	0	0	0
tribromobenzene	0	0	0	0	0	0	0	0	0	0	0
bromomethylbenzene	3.0	0	1.3	0	0	0	0	0	0	0	0
bromodimethylbenzene	0	0	5.7	1.6	0	0	0	0	0	0	0

a - on Run 10, too much ethylene dibromide was inadvertently added

3.3 - Semivolatile and Non-Volatile Organics

3.3.1 - Conventional GC/MS Analytical Results

The semivolatile organic analytical results of the methylene chloride extracts indicate that a significant number of PICs have been identified both as target analytes and as TICs. For the analytical data evaluated, PICs identified as target analytes and TICs are presented in Tables 3-12 and 3-13, respectively. Many of the target analytes were detected. It should be noted once again that several of these compounds were in the original surrogate waste feed. Over 50 nontarget analytes were tentatively identified as PICs. Many of the PICs present in the MM5 samples were not identified. Also, the mix of PICs found on the filter sample fraction differed from that of the XAD-2 sample fraction. For a selected filter sample, at least 174 compounds were detected: 25 were identified as target analytes, 11 were tentatively identified, and 138 remained unidentified. For a selected XAD-2 sample, at least 194 compounds were detected: 18 were identified as target analytes, 17 were tentatively identified, and 159 remained unidentified. Identification of non-target analytes was particularly complicated by coeluting compounds. Coeluting compounds result in combined mass spectra that cannot be compared easily to reference spectra.

Many of the TICs were oxygenated compounds, such as esters, aldehydes, diones, and carboxylic acids. There were also many brominated TICs. There were also a significant number of unidentifiable aliphatic hydrocarbons, silanes, and phthalates that were not reported in Table 3-13. Silanes are frequently found as chromatographic artifacts from degradation of GC columns. Phthalates are commonly found in combustor emissions, but it is not well-established whether they are actual PICs or artifacts resulting from sampling and analytical treatments.

Analysis of the acetone and toluene sample extracts did not result in the identification of additional compounds. These analyses do verify the acceptable performance of methylene chloride as the single extraction solvent.

Table 3-12. Semivolatile Organic Target Results ($\mu\text{g}/\text{m}^3$)

Run	1	2	3	4	5	6	9	10	11	13	14	15
N-methyl-N-nitroso-ethanamine	ND	ND	ND	ND	ND	ND	ND	ND	ND	ND	ND	ND
Bis(2-chloroethyl)ether	ND	ND	ND	ND	ND	ND	ND	ND	ND	ND	ND	ND
Aniline	ND	ND	ND	ND	ND	ND	ND	ND	ND	ND	ND	ND
Phenol	0.3	0.8	ND	0.5	ND	0.5	ND	ND	4.0	ND	ND	ND
2-Chlorophenol	ND	ND	ND	ND	ND	ND	ND	ND	ND	ND	ND	ND
1,3-Dichlorobenzene	ND	ND	ND	ND	ND	ND	ND	ND	0.4	1.8	0.5	1.3
1,4-Dichlorobenzene	ND	ND	ND	ND	ND	ND	ND	ND	0.3	1.0	0.2	1.0
1,2-Dichlorobenzene	ND	ND	ND	0.6	ND	21.9	ND	1.5	0.7	29.3	0.5	2.7
Benzyl alcohol	ND	0.5	ND	ND	ND	ND	ND	ND	ND	1.6	ND	ND
Bis(2-chloroisopropyl) ether	ND	ND	ND	ND	ND	ND	ND	ND	ND	ND	ND	ND
2-Methylphenol	ND	0.2	ND	ND	ND	1.5	ND	ND	0.3	0.3	ND	ND
Acetophenone	ND	ND	ND	ND	ND	ND	ND	ND	6.2	1.4	ND	ND
Hexachloroethane	ND	ND	ND	ND	ND	ND	ND	ND	ND	ND	ND	ND
N-Nitrosodipropylamine	ND	ND	ND	ND	ND	ND	ND	ND	ND	ND	ND	ND
Nitrobenzene	ND	ND	ND	ND	ND	ND	ND	ND	ND	0.4	ND	ND
1-Nitrosopiperidine	ND	ND	ND	ND	ND	ND	ND	ND	ND	ND	ND	ND
Isophorone	ND	ND	ND	ND	ND	ND	ND	ND	ND	ND	ND	ND
2,4-Dimethylphenol	ND	ND	ND	ND	ND	ND	ND	ND	ND	ND	ND	ND
Bis(2-chloroethoxy)methane	ND	ND	ND	ND	ND	ND	ND	ND	ND	ND	ND	ND
2,4-Dichlorophenol	ND	ND	ND	ND	ND	ND	ND	ND	ND	ND	ND	ND
1,2,4-Trichlorobenzene	ND	ND	ND	0.2	ND	0.2	ND	ND	2.5	3.6	1.0	3.1
Naphthalene	ND	0.3	ND	1.6	ND	7.7	ND	1.0	110	21.9	3.5	107
2-Nitrophenol	ND	ND	ND	ND	ND	ND	ND	ND	0.2	ND	ND	ND
2,6-Dichlorophenol	ND	ND	ND	ND	ND	ND	ND	ND	ND	ND	ND	ND
Hexachloropropene	ND	ND	ND	ND	ND	ND	ND	ND	ND	ND	ND	ND
4-Chloroaniline	ND	ND	ND	ND	ND	ND	ND	ND	ND	ND	ND	ND
Hexachlorobutadiene	ND	ND	ND	ND	ND	ND	ND	ND	ND	ND	ND	0.4
N-Butyl-N-nitroso-butanamine	ND	ND	ND	ND	ND	ND	ND	ND	ND	ND	ND	ND
4-Chloro-3-methyl-phenol	ND	ND	ND	ND	ND	ND	ND	ND	ND	ND	ND	ND
2-Methylnaphthalene	ND	0.2	ND	0.8	ND	1.3	ND	ND	1.6	0.4	ND	ND
1,2,4,5-Tetrachlorobenzene	ND	0.2	ND	0.7	ND	0.2	ND	ND	4.5	1.0	1.2	39.5
Hexachlorocyclopentadiene	ND	ND	ND	0.7	ND	ND	ND	ND	ND	0.2	ND	7.7

(continued)

Table 3-12. Semivolatile Organic Target Results (continued) (µg/m³)

Run	1	2	3	4	5	6	9	10	11	13	14	15
2,4,6-Trichlorophenol	ND	0.3	ND	ND	ND	0.3	ND	0.4	13.1	2.8	1.2	30.9
2,4,5-Trichlorophenol	ND	0.5	ND	ND	ND	0.5	ND	0.5	ND	ND	ND	30.5
2-Chloronaphthalene	ND	ND	ND	ND	ND	ND	ND	0.7	4.2	0.9	ND	199
2-Nitroaniline	ND	ND	ND	ND	ND	ND	ND	ND	ND	ND	ND	ND
3-Nitroaniline	ND	ND	ND	ND	ND	ND	ND	ND	ND	ND	ND	ND
Acenaphthylene	ND	ND	ND	ND	ND	ND	ND	ND	1.1	ND	ND	ND
1,4-Naphthoquinone	ND	ND	ND	ND	ND	ND	ND	4.4	ND	ND	ND	ND
Dimethylphthalate	ND	0.2	ND	ND	ND	7.4	ND	1.6	ND	ND	ND	34.6
2,6-Dinitrotoluene	ND	ND	ND	ND	ND	ND	ND	ND	ND	ND	ND	ND
Acenaphthene	ND	ND	ND	ND	ND	ND	ND	ND	0.7	ND	ND	ND
4-Nitroaniline	ND	ND	ND	ND	ND	ND	ND	ND	ND	ND	ND	ND
2,4-Dinitrophenol	ND	ND	ND	ND	ND	ND	ND	ND	ND	ND	ND	ND
Dibenzofuran	ND	ND	ND	ND	ND	ND	ND	5.9	5.7	1.3	ND	74.6
Pentachlorobenzene	ND	1.2	ND	1.8	ND	1.2	ND	0.8	29.3	6.9	2.8	128
2,4-Dinitrotoluene	ND	ND	ND	ND	ND	ND	ND	ND	ND	ND	ND	ND
2,3,4,6-Tetrachlorophenol	ND	0.3	ND	0.2	ND	0.3	ND	1.8	30.9	5.4	2.5	36.9
4-Nitrophenol	ND	ND	ND	ND	ND	ND	ND	ND	ND	ND	ND	ND
Fluorene	ND	ND	ND	ND	ND	ND	ND	ND	3.2	ND	ND	ND
Diethyl phthalate	0.2	2.2	ND	1.9	0.8	3.1	0.5	0.3	4.1	0.8	1.2	ND
4-Chlorophenyl phenyl ether	ND	ND	ND	ND	ND	ND	ND	ND	ND	ND	ND	ND
2-Methyl-4,6-dinitrophenol	ND	ND	ND	ND	ND	ND	ND	ND	ND	ND	ND	ND
Diphenylamine	ND	ND	ND	ND	ND	ND	ND	ND	ND	ND	ND	ND
4-Bromophenyl phenyl ether	ND	ND	ND	ND	ND	ND	ND	ND	ND	ND	ND	ND
Phenacetin	ND	ND	ND	ND	ND	ND	ND	ND	ND	ND	ND	ND
Hexachlorobenzene	ND	ND	ND	0.5	ND	2.6	ND	2.3	9.4	3.4	2.2	18.5
Pentachlorophenol	ND	ND	ND	ND	ND	ND	ND	1.4	31.3	5.5	1.4	13.8
Pentachloronitrobenzene	ND	ND	ND	ND	ND	ND	ND	ND	ND	ND	ND	ND
Phenanthrene	ND	0.2	ND	ND	ND	ND	ND	8.1	26.7	4.1	0.3	2.2
Anthracene	ND	ND	ND	ND	ND	ND	ND	ND	ND	ND	ND	ND
Dibutyl phthalate	35.4	41.9	58.8	91.3	49.9	69.4	153	42.3	50.0	12.9	13.5	3.0
Fluoranthene	ND	0.2	ND	ND	ND	ND	ND	0.8	6.8	0.7	ND	ND
Pyrene	ND	ND	ND	ND	ND	ND	ND	ND	0.4	ND	ND	ND

(continued)

Table 3-12. Semivolatile Organic Target Results (continued) ($\mu\text{g}/\text{m}^3$)

Run	1	2	3	4	5	6	9	10	11	13	14	15
P-Dimethylaminoazobenzene	ND	ND	ND	0.5	ND	ND	ND	ND	ND	ND	ND	ND
Benzyl butyl phthalate	0.2	0.3	ND	0.2	0.9	ND	ND	ND	0.3	0.8	ND	ND
Chrysene	ND	ND	ND	ND	ND	ND	ND	ND	ND	ND	ND	ND
Benzo(a)anthracene	ND	0.2	ND	ND	ND	ND	ND	ND	ND	ND	ND	ND
Di-N-octyl phthalate	1.4	1.4	3.6	38.9	0.8	278	0.3	ND	448	ND	146	6743
Benzo(b)fluoranthene	ND	0.2	ND	0.2	ND	ND	ND	ND	ND	ND	ND	ND
7,12-Dimethylbenz(a)anthracene	ND	ND	ND	ND	ND	ND	ND	ND	ND	ND	ND	ND
Benzo(k)fluoranthene	ND	0.2	ND	0.2	ND	ND	ND	ND	ND	ND	ND	ND
Benzo(a)pyrene	ND	0.2	ND	0.3	ND	ND	ND	ND	ND	ND	ND	ND
3-Methylcholanthrene	ND	0.2	ND	0.2	ND	ND	ND	ND	ND	ND	ND	ND
Indeno(1,2,3-cd)pyrene	ND	0.3	ND	0.2	ND	ND	ND	ND	ND	ND	ND	ND
Dibenz(a,h)anthracene	ND	0.2	ND	0.3	ND	ND	ND	ND	ND	ND	ND	ND
Benzo(ghi)perylene	ND	0.3	ND	0.3	ND	ND	ND	ND	ND	ND	ND	ND

Table 3-13. Semivolatile Organic Tentatively Identified Compounds (µg/m³)

Run	1	2	3	4	5	6	9	10	11	13	14	15
1,1'-Biphenyl	ND	0.5	ND	ND	ND	ND	ND	ND	3.2	ND	ND	3.3
1,1'-Biphenyl, 2-phenoxy	0.3	ND	ND	ND	ND	ND	ND	ND	ND	ND	ND	ND
1,1,2,2-Tetrabromoethylene	ND	ND	ND	ND	ND	ND	ND	ND	ND	ND	5.0	ND
1,1,2-Tribromo-2-chloro-ethylene	ND	ND	ND	ND	ND	ND	ND	ND	ND	ND	6.0	ND
1,1,2-Trichloroethane	ND	0.7	ND	ND	ND	ND	ND	ND	ND	ND	ND	ND
1,2,3,4-Tetrachlorobenzene	ND	ND	ND	ND	ND	ND	ND	ND	3.1	ND	ND	ND
1,2-Dibromo-1,2-dichloroethylene	ND	ND	ND	ND	ND	ND	ND	ND	ND	ND	12.4	ND
1,2-Dibromo-trans-cyclohexane	ND	ND	ND	ND	ND	ND	ND	ND	ND	60.0	ND	ND
1,3-Isobenzofurandione	ND	ND	0.7	ND	ND	ND	ND	ND	ND	ND	ND	ND
1,4-Dibromo-cyclohexane	ND	ND	ND	2.4	ND	25.5	ND	ND	23.7	ND	42.4	ND
1,4-Dimethyl benzene	ND	ND	ND	ND	ND	5.8	ND	ND	ND	ND	ND	ND
1,8-Naphthalic anhydride	ND	ND	ND	ND	ND	ND	ND	29.9	ND	ND	ND	ND
1-Bromo-1,2,2-trichloroethylene	ND	ND	ND	ND	ND	ND	ND	ND	ND	ND	ND	8.6
1-Bromo-2-methoxy-cis-cyclohexane	ND	ND	1.6	0.9	ND	ND	ND	ND	ND	ND	67.6	ND
1-Bromo-2-methyl-benzene	ND	ND	ND	ND	ND	ND	ND	ND	ND	ND	ND	6.7
1-Bromo-4-methyl-benzene	ND	ND	ND	ND	ND	ND	ND	ND	ND	ND	ND	7.4
1-Bromo-naphthalene	ND	ND	ND	ND	ND	ND	ND	ND	ND	ND	ND	7.6
1-Hexanol, 2-ethyl	ND	ND	ND	3.3	ND	9.6	ND	12.2	ND	ND	ND	ND
1H,3H-Naphtho[1,8-cd]pyran-1-3-dione	ND	ND	ND	ND	ND	ND	ND	ND	0.5	ND	ND	ND
1H-Indole-1,3(2H)-dione	ND	ND	ND	ND	ND	ND	ND	ND	0.5	ND	ND	ND
2,2,3-Tribromobutane	ND	ND	ND	5.9	ND	ND	ND	ND	ND	ND	ND	ND
2,4,5-Tribromotoluene	ND	ND	ND	ND	ND	ND	ND	ND	7.6	ND	ND	ND
2,5-Cyclohexadiene-1,4-dione	ND	ND	ND	ND	ND	ND	0.4	ND	ND	ND	ND	ND
2,5-Dibromothiophene	ND	ND	ND	ND	ND	ND	ND	ND	ND	ND	ND	0.5
2,6-Dibromo-p-chlorophenol	ND	ND	ND	ND	ND	7.1	ND	ND	ND	ND	ND	3.7
2-Butoxy-ethanol	ND	ND	ND	ND	ND	ND	ND	ND	0.4	ND	ND	ND
2-Chloro-pyridine	ND	ND	ND	ND	ND	ND	ND	ND	0.4	ND	ND	ND
2-Ethyl hexanoic acid	ND	ND	ND	ND	ND	0.5	ND	ND	ND	ND	ND	ND
2-Ethyl-1-hexanol	ND	ND	ND	ND	ND	ND	ND	ND	11.6	ND	ND	ND
4-Bromo-benzonitrile	ND	ND	ND	ND	ND	ND	ND	ND	3.1	ND	ND	ND
6-Bromo-1,1,4,6-cycloprop[aj]indene	ND	ND	ND	1.5	ND	ND	ND	ND	ND	ND	ND	ND

(continued)

Table 3-13. Semivolatile Organic Tentatively Identified Compounds (continued) ($\mu\text{g}/\text{m}^3$)

Run	1	2	3	4	5	6	9	10	11	13	14	15
9,10-Anthracenedione	ND	ND	ND	ND	ND	ND	ND	10.4	ND	ND	ND	ND
9-Bromo-anthracene	ND	ND	ND	ND	ND	ND	ND	ND	0.5	ND	ND	ND
9H-Fluoren-9-one	ND	ND	ND	ND	ND	ND	ND	ND	ND	ND	ND	ND
Benzaldehyde	ND	2.5	ND	2.3	ND	8.3	ND	ND	ND	ND	ND	ND
Benzaldehyde, ethyl	ND	0.5	ND	ND	ND	ND	ND	ND	ND	ND	ND	ND
Benzoic acid	ND	ND	ND	5.9	ND	5.7	ND	ND	11.2	ND	ND	ND
Benzoic acid, methyl ester	ND	ND	ND	0.9	ND	33.8	ND	ND	4.6	ND	ND	4.2
Bromobenzene	ND	ND	ND	ND	ND	ND	ND	ND	ND	ND	ND	ND
Butanoic acid, methyl ester	ND	ND	ND	0.5	ND	ND	ND	ND	ND	ND	ND	ND
Chlorobenzene	ND	ND	ND	ND	ND	6.0	ND	ND	ND	ND	ND	9.1
Cyclohexadecane	ND	ND	ND	ND	ND	ND	0.8	ND	ND	ND	ND	ND
Cyclopentanecarboxaldehyde	ND	ND	ND	ND	ND	ND	ND	ND	0.4	4.9	ND	ND
Decane	ND	ND	ND	2.2	ND	ND	ND	ND	ND	ND	ND	ND
Dichlorobromoethene	ND	ND	ND	ND	ND	ND	ND	ND	ND	15.1	ND	ND
Ethyl benzene	ND	1.6	ND	6.1	ND	11.3	ND	ND	ND	ND	ND	ND
Hexadecanoic acid	ND	ND	ND	ND	ND	ND	ND	ND	ND	37.3	ND	ND
Hexadecanoic acid, methyl ester	ND	ND	ND	ND	0.4	12.3	ND	22.0	9.9	18.3	ND	10.4
Hexanedioic acid	ND	ND	ND	ND	ND	ND	ND	ND	ND	9.7	ND	ND
Hexanedioic acid, bis(2-ethylhexyl)	ND	ND	ND	ND	ND	ND	ND	ND	ND	12.9	ND	ND
Hexanedioic acid, dimethyl ester	ND	ND	ND	0.8	0.5	ND	ND	ND	ND	ND	ND	ND
Hexanedioic acid, dioctyl ester	ND	61.1	ND	ND	ND	ND	ND	ND	ND	ND	ND	ND
Hexanedioic acid, mono(2-ethylhexyl)	ND	ND	ND	ND	ND	ND	ND	ND	ND	ND	ND	ND
Hexanoic acid	ND	ND	ND	ND	ND	ND	ND	ND	0.4	ND	ND	ND
Methyl benzene	147.5	577.3	5.4	840.5	20.5	1446.6	ND	ND	202.2	ND	ND	ND
Nonane	ND	ND	ND	106.4	ND	ND	ND	ND	ND	ND	ND	ND
Octadecanoic acid	ND	ND	ND	ND	ND	ND	ND	ND	ND	21.4	ND	ND
Octadecanoic acid, methyl ester	0.7	ND	ND	0.7	ND	31.1	ND	ND	8.2	17.2	ND	4.8
Styrene	ND	ND	ND	ND	ND	ND	ND	ND	ND	ND	ND	12.7
Tetrachloroethane	ND	5.0	2.9	ND	ND	ND	ND	ND	ND	ND	ND	ND
Tetrachloroethene	ND	ND	ND	ND	ND	ND	ND	ND	ND	ND	ND	4.6
Triacetin	ND	ND	ND	ND	ND	ND	ND	ND	ND	155.1	ND	ND
Tribromoethene	ND	ND	ND	ND	ND	ND	ND	ND	ND	11.1	ND	ND
Tribromomethane	ND	ND	ND	ND	ND	ND	ND	ND	ND	ND	ND	ND
Trichlorobromobenzene	ND	ND	ND	ND	ND	ND	ND	ND	ND	ND	ND	ND

3.3.2 - Multi-Dimensional GC/MS Analytical Results

Figure 3-4 shows the results from the MDGC/MS analysis of the extract from Run 10. A 15 second heartcut (showing a doublet, two closely spaced peaks) and a 10-second heartcut from a single peak (a singlet) were trapped at low temperature, and then both collected fractions were re-chromatographed by the secondary OTC (the more polar phase column). Both heartcuts were chosen by the difficulty of compound identification through MS spectral library searches. The lower section of Figure 3-4 shows the chromatograms and MS identifications for these two heartcuts. It is readily apparent that many more compounds were present in both of the heartcuts than would appear from examination of the primary chromatogram. More importantly, good separation was obtained by using the second chromatography step, resulting in reliable MS identifications. This technique verifies that complex samples, such as incinerator emissions, cannot be fully characterized using conventional techniques due to the problem of compound coelution. Table 3-14 shows a list of compounds identified from the two heartcut fractions. The potential benefits of using this technique for detailed examination of each peak of the primary chromatogram are obvious.

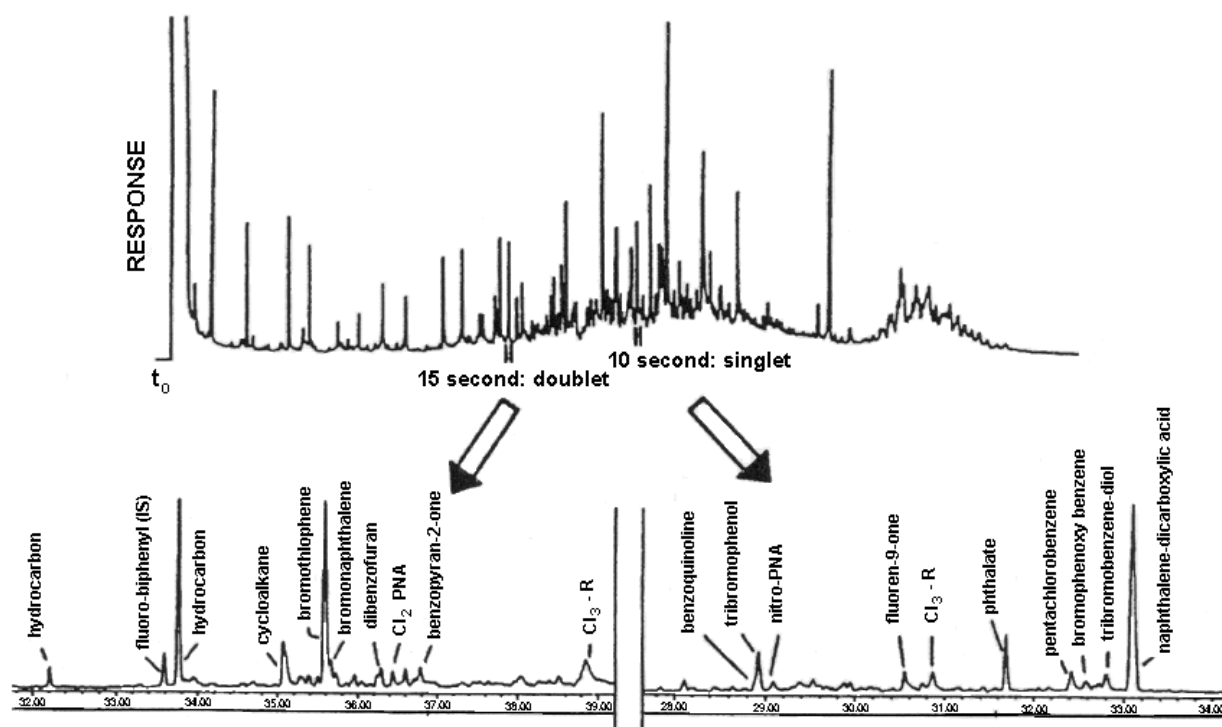

Figure 3-4. MDGC/MS Analysis of Methylene Chloride Extract from Run 10. The upper trace is for the single-column, "one-dimensional" analysis. "Two dimensional" resolution of a singlet and a doublet are shown. (Copyright © 1996; reproduced with permission of UDRI).

Table 3-14. Compounds identified via MDGC/MS

fluorobiphenyl	bromothiophene
bromonaphthalene	dibenzofuran
dichlorinated PAH	benzopyran-2-one
benzoquinoline	tribromophenol
nitrated PAH	fluoren-9-one
pentachlorobenzene	bromophenoxy benzene
tribromobenzene-diol	naphthalene dicarboxylic acid

3.4 - PCDDs/PCDFs and PBDDs/PBDFs

Table 3-15 lists the PCDDs/PCDFs and PBDDs/PBDFs found in the tests. Some congeners were found in all tests. These values reflect data taken at duct temperatures ranging from approximately 200 to 350 °C, and reflect short residence time in-flight formation of PCDDs/PCDFs and PBDDs/PBDFs and emissions of those compounds as PICs rather than formation at longer residence times, such as those found in particulate control devices. In general, the low temperature and high Br process conditions tended to yield higher levels of PICs than the baseline and even the fuel-rich conditions. Of particular interest is the observation of the very high levels of PCDDs/PCDFs that were found during Run 10, when the Br was at the high feed concentration. Tripling the concentration of Br in the feed resulted in an order of magnitude increase in PCDD/PCDF emissions, plus measured quantities of PBDDs/PBDFs were much higher. It may be that the presence of Br inhibits reactions that reduce the production of PCDDs/PCDFs. It may also be that Br may enhance some of the reactions that produce PCDDs/PCDFs. Further work is planned to investigate this phenomenon. It is also of interest that variations between the different run conditions produced a wide variation in concentrations of PCDDs/PCDFs. These data are undergoing further analyses to evaluate differences between run conditions. In spite of efforts to maintain a constant duct temperature, variations did occur, and this may be sufficient to account for some of the variations. HCl concentrations in the sampling duct were on the order of 5000 ppmv, which could provide more than sufficient gas-phase Cl to achieve these levels of PCDD/PCDF emissions. This is not typical of normal incinerator operation, since typically the HCl is removed prior to passing the flue gases through the optimal PCDD/PCDF formation temperature window.

Table 3-15. Polychlorinated and Polybrominated Dioxins and Furans

	___Baseline___		_Low SCC Temp_		_SCC Fuel Rich___	
	Run	Run	Run	Run	Run	Run
	5	6	9	10 ^a	13	14
	(ng/m3)	(ng/m3)	(ng/m3)	(ng/m3)	(ng/m3)	(ng/m3)
Monochlorodibenzofuran	0	0	693.79	10944.93	67.38	1.22
Monochlorodibenzodioxin	0	0	16.89	1770.38	0	1.57
Dichlorodibenzofuran	0	0	1145.83	16640.27	52.04	0
Dichlorodibenzodioxin	0	0	35.53	3671.38	0	0
Trichlorodibenzofuran	28.87	0	957.67	8940.27	48.35	0
Trichlorodibenzodioxin	0	0	53.01	4677.70	0	0
Tetrachlorodibenzofuran	28.30	0	421.75	1332.95	39.22	0
Tetrachlorodibenzodioxin	0	0	43.11	29.78	0	0
Pentachlorodibenzofuran	54.34	8.33	358.83	659.23	57.28	0
Pentachlorodibenzodioxin	0	0	43.69	373.04	0	0
Hexachlorodibenzofuran	39.81	0	310.49	470.22	177.09	0
Hexachlorodibenzodioxin	0	0	78.64	386.36	5.63	0
Heptachlorodibenzofuran	47.55	7.04	230.10	206.49	126.99	10.43
Heptachlorodibenzodioxin	7.74	0	73.98	289.18	29.13	0
Octachlorodibenzofuran	16.42	0	535.92	306.49	27.96	14.43
Octachlorodibenzodioxin	56.04	0	553.98	96.51	79.81	8.00
Totals	279	15	5553	50795	711	36
Bromotrichlorodibenzodioxin	0	0	0	90.52	0	0
Bromotrichlorodibenzofuran	0	0	0	0	• ^b	0
Dibromodichlorodibenzodioxin	0	0	0	32.45	0	0
Tetrabromodibenzodioxin	0	0	0	0	0	0
Pentabromodibenzodioxin	0	0	0	0	0	0
Bromotrichlorodibenzofuran	0	0	9.71	295.51	0	0
Tetrabromodibenzofuran	0	0	0	8.49	0	0
Pentabromodibenzofuran	0	0	0	0	0	0

a - On Run 10, too much ethylene dibromide was inadvertently added

b - Detected, but not quantified

3.5 - Surrogate Performance Indicators

A surrogate performance indicator is an easily measured compound or group of compounds whose variance can account for the variance in the measurements of a more difficult-to-measure compound, such as PCDDs/PCDFs. In light of that, the data from the VOST analyses were compared to the emissions of total PCDD and total PCDF, both singly and in combination using the STEPWISE regression in the SAS JMP software package. STEPWISE first looked at all compounds measured by VOST and determined whether variance in those compounds could account for any of the variance in PCDDs/PCDFs. Then individual analytes were compared (using the statistical correlation coefficient, R^2) to see if an $R^2 > 0.5$ was possible by correlating the concentration of that pollutant vs LOG(PCDD) and LOG(PCDF).

Figure 3-5 shows trichloroethylene vs. total PCDD, Figure 3-6 shows trichloroethylene vs total PCDF, and Figure 3-7 shows trichloroethylene vs. total PCDD+PCDF. Trichloroethylene was chosen because it showed the highest correlation coefficient (R^2) for any single compound. These are remarkably good correlations considering that these data points span a wide range of combustion conditions and temperatures, particularly in the transition duct where the maximum formation temperature window for PCDDs/PCDFs can be found. The fact that one of the chlorinated ethenes was found to be the best indicator is also promising. Chlorinated ethenes have been implicated as some of the primary precursors to ring growth reactions resulting in the formation of chlorinated benzenes and chlorinated phenols, the suspected precursors to PCDDs/PCDFs.²¹

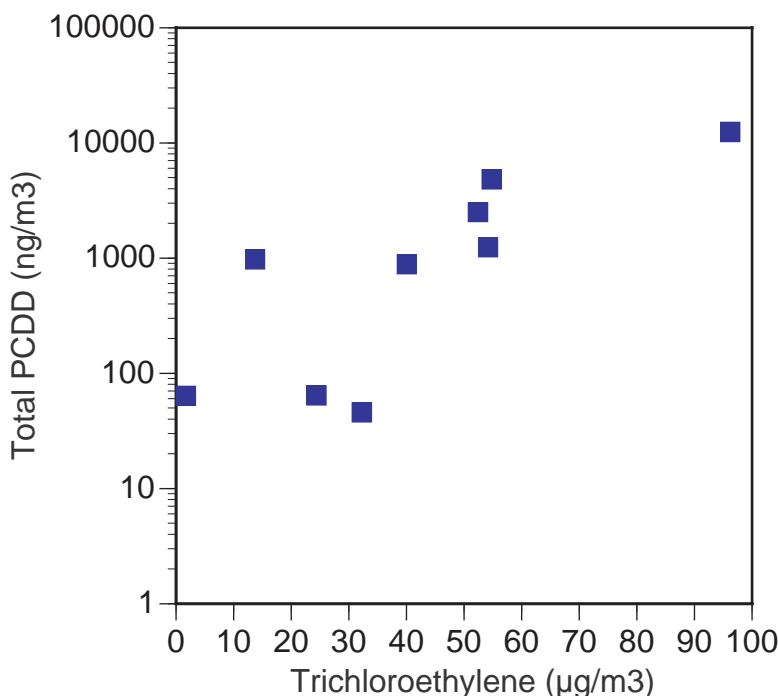

Figure 3-5. Trichloroethylene vs. Total PCDDs; $R^2=0.6476$ [based on LOG(PCDD)].

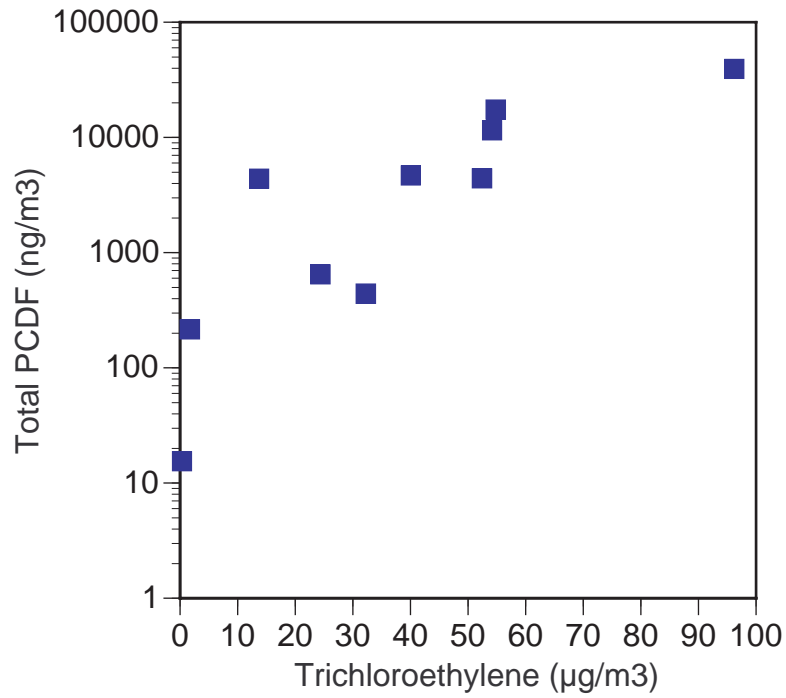

Figure 3-6. Trichloroethylene vs. Total PCDFs; $R^2=0.6956$ [based on LOG(PCDF)].

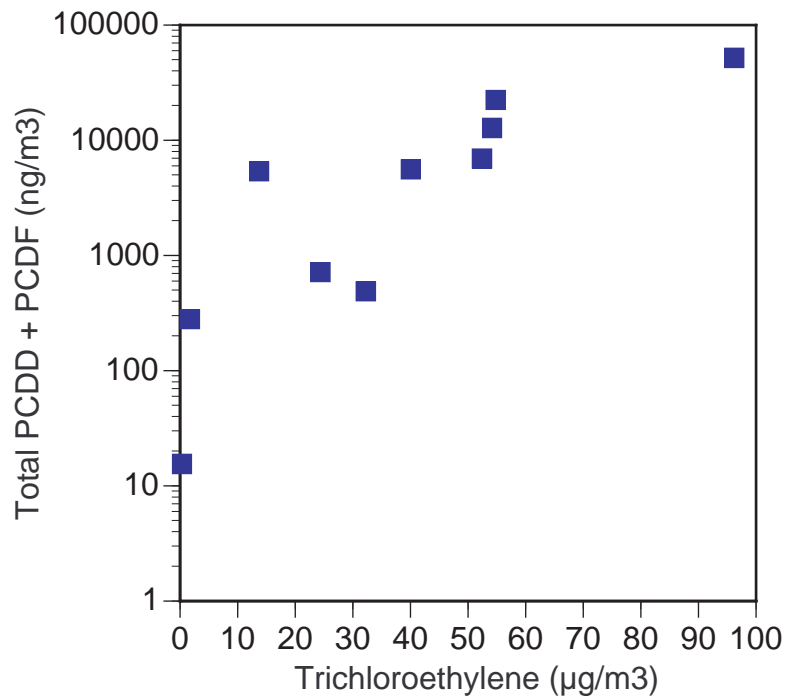

Figure 3-7. Trichloroethylene vs. Total PCDDs+PCDFs; $R^2=0.6915$ [based on LOG(TOTAL)].

It must be reiterated that these are preliminary findings, based on pilot-scale tests performed on a single waste stream. However, if it is borne out by further investigation that trichloroethylene is an appropriate surrogate for PCDDs/PCDFs, there is good potential that this information could be used for compliance assurance or system optimization, since trichloroethylene is one of the OLG's target analytes, and could be easily measured in the stack of an incinerator.

Potential surrogate indicators were further investigated by evaluating linear combinations of multiple VOST analytes. JMP was used to do a principal component statistical analysis on all VOST analytes, excluding brominated and fluorinated compounds. Principal component analysis is a statistical tool that is used to transform data to group interrelated variables. It is not statistically valid to directly use many VOST targets simultaneously to predict variance in PCDDs/PCDFs since, with a limited number of measurements such as are present here, you can explicitly predict virtually all of the variance in PCDDs/PCDFs by using a large enough group of VOST targets. However, principal component analysis can allow you to reduce the number of predictors by transforming their axes. The principal components represent variables that take into account the interrelations between similar VOST targets since, for example, it is not possible to use benzene and toluene as completely separate predictors, since their concentrations in the stack are related to each other. This statistical analysis yielded interesting results, indicating that 72% of the variability in the VOST PICs can be accounted for by the first three principal components, which are linear combinations of the various VOST analytes. Performing a least squares regression using the first three principal components vs total PCDD yielded an R^2 of 0.8182, and an R^2 of 0.8450 when correlated against total PCDF, and an R^2 of 0.8487 when correlated against total PCDD+PCDFs.

Using a principal component analysis of multiple volatile PICs may be a useful method with which to derive a surrogate indicator of PCDDs/PCDFs that is based on several analytes rather than a single analyte. It is unknown, however, how site-specific this approach might be. It would be worthwhile to explore this possibility on other existing incinerator datasets to see if this method holds promise.

4.0 CONCLUSIONS

The conclusions are divided into sections relating to the various primary and secondary goals of this study.

4.1 - Target Analyte List

Pilot-scale incineration tests have been performed under varied combustion conditions feeding a mixed surrogate waste, resulting in the generation of numerous PICs. While many of these PICs were identified as target analytes using standardized sampling and analytical methods, the majority of PICs present in the incineration emissions were not target analytes. Although a substantial number have been tentatively identified, a considerably larger number have not been identified at this time. It can be concluded from these experiments that the current sampling and analytical schemes for characterizing HWC emissions are inadequate and provide an incomplete picture of the emission profile. This is primarily due to the presence of an extremely complex mixture of organic compounds in the HWC emission samples. This is particularly evidenced in the semivolatile organic samples. Nearly 200 chromatographic peaks were resolved through conventional methodologies, many of which were coeluting peaks. These coeluting peaks could not be identified due to combined spectra. The complexity of the samples was further illustrated by the MDGC technique. Heartcuts of single, conventional peaks resulted in the resolution and identification of 10 times the number of compounds initially evident. As a result, the number of compounds suspected to be present in incinerator emissions may be an order of magnitude greater than initially suspected. Other techniques, such as fractionation with HPLC, may provide similar benefits for identification of coeluting peaks.

A very promising technique for enabling identification of the complex mixtures present in combustion emissions is multi-dimensional GC/MS. This technique of performing an additional chromatographic separation on chromatographic peaks that confound mass spectral identification, enabled significant additional identification of unknowns on the limited sample for which it was performed. The authors believe that a much more complete listing of PICs could be generated by performing a careful analysis of complex samples such as these using MDGC/MS. However, although MDGC/MS may eventually lend itself to routine analyses, in its current incarnation it is still an experimental technique.

As a result of these experiments, an expanded list of PIC target analytes has been developed. This list is by no means complete or comprehensive. This list should be viewed in context with this particular set of experiments; i.e., waste mix. The PICs resulting from other varied waste streams have not been evaluated.

The PICs identified fall into several chemical classes. A wide variety of chloro, bromo, and mixed bromochloro alkanes, alkenes, alkynes, aromatics, and polyaromatics were detected. In addition, nonhalogenated hydrocarbon homologues along with oxygenated, nitrogenated, and sulfonated organics were detected. MDGC/MS detected chlorinated PAHs. Analytical methods specifically suited to these chemical classes are needed to enhance PIC characterizations.

For this facility burning this particular waste stream, conventional C₁ and C₂ hydrocarbons were present in levels below 1-2 ppm. Since THC analyzer readings were on the same order of magnitude as the detection levels for C₁ and C₂ hydrocarbons, no carbon balance was attempted. In addition, below 10 ppm, THC analyzer readings are not accurate due to biases introduced by the

presence of common flue gas constituents.²²

4.2 - Effect of Presence of Bromine

Brominated C₁ and C₂ PICs were present at higher-than-expected concentrations than their chlorinated analogs, in spite of Br's being present at only 10% of the mass concentration of Cl in the feed. This phenomenon was also observed with aromatic halogenated PICs such as brominated and chlorinated benzenes. A large number of chlorinated, brominated, and bromochloro semivolatiles were also detected. Even though the sampling was performed upstream of a particulate matter control device, and samples were taken after a fairly short residence time in the optimal formation window between 600 and 200 °C, chlorinated, brominated, and bromochloro dioxins and furans were detected, and some congeners of the PBDDs/PBDFs were detected. During Run 10, with an erroneously high level of Br in the feed, emissions of PCDDs/PCDFs were increased dramatically, and significant emissions of PBDDs/PBDFs and bromochloro dioxins and furans were found. It is not known whether the presence of Br enhances production or inhibits destruction of PCDDs/PCDFs. Additional experiments are needed to confirm these results.

It is also unknown whether bromination increases or decreases the relative amounts and toxicities of the PCDD/PCDF, PBDD/PBDF, and PXDD/PXDF PICs. If bromination of PICs is additive, then brominated compounds (e.g., PBDDs/PBDFs) could add significantly to risk assessment calculations, especially if emissions of PBDDs/PBDFs are at a similar concentration as PCDDs/PCDFs. If the process is substitutive, Br could bring into question trial burn and compliance test PCDD/PCDF results due to bromination of chlorinated PICs resulting in brominated or bromochloro PICs that aren't considered in risk assessment calculations.

4.3 - Surrogate Performance Indicators

Based on these tests, on this facility, burning this particular waste stream, emissions of trichloroethylene give a very good correlation with emissions of total PCDD and total PCDF, even though PCDD/PCDF emissions varied over several orders of magnitude. Trichloroethylene is a relatively easily measured compound in the stack of incinerators, and because of its importance as a ring growth precursor, has a scientific basis for its use as a surrogate for PCDDs/PCDFs, as well as other chlorinated aromatic PICs of interest. It is not known whether trichloroethylene correlates with PCDDs/PCDFs in practical systems, although the authors will investigate whether this is the case. Likely, if trichloroethylene is a viable surrogate in full-scale systems, it will correlate with PCDDs/PCDFs prior to flue gas cleaning equipment, and would need to be coupled with flue gas cleaning equipment temperatures in order to be a viable surrogate for stack emissions of PCDDs/PCDFs.

It is possible to account for most or all of the variance in the PCDD/PCDF data by using linear combinations of several common volatile PICs, using a principal component statistical analysis to account for the interrelationships between the volatile PICs of interest. The first three principal components of the VOST analytes, when correlated against PCDDs/PCDFs, were able to generate R²s in excess of 0.80. It is not known how broadly applicable or facility specific this observation is.

Measurement of surrogate performance indicators via OLGc appears to have good promise. Not

only can the OLGC system make stack measurements, but can measure PICs at intermediate locations within the combustor, to gain insight into PIC formation processes and for system optimization. The analytes that gave good promise for potential surrogates for PCDDs/PCDFs were also OLGC targets. Observations made with the OLGC system show formation of chlorinated aromatics as gases passed through moderate temperature regions.

4.4 - Implications of These Results

The results from these tests have implications regarding incinerator trial burns and compliance tests. Although it is not within the scope of this report to make recommendations related to EPA policy, it is within ORD's charter to bring scientific implications of our results to OSW's attention. This study raises the following questions:

- Can compliance with potential PCDD/PCDF emission limits that have been demonstrated in a trial burn, using a synthetic POHC feed with no Br in the system, be ensured during actual operation when Br is present in the feed?
- If a facility will eventually burn Br-containing wastes during operation, should Br be added to the system during trial burns to challenge the system, even though brominated organics, including PBDDs/PBDFs, are not included in the regulations or the risk assessment calculations?
- How can PICs such as PBDDs/PBDFs be accounted for if their sampling and analytical methodologies have not been validated?
- Is it possible to use a common volatile PIC, such as trichloroethylene, as a surrogate for PCDDs/PCDFs and other chlorinated aromatic compounds? If one can be found, what is an appropriate level to control to?
- How facility specific would it be to use linear combinations of multiple volatile PICs as a surrogate for PCDDs/PCDFs?

4.5 - Recommendations

Much was learned analytically attempting to expand the target analyte list. Foremost is the obvious conclusion that conventional analytical methodologies and approaches are inadequate to characterize the inherently complex emissions samples. This is evidenced by the small number of target analytes observed relative to the large number of compounds present. Part of the problem lies in the fact that existing methodologies focus on the identification and quantification of hazardous waste components and not PICs. The greater problem is that, with complex samples, chromatographic interferences inhibit the ability to identify unknowns as well as confirm target analytes. Complex samples often result in significant numbers of coeluting peaks. The mass spectral fragmentation patterns of coeluting peaks are combined and additive, making individual spectral identifications difficult. This phenomenon would exhibit itself in the form of large numbers of tentatively identified compounds with poor identification probabilities from the mass spectral search. Fortunately, techniques were identified and demonstrated that were capable of deconvoluting the complex samples. The authors strongly believe that improved analytical methodologies emphasizing identification and quantification of unknown compounds would

provide the greatest opportunity to reduce uncertainty in risk assessment calculations with minimal expenditure.

Additional testing is recommended that incorporate these techniques. This additional testing should use as a foundation, EPA's Total Organics Approach (TOA). Particular emphasis should be placed on characterization of the semivolatile and nonvolatile fractions. This would equate to total chromatographable organic (TCO) and gravimetric organic (GRAV) fractions of the TOA. Each sample fraction should be segregated or fractionated, based on polar characteristics, to provide a first step towards deconvoluting the sample. This can be quantitatively accomplished using High Performance Liquid Chromatography (HPLC). Each segregated fraction should then be re-subjected to the TCO and GRAV analyses to ensure mass recovery. Then each sample fraction should be reanalyzed by GC/MS as well as MDGC/MS. This will not only improve compound identification and quantitation, but also demonstrate this particular approach as a potential method for characterizing incinerator emissions.

This testing should also include separate efforts to identify the components present in the GRAV fraction. Theoretically, the GRAV fraction includes primarily nonvolatile organics possessing high molecular weight compounds. It is possible, even probable, that a considerable portion of these compounds are not amenable to conventional GC analyses. However, the ability to characterize this fraction has met with mixed results. This fraction typically remains uncharacterized, with only a small percentage of the mass being identified.

It is the authors' strong contention that the GRAV fraction may consist of organic and/or inorganic mass not directly attributable to organic incinerator emissions. This artifact may be comprised of inorganic salts, super-fine particulate, fractured XAD-2 resin, or some other unknown. This artifact may account for the inability to identify a significant percentage of the GRAV fraction. Experiments can be designed to further determine the representativeness of the GRAV fraction. Based on these results, more efficient analytical approaches can be devised to characterize the GRAV fraction, thereby improving the potential for identifying a larger percentage of the GRAV fraction.

Finally, it may be possible to develop a multi-tiered approach to measuring PICs from incineration systems. Some incineration systems may exhibit a relatively small number of identifiable PICs, whereas others may have an exceedingly complex mixture in the stack. This multi-tiered approach could be performed by commercial analytical laboratories on a routine basis. The multi-tiered approach would consist of the following:

Tier 1: First Pass Analysis

The first pass analysis would focus on using existing analytical methodologies that focus more on potential PICs. The MM5 samples would be extracted and analyzed conventionally using a Method 8270C analysis, directed at the Method 8270C targets. The existing target list should be expanded to include common PICs that are amenable to GC/MS analysis. Aliquots from these same extracts would be subjected to further analyte-specific analyses for chlorobenzenes and chlorophenols (Method 8041), PAHs (CARB Method 429), and nitroaromatics and cyclic ketones

(Method 8091). These are more analyte-specific analyses and offer greater sensitivity, particularly through the use of selective ion monitoring techniques. High resolution mass spectrometry (HRMS) may also be used to improve sensitivity, if needed.

Greater emphasis should be placed on the identification and accurate quantitation of unknowns. Guidelines should be developed that standardize this approach. These guidelines should include spectral library searching and spectral interpretation requirements, confirmation of unknowns with known standards where possible, and other criteria that add to the quality of the identification (e.g., retention time, boiling point). In addition, tentatively identified unknowns should be quantified using a response factor of a compound similar to the characteristics of the unknown rather than an unrelated compound closest in retention time.

The Method 23 samples would be analyzed for PCDDs/PCDFs and PCBs using HRMS. The PCB analysis should include both totals and the co-planar isomer specific analyses. Two PCB Methods exist which can accomplish this method: CARB 428 and Draft Method 1668. The Method 23 target analyte list should be expanded to include the mono-, di-, and tri- substituted dioxin and furan congeners as well as the tetra- through octa- as are normally measured. Limited laboratory and field data suggest that the lower chlorinated congeners may be suitable surrogates for the higher chlorinated congeners, and measurement of the lower chlorinated congeners with a CEM may be practical in the near future. It is necessary to develop a database of the lower substituted congeners to develop correlations for different facility and feed types.

Based on the results from the Tier 1 analysis, it will be decided whether the sample was sufficiently complex to merit further investigation (e.g., number of peaks identified relative to total number of peaks). Again, complex samples would result in significant numbers of coeluting peaks, making spectral identifications difficult. This would ultimately result in a large number of unidentified compounds. If the samples analyzed using the Tier 1 approach indicate that a significant number of coeluting peaks exist, then Tier 2 should be used.

Tier 2: Sample Deconvolution

For Tier 2, the MM5 extracts would be run through an HPLC fractionation system. A solvent gradient would be used to partition the material eluting off an HPLC column according to elution time. Separating the MM5 extracts into multiple fractions of varying polarity, then running those fractions back through a GC/MS analysis, dramatically reduces the problems of coeluting peaks. This reduction is due to the fact that GC and HPLC use different techniques to differentiate compounds: GC separates primarily based on compound boiling points; whereas, HPLC separates primarily based on compound polarity.

The fractionated samples could also be run on a GC with atomic emission detection (AED). This detector is element specific and would aid in the interpretation of mass spectral data by confirming the presence of elements such as halogens, oxygen,

nitrogen, and sulfur.

Finally, the fractionated extracts could be analyzed by multidimensional gas chromatography (MDGC). The power of this technique has been demonstrated through this study.

5.0 REFERENCES

- 1 40 CFR Part 261 Identification and Listing of Hazardous Waste - Appendix VIII-Hazardous Constituents, July 1, 1990, Government Printing Office, Washington, DC.
- 2 Clean Air Act Amendments of 1990, P.L. 101-549, U.S. Congress, Washington, DC, November 15, 1990.
- 3 Resource Conservation and Recovery Act (RCRA), as amended by the Hazardous and Solid Waste Amendments of 1984, 40 CFR.
- 4 Hartzell, G.E., "Overview of Combustion Toxicology," *Toxicology*, **115**: 1-3, 7-23, December 1996.
- 5 Dellinger, B., P.H. Taylor, and D.A. Tirey, "Minimization and Control of Hazardous Combustion By-Products," EPA/600/S2-90/039 (NTIS PB90-259854), Risk Reduction Engineering Laboratory, Cincinnati, OH, August 1990.
- 6 Rigo, G.H., A.J. Chandler, and W.S. Lanier, "The Relationship Between Chlorine in Waste Streams and Dioxin Emissions from Waste Combustor Stacks," ASME Research Report CRTD-Vol 36, 1996.
- 7 Okey, A.B., D. Riddick, and P. Harper, "The Ah receptor: Mediator of the Toxicity of 2,3,7,8 TCDD and Related Compounds," *Toxicology Letters*, **70**: 1-22, 1994.
- 8 Ryan, J., P. Lemieux, C. Lutes, and D. Tabor, "Development of PIC Target Analyte List for Hazardous Waste Incineration Processes," Paper presented at the International Incineration Conference, Savannah, GA, May 6-10, 1996.
- 9 EPA Test Method 0040 "Sampling of Principal Organic Hazardous Constituents from Combustion Sources Using Tedlar Bags" in Test Methods for Evaluating Solid Waste, Volume II, SW-846 (NTIS PB88-239223). Environmental Protection Agency, Office of Solid Waste, Washington, DC. (August 1994).
- 10 EPA Test Method 0030 "Volatile Organic Sampling Train" in Test Methods for Evaluating Solid Waste, Volume II, SW-846 (NTIS PB88-239223). Environmental Protection Agency, Office of Solid Waste, Washington, DC. (September 1986).
- 11 EPA Test Method 0010 "Modified Method 5 Sampling Train" in Test Methods for Evaluating Solid Waste, Volume II, SW-846 (NTIS PB88-239223). Environmental Protection Agency, Office of Solid Waste, Washington, DC. (September 1986).
- 12 EPA Test Method 23 "Determination of Polychlorinated Dibenzo-p-dioxins and Polychlorinated Dibenzofurans from Stationary Sources" in Code of Federal Regulations, Title 40, Part 60, Appendix A, U.S. Government Printing Office, Washington, DC. (July 1991).
- 13 Richards, M.K., L.R. Waterland, and E. Whitworth, "Innovative Continuous Emission Monitors: Results of the EPA/DOE Demonstration Test Program," Paper presented at the International Incineration Conference, Savannah, GA, May 1996.

- 14 Ryan, J.V., P.M. Lemieux, W.T. Preston, and L.R. Waterland, "Field Demonstration of a Prototype On-Line Gas Chromatograph for Near-Real-Time Measurement of Trace Volatile Organic Products of Incomplete Combustion from Incinerators," *AWMA J.*, in press.
- 15 California Air Resources Board Method 428 "Determination of Polychlorinated Dibenzo-p-dioxin (PCDD), Polychlorinated Dibenzofuran (PCDF), and Polychlorinated Biphenyl Emissions from Stationary Sources" in *Methods for Determining Emissions of Toxic Air Contaminants from Stationary Sources, Volume III*, State of California Air Resources Board, December 1991.
- 16 EPA Test Method 5040 "Protocol for Analysis of Sorbent Cartridges from Volatile Organic Sampling Train" in *Test Methods for Evaluating Solid Waste, Volume II, SW-846 (NTIS PB-239223)*. Environmental Protection Agency, Office of Solid Waste, Washington, DC, September 1986.
- 17 EPA Test Method 8240 "Gas Chromatography/Mass Spectrometry for Volatile Organics" in *Test Methods for Evaluating Solid Waste, Volume II, SW-846 (NTIS PB-239223)*. Environmental Protection Agency, Office of Solid Waste, Washington, DC, September 1986.
- 18 Rubey, W.A., B. Dellinger, and R.C. Striebich, "Chemical Analysis of Combustion Samples Using Multi-Dimensional Gas Chromatography," Paper presented at the International Conference on Incineration and Thermal Treatment Technologies, May 12-16, 1997, Oakland, CA.
- 19 Anderson, S., J. Garver, W. Rubey, R. Striebich, and R. Grinstead, "The Separation and Identification of Trace Heteroatomic Species in Jet Fuel by Sample Enrichment and Multidimensional Gas Chromatography with Mass Selective Detection (MDGC-MSD)," *Proceedings of the 17th ISCCE*, Wintergreen, VA, May 1995.
- 20 Tsang, W., "Mechanisms for the Formation and Destruction of Chlorinated Organic Products of Incomplete Combustion," *Combustion Science and Technology*, 74:99-116 (1990).
- 21 Tirey, D.A., P.H. Taylor, J. Kasner, and B. Dellinger, "Gas Phase Formation of Chlorinated Aromatic Compounds from the Pyrolysis of Tetrachloroethylene," *Comb. Sci. Tech.*, **74**, 137-157, 1990.
- 22 Ryan, J.V., P.M. Lemieux, and P.W. Groff, "Evaluation of the Behavior of Flame Ionization Detection Total Hydrocarbon Continuous Emission Monitors at Low Concentrations," Paper presented at the International Conference on Incineration and Thermal Treatment Technologies, May 12-16, 1997, San Francisco, CA.

APPENDIX A QUALITY CONTROL EVALUATION REPORT

This project was conducted under the guidance of an EPA-approved QA Test Plan (APPCD Category III) . The Test Plan describes the intended experimental approach and procedures. The Test Plan also presents Data Quality Objectives (DQOs) for this study: to collect data of sufficient quality to develop a qualitative list of organic compounds present in HWC emissions. This list is not meant to be representative of all incineration configurations, conditions, or waste mixtures. Data Quality Indicator (DQI) goals were established to meet DQOs.

Table A-1 presents the DQI summaries for accuracy, precision, and completeness achieved during testing along with the planned DQI goals for each measurement or analysis performed. In general, the intended RKIS operational DQI goals were achieved. However, DQI goals for quantitative organic measurements generally were either not achieved or could not be assessed from the available data. Quantitative DQI goals were not met primarily due to poor surrogate and/or internal standard recoveries. As a result, the analytical data should be viewed as semiquantitative at best. While it is not appropriate to report organic emissions concentrations as absolute, the data are of sufficient quality to make rough order of magnitude quantitative comparisons between test condition data sets. It should be stressed, though, that qualitative identification was the primary goal of this project, not quantitative. The recovery problems have negligible impact on the qualitative identification of the PICs. As a result, the data are of sufficient quality to meet project objectives to develop a qualitative list of organic compounds present in HWC emissions.

Case narratives for specific analytical activities are included in the following subsections.

A.1 - Continuous Measurement Results

The THC analyzers failed after Run 11 due to the high HCl content of the flue gas. Their data were not available for Runs 12 through 16, resulting in a completeness of 69.4%, which was slightly below the desired 70% completeness. In addition, the Bodenseewerk HCl CEM was not available during Runs 13 through 16 due to its redeployment on other facilities, resulting in a 75% completeness of data. Other CEMs passed QC criteria.

The thermocouple at the kiln exit failed after Run 8 and was not available during Runs 9 through 12, resulting in a completeness of 75% for that thermocouple. A replacement thermocouple was installed at that point, and kiln exit temperatures were measured during subsequent tests. All other thermocouples operated normally within QC guidelines.

There was an anomaly in the bromine feed concentration in the batch of feed used in Run 10. All of the other runs were prepared at 449.8 g Br per batch, while run 10 was at 1589.8 g Br per batch.

Table A-1. Data Quality Indicator Summary for Critical Measurements

Measurement	Accuracy Goal	Accuracy Achieved	Precision Goal	Precision Achieved	Completeness Goal	Completeness Achieved
O2	±5	pass	5	pass	70	100
CO2	±5	pass	5	pass	70	100
CO	±5	pass	5	pass	70	100
THC	±5	pass ^a	5	pass ^a	70	68.75
NO	±5	pass	5	pass	70	100
Temperature	±2	NA	±2	±2	100	100 (75)
HCl	±5	NA	5	pass	70	75
VOCs (VOST)	50-150	fail	NA	NA	75	100
VOCs (Tedlar Bag)	50-150	fail	30	NA	75	100
SVOCs	18-120	fail	30	NA	75	100
PCDDs/PCDFs	40-120	*a	30	NA	70	100
VOCs (OLGC)	NA	NA	NA	NA	NA	NA

a - see additional information in text.

A.2 - Volatile Organic Compound Analyses

A.2.1 - VOST Samples

The 30 day holding times to analysis for these samples were generally adhered to.

The surrogate recoveries for the VOST compounds were mostly below the pass/fail criterion of 50-150%. The insufficient recoveries do not, however, impact the qualitative analysis of the data. A possible reason for the failure of the recoveries of internal standards is that the extremely high HCl content (several thousand ppmv) of the flue gas may have degraded the Tenax' ability to adsorb VOCs. The VOST method is intended for application downstream of particulate and acid gas control systems and not in the highly corrosive environment during these tests.

The first internal standard (bromochloromethane) was identified as a PIC. Because of this, the

second internal standard was used to quantify the targets that are normally referenced to the first internal standard.

The blanks showed a general trend of having common ketones, solvents, and chloromethane present (as is common for VOST samples) as contaminants. There were also a few instances of a minor carryover from the daily standard. But with target hits as high as 5000 ng per tube of benzene and many other compounds being near 1000 ng per tube, the contaminant levels were insignificant relative to sample levels.

Many of the VOST samples exhibited concentrations higher than the calibration range. The concentrations of these compounds will tend to be over-estimated due to non-linear responses of the mass spectrometer at regions above the calibration range. The nature of the VOST sampling/analysis does not allow reanalysis or dilution to bring these compounds into the calibration range. Data exceeding calibration levels are flagged as estimates. Given the semiquantitative nature of reported results, these estimates do not pose a problem.

A.2.2 - Tedlar Bag Samples

Hold times did not exceed 1 day, which is acceptable.

The blank samples were generally clean with only a few compounds reported above the practical quantitation limit (PQL). Few PICs were found in the blank samples.

There were inconsistencies in the reported recoveries of surrogate standards, which make it difficult to assess the quality of the quantitations. Based on careful examination of available data, in both hard copy and disk form, it is believed that the qualitative results are correct, but that the quantitative results may be in error by a factor of 2.5. Since these data are compared only to other test conditions, relative differences are not affected.

A.3 - Semivolatile Organic Compound Analyses

Semivolatile analysis by SW-846 Method 8270 was completed for eight samples. Filter and XAD-2 fractions were extracted separately. In general, filter extract surrogate recoveries were low, with many being just barely acceptable. The XAD samples, generally showed acceptable recovery. In all analyses, the surrogate recovery is worse for the earlier eluting (lower boiling point) compounds. A contributor to poor recovery was that some sample extracts were concentrated on a rotary evaporator (Roto-Vap) instead of the Kaderna-Danish concentrating apparatus which is specified in the method. This technique is less efficient and would result in greater azeotropeing and, therefore, the preferential loss of the more volatile surrogate standards.

After these samples exhibited the poor recoveries, the laboratory stopped using the Roto-Vap apparatus for semivolatile samples and resumed using the Kaderna-Danish apparatus. Volatile surrogate standard recoveries improved somewhat. Matrix effects, due to the extremely high HCl content of the sample collected, also likely impacted surrogate recoveries. Fortunately, the poor volatile surrogate standard recoveries were associated primarily with the filter extracts. During sampling, the more volatile species would tend to be collected on the XAD-2 rather than the filter. While the poor surrogate recovery problem impacts quantitative capabilities, qualitative information should not be compromised. This tenet is supported by the independent identification of overlapping PICs in both the VOST and MM5 samples.

Due to the high concentrations of nontarget analytes in the initial MM5 analyses, many reactive compounds responded poorly. Initial MM5 extracts, once concentrated to 1 mL, were dark and non-transparent. It is likely that the cumulative effect of injection of these corrosive, complex samples caused active sites to develop in the injection port and entrance of the column causing poorer responses for these more reactive compounds. Frequent injector and guard column maintenance reduced this problem. To verify acceptable MS and chromatographic performance, the decafluorotriphenylphosphine (DFTPP) tuning criterion was met prior to sample analyses each day, and the degradation products of dichlorodiphenyltrichloroethane (DDT) (compound in the DFTPP tuning solution) demonstrated less than 6% degradation prior to sample analyses for each day. DDT is a typical example of a labile compound used by the method to determine the condition of the chromatographic system. If degradation of DDT was greater than 20%, GC maintenance was performed. In an effort to improve chromatographic separations, GC conditions were modified to reduce the oven temperature ramping rate and to optimize column carrier flowrate from levels used during the initial analyses.

The five-point calibration ranged from 10 to 120 ng injected on column (except for the acid surrogates which ranged from 20 to 240 ng). Poorer responding compounds' PQLs -- defined here as the lowest point on the calibration curve -- were raised to 30 and sometimes 60 ng to obtain good response correlation throughout the calibration range.

All continuing calibration check compounds (CCC) and System Performance Check Compounds (SPCCs) had less than 30 % relative standard deviation and greater than 0.05 relative response, respectively (prior to daily sample analyses), which satisfies Method 8270 cutoff values.

A.4 - PCDD/PCDF and PBDD/PBDF Analyses

Both chlorinated and brominated DD/DF analyses were performed. As described earlier, the PCDD/PCDF analyses were performed following standardized procedures. A significant portion of the internal standard surrogate recovery results were outside of the method criteria (40-120%)

with many recoveries in the 20-30% range. Recoveries were highly variable but didn't seem to have a pattern. Run 11's filter fraction, Run 12's XAD fraction, and Run 13's filter fraction exhibited below 1% recoveries of the internal standards. Run 14's filter was lost and no extract was produced. These results, although not quantifiable within method criteria, are still usable to evaluate trends between test conditions.

Formalized methods for identifying and quantifying brominated DD/DF do not exist. As a result, the analyses performed were essentially a screening technique attempting to verify the presence or absence of select PBDD/PBDF congeners for which limited standards are available. For the brominated compounds, the ion ratio was the only definitive criterion available to confirm presence: no window defining mixes are available. The retention time was evaluated compared to the ^{13}C labeled TBDD/F standards. We used a general rule that a compound with a bromo substitution would correspond roughly to the retention time area of the same compound with a dichloro substitution. The fully brominated penta, hexa, and hepta diphenyl ethers were monitored for, but none were detected. This indicates that there was no interference between the fully brominated furans and these compounds. This approach is sufficient to screen for the presence of PBDD/PBDF PICs.

A.5 - Online GC Samples

On-line GC measurements were performed primarily to evaluate performance as a potential VOC monitor. No DQI goals were established. Each day a system bias check was performed to verify that recoveries of a 200 ppb sample were within the range of 50-150% by injecting a VOC standard mix into the probe at the stack and comparing the measured concentrations to the same mix injected directly into the sparge vessel of the OLG. The system passed the system bias check each day. In addition, system blanks were performed to verify that no targets were present in the system prior to each run day, and a calibration was performed each day to verify retention times and concentrations.