



UNITED STATES ENVIRONMENTAL PROTECTION AGENCY
WASHINGTON, D.C. 20460

August 22, 2003

OSWER 9285.7-50A

OFFICE OF
SOLID WASTE AND EMERGENCY
RESPONSE

MEMORANDUM

SUBJECT: Superfund Lead-Contaminated Residential Sites Handbook

FROM: Michael B. Cook, Director /s/ Elizabeth Southerland for
Office of Superfund Remediation and Technology Innovation

TO: Superfund National Program Managers, Regions 1- 10

Purpose:

I am pleased to transmit the attached Superfund Lead-Contaminated Residential Sites Handbook (subsequently referred to as the Handbook). The Handbook has been prepared to assist Superfund project managers working on the characterization and cleanup of lead-contaminated residential sites. Resource Conservation and Recovery Act (RCRA) project managers and others may also find it useful. It is intended to promote national consistency in the characterization and cleanup of lead-contaminated residential sites, while retaining the flexibility needed to respond to different sites and communities to ensure the success of the remedy and provide long-term protection of human health. The Handbook incorporates lessons learned from EPA's experience in remediating residential lead sites, as well as current technical and scientific literature addressing lead-contaminated residential sites.

The Handbook is not intended to apply to lead-contaminated commercial or industrial properties, other non-residential areas, or sites with ecological risks, although some of the concepts may be useful for such properties. The Handbook does not, outside the federal facilities universe, apply to lead-contaminated residential sites addressed under Title X procedures. A separate section of the Handbook is devoted to lead-contaminated properties at federal facilities.

BACKGROUND:

The draft handbook was developed primarily by the Lead Sites Workgroup (LSW), consisting of members from U.S. Environmental Protection Agency (EPA) Regional and Headquarters offices. This handbook has undergone previous reviews and has been revised to incorporate the comments from various EPA Regional and Headquarters offices, the Agency for Toxic Substances and Disease Registry (ATSDR) and more than 20 State agencies.

The LSW was established to develop guidance and position papers that clarify national policy, or address issues lacking clear policy regarding response to lead contamination at Superfund sites. The LSW is made up of representatives from Office of Site Remediation and Technology Innovation (OSRTI) and Federal Facilities Restoration and Reuse Office (FFRRO), Regional Remedial Project Managers (RPMs), RCRA project managers and a representative from the Agency for Toxic Substances and Disease Registry (ATSDR).

Consistent with the OSWER Clarification Memorandum (OSWER Directive # 9200.4-27P), residential properties are defined in the Handbook as any area with high accessibility to sensitive populations, and includes properties containing single- and multi-family dwellings, apartment complexes, vacant lots in residential areas, schools, day-care centers, community centers, playgrounds, parks, greenways, and any other areas where children may be exposed to site-related contaminated media. The Handbook defines sensitive populations as young children (those under 7 years of age, who are most vulnerable to lead poisoning) and pregnant women.

Throughout the development of the Handbook, the goal was to produce a complete reference that new and experienced project managers will find useful, while also keeping it to a manageable size. This has been accomplished by including the minimum considerations for addressing lead-contaminated residential sites in the Handbook and referring to appropriate agency guidance and/or policy where necessary. The Handbook addresses all aspects of the remediation process, from initial research on the nature and extent of site contamination, through cleanup level selection and the prevention of recontamination. Separate sections of the Handbook are devoted to community involvement and health education. To supplement the text, the Handbook includes flowcharts that provide a general overview (Figure 1-1) and a detailed 'roadmap' (Figure 5-1) of the cleanup process. Examples of property access forms, inspection checklists, closeout forms and 'clean letters' are provided in the Appendices for the convenience of the user.

Conclusions:

This handbook is intended to provide a comprehensive reference that new and experienced project managers will find useful in the characterization and cleanup of lead-contaminated residential sites. The handbook lays out only the minimum considerations for addressing lead-contaminated residential sites and the project manager is encouraged to use site-specific considerations in making final decisions. The LSW is available for brief training sessions and consultation on the use of the Handbook. Please contact your regional representative of the LSW for assistance (see page iii of the Handbook). If you have other questions, please e-mail or call Shahid Mahmud at Mahmud.Shahid@epa.gov or (703) 603-8789.

Attachments

cc: Steve Luftig,, Senior Advisor to OSWER Assistant Administrator
Jim Woolford, FFRRO

Debbie Dietrich, OEPPR
Robert Springer, OSW
Cliff Rothenstein, OUST
Linda Garczynski, OBCR
Elliott Gilberg, FFEO
Susan Bromm, OSRE
Charles Openchowski, OGC
Walt Kovalick, TIP/OSRTI
OSRTI Center Directors and Senior Process Managers
Nancy Riveland, Superfund Lead Region Coordinator, USEPA Region 9
Jeff Josephson
NARPM Co-Chairs
Joanna Gibson, OSRTI Documents Coordinator

The attached Superfund Lead-Contaminated Residential Sites Handbook (subsequently referred to as the Handbook) was prepared to assist Superfund project managers working on the characterization and cleanup of lead-contaminated residential sites. Resource Conservation and Recovery Act (RCRA) project managers and others may also find it useful.

It is intended to promote national consistency in the characterization and cleanup of lead-contaminated residential sites, while retaining the flexibility needed to respond to different sites and communities to ensure the success of the remedy and provide long-term protection of human health. The Handbook incorporates lessons learned from EPA's experience in remediating residential lead sites, as well as current technical and scientific literature.



United States
Environmental Protection
Agency

Office of Emergency
and Remedial Response

OSWER 9285.7-50
August 2003

PB2004-100017

Superfund Lead-Contaminated Residential Sites Handbook

Final: August 2003

Prepared by the

**Environmental Protection Agency
Lead Sites Workgroup (LSW)**

NOTICE

This document has been reviewed in accordance with U.S. EPA policy and is approved for publication. Mention of trade names or commercial products does not constitute endorsement or recommendation.

DISCLAIMER

This document provides guidance to EPA Regions concerning how the Agency intends to exercise its discretion in implementing one aspect of the CERCLA remedy selection process. The guidance is designed to implement national policy on these issues.

Some of the statutory provisions described in this document contain legally binding requirements. However, this document does not substitute for those provisions or regulations, nor is it a regulation itself. Thus, it cannot impose legally-binding requirements on EPA, states, or the regulated community, and may not apply to a particular situation based upon the circumstances. Any decisions regarding a particular remedy selection will be made based on the statute and regulations, and EPA decision makers retain the discretion to adopt approaches on a case-by-case basis that differ from this guidance where appropriate.

Interested parties are free to raise questions and objections about the substance of this guidance and the appropriateness of the application of this guidance to a particular situation, and the Agency welcomes public input on this document at any time. EPA may change this guidance in the future.

**CONTRIBUTING MEMBERS of
Lead Sites Workgroup of
U.S. Environmental Protection Agency**

Shahid Mahmud, Co-Chair

U.S. EPA HQ
Bus: (703) 603-8789
E-mail: mahmud.shahid@epa.gov

Brad Bradley, Co-Chair

U.S. EPA Region 5
Bus: (312) 886-4742
E-mail: bradley.brad@epa.gov

Monica McEaddy

U.S. EPA HQ
Bus: (202) 603-0044
E-mail: mceaddy.monica@epa.gov

Rafael Casanova

U.S. EPA Region 6
Bus: (214) 665-7437
E-mail: casanova.rafael@epa.gov

Ron Morony

U.S. EPA HQ
Bus: (202) 260-0282
E-mail: morony.ronald@epa.gov

Mark Doolan

U.S. EPA Region 7
Bus: (913) 551-7169
E-mail: doolan.mark@epa.gov

Byron Mah

U.S. EPA Region 1
Bus: (617) 918-1249
E-mail: mah.byron@epa.gov

Sara Sparks

U.S. EPA Region 8
Bus: (406) 782-7415
E-mail: sparks.sara@epa.gov

Mark Maddaloni

U.S. EPA Region 2
Bus: (212) 637-3765
E-mail: maddaloni.mark@epa.gov

Shea Jones

U.S. EPA Region 9
Bus: (415) 972-3148
E-mail: jones.shea@epa.gov

Khai Dao

U.S. EPA Region 3
Bus: (215) 814-5467
E-mail: dao.khai@epa.gov

Sean Sheldrake

U.S. EPA Region 10
Bus: (206) 553-1220
E-mail: sheldrake.sean@epa.gov

Charlie Root

U.S. EPA Region 3
Bus: (215) 814-3193
E-mail: root.charlie@epa.gov

Steve Jones

ATSDR
Bus: (703) 603-8729
E-mail: jones.steve@epa.gov

Beth Walden

U.S. EPA Region 4
Bus: (404) 562-8814
E-mail: walden.beth@epa.gov

CONTENTS

DISCLAIMER	ii
CONTRIBUTING MEMBERS of Lead Sites Workgroup of U.S. Environmental Protection Agency ..	iii
CONTENTS	iv
LIST OF TABLES AND FIGURES	vi
ACRONYMS	vii
1.0 INTRODUCTION	1
1.1 BACKGROUND	4
1.2 GENERAL DISCUSSION ON CERCLA'S APPLICABILITY TO LEAD SITES	4
1.2.1 Background	4
1.2.2 Response Authorities	5
1.2.3 Applicable or Relevant and Appropriate Requirements (ARARs)	6
1.3 DEFINITION AND PURPOSE	7
2.0 COMMUNITY INVOLVEMENT	9
2.1 EDUCATION ACTIVITIES	9
2.2 COMMUNITY ADVISORY GROUPS	10
2.3 EPA'S TECHNICAL ASSISTANCE GRANT PROGRAM	11
2.4 INFORMATIONAL MEETINGS	12
2.5 COMMUNITY INVOLVEMENT SPECIALIST/COORDINATOR	13
3.0 HEALTH EDUCATION	14
3.1 APPROPRIATE USES FOR HEALTH EDUCATION	14
3.2 PLANNING FOR HEALTH EDUCATION	14
3.3 EVALUATION OF HEALTH EDUCATION ACTIVITIES	15
3.4 AGENCY FOR TOXIC SUBSTANCES AND DISEASE REGISTRY (ATSDR) INVOLVEMENT	15
3.5 OUTREACH	16
4.0 SITE CHARACTERIZATION	17
4.1 CONTAMINANT ZONE DELINEATION	17
4.2 RESIDENTIAL PROPERTIES	19
4.2.1 Sampling Access	19
4.2.2 Residential Yards	21
4.2.3 Drip Zones	23
4.2.4 Play Areas, Gardens, and Driveways	24
4.2.5 Potable Water, Lead-Based Paint and Interior Dust	24
4.2.6 Backfill and Waste Soil	24
4.3 SAMPLING METHOD AND ANALYSIS	25
4.3.1 Sample Collection	25
4.3.2 Sample Depth	25
4.3.3 Sample Preparation	27
4.3.4 Sample Analysis	27
5.0 CLEAN-UP LEVEL SELECTION	29
5.1 PRIORITIZING RESPONSE ACTIONS	29
5.2 LONG-TERM REMEDIAL ACTION	35
6.0 APPLICATION OF CLEAN-UP NUMBERS/REMEDICATION	37
6.1 MINIMUM EXCAVATION DEPTH/SOIL COVER THICKNESS	37
6.2 SOIL CLEAN-UP OPTIONS	38
6.3 INTERPRETING SAMPLING RESULTS	39
6.4 OTHER CLEANUP CONSIDERATIONS	44
6.4.1 Background Lead Concentrations	45

6.5	YARD CLEANUP SPECIFICS	46
6.6	CLEANUP OF OTHER SOURCES OF LEAD	49
	6.6.1 Lead-Based Paint	50
	6.6.2 Interior Dust	50
	6.6.3 Lead Plumbing/Tap Water	52
6.7	PREVENTION OF RECONTAMINATION	53
	6.7.1 Early Actions	56
	6.7.2 Long-term Remedial Action	57
	6.7.3 Institutional Controls (ICs)	58
6.8	CLEAN-UP DOCUMENTATION	61
6.9	ENFORCEMENT	62
7.0	FIVE-YEAR REVIEW	64
8.0	FEDERAL FACILITIES	66
REFERENCES		70
APPENDIX A	Title X and EPA's Toxic Substances Control Act (TSCA) Title IV Lead Program	A-1
APPENDIX B	1998 OSWER Directive 9200.4-27P ('Clarification')	B-1
APPENDIX C	Contacts and Software for Sampling Design	C-1
APPENDIX D	Examples of Property Access Agreement Forms	D-1
APPENDIX E	Example of Dust Abatement Access Form	E-1
APPENDIX F	Example of Property Inspection Checklist	F-1
APPENDIX G	Examples of Property Closeout Forms	G-1
APPENDIX H	Examples of Clean Letters	H-1

LIST OF TABLES AND FIGURES

Table 4-1.	
Rationale for Sampling Residential Properties	20
Figure 1-1. An Overview to the Clean-up Process	3
Figure 4-1a. Recommended minimum soil sampling in yards less than or equal to 5,000 square feet with small side yard.	21
Figure 4-1b. Recommended minimum soil sampling in yards less than or equal to 5,000 square feet with substantial side yard.	22
Figure 4-2. Recommended minimum soil sampling in yards greater than 5,000 square feet	23
Figure 5-1. Recommended clean-up process for lead-contaminated residential sites.	30
Figure 6-1. Interpreting Sampling Results.	40
Figure 6-2a. Partial cleanup of residential lot less than or equal to 5,000 square feet in size.	42
Figure 6-2b. Partial cleanup of residential lot greater than 5,000 square feet in size	43
Figure 6-3. Implementing Best Management Practices (BMPs) during construction work	55

ACRONYMS

ARARs	Applicable or Relevant and Appropriate Requirements	LSCG	Lead Sites Consultation Group
ASTM	American Society for Testing and Materials	MCL	Maximum Contaminant Level
ASTSWMO	Association of State and Territorial Solid Waste Management Officials	NCP	National Contingency Plan
ATSDR	Agency for Toxic Substances and Disease Registry	NLLAP	National Lead Laboratory Accreditation Program
BMPs	Best Management Practices	NTCRA	Non-Time-Critical Removal Action
BRAC	Base Realignment and Closure	OSWER	EPA Office of Solid Waste and Emergency Response
CAGs	Community Advisory Groups	PRG	Preliminary Remediation Goal
CERCLA	Comprehensive Environmental Response, Compensation, and Liability Act	PRP	Potentially Responsible Party
CIC/CIS	Community Involvement Coordinator/ Specialist	RCRA	Resource Conservation and Recovery Act
DOD	Department of Defense	SEP	Supplemental Environmental Project
FOSL	Finding of Suitability to Lease	TAG	Technical Assistance Grant
FOST ¹	Finding of Suitability to Transfer	TCLP	Toxicity Characteristic Leaching Procedure
FP-XRF	Field-Portable X-Ray Fluorescence	TCRA	Time-Critical Removal Action
HUD	Department of Housing and Urban Development	TITLE X	Title X of the Housing and Community Development Act of 1992, 42 U.S.C. 4822
IC	Institutional Control	TRW	EPA Technical Review Workgroup
LBP	Lead-Based Paint	TSCA	Toxic Substances Control Act
IEUBK	Integrated Exposure Uptake Biokinetic Model for Lead in Children	UAO	Unilateral Administrative Order

1.0 INTRODUCTION

This Superfund Lead-Contaminated Residential Sites Handbook (subsequently called the Handbook) has been developed by the U.S. Environmental Protection Agency (EPA) to promote a nationally consistent decision-making process for assessing and managing risks associated with lead-contaminated residential sites across the country.

The primary audience for this risk management document is Superfund project managers working on the characterization and cleanup of lead-contaminated residential sites; however, Resource Conservation and Recovery Act (RCRA) project managers may also find it useful. This information was developed primarily for EPA staff, but may prove useful to others working on lead-contaminated residential sites, including states, other federal agencies, tribes, local governments, public interest groups, and private industry. While this Handbook is not intended to apply to lead-contaminated commercial or industrial properties, other non-residential areas, or sites with ecological risks, some of the concepts may be useful for such properties. Addressing lead-contaminated properties at federal facilities requires a different approach, and this Handbook provides a special section (Section 8) on addressing this universe of sites.

Generally, Comprehensive Environmental Response, Compensation, and Liability Act (CERCLA) response actions are undertaken to address a release or threat of release of a hazardous substance such as lead into the environment. Lead contamination found inside homes may be caused by deteriorating lead-based paint (LBP), plumbing, or other sources not resulting from a release into the environment, and therefore may be more appropriately addressed by authorities and programs other than CERCLA (see Appendix A and Section 6.6 of this Handbook). However, it may be appropriate to use CERCLA authorities to conduct sampling and site characterization activities to determine the source of the lead contamination and to differentiate between various site-related sources.

The Handbook lays out only the minimum considerations for addressing lead-contaminated residential sites and encourages users to refer to appropriate agency guidance and/or policy to conduct more stringent investigation and clean-up activities on a site-specific basis, if necessary. In addition, the site manager should determine the applicable and relevant or appropriate requirements (ARARs), including state laws and regulations, that apply to the site. It should also be noted that this Handbook does not, outside the federal facilities universe, apply to lead-contaminated residential sites addressed under Title X (HUD, 1992) procedures.

Lead site characterization and clean-up procedures are unique owing to the ubiquitous nature of lead exposures and the reliance on blood lead concentrations to describe lead exposure and toxicity. Lead

risks are characterized by predicting blood lead levels with computer models and guidance developed by EPA, which are available on the internet: <http://www.epa.gov/superfund/programs/lead/products.htm>. Major improvements in the removal of lead from gasoline, paint, and food packaging have significantly reduced the incidence of severe lead poisoning. The results of this progress mean that most environmental sources of lead exposure are more likely to cause subtle adverse health effects, primarily behavioral and learning impairments.

An overview to the clean-up process is provided as Figure 1-1. Section numbers are provided in the figure to help the reader locate information within this document.

Figure 1-1. An Overview to the Clean-up Process

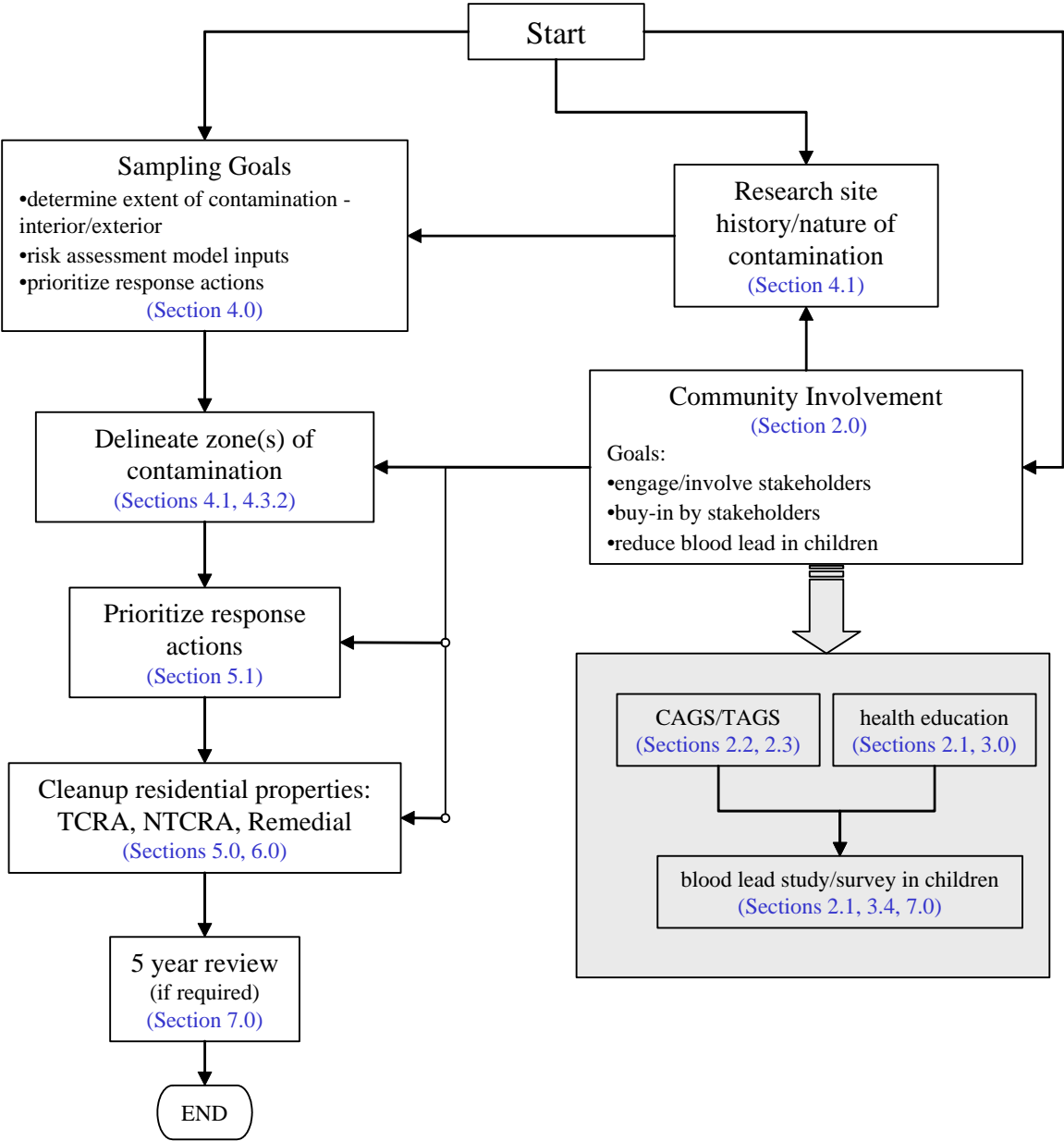

1.1 BACKGROUND

Elevated blood lead concentrations in young children in the United States are still prevalent in many areas. Major sources of lead contamination historically included mining and milling sites, primary and secondary smelters, battery manufacturing and recycling facilities, pesticide formulators, pesticide use in orchards, and paint manufacturers (prior to 1978). Many of the source facilities are located near residential areas or have had residential areas develop around them. Fugitive emissions from the facilities have resulted in soil contamination in the yards of residences, which in turn can cause high blood lead levels in children.

Although numerous sites of this type exist, EPA has remediated, or overseen the remediation of, many of these sites and surrounding residences. Many different clean-up methods have been implemented with varying degrees of success. This document is based on the lessons learned from EPA's experience in remediating residential lead sites. It is intended to promote consistency in the characterization and cleanup of lead-contaminated residential sites, while retaining the flexibility needed to respond to different sites and communities to ensure success of the remedy and provide long-term protection of human health. The document also provides guidance on addressing lead sources and media that the Superfund does not usually remediate, such as LBP and lead plumbing. It is anticipated that this information will be periodically updated as we strive to improve our ability to respond to environmental lead hazards.

1.2 GENERAL DISCUSSION ON CERCLA'S APPLICABILITY TO LEAD SITES

This section provides a general discussion of the sections of CERCLA that address lead-contaminated sites. A description of Title X and EPA's Toxic Substances Control Act (TSCA) IV Lead Program is provided in Appendix A. The Title X discussion is provided for informational purposes and is primarily applicable to federal facilities. Section 4.2.5 also provides useful information for LBP and dust sampling.

1.2.1 Background

Historically, the CERCLA has been used as a tool to implement clean-up activities at a large number of sites across the country. CERCLA authorities have been used for cleanups ranging from the removal of drums of hazardous substances from long-abandoned sites, to major privately funded remedial actions at sites on the National Priorities List (NPL).

CERCLA may apply any time there is a release or threatened release of: (1) a hazardous substance into the environment, or (2) a pollutant or contaminant "which may present an imminent and substantial endangerment to the public health or welfare" (EPA, 2000a). The term "release" is defined broadly in the statute and includes discharging or leaking of substances into the environment. This also includes the abandonment of closed containers containing hazardous substances, pollutants, or contaminants.

The definition of hazardous substance is extremely broad, and is defined in CERCLA Section 101(14). A comprehensive list of these substances is provided in 40 CFR 302.4. In addition to general listings for "lead", "lead and compounds", and "lead compounds," the regulation lists fourteen other subcategories of lead.

Additionally, CERCLA is not media-specific. Thus, it may address releases to air, surface water, groundwater, and soils. This multi-media aspect of CERCLA makes it possible to conduct environmental assessments and design clean-up projects that address site contaminants in a comprehensive way.

The Agency has pursued a number of CERCLA response actions involving lead-contaminated soil using the abatement authority under Section 106 (which also requires a showing of imminent and substantial endangerment). CERCLA covers almost every constituent found at mining and mineral processing (primary lead and other metals smelters) sites. Exceptions include petroleum (that is not mixed with a hazardous substance) and, in some cases, responses to releases of a naturally occurring substance in its unaltered form. It should be noted, however, that the latter exception does not include any of the releases typically dealt with at mining sites, such as acid mine drainage, waste rock, or any ore exposed to the elements by man.

1.2.2 Response Authorities

CERCLA's main strength is its response authorities. EPA can either use the Superfund to perform response (removal or remedial) activities (Section 104) or require private parties to perform such activities (Section 106). CERCLA gives EPA the flexibility to clean up sites based upon site-specific circumstances. EPA's clean-up decisions generally are based upon both risk assessment and consideration of ARARs. As long as the jurisdictional prerequisites have been met, CERCLA gives EPA the ability to perform virtually any clean-up activity necessary to protect public health and the environment.

There are potential limitations in CERCLA which may be relevant to lead-contaminated sites. For example, Section 104(a)(3) limits EPA's ability to respond to releases within residential structures as follows:

“Limitations on Response. The President (EPA) shall not provide for removal or remedial action under this section in response to a release or threat of release . . . from products which are part of the structure of , and result in exposure within, residential buildings or business or community structures . . . “

The above cited section of CERCLA generally limits EPA’s authority to respond to LBP inside a structure or house as written in Section 6.6.1 of this Handbook. However as noted in Section 6.6.1 of the Handbook, EPA has the authority to conduct response actions addressing soils contaminated by a release of lead-contaminated paint chips from the exterior of homes to prevent recontamination of soils that have been remediated. In addition, Section 104(a)(4) provides an exception to the limitations in Section 104(a)(3).

CERCLA provides EPA with the authority to perform "removal" and "remedial" actions. Assessments generally are considered “removal” actions and evaluate contaminants of concern, exposure pathways, and potential receptors. The assessment process includes the review of available information, as well as sampling, to obtain other necessary information. The process is broad in its application and is a powerful tool in evaluating environmental risks posed by a site. Removal actions can be performed on mining and mineral processing (primary lead and other metals smelters) sites, and other sites with lead releases to the environment, of any size. Removal actions are subject to limits on time (12 months) and money (\$2,000,000) under the statute; however, these limits are subject to exceptions.

Remedial actions are typically long-term responses performed at those sites placed on the NPL. Remedial actions also may be performed at non-NPL sites, through administrative orders on consent (AOCs) or consent decrees, if they are privately financed. Remedial actions are not subject to the time or dollar limitations imposed on removal actions, but require a more detailed and formal decision process.

1.2.3 Applicable or Relevant and Appropriate Requirements (ARARs)

Under Section 121(d) of CERCLA, remedial actions must comply with substantive provisions of federal environmental laws and more stringent, timely identified state environmental or facility siting laws. Removal actions should comply with ARARs to the extent practicable. “Applicable” requirements are those federal or state laws or regulations that specifically address a hazardous substance, pollutant, contaminant, remedial action, location, or other circumstance found at a CERCLA site. “Relevant and appropriate” requirements are not "applicable," but address problems or situations similar enough to those at the CERCLA site that their use is well suited to the site.

State requirements are not considered ARARs unless they are identified in a timely manner and are more stringent than federal requirements. The recently published TSCA §403 Soil Hazard Rule, which establishes a soil-lead hazard of 400 ppm for bare soil in play areas and 1,200 ppm for bare soil in non-play areas of the yard, should not be treated as an ARAR. As recognized in the TSCA §403 Rule, lead contamination at levels equal to or exceeding the 400 ppm and 1,200 ppm standards may pose serious health risks based upon a site-specific evaluation and may warrant timely response actions. However, the soil-lead hazard levels under the TSCA §403 Rule should not be used to modify approaches to addressing brownfields, NPL sites, state Superfund sites, federal CERCLA removal actions and CERCLA non-NPL facilities.

EPA has published a manual outlining potential federal ARARs that may be requirements at Superfund sites. Published in two parts, the manual is entitled *CERCLA Compliance with Other Laws Manual*, Part I, August 1988, and Part II, August 1989, and is available at EPA libraries (EPA, 1988).

1.3 DEFINITION AND PURPOSE

Residential properties are defined in the Handbook as any area with high accessibility to sensitive populations, and includes properties containing single- and multi-family dwellings, apartment complexes, vacant lots in residential areas, schools, day-care centers, community centers, playgrounds, parks, green ways, and any other areas where children may be exposed to site-related contaminated media (EPA, 1996a, 1997a, 1998a). This document defines sensitive populations as young children (those under 7 years of age, who are most vulnerable to lead poisoning) and pregnant women. Focus is put on children less than 7 years old because blood lead levels typically peak in this age range (EPA, 1986, 1990a; CDC, 1991). Unfortunately, this age range is also when children are most vulnerable to adverse cognitive effects of lead (Rodder, 1995). Pregnant women are included due to the effects of lead on the fetus (Gayer, 1990; Graziano et al., 1990; Carbone et al., 1998). Other EPA guidance (EPA, 1995a, 2001b) and local zoning regulations should also be consulted prior to determining which properties will be treated as residential.

Lead-contaminated residential sites are defined, for the purposes of this document, as sites where lead is the primary contaminant of concern in residential soils. Generally, lead-contaminated sites contain other metals of concern, such as cadmium and arsenic. This document, while addressing primarily lead contamination, may also be appropriate for use in the remediation of sites contaminated by other metals. In all cases, looking at the site history (type of lead site, depositional environment for the lead contamination, fill activities, previous epidemiological studies, etc.) is important in the use of the Handbook. Typically, the types of sites addressed by the Handbook are sites where the lead contamination has resulted primarily from primary or secondary lead smelting, battery cracking, or

mining and milling operations. Lead paint and dust, along with other sources of lead and other toxic metals, may also be present at these sites.

The Handbook is primarily based on a compilation of the Superfund program knowledge and experiences, as well as existing technical and scientific literature addressing lead-contaminated residential sites. The Handbook has undergone broad review by the Agency for Toxic Substances and Disease Registry (ATSDR), the Association of State and Territorial Solid Waste Management Officials (ASTSWMO), and national and regional EPA offices. Because the Handbook is written for use by CERCLA program staff, there are frequent references to guidance or other documents developed under the Superfund auspices. The Handbook does not supersede or modify any existing EPA guidance or policy. This guidance does not suggest that CERCLA authorities are to be applied at all lead-contaminated residential sites. Rather, these references are provided to the reader as resources to be considered in developing site characterization and clean-up strategies under whatever regulatory or non-regulatory approach is appropriate at a particular site. However, the NCP should be followed and other applicable guidance consulted when addressing lead-contaminated residential sites under CERCLA. The Handbook does not address ecological risks from lead and lead sites.

2.0 COMMUNITY INVOLVEMENT

The sustainability of a residential clean-up project in many ways is contingent upon support from affected residents, elected officials, local public health agencies, municipal and public works staff, state government personnel, and other stakeholders. Few sites impact more citizens of a community than large residential clean-up projects, with many projects exceeding a thousand homes and several thousand residents. If the residents recognize the risks posed to their community and feel involved in the decision-making process, they are more likely to accept the need for cleanup. House-to-house personal interaction with residents can be useful to learn their concerns (or lack of concerns) and can also be an effective part of educating the public regarding risks posed by the site. The project manager should issue bulletins and/or fact sheets to help keep the community informed of site activities and should consider establishing a toll free number for residents to contact her/him with questions about the site. Likewise, without the support of local governments, portions, if not all, of the selected remedy may be more difficult to implement. Many remedies rely in part on health education and institutional controls (ICs) as part of the actions taken to protect human health, both of which may rely on the active participation of local governments and health departments. The following sub-sections provide information on involving the community.

2.1 EDUCATION ACTIVITIES

This section discusses how to involve the local health departments and community in the education activities and the overall benefits and limitations of health education. Section 3 addresses health education activities in detail.

Several studies have shown that a significant short-term reduction in blood lead concentrations can be achieved through the education of the public on the dangers of lead exposure and on methods they can take to limit their exposure (Kimbrough et al., 1994; Hilts et al., 1998; Schultz et al., 1999). However, EPA does not consider health education, as the only action, to be an effective, permanent remedy for Superfund sites (Appendix B). Often, in-home education activities have been combined with regular house cleaning. One key to begin reduction of elevated blood lead concentrations in children is to initiate health education activities, and where appropriate, blood lead screening, as early as possible in the process. These activities should be started as soon as elevated blood lead levels or elevated soil levels are detected at a site. Education should be sustained throughout the project. If residual contamination, such as encapsulated wastes, LBP, or other such potential sources are left on site after completion of the remedy, then education activities should be sustained in perpetuity.

Generally, EPA does not directly conduct the majority of education activities. One of the responsibilities of the project manager is to educate the community on the risks of lead exposure and to coordinate with various health agencies in establishing lead education programs. These programs are often implemented by local health districts that, in turn, typically coordinate with schools and other community groups working with families and children. Initial tasks include educating the community regarding their lead exposure and associated health risks. Typically, a significant amount of effort will be required to explain the rationale and procedures of the EPA risk assessment method for lead, using the Integrated Exposure Uptake Biokinetic Model (IEUBK), and the need to collect data to estimate site-specific values for model parameters. It is advisable to obtain input on exposure parameters specific to the community (e.g., how often they frequent locations that are not residential). Community input into the risk assessment is not relevant to those parameters that require site-specific studies to generate empirical data (e.g., an animal feeding study to determine bioavailability). Often, local health officials will be unfamiliar with EPA's risk assessment process and will benefit from education along with the general public. The need for community education is heightened by the subtle nature of the low-dose adverse health effects of lead, which cannot be diagnosed in an individual because the scientific basis for cognitive impairments caused by low to moderate exposures relies on carefully controlled comparisons of large numbers of children exhibiting a range of blood lead levels (NRC, 1993; Needleman and Bellinger, 2001). Once the public and local health officials are made aware of the potential risks presented by the site, specific programs, discussed in detail in Section 3 (Health Education), can be implemented. Education and clean-up activities should be easier to implement, more effective, and more widely accepted by the community when the citizens understand the risks and believe that the community is at risk.

Integrated Exposure Uptake Biokinetic Model (IEUBK) – Predicts blood-lead concentrations (PbBs) for an individual child, or group of similarly exposed children (6 months to 7 years old), who are exposed to lead in the environment. More information is available from the Technical Review Workgroup for Lead (TRW) web site:
<http://www.epa.gov/superfund/programs/lead/ieubk.htm>

2.2 COMMUNITY ADVISORY GROUPS

Community Advisory Groups (CAGs) can be invaluable in assuring the success of the project (EPA, 1995b). A supporting and active CAG, comprised of a wide cross section of the community, has been demonstrated on several projects to greatly contribute to the success of meeting the remedial goal. Establishing an open dialogue with the CAG

Community Advisory Group (CAG) – Members of the community make up a CAG, which serves as the focal point for the exchange of information among the local community, EPA, the state regulatory agency, and other pertinent federal agencies involved in cleanup of the Superfund site. Additional information is available online:
<http://www.epa.gov/superfund/tools/cag/index.htm>

and understanding and addressing its concerns, leads to increased satisfaction in the community at the completion of the project. Concurrent with the establishment of health education activities, formation of citizens groups should be encouraged at the very onset of the project. Delay in forming the groups until significant progress has occurred may lead to mistrust by the community, as well as delay or loss of the valuable contributions they can make in assisting EPA.

Citizens groups should be representative of the community. Examples include residents, workers, and business owners from affected neighborhoods, as well as minority leaders, realtors, bankers or lending institution officers, school board members, health officials, elected officials, city public works staff, local environmental group members, and other groups in the community. Additionally, the project manager should coordinate with other federal and state agencies to attend citizen group meetings. Relevant agencies may include the ATSDR, HUD, and state health and environmental departments.

Citizens groups can create a feeling of ownership that facilitates the long-term success of the remedy. They can contribute significantly to education activities in numerous ways. A few examples of the successful programs and activities accomplished by citizens groups at sites include: general education and awareness of the segment of the community they individually represent; creating site-specific education material such as coloring/story books; hosting health fairs; creating health education programs for local school districts; establishing lead poisoning prevention merit badges for girl and boy scout organizations; developing instructional videos; and establishing pre- and post-natal education programs at local hospitals.

2.3 EPA'S TECHNICAL ASSISTANCE GRANT PROGRAM

EPA provides assistance grants to communities to help citizens understand site-related information. By regulation, EPA must inform communities about the availability of Technical Assistance Grants (TAGs) and assist them in applying for these grants (EPA, 1992). EPA also informs citizens about obtaining assistance through other programs such as the university-based Technical Outreach Services for Communities program and the Department of Defense's Technical Assistance for Public Participation (TAPP) program.

Under the TAG program, initial grants of up to \$50,000 are available to qualified groups affected by a response action. Additional funding is available for unusually large or complex sites. A group applying for a TAG need not be incorporated as a non-profit organization at the time it submits its application, but must incorporate as a non-profit organization before EPA can award the grant.

The group must contribute 20 percent of the total project costs to be supported by the TAG grant. This requirement can be met in a number of ways, including with cash, donated supplies, and volunteered services. TAG groups must prepare a budget and work plan for using the funds. There may be only one TAG award per NPL site. If more than one group applies for the same TAG, they are encouraged to form a coalition to apply for the grant.

TAGs are used to hire a technical advisor, who is an independent expert who can review site-related documents, interpret them, and explain technical or health-related information to community members. A TAG advisor will often make site visits to gain a better understanding of the clean-up activities. A technical advisor can also help communicate the community's concerns to EPA. TAG funds may not be used to generate new data (e.g., to conduct additional sampling) or for lawsuits or other legal actions. For further information on TAGs, see the recently revised TAG regulation (EPA, 2000b), which is available from the [EPA TAG web site](#).

2.4 INFORMATIONAL MEETINGS

As important as the health education activities and the establishment of citizens groups are, the project manager should consider holding frequent public meetings to inform the community of current and planned EPA activities and to collect feedback and concerns from citizens. If a CAG has been formed at the site, meetings with the group should be frequent and open to the general public. It is recommended that in the early phases of the project, information sessions should be held at least monthly. Once the community becomes aware of the site risks, current site activities, and becomes relatively involved in the process, the frequency of the meetings can be reduced. However, it is recommended that public informational meetings, separate from the citizens task force meetings, be conducted at least once every six months. This frequency can help ensure that the public stays informed of site progress and has an opportunity to provide meaningful input to the process.

In addition to the meetings pursuant to CERCLA (e.g., prior to release of the Record of Decision) meetings are helpful at the following points in the process: (1) before sampling is conducted, to explain the reason that lead contamination is suspected, how residents can reduce exposure as a safety precaution while awaiting sampling results, and the overall goals of the project (e.g., if the goal of the project is to reduce exposure by remediating only surface soils and therefore the sampling is designed to evaluate only surface soils, the issue of ICs for any contaminated soils remaining at depth should be discussed with the property owners early in the process); (2) after sampling is conducted, to explain results, reiterate how residents can reduce exposure (if results show elevated levels), explain plans and the schedule for conducting remediation, discuss plans for re-landscaping the property, and discuss what sort of ICs may be appropriate; and (3) after remediation is completed, to explain what was done, provide documentation

of the results of the remediation, discuss any problems with the landscaping, and discuss any applicable ICs.

2.5 COMMUNITY INVOLVEMENT SPECIALIST/COORDINATOR

When the site is large and cleanup is expected to last several years, consideration should be given to housing a full time community involvement specialist/coordinator (CIS/CIC) at the site. The roles of the CIS/CIC are (1) to coordinate community involvement activities, and (2) to be readily accessible to the public to provide information and answer questions concerning site activities. The CIS/CIC should be intimately familiar with all activities at the site, as well as the documented health risks, and should maintain an office with business hours convenient to the public. Additionally, the CIS/CIC can use information gained from their constant contact with the local community to brief project staff on issues important to the successful remediation of the site.

Community Involvement Specialist/Coordinator - is the primary point of contact for a community and a Community Advisory Group (CAG), if one was formed for the site. He or she answers questions and provides other assistance directly as well as sees that a CAG's concerns and other issues are transmitted to other Regional Office staff who can help.

3.0 HEALTH EDUCATION

Health education provides information to the public about the risks associated with exposure to contamination and, in turn, how to reduce the exposures. Health education may be considered one of many tools the project manager can use at lead-contaminated sites to reduce exposure to humans.

3.1 APPROPRIATE USES FOR HEALTH EDUCATION

Health education is an informational device and this type of instrument is largely unenforceable. Furthermore, health education has not been demonstrated to be effective over the longer term. Health education may be effective when combined with other measures as an overall remedy for a site. Health education is not a stand-alone remedy. EPA's policy is that health education is only appropriate as a supplemental component of the permanent, health protective remedy selected at a contaminated lead site.

For these reasons, EPA advocates that health education be layered or implemented in series with ICs and engineered remedies. Layering means using different types of ICs and engineered remedies at the same time to enhance the protectiveness of the remedy. Using ICs in series is the use of ICs at different points in the investigation and remediation process to ensure the short- and long-term protection of human health and the environment.

3.2 PLANNING FOR HEALTH EDUCATION

Generally, the specific goals of the health education program should be described in a site-specific decision document. A plan that clearly defines the goals and how they should be achieved is also more likely to succeed. Health education at large lead sites may have a performance period of several years and cost hundreds of thousands of dollars. For these large projects, a clearly defined health education program is even more important.

An early step in any health education planning process includes conducting a community profile and assessing the educational needs of the community. A comprehensive health education program for a typical large lead site would normally attempt to focus on reaching the general public, with special emphasis on schools and other groups involved with young children. Also, it is important to coordinate with city, county, and other local governmental entities. The most important target population, though, is parents, particularly young parents, and parents with a child whose blood lead tested high. Other means of targeted education may include those homes with children that have high dust lead concentrations or lead loadings, which have been shown to be highly predictive of homes where a child is likely to have an elevated blood lead level during the summer peak (EPA, 1996b; von Lindern and Spalinger, 2001).

The response plan should describe what actions and activities are necessary to reach the community-at-large and the targeted groups. It is very important to consider that there are costs associated with the development, implementation, and follow up of health education and that these factors should be thoroughly understood and estimated. Other key points to consider are that the responsibilities for conducting this work should be clear and agreements should be made in writing in the planning stages of site response process.

3.3 EVALUATION OF HEALTH EDUCATION ACTIVITIES

It is important to monitor the effectiveness of health education projects that have been implemented at lead-contaminated sites. Many sites may include health education activities as a major component of the remedy, especially in the early phases of the cleanup. Failure to establish the education part of the remedy may trigger reconsideration and imposition of additional requirements, or more extensive and costly clean-up efforts.

The project manager should monitor the organization(s) performing the educational activities for proper implementation of the health education program and assess the effectiveness of the program. Project managers should ensure that the objectives of the program are being met to protect children's health. If health education is included as part of the final remedy, it should be carefully scrutinized during the Five-Year Review process.

3.4 AGENCY FOR TOXIC SUBSTANCES AND DISEASE REGISTRY (ATSDR) INVOLVEMENT

Health education is often implemented through grants from ATSDR to its partners in state health departments or directly through agreements with local health departments. When health education is specified as a major part of EPA's clean-up activities, strong consideration should be given to establishing an interagency agreement with ATSDR to assist in funding the required activities. ATSDR as a federal health agency is well positioned in terms of health education resources to administer such grants. ATSDR can provide expertise not only with the CAGs but also with public health assessments, health consultations, and health surveillance. An emphasis should be placed on developing the collaborative partnerships between EPA, ATSDR, and other federal, state, and local health departments for health education activities at contaminated lead sites.

Health education at lead sites is often accompanied with blood lead screening. Centers for Disease Control and Prevention (CDC) has issued guidelines for increasing intensity of health intervention activities based on blood lead test results (CDC, 1991). Increased collaboration among the involved

agencies is important to properly implement a health education/blood lead screening project. Additionally, [ATSDR](#) and many state and local health departments have ongoing lead screening and health education programs. Information from targeted screening is valuable for (1) targeting follow-up education to individual families with children identified with elevated blood lead levels; (2) determining the areal and demographic extent of the problem; and (3) effectively evaluating the impact of health education.

3.5 OUTREACH

EPA has had success in health education activities at several sites because the programs were tailored specifically for the site by the site team (i.e., project manager, toxicologist, on-scene coordinator, CIS/CIC, etc.). These programs have included significant amounts of outreach activities in the communities. The success of any health education program generally can be attributed to the amount of community outreach that is conducted at the site. As discussed in Section 2, the outreach can consist of a wide variety of activities. A few examples include the following: site specific coloring books distributed to the parents of young children, scouting merit badges on lead-poisoning prevention, school curriculums developed to inform student of the hazards of lead and good hygiene, health and environmental fairs conducted in the community, and blood lead testing events held at community celebrations. Consultation with local health officials and community groups can provide numerous ideas for outreach, which can be incorporated into specific programs to best meet the needs of the community. Typically, the local health officials should lead the outreach efforts. Funding should be provided by EPA when other funds, such as from ATSDR, are unavailable to support the outreach activities.

4.0 SITE CHARACTERIZATION

EPA has reviewed various sampling designs historically employed at lead-contaminated residential sites and assessed the ability of these sampling designs to meet risk assessment needs and support the development of clean-up levels. Over a 20-year period, several large area lead sites (e.g., Bunker Hill, Shoshone County, Idaho; Joplin, Missouri; NL Industries/Taracorp-Granite City, Illinois; Tar Creek, Ottawa County, Oklahoma) have used a variety of sampling techniques to characterize residential properties. Additionally, many different approaches to applying selected clean-up levels have been taken. As stated, this document was developed to promote consistent procedures, criteria and goals in the investigation and clean-up activities at Superfund lead-contaminated residential sites. However, a level of flexibility is needed to best respond to different site conditions, communities, and uncertainties.

The overall goals of the sampling effort are to estimate an average soil lead concentration for risk assessment purposes and to provide information to determine the scope of any required clean-up actions. This information can also be used for public education and intervention. The sampling designs discussed in this section are intended to provide, within one sampling effort, the necessary data for all phases of a clean-up project so that residents are not inconvenienced by repeated sampling of the same property. Project managers should carefully choose the sampling points needed to estimate the average lead concentration in a cost-effective manner. Some uncertainty is acceptable to reduce the overall cost of sampling at large lead sites. The selection of sample locations within areas with potential for exposure has been the subject of recent articles which describe methods to manage decision uncertainty by balancing sampling and clean-up costs (Englund & Heravi, 1994; Crumbling et al., 2001). Table C-1 (Appendix C) lists contacts within the agency who can provide assistance in various aspects of sample planning and design, and also lists software that may be used for sample planning and decision support.

Section 4.0 discusses: (1) delineating the contamination zones; (2) residential property sampling locations; (3) sampling method; (4) sampling requirements for backfill material and excavated soil for off-site disposal.

4.1 CONTAMINANT ZONE DELINEATION

Historical information on site operations and use is crucial for the design of sampling plans that are intended to delineate contaminant zone(s), and for the interpretation of data generated from the sampling effort. In addition to gathering data on the nature of the source of contamination, information should be gathered to identify areas where soils may have been moved or where fill or topsoil may have been placed. Guidance on how to gather historical site data is available (EPA, 2001f, 2001g). Sites that have been contaminated primarily by airborne-derived lead, such as smelter areas, can initially be sampled in a

grid pattern. This will usually allow concentration contours to be defined across the community and to establish the extent of horizontal contamination for cleanup and costing purposes. If grid sampling is used for initial characterization to define the horizontal extent of contamination, follow-up sampling of each yard located within the identified clean-up zone should be used to characterize each individual property for clean-up requirements. For other sites where the variability is expected to be higher, such as mining sites with discrete individual tailings piles located throughout the area, delineating the contaminant zones by establishing concentration contours will be more uncertain and consideration should be given to sampling every home in the potentially affected area, moving laterally away from the source until clean areas of the community have been identified.

Delineating the zone of contamination generally amounts to distinguishing soil with “background” lead concentration from soil that has been impacted by site-related activities. There are basically two types of background: naturally occurring and anthropogenic (see insert for definitions) (EPA, 1989, 1995c, 2002). EPA guidance defines background for inorganics as “...*the concentration of inorganics found in soils or sediments surrounding a waste site, but which are not influenced by site activities or releases*” (EPA, 1995c). Natural background concentrations of lead vary widely with the local geology, and can be as high as 250 ppm or more in mining areas (SRC, 1999). Local background concentrations, which include natural and non-site-related anthropogenic sources (e.g., historic automobile emissions) can be substantially higher. Background samples should be collected from areas near the site that are not influenced by site contamination, but that have the same basic characteristics (e.g., soil type, land use).

Types of Background

naturally occurring: ambient concentrations of lead present in the environment that have not been influenced by humans

anthropogenic: lead concentrations that are present in the environment due to human-made, non-site sources (e.g., automobile exhaust)

Statistical approaches to delineating contaminant zones are useful for some sites. In these cases, the project manager should consult with a statistician to design an efficient sampling plan. The Agency is developing guidance on characterizing background chemicals in soil that includes statistical methods for delineating contaminated areas (EPA, 2001i). Geostatistics is widely recognized for offering graphical methods that are ideally suited for delineating contaminant zones (Gilbert and Simpson, 1983; Flatman and Yfantis, 1984; Journel, 1984; Englund and Heravi, 1994; Goovaerts, 1997). Geostatistics also provides powerful methods for detecting contaminated areas from background when sample locations have not been randomly selected (e.g., Quimby, 1986; Borgman and Quimby, 1996), for sampling plan design (e.g., Flatman and Yfantis, 1984; Borgman et al., 1996), and for aiding in the design of remedial

responses (e.g., Ryti, 1993). For smaller sites, rigorous statistical analyses may be unnecessary because site-related and non-site-related contamination clearly differ. For these sites, the sampling plan should focus on establishing a reliable representation of the extent (in two or three dimensions) of a contaminated area (EPA, 1989).

4.2 RESIDENTIAL PROPERTIES

For the purposes of this document, a residential property includes properties that contain single and multi-family dwellings, apartment complexes, vacant lots in residential areas, schools, day-care centers, playgrounds, parks, and green ways (EPA, 1996a, 1997a). In all cases, historical site information (type of lead site, fill activities, previous epidemiological studies, etc.) is important in the application of this Handbook.

Rationale for collecting yard soil samples and water samples on a residential property is provided in Table 4-1. The collection of other types of media are important to determine overall risk, however CERCLA has limited authority to address these media (e.g., interior paint, dust, and potable water).

4.2.1 Sampling Access

Prior to conducting any sampling or clean-up activities at a residential property, access must be obtained from the property owner; access obtained from tenants or renters is not sufficient. It is essential to begin access procurement as early as possible in the remedial process to avoid potentially lengthy delays. It is recommended that access be obtained by going door-to-door. If residents are not home, a blank access agreement with instructions for signature and submission to EPA, along with relevant contact information should be left at the residence (but not in the mailbox). Examples of access agreements are presented in Appendix D, pages D-2 and D-3. If possible, access for remediation should be obtained at the same time access for sampling is sought. Examples of combined sampling/remediation access agreements are included on pages D-4 and D-5 of Appendix D. Combining sampling and clean-up access will avoid potentially lengthy delays. Additionally, access should be obtained for any interior dust sampling and/or cleaning that will be performed at the residence (Section 6.6.2). Sample access agreements for dust cleanup are presented in Appendix E.

**Table 4-1.
Rationale for Sampling Residential Properties**

Sample Location	Rationale for Sample Collection
Residential yard soils	Residential soil may present a direct exposure pathway to persons working, playing, or conducting other recreational activities on the property. Soil samples should be collected and quantitatively analyzed to estimate lead concentrations. Residential soils may also present an indirect exposure pathway via house dust exposure (see below).
Gravel driveways	Fine-grained driveway material may present a direct exposure pathway to persons working or engaged in recreational activities on driveways. Soil samples should be collected and quantitatively analyzed to estimate lead concentrations. Gravel driveways with elevated soil concentrations may also contribute to the transport of contaminants throughout the community.
Drip zones and soils below roof gutter downspouts	Rooftops may collect fine-grained sediments that contain high concentrations of lead. In yard areas where downspouts discharge during a storm event, the fine-grained material washed from a roof may accumulate and result in a localized increase in soil lead concentrations. Soil samples should be collected and quantitatively analyzed to estimate lead concentrations. Drip zone areas may also contain LBP influences and are important to characterize for health intervention purposes, as drip zones are often used as play areas.
Soils in play areas	Play area soils may present a direct exposure pathway to children under the age of seven. Soil samples should be collected and quantitatively analyzed to estimate lead concentrations.
Garden soils	Garden soils may present a direct exposure pathway to persons who actively maintain a garden. Soil samples should be collected and quantitatively analyzed to estimate lead concentrations.
Interior lead dust	Lead in household dust may be a significant contributor to elevated blood lead levels, especially in younger children. Dust samples should be collected and quantitatively analyzed to estimate lead concentrations. Lead-contaminated interior dust can be derived from multiple sources; dust mat samples and speciation can be used to identify lead sources.
Lead-based paint	Deteriorating LBP may contribute lead to household dust, which can be a significant source of lead exposure, particularly for young children. If elevated concentrations of lead are found in interior dust, samples of interior paint should be collected and quantitatively analyzed to estimate lead concentrations. Exterior LBP may contribute to the recontamination of remediated properties. Samples of exterior LBP should be collected and quantitatively analyzed to estimate lead concentrations.
First run and purged tap water	Groundwater and surface water near the site may contain elevated lead concentrations. Some residences located within the site may use local groundwater or nearby surface water as a source of drinking, cooking, bathing, or irrigation water. The water may represent a direct exposure or ingestion pathway. Samples of both water standing in the pipes (first run sample) and water discharged after the system has been flushed (purged sample) should be collected and quantitatively analyzed to estimate lead concentrations. These results can also be used to help determine if the drinking water is contaminated with site-related contamination (exceedance in purged), or to determine if there is lead in the home's plumbing (exceedance in first run), or both, which may be used for remediation or intervention purposes, respectively.
Crawl Spaces	Crawl space sampling is recommended if the crawl space is accessible to children or pets. At some sites (e.g., Bunker Hill) this has been found to be a significant pathway (IDHW, 2000; TerraGraphics, 2000). Even when spaces are too small for children, pets have been found to access these spaces and move significant amounts of fine dust containing elevated lead levels into the child's bedroom (e.g., where a pet may sleep on the child's bed at night). Information on concentrations of lead beneath the structure may be used to document the need to preclude access or take other remedial measures.
Other areas	During field work, other potential sources of lead contamination may be identified. If the sources appear to represent a potential exposure pathway to occupants of a residence, sampling may be recommended. Other areas should be evaluated on a case-by-case basis and could include sediment, surface water, or secondary play areas. If deemed appropriate, samples should be collected and quantitatively analyzed to estimate lead concentrations.

4.2.2 Residential Yards

It is recommended that when sampling residential lots with a total surface area less than 5,000 square feet (a typical urban lot size), five-point composite samples should, at a minimum, be collected from each of the following locations: the front yard, the back yard, and the side yard (if the size of the latter is substantial). The front, back, and side (if needed) yard composites should be equally spaced within the respective portion of the yard, and should be outside of the drip zone and away from influences of any other painted surfaces (Figures 4-1a and 4-1b). Composites should consist of aliquots collected from the same depth interval.

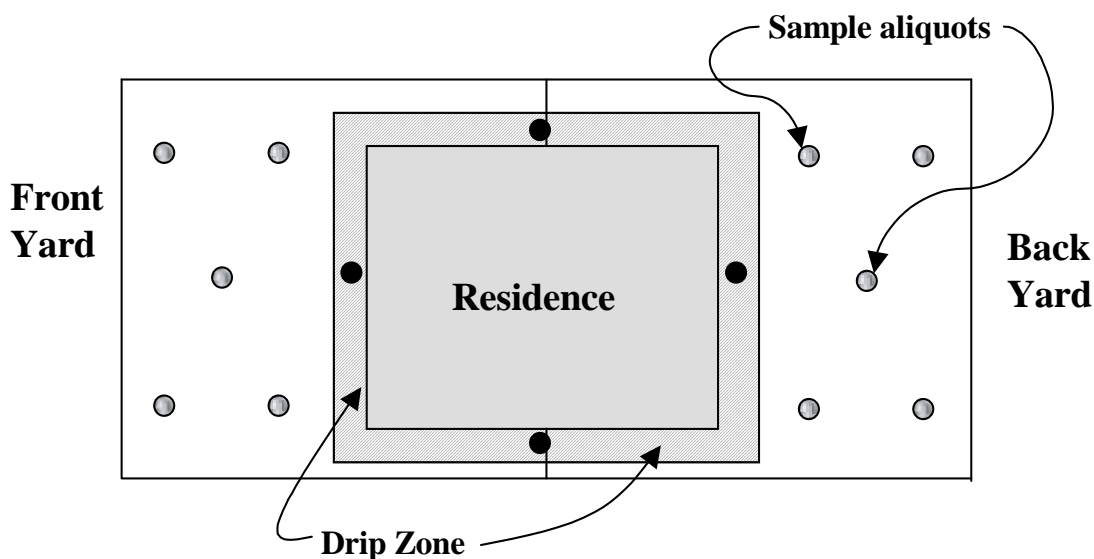

Figure 4-1a. Recommended minimum soil sampling in yards less than or equal to 5,000 square feet with small side yard. Five point composite samples should be collected from each of the front and back yards. Four point composites should be collected from the drip zone; each aliquot should generally be collected from the midpoint along each side of the residence. Aliquots for a single composite sample should be collected from the same depth interval. Soil samples should also be collected from distinct play areas and gardens if they are present, as well as unpaved driveways and minimal use areas such as areas under porches and crawl spaces. The locations of the aliquots should be equally spaced within the area of the yard the composite is collected from. The figure illustrates one possible arrangement of the sample aliquots. Please refer to Section 4.2.2 for further explanation.

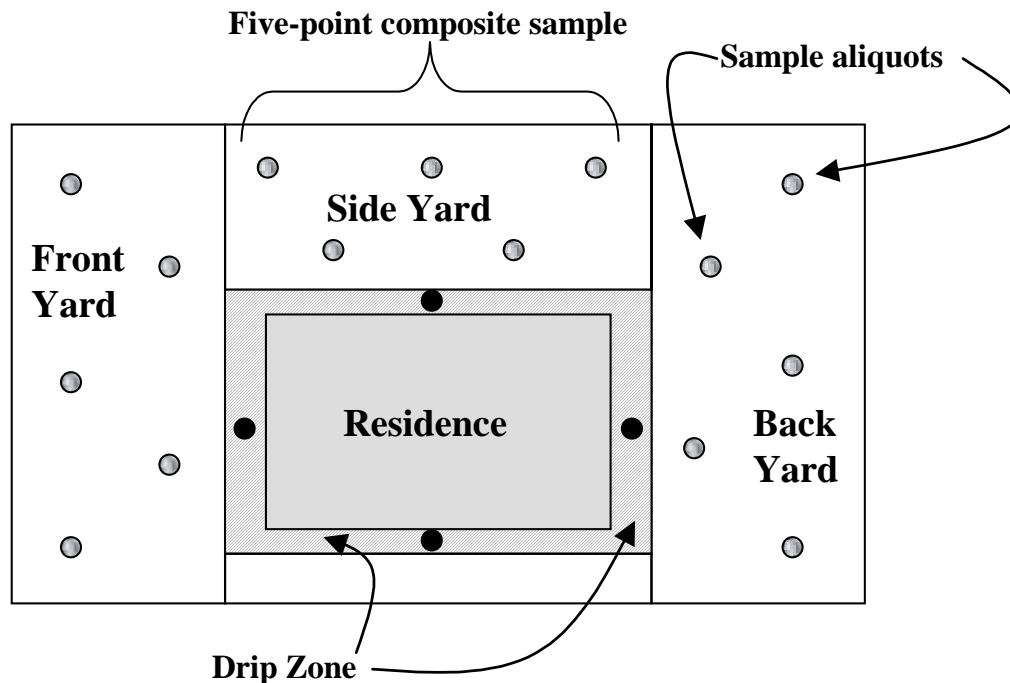

Figure 4-1b. Recommended minimum soil sampling in yards less than or equal to 5,000 square feet with substantial side yard. Five point composite samples should be collected from each of the front, back, and side yards, along with other areas as described in Figure 4-1a. The locations of the aliquots should be equally spaced within the area of the yard the composite is collected from. The figure illustrates one possible arrangement of the sample aliquots. Aliquots for a single composite sample should be collected from the same depth interval. Please refer to Section 4.2.2 for further explanation.

For residential lots with a total surface area greater than 5,000 square feet, it is advisable that the property be divided into four quadrants of roughly equal surface area. The two quadrants in the front yard should encompass one half of the side yard; likewise for the two quadrants in the back yard. One five-point composite of aliquots collected at equal spacing and from the same depth interval should be obtained from each quadrant. Each aliquot should be collected away from influences of the drip zone and any other painted surfaces (Figure 4-2).

Properties over one acre in size should be divided into 1/4 acre sections. One five-point composite sample should be collected from each section. For large properties, consideration should be given to whether elevated concentrations trigger partial removal of soils or access restriction (see Section 6.5).

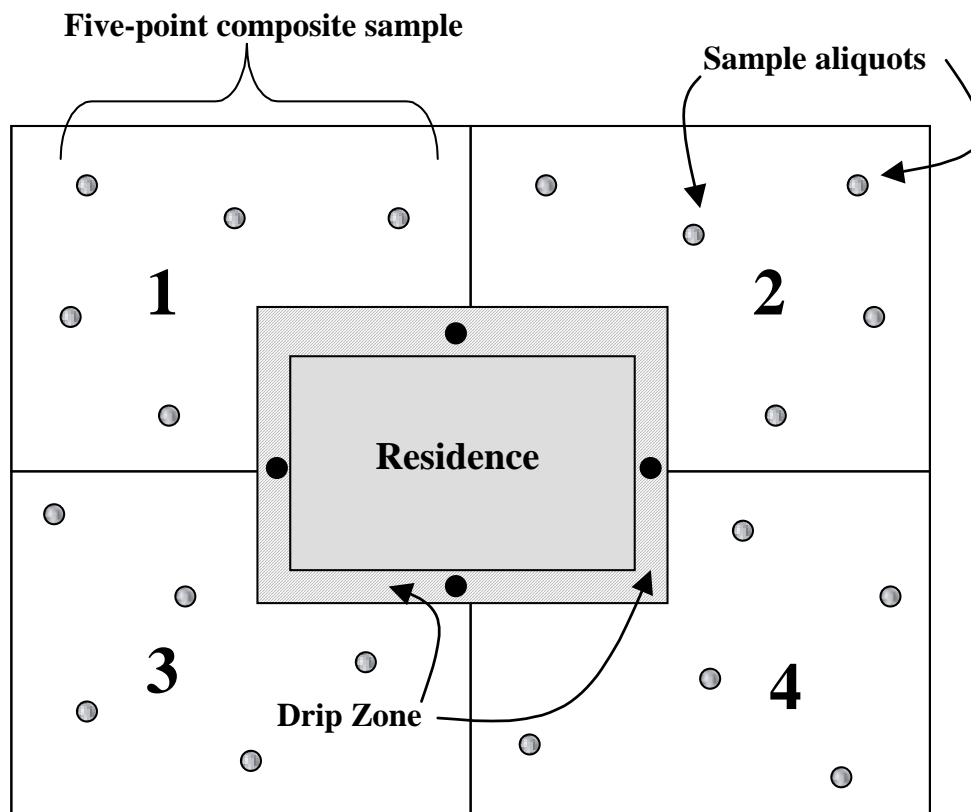

Figure 4-2. Recommended minimum soil sampling in yards greater than 5,000 square feet. Five point composite samples should be collected from each of the four quadrants as indicated above. The locations of the aliquots should be equally spaced within each of the quadrants. The figure illustrates one possible arrangement of the sample aliquots. Four point composites should be collected from the drip zone; each aliquot should generally be collected from the midpoint along each side of the residence. Aliquots for a single composite sample should be collected from the same depth interval. Additional samples should be collected from distinct play areas and gardens if they are present, as well as unpaved driveways and minimal use areas such as areas under porches and crawl spaces. Please refer to Section 4.2.2 for further explanation.

4.2.3 Drip Zones

Lead-contaminated soils are frequently found within the drip zone of houses. It is recommended that a four-point composite sample be collected from the drip zone of each residential property (Figures 4-1a, 4-1b, and 4-2). The composite sample (taken from any size lot) should consist of a minimum of four aliquots collected between 6 and 30 inches from the exterior walls of the house. Each aliquot should generally be collected from the midpoint of each side of the house. Collection of additional aliquots should be considered if other factors exist, such as bare spots, distinct differences in the house exterior, and areas where runoff collects. Rooftops may collect fine-grained sediments that contain high concentrations of lead. In yard areas where downspouts discharge during a storm event, the fine-grained material washed from a roof may accumulate and result in a localized increase in soil lead

concentrations. Samples of the soil from the downspout discharge area should also be sampled if present.

4.2.4 Play Areas, Gardens, and Driveways

Distinct play areas and gardens, if present, should generally be sampled separately as discrete areas of the yard. At some sites, collection of a right-of-way/easement composite may also be appropriate, such as residential areas with unpaved streets and alleys. Paved surfaces such as asphalt/concrete driveways, patios, alleys, and parking lots should, in most cases, not be sampled. Samples should also be collected in other locations depending upon the potential for exposure or recontamination, for example, under porches and crawl spaces and areas with incomplete barriers such as gravel driveways.

4.2.5 Potable Water, Lead-Based Paint and Interior Dust

Drinking water supply samples should be collected to determine if exposure to lead in drinking water is occurring. First-run and purged samples of potable water should be collected to differentiate site-related sources of lead from lead derived from plumbing that is located within the residence. CERCLA authority for remedial action may be limited with regard to lead derived from plumbing that is located within the residence.

Deteriorating LBP may contribute lead to household dust. If elevated concentrations of lead are found in interior dust, samples of interior paint should be collected. Exterior LBP may contribute to the recontamination of remediated properties (Section 6.7). Samples of exterior LBP should be collected and analyzed to estimate lead concentrations. Lead in household dust may be a significant contributor to elevated blood lead levels, especially in younger children. Lead-contaminated interior dust can be derived from multiple sources; dust mat samples and speciation can be used to identify lead sources. Dust samples should be collected and analyzed to estimate its potential contribution to lead exposure. Guidance on LBP and dust sampling is available from HUD (HUD, 1995).

4.2.6 Backfill and Waste Soil

Backfill soil should be sampled to ensure that uncontaminated material is being placed on the site. The list of analytes and the frequency of sampling should be based on site-specific factors including the location of the source for the backfill material relative to potential sources of contamination, the geology of the borrow area, and the heterogeneity of the material. For example, on the Bunker Hill Superfund Site, four-point composite samples were collected for each 200 yd³ of soil (TerraGraphics, 1997a). Gravel for driveway backfill was also sampled every 200 yd³ (TerraGraphics, 1997b). Samples of excavated soil should be analyzed by the toxicity characteristic leaching procedure ([TCLP method](#)) to

determine the appropriate method of disposal. The frequency required for TCLP sampling should be based on the heterogeneity of the lead and other contaminant(s), if any, on the site.

4.3 SAMPLING METHOD AND ANALYSIS

4.3.1 Sample Collection

Composite samples should consist of discrete aliquots of equal amounts of soil. The soil from each aliquot should be collected into one clean container, such as a stainless steel bowl or plastic bag, and thoroughly mixed. After mixing, the sample can then be analyzed by X-Ray Fluorescence (XRF) (see Section 4.3.4) or sent to the laboratory. Remaining sample volume can then be disposed in the general location from where it was collected, or archived, depending on the requirements of the project. In some cases, material other than grass and/or soil will be encountered at a sample location, e.g., wood chips and sand are often found in recreational areas of day-care and school playgrounds. Samples of the soil below the cover material should be collected.

The use of a dynamic sampling and analysis strategy should be considered (EPA, 2001d). A dynamic sampling and analysis strategy takes full advantage of the real-time that data field analytical methods provide, which can limit the sampling effort and minimize cost (EPA, 2001d). This document suggests the use of field portable X-Ray Fluorescence (FP-XRF) analysis.

4.3.2 Sample Depth

The following sampling design is based on the assumption that removal of surficial contaminated soils and placement of a cover of clean soil will be protective of human health and the environment (see Section 4.0). Furthermore, the sampling design outlined below is based on the assumption that a minimum of 12 inch soil cover is adequate.

Initial sampling for lead contamination in residential soils should be conducted to a depth of at least 18 inches, but does not need to exceed 24 inches to define the vertical extent of contamination for clean-up purposes. Composite samples should be collected at 6 inch depth intervals, i.e., 0–6 inches, 6–12 inches, 12–18 inches, and 18–24 inches. Additional sampling may be required at lead sites in cold weather regions when contamination is associated with coarse grained material. Stone-sized material, such as tailings and crushed battery casings, will, over time, migrate upward through the soil via freeze/thaw effects. At such sites, composite sampling should be conducted at 6 inch intervals to the approximate maximum frost depth for the region. In all cases, composites should consist of aliquots collected from the same depth interval.

In site-specific situations, deeper sampling may be conducted to determine the total vertical extent of contamination for groundwater issues or ICs, and to determine if complete removal of contaminated soil is possible. Depth sampling should be conducted until the vertical extent of contamination has been adequately defined, but does not need to be conducted on every property.

In addition to the composite samples collected to define the vertical extent of contamination, five-point composite surface soil samples should be collected from 0 to 1 inch for human health risk assessment purposes (EPA, 1989, 1996c). The samples should be collected using the procedure described in Section 4.3.1. These surface soil samples should be collected from every property within the identified zone of contamination; however, after collecting a statistically valid number of both 0–1" and 1–6" samples, the project manager may want to compare both sample horizons (e.g., paired-sample t-test; Wilcoxon Rank Sum test) (Gilbert, 1987; Snedecor and Cochran, 1989) to determine if the 0–1" depth can be eliminated (i.e., sample from 0–6"), to further decrease sampling costs. This may be particularly useful at mine waste sites where contamination often extends to depth or at sites where lead-contaminated soil has been used as fill material; in such cases, the lead concentration may increase with depth. Conversely, the 0–1" horizon may be far more contaminated than the 1–6" at smelter sites, making individual horizon sampling crucial to remedial decision-making.

Collection of samples from specified depth intervals serves two primary purposes: risk assessment and remedial decision-making. With respect to risk assessment, the top inch of soil best represents current exposure to contaminants (EPA, 1989, 1996c) and is the source of data used in the IEUBK model to represent exposure from soil. The various depth intervals are used in remedial decision-making to determine if a residential yard requires cleanup by evaluating if any of the horizons exceed the site-specific action level. The lower soil horizons represent possible future exposures, such as homeowner projects, children's play areas, and other home activities that periodically go beneath the top inch of vegetation/soil (EPA, 1989). All soil horizons should be used for clean-up decision-making. The 6 inch depth intervals recommended in this document are based on the performance that may be reasonably expected of operators of small equipment working in relatively small spaces around homes. Specifically, a "bobcat" is most efficiently used for soil removal on a property if the soil is removed in 6 inch intervals, rather than in smaller increments, which would be far more difficult to achieve in a consistent or cost-effective manner. This approach has been developed to ensure a residential yard is cleaned up if it poses an immediate or long-term risk to human health in a manner that relates the sampling methodology closely to reasonable and cost-effective construction equipment performance.

A secondary goal of the sample collection effort is to facilitate the implementation of ICs for sites where contamination at depth is left in place.

4.3.3 Sample Preparation

Residential soil lead samples should represent the exposure potential of young children who are most vulnerable to adverse effects of exposure. Children inadvertently ingest lead in soil and dust that adheres to their hands (Succop et al., 1998). The smaller particles are more representative of this type of exposure (Duggan et al., 1985; Kissel et al., 1996; Mielke et al., 1997). Additionally, smaller particles are preferentially brought into the home. Sieving is conducted to better represent the soil fraction that is ingested by the typical child. Sieving has also been used in soil ingestion and bioavailability studies (Calabrese et al., 1996; Casteel et al., 1997; Stanek et al., 1999). Samples collected from all depth intervals should be sieved. Samples should not be ground prior to sieving, as this changes the physical structure of the soil and may bias the analytical results. To reduce sampling costs, it may be desirable to develop a correlation between sieved and unsieved data, to eliminate the need to sieve all samples. The correlation can be used to predict sieved results from unsieved samples. The EPA Technical Review Workgroup (TRW) and American Society for Testing and Materials (ASTM) have issued guidance on sieving (ASTM, 1998; EPA, 2000c). The EPA TRW guidance addresses appropriate sieve size (No. 60) and a method for predicting the concentration in the fine fraction using concentrations measured in unsieved samples.

[Technical Review Workgroup \(TRW\)](#) – The TRW is an interoffice workgroup that consists of key scientific experts from various EPA regions, labs, and headquarters that supports and promotes consistent application of the best science in the field of lead (Pb) risk assessment at contaminated sites nationwide.

The presence of paint chips in a soil sample can represent a large proportion of the total lead concentration that is measured. On this issue, the Handbook directs the reader to existing HUD guidance, which states “If paint chips are present in the soil, they should be included as part of the sample. However, there should be no special attempt to over-sample paint chips. The laboratory should be instructed to disaggregate (‘break up’) paint chips by forcing them through a sieve in the laboratory. Although paint chips should not be oversampled, they should not be excluded from the soil sample, since they are part of the soil matrix.” (HUD, 1995). The TRW website should be checked periodically for additional sampling guidance.

4.3.4 Sample Analysis

EPA’s experience in sample analyses at large residential contamination sites (with several thousand homes on a site) shows that both FP-XRF or fixed-site laboratory analyses (acid digestion/Inductively Coupled Spectroscopy) provide reliable information (EPA, 1996d, 1998b, 2001c, 2001d; Crumbling et al., 2001). The objective of using a FP-XRF is to predict Contract Laboratory Program (CLP) values with

less expensive real-time data. A sufficient amount of data should be collected to develop a site-specific relationship (i.e., correlation) between FP-XRF and CLP lab data.

The comparison should consider sample preparation (drying and sieving) and analytical methods. Typically, a large number of laboratory confirmation samples should be analyzed at the beginning of the project to estimate the correlation between the FP-XRF and the CLP results and the FP-XRF precision and accuracy. Additional confirmatory samples should then be analyzed at key decision points when the FP-XRF results are close to action levels or when the reliability of the FP-XRF unit is in question (EPA, 2001d). For example, initial sample analyses using an FP-XRF instrument could include 20 percent laboratory confirmatory samples to assess the accuracy and precision of the FP-XRF. Once the accuracy and precision of the FP-XRF results have been determined (and assuming they satisfy the requirements of the project), the number of laboratory confirmatory samples could be reduced (e.g., to 5 percent). Additional information on analyzing soil (and other media) in the field with FP-XRF is available on the EPA web site: <http://www.epa.gov/superfund/programs/dfa/> (EPA, 2001e).

Proper calibration of the FP-XRF unit is important to obtaining reliable results (EPA, 1996d). Correlation between the FP-XRF and laboratory analyses is best achieved with small sample volume. Laboratory confirmatory samples should be collected in the specimen cup available from the FP-XRF manufacturer. The sample is first analyzed with the FP-XRF and then sent to the laboratory for wet chemistry analysis. Soil moisture can introduce error in FP-XRF results to varying degrees, depending on the instrument being used (EPA, 1996d). The correlation between the FP-XRF measurements on dried and undried samples should be estimated. The correlation analysis should then be used to establish a cutoff or 'soil moisture ceiling'. The 'soil moisture ceiling' represents the maximum moisture content at which useful results (i.e., of sufficient precision and accuracy) can be obtained with the FP-XRF. Field portable instruments capable of measuring moisture content are available and should be used to compare sample moisture content to the 'soil moisture ceiling'. Samples with moisture contents greater than the 'soil moisture ceiling' should be dried prior to analysis with the FP-XRF.

5.0 CLEAN-UP LEVEL SELECTION

Generally, the approach to human health risk assessment for lead differs from that of other metals and contaminants. Typically, risks from lead exposures are estimated from long-term exposures, although elevated blood lead concentrations also result from short-term exposures (CDC, 1991). EPA has developed the IEUBK model to predict blood lead (PbB) concentrations in children exposed to lead. The model considers several different media through which children can be exposed to lead.

EPA and the CDC have determined that childhood PbB concentrations at or above 10 micrograms of lead per deciliter of blood (: g Pb/dL) present risks to children's health (CDC, 1991). Accordingly, EPA seeks to limit the risk that children will have Pb concentrations above 10 : g Pb/dL. The IEUBK model predicts the geometric mean PbB for a child exposed to lead in various media (or a group of similarly exposed children). The model also calculates the probability that the child's PbB exceeds 10 : g Pb/dL (P_{10}). Preliminary remediation goals (PRGs) generally are determined with the model by adjusting the soil concentration term until the P_{10} is below 5%. Final clean-up level selection for Superfund sites generally is based on the IEUBK model results and the nine criteria analysis per the National Contingency Plan (NCP) (EPA, 1990b), which includes an analysis of ARARs. More information on the IEUBK model is available from the [EPA TRW web site](#).

Typically at large lead sites, early actions taken to mitigate the identified site risks consist of time-critical removal actions (TCRAs), most often taken as an interim action. These actions are usually followed by long-term remedial actions. The following sections describe the different approaches that should be used for prioritizing response actions and selecting clean-up levels for both early (interim) and long-term (permanent) response actions.

5.1 PRIORITIZING RESPONSE ACTIONS

For early, interim actions, a tiered approach should be used for prioritizing clean-up actions. A tiered-response approach is recommended when sufficient resources are not available to fully address lead risks. The size and complexity of many lead sites often requires implementation of response actions over an extended period of time; therefore, it is often necessary to implement interim clean-up actions to manage short-term health risk concerns while response actions to address long-term risk are planned and implemented. Early removal actions at residential lead sites should contribute to the performance of the long-term permanent remedy.

The tiered approach is depicted in Figure 5-1. Figure 5-1 is a flowchart that provides a roadmap of the recommended clean-up process for lead-contaminated residential sites. An overview to the clean-up process is provided in Figure 1-1. The first page of Figure 5-1 provides a more detailed overview; the subsequent pages provide additional details of the process.

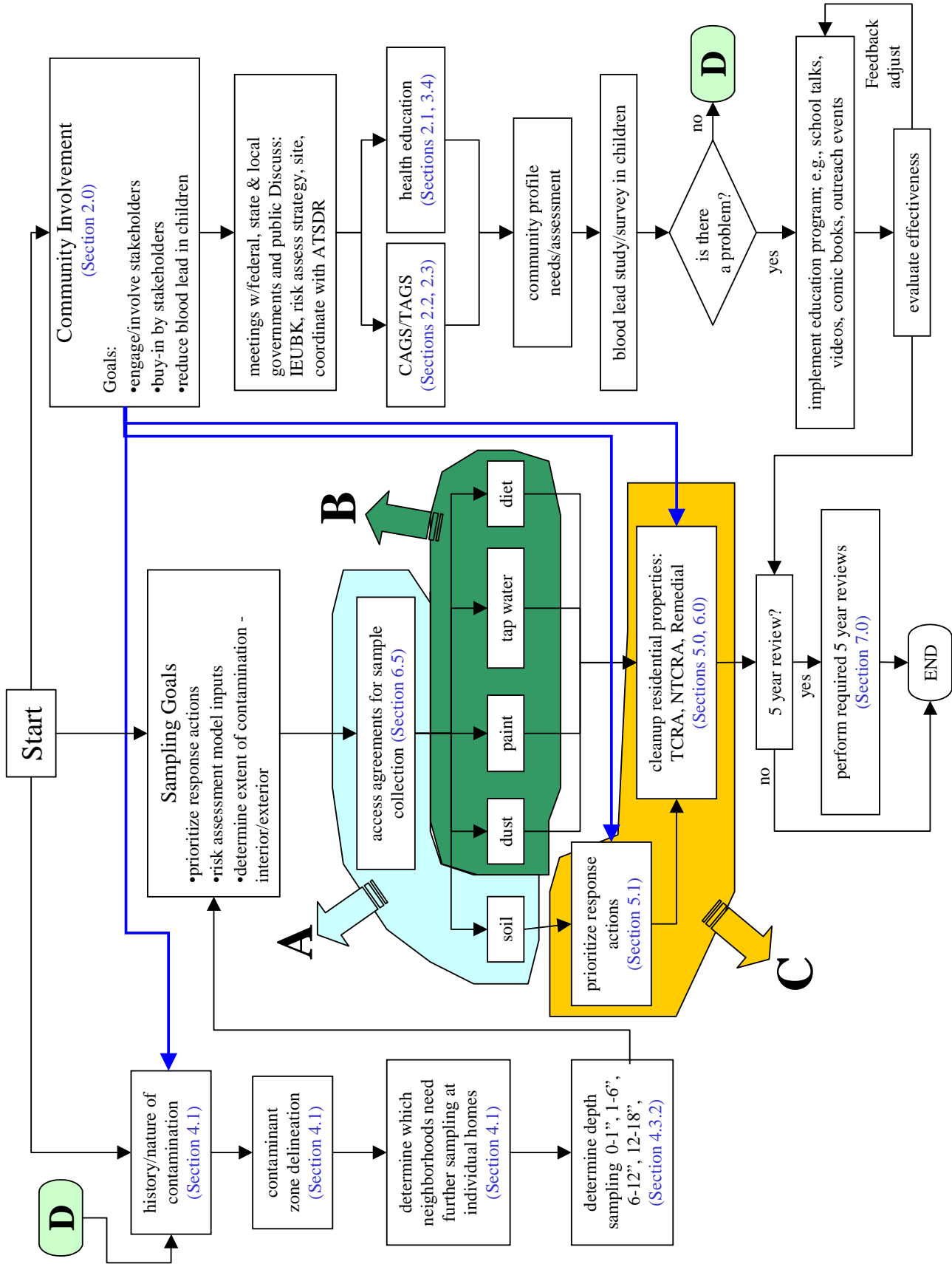

Figure 5-1. Recommended clean-up process for lead-contaminated residential sites. Refer to Figure 1-1 for an overview of the process. The shaded portions of the figure, labeled A-C, are expanded on the second through the fourth pages of the flowchart.

Figure 5-1. (continued)

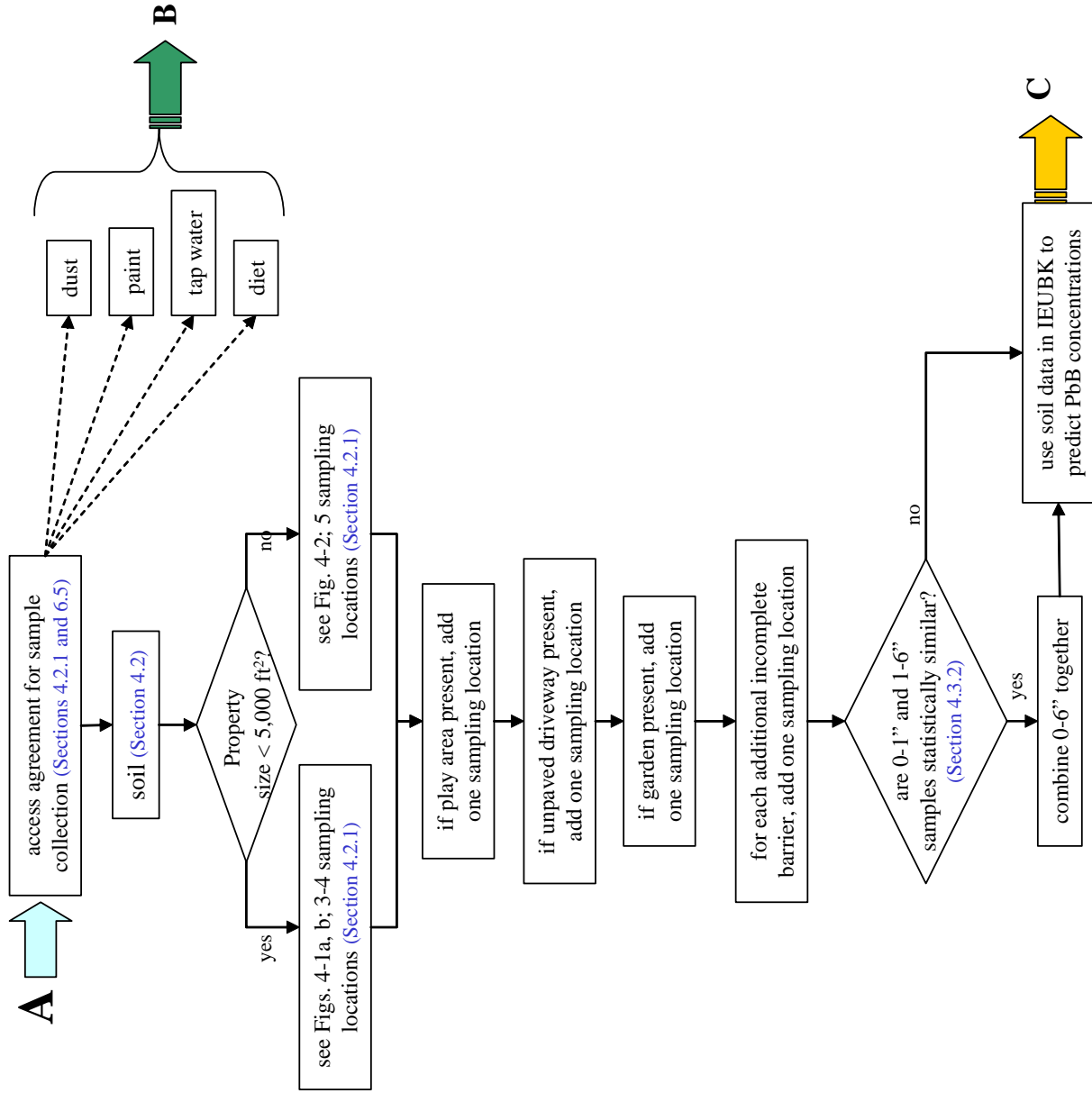

Figure 5-1. (continued)

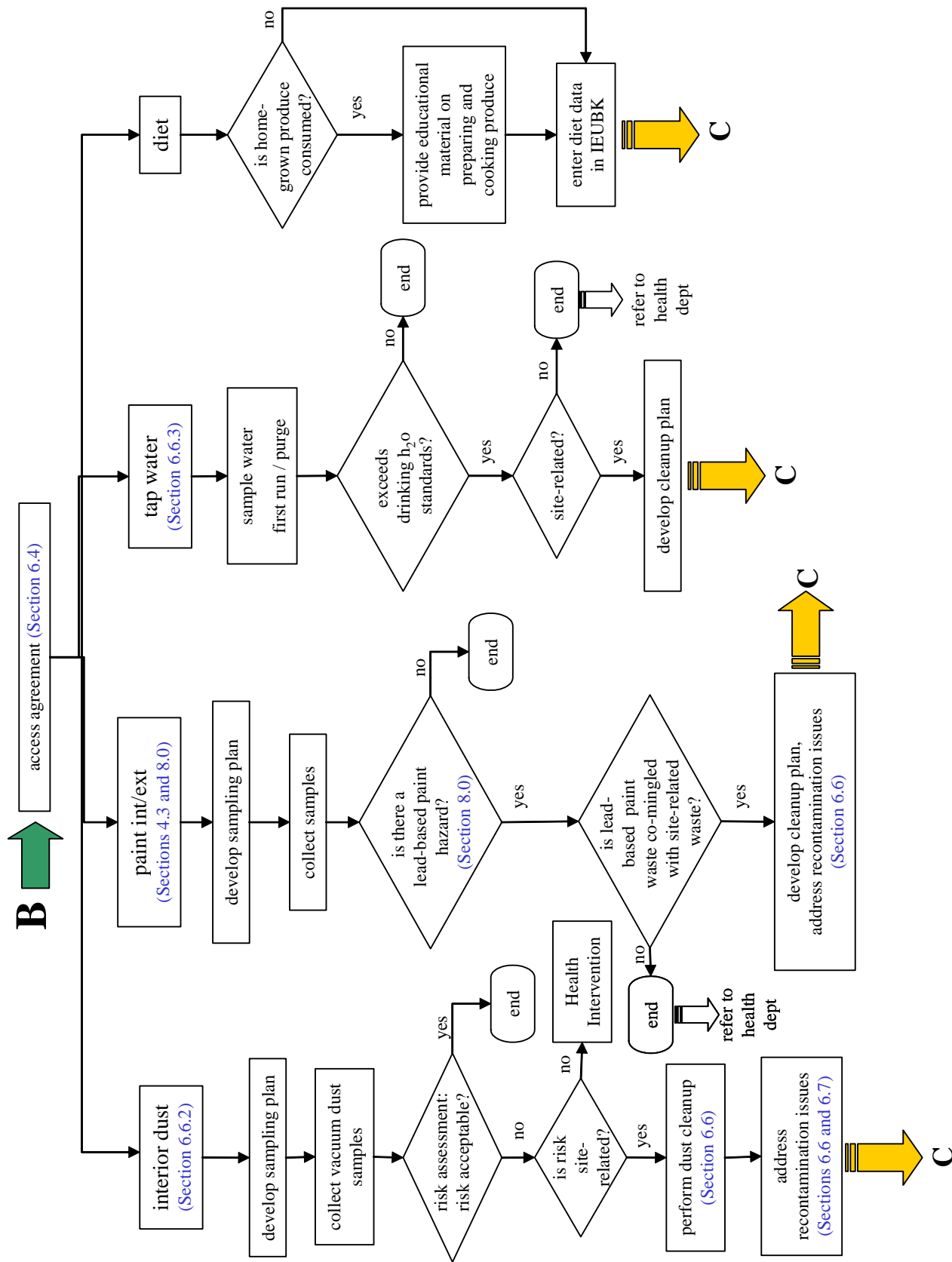
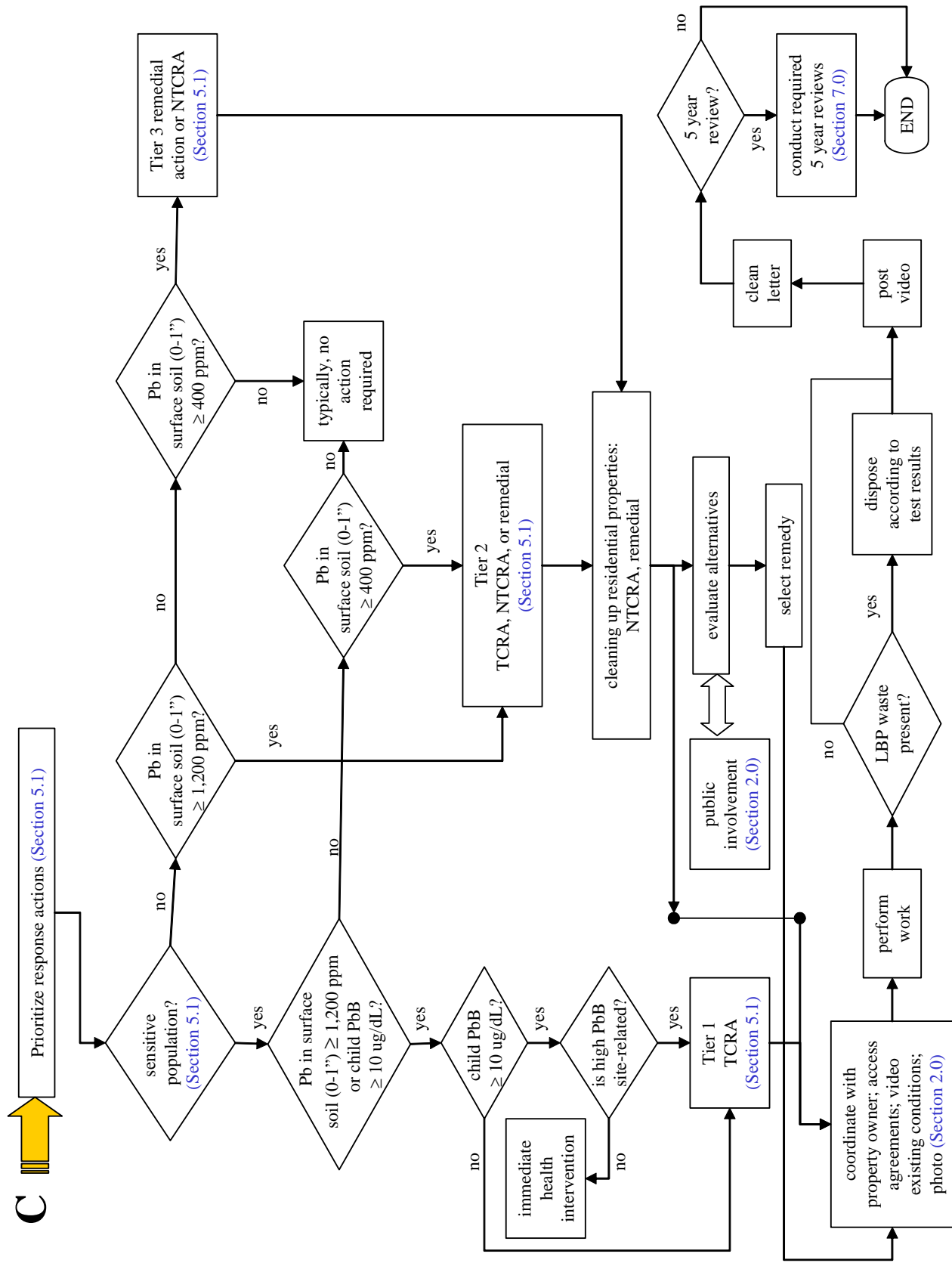

Figure 5-1. (continued)



The concentrations that are used to define tiers should not be confused with clean-up numbers, which are based on the PRG determined with the IEUBK model and an analysis that includes the nine criteria listed in the NCP (EPA, 1990b). The 1,200 ppm concentration is not an action level for TCRA's, but is intended to provide an alternative to running the IEUBK model if the project manager believes the site poses an urgent threat (EPA, 1997b, 1997c). Certainly, a TCRA could be justified above or below this concentration depending on the conditions at the site. The tiers, for the purposes of this guidance, are defined below (see also Figure 5-1). (Please note the Agency is considering developing new guidance for removal actions.)

- C Tier 1 properties have both sensitive populations (children up to 7 years old or pregnant women) and soil concentrations in the surface soils (0–1" depth) at or above 1,200 ppm (EPA, 1997b, 1997c). Also, Tier 1 sites can be identified based upon a demonstration of children's blood lead levels at or above 10 µg/dL. Generally, TCRA's would be taken at Tier 1 properties.

- C Tier 2 properties have either sensitive populations and soil lead concentrations in surface soils between 400 ppm and 1,200 ppm, or no sensitive populations and surface soil lead concentrations above 1,200 ppm, but not both. Tier 2 properties can be addressed through TCRA's, or non-time-critical removal actions (NTCRA's), or long-term remedial actions.

- C Tier 3 properties have surface soil concentrations below 1,200 ppm, but above 400 ppm, and no sensitive populations present. Tier 3 sites would typically be addressed through long-term remedial actions or NTCRA's.

Tier 1 should be the highest priority for immediate action and Tier 3 should be the lowest priority for immediate action. Residential properties can move into a different tier if conditions change (e.g., small children or pregnant women move into a house). A typical residential lead site will contain a combination of properties that fit into different tiers. The project manager should use judgement to determine whether or not to perform a complete cleanup of contaminated residential properties (as defined in Section 1.3).

As discussed below, remedial actions for residential lead sites should use the IEUBK model. The IEUBK model should be used to assess risks posed by contaminated soils and to determine PRGs for soils at residential lead sites. In order to facilitate TCRA's, a demonstration of elevated blood lead levels or elevated soil-lead levels at or above 1,200 ppm will usually be sufficient. If elevated blood lead levels are the basis for concern, occupational contributions of lead, elevated lead levels in drinking water, lead from LBP, and lead dust in the homes of children or adults with elevated blood lead should be investigated first because these sources of lead can be significant (Appendix B). At this stage, consultation with Regional

risk assessors and public health officials (such as ATSDR) to better understand health impacts is encouraged.

The Agency plans on publishing a future lead removal directive which includes further information on site-tier approaches.

5.2 LONG-TERM REMEDIAL ACTION

The [1994 Office of Solid Waste and Emergency Response \(OSWER\) Directive 9355.4-12](#) states OSWER's risk reduction goal for residential lead sites: "... generally, OSWER will attempt to limit exposure to soil lead levels such that a typical (or hypothetical) child or group of similarly exposed children would have an estimated risk of no more than 5% exceeding the 10 : g lead/dL blood lead level." ($P_{10}<5\%$) (EPA, 1994b). It is important to note that this recommendation (i.e., $P_{10}<5\%$) is meant to apply to a single residential property or another discrete exposure area, not on an area- or community-wide basis (i.e., 5 children out of every 100 actually exceed 10 : g/dL). It is also important to note that selecting a soil lead concentration in this manner will not guarantee that a given child will not exceed a blood lead level of 10 : g/dL. Many factors other than soil concentration cause variance in blood lead levels: pica behavior, or other sources of lead not included in the exposure unit, such as paint, diet, etc. (e.g., this could include soil at a camping site or other remote site frequented by the child).

The [1998 OSWER Directive 9200.4-27P](#) ('Clarification') (EPA, 1998a) recommends that the IEUBK Model be used as the primary tool to generate risk-based soil clean-up levels at lead sites for current and future residential use (Appendix B). Additionally, the 1998 Clarification states that response actions can be taken using IEUBK predictions alone, and that blood lead studies, while providing useful information, should not be used for establishing long-term remedial or non-time-critical removal clean-up levels at lead sites. Regarding exposure units at residential lead sites, the 1998 Clarification states: "... it is recommended that risk assessments conducted at lead-contaminated residential sites use the individual residence as the primary exposure unit of concern" (EPA, 1998a; Appendix B). This document clarifies the definition of exposure unit provided in the 1998 Clarification. In addition to the individual residence, accessible site-related lead sources outside the residential setting should also be evaluated to understand how these other potential exposures contribute to the overall risk to children. When the evaluation indicates a significant contribution to risk, clean-up measures should be determined for those areas.

Empirical blood lead data occasionally deviates significantly from IEUBK Model predictions. This can be due to numerous factors, including the implementation of lead exposure-reduction and health education programs, and uncertainties in the exposure parameters of the Model as well as uncertainties in the blood lead data (Mushak, 1998). Regarding this issue, the 1998 Clarification states: "Where actual

blood lead data varies significantly from IEUBK Model predictions, the model parameters should not automatically be changed. In such a case, the issue should be raised to the TRW to further identify the source of those differences” (Appendix B). Basically, model inputs should be changed only when defensible, site-specific information that is specifically applicable to the parameters is collected. Moreover, these changes should also ensure that model outputs are protective of future residents. Examples of such information are dust lead concentration, drinking water concentration, bioavailability data (e.g., *in vivo* pig studies), and soil-to-dust ratio. The predictive capacity of the IEUBK Model depends upon the representativeness of the inputs. Section 4 discusses the collection of the data used to estimate some of these inputs.

In summary, there is no national clean-up standard for lead in residential soil on a Superfund site; however, there is a consistent process by which residential soil lead clean-up levels are selected. One step is to gather site-specific data as recommended in Section 4 of this Handbook and review other guidance on the use of the IEUBK Model (EPA, 1994b; TRW web site: <http://www.epa.gov/superfund/programs/lead/ieubk.htm>). Risk assessors (and other data users) should be consulted early to assist with data collection and planning (EPA, 2000d). Another step is to get assistance from the regional risk assessor(s) to run the IEUBK Model with applicable site-specific inputs. Running the model should allow the determination of a site-specific PRG that corresponds to a P_{10} for a typical child, or group of similarly exposed children, that is no more than 5%. Another step is to select a site-specific residential soil lead clean-up level that is based on the model-derived soil lead PRG and an analysis of the nine criteria consistent with the NCP (Superfund sites only) (EPA, 1990b). If the proposed clean-up level is outside of the range of 400 ppm to 1,200 ppm lead, then the draft decision document for the site is sent to the Lead Sites Consultation Group (LSCG) for review (EPA, 1997b).

Lead Sites Consultation Group (LSCG) – The Lead Sites Consultation Group (LSCG) was created in 1997 to promote national consistency in decision-making at lead sites across the country (EPA, 1997b). The main purpose of the group is to review key response decisions at lead sites. The LSCG is comprised of senior management representatives from the Waste Management Divisions in all 10 EPA regions along with senior representatives from the Office of Emergency and Remedial Response in EPA headquarters.

The LSCG is supported by EPA’s Technical Review Workgroup for Lead (TRW) and the national Lead Sites Workgroup (LSW). According to Agency policy, there are three triggers that cause the review of lead-related proposed plans by the LSCG (EPA, 1997b):

- 1) Residential contaminated lead sites with proposed cleanup levels outside a 400 to 1,200 ppm soil-lead level;
- 2) Sites that envision actions to address non-soil lead-contaminated media;
- 3) Routine LSW deliberations that identify a unique or precedent setting site issue(s).

6.0 APPLICATION OF CLEAN-UP NUMBERS/REMEDIATION

The following section provides a detailed discussion of recommended minimum considerations to remediate residential soil and other sources of lead in residential settings. The guidelines stated below apply to early/interim actions and long-term remedial actions. However, due to statutory funding limitations that apply to time-critical removal actions, site-specific determinations regarding yard size limitations, and whether to clean up empty lots and other sources of lead (paint, dust, tap water), should be made by the project manager on a site-by-site basis.

6.1 MINIMUM EXCAVATION DEPTH/SOIL COVER THICKNESS

Based on Agency experience, it is strongly recommended that a minimum of twelve (12) inches of clean soil be used to establish an adequate barrier from contaminated soil in a residential yard for the protection of human health. Cover soil can either be placed after excavation as backfill or placed on top of the contaminated yard soil. The rationale for establishing a minimum cover thickness of 12 inches is that the top 12 inches of soil in a residential yard can be considered to be available for direct human contact. With the exception of gardening, the typical activities of children and adults in residential properties do not extend below a 12-inch depth. Thus, placement of a barrier of at least 12 inches of clean soil will generally prevent direct human contact and exposure to contaminated soil left at depth.

Removal of lead-contaminated soil to depths greater than 12 inches should be considered at sites in cold regions with non-soil lead-contamination sources, such as tailings and crushed battery casings, and whenever it is cost-effective. The additional response cost should be compared to future IC and monitoring costs associated with leaving the material in place. Full vertical removal of residential soil has many advantages, such as reducing or avoiding the costs of maintaining the soil cover, the placement of subsurface barriers/markers, and obtaining environmental easements. Full removal of contaminated soil also satisfies EPA's preference for permanent remedies and normally allows the remediated yard to return to unrestricted use.

Twenty-four (24) inches of clean soil cover is generally considered to be adequate for gardening areas; however, site specific conditions that may require more soil cover (e.g., presence of burrowing animals) should be considered. A 24-inch barrier normally is necessary to prevent contact of contaminated soil at depth with plant roots, root vegetables, and clean soil that is mixed via deep rototilling. Raised garden beds may be built to obtain 24 inches of clean soil, and may be more cost effective than excavating to 24 inches in depth, e.g., excavate 12 inches of contaminated soil, then add 24 inches of soil to create a 12" raised bed.

6.2 SOIL CLEAN-UP OPTIONS

Currently, there are only two remedial actions that generally are considered to be protective, long-term (not interim) remedial actions at residential properties: (1) excavation of contaminated soil followed by the placement of a soil cover barrier and (2) placement of a soil cover barrier without any excavation of contaminated soils. Excavation followed by the placement of a soil cover is the preferred method and is strongly recommended at sites with relatively shallow contamination, such as many smelter sites. In most cases, excavation and placement of a soil cover should be performed whenever the specific conditions of a site do not preclude it. For example, it may not be feasible to fully excavate a very large site cost-effectively, therefore capping, also considered to be protective, may be more appropriate. The advantage of the preferred method is that it is a permanent remedy in terms of removal of lead from areas where children may be exposed.

Several treatment technologies are currently under development to reduce the bioavailability of soil lead, but have not yet been proven to be protective in the long-term. These include amending the soil with phosphorus or high iron biosolids composts. Preliminary results have shown phosphate treatment to reduce the bioavailability of lead in soil by as much as 50 percent. This would mean that soil with lead concentrations in the range between clean-up levels calculated with the pre- and post-treatment bioavailability values could be treated instead of removed (e.g., if the IEUBK model-derived clean-up number using the pre-treatment bioavailability were 400 ppm lead, and the calculated post-treatment clean-up level were 800 ppm lead, then the yards with lead concentrations between 400 ppm and 800 ppm could be treated rather than excavated or capped).

Over time, the efficacy of the phosphorous treatments appears to increase. This is consistent with what is predicted using thermodynamics. To date, the treatability studies have been monitored for 3–5 years. Additional monitoring will be necessary to assure the long-term stability of the observed reduction in bioavailability.

Some other existing technologies for soil remediation that are not currently considered acceptable for residential lead cleanups are rototilling, phytoremediation, and interim controls, such as mulching, seeding, and sodding (without prior removal of contaminated soil). Rototilling is not considered a permanent, protective remedy in that no lead removal occurs, and adequate mixing of soil is difficult, if not impossible, to achieve; additionally, rototilling may increase the volume of soil, which ultimately requires remediation. Mulch, sod, or other vegetative covers are generally not considered permanent, protective remedies in that no lead removal occurs, and there is no guarantee that grass, mulch, or other vegetative cover will be maintained in good condition over time.

Additionally, land use changes that may occur within a yard, such as starting a garden or putting in a swing set, are not precluded in any way by mulch, sod, or other vegetative cover. Lastly, phytoremediation is not currently an appropriate technology for residential lead cleanups due to several factors: (1) the lead concentrations at many residential sites are not within the optimal performance range for the plants; (2) the plants may concentrate lower level lead contamination and present an increased disposal cost if the plants fail the TCLP test, but the unremediated yard soil does not fail; (3) the length of time required for remediation; (4) the potential conflicts with local regulations pertaining to yard maintenance; and (5) the depth of remediation achieved may be inadequate.

6.3 INTERPRETING SAMPLING RESULTS

Based upon the results of the sampling efforts (Section 4.0), this section describes the implementation of two clean-up options: (1) excavation and backfill (and placement of a visible barrier if applicable); or (2) soil cover placement (and placement of a visible barrier if applicable). The options should be performed as described below (see also Figure 6-1). The goal should be to remove all contaminated soil or provide a minimum 12" clean soil barrier. The following describes the implementation of option 1:

- If the 0–1" horizon exceeds the clean-up level, a 6 or 12" excavation is recommended, depending on the 6–12" sample horizon results;
- If the 1–6" or 0–6" horizon exceeds the clean-up level, a 6 or 12" excavation is recommended, depending on the 6–12" sample horizon results;
- If the 6–12" horizon exceeds the clean-up level, a 12" excavation is recommended. A visual barrier is required if the 12–18" horizon exceeds the clean-up level;
- If the 0–1, 0–6 or 1–6" horizons exceed the clean-up level and the 6–12" horizon does not exceed the clean-up level, a 6" excavation is recommended; a visual barrier is not needed.

	Depth	Soil Concentration Exceed Action Level?							
		Yes	Yes	Yes	Yes	No	No	No	No
	0-1"	Yes	Yes	Yes	Yes	No	No	No	No
	1-6" (or 0-6")	Yes	Yes	No	No	No	Yes	No	Yes
Remedial Action Options	6-12"	Yes	No	Yes	No	No	No	Yes	Yes
Option 1: Excavation (& Backfill)	Depth of excavation	12"	6"	12"	6"	No action	6"	12"	12"
Option 2: Capping	Soil cover thickness	12"	12"	12"	12"	No action	12"	6"	12"

Figure 6-1. Interpreting Sampling Results. The figure suggests remedial actions based on the results of composite soil samples collected for each of the depth intervals shown. The figure includes two remedial action options: (1) excavation followed by backfilling, and (2) placement of a clean soil cover without removal of soil that exceeds the action level. To use the figure, find the column of the table that agrees with the soil sample results for your site, then read down the table to determine the depth of soil to remove (option 1: excavation remedies) or the thickness of the soil cover recommended (option 2: capping remedies). For example, the heavy border around the third column of the table corresponds to a situation where the average lead concentration in the 0–1" and 1–6" depth intervals exceed the action level, but the 6–12" interval does not. In this example, it is recommended to remove the top 6" of contaminated soil and replace it with clean soil, or to place a 12" clean soil cover (cap). The goal is to provide a minimum 12" barrier of clean soil when the underlying soil exceeds the action level. Please refer to Section 6.3 for further explanation.

The following describes the implementation of option 2:

- If the 0–1" horizon exceeds the clean-up level, a 12" soil cover and visual barrier should be used;
- If the 0–6" or 1–6" horizon exceeds the clean-up level, a 12" soil cover and visual barrier should be used;
- If the 6–12" horizon exceeds the clean-up level (but not the 0–1", 1–6", or 0–6" intervals), a 6" soil cover should be used;
- If only the 12–18" horizon exceeds the clean-up level, no capping is needed.

The decision to perform soil cleanup to depths greater than 12 inches should be considered on a site-by-site basis. Some advantages to full vertical soil cleanup are listed in Section 6.1. However, there are many sites where lead contamination is located at depth. Full vertical soil cleanup may not be cost-effective and/or feasible at such sites. The depth of excavation and soil cover thickness is an important factor to be considered during the analysis of the nine criteria per the NCP (for Superfund sites) (EPA, 1990b). Potential for freeze/thaw upward migration, groundwater contamination, and the cost, extent, and effectiveness of ICs are some of the factors to be considered in this analysis.

Sampling results obtained for residential lots may indicate that only a portion of the lot contains soil that exceeds the selected clean-up level. For properties less than 5,000 square feet, the spatial scale for the remedial decision should be one-half of the yard. For properties greater than 5,000 square feet, the property should be divided into four quadrants and a remedial decision should be made for each quadrant. It is usually protective to excavate only the portion(s) of the lot that exceed the clean-up level (Figures 6-2a and 6-2b). However, removal of the sod layer and resodding/reseeding the unexcavated portion(s) of the lot is strongly recommended to promote consistency in the vegetative cover of the yard for homeowner satisfaction. When interpreting sampling results for a property, the sampling results of surrounding properties should also be considered to lessen the probability of mislabeling the property as being below the clean-up level, when it is actually above, and to avoid "patchwork clean-up" patterns, which are prone to recontamination.

If the only portion of the yard that exceeds the selected clean-up level is the drip zone, the exterior paint should be checked for lead content. If the drip zone contamination does not appear to be paint-related, the drip zone should generally be cleaned up. If the drip zone contamination appears to be solely paint-related, EPA should promote the remediation of the exterior LBP by local health agencies, other local government agencies, state health agencies, and/or the homeowner. At a minimum, the resident should be notified and informed of the disclosure requirements (Appendix A). Consideration should be given to also notifying the relevant local government agencies and informing them about available remedies, such as HUD grants.

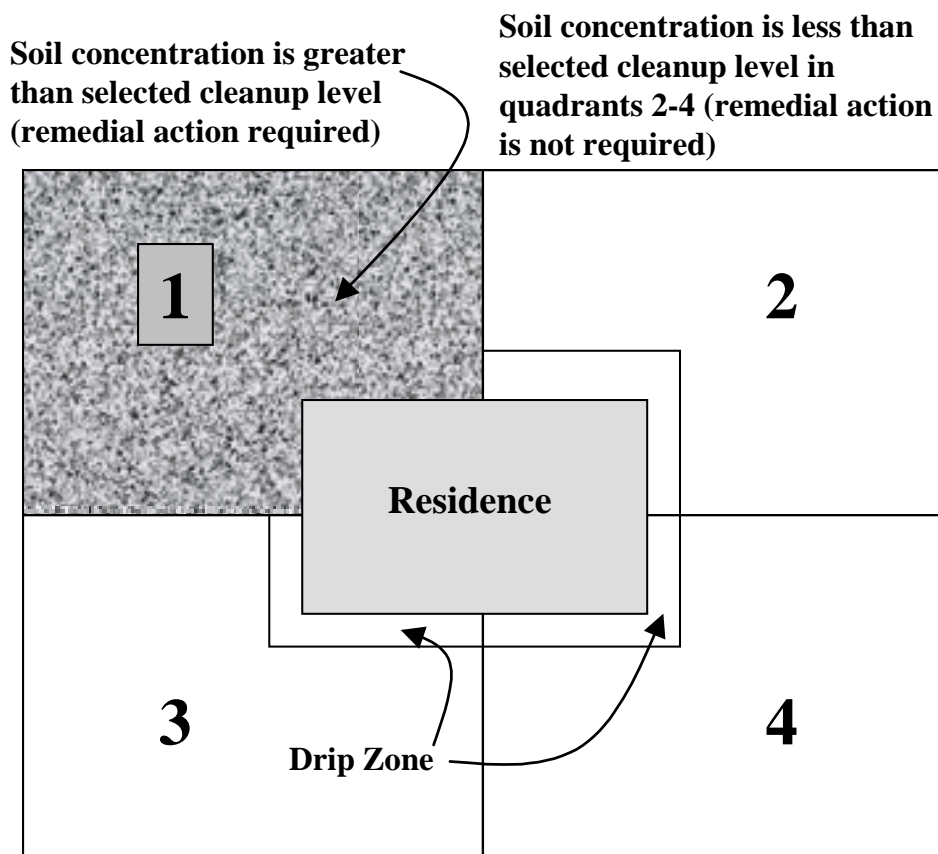

Figure 6-2b. Partial cleanup of residential lot greater than 5,000 square feet in size. In this example, the lead concentration measured in quadrant 1 exceeds the selected clean-up level while the concentration measured in quadrants 2–4 do not. Cleanup may be limited to quadrant 1 although it is recommended that the sod layer in the entire lot be removed to promote consistency in the vegetative cover on the property for homeowner satisfaction. The entire drip zone should be cleaned up if the average lead concentration exceeds the clean-up level. For example, in the above figure, the drip zone in quadrants 2–4 (as well as quadrant 1) should be cleaned up if the average concentration in the drip zone exceeds the clean-up level. Please refer to Section 6.3 for further explanation.

6.4 OTHER CLEANUP CONSIDERATIONS

The area remediated on a single property normally should not exceed one acre. This limitation is based on three factors: (1) typical lot sizes in residential areas throughout the country generally do not exceed one acre; (2) the portion of a property where the majority of exposure to contaminated soil occurs generally does not exceed one acre; and (3) EPA should generally not excavate/cover with soil the entirety of very large yards due to cost-effectiveness considerations.

The goal for cleanup of a yard that exceeds one acre is to excavate or cap the portion of the yard that is in frequent use and continue to limit exposure in the unremediated portion of the yard. To this end, it is recommended that the unremediated portion of such a yard be fenced to clearly delineate the remediated and unremediated areas and to limit the potential for off-site migration of contaminants (e.g., vehicle tracking). Exceptions to this general approach may include areas outside the one-acre area that are used for recreation and gardening, areas with the potential for residential development, and areas in close proximity to other residential areas. As stated in Section 6.5, any unremediated areas of a property should be documented on the clean-up documentation letter for such property, and consideration should be given to implementing ICs for those areas.

If contaminated soil is not removed to the full depth of contamination (i.e., where soil concentration is greater than clean-up level) on a property, a permanent barrier/marker that is permeable, easily visible and not prone to frost heave, should be placed to separate the clean fill from the contamination. This applies to both incomplete vertical excavation with placement of a soil cover and placement of a soil cover without excavating contaminated soil. Selection of an appropriate permanent barrier/marker should be based on the type of contamination left in place, the chemical/physical characteristics of the soil (e.g., pH), the potential for upward migration of the contamination, and/or the types of ICs developed for the site. Examples of suitable barriers/markers include snow fencing (usually orange), a clean, crushed limestone layer, and geofabric.

Empty lots that are zoned residential and contain soils with lead concentrations greater than the clean-up level should be cleaned up when in close proximity to other residential lots. Examples of this are lots between two houses and lots that are near occupied lots. A site-specific determination should be made for these situations. Also, unpaved lots used for vehicle parking should be sampled, and cleaned up if necessary, or access restrictions put in place to prevent recontamination (e.g., vehicle tracking of contaminants) even if no current direct exposure exists. However, it is not the intent of EPA to clean up tracts of remote, undeveloped, lead-contaminated land that may be developed into residential lots in the future. This clean-up responsibility should be borne by the land developer. Institutional controls should

be developed to ensure safe development in these areas, since under CERCLA developers could be held liable for improper cleanup.

6.4.1 Background Lead Concentrations

Many of the “Lead Sites” on the NPL are located in areas with high natural background lead concentration. Often this problem is exacerbated by the presence of high background concentrations of lead in various media (such as soil and groundwater) from anthropogenic sources such as automobile emissions, mining, and smelting (the latter two sources would be considered ‘background’ if they are not associated with the site). It should be noted that CERCLA 104 (a)(3) limits the Agency from taking response actions to address “... naturally occurring substance in its unaltered form, or altered solely through naturally occurring processes or phenomena, from a location where it is naturally found” (EPA, 2000a). Generally, under CERCLA, clean-up levels are not set below natural or anthropogenic background concentrations (EPA, 1996c, 1997d, 2002). Cleanup below natural or anthropogenic background concentrations is normally not performed because it is not cost-effective, it is technically infeasible and there is a high likelihood of recontamination by surrounding areas that have not been remediated (EPA, 2002).

Public education about ubiquitous risks should be incorporated early in the process to help the community understand that Superfund actions are designed to address risks from specific releases to the environment (EPA, 2002). In situations like these, it may be appropriate to examine land uses that limit exposures through implementation of ICs. For more information on this approach, please refer to the 1998 Clarification to the Revised Interim Soil Lead Guidance for CERCLA Sites and RCRA Corrective Action Facilities (Appendix B). Site-specific factors should determine what range of alternatives and what clean-up levels will achieve a protective remedy satisfying the nine criteria specified in the NCP.

Remedial decisions often involve a comprehensive response coordinated with other responsible authorities, such as a local public health district, state departments of environmental protection, housing agencies, and private parties. An effort should be made to identify other programs or regulations that may have the authority and capability of addressing risks associated with high natural or anthropogenic background (EPA, 2002). Additional guidance is available for developing a risk management-based response strategy that is protective of human health and the environment (EPA, 1988).

6.5 YARD CLEANUP SPECIFICS

It is important to define the limits of the properties that will be remediated. The use of property lines rather than temporary features, such as fence lines, to delineate boundaries is recommended. The use of temporary features may result in partial cleanup of some properties.

Whether remediation consists of excavation and placement of soil cover or just the placement of a soil cover, consultation with the property owners is important to the development and implementation of response actions and may necessitate property-specific deviations to the guidelines listed in this section. Flexibility is essential to a successful residential lead clean-up program. Some residents may want to pay for upgrades during the cleanup of their yard, such as paving a driveway after excavation, or to have some yard features removed, such as taking out a damaged patio. Within reasonable limits, such requests should be entertained on a yard-by-yard basis. Granting such requests can greatly contribute to building public trust and satisfaction with the clean-up program. All additional costs associated with special requests and considerations must be borne by the homeowner.

Prior to cleanup of a residential yard, access from the property owner should be obtained; access obtained from tenants or renters is not sufficient. It is recommended that access be obtained by going door-to-door. If residents are not home, a blank access agreement with instructions for signature and submission to EPA, along with relevant contact information should be left at the residence (but not in the mailbox). An example access agreement form is presented on page D-6 of Appendix D. As stated in Section 4.2.1, it is suggested that access for remediation be obtained at the time access for sampling is sought. Examples of combined sampling/remediation access agreements are presented on pages D-4 and D-5. An example of a dust cleanup access agreement form is presented on page E-2 of Appendix E. Many residents may refuse access for dust cleanup while granting access for yard-soil cleanup. Combining dust access agreements with other access agreements is not recommended.

Prior to initiating clean-up activity, the condition of each property should be documented and recorded on videotape. 'Clean-up activity' includes any disturbance of the property, including the removal of debris and dilapidated structures that may be required prior to initiating the excavation of contaminated soil. An example of a property inspection form is provided in Appendix F. EPA should enter into a written agreement with the resident regarding any special requests or considerations in cleaning up the yard, e.g., replacing concrete walkway with brick. All additional costs associated with special requests and considerations must be borne by the homeowner. Any contaminated yard areas that will not be cleaned up, special resident concerns, and any deviations from strict soil excavation or capping should be noted on this agreement.

Other possibilities for cleanup-related agreements include sod/lawn watering agreements. A sod-watering agreement basically allows for payment to residents for watering the sod that is placed by the remediation contractor. A payment is made before watering is required to cover the water bill and some of the time involved. A second payment is made if, at the end of one month, the sod is in good condition. A similar agreement should be established for maintaining lawns that have been initiated by hydroseeding. This can be a useful incentive program that can also save money. The contract with the remediation contractor should require the contractor to establish vegetation on each property, restore the pre-construction drainage patterns on each property, and perform repairs for damages to the property.

Relocation of residents during yard soil remediation is rarely needed and is generally not recommended (EPA, 1999b). (Guidance is available online at: <http://www.epa.gov/oerrpage/superfund/tools/topics/relocation/index.htm>.)

Specific safety issues during residential yard cleanup, including ingress and egress to the home, should be coordinated with the property owner/residents and spelled out in the Health and Safety Plan.

Incomplete barriers (such as rock or gravel) or minimal use areas (such as areas under porches), which exceed the applicable clean-up level, should be cleaned up to the extent practical. Although removal is preferred, if it is not feasible to clean up the area, a barrier, which effectively limits access, should be constructed. For example, for areas underneath porches, typically the preferred barrier would be shot-crete (sprayed concrete that can easily be placed in tight or confined areas). It may be preferable to place asphalt rather than gravel on heavily-trafficked roads or driveways, especially those that experience severe erosion.

In all cases, every attempt should be made to clean up the entire yard (subject to cost limitations discussed below), however, any residential yard areas without permanent barriers that the resident requests to leave unremediated, such as gardens or patios, should be sampled separately to determine if the selected clean-up level is exceeded. If the clean-up level is exceeded and the owner refuses to allow cleanup of that portion of the yard, then the clean-up documentation letter issued to the owner should note the unremediated area.

The steps of a typical soil cleanup are shown in the text box below.

Steps of a Typical Soil Response Action

Step 1 (Access Agreement) - Collect access agreement(s) from each owner and/or tenant before any work is conducted.

Step 2 (Initial Survey) - Interview the resident(s) to determine if there are any specific problems that need attention, and if there are any structures or property the owner wants to have disposed, stored, or left untouched. The contractor will conduct a thorough documentation of the property using drawings, digital photographs, and videotapes. Once documented, the owner is required to sign a property agreement which documents any special requests or considerations in cleaning up the yard, any contaminated yard areas that will not be cleaned up, provisions for structural concrete and fence restoration, and deviations from strict soil excavation and capping.

Step 3 (Excavation) - Each tract is excavated by the contractor(s), who will also complete documentation and provide depth confirmations.

Step 4 (Backfill) - After excavation of properties where full excavation to depth has been performed, the excavated area is backfilled and compacted. After excavation of properties with a vertical excavation limit, a permanent, permeable barrier/marker is placed in the excavated area. After placement of the barrier/marker, the excavation area is backfilled and compacted.

Step 5 (Restoration) - Restoration of the property, including landscaping, sod/seeding, fencing, and concrete (if needed) is conducted.

Step 6 (Final Inspection) - After restoration activities are complete, the EPA, PRP, or its agent (e.g., Corps of Engineers) will conduct a final inspection.

Step 7 (Closeout Form) - A property closeout form should be signed by the property owner, which documents the owner is satisfied with the remediation of the property. Any outstanding issues between the EPA and the homeowner that have not been fully resolved should be documented in the closeout form.

Step 8 (Clean Letter) - After the homeowner signs at property closeout form, the EPA issues a "clean" letter, which documents the property has been remediated. Any areas that are not cleaned up via the owner's request, such as gardens, should be noted in the "clean" letter. For properties where contamination is not completely removed, the clean letter should also document the presence of contamination at depth, and should describe the protective measures that were taken to prevent exposure to the remaining contamination (i.e., barriers/markers).

6.6 CLEANUP OF OTHER SOURCES OF LEAD

Lead in the environment can originate from many sources. In addition to soil, the main sources to consider when performing clean-up activities are interior and exterior LBP, lead-contaminated interior dust, drinking water, and occupational exposure resulting in subsequent contamination of homes. Generally, sources other than soil, exterior paint, dust, and tap water cannot be remediated by EPA in the course of residential lead cleanups.

Ultimately, the project managers should strive to address any unacceptable lead-exposure risks at the residence. Sampling and the establishment of clean-up mechanisms needed to take action, such as HUD grants for paint abatement, should be completed as early in the remedial process as possible. Even so, it may not be possible to address all sources of lead in the ideal sequence. When this occurs, other measures should be taken to minimize the potential for recontamination (i.e., to protect the remedy). For example, if deteriorating exterior LBP is present, it is recommended that it be removed prior to initiating any soil clean-up activities in the yard.

Due to transport of lead among media, the preferred sequence of lead clean-up activities at a residence with LBP and lead-contaminated soil would be to clean up the paint first, then the yard soil, and then the interior dust. Clean-up activities performed counter to this sequence increase the risk of recontamination. For example, performing a soil cleanup first at a residence with exterior paint problems increases the potential for recontamination of the soil from the exterior paint. Similarly, interior dust can be recontaminated by interior LBP. Exterior sources have been shown to cause recontamination of the interior when cleaned before community-wide yard cleanup is completed (EPA, 2000e). Accordingly, project managers should make every effort to coordinate the sequence of clean-up activities to prevent recontamination.

CERCLA and the NCP limit Superfund authority to address interior LBP (see Section 1.2) (EPA, 1990b). If a mechanism exists for addressing the paint, such as a HUD grant or a Supplemental Environmental Project (SEP), then the timing of the paint encapsulation or abatement activities may not coincide with the soil cleanup. Additionally, residents may be more reluctant to grant access for dust remediation since it is more intrusive. On the other hand, EPA actions taken to address lead in drinking water from site sources usually can be taken independently from any soil, dust, or paint cleanups, and should be done as soon as practical.

Supplemental Environment Project (SEP) – Environmentally beneficial projects which a defendant/respondent agree to undertake in settlement of an enforcement action, but which the defendant/respondent is not otherwise legally required to perform.

6.6.1 Lead-Based Paint

The 1998 Clarification presents OSWER's policy with respect to remediation of interior paint, exterior paint, interior dust, and lead plumbing. Regarding interior LBP, the 1998 Clarification states:

“EPA has limited legal authority to use Superfund to address exposure from interior lead-based paint. As a policy matter, OSWER recommends that such exposures not be addressed through actual abatement activities. However, EPA Regions should promote addressing interior paint risks through actions by others, such as HUD, local governments and health authorities, or individual homeowners as a component of an overall site management strategy. Any activities to clean up interior lead-based paint by potentially responsible parties (PRPs) or other parties should not result in an increase of the risk-based soil clean-up levels” (EPA, 1998a; Appendix B).

Regarding exterior LBP, the 1998 Clarification indicates that the Regions should avoid using the Superfund trust money for removing exterior LBP and soil contaminated from LBP. However, Superfund dollars may be used to respond to exterior LBP to prevent recontamination of soils that have been remediated, but only after determining that other funding sources are not available (EPA, 1998a; Appendix B). The 1998 Clarification states: “As with interior lead-based paint abatement, EPA Regions should promote remediation of exterior lead-based paint by others, such as PRPs, local governments, or individual homeowners. Clean-up activities of exterior paint conducted by PRPs or other parties should not result in an increase of the risk-based soil clean-up levels” (EPA, 1998a; Appendix B).

As a practical matter, project managers should inform each resident regarding the presence or absence of LBP in their home, and options for encapsulation and abatement. The local health agency and/or the state health agency should be informed regarding the availability of HUD grants for paint assessment and abatement. Additionally, regarding PRP-funded cleanups, if any penalties are being considered for non-compliance (Section 6.9), consideration should be given to allowing the PRPs to perform a SEP for paint assessment and abatement in lieu of some or all of the penalty amount.

6.6.2 Interior Dust

Lead-contaminated interior dust can be derived from multiple sources, including exterior soil, interior and exterior paint, homeowner hobbies, workplace, and other exterior sources; thus, it may be difficult to differentiate between sources of dust contamination. Household lead dust contamination may be a significant contributor to elevated blood lead levels, especially for younger children (under the age of three), and may need to be evaluated in determining risks and clean-up actions at residential lead sites. However, as pointed out previously, there are limitations on EPA's authority to abate these sources of contamination to the extent they are not related to releases or threatened releases to the environment (Appendix B).

Based on the 1998 Clarification, OSWER recommends that Superfund monies should generally not be used to take CERCLA response actions for addressing residential dust exposures due solely to interior paint or other interior sources. However, Superfund monies can be used to address interior dust if it can be shown to be derived from an exterior pollution source (e.g., air lead concentration caused by lead smelter, mining, or mineral processing). Dust mat sampling, which was done at the Bunker Hill Site in Idaho (EPA, 2000e), is one possible method of lead source identification; speciation, which is costly, is another method. (Dust mats are used to measure dust lead concentration and loading rates in residences and other structures.) Where interior dust is being addressed by other authorities, the recommendations presented here may be helpful to guide the dust cleanup.

If the lead in interior dust is solely derived from interior paint, EPA should promote addressing interior dust risks through the actions of others, such as HUD, state and local governments, PRPs, or individual homeowners, as a component of an overall site management strategy. The overall site strategy, as outlined below, should also consider the proper phasing/sequencing of actions to address the multiple sources of lead risks at residential lead sites, as discussed at the beginning of Section 6.6.

The baseline risk assessment should document the relative contributions of lead uptake from all relevant media including direct soil exposures and secondary exposures to soil in indoor dust. Replacement of defaults with a site-specific value for the interior dust concentration, or the soil-to-dust relationship (M_{sd}), should be justified through the use of high quality, compelling, site-specific data (EPA, 1994b, 1998c). Dust sampling is preferred for risk assessment and remedial decisions, but dust modeling may be needed to develop or refine soil action levels.

Lead-contaminated interior residential dust presents a significant exposure pathway that can readily be addressed. Consequently, significant health benefit is gained by removal of contaminated interior dust as early in clean-up activities as possible. However, exterior contamination sources present a threat of recontamination to interior of residences (EPA, 2000e; TerraGraphics, 2001). Therefore, any interior dust clean-up actions should be periodic throughout the project and should culminate in a final cleaning of all residences exceeding an action level after the exterior sources have been remediated. As a practical matter, risk management and reduction may need a phased strategy as recommended below:

Early-Phase Actions: Public awareness and health education efforts should be initiated immediately. Entry way dust mats should be provided to residents. HEPA-filter vacuum cleaners should be provided for use by residents. If warranted, a program to abate interior lead-contaminated dust in homes with acute levels should be initiated to provide temporary risk reduction.

Establish appropriate public health partnerships with state and local health departments, ATSDR, and HUD as early as practical.

Mid-Phase Actions: The source of the interior dust lead contamination should be identified. Monitoring of the changes in lead-contaminated dust (e.g., lead loading in dust, lead concentration in dust, exterior-to-interior lead transport) should be initiated. The public awareness/health education efforts and availability of HEPA-filter vacuum cleaners for use by residents should be continued. Assistance to remove and dispose of old carpets should be provided to residents after yard cleanup has occurred.

Final-Phase Actions: Once the exterior lead sources that were found to contribute to interior dust have been addressed, the final step should consider the active remediation of interior lead-contaminated dust. Actions may include: removal of carpeting, cleaning heat and ventilation ducts, wet wiping hard surfaces and soft surfaces (furniture, draperies, bedding, clothing, etc.). Most of these actions should be limited to living spaces. Areas such as attics, crawl spaces, and other non-living spaces need not be addressed unless they are shown to be a continued source of contamination to the living areas. It is important for dust remediation to be performed as the last phase in the site clean-up process to minimize the risk of recontamination.

6.6.3 Lead Plumbing/Tap Water

The 1998 Clarification states: “Generally CERCLA does not provide legal authority to respond to risks posed by lead plumbing within residential dwellings. It should be noted that the water utility is responsible for providing clean water to the residences. As with interior dust, OSWER recommends that EPA Regions coordinate with local agencies to establish a health education program to inform residents of the hazards associated with lead plumbing and how to protect themselves by regularly flushing, or preferably, replacing lead pipes. Soil clean-up levels should not be adjusted to account for possible remediation of lead plumbing” (EPA, 1998a; Appendix B).

With regard to tap water, it should be sampled, and lead levels in the purged sample in excess of the maximum contaminant level (MCL) established by the Safe Drinking Water Act should be addressed. In general, lead concentrations in the purged sample greater than a removal action level (RAL) of 30 : g/L should be addressed through TCRA; concentrations between the MCL and RAL should be addressed through NTCRA or long-term remedial actions. Actions that could be taken include provision of bottled

water, connection to a municipal water supply, tap filtration, and installation of deep wells (in remote areas and where shallow groundwater is contaminated). Regarding first run exceedance for lead, the homeowners should be notified that they may need to address a plumbing or corrosion problem, which is outside of the scope of Superfund.

6.7 PREVENTION OF RECONTAMINATION

Project managers should take steps to mitigate recontamination. During site closeout and five-year reviews, the project manager should also check for recontamination at levels which may threaten the remedy.

At many large-area lead sites, cleanup occurs over a long period of time and through multiple phases, throughout which the potential for recontamination exists. During each of these phases, windblown dust sources, vehicle tracking, flooding, and other mechanisms can recontaminate previously cleaned areas. Although best management practices (BMPs) should minimize the movement of contaminated material from each residence being cleaned, vehicle tracking of contamination from areas yet to be cleaned up can significantly raise concentrations of contaminants in cleaned areas. During the early phase, typically an emergency response action, cleanup is focused towards Tier 1 properties, and cleanup favors a “hop scotch” approach to address the worst risks first. This method of remediation can result in recontamination of clean properties. Confirmation samples should be collected in any areas that have been potentially recontaminated.

Another aspect of large-area lead sites is that complete cleanup of residential properties does not always take place for a variety of reasons (see Sections 6.2 and 6.4); instead a barrier or soil cover is put in place over contaminated soils. Flooding can pose a serious problem for these areas in that flood waters

Best Management Practice (BMP) – In general, BMPs are a combination of practices that are determined to be the most effective and practicable means of controlling point and nonpoint pollutants at levels compatible with environmental quality goals. In this document, BMPs specifically refer to measures taken during construction activities on properties where contamination has been left at depth to prevent the transfer of those contaminants to other media.

can erode away clean materials leaving subsurface contamination exposed, and entrained sediments bearing contamination may be left on top of newly remediated properties. Inadequate drainage of runoff can move lead into cleaned areas (e.g., lead particles on a crowned road with no curb and gutter may be rinsed onto adjacent residential properties with normal rainfall). Additionally, the activities of burrowing animals can bring contaminated soils to the surface.

Recontamination of clean soil cover can be caused by ongoing homeowner projects, such as digging a hole through a clean barrier to install fence posts or a new tree or shrub, if preventative measures are not taken. Education and licensing of contractors who work on clean barriers/markers should generally be required (e.g., as part of a local ordinance) to ensure the longevity of the remedy. Also, at many sites (e.g., Bunker Hill), ICs have been most effective when linked to the “call before you dig” program typically operated by many counties to avoid disruption of utility service. In addition, large scale residential development projects that may raze old housing in favor of new will frequently recontaminate areas where lead-contaminated soil was left at depth, without appropriate BMPs in place. BMPs include silt fences, hay bales, etc., to limit movement of contamination off a project site, and stockpiling of contaminated soil on a tarp to prevent contamination of underlying soil (Figure 6-3). EPA provides guidance on the implementation of BMPs in construction activities at sites where contamination is present (EPA, 1997e). Best management practices typically add about 5 percent to project cost (TerraGraphics, 2000). Periodic inspections of residential areas should be performed by the local government to ensure that projects within the site are implementing BMPs.

Wind blown dust can pose a significant threat to the health of individuals at a site and can cause recontamination. Tailings impoundments that have dried can be large sources of windblown lead dust. Most tailings impoundments are large; a wind sweeping across the face of one can carry substantial amounts of contaminated dust and then deposit these particles on a downwind residential area, both causing increased exposure to contaminants, and recontaminating clean areas. Wind blown dust sources are typically a key issue to be addressed early in the sequencing of site activities to minimize this migration.

These are but a few examples of how recontamination can be an ongoing problem that needs to be considered at every site during each phase of cleanup. Although mechanisms vary from site to site, the types of response actions put in place and the sequence in which these actions take place can play a significant role in enhancing the permanence and effectiveness of a remedy.

A disposal area may be needed to dispose of contaminated soil from the site to support typical homeowner projects, as some municipal landfills may not accept contaminated soil. Without free or low cost disposal for contaminated soil available to each homeowner and renter, improper disposal is more likely, which would result in recontamination. In addition, a disposal area may be needed if certain materials at a site, such as carpets, fail TCLP and cannot be commingled with solid waste. It may even be appropriate for the remedy to provide free removal of contaminated soil and provision of clean soil to homeowners (but contractors may be required to pay for these services, or obtain material from approved sources) to encourage maximum compliance and further ensure the longevity of the remedy. The

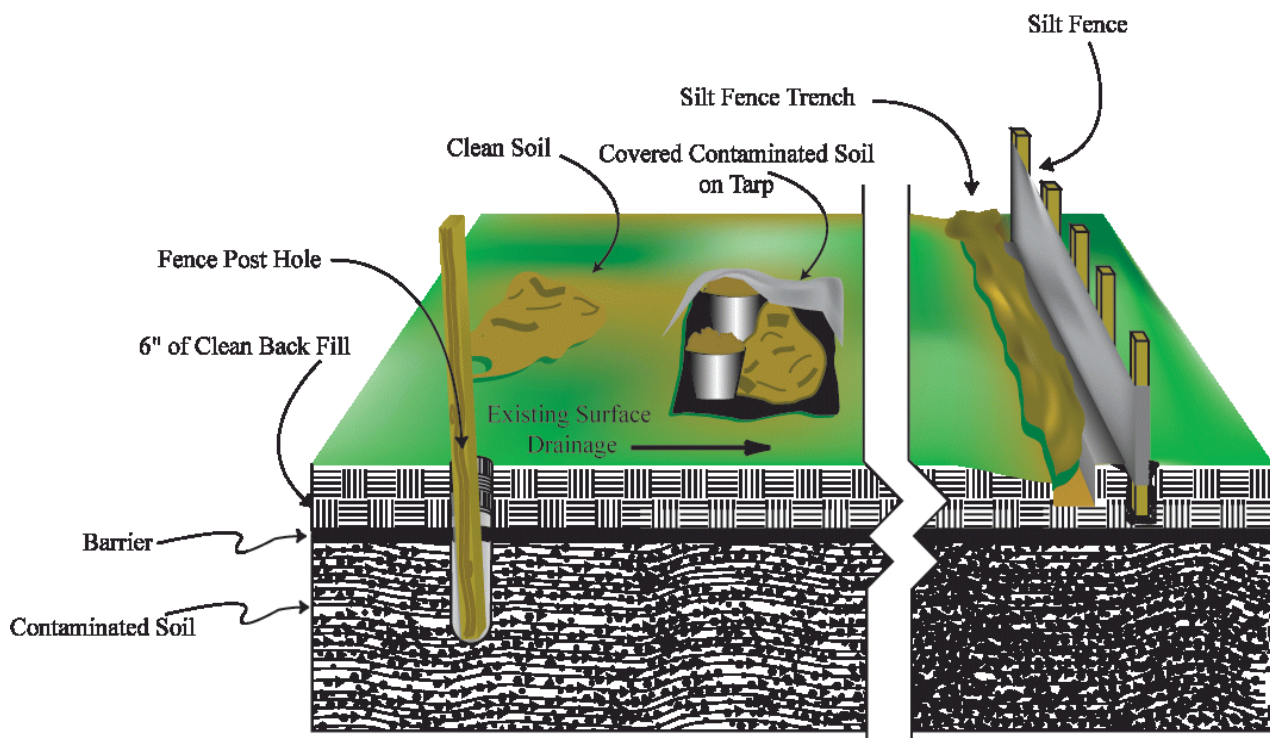

Figure 6-3. Implementing Best Management Practices (BMPs) during construction work. The best management practices (BMPs) shown in the above figure (e.g., a clean soil barrier) represent one component of the ICs which may be put in place by local ordinance to ensure the long-term protectiveness of the remedy and to prevent recontamination. The purpose of BMPs is to minimize the potential for accidental exposure of humans during construction and maintenance activities on sites where wastes have been left in place. The staging of contaminated soil on tarps and/or in small buckets, and the installation of silt fences downgradient of the construction area are examples of BMPs intended to prevent the migration of contaminated material from the construction site. Please refer to Section 6.7.3 for further explanation.

maximum concentration of lead (and perhaps other constituents) allowed in “clean” soil, and the required sampling frequency, should be specified in an IC.

Over the long term, cleanups may not be possible at every property at the same time. A trust fund should be established for the site for the cleanup of properties that are deferred for various reasons, which should be implemented by the local government. In this manner, changes in property ownership over time may be more closely monitored to determine when cleanup at deferred properties might be appropriate (see Section 6.9). Local implementation of the trust fund will ensure that cleanup of these properties occurs as soon as possible, further ensuring the protectiveness of the remedy, further ensuring the protectiveness of the remedy by minimizing the potential for recontamination to the extent possible.

6.7.1 Early Actions

Early response actions (including cleanups for sensitive subpopulations) can be an essential aspect of the response action at a site, as discussed above. These actions should be conducted simultaneously with source area control. The following are considerations that may reduce the potential for recontamination when scoping an early action.

- C Seek permanence in selecting the clean-up alternative(s), if possible, such as complete removal to depth of soil contamination at properties where there is an acute risk.
- C Consider cleanup of adjacent properties simultaneously that may threaten the permanence or effectiveness of the early action.
- C Control fugitive dust sources, access, tracking, and erosion of contaminants to the extent possible.
- C Perform HEPA street sweeping to minimize tracking of contaminants throughout a community.
- C Evaluate the feasibility of conducting the cleanup of residential areas in their entirety during the early removal phase if contamination is widespread. If this is not possible, limit the early removal actions to immediate risks (Tier 1 and Tier 2 residential properties, including residences with elevated blood lead levels) in order to minimize the potential area where recontamination might occur.
- C Provide informational fact sheets to homeowners on how to minimize recontamination on their property.
- C Establish an IC to manage cleaned areas. This could involve local and state government agencies, and PRPs that are available to recommend best management practices for homeowner projects and provide education to the homeowner, as well as utility districts and companies likely to breach the barriers/markers put in place.
- C Provide site plans or other documentation of areas that have been cleaned up, as well as information on areas that are still contaminated, to the local governmental entity responsible for the maintenance of the remedy, i.e., for monitoring ICs and for tracking properties over time.
- Establish a geographic information system (GIS) for monitoring ICs and properties.

6.7.2 Long-term Remedial Action

Some or all of the following measures may be useful to address the risk of recontamination during the remedial action (Tiers 2 and 3, if a tiered approach is used) and post-design phase:

- C Evaluate the permanence and effectiveness of the various remedial actions under consideration. Consider the economic feasibility of complete contaminated soil removal to minimize reliance on ICs.
- C Conduct a cost analysis comparing the cost of long term ICs to those of complete removal (EPA, 2000f). For example, property depreciation, tax base impact, additional procedures/cost of utility work, flooding complications/costs, and long term IC administration cost should be taken into account when comparing the cost of a partial removal of contaminants to a complete removal. Property depreciation, while possibly subtle for each property, may add up to substantial losses for the entire community in reference to a county tax base. Also, losses for an individual property over a lifetime of sales could add up to a significant cost. Following cleanup, increases in property valuation from source removal or drainage/infrastructure enhancements (and savings/in-kind services to municipalities) should be considered.
- C Remedial action should strive to remediate the contamination in the community by segregable areas, such as a town, or a divisible segment of town. Each segregable area should be cleaned up as quickly as possible (e.g., within one construction season) to minimize recontamination of cleaned properties and to compound the protection to human health (EPA, 2000e). Each community should be cleaned up block by block within these segregable areas, utilizing BMPs to mitigate tracking of contaminants. Site experience suggests that cleanup of up to 800 properties per site per year is possible.
- C Fugitive dust that may be a source for recontamination, and access to such sources should be controlled. Air monitoring along with depositional modeling may be necessary to determine if windblown dust presents a significant threat of recontamination. Significant sources of windblown dust should be controlled prior to or simultaneously with cleanup of adjacent residential areas. Consider HEPA street sweeping during remediation and immediately following completion of cleanup to minimize tracking of contaminants throughout a community.
- C Complete removal of contaminants should be considered in flood prone areas or areas with a high groundwater level due to the inherent difficulty in maintaining a soil cover remedy in a flood prone area. Drainage-ways containing contamination within their 100-year floodplain, which are

not addressed in the remedy could also lead to remedy failure if the contaminants are eroded to other areas.

- C Remediation of contaminated rights-of-way should occur within segregable areas simultaneously, if possible, or as close together in time as possible to minimize vehicle tracking and recontamination of driveways from the rights-of-way.
- C Control measures for all remaining sources, such as mining waste piles surrounding the community, should be developed to ensure the remediated neighborhoods are kept clean. ICs should be established to ensure the control, or proper use and disposal of any wastes remaining on site.
- C If the residential remedy includes replacement of soils, removal of deteriorating exterior LBP (e.g., by pressure washing) should be considered to minimize the soil recontamination potential.
- Other sources of residential property recontamination should also be considered. For example, homeowners may bring in contaminated soil for fill or other uses on their property.
- C Establish permanent funding for ICs. Unless all contaminants are removed, some level of ICs may be necessary. Early establishment of a program is the key to success of a remedy that consists of a partial removal of contaminants.

6.7.3 Institutional Controls (ICs)

EPA defines ICs as administrative and/or legal mechanisms that: (1) help minimize the potential for human exposure to contamination, and (2) protect the integrity of the remedy. ICs accomplish these objectives by directly limiting land or resource use, and/or by providing information that modifies behavior. ICs are used throughout the remedy pipeline, including (1) when contamination is first discovered (i.e., prohibition of excavation of newly discovered soil contamination), (2) when the remedy is ongoing (i.e., restrictions on property use until clean-up levels are met), and (3) when hazardous substances, pollutants, or contaminants remain at the site above levels that allow for unlimited use and unrestricted exposure.

At sites where minimizing exposure is the primary purpose of the IC, it is EPA's policy that if a site cannot support "unlimited use and unrestricted exposure" (EPA, 2000f), ICs are generally required. The "unlimited use and unrestricted exposure" threshold is a site-specific determination similar to that of a five-year review. Essentially, if contamination could result in an unacceptable exposure, ICs would be

required. This is often the case at lead cleanups because residual contamination is frequently managed onsite. Note that the term "residential" is often used interchangeably with the "unlimited use and unrestricted exposure" threshold but these are not synonymous terms. For example, a lead cleanup where the top layer of soil has been removed and replaced can result in a residential use at a site that includes restrictions (e.g., restrictions on digging, requirements for elevated gardens, and an information/outreach program, etc.).

The second common purpose of an IC is to protect the integrity of a remedy. In the lead clean-up context this may mean using institutional controls to prevent penetration of a cap or damage to monitoring equipment. An important consideration in this context is what type of IC will provide the required remedy protection. For example, the primary concern for protecting a remedy in a lead clean-up scenario is typically uncontrolled excavation. For this reason it is important to select ICs that will be relevant to excavators. Examples of potentially effective ICs are local digging or drilling permits and "One-Call" or "Miss Utility" systems. Examples of potentially ineffective ICs are deed notices, because excavators seldom check land records prior to digging.

To better understand the correct IC approach, it is important to understand what tools are available. In general, there are four categories of ICs commonly used in cleanups: governmental controls, proprietary controls, enforcement and permit tools with IC components, and informational devices. The definitions provided below were taken in large part from the current EPA guidance (EPA, 2000f).

Governmental controls are usually implemented and enforced by a state or local government. Some of the more common examples include things like zoning restrictions, building/excavation permits, groundwater drilling and use permits, ordinances, or other provisions that restrict land or resource use at a site. These types of mechanisms are popular in remedies because the administrative processes are in place and are typically well understood within a particular jurisdiction. The greatest concern with this type of control is that it is often implemented, monitored, and enforced by an agency other than EPA or the state.

Proprietary controls are unique in that they have their basis in real property law and that they generally create legal property interests. An example of this type of control is an easement that provides access rights to a property so that an agency may inspect and monitor a cover system. A proprietary control may also be used to restrict certain activities on the property, such as excavating below a certain depth. These are powerful tools in that they can be made to "run-with-the-land" (i.e., effective if ownership changes), but they provide significant challenges because property interests are often transferred. EPA is limited by CERCLA §104(j) with regard to acquiring interests in real property. Prior to acquiring an interest in real property the state must provide an assurance that it will accept transfer of

that interest at completion of the remedial action. This requirement applies at both Fund-lead and enforcement-lead sites. Therefore, if a proprietary control involves the transfer of an interest in real property, EPA must obtain this assurance and find an appropriate entity to hold the interest following the remedial action. At Fund-lead sites this will most likely be the state. At enforcement sites, it may be the state, a PRP, or some other interested and qualified party. In addition, proprietary controls are based on state law, and EPA and many state environmental agencies have limited real estate or common law experience. This can complicate proprietary control enforcement.

Enforcement and permit tools with IC components under CERCLA Sections 104 and 106(a) include unilateral administrative orders (UAOs) and AOCs, which can be issued or negotiated to compel the land owner to limit certain site activities at both federal and private sites. In addition, CERCLA 122(d) authorizes the use of consent decrees at privately-owned sites. Enforcement devices are some of the more common ICs. The strength of these types of tools is that EPA or states can directly enforce them (rather than relying on a local agency for governmental controls or using real estate common law for proprietary controls). The major weakness is that they may be enforceable only against the signatory, recipient, or permittee (i.e., may not run with the land to bind future property owners).

<p>Unilateral Administrative Order (UAO) – When EPA negotiates with a Potentially Responsible Party (PRP) to do cleanup work at a Superfund site, the agreement may be documented in an administrative order on consent (AOC). If the negotiations fail, EPA has the authority to compel the PRP to do the cleanup by issuing a unilateral administrative order (UAO). Administrative orders are issued under CERCLA sections 104 and 106.</p>
--

Informational devices are types of devices that only provide information or notification that residual or capped contamination may remain on-site. These types of tools are common at lead cleanups to both provide notification of residual contamination and to provide information that may modify behavior to minimize the potential for unacceptable exposure. Examples include placing a property on a state contaminated properties registry, developing deed notices, and providing periodic lead-education advisories to residents. Due to the nature of informational devices and their non-enforceability, it is important to carefully consider the objective of this category of ICs. Informational devices are most likely to be used as a secondary "layer" to help ensure the overall reliability of other ICs.

There is typically an inverse relationship between the amount of cleanup and the degree of reliance on ICs (i.e., the more cleanup, the less reliance on ICs). EPA tends to focus on a number of considerations when evaluating the long-term viability and amount of redundancy required for ICs at a particular site. EPA guidance strongly advocates the use of ICs in "layers" and/or in "series" (EPA, 2000f). Layering ICs means using multiple ICs concurrently (e.g., a consent decree, deed notice, educational/informational devices and a covenant). Using ICs in series is appropriate when IC

mechanisms are removed or changed as site circumstances change, such as reduction in restrictions during the clean-up life-cycle. As illustrated in the descriptions of the different categories of ICs, there are inherent strengths and weaknesses with each type. The goal is to obtain the best mixture of ICs to manage the risk at a site over the long-term. There are many important factors to consider when determining how many ICs are required at a site. The following is not intended to be a comprehensive list, but rather illustrative of the site-specific nature of these types of decisions. A few common considerations include: (1) the type of enforcement mechanism used (consent decree, order, permit, ordinance); (2) who will enforce the mechanism (i.e., EPA, the state, local agency, third party, etc.); (3) who the intended IC will effect and how; (4) the level of sophistication of the party implementing the cleanup and those remaining on the property; (5) the expected property use (likelihood of redevelopment and/or resale); and (6) the degree of cooperation exhibited by the parties to the cleanup. Since ICs can impact future development at sites, it is important to work cooperatively to determine the appropriate mix of ICs. The objective is not to use as many layers of ICs as possible, but rather to strike a balance that gives the regulators the certainty that the site remedy will be protective over time while maximizing the site's future beneficial use.

At many large lead sites, GIS systems are used to track the cleanup status of properties located on the site. The tracking system facilitates the monitoring of ICs and the maintenance of the remedy. GIS systems can be operated by local governments, state governments or PRPs.

6.8 CLEAN-UP DOCUMENTATION

Upon confirmation that initial yard sampling indicates a given residential yard does not exceed the lead clean-up level for the site, or upon the completion of the cleanup of a residential yard, a letter (“clean” letter) should be sent to the property owner documenting that EPA considers the lead level in the yard to be below the level of human health concern. Prior to issuing a “clean” letter, a property closeout form should be signed by the property owner, which documents the owner is satisfied with the remediation of the property. Examples of property closeout forms are provided in Appendix G. Any areas that are not cleaned up via the owner’s request, such as gardens, should be noted in the “clean” letter. If contamination is not cleaned up to depth, this fact, along with protections (i.e., barriers/markers) that are put in place, should be stated in the “clean” letter. The “clean” letter provides official documentation to the property owner for use in future property sales or transactions. Sample “clean” letters are provided in Appendix H.

6.9 ENFORCEMENT

The project manager should strive to characterize all residences within the identified zone of contamination, and achieve cleanup at all residences where lead concentrations exceed the clean-up level. At all residential clean-up sites, a percentage of homeowners typically will refuse to grant access to EPA for sampling and/or for cleanup. In order to meet remedial goals of protecting a community, all residences suspected of being located within a zone of contamination should be sampled. It is important to work with the landowner and be sensitive to a landowner's concerns regarding property access. The project manager should educate the landowner of the dangers that lead contamination may pose. If a landowner still refuses to grant access, the Region should consider issuing an access order for sampling (EPA, 1990c).

An owner of residential property on a Superfund site may be potentially liable under CERCLA § 107(a)(1). However, EPA, as an exercise of enforcement discretion, generally will not take CERCLA enforcement actions against an owner of residential property unless the residential homeowner's activities lead to a release or threat of release of hazardous substances resulting in the taking of a response action at a site. (See [Policy Towards Owners of Residential Property at Superfund Sites](#) (July 3, 1991)). Additionally, under CERCLA a residential property owner may qualify for protection from CERCLA liability as a contiguous property owner, bona fide prospective purchaser, or innocent landowner. Under both the statute and EPA's policy, a residential property owner is expected to cooperate with EPA and the person taking the response action. This obligation includes providing access and information as requested, agreeing to comply with land use restrictions relied on in connection with the remedy, and not impeding the effectiveness the effectiveness or integrity of institutional controls. (See CERCLA §§ 101(40)(B)-(H), 107(q)(1)(a), 101(35)(A)-(B)). The project manager should work to inform and educate an owner of EPA's expectations for cooperation in connection with the remedy. If necessary, to meet the commitments of the remedy, EPA should consider taking appropriate steps, such as issuing a UAO, to secure the cooperation of an uncooperative landowner.

If some properties are not addressed under site response actions (e.g., current homeowners with no young children or women of child-bearing age), then consideration should be given to establishing a trust fund (under state authority or local law), to be administered by a local government, for the cleanup of the property at a future date, when the property is transferred (e.g., by sale) to a new owner (see text box). Buyers of contaminated properties could make use of the fund to have the property cleaned up at their discretion.

Example Trust Fund – At the Bunker Hill Superfund Site, a number of property owners refused to have their residential yards cleaned up. Without any obvious need to cleanup the property right away, e.g. an unpaved, contaminated driveway that threatens to recontaminate the neighborhood or a child living at the residence or next door, the PRPs for the site were willing to give the State funds to set aside in an interest bearing account to clean up the properties in the future, when the property changes hands. Property status is then monitored by the local Health District as part of the institutional controls program. The State then manages the funds to ensure maximum interest accrual in an irrevocable trust and disbursement according to the limitations set up in the trust -- for residential property cleanup. Cleanup then occurs under State oversight at the time new owners buy the property thereby ensuring families with children that move into the community are protected.

In the case of rental properties, EPA should order access for cleanup by UAO to all owners of contaminated rental property who refuse access. To ensure the protection of occupants, enforcement of the UAO may be necessary to clean up all rental properties with contamination greater than the clean-up level.

7.0 FIVE-YEAR REVIEW

Five-Year Review – Pursuant to section 121 of CERCLA and the NCP, remedial actions which result in any hazardous substances, pollutants, or contaminants remaining at the site above levels that allow for unlimited use and unrestricted exposure need to be reviewed every five years to ensure protection of human health and the environment.

CERCLA §121(c) requires an assessment of certain remedial actions every five years on sites where contamination has been left on site (EPA, 2000a). Guidance for conducting five-year reviews has been issued (EPA, 2001h). The purpose of a five-year review is to evaluate the performance of a remedy to determine if the remedy continues to be protective of human health and the environment.

Typically, at large lead sites, such as mining and smelting sites, the volume and areal extent of contamination is such that total removal of all contamination above the health-based risk level is economically impractical. Contaminated wastes are generally left on site and covered with soil. The remedy for these types of sites typically includes some type of IC to address residual or encapsulated contamination. A five-year review can determine whether the remedy is stable (i.e., soil covers are undisturbed, and clean areas are not being recontaminated from sources remaining on the site). The review should also assess the ICs that were established for residual source control to determine their effectiveness in protecting human health. As described below, the five-year reviews at large lead sites may involve the collection and evaluation of substantial quantities of data and require significant up-front planning. Much of the following discussion may not apply to small sites.

At many sites, an exposure study has been performed prior to any clean-up activities to determine blood lead concentrations of children in the community. A follow-up exposure study of residents should be conducted during the five-year review to determine if the concentrations have decreased below levels of concern. If the blood lead concentrations have not decreased to acceptable levels, additional environmental studies and individualized, follow-up exposure investigations should be conducted to determine the pathways of exposure that may need to be addressed. Long-term exposure studies can be very useful in understanding exposure trends at a site. They also can be useful to ensure that no pathways of exposure have been missed and to help identify areas of the site that have been recontaminated. In this manner, the project manager can use health data as a means to “double check” the effectiveness of the remedy and to corroborate environmental data. However, blood lead data from limited sampling should not be used as the only metric for gauging the success of a remedy, even if it can be used to identify specific problems. The project manager should coordinate with ATSDR and the local health district with respect to planning and funding such a program.

The five-year review should include resampling at a percentage of each type of property that was remediated during the clean-up actions. A baseline level of resampling should be designed to achieve a

pre-specified level of statistical significance and power. This sampling should assess the potential for recontamination that may be occurring, and may help identify any pathways that may have been missed during remediation. Any sampling that indicates widespread or clusters of soil levels above clean backfill concentrations should be monitored over time to determine if an upward trend exists that may jeopardize the remedy.

Additionally, some level of house dust sampling should occur to determine if levels are rising or falling. House dust, being a primary exposure pathway, should be used as one indicator of remedy effectiveness and also used to detect the presence of recontamination. Lead concentrations in house dust levels often correlate to interior LBP, which is not usually addressed by Superfund (Appendix B). Therefore, interior paint sampling should also be conducted as a component of the risk assessment to aid in determining the source of the lead loading to dust.

At large lead sites, remedy protectiveness issues will often relate to the implementation and management of ICs and recontamination of areas previously cleaned. The five-year review should evaluate the effectiveness of the site ICs and recommend corrections to address any deficiencies that are identified. In order for a five-year review to be effective at sites where ICs are a component in ensuring the effectiveness of the remedy, there should be: (1) clear documentation of the specific type of ICs that were to be implemented, and (2) accurate and complete tracking of subsequent activities and changes in property use following completion of the Superfund remedy.

The following are possible deficiencies for several types of commonly-used ICs and other control measures taken to ensure the protectiveness of the remedy:

- C HEPA vacuum loan program not being broadly used.
- C Information on interior home cleaning not being widely distributed.
- C Lack of access control along rights-of-way, and in unremediated areas.
- C Inadequate decontamination of vehicles leaving areas of existing contamination.
- C Erosion of unremediated areas onto remediated properties.
- C Lack of or inadequate disposal area for snow (that contains contaminated soil).
- C Lack of drainage infrastructure and maintenance by local entities.
- C Uncontrolled utility excavation in areas with contamination at depth.
- C Inadequate road maintenance in areas where contamination exists at depth.
- C Inadequate disposal capacity to handle IC-generated wastes.
- C Discontinuation of, or diminishing, health education program.
- C Decrease of blood lead monitoring.
- C Complicated/unfounded ICs and/or change in local government acceptance of ICs.

8.0 FEDERAL FACILITIES

The purpose of this section includes the following: (1) to provide direction to EPA federal facility project managers who oversee response actions involving lead contamination of soils from LBP in residential areas of federal facilities; (2) to build and elaborate on the joint March 1999 EPA and DOD Principles Memorandum (DOD/EPA, 1999a) and the December 1999 Lead-Based Paint Interim Field Guide (DOD/EPA, 1999b); (3) to address situations where the DOD service component will conduct the response actions and the regulatory agencies will provide oversight; and (4) to address the unique considerations that arise when the federal government transfers LBP-contaminated property that is subject to CERCLA §120(h) to non-federal parties (e.g., states, local governments, local reuse authorities [LRAs], and private entities, etc.).

While existing policy, guidance, and directives on lead contamination are applicable at federal facilities, property transfer issues present unique requirements that necessitate this section. This section applies to properties that will be transferred for residential use which are contaminated with lead due to LBP or to properties/parcels whose use would expose sensitive populations (e.g., infants, toddlers, small children, nursing mothers) to unacceptable exposure to lead after the properties are transferred to non-Federal entities.

Beginning in 1995, EPA and DOD began to address policy differences on the clean-up levels for lead in soils from LBP. In 1998, Sherri Goodman, then Deputy Under Secretary of Defense (Environmental Security) and Tim Fields, Assistant Administrator for OSWER, reached agreement on the management of LBP at residential and non-residential areas at BRAC properties. In March 1999, this agreement was formalized as the 'Principles Memorandum' (DOD/EPA, 1999a). The Principles Memorandum stated that for residential areas located on BRAC sites, Title X procedures provide an efficient, effective, and legally adequate framework for addressing LBP in residential areas, and that as a matter of policy, CERCLA/RCRA would apply in limited circumstances. EPA and DOD agreed that generally for residential areas that were being transferred, Title X regulations would apply and that CERCLA/RCRA would apply in limited circumstances. Residential real property is defined by Title X as real property on which there is situated one or more residential dwellings used or occupied, in whole or in part, as the home or residence of one or more persons. It is important to note that Title X defines residential property differently than the Handbook.

For federal property transfers subject to CERCLA where there is a concern about lead contamination to soils from LBP, EPA Regions, where they are involved, will need to make a determination whether the property meets the requirements of CERCLA §120(h)(3). This section of CERCLA outlines deed requirements for transferring property and requires covenants indicating that all

remedial actions have been taken at the site. Federal property contaminated with lead from LBP should be evaluated based on its use, or its intended reuse, before the property has been sold or transferred to another private entity. EPA's evaluation of the transfer should be based on an evaluation of lead contamination by either relying on existing and available information gathered through a combination of file searches and a review of existing data and/or a site risk assessment, which may require the collection and analysis of additional soil samples.

The soil sampling design should be specific to the site. The actual or suspected presence of lead contamination in soil does not necessarily require sampling. Factors to be considered before designing a sampling plan include, but are not limited to, the nature of the facility's operations, its operating records, the age of the buildings/structures under consideration, the maintenance schedule for the buildings/structure, visual inspection, and future use. Based on these factors, it may be reasonable to conclude that the potential risks posed by lead may be acceptable and no further evaluation is needed. It may also be important to consider the ultimate disposition of the property once it leaves federal control. For example, the structures may be scheduled to be demolished, so that the abatement of the hazard may be addressed in the demolition process and may negate the need to conduct clean-up activities.

The EPA project manager and, as appropriate, an EPA risk assessor should work with their federal, state, and local government counterparts to develop a sampling design, where required, that would be scientifically appropriate, minimize the cost of sampling, and provide the information required for risk management decisions. As appropriate, the local redevelopment or reuse authority should be consulted as well. Information from the sampling effort could result in different outcomes: a "no further action decision", a conclusion that more extensive sampling is necessary, or, in some cases, a response action. All of these potential outcomes should be discussed with the lead federal agency, and others as appropriate, prior to the initiation of sampling.

If there is insufficient knowledge to make a conclusion about the risk at the site or if the initial sample results indicate an unacceptable risk from lead, data may be collected by a focused sampling of an environmental media to develop an improved understanding of the risk that may be posed by the lead exposure. It may be appropriate to determine that after visual inspection and/or focused sampling, and after consultation with an EPA risk assessor, the lead from the area may not pose a significant risk that requires further evaluation. Risk evaluations should be based upon a number of factors including the reasonably anticipated future land use, exposure potential, ICs proposed or in place, and bioavailability. The Handbook user is encouraged to obtain detailed information on ICs for federal facilities in the document "Institutional Controls and Transfer of Real Property under CERCLA Section 120(h)3(A), (B), or (C)" (EPA, 2000g).

If the property has been used or will be reused as residential real property after transfer, the EPA project manager should verify that the lead federal agency has followed the Title X regulations and policies regarding sampling and risk assessment. As a guide to assist site managers in understanding Title X regulations and policies, EPA and DOD jointly issued a Field Guide (DOD/EPA, 1999b) that is used by EPA and DOD field personnel when assessing hazards due to LBP. The field guide contains information on performing a Title X paint inspection and risk assessment and outlines the requirements for abating soil contaminated by LBP

The Title X program, through the implementation of the new Title IV of TSCA, establishes certification programs and work practice standards to regulate LBP hazard evaluation and abatement in target housing and child-occupied facilities. There are two types of evaluations covered by Title X. The first evaluation is a paint inspection that includes a surface-by-surface inspection to determine the presence of LBP. All painted surfaces with distinct painting histories are sampled. Usually the paint inspection is done by a combination of portable XRF devices and paint chip sampling.

The second evaluation is a risk assessment to determine if LBP hazards exist. A risk assessment includes taking samples of all deteriorating paint, dust, and soil. The final report recommends methods to deal with all LBP hazards that were found, which could include interim controls or abatement. A comprehensive evaluation consists of a combination of a paint inspection and risk assessment. Paint inspections and risk assessment conducted in accordance with Title X must be performed by certified personnel. All results, whether positive or negative, must be disclosed at the time of sale or rental.

The final TSCA 403 regulation (EPA/HUD, 2001), defines a soil-lead hazard as bare soil on residential real property, or on property of a child-occupied facility, that contains concentrations of lead equal to or exceeding 400 ppm in the play area or an average of 1,200 ppm in the rest of the yard. EPA and DOD have agreed that as a matter of policy, for bare soil with lead concentration between 400 ppm and 1,200 ppm, the Service, in consultation with the EPA, has the option of abatement or interim controls. Based on the final HUD 1012/1013 regulations (24 CFR Part 35) (HUD, 2001), federal agencies can transfer the control and abatement requirements to the purchaser, but by law the federal agency is responsible for performing the LBP inspection and risk assessment and must assure that through contractual mechanisms, the purchaser has performed the abatement of the soil in accordance with Title X.

In cases where the EPA project manager makes a determination that actions taken to address LBP hazards are sufficient (following the requirements outlined in the Field Guide), EPA should agree with the federal agency on the transfer documents and the covenant that all remedial action necessary to protect human health and the environment with respect to any such substances remaining on the property has been taken before the date

Finding of Suitability to Transfer (FOST) – A process that has been established to identify and prepare property for transfer by deed. Such transfers are usually undertaken at a property where environmental response is not needed or has been taken. However, under certain conditions, new authority now permits earlier transfer. The FOST process also looks at the compatibility of an anticipated reuse with completed restoration activities and identifies restrictions necessary to protect human health and the environment.

of such transfer . In the case of BRAC sites, the EPA project manager can agree on the Findings of Suitability to Transfer (FOST) or Findings of Suitability to Lease (FOSL) language, and/or the operating properly and successfully (OPS) determination as required by CERCLA. When an EPA project manager

Finding of Suitability to Lease (FOSL) – A process that has been established for leasing of property that cannot be transferred by deed because environmental restoration activities are still ongoing. The FOSL process also looks at the compatibility of a proposed reuse with ongoing restoration activities and identifies restrictions necessary to protect human health and the environment and prevent interference with the cleanup.

has unresolved questions as to whether actions at residential areas meet the requirements of CERCLA, she/he should raise these issues to the federal agency and provide an opportunity for response. In the case of BRAC sites, it is proper to highlight these concerns in EPA's comments on the FOST/FOSL. Efforts should be made to determine that the purchaser is fully aware that EPA has questions about the condition of the property.

REFERENCES

- American Society for Testing and Materials (ASTM). 1998. *Standard Test Method for Particle-Size Analysis of Soils*. D 422–63.
- Borgman, LE, Gerow, K and Flatman, GT., Cost-Effective Sampling for Spatially Distributed Phenomena. In *Principles of Environmental Sampling*, 2nd Ed. Keith, LH, ed. (American Chemical Society, 1996)
- Borgman, LE and Quimby, WF. 1996. Sampling for Tests of Hypothesis When Data are Correlated in Space and Time. In *Principles of Environmental Sampling*, 2nd Ed. Keith, LH, ed. (American Chemical Society, 1996)
- Carbone, R., N. Laforgia, E. Crollo, A. Mautone and A. Iolascon. 1998. Maternal and neonatal lead exposure in southern Italy. *Biol. Neonate* 73: 362–366.
- Centers for Disease Control and Prevention (CDC). 1991. Preventing Lead Poisoning in Young Children. October 1991. Centers for Disease Control, Atlanta, GA.
- Crumbling, D.M., C. Groenjes, B. Lesnik, K. Lynch, J. Shockley, J. Van Ee, R.A. Howe, L.H. Keith, and J. McKenna. 2001. Applying the concept of effective data to contaminated sites could reduce costs and improve cleanups. *Environmental Science and Technology* 35(9):405A–409A.
- Englund, E.J. and N. Heravi. 1994. Phased Sampling for Soil Remediation. *Env. Ecol. Stats* 1:247–263.
- Flatman, G.T. and A.A. Yfantis. 1984. Geostatistical Strategy for Soil Sampling: The Survey and the Census. U.S. EPA EMSL. *Env. Mon. Assess* 4:335–349.
- Gilbert, R.O. and Simpson, J.C. 1983. Kriging for Estimating Spatial Pattern Of Contaminants: Potential and Problems. *Environmental Monitoring and Assessment* Vol 4: 113–135.
- Gilbert, R.O. 1987. *Statistical Methods for Environmental Pollution Monitoring*. Van Nostrand Reinhold. New York, New York.
- Goovaerts, P. 1997. *Geostatistics for Natural Resources Evaluation*. Oxford University Press.
- Gayer, R.A. 1990. Transplacental transport of lead. *Environ. Health Perspect* 89:101–105.
- Graziano, J.H., D. Popovac, P. Factor-Litvak, P. Shrout, J. Kline, M.J. Murphy, Y. Zhao, A. Mehmeti, X. Ahmedi, B. Rajovic, Z. Zvicar, D. Nenezic, N. Lolacono and Z. Stein. 1990. Determinants of elevated blood lead during pregnancy in a population surrounding a lead smelter in Kosovo, Yugoslavia. *Environ. Health Perspect* 89:95–100.
- Idaho Department of Health and Welfare and Agency for Toxic Substances and Disease Registry, Division of Health Assessment and Consultation. 2000. Coeur d'Alene River Basin Environmental Health Assessment. Atlanta, GA.
- Journel, A.G. 1984. Indicator Approach to Toxic Chemical Sites; Report of Project No. CR-811235-02-0. U.S. Environmental Protection Agency, Las Vegas, NV.
- Mushak, P. 1998. Uses and limits of empirical data in measuring and modeling human lead exposure. *Environ Health Perspect* 106 Suppl 6:1467–84.

- National Research Council (NRC) Committee on Measuring Lead in Critical Populations, 1993.
- Quimby, W.F. 1986. Selected Topics in Spatial Statistical Analysis: *Nonstationary Vector Kriging, Large Scale Conditional Simulation of Three Dimensional Gaussian Random Fields, and Hypothesis Testing in a Correlated Random Field*. PhD Thesis. University of Wyoming, Laramie. December.
- Ryti, R.T. 1993. Superfund Soil Cleanup: Developing the Piazza Road Remedial Design. *J. Air Waste Manage. Assoc* 43:197–202.
- Snedecor, G.W. and Cochran, W.G. 1989. *Statistical Methods*. Iowa State University Press. Ames, Iowa.
- Syracuse Research Corporation (SRC). 1999. *Assessment of Background Lead Concentrations for the Coeur d'Alene, Idaho River Basin Common Use Areas Risk Assessment Report*. Prepared for U.S. EPA Region 10 under Subcontract No. SE-98-A-713. SRC TR-99-001.
- TerraGraphics. 1997a. PanHandle Health District Institutional Controls Program Sampling Plan for Soil Piles and Excavations. November.
- TerraGraphics. 1997b. PanHandle Health District Institutional Controls Program Sampling Plan for Gravel Sources. November.
- TerraGraphics. 2000. *Final 1999 Five Year Review Report - Bunker Hill Superfund Site*. April.
- TerraGraphics. 2001. *Data Summary Report for Six-Month Sampling Results, House Dust Pilot Project 2000*. August.
- U.S. Department of Defense/U.S. Environmental Protection Agency (DOD/EPA). *Memorandum, Subject: Management of Lead-Based Paint in Residential and Non-Residential Areas at Base Realignment and Closure (BRAC) Properties*. March 17. 1999a.
- U.S. Department of Defense (DOD)/U.S. Environmental Protection Agency (EPA). *Department of Defense and the Environmental Protection Agency Lead-Based Paint Guidelines for Disposal of Department of Defense Residential Real Property-A Field Guide*. Interim Final. December 1999b.
- U.S. Department of Housing and Urban Development (HUD). Housing and Community Development Act of 1992. *Title X Residential Lead-Based Paint Hazard Reduction Act of 1992*. Public Law 102-550. U.S. Housing and Urban Development. Washington, D.C. 1992.
- U.S. Department of Housing and Urban Development (HUD). *Guidelines for the Evaluation and Control of Lead-Based Paint Hazards in Housing*. June. 1995.
- U.S. Department of Housing and Urban Development (HUD). *Lead-Based Paint Poisoning Prevention in Certain Residential Structures*. 24 CFR Part 35.
Available online: <http://www.access.gpo.gov/nara/cfr/cfr-table-search.html>. 2001.
- 1986 U.S. EPA**
U.S. Environmental Protection Agency (EPA). *Air Quality Criteria for Lead Volume I-IV*. Environmental Criteria and Assessment Office, Office of Research and Development, RTP, NC. EPA/600/8-83-028. 1986.
- 1988 U.S. EPA**
U.S. Environmental Protection Agency (EPA). *CERCLA Compliance with Other Laws Manual: Interim Final*. Office of Emergency and Remedial Response, Washington, DC. EPA 540-G-89-006. August 1988.

1989 U.S. EPA

U.S. Environmental Protection Agency (EPA). *Human Health Evaluation Manual, Part A, Risk Assessment Guidance for Superfund, Volume I, Interim Final*. Office of Emergency and Remedial Response, Washington, DC. EPA/540/1-89/002. 1989.

1990 U.S. EPA

U.S. Environmental Protection Agency (EPA). *Report of the Clean Air Act Scientific Advisory Committee on its Review of the OAQPS Lead Staff Paper and the ECAO Air Quality Criteria Document Supplement*. EPA-SAB-CASAC-90-002. January 1990a.

U.S. Environmental Protection Agency. *National Oil and Hazardous Substances Pollution Contingency Plan*. Final Rule. 40 CFR 300.55 Federal Register, 8666–8865, March 8. Washington, DC. 1990b.

U.S. Environmental Protection Agency. *OSWER Directive 9833.0-1a: Guidance on CERCLA Section 106(a) Unilateral Administrative Orders for Remedial Designs and Remedial Actions*. (March 1990). Available online: <http://www.epa.gov/compliance/resources/policies/cleanup/superfund/cerc106-uao-rpt.pdf>. 1990c

1992 U.S. EPA

U.S. Environmental Protection Agency (EPA). Community Relations. 40 CFR 300.430(c)(2)(iv). 1992.

1994 U.S. EPA

U.S. Environmental Protection Agency (EPA). *OSWER Directive: Revised Interim Soil Lead (Pb) Guidance for CERCLA Sites and RCRA Corrective Action Facilities*. EPA/540/F-94/043 PB94-963282. (August 1994). Available online: <http://www.epa.gov/superfund/programs/lead/products/oswerdir.pdf>. 1994a.

U.S. Environmental Protection Agency (EPA). *Guidance Manual for the Integrated Exposure Uptake Biokinetic Model for Lead In Children*. EPA/540/R-93/081 PB93-963510, (February 1994). 1994b.

1995 U.S. EPA

U.S. Environmental Protection Agency (EPA). *Land Use in the CERCLA Remedy Selection Process*. May. OSWER Directive 9355.7-04. 1995a.

U.S. Environmental Protection Agency (EPA). *Guidance for Community Advisory Groups at Superfund Sites*. December. OSWER Directive 9230.0-28 PB94-963293 EPA 540-K-96-001. Available online: <http://www.epa.gov/superfund/tools/cag/resource.htm>. 1995b.

U.S. Environmental Protection Agency (EPA). Engineering Forum Issue: Determination of Background Concentrations of Inorganics in Soils and Sediments at Hazardous Waste Sites. Office of Research and Development. EPA/540/S-96/500. 1995c.

1996 U.S. EPA

U.S. Environmental Protection Agency (EPA). *Record of Decision. Bunker Hill Mining & Metallurgical Complex*. Shoshone County, Idaho. Office of Emergency and Remedial Response. Washington, DC. 1996a.

U.S. Environmental Protection Agency (EPA). *Urban Soil Lead Abatement Demonstration Project, Vol. I: Integrated Report*. Office of Research and Development. 1996b.

U.S. Environmental Protection Agency (EPA). *Soil Screening Guidance*. July. Pub 9355.4-23. Available online: <http://www.epa.gov/superfund/resources/soil/ssg496.pdf>. 1996c.

U.S. Environmental Protection Agency (EPA). Region 1, EPA-New England. *Standard Operating Procedure for Elemental Analysis Using the X-MET 920 Field X-RAY Fluorescence Analyzer*. Available online: <http://www.epa.gov/NE/measure/xray/xrayfluor.html>. 1996d.

1997 U.S. EPA

U.S. Environmental Protection Agency (EPA). *Record of Decision. Tar Creek. Ottawa County, Oklahoma*. Office of Emergency and Remedial Response. Washington, DC. 1997a

U.S. Environmental Protection Agency (EPA). *Lead Site Response Decisions: Formation of the Lead Sites Consultation Group*. Memo from Steve Luftig dated May 29, 1997. 1997b.

U.S. Environmental Protection Agency (EPA). *OSWER Directive 9200.1-18FS: Consolidated Guide to Consultation Procedures for Superfund Response Decisions*. EPA/540-F-97-009. May 1997. 1997c.

U.S. Environmental Protection Agency (EPA). *Rules of Thumb for Superfund Remedy Selection*. August. EPA 540-R-97-013 OSWER Directive 9285.6-07,P PB97-963301. Available online: <http://www.epa.gov/superfund/resources/rules/>. 1997d.

U.S. Environmental Protection Agency (EPA). *Best Management Practices (BMPS) for Soil Treatment Technologies: Suggested Guidelines to Prevent Cross-Media Transfer of Contaminants During Clean-Up Activities*. EPA 530/R97/007. 1997e.

1998 U.S. EPA

U.S. Environmental Protection Agency (EPA). *OSWER Directive: Clarification to the 1994 Revised Interim Soil Lead (Pb) Guidance for CERCLA Sites and RCRA Corrective Action Facilities*. EPA/540/F-98/030, OSWER Directive 9200.4-27P, PB98-963244. (August 1998). Available online: <http://www.epa.gov/superfund/programs/lead/products/oswer98.pdf>. 1998a.

U.S. Environmental Protection Agency (EPA). *Test Methods for Evaluating Solid Waste, Physical/Chemical Methods*. Vol IA, SW-846, Method 6200, Revision 0, January. 1998b.

U.S. Environmental Protection Agency (EPA). *Short Sheet: IEUBK Model Mass Fraction of Soil in Indoor Dust (M_{SD}) Variable (June 1998)*. EPA #540-F-00-008, OSWER #9285.7-34. Available online: <http://www.epa.gov/oerrpage/superfund/programs/lead/products/ssmsdcol.pdf>. 1998c.

1999 U.S. EPA

U.S. Environmental Protection Agency (EPA). *Protect Your Family From Lead in Your Home*. EPA 747-K-99-001. April 1999a.

U.S. Environmental Protection Agency (EPA). *Interim Policy on the Use of Permanent Relocations as Part of Superfund Remedial Actions*. (June 1999). EPA #540-F-98-033, OSWER #9355.0-71P. Available online: <http://www.epa.gov/oerrpage/superfund/tools/topics/relocation/index.htm>. 1999b.

2000 U.S. EPA

U.S. Environmental Protection Agency (EPA). *Comprehensive Environmental Response, Compensation, and Liability*. 42USC103. Section9621(c). Washington, DC. 2000a.

U.S. Environmental Protection Agency (EPA). *Grants for Technical Assistance*. 40 CFR Part 35, Subpart M. Available online: <http://www.epa.gov/superfund/tools/tag/resource.htm>. 2000b.

U.S. Environmental Protection Agency (EPA). *Short Sheet: TRW Recommendations for Sampling and Analysis of Soil at Lead (Pb) Sites (April 2000)*. EPA #540-F-00-010, OSWER #9285.7-38. Available online: <http://www.epa.gov/oerrpage/superfund/programs/lead/products/sssiev.pdf>. 2000c.

U.S. Environmental Protection Agency (EPA). *Guidance for the Data Quality Objectives Process*. EPA QA/G-4. U.S. Environmental Protection Agency. Washington, D.C. 2000d.

U.S. Environmental Protection Agency (EPA). *Bunker Hill Populated Areas Operable Unit First Five Year Review Report*. Volume I, Seattle, WA. September 27, pp. 48. 2000e.

U.S. Environmental Protection Agency (EPA). *Institutional Controls: A Site Manager's Guide to Identifying, Evaluating and Selecting Institutional Controls at Superfund and RCRA Corrective Action Cleanups*. September 29. EPA 540-F-00-005, OSWER Directive 9355.0-74FS-P. Available online: <http://www.epa.gov/oerrpage/superfund/action/ic/guide/guide.pdf>. 2000f.

U.S. Environmental Protection Agency (EPA). *Institutional Controls and Transfer of Real Property under CERCLA Section 120(h)3(A), (B), or (C)*. February 2000. Available online: http://www.epa.gov/swerffrr/documents/fi-icops_106.htm. 2000g.

2001 U.S. EPA

U.S. Environmental Protection Agency (EPA). *Lead; Identification of Dangerous Levels of Lead*; Final Rule. FR Vol. 66 No. 4. January 5. Available online : http://www.epa.gov/lead/403_final.pdf. 2001a.

U.S. Environmental Protection Agency (EPA). *Reuse Assessments: A Tool To Implement The Superfund Land Use Directive*. June. OSWER Directive 9355.7-06P. 2001b

U.S. Environmental Protection Agency (EPA). *Abandoned Mine Site Characterization and Cleanup Handbook*. Appendix E "X-Ray Fluorescence". EPA 530-R-01-002, March 2001. 2001c.

U.S. Environmental Protection Agency (EPA). *Integrating Dynamic Field Activities Into the Superfund Response Process: A Guide for Project Managers*. Draft Final. December. Available online: <http://www.epa.gov/superfund/programs/dfa/>. 2001d.

U.S. Environmental Protection Agency (EPA). *Field Analytical Technologies Encyclopedia (FATE)*. Accessed on December 17, 2001. Available online: <http://fate.clu-in.org/>. 2001e.

U.S. Environmental Protection Agency (EPA). *Site Assessment Guidance CD*. Available online: <http://www.epa.gov/oerrpage/superfund/sites/phonefax/descript/siteassess.htm>. 2001f.

U.S. Environmental Protection Agency (EPA). *Site Assessment Web Site*. Available online: <http://www.epa.gov/superfund/programs/siteasmt/index.htm>. 2001g.

U.S. Environmental Protection Agency (EPA). *Comprehensive Five-Year Review Guidance*. EPA 540-R-01-007. OSWER Directive 9355.7-03B-P. June. Available online: <http://www.epa.gov/oerrpage/superfund/sites/phonefax/descript/siteassess.htm>. 2001h.

U.S. Environmental Protection Agency (EPA). *Guidance for Characterizing Background Chemicals in Soil at Superfund Sites. External Review Draft*. EPA 540-R-01-003. OSWER Directive 9285.7-4-1. June. Available online: <http://www.epa.gov/superfund/programs/risk/background.pdf>. 2001i.

2002 U.S. EPA

U.S. Environmental Protection Agency (EPA). *Role of Background in the CERCLA Cleanup Program*. April 26. OSWER Directive 9285.6-07P. Available online: <http://www.epa.gov/superfund/programs/risk/role.pdf>. 2002.

von Lindern, I. and Spalinger, S. *Memorandum to Lead Remediation Review Group Regarding Interim Preventative Risk Management Activities Dust Mat Monitoring Proposed Protocol*. TerraGraphics. September 14. 2001.

APPENDIX A

TITLE X AND EPA'S TOXIC SUBSTANCES
CONTROL ACT (TSCA) TITLE IV LEAD PROGRAM

TITLE X AND EPA'S TOXIC SUBSTANCES CONTROL ACT (TSCA) TITLE IV LEAD PROGRAM

Background

The Housing and Community Development Act of 1992 (PL102-550) contained Title X the "Residential Lead-Based Paint Hazard Reduction Act of 1992" (HUD, 1992). Even though this was a U.S. Department of Housing and Urban Development (HUD) authorization bill, it established a series of requirements for EPA. Title X includes a new Title IV of the Toxics Substances Control Act (TSCA). The sections that address EPA alone have section numbers in the four hundred (400) series, such as Section 403, Health Based Standards, whereas the HUD portions have numbers in the one thousand (1000) series, such as Section 1015, Task Force. There is one section, Section 1018, that Congress required both HUD and EPA to jointly issue a rule on disclosure.

Overview

Title X addresses LBP and LBP hazards and requires EPA and HUD to issue regulations to address those items. Title X's emphasis is on actual hazards such as deteriorating paint, lead in dust, or lead in soil versus potential hazards such as intact paint. Generally, Title X does not mandate inspections, risk assessments, abatements of LBP, or LBP hazards. The exceptions are HUD program related actions (Section 1012) or when a federal agency disposes of a property that will be used for residential purposes (Section 1013). However, if you choose to do an inspection, risk assessment, or abatement, Title X establishes certification requirements and work practice standards that must be followed. Title X requires disclosure at the time of sale or rental (Section 1018) and the provision of a brochure *Protect Your Family from Lead in Your Home* (EPA, 1999a), before rehabilitation (Section 406b). EPA may authorize state programs to operate in lieu of the federal program for the 400 series regulations but not Section 1018. See Appendix A for a full discussion of Title X.

Scope of Title X

Title X contains specific classes of structures that it regulates. The first category is "target housing", which is defined as "...any housing constructed prior to 1978 except housing for the elderly or persons with disabilities (unless any child who is less than 6 years of age resides or is expected to reside in such housing for the elderly or persons with disabilities) or any 0-bedroom dwelling."

The second category is "child occupied facilities", which are defined as "... a building or a portion of a building, constructed prior to 1978, visited regularly by the same child, 6 years of age or under, on at least two different days within any week (Sunday through Saturday period), provided that each day's visit lasts at least 3 hours and the combined weekly visit lasts at least 6 hours, and the combined annual visits last at least 60 hours. Child-occupied facilities may include, but are not limited to, day-care centers, preschools and kindergarten classrooms" (EPA, 2001a).

As of December 2001 target housing and child occupied facilities are the only classes of structures for which EPA has issued final regulations.

CERCLA 121(e)(1) exempts any response action conducted entirely on-site from having to obtain a federal, state, or local permit, where the action is carried out under §121. In general, on-site actions need to comply only with the substantive aspects of ARARs and not with the corresponding administrative requirements. Therefore, the administrative requirements laid out under TSCA 402 and 403 are not considered ARARs for actions conducted entirely on-site.

More Information

Section 405 requires EPA to establish a Hot Line and Clearing House for lead. This has been done and the National Lead Information Center's toll free number is 1-(800)-424-LEAD. Additionally the EPA web site at www.epa.gov/lead has all the rules, fact sheets, and guidance documents that the EPA Office of Pollution Prevention and Toxics has developed.

Description of the Sections of Title X

Title X Final Rules in Effect for ONLY Target Housing:

Section 1012. This section establishes the requirements for those who get assistance or mortgage insurance from HUD. The requirements are HUD program specific, but only pertain to those who are involved with a particular HUD program.

Section 1013. This section establishes the requirements for federal agencies that dispose of target housing that will be used for residential purposes.

Section 1018. Section 1018 requires that sellers and landlords disclose known LBP and LBP hazards and provide available reports to buyers and renters. Sellers and landlords must also provide a copy of *Protect Your Family from Lead in Your Home* (EPA, 1999a).

This is a joint rule between EPA and HUD. Section 1018 does not include "child occupied facilities"; EPA developed the concept of "child occupied facilities" under TSCA Title IV, the term is only in effect for TSCA four hundred (400) series rules.

TSCA Final Rules in Effect for ONLY Target Housing and Child Occupied Facilities:

Section 402/404 State Certification Programs establishes a nationally consistent federal Program for the certification of individuals and firms engaged in training, paint inspections, risk assessments, and certification of abatement workers, supervisors and training providers. There are two aspects of the program. States and tribes are encouraged to establish a program that as a whole, is at least as protective as EPA's federal program. The state programs can be more protective. When a state program is approved, it becomes the federal program in that state.

If the state or tribe does not establish an acceptable certification program, EPA operates the national program in that state. Much of the work is done in the EPA Regional Office. As of December 2001, 39 states, the District of Columbia, and 2 tribes have EPA authorized programs. Two states with large populations, which do not have authorized programs, are New York and Florida.

Section 403 establishes hazard standards for lead in paint, dust, and soil. Lead-based paint is a hazard if (1) it is deteriorated; (2) it is present on a friction surface that is subject to abrasion and the dust-lead levels on the nearest horizontal surface are equal to or greater than the applicable dust hazard standard; or (3) it is present on any chewable surface on which there is evidence of teeth marks. (Lead-based paint is statutorily defined as paint containing 1.0 milligram or more lead per square centimeter or 0.5% or more lead by weight.) Dust is a hazard if it contains 40 micrograms or more lead per square foot on floors or 250 micrograms or more lead per square foot on window sills. Soil is a hazard if it contains 400 parts per million or more in play areas or 1,200 parts per million or more in the rest of the yard.

This regulation also established the following clearance levels for interior dust: 40 micrograms lead per square foot for floors, 250 micrograms lead per square foot for window sills, and 400 micrograms lead per square foot for window troughs.

EPA's Section 403 rule was intended to prioritize risks as opposed to being inclusive of situations in which risks of concern exist. Per the rule preamble, "*The hazard standard in this TSCA rule was intended as a 'worst first' level that will aid in setting priorities to address the greatest lead risks promptly at residential and child-occupied facilities affected by lead-based paint*" (EPA, 2001a). While identification of lead hazards (as defined under TSCA) is a necessary part of the facility reuse process, a minimal approach that would insure only that the letter of the hazard standards are met may not protect against some important risks.

Section 405 establishes standards of environmental sampling laboratories. The National Lead Laboratory Accreditation Program (NLLAP) is administered by the American Industrial Hygiene Association and the American Association for Laboratory Accreditation. All laboratory samples must be analyzed by an NLLAP accredited laboratory.

Section 406b requires that the pamphlet *Protect Your Family from Lead in Your Home* (EPA, 1999a) be distributed no more than 60 days before a renovation in the home.

TSCA Rules Being Developed

Section 402. Renovation and remodeling requirements for target housing and child occupied facilities are being drafted as a proposed rule. Requirements for bridges and structures constructed prior to 1978 are being drafted for re-proposal. Both of these could include training, certification, and work practice standards.

Lead-based Paint Debris. This rule was not required by Title X, but the need was clearly there to treat portions of the debris from lead-based activities differently than the RCRA requirements. There are two categories of waste discussed. First is the paint chips and dust, sludges and filtercakes, wash water and contaminated and decontaminated protective clothing equipment that would continue to be subject to all the requirements of RCRA. Second is the "lead-based paint architectural component debris", which would be exempt from the Toxicity Characteristics rule including Toxicity Characteristic Leaching Procedure (TCLP) testing for lead only. This would allow disposal of these components at construction-demolition (CD) landfills.

Although the Pb Debris Rule is still being developed, in the interim, **EPA has issued a Memorandum that "Regulatory Status of Waste Generated by Contractors and Residents from Lead-Based Paint Activities Conducted in Households" - signed July 31, 2000.** This memo clarifies the regulatory status of waste generated as a result of LBP activities (including abatement, renovation activities, and remodeling) in homes and other residences. This memo explains why LBP generated by contractors in households is "household waste" and thus excluded from the RCRA Subtitle C hazardous waste regulations. The household exclusion applies only to waste generated by either residents or contractors conducting LBP activities in residences. As a result, LBP waste from residences can be discarded in a municipal solid waste landfill or a municipal solid waste combustor.

APPENDIX B

1998 OSWER Directive 9200.4-27P ('Clarification')

OSWER Directive # 9200.4-27P

MEMORANDUM**SUBJECT:** Clarification to the 1994 Revised Interim Soil Lead Guidance for CERCLA Sites and RCRA Corrective Action Facilities**FROM:** Timothy Fields, Jr.
Acting Assistant Administrator**TO:** Regional Administrators I-X**PURPOSE**

This directive clarifies the existing 1994 Revised Interim Soil Lead Guidance for CERCLA Sites and RCRA Corrective Action Facilities, OSWER Directive 9355.4-12. Specifically, this directive clarifies OSWER's policy on (1) using EPA's Science Advisory Board (SAB) reviewed Integrated Exposure Uptake Biokinetic Model (IEUBK) and blood lead studies, (2) determining the geographic area to use in evaluating human exposure to lead contamination ("exposure units"), (3) addressing multimedia lead contamination and (4) determining appropriate response actions at lead sites. The purpose for clarifying the existing 1994 directive is to promote national consistency in decision-making at CERCLA and RCRA lead sites across the country.

BACKGROUND

OSWER Directive 9355.4-12, issued on July 14, 1994 established OSWER's current approach to addressing lead in soil at CERCLA and RCRA sites. The existing directive established a streamlined approach for determining protective levels for lead in soil at CERCLA sites and RCRA facilities as follows:

- It recommends a 400 ppm screening level for lead in soil at residential properties;
- It describes how to develop site-specific preliminary remediation goals (PRGs) at CERCLA sites and media cleanup standards at RCRA Corrective Action facilities for residential land use; and,
- It describes a strategy for management of lead contamination at CERCLA sites and RCRA Corrective Action facilities that have multiple sources of lead.

The existing interim directive provides direction regarding risk assessment and risk management approaches for addressing soil lead contaminated sites. The OSWER directive states that, "... implementation of this guidance is expected to provide more consistent decisions across the country ...". However, since that directive was released, OSWER determined that clarification of the guidance is needed. Key areas being clarified by issuance of this directive include: (1) using the IEUBK model and blood lead studies, (2) determining exposure units to be considered in evaluating risk and developing risk management strategies, (3) addressing multimedia lead contamination and (4) determining appropriate response actions at residential lead sites. The existing directive provides the following guidance on these areas:

1. The OSWER directive recommends using the Integrated Exposure Uptake Biokinetic (IEUBK) Model for Lead in Children (Pub. # 9285.7-15-1, PB93-963510) for setting site-specific residential preliminary risk-based remediation goals (PRGs) at CERCLA sites and media cleanup standards (MCSs) at RCRA corrective actions Facilities. The directive states that the IEUBK model is the best tool currently available for predicting the potential blood lead levels of children exposed to lead in the environment. OSWER's directive also recommends the evaluation of blood lead data, where available, and states that well-conducted blood lead studies provide useful information to site managers. The directive however recommends that "... blood lead data not be used alone to assess risk from lead exposure or to develop soil lead cleanup levels."
2. The directive describes OSWER's risk reduction goal as "...generally, OSWER will attempt to limit exposure to soil lead levels such that a typical (or hypothetical) child or group of similarly exposed children would have an estimated risk of no more than 5% of exceeding a 10 : g/dl blood lead level." The directive also states that "... EPA recommends that a soil lead concentration be determined so that a typical child or group of children exposed to lead at this level would have an estimated risk of no more than 5% of exceeding a blood lead of 10 : g/dl." OSWER generally defines an exposure unit as a geographic area where exposures occur to the receptor of concern during the time of interest and believes that for a child or group of similarly exposed children, this is typically the individual residence and other areas where routine exposures are occurring.
3. The directive recommends that risk managers assess the contribution of multiple environmental sources of lead to overall lead exposure (e.g., consideration of the importance of soil lead levels relative to lead from drinking water, paint, and household dust) which promotes development of risk reduction strategies that address all sources that contribute significantly to exposure.
4. The OSWER directive states that the IEUBK model is not the only factor to be considered in establishing lead cleanup goals. Rather, the IEUBK model is the primary risk assessment tool available for evaluating lead risk and the results of the model are used to guide selection of appropriate risk management strategies for each site.

Since the OSWER directive was issued in 1994, there has been a trend toward a more consistent approach to managing risk at residential lead sites, however, OSWER was interested in identifying areas requiring additional clarification to facilitate more effective implementation of the directive. As a first step in the process, meetings were held with various EPA Regions, States and local governments to discuss how the directive has been implemented nationally at lead sites since 1994. By participating in these meetings and by reviewing the decisions that are being made across the country, OSWER believed that clarification of certain aspects of the 1994 directive would be useful.

All of the documents and guidance referenced in this directive are available through the National Technical Information Service (NTIS) at 703-605-6000 or could be downloaded electronically from: http://epa.gov/superfund/oerr/ini_prod/lead/prods.htm.

OBJECTIVE

At lead contaminated residential sites, OSWER seeks assurance that the health of the most susceptible population (children and women of child bearing age) is protected and promotes a program that proactively assesses and addresses risk. OSWER believes that predictive tools should be used to evaluate the risk of lead exposure, and that cleanup actions should be designed to address both current and potential future risk.

While health studies, surveys, and monitoring can be valuable in identifying current exposures and promoting improved public health, they are not definitive tools in evaluating potential risk from exposure to environmental contaminants. In the case of lead exposure, blood lead monitoring programs can be of critical importance in identifying individuals experiencing potential negative health outcomes and

directing education and intervention resources to address those risks. However, CERCLA §121(b) requires EPA to select cleanup approaches that are protective of human health and the environment and that utilize permanent solutions to the maximum extent practicable. To comply with the requirements set forth in CERCLA §121(b), OSWER will generally require selection of cleanup programs that are proactive in mitigating risk and that do not simply rely on biological monitoring programs to determine if an exposure has already occurred.

To meet these objectives, OSWER will seek actions that limit exposure to soil lead levels such that a typical child or group of similarly exposed children would have an estimated risk of no more than 5% of exceeding a 10 : g/dl blood lead level. If lead is predicted to pose a risk to the susceptible population, OSWER recommends that actions be taken to significantly minimize or eliminate this exposure to lead.

The principles laid out in the **four attached fact sheets** (Appendix) support OSWER's goals by encouraging appropriate assessment and response actions at CERCLA and RCRA lead sites across the country.

This clarification directive emphasizes the following key messages regarding the four areas and encourages the users of this directive, be they EPA Regions, States, or other stakeholders, to adopt these principles in assessing and managing CERCLA and RCRA lead sites across the country. The critical elements of the attached papers are as follows:

I. Using Blood Lead Studies and IEUBK Model at Lead Sites:

OSWER emphasizes the use of the IEUBK Model for estimating risks for childhood lead exposure from a number of sources, such as soils, dust, air, water, and other sources to predict blood lead levels in children 6 months to 84 (7 years) months old. The 1994 directive also recommended evaluation of available blood lead data and stated that data from a well-conducted blood lead study of children could provide useful information to site managers. In summary, OSWER's clarification policy on the appropriate use of the IEUBK and blood lead studies is that:

- OSWER recommends that the IEUBK model be used as the primary tool to generate risk-based soil cleanup levels at lead sites for current or future residential land use. If Regions propose an alternative method for generating cleanup levels, they are required to submit their approach to the national Lead Sites Consultation Group (LSCG)¹ for review and comment;
- Response actions can be taken using IEUBK predictions alone; blood lead studies are not required; and
- Blood lead studies and surveys are useful tools at lead sites and can be used to identify key site-specific exposure pathways and to direct health professionals to individuals needing immediate assistance in minimizing lead exposure; however, OSWER recommends that blood lead studies not be used for establishing long-term remedial or non-time-critical removal cleanup levels at lead sites.

II. Determining Exposure and Remediation Units at Lead Sites

¹The Lead Sites Consultation Group (LSCG) is comprised of senior management representatives from the Waste Management Divisions in all 10 EPA regions along with senior representatives from the Office of Emergency and Remedial Response in EPA headquarters. The LSCG is supported by EPA's Technical Review Workgroup (TRW) for lead and the national Lead Sites Workgroup (LSW). The TRW consists of key scientific experts in lead risk assessment from various EPA Regions, labs and headquarters. The LSW is comprised of senior Regional Project Managers from various Regions and key representatives from headquarters who are experienced in addressing lead threats at Superfund sites.

OSWER recommends that cleanup levels at lead sites be designed to reduce risk to a typical or individual child receiving exposures at the residence to meet Agency guidelines (*i.e.*, no greater than a 5% chance of exceeding a 10 : g/dl blood lead level for a full-time child resident). Therefore, it is recommended that risk assessments conducted at lead-contaminated residential sites use the individual residence as the primary exposure unit of concern. This does not mean that a risk assessment should be conducted for every yard, rather that the soil lead contamination data from yards and other residential media (for example, interior dust and drinking water) should be input into the IEUBK model to provide a preliminary remediation goal (PRG) for the residential setting. When applicable, potential exposure to accessible site-related lead sources outside the residential setting should also be evaluated to understand how these other potential exposures contribute to the overall risk to children, and to suggest appropriate cleanup measures for those areas.

III. Addressing Multimedia Contamination at Lead Sites

EPA generally has limited legal authority to use Superfund to address exposure from **interior lead-based paint**. As a policy matter, OSWER recommends that such exposures not be addressed through actual abatement activities. However, EPA Regions should promote addressing interior paint risks through actions by others (*e.g.*, potentially responsible parties (PRPs), other government programs, etc.) as a component of an overall site management strategy. Because of other competing demands on the Superfund Trust Fund, OSWER recommends that EPA Regions avoid using the Superfund Trust Fund for removing **exterior lead-based paint** and soil contaminated from lead-based paint. Superfund dollars *may* however be used in limited circumstances to remediate exterior lead-based paint in order to protect the overall site remedy (*i.e.*, to avoid re-contamination of soils that have been remediated) but generally only after determining that other funding sources are unavailable. As with interior lead-based paint abatement, EPA Regions should promote remediation of exterior lead-based paint by others, such as PRPs, local governments or individual homeowners.

IV. Determining Appropriate Response Actions at Lead Sites

In selecting site management strategies, it is OSWER's preference to seek early risk reduction with a combination of engineering controls (actions which permanently remove or treat contaminants, or create reliable barriers to mitigate the risk of exposure) and non-engineering response actions. All potential lead sources should be identified in site assessment activities. Non-engineering response actions, such as education and health intervention programs, should be considered an integral part of early risk reduction efforts because of their potential to provide immediate health benefits. In addition, engineering controls should be implemented early at sites presenting the greatest risk to children and other susceptible subpopulations.

As a given project progresses, OSWER's goal should be to reduce the reliance on education and intervention programs to mitigate risk. The goal should be cleanup strategies that move away from reliance on long-term changes in community behavior to be protective since behavioral changes may be difficult to maintain over time. The actual remedy selected at each CERCLA site must be determined by application of the National Oil and Hazardous Substances Pollution Contingency Plan (NCP) (55 FR 8666- 8865, March 8, 1990) remedy selection criteria to site-specific circumstances. This approach also recognizes the NCP preference for permanent remedies and emphasizes selection of engineering over non-engineering remedies for long-term response actions.

This directive clarifies OSWER's policy on four key issue areas addressed in the 1994 OSWER soil lead directive in order to promote a nationally consistent decision-making process for assessing and managing risks associated with lead contaminated sites across the country. The policy presented in these specific issue areas supersedes all existing OSWER policy and directives on these subjects. No other aspects of the existing 1994 directive are affected.

IMPLEMENTATION

The principles laid out in this directive (which includes the four attached factsheets) are meant to apply to all residential lead sites currently being evaluated through the CERCLA Remedial Investigation/Feasibility Study process and all future CERCLA Sites and RCRA Corrective Action Facilities contaminated with lead. The Regions will be required to submit their rationale for deviating from the policies laid out in this directive to the Lead Sites Consultation Group. This directive does not apply to previous remedy selection decisions.

Attachments

cc: Waste Management Policy Managers (Regions I-X)
Stephen Luftig, OERR
Elizabeth Cotsworth, OSW
James Woolford, FFRRO
Barry Breen, OSRE
Larry Reed, OERR
Tom Sheckells, OERR
Murray Newton, OERR
Betsy Shaw, OERR
John Cunningham, OERR
Paul Nadeau, OERR
Bruce Means, OERR
Earl Salo, OGC

NOTICE: This document provides guidance to EPA staff. The document does not, however, substitute for EPA's statutes or regulations, nor is it a regulation itself. Thus it cannot impose legally-binding requirements on EPA, states, or the regulated community, and may not apply to a particular situation based upon the circumstances. EPA may change this guidance in the future, as appropriate.

Factsheet: Using the IEUBK Model and Blood Lead Studies at Residential Lead Sites

Question: What is OSWER's policy on using the IEUBK model and blood lead studies in conducting risk assessments and setting cleanup standards at residential lead contamination sites?

Answer: OSWER's policy on using the IEUBK model and blood lead studies in conducting risk assessment and setting cleanup standards is as follows:

A. Use of the IEUBK Model:

1. The IEUBK model is a good predictor of potential long-term blood lead levels for children in residential settings. OSWER recommends that the IEUBK model be used as the primary tool to generate risk-based soil cleanup levels at lead sites for current or future residential land use. If Regions propose an alternative method for generating cleanup levels, they are required to submit their approach to the National Lead Sites Consultation Group (LSCG) for review and comment.
2. Blood lead distributions predicted by the IEUBK model illustrate a plausible range of variability in children's physiology, behavior, and household conditions.
3. Response actions can be taken, and remedial goals developed, using IEUBK predictions alone.

B. Use of Blood Lead Studies/Data:

1. Blood lead studies, surveys, and monitoring are useful tools at lead sites and can be used to help identify key site-specific exposure pathways and direct health professionals to individuals needing immediate assistance in minimizing lead exposure.
2. The utility of blood lead testing results and studies depends on how representative the information is of the population being evaluated, the design of the data collection, and the quality of the laboratory analysis. To this end, OSWER recommends that EPA Regions consult with ATSDR or CDC to assess or design studies according to their intended use.
3. Many blood lead screening, monitoring, or testing programs differ from blood lead studies in that they do not attempt to identify risk factors for childhood exposure to lead sources. Although these programs may be extremely beneficial in identifying children with elevated blood lead levels and identifying candidates for referral to medical professionals for evaluation, they may not provide an accurate representation of community-wide exposure.
4. Well-designed blood lead studies may be used to identify site specific factors and pathways to be considered in applying the IEUBK model at residential lead sites. However, OSWER recommends that blood lead studies not be used to determine future long-term risk where exposure conditions are expected to change over time; rather, they should be considered a snapshot of ongoing exposure under a specific set of circumstances (including community awareness and education) at a specific time. Long-term studies may be helpful in understanding exposure trends within a community and evaluating the effectiveness of cleanup strategies over time.

C. IEUBK and Blood Lead Studies/Data:

1. Blood lead data and IEUBK model predictions are expected to show a general concordance for most sites. However, some deviations between measured and predicted levels are expected. On some occasions, declines in blood lead levels have been observed in association with lead exposure-reduction and health education. However, long-term cleanup goals should be protective

in the absence of changes in community behavior as there is little evidence of the sustained effectiveness of these education/intervention programs over long periods of time.

2. Where actual blood lead data varies significantly from IEUBK Model predictions, the model parameters should not automatically be changed. In such a case, the issue should be raised to the Lead Technical Review Workgroup (TRW) to further identify the source of those differences. Site work need not be put on hold while the issue is being reviewed by the TRW; the site manager should review other elements of the lead directive and the “Removal Actions at Lead Sites” guidance to determine appropriate interim actions to be taken at the site.

The Regions will be required to submit their rationale for deviating from the policies laid out in this factsheet to the Lead Sites Consultation Group.

Factsheet: Determining Exposure and Remediation Units at Residential Lead Sites
--

Question: How does OSWER define an exposure unit, and subsequently apply this definition in conducting risk assessment and risk management activities at residential lead sites?

Answer: OSWER recognizes that defining and characterizing exposure unit(s) for a site is critically important in undertaking risk assessment activities and in designing protective cleanup strategies. An **exposure unit** is defined as a geographic area where exposures occur to the receptor of concern during the time of interest and that for a child, or group of similarly exposed children, this is typically the individual residence and other areas where chronic or ongoing exposures are occurring.

Various approaches to characterizing and managing risks by exposure units have been examined by OSWER. OSWER recognizes that lead ingestion can also cause adverse health effects in adults and fetuses but believes that by adequately limiting lead exposures to young children at residential sites, these other receptors will generally be likewise protected from adverse health impacts.

EPA's goal is to protect human health and the environment under current and future exposure scenarios. At lead sites, OSWER wants to assure that children's health is protected and promotes a program that proactively assesses risks rather than relying on biological monitoring to determine if an exposure has already occurred. OSWER emphasizes actions be taken at lead sites that will minimize or eliminate exposure of children to environmental lead contamination.

To achieve the above stated goal, OSWER recommends characterizing **exposure units as exposure potential at the individual residence as the primary unit of concern for evaluating potential risk at lead contaminated residential sites**. This recognizes that there are children whose domain and activities occur principally within the confines of a particular residential property. For determining exposure potential (and ultimately developing protective cleanup levels) at the individual home, OSWER recommends the scenario to be evaluated (through use of the IEUBK Model) would be a young child in full-time residence. This approach helps achieve OSWER's recommended health protection goal that an individual child or group of similarly exposed children would have <5% chance of exceeding a blood lead concentration of 10 : g/dl. In designing community wide cleanup strategies, it is essential that non-residential areas (*e.g.*, parks, day care facilities, playgrounds, etc.), where lead exposure may occur, also be characterized with respect to their contribution to soil-lead exposure, and appropriate cleanup actions implemented.

OSWER recommends that risk management decisions for response to residential lead contamination sites focus on reducing risk at residences, but also recommends that response strategies be developed for other site locations (exposure units) where children receive exposure. Flexibility in determining appropriate response actions that provide protection at the individual residence should be considered in context of the NCP remedy selection criteria. The lead exposure issues are complex and OSWER recommends that EPA Regions try to communicate clearly the risk characterization and risk management decisions to the site residents. Affected communities must clearly understand the context of risk management decisions, how these decisions affect the health of their children, and how cleanup actions will influence the future growth and development of the community.

The Regions will be required to submit their rationale for deviating from the policies laid out in this factsheet to the Lead Sites Consultation Group.

Factsheet: Addressing Multimedia Contamination at Residential Lead Sites

Question: What is OSWER's policy on addressing multimedia contamination at residential lead sites?

Answer: OSWER recognizes that several sources of lead-contamination, including soil, ground water, airborne particulates, lead plumbing, interior dust, and interior and exterior lead-based paint may be present at Superfund sites where children are at risk or have documented lead exposure. These lead sources may contribute to elevated blood lead levels and may need to be evaluated in determining risks and cleanup actions at residential lead sites. However, there are limitations on the Agency's statutory authority under CERCLA to abate some of these sources, such as indoor lead-based paint and lead plumbing because CERCLA responses may be taken only to releases or threatened releases into the environment (CERCLA §104 (a)(3) and (4)).

When EPA's resources, or authority to respond or to expend monies under Superfund is limited, OSWER recommends that EPA Regions identify and coordinate to the greatest extent possible with other authorities and funding sources (*e.g.*, other federal agencies and state or local programs). EPA Regions should coordinate with these other authorities to design a comprehensive, cost-effective response strategy that addresses as many sources of lead as practicable. These strategies should include actions to respond to lead-based paint, interior dust, and lead plumbing, as well as ground water sources and lead-contaminated soil.

Although OSWER will encourage that EPA Regions fully cooperate in the development of a comprehensive site management strategy, OSWER realizes that complete active cleanup of these other sources may be difficult to complete due to limited funding available to other authorities. Since complete cleanups of these sources is not guaranteed, and at most sites may be unlikely, OSWER recommends that the soil cleanup levels not be compromised. In other words, the soil cleanup levels should be calculated with the IEUBK model using existing pre-response action site specific data. This is due to the fact that soil cleanup levels at residential lead sites are generally established to protect individuals, from excess exposures to soils, and house dust attributable to those soils, and are not attributable to exposure to other sources such as interior lead paint which should be managed on a residence specific basis. Remediation of non-soil lead sources to mitigate overall lead exposure at individual residences should therefore not be used to modify site-wide soil lead cleanup levels.

The recommendations provided below represent OSWER's policy on addressing lead-contaminated media and/or sources for which EPA has limited or no authority to remediate.

Interior Paint: EPA has limited legal authority to use Superfund to address exposure from interior lead-based paint. As a policy matter, OSWER recommends that such exposures not be addressed through actual abatement activities. However, EPA Regions should promote addressing interior paint risks through actions by others, such as HUD, local governments, or individual home owners as a component of an overall site management strategy. Any activities to clean up interior lead-based paint by PRPs or other parties should not result in an increase of the risk-based soil cleanup levels.

Exterior Paint: Because of other competing demands on the Superfund Trust Fund, OSWER recommends that EPA Regions avoid using the Superfund Trust Fund for removing exterior lead-based paint and soil contaminated from lead-based paint. Superfund dollars *may* be used to respond to exterior lead-based paint for protecting the overall site remedy (*i.e.*, to prevent re-contamination of soils that have been remediated) but only after determining that other funding sources are unavailable. Where other sources of funding are not available, EPA may utilize the CERCLA monies to remediate exterior lead-based paint on homes/buildings, around which soil contaminated by other sources has been cleaned up to prevent recontamination of the soil. The Superfund should not be used to remediate exterior lead-based paint where no soil cleanup has occurred. As with interior lead-based paint abatement, EPA Regions

should promote remediation of exterior lead-based paint by others, such as PRPs, local governments or individual homeowners. Cleanup activities of exterior paint conducted by PRPs or other parties should not result in an increase of the risk-based soil cleanup levels.

Interior Dust: Lead contaminated interior dust can be derived from several sources, including interior paint, home owner hobbies, exterior soil, and other exterior sources. In many cases, it may be difficult to differentiate the source(s) for the lead contamination in the dust. In general, EPA Regions should refrain from using the Superfund Trust Fund to remediate interior dust. Because of the multi-source aspects of interior dust contamination, potential for recontamination, and the need for a continuing effort to manage interior dust exposure, OSWER recommends the use of an aggressive health education program to address interior dust exposure. Such programs, administered through the local health department (or other local agency), should be implemented in conjunction with actions to control the dust source. At a minimum, the program should include blood lead monitoring, and personal hygiene and good housekeeping education for the residents. OSWER believes that EPA Regions can also support the program by providing HEPA vacuums to the health agency for use in thoroughly cleaning home interiors.

Lead Plumbing: Generally CERCLA does not provide for legal authority to respond to risks posed by lead plumbing within residential dwellings. It should be noted that the water purveyor is responsible for providing clean water to the residences. As with interior dust, OSWER recommends that EPA Regions coordinate with local agencies to establish a health education program to inform residents of the hazards associated with lead plumbing and how to protect themselves by regularly flushing, or preferably, replacing lead pipes. Soil cleanup levels should not be adjusted to account for possible remediation of lead plumbing.

Factsheet: Determining Appropriate Response Actions at Residential Lead Sites

Question: What is OSWER's position on the appropriate use of engineering and non-engineering response actions in developing risk management strategies for lead sites?

Answer: One goal emphasized in the recent third round of Superfund Reforms is for EPA to take a consistent approach in selecting and implementing both long- and short-term response actions at lead sites in all regions. One obstacle to achieving this consistency has been differing degrees of reliance on non-engineering response actions in reducing risk.

Site management strategies at lead sites typically include a range of response actions. Alternatives range from engineering controls that permanently remove or treat the contaminant source to non-engineering response actions, such as educational programs and land use restrictions. This continuum represents the range of response options available to risk managers. This position paper clarifies the relationship between engineering and non-engineering response actions in developing site management strategies.

In selecting site management strategies, OSWER's policy will be to seek early risk reduction with a combination of engineering controls (actions which permanently remove or treat contaminants, or which create reliable barriers to mitigate the risk of exposure) and non-engineering response actions. All potential lead sources should be identified in site assessment activities. Non-engineering response actions, such as education and health intervention programs, should be considered an integral part of early risk reduction efforts due to their potential to provide immediate health benefits.² In addition, engineering controls should be implemented early at sites presenting the greatest risk to children and other susceptible subpopulations. Community concerns should receive a high priority in site decision-making; local support is vital to the success of health intervention and education programs.

As the project progresses, OSWER's goal should be to reduce reliance on education and intervention programs to mitigate risk. The goal should be cleanup strategies that move away from reliance on long-term changes in community behavior to be protective; behavioral changes may be difficult to maintain over time. The actual remedy selected at each site must be determined by application of the NCP remedy selection criteria to site-specific circumstances. However, this approach recognizes the NCP preference for permanent remedies and emphasizes the use of engineering controls for long-term response actions. This approach also recognizes that well-designed health intervention and education programs, when combined with deed restrictions and/or other institutional controls, may be appropriate for reducing future exposure potential and may supplement engineering controls.

In instances where Regions believe that the use of engineering controls is impracticable, and education, health intervention, or institutional controls are proposed as the sole remedy, Regions will be required to consult with the LSCG.

²The actual effectiveness of health intervention and educational programs in reducing risk continues to be a subject of discussion. Anecdotal information suggests that such programs can provide short-term benefits in some populations. Rigorous statistical studies demonstrating the benefits of educational programs in preventing lead exposure are lacking. It is generally recognized that not all segments of the population will be influenced by such programs, and that long-term benefits are less certain. Local support for such programs is critical. The active (and long-term) participation of local and state public health agencies is needed in implementing institutional controls, including health intervention and education programs; without local implementation of such programs their success is uncertain. Additional research on the effectiveness of these programs is critical to consideration of their use in future cleanups.

APPENDIX C

Contacts and Software for Sampling Design

Table C-1 Contacts and Software for Sample Planning Design		
Topic		Contact(s)
Sampling plan design/ Systematic Planning	General support	EPA HQ Quality Staff Phone: (202) 564-6830 FAX: (202) 565-2441 E-mail: quality@epa.gov
	Dynamic Field Activities	Internet: http://www.epa.gov/superfund/programs/dfa/index.htm
Software	DEFT: Data Quality Objectives Decision Error Feasibility Trials	E-mail: quality@epa.gov Internet: http://www.ornl.gov/doe_oro/dqo/resdqo.htm
	FIELDS: Fully Integrated Environmental Decision Support	Internet: http://www.epa.gov/region5fields/static/pages/index.html
	Geo-EAS: Geostatistical Environmental Assessment Software	E-mail: englund.evan@epa.gov Internet: http://www.ai-geostats.org/
	SADA: Spatial Analysis Decision Assistance	E-mail: sada@tiem.utk.edu Internet: http://www.tiem.utk.edu/~sada/
	VSP: Visual Sample Plan	E-mail: nell.cliff@pnl.gov Internet: http://dqo.pnl.gov/vsp/

APPENDIX D

Examples of Property Access Agreement Forms

CONSENT FOR ACCESS TO PROPERTY FOR SAMPLING

Name: _____ Daytime Phone Number: _____

Address(es) of Property(ies): _____

I consent to officers, employees, and authorized representatives of the United States Environmental Protection Agency (EPA) entering and having access to my property for the purpose of taking [DESCRIBE NUMBER OF SAMPLING LOCATIONS AND DEPTHS] which are necessary to implement the cleanup of lead contamination in the soil.

This written permission is given by me voluntarily with knowledge of my right to refuse and without threats or promises of any kind. I understand that EPA or authorized representatives of EPA will contact me at least one week in advance before the soil samples are collected. This agreement is only for the purpose of soil sampling and no other work.

Date

I grant
access to my property

I do not grant
access to my property

Signature

Signature

I would also like EPA to have a lead expert contact me to schedule a free inspection to identify potential lead hazards in my home and provide safety tips.

**United States Environmental Protection Agency Region 6
1445 Ross Avenue, Suite 1200
Dallas, Texas 75202-2733**

CONSENT FOR ENTRY AND ACCESS TO PROPERTY FOR SAMPLING

Description of property (including address) for which consent to access is granted:

Example: XXXX Street, Texarkana, Arkansas, more particularly described as a lot measuring approximately 3,000 square feet, including a two-room wood structure of approximately 300 square feet

Name of Signatory: _____

Address: _____

Phone: (____)_____

Relationship to property (e.g., owner, lessee, agent or employee of owner, etc.):

I HEREBY CONSENT to officers, employees and parties authorized by the U.S. Environmental Protection Agency (EPA), entering and having continued access to the property described above at reasonable times for the following purposes (List the activities to be undertaken on the property):

Example:

- Sample collection including: (1) the gathering of soil from the outside area of the property; (2) drawing water from the tap; and (3) vacuuming the inside area of any inhabitable structure in order to collect dust.
- Taking photographs to record the sampling process.

I realize that these actions are undertaken pursuant to EPA's response and enforcement responsibilities under the Comprehensive Environmental Response, Compensation, and Liability Act (CERCLA), 42 U.S.C. Sections 9601-9675. This written permission is given by me voluntarily with the knowledge of my right to refuse and without threats or promises of any kind.

This agreement expires on: _____
(Date)

I HEREBY WARRANT that I have authority to make this access agreement.

Date

Signature

Print name

CONSENT FOR ACCESS TO PROPERTY FOR SAMPLING AND TO TAKE RESPONSE ACTION

Name: _____ Daytime Phone Number: _____

Address(es) of Property(ies): _____

I consent to officers, employees, and authorized representatives of the United States Environmental Protection Agency (EPA) entering and having access to my property for the purpose of sampling and taking a response action including: (1) preparing for and excavation of soil from my property; (2) backfilling the excavated area(s) with clean soil and/or backfill; and (3) restoring any grass or other vegetation or structures to their pre-excavation state. These activities are necessary to implement the cleanup of lead contamination in the soil.

This written permission is given by me voluntarily with knowledge of my right to refuse and without threats or promises of any kind. I understand that EPA or authorized representatives of EPA will contact me approximately two weeks in advance before the removal of soil begins, to discuss the steps involved in the excavation and removal program and all measures EPA will take to restore my yard. I also understand that if there is any damage to structures such as sidewalks that is caused by the work conducted by EPA or authorized representatives of EPA, then EPA or authorized representatives of EPA shall repair such damage.

Date

I grant
access to my property

I do not grant
access to my property

Signature

Signature

XXXX TRIBE OF OKLAHOMA

PROPERTY ACCESS CONSENT AGREEMENT FOR SAMPLING AND TO TAKE RESPONSE ACTION

The Property which is the subject of this agreement is described as follows:

NE 1/4 SE 1/4, Section 6, Township 28 North, Range 24 East, Xxxx County, Oklahoma otherwise described as Beaver Springs Park and Tribal Office which includes the Pow Wow grounds (hereinafter the Property).

THIS ____ DAY OF _____, 1999, by authority of the Xxxx Tribal Business Committee, permission is hereby granted to officers, employees and parties authorized by the United States Environmental Protection Agency (EPA) entering and having continued access to the Property until 4:30 pm (CST) on _____, to conduct the following work (hereinafter the work):

- (1) To perform necessary response actions (e.g., excavation of contaminated soil, backfilling with clean soil or gravel, and sodding or seeding) to address lead and other metals from mining waste contamination on the above-described lands in accordance with the EPA Record of Decision issued August 27, 1997;
- (2) To take necessary samples of environmental media to identify lead and other metals that may be a threat to public health or welfare or the environment.

Nothing contained in this permit shall operate to delay or prevent a termination of Federal trust responsibilities with respect to the Property by the issuance of a fee patent or otherwise during the term of the work; however, such termination shall not serve to terminate the work. The Xxxx Tribal Business Committee shall notify EPA of any change in status or ownership of the Property.

The Xxxx Tribal Business Committee realizes that the work will be undertaken pursuant to EPA's Superfund authority under the Comprehensive Environmental Response, Compensation, and Liability Act (CERCLA), 42 U.S.C. Sections 9601-9675.

This written permission is given by the Xxxx Tribal Business Committee voluntarily with the knowledge of its right to refuse and without threats or promises of any kind.

The Xxxx Tribal Business Committee is the property owner or a responsible representative of the property owner and I, Xx Xxxx, as Chairman of that Committee, warrant that I have authority to make this access agreement.

 Xx Xxxx
 Xxxx Tribal Chairman
 Xxxx Tribe of Oklahoma

Date

U.S. Environmental Protection Agency

Date

CONSENT FOR ACCESS TO PROPERTY TO TAKE RESPONSE ACTION

Name: _____ Daytime Phone Number: _____

Address(es) of Property(ies): _____

I consent to officers, employees, and authorized representatives of the United States Environmental Protection Agency (EPA) entering and having access to my property for the purpose of taking a response action including: (1) preparing for and excavation of soil from my property; (2) backfilling the excavated area(s) with clean soil and/or backfill; and (3) restoring any grass or other vegetation or structures to their pre-excavation state. These activities are necessary to implement the cleanup of lead contamination in the soil.

This written permission is given by me voluntarily with knowledge of my right to refuse and without threats or promises of any kind. I understand that EPA or authorized representatives of EPA will contact me approximately two weeks in advance before the removal of soil begins, to discuss the steps involved in the excavation and removal program and all measures EPA will take to restore my yard. I also understand that if there is any damage to structures such as sidewalks that is caused by the work conducted by EPA or authorized representatives of EPA, then EPA or authorized representatives of EPA shall repair such damage.

Date

I grant
access to my property

I do not grant
access to my property

Signature

Signature

APPENDIX E

Example of Dust Abatement Access Form

CONSENT FOR ACCESS TO PROPERTY

Name: _____ Daytime Phone Number: _____

Address(es) of Property(ies): _____

I hereby consent to grant officers, employees, contractors, sub-contractors and authorized representatives of the United States Environmental Protection Agency (EPA) access to the interior of my home and/or property for the purpose of interior dust abatement. The home dust abatement program being offered at this time consists of vacuuming floors and walls with a special vacuuming system. This system is portable and compact and easy to use. A team of bonded representatives will be providing the service at no charge to the homeowner.

Videotaping of the interior of the residence will be necessary to provide backup documentation in the event of any claims. It will be necessary that someone remain at the residence for one or two days while it is being vacuumed. This lead abatement program is offered only to homeowners who have or will grant access to their property for the remediation of in their yards. These activities are necessary to interrupt the movement of lead through soil dust, house dust, and paint dust.

If you want the process completed in your home and prefer to do it yourself, please note in the appropriate space and arrangements will be made to schedule the loan of a HEPA-VAC unit to you.

This written permission is given voluntarily with the knowledge of its right to refuse and without threats or promises of any kind. I understand that , if any damage to my property results from these activities or any work conducted by the USEPA or its authorized representatives, then the USEPA or its authorized representatives shall repair or replace such damage.

Date

- ' I grant access to my property for Representatives of the EPA to video and vacuum.
- ' I wish to make arrangements to vacuum myself.
- ' I do not grant access to my property.

Signature

Please return as soon as possible for scheduling of work. If you should have any questions please contact [LOCAL CONTACT NAME] at [PHONE NUMBER].

APPENDIX F

Example of Property Inspection Checklist

**TAR CREEK PROJECT
PROPERTY HOME INSPECTION CHECKLIST**

Address _____

Date _____

Property Group Number _____

Home Interior Access (check one, see comments):

- Approved by Property Owner Denied by Property Owner

Property (Yard) Access (check one, see comments):

- Approved by Property Owner Denied by Property Owner

	OK	NA	PROBLEM/CONDITION
YARD AREA			
1. Lawn Area			
A. Location of Flower/Plant Boxes			
B. Soil (grade) next to house			
C. Shrubbery			
D. Trees			
E. Low areas near house (that could cause ponding of water)			
F. Other: _____			
2. Utility			
A. Water Meter			
B. Gas Meter			
C. Sewer Lines			
D. Other: _____			
3. Driveway			
A. Concrete cracked, damaged			
B. Blacktop cracked, damaged			
C. Uneven Settling			
D. Other: _____			

	OK	NA	PROBLEM/CONDITION
YARD AREA (cont.)			
4. Streetwalk & Walkways			
A. Concrete cracked, eroded			
B. Tripping hazards			
C. Tree roots cracking, lifting slab			
D. Sections missing			
E. Other _____			
5. Garage			
A. Settlement cracks in walls			
B. Concrete floor slab cracked, damaged			
C. Door jambs damaged, rotted			
D. Door hard to open, close			
E. Other: _____			
6. Swimming Pool (Above Ground)			
A. Leakage			
B. Visible damage			
C. Other: _____			
7. Swimming Pool (Below Ground)			
A. Leakage			
B. Visible damage			
C. Other _____			
8. Storm Cellar			
A. Damaged			
B. Indication of Flooding			
C. Other: _____			

	OK	NA	PROBLEM/CONDITION
YARD AREA (cont.)			
9. Electrical Service			
A. Damaged circuit breaker panel box			
B. Wiring hanging outside			
C. Damaged electric meter			
D. Other: _____			
EXTERIOR AREA			
10. 9 Brick 9 Siding			
A. Brick bulging, spalling, cracking			
B. Mortar loose, needs repointing			
C. Lintel needs repair			
D. Stucco bulging, cracking			
E. Siding dented, damaged			
F. Finish wearing off siding			
G. Siding loose, not level, missing			
H. Siding rotted, termites			
I. Composite shingles worn, broken, missing			
J. Windows damaged			
K. Other: _____			
11. Roofing			
A. Age of covering			
B. Shingles worn, damaged, patched			
C. Brick chimney broken, leaning			
D. Joint open between chimney & exterior wall			
E. Need flashing at chimney, vents, walls			

	OK	NA	PROBLEM/CONDITION
EXTERIOR AREA (cont.)			
F. Parapet wall leaning			
G. Roof sagging			
H. Metal flashing damaged, missing			
I. Other: _____			
12. Gutters & Leaders 9 Yes 9 No			
A. Copper discolored, greenish, damaged			
B. Galvanized rusted, patched			
C. Fascia board rotted, damaged, patched			
D. Drain onto foundation wall			
E. Need to divert water from wall			
F. Soffit venting 9 Yes 9 No			
G. Concrete slab cracked, deteriorated			
H. Concrete slab/splash block need			
I. Other: _____			
13. Entrance Steps			
A. Concrete cracked			
B. Brick cracked, mortar loose			
C. Structurally sound			
D. Handrail			
E. Other: _____			
14. Exterior Doors			
A. Damaged			
B. Opens/closes freely			
C. Weatherstripping			
D. Trim rotted, missing			

	OK	NA	PROBLEM/CONDITION
EXTERIOR AREA (cont.)			
E. Jambs rotted, damaged			
F. Frame separation from walls			
G. Other: _____			
INTERIOR AREA			
15. Windows			
A. Trim/sills rotted			
B. Broken glass			
C. Open freely			
E. Frame separation from walls			
F. Other: _____			
16. Kitchen			
A. Cracked walls, ceiling			
B. Loose nails, tape on drywall			
C. Soft, springy floors			
D. Wood, tiles on floor damaged			
E. Faucet leaks			
F. Doors don't close			
G. Cabinets don't close			
H. Moisture in cabinets			
I. Walls have moisture damage			
J. Other: _____			
17. Interior Rooms			
A. Cracked walls, ceiling			
B. Loose nails, tape on drywall			
C. Soft, springy floor			
D. Carpeting water damaged			
E. Water stains near windows			

	OK	NA	PROBLEM/CONDITION
INTERIOR AREA (cont.)			
F. Mold/mildew on walls			
G. Other: _____			
18. Toilet Facility			
A. Cracked tile, plaster on walls			
B. Cracked plaster on ceilings			
C. Loose tiles on walls, floors			
D. Loose nails, tape on drywall			
E. Toilet cracked			
F. Water leaks at closet flange			
G. Grout missing around tub			
H. Shower pan damaged, missing			
I. Shower door damaged, missing			
J. Need new shower door			
K. Water stains on ceiling below bathroom			
L. Hot water heater tank corroded			
M. Water stains on floor around hot water heater			
N. Moisture present around hot water heater			
O. Other: _____			
19. Interior Doors			
A. Open freely			
B. Frame separation from walls			
C. Other: _____			
20. Attic			
A. Only if visual indicator			
B. Other: _____			

	OK	NA	PROBLEM/CONDITION
INTERIOR AREA (cont.)			
21. Foundation			
A. Minor cracks			
B. Settlement cracks at corners, walls			
C. Wall bulging inward			
D. Seepage into basement/cellar			
E. Mortar deteriorating			
F. Other: _____			
22. Basement or Cellar			
A. Seepage, water stains on floor/wall			
B. Sump pump installed			
C. Water pipe leaks			
D. Sewer pipe leaks			
E. Other: _____			
FOUNDATION AREA			
23. Foundation (Slab on Grade)			
A. Settlement cracks			
B. Joint separation			
C. Spalding			
D. Other: _____			
24. Foundation (Elevated Slab w/Crawl Space)			
A. Concrete support integrity			
B. Evidence of moisture or visible moisture in crawl space			
C. Evidence of water accumulation (e.g., water stains)			

	OK	NA	PROBLEM/CONDITION
FOUNDATION AREA (cont.)			
D. Sagging joist/support girders			
E. Fungus growth evident			
F. Sump pump evident			
G. Vents present			
H. Vapor barriers			
I. Pier settlement			
J. Uneven subgrade			
K. Insect damage			
L. Sill plate damaged			
M. Subfloor damaged, loose			
N. Need subfloor			
O. Other: _____			
25. Plumbing (Raised Floors Only)			
A. Pipe insulation crumbling, missing			
B. Need to insulate pipes			
C. Water pipes leaking			
D. Sewer pipes leaking			
E. Water pipe condition			
F. Other: _____			
26. Plumbing			
A. Water pipe conditions			
B. Sewage pipe conditions			
C. Pipes leaking			
D. Pipe insulation			
E. Corrosion on drain lines			
F. Other: _____			

	OK	NA	PROBLEM/CONDITION
FOUNDATION AREA (cont.)			
27. Other Area			
A. _____			
B. _____			
C. _____			
D. _____			

COMMENTS: _____

Topo Survey Requested 9 Yes 9 No

 Inspector Signature

 Date

APPENDIX G

Examples of Property Closeout Forms

USEPA REMEDIATION AGREEMENT FORM

Name: Sam's Restaurant

Address: 5000 Main St.

Madison, IL 62060

Phone: 000-123-4567

This form documents the completion of remedial activity performed on my property. My signature will designate that I am satisfied with the restoration of my property, and that no items are in question, now, or at any time in the future, except those items listed below, if any.

Comments: 100% satisfied

Restoration items in question:

1. NONE
2. _____
3. _____
4. _____
5. _____
6. _____
7. _____

<u>Chloe Irish</u>	<u>Chloe Irish</u>	<u>01/24/98</u>
Resident Signature	Printed Name	Date

<u>Brad W. Bradley</u>	<u>Brad W. Bradley</u>	<u>04/13/98</u>
USEPA Representative Signature	Printed Name	Date

RESIDENTIAL REMEDIATION INSPECTION/AGREEMENT FORM

Name Sara O'Mara

Address 777 East Ave, Whoville, IN 45123

Phone 000-987-6543

This form documents the completion of remedial activities performed on my property. My signature will designate that I am satisfied with the restoration of my property, and that no items are in question, now, or at any time in the future, except those items listed below, if any.

Comments _____

Restoration Items in Question:

1. Roll netting on sod to be trimmed off
2. Stone left side, more stone to be added, taper from building
3. At double doors back left corner, add rock up to lip to allow vehicle to get in
4. Also add rock at back of building in middle in front of concrete ledge
5. Also add rock in open parking area & grade the tops off of the high spots
6. Check outside of fence on ^W Street, clean up dirt clods rolling under sod & fence
7. _____

Property Inspection Date 12/04/98

Lawn Care Instructions Reviewed/Delivered 12/04/98

<u>Sara O'Mara</u>	<u>Sara O'Mara</u>	<u>12/09/98</u>
Resident Signature	Printed Name	Date

<u>Brad W. Bradley</u>	<u>Brad W. Bradley</u>	<u>02/12/99</u>
USEPA Representative Signature	Printed Name	Date

APPENDIX H

Examples of Clean Letters

EPA LOGO AND ADDRESS

Date

Name

Address

City, State Zip

Dear :

The U.S. Environmental Protection Agency (EPA) has completed the cleanup of the lead contamination in your yard located at [ADDRESS, CITY, STATE], in connection with the [SITE NAME] site in [CITY, STATE] (the Site). By way of this letter, U.S. EPA is certifying that your yard has been cleaned up to less than [CLEAN-UP LEVEL] parts per million lead, the level which U.S. EPA considers protective of children's health at the Site.

Thank you for your cooperation in this clean-up effort. It has been our pleasure to work with you. If you have any questions concerning this letter or need further information, please contact me at [PROJECT MANAGER'S PHONE NUMBER].

Sincerely,

[PROJECT MANAGER NAME]
Remedial Project Manager

EPA LOGO AND ADDRESS

Date

Name
 Address
 City, State Zip

Dear :

The United States Environmental Protection Agency (U.S. EPA) has sampled your yard located at [ADDRESS, CITY, STATE] for lead. The results of this sampling, which are enclosed with this letter, indicate that your yard contains less than [CLEAN-UP LEVEL] per million lead, the level which U.S. EPA considers protective of children’s health at the [SITE NAME, CITY, STATE]. Thus, U.S. EPA will not need to perform soil clean-up activities in your yard.

If you have any questions concerning this letter or the enclosure, please contact me at [PROJECT MANAGER’S PHONE NUMBER].

Sincerely,

PROJECT MANAGER NAME
 Remedial Project Manager

Enclosure

ENCLOSURE

Analytical results for [ADDRESS]
 in parts per million (ppm) of lead:

Depth Zone (inches)	Yards		OR Quadrant			
	Front	Back	1	2	3	4
0 to 1	ppm	ppm	ppm	ppm	ppm	ppm
1 to 6	ppm	ppm	ppm	ppm	ppm	ppm
6 to 12	ppm	ppm	ppm	ppm	ppm	ppm
18 to 24	ppm	ppm	ppm	ppm	ppm	ppm
Deeper Zones (if applicable)	ppm	ppm	ppm	ppm	ppm	ppm
Drip Zone Composite	ppm	ppm	ppm	ppm	ppm	ppm

Mr. John Smith
123 N. Main
Joplin, Missouri 64108

Dear Mr. Smith,

This letter serves as written notification that a lead-contaminated soil clean-up action was performed under authority of the Comprehensive Environmental Response, Compensation, and Liability Act of 1980 as amended by the Superfund Amendments and reauthorization Act of 1986 on property you have an interest in at the Jasper County, National Priorities Listed Superfund site. Our records show that your property located at **123 N. Main** was included in this action. The clean-up action conducted by the U.S. Environmental Protection Agency (EPA) and the U.S. Army Corps of Engineers (COE) addressed residences with soil lead levels over 800 ppm, day care facilities, and residences with children under six years of age with blood lead levels over 15 g/dL.

Briefly, the primary objective of the clean-up action on your property was to remove highly lead-contaminated near-surface yard soils that were located at your residence. In some cases trees, shrubs, flowers, and other vegetation were left in place. As a result a small amount of lead-contaminated soils may be left near the surface on your property. This small amount of contamination should not cause a health threat under normal circumstances. In the future if additional landscaping, or planting requiring excavation below six inches are done, care should be exercised to minimize recontamination.

The excavation criteria for the project was as follows:

A) From the surface to 12 inches, excavation continued until 500 ppm or less lead levels concentrations were achieved;

B) If the residual lead concentrations at a depth of one foot exceeded 1,500 ppm a “marker barrier” was placed at that depth. The marker barrier used was the temporary orange plastic construction-type fence. This material is permeable, and will allow water and plant roots to pass through it. Only a small number of properties required the installation of the barrier. The primary purpose of this marker barrier is to inhibit and alert individuals excavating in these areas in future years.

In general, all areas of the yard that exceeded 500 mg/kg lead at the surface were removed. Soil brought in to backfill the excavation contained less than 240 mg/kg lead.

IF YOU HAVE PLANS TO DO ANY EXCAVATION WORK AT YOUR PROPERTY AND YOU ENCOUNTER THE ORANGE BARRIER PLEASE CONTACT YOUR LOCAL HEALTH DEPARTMENT, THE MISSOURI DEPARTMENT OF NATURAL RESOURCES, OR THE EPA FOR GUIDANCE.

Please save this document for your permanent records. In the event you sell or transfer the property to someone you can show the next owner that a lead cleanup was performed. If you require more specific information concerning the excavation on your property, please feel free to contact me at (xxx) xxx-xxxx.

Sincerely,

(Project Manager)