

# Multi-Pollutant Emissions Standards for Model Years 2027 and Later Light-Duty and Medium-Duty Vehicles

## Regulatory Impact Analysis

# Multi-Pollutant Emissions Standards for Model Years 2027 and Later Light-Duty and Medium-Duty Vehicles

## Regulatory Impact Analysis

Assessment and Standards Division  
Office of Transportation and Air Quality  
U.S. Environmental Protection Agency

## Table of Contents

|  |       |
|--|-------|
| List of Tables .....   | xx    |
| List of Figures .....  | xxxix |
| Executive Summary .....  | 1     |
| Chapter 1: Development of GHG Standards and PEV Durability Requirements .....                                  | 1-1   |
| 1.1 Development of the final GHG standards for Light-Duty Vehicles .....                                       | 1-1   |
| 1.1.1 Analysis of fleet changes since 2012 .....   | 1-2   |
| 1.1.1.1 Car and Truck Regulatory Classes.....  | 1-2   |
| 1.1.2 Relationship between GHG curve shape, stringency, and BEV share .....                                    | 1-6   |
| 1.1.3 Development of appropriate GHG curve shape (slope and cut points) .....                                  | 1-6   |
| 1.1.3.1 Establishing slope of car curve .....  | 1-6   |
| 1.1.3.2 Development of truck curve.....  | 1-9   |
| 1.1.3.3 Analysis of Footprint Response to Standards .....  | 1-15  |
| 1.1.3.4 Cut points .....   | 1-17  |
| 1.2 Development of the final GHG standards for Medium-Duty Vehicles .....                                      | 1-18  |
| 1.2.1 History of GHG standards for Medium-Duty Vehicles .....  | 1-18  |
| 1.2.2 Development of the final standards for Medium-Duty Vehicles .....  | 1-22  |
| 1.2.2.1 Final MDV GHG Standards.....   | 1-23  |
| 1.3 Development of the final battery durability standards.....   | 1-25  |
| 1.3.1 United Nations Global Technical Regulation No. 22 on In-Vehicle Battery Durability .....                 | 1-26  |
| 1.3.2 California Air Resources Board battery durability and warranty provisions under the ACC II program ..... | 1-27  |
| Chapter 2: Tools and Inputs Used for Modeling Technologies and Adoption Towards Compliance .....               | 2-1   |
| 2.1 Overview of EPA’s Compliance Modeling Approach .....   | 2-2   |
| 2.1.1 OMEGA Compliance and Model Overview.....   | 2-3   |
| 2.1.2 OMEGA Version 2.0 .....  | 2-3   |
| 2.2 OMEGA2 Model Structure and Operation .....   | 2-7   |
| 2.2.1 Inputs and Outputs .....   | 2-7   |
| 2.2.2 Model Structure and Key Modules .....  | 2-7   |

|   |      |
|---|------|
| 2.2.3 Iteration and Convergence .....   | 2-8  |
| 2.2.4 Analysis Resolution .....   | 2-8  |
| 2.3 OMEGA2 Peer Review.....   | 2-9  |
| 2.3.1 Charge Questions for the Peer Review:.....  | 2-9  |
| 2.3.2 Information Received from Peer Review .....   | 2-9  |
| 2.4 ALPHA Full Vehicle Simulation and Response Surface Equations .....                      | 2-11 |
| 2.4.1 General Description of ALPHA.....   | 2-11 |
| 2.4.2 Overview of Previous Versions of ALPHA.....   | 2-12 |
| 2.4.3 Current version of ALPHA.....   | 2-13 |
| 2.4.4 ALPHA Models for Conventional and Electrified Vehicle Architectures .....             | 2-13 |
| 2.4.4.1 Conventional Vehicle Architecture.....  | 2-14 |
| 2.4.4.2 Hybrid Electric Vehicle (HEV) Architectures .....                                   | 2-15 |
| 2.4.4.2.1 Mild Hybrid Architectures .....   | 2-16 |
| 2.4.4.2.2 Strong Hybrid and PHEV Architectures.....   | 2-17 |
| 2.4.4.3 Battery Electric Vehicle Architecture (BEV) .....                                   | 2-20 |
| 2.4.5 Engine, E-motor, Transmission, and Battery Components .....                           | 2-21 |
| 2.4.5.1 Electric Drive Components.....  | 2-22 |
| 2.4.5.2 Transmissions .....   | 2-23 |
| 2.4.5.3 Batteries .....   | 2-24 |
| 2.4.6 Scaling rules for ALPHA input maps .....  | 2-25 |
| 2.4.7 Tuning ALPHA's Electrified Vehicle Models Using Vehicle Validations.....              | 2-26 |
| 2.4.7.1 Verifying the Validated Strong Hybrid and BEV Models against Variant Vehicles ..... | 2-30 |
| 2.4.7.2 P0 Mild Hybrid Validation Efforts .....   | 2-32 |
| 2.4.8 Verifying ALPHA's Ability to Simulate Entire Fleets .....                             | 2-33 |
| 2.4.8.1 Data Sources to Determine MY 2022 Light-Duty Fleet Parameters .....                 | 2-33 |
| 2.4.8.2 Vehicle Parameters .....  | 2-34 |
| 2.4.8.3 Electrified Powertrain Model Assignments .....                                      | 2-35 |
| 2.4.8.4 Modeling Conventional Vehicles in the Fleet .....                                   | 2-35 |
| 2.4.8.5 Modeling Mild Hybrids in the Fleet .....  | 2-37 |
| 2.4.8.6 Modeling Strong Hybrids in the Fleet .....  | 2-39 |
| 2.4.8.6.1 PowerSplit modeling (HEVs and Charge-Sustaining-Mode PHEVs).....                  | 2-39 |

|  |      |
|--|------|
| 2.4.8.6.2 P2 modeling (HEVs and Charge-Sustaining-Mode PHEVs).....   | 2-41 |
| 2.4.8.6.3 Charge depleting mode for PHEVs.....   | 2-42 |
| 2.4.8.7 Modeling Battery Electric Vehicles in the Fleet.....   | 2-43 |
| 2.4.8.8 Summary of ALPHA's Ability to Simulate Entire Fleets.....  | 2-45 |
| 2.4.9 Peer-Reviewing ALPHA Electrified Models.....   | 2-47 |
| 2.4.9.1 Charge Questions for the ALPHA Peer Review.....  | 2-48 |
| 2.4.9.2 Information Received from the Peer Review.....   | 2-49 |
| 2.4.10 Estimating CO <sub>2</sub> Emissions of Future Fleets.....  | 2-49 |
| 2.4.10.1 Technology Packages used to create RSEs for OMEGA.....  | 2-49 |
| 2.4.10.2 Vehicle Parameter Sweeps for each Technology Package.....   | 2-52 |
| 2.4.10.2.1 Swept Vehicle Parameters and Their Values.....  | 2-52 |
| 2.4.10.2.2 Values of Parameters Used for ALPHA Simulations.....  | 2-55 |
| 2.4.10.2.3 ALPHA Simulation Outputs for RSEs.....  | 2-55 |
| 2.4.10.3 Transforming ALPHA Simulation Outputs into RSEs for OMEGA.....  | 2-55 |
| 2.4.10.3.1 Steps to Create an RSE from the RSM.....  | 2-56 |
| 2.4.11 Illustration of Vehicle-specific CO <sub>2</sub> Performance Compared to Footprint CO <sub>2</sub> Targets..... | 2-57 |
| 2.5 Cost Methodology.....  | 2-60 |
| 2.5.1 Absolute vs. incremental cost approach.....  | 2-60 |
| 2.5.2 Direct manufacturing costs.....  | 2-61 |
| 2.5.2.1 Battery cost modeling methodology.....   | 2-61 |
| 2.5.2.1.1 Battery sizing.....  | 2-61 |
| 2.5.2.1.2 Battery costs for 2023 to 2035.....  | 2-62 |
| 2.5.2.1.3 Battery costs for 2036 to 2055.....  | 2-66 |
| 2.5.2.1.4 Battery cost reductions due to Inflation Reduction Act.....  | 2-66 |
| 2.5.2.2 Non-Battery Cost Approach.....   | 2-67 |
| 2.5.2.3 Powertrain Cost Scaling Exercise for ICE, HEV, PHEV, and all Electrified Vehicle Non-Battery Costs.....        | 2-69 |
| 2.5.3 Approach to cost reduction through manufacturer learning.....  | 2-69 |
| 2.5.4 Indirect costs.....  | 2-70 |
| 2.6 Inputs and Assumptions for Compliance Modeling.....  | 2-72 |
| 2.6.1 Powertrain Costs.....  | 2-72 |
| 2.6.1.1 Engine, exhaust and fuel system costs.....   | 2-73 |

|  |      |
|--|------|
| 2.6.1.1.1 Cylinder Deactivation .....  | 2-74 |
| 2.6.1.1.2 Atkinson Cycle Engine .....  | 2-74 |
| 2.6.1.1.3 Gasoline Particulate Filter.....                                     | 2-75 |
| 2.6.1.1.4 Three-way Catalyst .....   | 2-75 |
| 2.6.1.1.5 Diesel Exhaust Aftertreatment System .....                           | 2-76 |
| 2.6.1.2 Driveline System Costs for all Vehicles .....                          | 2-77 |
| 2.6.1.2.1 High Efficiency Alternator .....                                     | 2-78 |
| 2.6.1.2.2 Air Conditioning .....   | 2-78 |
| 2.6.1.3 Electrified Driveline System Costs for HEV, PHEV, and BEV .....        | 2-79 |
| 2.6.1.4 HEV and Mild HEV Battery Costs .....                                   | 2-80 |
| 2.6.1.5 BEV and PHEV Battery Costs.....  | 2-80 |
| 2.6.1.6 BEV Range Assumptions .....  | 2-81 |
| 2.6.1.7 PHEV Range Assumptions .....   | 2-81 |
| 2.6.1.8 Additional discussion of PHEV Architectures .....                      | 2-81 |
| 2.6.2 Glider Costs .....   | 2-83 |
| 2.6.3 Consumer demand assumptions and PEV acceptance.....                      | 2-85 |
| 2.6.4 Producer decision modeling and constraints for technology adoption ..... | 2-85 |
| 2.6.4.1 Redesign schedules .....   | 2-85 |
| 2.6.4.2 Materials and mineral availability .....                               | 2-86 |
| 2.6.4.3 Credit Banking.....  | 2-87 |
| 2.6.4.4 Credit Trading and Credit Market Efficiency.....                       | 2-88 |
| 2.6.4.5 Producer Generalized Costs and compliance cost minimization .....      | 2-89 |
| 2.6.5 Manufacturing capacity .....   | 2-90 |
| 2.6.6 Fuel and electricity prices used in OMEGA .....                          | 2-91 |
| 2.6.7 Gross Domestic Product Price Deflators .....                             | 2-94 |
| 2.6.8 Inflation Reduction Act.....   | 2-94 |
| Chapter 3: Analysis of Technology Feasibility .....                            | 3-1  |
| 3.1 Vehicle Technologies and Trends.....                                       | 3-1  |
| 3.1.1 Light-Duty Vehicle Technologies and Trends.....                          | 3-1  |
| 3.1.1.1 Advanced ICE technologies.....   | 3-1  |
| 3.1.1.2 Hybrid Electric Technologies .....                                     | 3-3  |
| 3.1.1.3 Plug-in Electric Vehicle Technologies .....                            | 3-4  |

|  |      |
|--|------|
| 3.1.2 Medium-duty Vehicle Technologies and Trends.....   | 3-9  |
| 3.1.3 Review of Light- and Medium-Duty PEV Feasibility.....  | 3-14 |
| 3.1.4 Additional Background on Critical Minerals and Manufacturing.....  | 3-21 |
| 3.1.4.1 Review of Key Developments Considered.....   | 3-22 |
| 3.1.4.2 Background on Global Distribution and Production of Critical Minerals.....   | 3-26 |
| 3.1.4.3 Enabling Approaches on Strengthening Supply Chains.....  | 3-31 |
| 3.1.5 Modeling Constraint on Rate of PEV Technology Penetration.....   | 3-34 |
| 3.2 Criteria and Toxic Pollutant Emissions Standards.....  | 3-38 |
| 3.2.1 NMOG+NO <sub>x</sub> Standards.....  | 3-40 |
| 3.2.1.1 NMOG+NO <sub>x</sub> Bin Structure for Light-Duty and MDV.....   | 3-40 |
| 3.2.1.2 Light-Duty NMOG+NO <sub>x</sub> Standards and Test Cycles.....   | 3-41 |
| 3.2.1.3 NMOG+NO <sub>x</sub> Standards for MDV.....  | 3-42 |
| 3.2.2 PM Standard for Light-Duty and Medium-Duty Vehicles.....   | 3-45 |
| 3.2.3 CO and Formaldehyde (HCHO) Standards.....  | 3-45 |
| 3.2.4 In-use Standards for High GCWR Medium-Duty Vehicles.....   | 3-47 |
| 3.2.4.1 Background on California ACC II/LEV IV Medium-Duty Vehicle In-use Standards.....   | 3-47 |
| 3.2.4.2 Background on Federal MAW Standards and Procedures for Light-Heavy-duty Engines and California Harmonization with Federal Standards..... | 3-48 |
| 3.2.4.3 In-Use Testing Requirements for Chassis-Certified High GCWR Medium-Duty Vehicles Using the Moving Average Window (MAW).....              | 3-48 |
| 3.2.4.4 Optional High GCWR Medium-Duty Vehicles Engine Certification.....  | 3-52 |
| 3.2.5 Feasibility of ICE-Based Vehicle NMOG+NO <sub>x</sub> Standards.....   | 3-52 |
| 3.2.5.1 Technologies that can reduce NMOG+NO <sub>x</sub> emissions.....   | 3-56 |
| 3.2.5.2 Changes in aftertreatment system hardware.....   | 3-57 |
| 3.2.5.2.1 Lower mass catalysts.....  | 3-57 |
| 3.2.5.2.2 Higher surface area catalysts.....   | 3-57 |
| 3.2.5.2.3 Advanced washcoat and PGM technology.....  | 3-57 |
| 3.2.5.2.4 HC traps, NO <sub>x</sub> adsorbers, and catalyzed filters.....  | 3-58 |
| 3.2.5.3 Changes in engine operation.....   | 3-58 |
| 3.2.5.3.1 Changing valve timing for initial engine start.....  | 3-59 |
| 3.2.5.3.2 Engine Speed.....  | 3-59 |
| 3.2.5.4 Addition of active catalyst heating.....   | 3-60 |

|  |      |
|--|------|
| 3.2.5.4.1 Electrically heated catalysts .....  | 3-60 |
| 3.2.5.4.2 Electrically Heated catalysts in HEVs and PHEVs .....                                      | 3-60 |
| 3.2.5.4.3 Exhaust burners.....   | 3-61 |
| 3.2.5.5 Solutions for Hybrids and PHEVs .....  | 3-61 |
| 3.2.5.6 Combinations of NMOG+NO <sub>x</sub> emissions reduction technologies .....                  | 3-62 |
| 3.2.5.6.1 Current ICE Emissions at -7°C FTP .....  | 3-63 |
| 3.2.5.6.2 Feasibility of a Single Numerical Standard for FTP, HFET, SC03 and US063-64                |      |
| 3.2.6 Particulate Matter Emissions Control .....   | 3-65 |
| 3.2.6.1 Overview of GPF Technology .....   | 3-65 |
| 3.2.6.2 GPF Benefits and Feasibility of the Standard.....  | 3-67 |
| 3.2.6.2.1 Setup and Test Procedures .....  | 3-68 |
| 3.2.6.2.2 PM Mass, BC, and PAH Emissions Reductions over a Composite Drive Cycle .....               | 3-70 |
| 3.2.6.2.3 Cycle-Specific Reduction in PM Mass Emissions from GPF Application to Three Vehicles ..... | 3-74 |
| 3.2.6.2.4 Laboratory Round Robin Reproducibility .....   | 3-77 |
| 3.2.6.3 Importance of Test Cycles .....  | 3-78 |
| 3.2.6.4 GPF Cost.....  | 3-80 |
| 3.2.6.5 GPF Impact on CO <sub>2</sub> Emissions.....   | 3-81 |
| 3.2.7 Refueling Standards for Incomplete Spark-Ignition Vehicles.....                                | 3-84 |
| 3.2.7.1 Technologies to Address Evaporative and Refueling Emissions .....                            | 3-85 |
| 3.2.7.2 Filler Pipe and Seal .....   | 3-86 |
| 3.2.7.3 ORVR Flow Control Valve .....  | 3-87 |
| 3.2.7.4 Canister .....   | 3-87 |
| 3.2.7.5 Purge Valve.....   | 3-87 |
| 3.2.7.6 Design considerations for Unique Fuel Tanks.....   | 3-88 |
| 3.2.7.7 Onboard Refueling Vapor Recovery Anticipated Costs.....                                      | 3-88 |
| 3.3 On-board Diagnostics .....   | 3-91 |
| 3.4 PHEV Accounting .....  | 3-91 |
| 3.4.1 Final Approach for the Revised PHEV Utility Factor .....                                       | 3-91 |
| 3.4.2 Overview of BAR dataset .....  | 3-92 |
| 3.4.2.1 Descriptions of Data Source and Filtering Method .....                                       | 3-93 |



|           |   |       |
|-----------|---|-------|
| 3.4.2.2   | Minimum VMT and Sample-Size Sensitivities .....   | 3-94  |
| 3.4.3     | Analyses of FUF based on BAR Dataset .....  | 3-95  |
| 3.4.3.1   | Basis for EPA’s Final Utility Factor .....  | 3-96  |
| 3.4.3.2   | FUF Comparisons with Real World Data .....  | 3-97  |
| 3.4.3.2.1 | Influence of Geographic Origin .....  | 3-98  |
| 3.4.3.2.2 | Influence of Gasoline Price .....   | 3-99  |
| 3.4.3.2.3 | Influence of Aggressive Driving Behaviors .....   | 3-101 |
| 3.4.3.2.4 | Influence of Data Filtering .....   | 3-104 |
| 3.4.3.2.5 | Influence of CD Blended Vehicle Miles Traveled on Electricity (eVMT) ....                         | 3-104 |
| 3.4.3.2.6 | FUF Curves on different CD Ranges .....   | 3-105 |
| 3.4.3.3   | Statistical Evaluation of FUF based on Real-World Data. ....                                      | 3-109 |
| 3.4.3.3.1 | Definitions of Utility Factor .....   | 3-110 |
| 3.4.3.3.2 | Estimation of Standard Error for the UF .....   | 3-110 |
| 3.4.3.3.3 | Comparison to the SAE J2841 Trend .....   | 3-113 |
| 3.4.3.3.4 | Influence of Gasoline Price .....   | 3-114 |
| 3.4.3.3.5 | Influence of Geographic Origin .....  | 3-115 |
| 3.4.4     | Other studies of FUF .....  | 3-115 |
| 3.4.5     | Consideration of CARB ACC II PHEV Provisions .....  | 3-116 |
| 3.5       | GHG Emissions Control Technologies .....  | 3-117 |
| 3.5.1     | Engine Technologies .....   | 3-117 |
| 3.5.1.1   | 2013 Chevrolet 2.5L Ecotec LCV Engine Reg E10 Fuel .....  | 3-117 |
| 3.5.1.2   | GT Power Baseline 2020 Ford 7.3L Engine from Argonne Report Tier 3 Fuel ..                        | 3-118 |
| 3.5.1.3   | 2013 Ford 1.6L EcoBoost Engine LEV III Fuel .....   | 3-119 |
| 3.5.1.4   | 2015 Ford 2.7L EcoBoost Engine Tier 3 Fuel .....  | 3-121 |
| 3.5.1.5   | 2016 Honda 1.5L L15B7 Engine Tier 3 Fuel .....  | 3-122 |
| 3.5.1.6   | Volvo VEP 2.0L LP Gen3 Miller Engine from 2020 Aachen Paper Octane Modified for Tier 3 Fuel ..... | 3-123 |
| 3.5.1.7   | Geely 1.5L Miller GHE from 2020 Aachen Paper Octane Modified for Tier 3 Fuel .....                | 3-124 |
| 3.5.1.8   | 2018 Toyota 2.5L A25A-FKS Engine Tier 3 Fuel .....  | 3-125 |

|   |       |
|---|-------|
| 3.5.1.9 Toyota 2.5L TNGA Prototype Hybrid Engine from 2017 Vienna Paper Octane Modified for Tier 3 Fuel .....                 | 3-126 |
| 3.5.1.10 GT Power 2020 GM 3.0L Duramax Engine from Argonne Report Diesel Fuel. 3-127  |       |
| 3.5.1.11 Future 3.6L HLA Hybrid Concept Engine Tier 3 Fuel.....   | 3-128 |
| 3.5.1.12 Future 6.0L HLA Hybrid Concept Engine Tier 3 Fuel.....   | 3-129 |
| 3.5.1.13 2014 Chevrolet 4.3L EcoTec3 LV3 Engine LEVIII Fuel.....  | 3-130 |
| 3.5.2 Electrification Technologies .....  | 3-131 |
| 3.5.2.1 2010 Toyota Prius 60kW 650V MG2 EMOT.....   | 3-131 |
| 3.5.2.2 EST 2010 Toyota Prius 60kW 650V MG1 EMOT .....  | 3-132 |
| 3.5.2.3 2011 Hyundai Sonata 30kW 270V EMOT.....   | 3-133 |
| 3.5.2.4 2012 Hyundai Sonata 8.5kW 270V BISG .....   | 3-134 |
| 3.5.2.5 Generic IPM 150kW 350V EDU .....  | 3-135 |
| 3.5.2.6 Three IPM Electric Motor/Inverters (EMOTs) used to Simulate Future LD PHEVs and MD PHEVs with Towing Capability ..... | 3-136 |
| 3.5.3 Vehicle Architectures.....  | 3-136 |
| 3.5.3.1 Heavy-light-duty and Medium-duty Range-extended Electric Truck (REET) Study .....                                     | 3-137 |
| 3.5.3.1.1 LDT4 Range-extended Electric Truck (REET).....  | 3-137 |
| 3.5.3.1.2 MDV Range-extended Electric Truck REET .....  | 3-141 |
| 3.5.4 Other Vehicle Technologies .....  | 3-145 |
| 3.6 Vehicle Air Conditioning System Related Provisions.....   | 3-145 |
| 3.6.1 A/C Leakage Credit .....  | 3-145 |
| 3.6.2 How Will Leakage Credits Be Calculated? .....   | 3-146 |
| 3.7 Fuel Economy Test Procedure Adjustments for Tier 3 Test Fuel .....  | 3-150 |
| 3.7.1 Summary of EPA Test Program and Results.....  | 3-150 |
| 3.7.1.1 Discussion of Results.....  | 3-154 |
| 3.7.2 Development of Adjustment Factors .....   | 3-157 |
| 3.7.2.1 CO <sub>2</sub> Adjustment Factor.....  | 3-157 |
| 3.7.2.2 Analysis of Fuel Economy Data and Development of Adjusted Equation.....   | 3-159 |
| Chapter 4: Consumer Impacts and Related Economic Considerations .....   | 4-1   |
| 4.1 Modeling the Vehicle Choice within the Purchase Decision.....   | 4-1   |
| 4.1.1 Cost Elements of the Purchase Decision .....  | 4-2   |

|  |      |
|--|------|
| 4.1.2 Estimating Market Shares .....   | 4-5  |
| 4.1.2.1 Consumer Choice.....   | 4-5  |
| 4.1.2.2 Consumer Response to Costs and Acceptance of Technology .....                                  | 4-7  |
| 4.1.2.2.1 Response to Costs: More on the logit parameter .....   | 4-7  |
| 4.1.2.2.2 Acceptance of Technology: Background and Shareweight Estimates .....                         | 4-8  |
| 4.1.2.2.2.1 Research on Consumer Acceptance of Light-Duty PEVs .....                                   | 4-8  |
| 4.1.2.2.2.2 Market Observations.....   | 4-9  |
| 4.1.2.2.2.3 EPA Analyses: Cross References and Robustness .....  | 4-10 |
| 4.1.2.2.2.4 Diffusion of Innovation.....   | 4-11 |
| 4.1.2.2.2.5 Shareweights .....   | 4-12 |
| 4.1.3 BEV Acceptance Sensitivities .....   | 4-17 |
| 4.2 Ownership Experience .....   | 4-22 |
| 4.2.1 Vehicle Miles Traveled and Rebound Effect.....   | 4-22 |
| 4.2.1.1 Basis for Vehicle Miles Traveled for Battery Electric Vehicles.....                            | 4-23 |
| 4.2.1.2 Basis for the Rebound Effect for Internal Combustion Engines and PHEVs....                     | 4-25 |
| 4.2.1.3 Basis for Rebound Effect for Battery Electric Vehicles .....                                   | 4-25 |
| 4.2.2 Consumer Savings and Expenses.....   | 4-26 |
| 4.2.2.1 Vehicle Lifetime Savings and Expenses Under the Standards Compared to the MY2026 Standard..... | 4-30 |
| 4.2.2.2 Eight Year Savings and Expenses Under the Final Standards for PEVs and ICE Vehicles.....       | 4-32 |
| 4.2.3 Other Ownership Considerations .....   | 4-35 |
| 4.3 Consumer-Related Benefits and Costs.....   | 4-37 |
| 4.3.1 Vehicle Technology Cost Impacts .....  | 4-37 |
| 4.3.2 Value of Rebound Driving.....  | 4-38 |
| 4.3.3 Fuel Consumption.....  | 4-39 |
| 4.3.4 Monetized Fuel Savings.....  | 4-40 |
| 4.3.5 Benefits Associated with the Time Spent Refueling .....  | 4-41 |
| 4.3.6 Insurance Costs .....  | 4-46 |
| 4.3.7 Maintenance and Repair Costs.....  | 4-47 |
| 4.3.7.1 Maintenance Costs .....  | 4-47 |
| 4.3.7.2 Repair Costs .....   | 4-52 |
| 4.3.8 Costs Associated with Noise and Congestion.....  | 4-54 |

|   |      |
|---|------|
| 4.4 New Vehicle Sales .....   | 4-56 |
| 4.4.1 How Sales Impacts Were Modeled.....   | 4-59 |
| 4.4.1.1 The Role of Fuel Consumption in Vehicle Sales Estimates .....                           | 4-60 |
| 4.4.1.2 Elasticity of Demand.....   | 4-61 |
| 4.4.2 New LD Vehicle Sales Estimates .....  | 4-62 |
| 4.5 Employment.....   | 4-65 |
| 4.5.1 Background and Literature .....   | 4-65 |
| 4.5.2 Potential Employment Impacts from the Increasing Penetration of Electric Vehicles. 4-67   |      |
| 4.5.3 Potential Employment Impacts of the Standards.....  | 4-69 |
| 4.5.3.1 The Factor Shift Effect.....  | 4-71 |
| 4.5.3.2 The Demand Effect .....   | 4-73 |
| 4.5.3.3 The Cost Effect .....   | 4-73 |
| 4.5.4 Partial Employment Effects of the Standards .....   | 4-76 |
| 4.5.5 Employment Impacts on Related Sectors .....   | 4-81 |
| Chapter 5: Electric Power Sector and Infrastructure Impacts.....                                | 5-1  |
| 5.1 Modeling PEV Charge Demand and Regional Distribution.....                                   | 5-1  |
| 5.1.1 PEV Disaggregation and Charging Simulation .....  | 5-2  |
| 5.2 Electric Power Sector Modeling .....  | 5-10 |
| 5.2.1 Estimating Retail Electricity Prices .....  | 5-10 |
| 5.2.2 IPM emissions post-processing.....  | 5-11 |
| 5.2.3 IPM National-level Demand, Generation, Emissions and Costs .....                          | 5-11 |
| 5.2.3.1 Power Sector Impacts of the BIL and IRA .....   | 5-11 |
| 5.2.3.2 Power Sector Modeling Results for the Final Rule .....                                  | 5-12 |
| 5.2.4 Retail Price Modeling Results .....   | 5-18 |
| 5.2.5 New Builds, Retrofits and Retirements of EGUs .....                                       | 5-20 |
| 5.2.6 Interregional Dispatch.....   | 5-22 |
| 5.2.7 Regional Comparison of No Action and Final Rule IPM Emissions and Generation Results..... | 5-23 |
| 5.3 Assessment of PEV Charging Infrastructure .....   | 5-30 |
| 5.3.1 Status and Outlook for PEV Charging Infrastructure .....                                  | 5-31 |
| 5.3.1.1 Definitions.....  | 5-31 |
| 5.3.1.2 Charging Types.....   | 5-31 |

|   |      |
|---|------|
| 5.3.1.2.1 PEV Charging Infrastructure Status and Trends.....                            | 5-32 |
| 5.3.1.3 PEV Charging Infrastructure Investments .....                                   | 5-33 |
| 5.3.1.3.1 Bipartisan Infrastructure Law .....   | 5-34 |
| 5.3.1.3.2 Inflation Reduction Act.....  | 5-35 |
| 5.3.1.3.3 Equity Considerations in BIL and IRA.....                                     | 5-35 |
| 5.3.1.3.4 Other Public and Private Investments.....                                     | 5-36 |
| 5.3.2 PEV Charging Infrastructure Cost Analysis .....                                   | 5-37 |
| 5.3.2.1 Charging Demand Projections .....   | 5-38 |
| 5.3.2.2 Projected EVSE Port Needs.....  | 5-40 |
| 5.3.2.3 EVSE Cost Approach .....  | 5-43 |
| 5.3.2.4 Hardware & Installation Costs per EVSE Port.....                                | 5-43 |
| 5.3.2.4.1 Home Charging.....  | 5-44 |
| 5.3.2.4.2 Depot Charging.....   | 5-45 |
| 5.3.2.4.3 Work and Public Charging.....   | 5-45 |
| 5.3.2.5 Will Costs Change Over Time? .....  | 5-46 |
| 5.3.2.6 PEV Charging Infrastructure Cost Summary .....                                  | 5-46 |
| 5.4 Grid Reliability .....  | 5-47 |
| 5.4.1 Factors Affecting Distribution Grid Reliability.....                              | 5-52 |
| 5.4.2 Distribution Grid Reliability Continues to Improve .....                          | 5-54 |
| 5.4.3 Transportation Electrification Impact Study.....                                  | 5-55 |
| 5.4.3.1 TEIS Results .....  | 5-57 |
| 5.4.4 Transmission Improvements Increase Grid Reliability .....                         | 5-62 |
| 5.4.5 Electric Generation Will Continue To Be Reliable Under this Final Rule.....       | 5-63 |
| Chapter 6: Health and Welfare Impacts.....  | 6-1  |
| 6.1 Climate Change Impacts from GHG Emissions .....                                     | 6-1  |
| 6.2 Climate Benefits.....   | 6-6  |
| 6.3 Health Effects Associated with Exposure to Criteria and Air Toxics Pollutants ..... | 6-15 |
| 6.3.1 Particulate Matter.....   | 6-16 |
| 6.3.1.1 Background on Particulate Matter .....  | 6-16 |
| 6.3.1.2 Health Effects Associated with Exposure to Particulate Matter.....              | 6-16 |
| 6.3.2 Ozone .....   | 6-20 |
| 6.3.2.1 Background on Ozone.....  | 6-20 |

|  |      |
|--|------|
| 6.3.2.2 Health Effects Associated with Exposure to Ozone .....                           | 6-21 |
| 6.3.3 Nitrogen Oxides .....  | 6-22 |
| 6.3.3.1 Background on Nitrogen Oxides .....  | 6-22 |
| 6.3.3.2 Health Effects Associated with Exposure to Nitrogen Oxides .....                 | 6-22 |
| 6.3.4 Sulfur Oxides .....  | 6-23 |
| 6.3.4.1 Background on Sulfur Oxides.....   | 6-23 |
| 6.3.4.2 Health Effects Associated with Exposure to Sulfur Oxides .....                   | 6-23 |
| 6.3.5 Carbon Monoxide .....  | 6-24 |
| 6.3.5.1 Background on Carbon Monoxide.....   | 6-24 |
| 6.3.5.2 Health Effects Associated with Exposure to Carbon Monoxide .....                 | 6-24 |
| 6.3.6 Diesel Exhaust .....   | 6-26 |
| 6.3.6.1 Background on Diesel Exhaust.....  | 6-26 |
| 6.3.6.2 Health Effects Associated with Exposure to Diesel Exhaust.....                   | 6-26 |
| 6.3.7 Air Toxics .....   | 6-28 |
| 6.3.7.1 Health Effects Associated with Exposure to Acetaldehyde.....                     | 6-28 |
| 6.3.7.2 Health Effects Associated with Exposure to Benzene .....                         | 6-28 |
| 6.3.7.3 Health Effects Associated with Exposure to 1,3-Butadiene .....                   | 6-29 |
| 6.3.7.4 Health Effects Associated with Exposure to Formaldehyde.....                     | 6-30 |
| 6.3.7.5 Health Effects Associated with Exposure to Naphthalene .....                     | 6-31 |
| 6.3.7.6 Health Effects Associated with Exposure to PAHs/POM .....                        | 6-32 |
| 6.3.8 Exposure and Health Effects Associated with Traffic.....                           | 6-32 |
| 6.4 Welfare Effects Associated with Exposure to Criteria and Air Toxics Pollutants ..... | 6-36 |
| 6.4.1 Visibility Degradation.....  | 6-36 |
| 6.4.1.1 Visibility Monitoring .....  | 6-38 |
| 6.4.2 Plant and Ecosystem Effects of Ozone .....   | 6-39 |
| 6.4.3 Deposition.....  | 6-40 |
| 6.4.3.1 Deposition of Nitrogen and Sulfur.....   | 6-40 |
| 6.4.3.1.1 Ecological Effects of Acidification.....                                       | 6-41 |
| 6.4.3.1.1.1 Aquatic Acidification.....   | 6-42 |
| 6.4.3.1.1.2 Terrestrial Acidification.....   | 6-42 |
| 6.4.3.1.2 Ecological Effects from Nitrogen Enrichment .....                              | 6-43 |
| 6.4.3.1.2.1 Aquatic Enrichment .....   | 6-43 |

|  |      |
|--|------|
| 6.4.3.1.2.2 Terrestrial Enrichment .....   | 6-43 |
| 6.4.3.1.3 Vegetation Effects Associated with Gaseous Sulfur Dioxide, Nitric Oxide,<br>Nitrogen Dioxide, Peroxyacetyl Nitrate, and Nitric Acid..... | 6-44 |
| 6.4.3.1.4 Mercury Methylation .....  | 6-44 |
| 6.4.3.2 Deposition of Metallic and Organic Constituents of PM .....  | 6-45 |
| 6.4.3.3 Materials Damage and Soiling.....  | 6-46 |
| 6.4.4 Welfare Effects of Air Toxics.....   | 6-47 |
| 6.5 Criteria Pollutant Human Health Benefits .....   | 6-47 |
| 6.5.1 Approach to Estimating Human Health Benefits.....  | 6-49 |
| 6.5.2 Estimating PM <sub>2.5</sub> -attributable Adult Premature Death .....   | 6-52 |
| 6.5.3 Economic Value of Health Benefits .....  | 6-53 |
| 6.5.4 Dollar Value per Ton of Directly-Emitted PM <sub>2.5</sub> and PM <sub>2.5</sub> Precursors.....   | 6-54 |
| 6.5.5 Characterizing Uncertainty in the Estimated Benefits.....  | 6-56 |
| 6.5.6 Benefit-per-Ton Estimate Limitations .....   | 6-57 |
| Chapter 7: Analysis of Air Quality Impacts of Light- and Medium-Duty Vehicles Regulatory<br>Scenario.....  | 7-1  |
| 7.1 Current Air Quality .....  | 7-1  |
| 7.1.1 PM <sub>2.5</sub> Concentrations .....   | 7-1  |
| 7.1.2 Ozone Concentrations.....  | 7-2  |
| 7.1.3 NO <sub>2</sub> Concentrations .....   | 7-4  |
| 7.1.4 SO <sub>2</sub> Concentrations.....  | 7-4  |
| 7.1.5 CO Concentrations.....   | 7-5  |
| 7.1.6 Air Toxics Concentrations .....  | 7-5  |
| 7.1.7 Deposition .....   | 7-6  |
| 7.1.8 Visibility .....   | 7-6  |
| 7.2 Emissions Modeling for Air Quality Analysis.....   | 7-6  |
| 7.2.1 Onroad Vehicle Emission Estimates with MOVES.....  | 7-7  |
| 7.2.1.1 Overview.....  | 7-7  |
| 7.2.1.2 MOVES versions used for air quality modeling.....  | 7-7  |
| 7.2.1.3 Modeling the Reference scenario with MOVES .....   | 7-8  |
| 7.2.1.4 Modeling the Policy scenario with MOVES .....  | 7-8  |
| 7.2.1.4.1 EV sales and stock .....   | 7-8  |
| 7.2.1.4.2 Internal Combustion Engine Vehicle Energy Consumption.....   | 7-9  |

|   |      |
|---|------|
| 7.2.1.4.3 ICEV HC and NO <sub>x</sub> .....                                   | 7-9  |
| 7.2.1.4.4 ICEV PM rates .....   | 7-10 |
| 7.2.1.4.4.1 PM emission reduction fractions .....                             | 7-10 |
| 7.2.1.4.4.2 PM reduction phase-in .....                                       | 7-11 |
| 7.2.1.4.4.3 PM update for LEV rates .....                                     | 7-11 |
| 7.2.2 Upstream Emission Estimates for AQ Modeling.....                        | 7-11 |
| 7.2.2.1 Electricity Generating Units (EGUs) .....                             | 7-12 |
| 7.2.2.2 Refineries .....  | 7-13 |
| 7.2.2.3 Crude Production Well Sites and Pipeline Pumps.....                   | 7-14 |
| 7.2.2.4 Natural Gas Production Well Sites and Pipeline Pumps .....            | 7-14 |
| 7.2.2.5 Limitations of the Upstream Inventory.....                            | 7-15 |
| 7.2.3 Combined Onroad and Upstream Emission Impacts.....                      | 7-15 |
| 7.3 Air Quality Modeling Methodology .....                                    | 7-16 |
| 7.3.1 Air Quality Model.....  | 7-16 |
| 7.3.2 Model Domain and Configuration .....                                    | 7-16 |
| 7.3.3 Model Inputs .....  | 7-18 |
| 7.3.4 Model Evaluation.....   | 7-19 |
| 7.3.5 Model Simulation Scenarios .....  | 7-19 |
| 7.4 Results of Air Quality Analysis .....                                     | 7-20 |
| 7.4.1 PM <sub>2.5</sub> .....   | 7-20 |
| 7.4.1.1 Overall Projected PM <sub>2.5</sub> Impacts.....                      | 7-20 |
| 7.4.1.2 Onroad-Only Projected PM <sub>2.5</sub> Impact .....                  | 7-21 |
| 7.4.1.3 Projected Annual PM <sub>2.5</sub> Design Value Impacts in 2055 ..... | 7-22 |
| 7.4.2 Ozone .....   | 7-23 |
| 7.4.2.1 Overall Projected Ozone Impacts .....                                 | 7-23 |
| 7.4.2.2 Onroad-Only Projected Ozone Impacts .....                             | 7-24 |
| 7.4.2.3 Projected Ozone Design Value Impacts in 2055 .....                    | 7-25 |
| 7.4.3 NO <sub>2</sub> .....   | 7-26 |
| 7.4.3.1 Overall Projected NO <sub>2</sub> Impacts .....                       | 7-26 |
| 7.4.3.2 Onroad-Only Projected NO <sub>2</sub> Impacts.....                    | 7-27 |
| 7.4.4 SO <sub>2</sub> .....   | 7-28 |
| 7.4.4.1 Overall Projected SO <sub>2</sub> Impacts.....                        | 7-28 |



|  |      |
|--|------|
| 7.4.4.2 Onroad-Only Projected SO <sub>2</sub> Impacts .....                    | 7-29 |
| 7.4.5 Carbon Monoxide .....  | 7-30 |
| 7.4.5.1 Overall Projected CO Impacts .....                                     | 7-30 |
| 7.4.5.2 Onroad-only projected CO impacts of rulemaking.....                    | 7-31 |
| 7.4.6 Air Toxics .....   | 7-32 |
| 7.4.6.1 Overall Projected Air Toxics Impacts.....                              | 7-32 |
| 7.4.6.2 Onroad-Only Projected Air Toxics Impacts .....                         | 7-39 |
| 7.4.7 Deposition .....   | 7-45 |
| 7.4.7.1 Overall Projected Nitrogen and Sulfur Deposition Impacts .....         | 7-45 |
| 7.4.7.2 Onroad-Only Projected Nitrogen and Sulfur Deposition Impacts .....     | 7-46 |
| 7.5 Ozone and Particulate Matter Health Benefits.....                          | 7-48 |
| 7.6 Demographic Analysis.....  | 7-54 |
| 7.6.1 Overview .....   | 7-54 |
| 7.6.2 Air Quality, Population and Demographic Data.....                        | 7-54 |
| 7.6.3 National Population-Weighted Average Concentration Analysis .....        | 7-57 |
| 7.6.4 National Distributional Analysis.....                                    | 7-61 |
| 7.6.5 Uncertainty in the Demographic Analysis .....                            | 7-64 |
| Chapter 8: OMEGA Physical Effects of the Final Standards and Alternatives..... | 8-1  |
| 8.1 The OMEGA "Context".....   | 8-1  |
| 8.2 The Analysis Fleet and the Legacy Fleet.....                               | 8-2  |
| 8.3 Estimating Vehicle, Fleet, and Rebound VMT.....                            | 8-6  |
| 8.3.1 OMEGA "Context" VMT .....  | 8-8  |
| 8.3.2 Context Fuel Costs Per Mile .....  | 8-8  |
| 8.3.3 Rebound VMT .....  | 8-9  |
| 8.3.4 Summary of VMT in the Analysis.....                                      | 8-10 |
| 8.4 Estimating Safety Effects.....   | 8-12 |
| 8.4.1 Fatality Rates used in OMEGA .....                                       | 8-13 |
| 8.4.2 Calculating Safety Effects tied to Vehicle Weight Changes .....          | 8-14 |
| 8.4.3 Calculating Fatalities .....   | 8-17 |
| 8.4.4 Summary of Safety Effects in the Analysis .....                          | 8-17 |
| 8.5 Estimating Fuel Consumption in OMEGA.....                                  | 8-19 |
| 8.5.1 Drive Cycles for Onroad Fuel Consumption .....                           | 8-19 |

|  |      |
|--|------|
| 8.5.2 Electricity Consumption .....                                    | 8-26 |
| 8.5.3 Liquid-Fuel Consumption.....                                     | 8-26 |
| 8.5.4 Summary of Fuel and Electricity Consumption in the Analysis..... | 8-28 |
| 8.6 Estimating Emission Inventories in OMEGA.....                      | 8-31 |
| 8.6.1 Calculating EGU Emission Rates in OMEGA .....                    | 8-31 |
| 8.6.2 Calculating Refinery Emission Rates in OMEGA.....                | 8-33 |
| 8.6.3 Vehicle Emission Rates in OMEGA.....                             | 8-37 |
| 8.6.4 Calculating Upstream Emission Inventories.....                   | 8-38 |
| 8.6.4.1 Electric Generating Units.....                                 | 8-38 |
| 8.6.4.2 Refineries .....   | 8-39 |
| 8.6.5 Calculating Vehicle Emission Inventories.....                    | 8-45 |
| 8.6.6 Summary of Inventories and Inventory Impacts.....                | 8-46 |
| 8.6.6.1 Greenhouse Gas Inventory Impacts .....                         | 8-46 |
| 8.6.6.2 Criteria Air Pollutant Inventory Impacts .....                 | 8-52 |
| 8.7 Estimating Energy Security Effects .....                           | 8-61 |
| 8.7.1 Calculating Oil Consumption from Fuel Consumption.....           | 8-61 |
| 8.7.2 Calculating Oil Imports from Oil Consumption .....               | 8-61 |
| 8.7.3 Summary of Energy Security Effects .....                         | 8-64 |
| Chapter 9: Costs and Benefits of the Final Standards in OMEGA.....     | 9-1  |
| 9.1 Costs.....   | 9-1  |
| 9.2 Fuel Savings.....  | 9-3  |
| 9.3 Non-Emission Benefits .....  | 9-5  |
| 9.4 Benefits of GHG Reductions .....                                   | 9-7  |
| 9.5 Criteria Air Pollutant Benefits .....                              | 9-18 |
| 9.6 Summary and Net Benefits .....                                     | 9-21 |
| 9.7 Transfers .....  | 9-25 |
| Appendix to Chapter 9 .....  | 9-1  |
| Chapter 10: Energy Security Impacts .....                              | 10-1 |
| 10.1 Review of Historical Energy Security Literature.....              | 10-2 |
| 10.2 Review of Recent Energy Security Literature .....                 | 10-4 |
| 10.2.1 Recent Oil Security Studies .....                               | 10-4 |
| 10.2.2 Recent Tight (i.e., Shale) Oil Studies .....                    | 10-7 |

|   |       |
|---|-------|
| 10.2.3 Recent Electricity Security Studies.....   | 10-10 |
| 10.2.3.1 Fuel Costs.....  | 10-11 |
| 10.2.3.2 Fuel Price Stability/Volatility .....  | 10-13 |
| 10.2.3.3 Electricity Reliability/Resiliency .....   | 10-14 |
| 10.2.3.4 Energy Independence.....   | 10-17 |
| 10.3 Electricity Security Impacts.....  | 10-18 |
| 10.3.1 Recent Fuel Costs for Gasoline-Powered Vehicles Compared to PEVs in the U.S. 10-19 |       |
| 10.3.1.1 National (i.e., U.S.) Analysis .....   | 10-19 |
| 10.3.1.2 State-Level Analysis .....   | 10-21 |
| 10.3.2 Fuel Price Stability/Volatility .....  | 10-22 |
| 10.3.3 Energy Independence.....   | 10-24 |
| 10.4 Oil Security Impacts .....   | 10-26 |
| 10.4.1 U.S. Oil Import Reductions .....   | 10-26 |
| 10.4.2 Oil Security Premiums Used for this Final Rule .....                               | 10-28 |
| 10.4.3 Cost of Existing U.S. Oil Security Policies .....                                  | 10-33 |
| 10.4.4 Oil Security Benefits of the Final Rule.....                                       | 10-35 |
| Chapter 11: Small Business Flexibilities .....  | 11-1  |
| Chapter 12: Compliance Effects .....  | 12-1  |
| 12.1 Light-Duty Vehicles.....   | 12-1  |
| 12.1.1 GHG Targets and Compliance Levels .....  | 12-1  |
| 12.1.1.1 CO <sub>2</sub> g/mi .....   | 12-1  |
| 12.1.1.1.1 Final standards .....  | 12-1  |
| 12.1.1.1.2 Alternative A.....   | 12-5  |
| 12.1.1.1.3 Alternative B.....   | 12-8  |
| 12.1.1.2 CO <sub>2</sub> Mg.....  | 12-12 |
| 12.1.1.2.1 Final standards .....  | 12-12 |
| 12.1.1.2.2 Alternative A.....   | 12-16 |
| 12.1.1.2.3 Alternative B.....   | 12-20 |
| 12.1.2 Projected Manufacturing Costs per Vehicle .....                                    | 12-24 |
| 12.1.2.1 Final GHG Standards.....   | 12-24 |
| 12.1.2.2 Alternative A.....   | 12-26 |

|   |       |
|---|-------|
| 12.1.2.3 Alternative B.....                                   | 12-28 |
| 12.1.3 Technology Penetration Rates .....                     | 12-30 |
| 12.1.3.1 No Action Case.....                                  | 12-30 |
| 12.1.3.2 Final Standards.....                                 | 12-35 |
| 12.1.3.3 Alternative A.....                                   | 12-39 |
| 12.1.3.4 Alternative B.....                                   | 12-43 |
| 12.1.4 Light-Duty Vehicle Sensitivities.....                  | 12-47 |
| 12.1.4.1 State-level ZEV Policies (ACC II) .....              | 12-47 |
| 12.1.4.2 Battery Costs.....                                   | 12-48 |
| 12.1.4.2.1 Low Battery Costs.....                             | 12-48 |
| 12.1.4.2.2 High Battery Costs.....                            | 12-48 |
| 12.1.4.3 Consumer Acceptance .....                            | 12-49 |
| 12.1.4.3.1 Faster BEV Acceptance .....                        | 12-49 |
| 12.1.4.3.2 Slower BEV Acceptance.....                         | 12-50 |
| 12.1.4.4 No Credit Trading Case .....                         | 12-50 |
| 12.1.4.5 Alternative Manufacturer Pathways .....              | 12-51 |
| 12.1.4.5.1 Lower BEV Production.....                          | 12-51 |
| 12.1.4.5.2 No Additional BEVs Beyond the No Action Case ..... | 12-52 |
| 12.2 Medium-Duty Vehicles.....                                | 12-53 |
| 12.2.1 GHG Targets and Compliance Levels .....                | 12-53 |
| 12.2.1.1 CO <sub>2</sub> g/mi .....                           | 12-53 |
| 12.2.1.1.1 Final Standards.....                               | 12-53 |
| 12.2.1.2 CO <sub>2</sub> Mg.....                              | 12-54 |
| 12.2.1.2.1 Final Standards.....                               | 12-54 |
| 12.2.2 Projected Manufacturing Costs per Vehicle .....        | 12-56 |
| 12.2.2.1 Final Standards.....                                 | 12-56 |
| 12.2.3 Technology Penetration Rates .....                     | 12-57 |
| 12.2.3.1 No Action Case.....                                  | 12-57 |
| 12.2.3.2 Final Standards.....                                 | 12-59 |
| 12.2.4 Medium-Duty Vehicle Sensitivities.....                 | 12-60 |
| 12.2.4.1 Battery Costs.....                                   | 12-60 |
| 12.2.4.1.1 Low Battery Costs.....                             | 12-60 |

12.2.4.1.2 High Battery Costs ..... 12-61  
12.2.4.2 No Credit Trading Case ..... 12-62  
12.3 Additional Illustrative Scenarios..... 12-63  
12.3.1 No New BEVs Above Base Year MY 2022 Fleet - Light-Duty Vehicles..... 12-63  
12.3.2 No New BEVs Above Base Year MY 2022 Fleet - Medium-Duty Vehicles..... 12-63

## List of Tables

|  |      |
|--|------|
| Table 1-1. Comparison of Car and Truck GHG Targets for 50 Square-Foot Vehicles .....   | 1-3  |
| Table 1-2: Comparison of MY 2032 Footprint to Base Year Footprint, Final Standards .....   | 1-16 |
| Table 1-3: GHG Emissions Comparison of LD and MD pickup.....   | 1-19 |
| Table 1-4: Final coefficients for MDV GHG standards for $WF \leq 5,500$ pounds.....  | 1-24 |
| Table 1-5: Final coefficients for MDV GHG standards for $WF > 5,500$ pounds.....   | 1-24 |
| Table 1-6. Battery durability performance requirements of UN GTR No. 22.....   | 1-27 |
| Table 1-7. CARB ACC II battery durability requirements.....  | 1-28 |
| Table 1-8. CARB battery warranty requirements .....  | 1-28 |
| Table 2-1: OMEGA topics and their RIA Chapter locations.....   | 2-6  |
| Table 2-2: Percentage breakdown of mild and strong hybrids in the MY 2022 light-duty vehicle fleet .....   | 2-16 |
| Table 2-3: Engine ALPHA input maps used to create ALPHA outputs for RSEs .....   | 2-22 |
| Table 2-4: Electric motor/related ALPHA input maps for electrified vehicles used to create ALPHA outputs for RSEs.....   | 2-23 |
| Table 2-5: Transmission ALPHA inputs used to create ALPHA outputs for RSEs.....  | 2-24 |
| Table 2-6: Battery ALPHA inputs used to create ALPHA outputs for RSEs .....  | 2-24 |
| Table 2-7: Table of test data vehicles used to validate ALPHA.....   | 2-26 |
| Table 2-8: Percent difference of ALPHA vehicle validation simulation versus benchmarking test data.....  | 2-28 |
| Table 2-9: Comparison of ALPHA results from SP-P4 Strong HEV/PHEV and P2-P4 PHEV models to the results from the GT-Drive versions of these model in EPA's REET study (Bhattacharjya, et al. 2023)..... | 2-29 |
| Table 2-10: Percent difference of variant vehicle ALPHA simulations versus certification data.....   | 2-31 |
| Table 2-11: Estimated CO <sub>2</sub> reductions with both P0 mild hybrid & engine start-stop technologies applied to the comparable conventional vehicle.....   | 2-33 |
| Table 2-12: Powertrain components and categories.....  | 2-34 |
| Table 2-13: Vehicle Parameters.....  | 2-34 |
| Table 2-14: Vehicle model type assignments in MY 2022 light-duty fleet.....  | 2-35 |
| Table 2-15: Assignments of engines used to simulate MY 2022 base year fleet conventional vehicle model types, based on engines in Table 2-3.....   | 2-36 |

|   |      |
|---|------|
| Table 2-16: Transmissions used to simulate MY 2022 base year fleet conventional vehicles, based on transmissions given in Table 2-5. ....                                       | 2-36 |
| Table 2-17: Conventional vehicle model type in the MY 2022 fleet - ALPHA CO <sub>2</sub> g/mile values versus certification CO <sub>2</sub> g/mile. ....                        | 2-37 |
| Table 2-18: P0 mild hybrids in the MY 2022 fleet - ALPHA CO <sub>2</sub> g/mile values versus certification CO <sub>2</sub> g/mile. ....  | 2-38 |
| Table 2-19: PowerSplit HEVs and PS PHEVs in Charge-Sustaining-Mode in the MY 2022 fleet - ALPHA CO <sub>2</sub> g/mile values versus certification CO <sub>2</sub> g/mile. .... | 2-40 |
| Table 2-20: P2 HEVs and P2 PHEVs in Charge-Sustaining-Mode in the MY 2022 fleet - ALPHA CO <sub>2</sub> g/mile values versus certification CO <sub>2</sub> g/mile. ....         | 2-41 |
| Table 2-21: PowerSplit and P2 PHEV both in Charge-Depleting-Mode in the MY 2022 fleet - ALPHA kWh/100 miles values versus certification kWh/100 miles. ....                     | 2-43 |
| Table 2-22: BEVs in the MY 2022 fleet - ALPHA kWh/100 miles values versus certification kWh/100 miles ....  | 2-44 |
| Table 2-23: Summary of ALPHA Simulations vs Certification Values for MY 2022 Fleet.....   | 2-46 |
| Table 2-24: Details of ALPHA 3.0 models peer reviewed. ....   | 2-47 |
| Table 2-25: List of Technology packages for LDV/LDT RSEs. ....  | 2-51 |
| Table 2-26: List of Technology packages for medium-duty vans and pickups for RSEs. ....   | 2-52 |
| Table 2-27: Engine displacements used in RSE construction. ....   | 2-54 |
| Table 2-28: Sample results. ....  | 2-56 |
| Table 2-29: Tabular results. ....   | 2-56 |
| Table 2-30: ANL cost equation coefficients for HEV and PEV batteries (\$50/hr labor). ....  | 2-63 |
| Table 2-31: ANL cost equation coefficients for HEV and PEV batteries. ....  | 2-64 |
| Table 2-32: U.S. PEV battery cathode chemistry market projections, 2023 to 2035. ....   | 2-65 |
| Table 2-33: Learning Factors Applied in OMEGA, Indexed to 2022 <sup>a</sup> . ....  | 2-70 |
| Table 2-34: Retail Price Equivalent Factors in the Heavy-Duty and Light-Duty Industries (Rogozhin 2009). ....   | 2-71 |
| Table 2-35: Engine, exhaust, and fuel system costs used for ICE, HEV and PHEV. ....   | 2-73 |
| Table 2-36: Cylinder Deactivation Costs used to generate a partial discrete cost curve for OMEGA. ....  | 2-74 |
| Table 2-37: Atkinson Cycle Engine Costs used to generate a cost curve for OMEGA. ....   | 2-74 |
| Table 2-38: Driveline system costs for all vehicles. ....   | 2-77 |

|   |      |
|---|------|
| Table 2-39: Air Conditioning System Costs in OMEGA. ....  | 2-78 |
| Table 2-40: Electrified driveline system costs for HEV, PHEV, and BEV.....  | 2-79 |
| Table 2-41: Glider Costs in OMEGA. ....   | 2-84 |
| Table 2-42: Mass Calculations in OMEGA.....   | 2-85 |
| Table 2-43: MY 2032 Vehicles: Year of Last Redesign.....  | 2-86 |
| Table 2-44: Industry Maximum Battery Production Limits (GWh), by Model Year.....  | 2-87 |
| Table 2-45: Light-duty Vehicle Historical Mg CO <sub>2</sub> Credit Bank, by Model Year Vintage. ....   | 2-88 |
| Table 2-46: AEO2023 Liquid Fuel Prices Used in OMEGA Compliance and Effects Modeling (2022 dollars).....  | 2-92 |
| Table 2-47: Electricity Prices used in OMEGA Compliance and Effects Modeling (2022 dollars).<br>.....   | 2-93 |
| Table 2-48: Gross domestic product implicit price deflators.....  | 2-94 |
| Table 2-49: IRA Battery Production Tax Credits in OMEGA. ....   | 2-95 |
| Table 2-50: IRS 30D and 45W Clean Vehicle Credit in OMEGA.....  | 2-95 |
| Table 3-1: Percentage of MY2020 sales and sales volumes of pickup, van, and incomplete MDVs by fuel type.....   | 3-11 |
| Table 3-2 Summary of Funding Programs for U.S. Battery Production .....   | 3-24 |
| Table 3-3: Light-duty vehicle and MDV NMOG+NO <sub>x</sub> bin structure.....   | 3-41 |
| Table 3-4: LDV, LDT and MDPV NMOG+NO <sub>x</sub> standards for 25°C FTP, US06, HFET and SC03.....  | 3-41 |
| Table 3-5: MDV fleet average NMOG+NO <sub>x</sub> standards under the early compliance pathway†...<br>43  | 3-43 |
| Table 3-6: MDV fleet average chassis dynamometer FTP NMOG+NO <sub>x</sub> standards under the default compliance pathway*.....                                | 3-43 |
| Table 3-7: Light-duty PM standard.....  | 3-45 |
| Table 3-8: MDV PM standard. ....  | 3-45 |
| Table 3-9: Light-duty CO and HCHO standards.....  | 3-45 |
| Table 3-10: MDV CO and HCHO standards.....  | 3-45 |
| Table 3-11: Average* FTP, SC03, US06 and composite SFTP CO emissions for MY 2024 test groups certified to Tier 3 that overlap with Tier 4 Standard Bins ..... | 3-46 |
| Table 3-12: Comparison of LEV IV CO standards calculated as a composite SFTP to the Tier 3 SFTP composite CO Standards.....                                   | 3-46 |



|  |       |
|--|-------|
| Table 3-13: Spark-Ignition Standards for Off-Cycle Testing of High GCWR MDV. ....  | 3-49  |
| Table 3-14: Compression-Ignition Standards for Off-Cycle Testing of High GCWR MDV Over the 3B-MAW Procedures.....  | 3-50  |
| Table 3-15: Criteria for 3B-MAW Off-Cycle Bins. ....   | 3-50  |
| Table 3-16: Compression-Ignition Standards for Off-Cycle Testing Over the 2B-MAW. ....   | 3-50  |
| Table 3-17: Criteria for 2B-MAW Off-Cycle Bins. ....   | 3-50  |
| Table 3-18: Accuracy Margins for In-Use Testing Over the 2B-MAW.....   | 3-50  |
| Table 3-19: Examples of NMOG+NO <sub>x</sub> MY 2023 certification emissions that are less than 15 mg/mi. ....   | 3-54  |
| Table 3-20: -7°C FTP NMOG+NO <sub>x</sub> emissions measurements at EPA. ....  | 3-63  |
| Table 3-21: Comparison of FTP, HFET, SCO3, US06 cert test results for MY 2023 LD vehicles. ....  | 3-64  |
| Table 3-22: Vehicle and GPF specifications. ....   | 3-82  |
| Table 3-23: Change in measured CO <sub>2</sub> emissions for each test cycle when GPFs are added, averaged across four test vehicles (2022 F250, 2021 F150 HEV, 2019 F150, 2011 F150). ....        | 3-84  |
| Table 3-24: ORVR Specifications and Assumptions used in the Cost Analysis for Incomplete Medium-Duty Vehicles.....   | 3-90  |
| Table 3-25: Estimated Direct Manufacturing Costs for ORVR Over Tier 3 as Baseline.....   | 3-91  |
| Table 3-26: Curve Fitting Coefficients in the FUF Finalized and BAR Regression Fit.....  | 3-106 |
| Table 3-27: CO <sub>2</sub> Emissions [g/mi] Calculated using Existing FUF and Finalized FUF. ....   | 3-109 |
| Table 3-28: Mean Utility Factors, Standard Errors and Relative Standard Errors for Bootstrap Sampling with selected Sample Sizes for two Models (5,000 replicates drawn for each sample size)..... | 3-112 |
| Table 3-29: Hybrid drive system specifications used for LDT4 REET simulations. ....  | 3-138 |
| Table 3-30: Battery specifications used for LDT4 REET simulations. ....  | 3-139 |
| Table 3-31: Modeled Fuel Economy and CO <sub>2</sub> emissions comparison between the LDT4 Series-Parallel REET and 2021 Ford F-150 using Tier 3 regular-grade fuel. ....                          | 3-139 |
| Table 3-32: Modeled Fuel Economy and CO <sub>2</sub> emissions comparison between the LDT4 P2-P4 REET and 2021 Ford F-150 using Tier 3 regular-grade fuel.....                                     | 3-139 |
| Table 3-33: LDT4 REET 0-60 mph acceleration performance at ETW compared to 2021 Ford F150. ....  | 3-140 |
| Table 3-34: SAE J2807 modeling results for LDT4 REET at GCWR. ....   | 3-140 |
| Table 3-35: Hybrid drive system specifications used for MDV REET simulations. ....   | 3-142 |

|   |       |
|---|-------|
| Table 3-36: Battery specifications used for MDV REET simulations. ....  | 3-142 |
| Table 3-37: Modeled Fuel Economy and CO <sub>2</sub> emissions comparison between the MDV P2-P4 REET with a gasoline DHE and a 2021 RAM 2500 Diesel. ....   | 3-143 |
| Table 3-38: Modeled Fuel Economy and CO <sub>2</sub> emissions comparison between the MDV P2-P4 REET with a diesel DHE and a 2021 RAM 2500 Diesel. ....   | 3-143 |
| Table 3-39: Modeled 0-60 mph performance results at ALVW for the 2021 RAM 2500 and both Class 2b P2-P4 REET configurations. ....  | 3-144 |
| Table 3-40: SAE J2807 modeling results for MDV REET. ....   | 3-144 |
| Table 3-41: A/C maximum leakage credits (MaxCredit) available to manufacturers, final program (CO <sub>2</sub> g/mile). ....  | 3-148 |
| Table 3-42: A/C Component Credits /w SAE J2727-2023 default parameter settings. ....  | 3-148 |
| Table 3-43: A/C Leakage Credits (MaxCredit) of the lowest-GWP refrigerant. ....   | 3-149 |
| Table 3-44: Test Variables Requiring Control for Accurate Fuel Effects Measurement. ....  | 3-153 |
| Table 3-45: Test Program Vehicles. ....   | 3-154 |
| Table 3-46: CO <sub>2</sub> : Results of the EPA Test Program for the FTP and HFET Cycles, With Weighted Values for the Two Cycles, and Corresponding Percent Differences. ....                   | 3-158 |
| Table 3-47: Carbon-Balance and R-Adjusted Fuel Economy Results by Vehicle and Fuel (City/Highway-Weighted Values, mpg). ....  | 3-160 |
| Table 3-48: Adjusted Fuel Economy Results by Vehicle and Fuel Showing Impact of Ra Factor (City/Highway-Weighted Values). ....  | 3-162 |
| Table 4-1: Operating cost inputs to consumer generalized cost. ....   | 4-3   |
| Table 4-2: Central case shareweight values for light-duty vehicles. ....  | 4-14  |
| Table 4-3: Faster BEV acceptance shareweight values by body style for light-duty. ....  | 4-19  |
| Table 4-4: Slower BEV acceptance shareweight values by body style for light-duty. ....  | 4-21  |
| Table 4-5: Recent scientific studies of eVMT. ....  | 4-24  |
| Table 4-6: Recent scientific studies of eVMT rebound. ....  | 4-26  |
| Table 4-7: National per vehicle ownership (savings) and expenses for new model year 2032 light-duty vehicles under the No Action case and the Final Standards (2022 dollars). ....                | 4-31  |
| Table 4-8: Summary of estimated average savings over the 24-year lifetime of light-duty vehicles under the Final Standards compared to vehicles meeting the MY 2026 standards (2022 dollars) .... | 4-32  |
| Table 4-9: National per vehicle ownership expenses for new model year 2032 light-duty vehicles under the Final Standards (2022 dollars). ....   | 4-33  |

|  |      |
|--|------|
| Table 4-10: Summary of estimated average savings over the first 8 years of light-duty vehicle life when MY 2032 PEV purchased instead of ICE vehicle (2022 dollars). ..... | 4-34 |
| Table 4-11: Vehicle technology costs (billions of 2022 dollars)*.....  | 4-37 |
| Table 4-12 Drive value benefits of rebound driving.....  | 4-38 |
| Table 4-13: Liquid-fuel consumption impacts (billion gallons).....   | 4-40 |
| Table 4-14 Electricity consumption impacts (terawatt hours).....   | 4-40 |
| Table 4-15: Retail fuel expenditure savings (billions of 2022 dollars)* .....  | 4-41 |
| Table 4-16: Benefits associated with changes to the time spent refueling .....   | 4-42 |
| Table 4-17: BEV recharging thresholds by body style and range *. .....   | 4-45 |
| Table 4-18 Curve fits used in calculating refueling time for BEVs * .....  | 4-46 |
| Table 4-19 Annual comprehensive and collision premium with \$500 deductible, 2019 dollars *. .....   | 4-47 |
| Table 4-20: Maintenance costs associated with the final standards and each alternative (billions of 2022 dollars). .....   | 4-48 |
| Table 4-21: Maintenance service schedule by powertrain.....  | 4-50 |
| Table 4-22: Repair costs associated with the final standards and each alternative .....  | 4-52 |
| Table 4-23: Repair cost per mile coefficient values <sup>a</sup> .....   | 4-53 |
| Table 4-24: Costs associated with congestion and noise (2018 dollars per vehicle mile).....  | 4-55 |
| Table 4-25 Congestion costs associated with the final standards and the alternatives (billions of 2022 dollars) .....  | 4-55 |
| Table 4-26 Noise costs associated with the final standards and the alternatives (billions of 2022 dollars) .....   | 4-56 |
| Table 4-27: LD sales impacts in the final rule.....  | 4-63 |
| Table 4-28: LD sales impacts in the alternative scenarios.....   | 4-63 |
| Table 4-29: Sectors and associated workers per million dollars in expenditures by source.....  | 4-78 |
| Table 4-30 Annual change in the ratio of labor to value of output for directly impacted sectors (%).....   | 4-79 |
| Table 4-31: Estimated partial employment effects for sectors focused on the electrified, ICE and common portions of vehicle production <sup>a</sup> . .....                | 4-80 |
| Table 4-32: Estimated maximum combined range of estimated partial employment effects across all sectors. ....  | 4-81 |
| Table 5-1: Representative PEV examples for charging simulations. ....  | 5-4  |

|  |      |
|--|------|
| Table 5-2: National electric power sector emissions, demand, generation and cost for the no-action case. ....  | 5-13 |
| Table 5-3: National electric power sector emissions, demand, generation and cost for the final rule. ....  | 5-14 |
| Table 5-4: Average retail electricity price by region for the no-action case and the final rule in 2030 and 2050. ....   | 5-19 |
| Table 5-5: Projected EGU capacity for the no-action case. ....   | 5-21 |
| Table 5-6: Projected EGU capacity for the final rule. ....   | 5-21 |
| Table 5-7: EGU retirements for the no-action case. ....  | 5-22 |
| Table 5-8: EGU retirements for the final rule. ....  | 5-22 |
| Table 5-9: IPM results for net export of electricity into the contiguous United States for the no-action case. *. <sup>†</sup> ....  | 5-22 |
| Table 5-10: IPM results for net export of electricity into the contiguous United States for the final rule. *. <sup>†</sup> ....   | 5-23 |
| Table 5-11: EVSE port counts (thousands) for select years under the final rule and no-action case. ....  | 5-43 |
| Table 5-12: Cost (hardware and installation) per EVSE port. ....   | 5-44 |
| Table 5-13: EVSE costs for the final rule relative to no-action case (billions of 2022 dollars). ....  | 5-47 |
| Table 6-1: Annual Rounded SC-CO <sub>2</sub> , SC-CH <sub>4</sub> , and SC-N <sub>2</sub> O Values, 2027-2055. ....  | 6-14 |
| Table 6-2 Human Health Effects of PM <sub>2.5</sub> . ....   | 6-51 |
| Table 6-3: PM <sub>2.5</sub> -related Benefit Per Ton values (2022\$) associated with the reduction of NO <sub>x</sub> , SO <sub>2</sub> and directly emitted PM <sub>2.5</sub> emissions for (A) Onroad light-duty gasoline cars, (B) Onroad light-duty gasoline trucks, (C) Onroad light-duty diesel cars/trucks, (D) Electricity Generating Units, and (E) Refineries. .... | 6-55 |
| Table 6-4: Unquantified Health and Welfare Benefits Categories ....  | 6-58 |
| Table 7-1: Total onroad emissions impact in AQM policy scenario in 2055 ....   | 7-7  |
| Table 7-2: MOVES versions for AQM scenarios ....   | 7-7  |
| Table 7-3: PM reduction by MOVES operating mode ....   | 7-11 |
| Table 7-4: PM control fraction by MOVES reg class and model year ....  | 7-11 |
| Table 7-5: Total upstream emissions impact in AQM policy scenario in 2055 ....   | 7-12 |
| Table 7-6: EGU emissions impact in AQM inventories in 2055. ....   | 7-13 |
| Table 7-7: Adjustment factors to apply to 2050 refinery inventory ....   | 7-13 |

|  |      |
|--|------|
| Table 7-8: Refinery emissions impact in AQM inventories in 2055 .....  | 7-14 |
| Table 7-9: Crude production well site and pipeline pump impact in AQM inventories in 2055 ..   | 7-14 |
| Table 7-10: Natural gas production well and pipeline pump impact in AQM inventories in 2055 .....  | 7-15 |
| Table 7-11: Net impacts <sup>a</sup> on criteria pollutant emissions from the LMDV regulatory scenario. ...  | 7-15 |
| Table 7-12: Geographic elements of domains used in air quality modeling. ....  | 7-16 |
| Table 7-13: Vertical layer structure for CMAQ domain. ....   | 7-17 |
| Table 7-14: Projected changes in annual average air toxics concentrations in 2055 due to the rule. ....  | 7-33 |
| Table 7-15: Projected changes in annual average air toxics concentrations in 2055 due to onroad-only emissions changes. ....   | 7-39 |
| Table 7-16: Health effects of ambient ozone and PM <sub>2.5</sub> .....  | 7-49 |
| Table 7-17: Quantified and monetized avoided PM <sub>2.5</sub> -related premature mortalities and illnesses of the regulatory scenario in 2055 (95% confidence interval) <sup>a</sup> . ....   | 7-51 |
| Table 7-18: Quantified and monetized avoided ozone-related premature mortalities and illnesses of the regulatory scenario in 2055 (95% confidence interval) <sup>a</sup> . ....  | 7-52 |
| Table 7-19: Total PM <sub>2.5</sub> and ozone benefits of the regulatory scenario in 2055 (95% confidence interval, billions of 2022 dollars) <sup>a,b</sup> .....   | 7-53 |
| Table 7-20: Demographic Population Variables Included in the EJ Analysis.....  | 7-56 |
| Table 7-21: Population-weighted averages for the reference, control, absolute difference, and relative difference (in percentage terms) for each population group for PM <sub>2.5</sub> reductions in 2055 associated with the final rule..... | 7-58 |
| Table 7-22: Population-weighted averages for the reference, control, absolute difference, and relative difference (in percentage terms) for each population group for ozone reductions in 2055 associated with the final rule.....             | 7-59 |
| Table 8-1: Mileage accumulation and re-registration rates used for light-duty.....   | 8-7  |
| Table 8-2: VMT summary, light-duty and medium-duty (billion miles). ....   | 8-11 |
| Table 8-3: Rebound VMT relative to no action, light-duty and medium-duty (billion miles)..   | 8-12 |
| Table 8-4: Safety values used in OMEGA (U.S. NHTSA 2022). ....   | 8-14 |
| Table 8-5: Light- and medium-duty fleet-weighted attributes in the OMEGA safety analysis for the No Action and Final Standards (pounds)*.....  | 8-16 |
| Table 8-6: Fatalities per year, light-duty and medium-duty. ....   | 8-18 |

|  |      |
|--|------|
| Table 8-7: Fatality rate impacts, light-duty and medium-duty (fatalities per billion miles).....   | 8-19 |
| Table 8-8: Fuel and electricity consumption impacts, final standards.....  | 8-28 |
| Table 8-9: Fuel and electricity consumption impacts, Alternative A. ....   | 8-29 |
| Table 8-10: Fuel and electricity consumption impacts, Alternative B. ....  | 8-30 |
| Table 8-11: Emissions from Refineries that Refine Onroad Liquid Fuels (US tons per year). .  | 8-33 |
| Table 8-12: AEO 2023 Projections of Domestic Liquid Fuel Use (Million Barrels per Day, (U.S. EIA 2023) see Table 11, Reference case). ....   | 8-34 |
| Table 8-13: Net Exports and Export Scaler Used to Project Future Net Exports Associated with any OMEGA Policy Scenario (Million Barrels per Day, (U.S. EIA 2023) see Table 11, Reference case). .... | 8-34 |
| Table 8-14: EIA Petroleum Product Export Data for 2022 (EIA Imports by Area of Entry 2023) .....   | 8-35 |
| Table 8-15: EPA Projections of Net Exports of Petroleum Products (Million Barrels per Day). .  | 8-35 |
| Table 8-16: EPA Estimated Domestic Refining (Million Barrels per Day). ....  | 8-35 |
| Table 8-17: Refinery Emission Apportionment by Fuel Type (unitless). ....  | 8-36 |
| Table 8-18: Refinery Emission Rates Calculated in OMEGA for Gasoline .....   | 8-36 |
| Table 8-19: Refinery Emission Rates Calculated in OMEGA for Diesel Fuel .....  | 8-37 |
| Table 8-20: Share of Gasoline and Diesel Fuel Consumed by Regulatory Class (unitless).....   | 8-44 |
| Table 8-21: Share of Gasoline and Diesel fuel Consumed by Weight Classes (unitless). ....  | 8-44 |
| Table 8-22: Greenhouse gas emission inventory impacts, Final standards .....   | 8-46 |
| Table 8-23: Greenhouse gas emission inventory impacts, Alternative A.....  | 8-47 |
| Table 8-24: Greenhouse gas emission inventory impacts, Alternative B.....  | 8-48 |
| Table 8-25: Net Greenhouse gas emission inventory impacts, Final standards*. ....  | 8-49 |
| Table 8-26: Net Greenhouse gas emission inventory impacts, Alternative A*. ....  | 8-50 |
| Table 8-27: Net Greenhouse gas emission inventory impacts, Alternative B*. ....  | 8-51 |
| Table 8-28: Criteria air pollutant impacts from vehicles, Final standards.....   | 8-52 |
| Table 8-29: Criteria air pollutant impacts from vehicles, Alternative A .....  | 8-53 |
| Table 8-30: Criteria air pollutant impacts from vehicles, Alternative B .....  | 8-54 |
| Table 8-31: Criteria air pollutant impacts from EGUs and refineries, Final standards .....   | 8-55 |
| Table 8-32: Criteria air pollutant impacts from EGUs and refineries, Alternative A.....  | 8-56 |

|  |      |
|--|------|
| Table 8-33: Criteria air pollutant impacts from EGUs and refineries, Alternative B.....  | 8-57 |
| Table 8-34: Net criteria air pollutant impacts from vehicles, EGUs and refineries, Final standards<br>* .....  | 8-58 |
| Table 8-35: Net criteria air pollutant impacts from vehicles, EGUs and refineries, Alternative A<br>* .....  | 8-59 |
| Table 8-36: Net criteria air pollutant impacts from vehicles, EGUs and refineries, Alternative B<br>* .....  | 8-60 |
| Table 8-37: Parameters used in estimating oil import impacts.....  | 8-61 |
| Table 8-38 Oil Import Factor based on AEO 2021.....  | 8-62 |
| Table 8-39 Oil Import Factor based on AEO 2023.....  | 8-63 |
| Table 8-40: Impacts on oil consumption and oil imports, Final standards.....   | 8-64 |
| Table 8-41: Impacts on oil consumption and oil imports, Alternative A .....  | 8-65 |
| Table 8-42: Impacts on oil consumption and oil imports, Alternative B.....   | 8-66 |
| Table 9-1: Costs associated with the final standards (billions of 2022 dollars)*. ....   | 9-1  |
| Table 9-2: Costs associated with Alternative A (billions of 2022 dollars)*.....  | 9-2  |
| Table 9-3: Costs associated with Alternative B (billions of 2022 dollars)*.....  | 9-2  |
| Table 9-4: Pretax fuel savings and EVSE port costs associated with the final standards (billions<br>of 2022 dollars)*.....   | 9-3  |
| Table 9-5: Pretax fuel savings and EVSE port costs associated with Alternative A .....   | 9-4  |
| Table 9-6: Pretax fuel savings and EVSE port costs associated with Alternative B .....   | 9-4  |
| Table 9-7: Non-emission benefits associated with the final standards .....   | 9-5  |
| Table 9-8: Non-emission benefits associated with Alternative A .....   | 9-6  |
| Table 9-9: Non-emission benefits associated with Alternative B.....  | 9-6  |
| Table 9-10: Benefits of reduced CO <sub>2</sub> emissions from the final standards.....  | 9-8  |
| Table 9-11: Benefits of reduced CH <sub>4</sub> emissions from the final standards.....  | 9-9  |
| Table 9-12: Benefits of reduced N <sub>2</sub> O emissions from the final standards.....   | 9-10 |
| Table 9-13: : Benefits of reduced GHG emissions from the final standards.....  | 9-11 |
| Table 9-14: Benefits of reduced GHG emissions from Alternative A.....  | 9-12 |
| Table 9-15: Benefits of reduced GHG emissions from Alternative B.....  | 9-13 |
| Table 9-16: Monetized PM <sub>2.5</sub> health benefits of onroad and upstream emissions reductions<br>associated with the final standards (billions of 2022 dollars)..... | 9-19 |

|   |       |
|---|-------|
| Table 9-17: Monetized PM <sub>2.5</sub> health benefits of onroad and upstream emissions reductions associated with Alternative A (billions of 2022 dollars). .....   | 9-20  |
| Table 9-18: Monetized PM <sub>2.5</sub> health benefits of onroad and upstream emissions reductions associated with Alternative B (billions of 2022 dollars). .....   | 9-21  |
| Table 9-19: Summary of costs, fuel savings and benefits of the final standards.....   | 9-22  |
| Table 9-20: Summary of costs, fuel savings and benefits of Alternative A .....  | 9-23  |
| Table 9-21 Summary of costs, fuel savings and benefits of Alternative B.....  | 9-24  |
| Table 9-22: Transfers associated with the final standards .....   | 9-25  |
| Table 9-23: Transfers associated with Alternative A .....   | 9-26  |
| Table 9-24: Transfers associated with Alternative B.....  | 9-26  |
| Table 9-25 Interim Social Cost of GHG Values, 2027-2055 (2022 \$/metric ton) .....  | 9-1   |
| Table 9-26 Benefits of reduced CO <sub>2</sub> emissions from the final standards using the interim SC-GHG values.....  | 9-2   |
| Table 9-27 Benefits of reduced CH <sub>4</sub> emissions from the final standards using the interim SC-GHG values.....  | 9-3   |
| Table 9-28 Benefits of reduced N <sub>2</sub> O emissions from the final standards using the interim SC-GHG values.....   | 9-4   |
| Table 9-29 Benefits of reduced GHG emissions from the final standards using the interim SC-GHG values.....  | 9-5   |
| Table 9-30 Summary of costs, fuel savings and benefits of the final standards.....  | 9-6   |
| Table 10-1: Oil Import Reduction Factor, Average Over Years 2027 to 2050. ....  | 10-27 |
| Table 10-2: Projected trends in U.S. crude oil exports/imports, net refined oil product exports, net crude oil and refined petroleum product imports, oil consumption and U.S. oil import reductions resulting from the final rule from 2027 to 2055 (MMBD). <sup>a</sup> ..... | 10-28 |
| Table 10-3: Macroeconomic oil security premiums for 2027–2055 for final rule (2022\$/barrel). <sup>a,b</sup> .....  | 10-32 |
| Table 11-1 Small Entity Vehicle Production from Model Year 2017 to 2022 .....   | 11-2  |
| Table 11-2 ICI Import Records (number of imported vehicles).....  | 11-2  |
| Table 12-1: Projected GHG Targets, Final Standards - Cars.....  | 12-2  |
| Table 12-2: Projected GHG Targets, Final Standards - Trucks.....  | 12-2  |
| Table 12-3: Projected GHG Targets, Final Standards - Combined .....   | 12-3  |
| Table 12-4: Achieved GHG Levels, Final Standards - Cars.....  | 12-3  |



|  |       |
|--|-------|
| Table 12-5: Achieved GHG Levels, Final Standards - Trucks .....              | 12-4  |
| Table 12-6: Achieved GHG Levels, Final Standards - Combined .....            | 12-4  |
| Table 12-7: Projected GHG Targets, Alternative A - Cars.....                 | 12-5  |
| Table 12-8: Projected GHG Targets, Alternative A - Trucks.....               | 12-6  |
| Table 12-9: Projected GHG Targets, Alternative A - Combined .....            | 12-6  |
| Table 12-10: Achieved GHG Levels, Alternative A - Cars.....                  | 12-7  |
| Table 12-11: Achieved GHG Levels, Alternative A - Trucks .....               | 12-7  |
| Table 12-12: Achieved GHG Levels, Alternative A - Combined .....             | 12-8  |
| Table 12-13: Projected GHG Targets, Alternative B - Cars.....                | 12-9  |
| Table 12-14: Projected GHG Targets, Alternative B - Trucks .....             | 12-9  |
| Table 12-15: Projected GHG Targets, Alternative B - Combined.....            | 12-10 |
| Table 12-16: Achieved GHG Levels, Alternative B - Cars .....                 | 12-10 |
| Table 12-17: Achieved GHG Levels, Alternative B - Trucks .....               | 12-11 |
| Table 12-18: Achieved GHG Levels, Alternative B - Combined.....              | 12-11 |
| Table 12-19: Projected GHG Targets (Mg), Final Standards - Cars .....        | 12-12 |
| Table 12-20: Projected GHG Targets (Mg), Final Standards - Trucks.....       | 12-13 |
| Table 12-21: Projected GHG Targets (Mg), Final Standards - Combined.....     | 12-13 |
| Table 12-22: Achieved GHG Levels (Mg), Final Standards - Cars .....          | 12-14 |
| Table 12-23: Achieved GHG Levels (Mg), Final Standards - Trucks.....         | 12-14 |
| Table 12-24: Achieved GHG Levels (Mg), Final Standards - Combined .....      | 12-15 |
| Table 12-25: GHG Credits/Debits Earned (Mg), Final Standards - Combined..... | 12-15 |
| Table 12-26: Projected GHG Targets (Mg), Alternative A - Cars .....          | 12-16 |
| Table 12-27: Projected GHG Targets (Mg), Alternative A - Trucks.....         | 12-17 |
| Table 12-28: Projected GHG Targets (Mg), Alternative A - Combined .....      | 12-17 |
| Table 12-29: Achieved GHG Levels (Mg), Alternative A - Cars.....             | 12-18 |
| Table 12-30: Achieved GHG Levels (Mg), Alternative A - Trucks.....           | 12-18 |
| Table 12-31: Achieved GHG Levels (Mg), Alternative A - Combined .....        | 12-19 |
| Table 12-32: GHG Credits/Debits Earned (Mg), Alternative A - Combined.....   | 12-19 |
| Table 12-33: Projected GHG Targets (Mg), Alternative B - Cars.....           | 12-20 |

|  |       |
|--|-------|
| Table 12-34: Projected GHG Targets (Mg), Alternative B - Trucks .....                      | 12-21 |
| Table 12-35: Projected GHG Targets (Mg), Alternative B - Combined .....                    | 12-21 |
| Table 12-36: Achieved GHG Levels (Mg), Alternative B - Cars.....                           | 12-22 |
| Table 12-37: Achieved GHG Levels (Mg), Alternative B - Trucks .....                        | 12-22 |
| Table 12-38: Achieved GHG Levels (Mg), Alternative B - Combined .....                      | 12-23 |
| Table 12-39: GHG Credits/Debits Earned (Mg), Alternative B - Combined.....                 | 12-23 |
| Table 12-40: Projected Manufacturing Costs Per Vehicle, Final Standards .....              | 12-24 |
| Table 12-41: Projected Manufacturing Costs Per Vehicle, Final Standards (by Body Style).   | 12-24 |
| Table 12-42: Projected Manufacturing Costs Per Vehicle, Final Standards - Cars.....        | 12-25 |
| Table 12-43: Projected Manufacturing Costs Per Vehicle, Final Standards - Trucks .....     | 12-25 |
| Table 12-44: Projected Manufacturing Costs Per Vehicle, Final Standards - Combined .....   | 12-26 |
| Table 12-45: Projected Manufacturing Costs Per Vehicle, Alternative A.....                 | 12-26 |
| Table 12-46: Projected Manufacturing Costs Per Vehicle, Alternative A (by Body Style) .... | 12-26 |
| Table 12-47: Projected Manufacturing Costs Per Vehicle, Alternative A - Cars.....          | 12-27 |
| Table 12-48: Projected Manufacturing Costs Per Vehicle, Alternative A - Trucks .....       | 12-27 |
| Table 12-49: Projected Manufacturing Costs Per Vehicle, Alternative A - Combined.....      | 12-28 |
| Table 12-50: Projected Manufacturing Costs Per Vehicle, Alternative B.....                 | 12-28 |
| Table 12-51: Projected Manufacturing Costs Per Vehicle, Alternative B (by Body Style) .... | 12-28 |
| Table 12-52: Projected Manufacturing Costs Per Vehicle, Alternative B - Cars .....         | 12-29 |
| Table 12-53: Projected Manufacturing Costs Per Vehicle, Alternative B - Trucks .....       | 12-29 |
| Table 12-54: Projected Manufacturing Costs Per Vehicle, Alternative B - Combined.....      | 12-30 |
| Table 12-55: Projected BEV Penetrations, No Action - Cars.....                             | 12-31 |
| Table 12-56: Projected BEV Penetrations, No Action - Trucks .....                          | 12-32 |
| Table 12-57: Projected BEV Penetrations, No Action - Combined .....                        | 12-32 |
| Table 12-58: Projected PHEV Penetrations, No Action - Cars .....                           | 12-33 |
| Table 12-59: Projected PHEV Penetrations, No Action - Trucks .....                         | 12-33 |
| Table 12-60: Projected PHEV Penetrations, No Action - Combined.....                        | 12-34 |
| Table 12-61: Projected Strong HEV Penetrations, No Action .....                            | 12-34 |
| Table 12-62: Projected TURB12 Penetrations, No Action.....                                 | 12-34 |

|   |       |
|---|-------|
| Table 12-63: Projected MIL Penetrations, No Action .....  | 12-34 |
| Table 12-64: Projected BEV Penetrations, Final Standards - Cars .....                                 | 12-35 |
| Table 12-65: Projected BEV Penetrations, Final Standards - Trucks.....                                | 12-36 |
| Table 12-66: Projected BEV Penetrations, Final Standards - Combined .....                             | 12-36 |
| Table 12-67: Projected PHEV Penetrations, Final Standards - Cars .....                                | 12-37 |
| Table 12-68: Projected PHEV Penetrations, Final Standards - Trucks .....                              | 12-37 |
| Table 12-69: Projected PHEV Penetrations, Final Standards - Combined.....                             | 12-38 |
| Table 12-70: Projected Strong HEV Penetrations, Final Standards .....                                 | 12-38 |
| Table 12-71: Projected TURB12 Penetrations, Final Standards .....                                     | 12-38 |
| Table 12-72: Projected MIL Penetrations, Final Standards.....   | 12-38 |
| Table 12-73: Projected BEV Penetrations, Alternative A - Cars.....                                    | 12-39 |
| Table 12-74: Projected BEV Penetrations, Alternative A - Trucks.....                                  | 12-40 |
| Table 12-75: Projected BEV Penetrations, Alternative A - Combined .....                               | 12-40 |
| Table 12-76: Projected PHEV Penetrations, Alternative A - Cars .....                                  | 12-41 |
| Table 12-77: Projected PHEV Penetrations, Alternative A - Trucks .....                                | 12-41 |
| Table 12-78: Projected PHEV Penetrations, Alternative A - Combined.....                               | 12-42 |
| Table 12-79: Projected Strong HEV Penetrations, Alternative A .....                                   | 12-42 |
| Table 12-80: Projected TURB12 Penetrations, Alternative A.....  | 12-42 |
| Table 12-81: Projected MIL Penetrations, Alternative A.....   | 12-42 |
| Table 12-82: Projected BEV Penetrations, Alternative B - Cars.....                                    | 12-43 |
| Table 12-83: Projected BEV Penetrations, Alternative B - Trucks .....                                 | 12-44 |
| Table 12-84: Projected BEV Penetrations, Alternative B - Combined .....                               | 12-44 |
| Table 12-85: Projected PHEV Penetrations, Alternative B - Cars .....                                  | 12-45 |
| Table 12-86: Projected PHEV Penetrations, Alternative B - Trucks.....                                 | 12-45 |
| Table 12-87: Projected PHEV Penetrations, Alternative B - Combined.....                               | 12-46 |
| Table 12-88: Projected Strong HEV Penetrations, Alternative B.....                                    | 12-46 |
| Table 12-89: Projected TURB12 Penetrations, Alternative B.....  | 12-46 |
| Table 12-90: Projected MIL Penetrations, Alternative B .....  | 12-46 |
| Table 12-91: Projected targets with ACC II (CO <sub>2</sub> grams/mile) - cars and trucks combined... | 12-47 |

|   |       |
|---|-------|
| Table 12-92: Projected achieved levels with ACC II (CO <sub>2</sub> grams/mile) - cars and trucks combined <sup>a</sup> .....   | 12-47 |
| Table 12-93: BEV penetrations with ACC II - cars and trucks combined .....  | 12-47 |
| Table 12-94: PHEV penetrations with ACC II - cars and trucks combined.....  | 12-47 |
| Table 12-95: Average incremental vehicle cost vs. No Action case with ACC II - cars and trucks combined.....                    | 12-47 |
| Table 12-96: Projected targets for Low Battery Costs (CO <sub>2</sub> grams/mile) - cars and trucks combined.....               | 12-48 |
| Table 12-97: Projected achieved levels for Low Battery Costs (CO <sub>2</sub> grams/mile) - cars and trucks combined.....       | 12-48 |
| Table 12-98: BEV penetrations for Low Battery Costs - cars and trucks combined.....   | 12-48 |
| Table 12-99: PHEV penetrations for Low Battery Costs - cars and trucks combined .....   | 12-48 |
| Table 12-100: Average incremental vehicle cost vs. No Action case for Low Battery Costs - cars and trucks combined .....        | 12-48 |
| Table 12-101: Projected targets for High Battery Costs (CO <sub>2</sub> grams/mile) - cars and trucks combined.....             | 12-48 |
| Table 12-102: Projected achieved levels for High Battery Costs (CO <sub>2</sub> grams/mile) - cars and trucks combined .....    | 12-48 |
| Table 12-103: BEV penetrations for High Battery Costs - cars and trucks combined.....   | 12-49 |
| Table 12-104: PHEV penetrations for High Battery Costs - cars and trucks combined.....  | 12-49 |
| Table 12-105: Average incremental vehicle cost vs. No Action case for High Battery Costs - cars and trucks combined .....       | 12-49 |
| Table 12-106: Projected targets for Faster BEV Acceptance (CO <sub>2</sub> grams/mile) - cars and trucks combined.....          | 12-49 |
| Table 12-107: Projected achieved levels for Faster BEV Acceptance (CO <sub>2</sub> grams/mile) - cars and trucks combined ..... | 12-49 |
| Table 12-108: BEV penetrations for Faster BEV Acceptance - cars and trucks combined ....  | 12-49 |
| Table 12-109: PHEV penetrations for Faster BEV Acceptance - cars and trucks combined..  | 12-49 |
| Table 12-110: Average incremental vehicle cost vs. No Action case for Faster BEV Acceptance - cars and trucks combined.....     | 12-50 |
| Table 12-111: Projected targets for Slower BEV Acceptance (CO <sub>2</sub> grams/mile) - cars and trucks combined.....          | 12-50 |
| Table 12-112: Projected achieved levels for Slower BEV Acceptance (CO <sub>2</sub> grams/mile) - cars and trucks combined ..... | 12-50 |

|   |       |
|---|-------|
| Table 12-113: BEV penetrations for Slower BEV Acceptance - cars and trucks combined...  | 12-50 |
| Table 12-114: PHEV penetrations for Slower BEV Acceptance - cars and trucks combined  | 12-50 |
| Table 12-115: Average incremental vehicle cost vs. No Action case for Slower BEV Acceptance - cars and trucks combined .....                          | 12-50 |
| Table 12-116: Projected targets for No Credit Trading (CO <sub>2</sub> grams/mile) - cars and trucks combined.....                                    | 12-50 |
| Table 12-117: Projected achieved levels for No Credit Trading (CO <sub>2</sub> grams/mile) - cars and trucks combined.....                            | 12-51 |
| Table 12-118: BEV penetrations for No Credit Trading - cars and trucks combined .....   | 12-51 |
| Table 12-119: PHEV penetrations for No Credit Trading - cars and trucks combined.....   | 12-51 |
| Table 12-120: Average incremental vehicle cost vs. No Action case for No Credit Trading - cars and trucks combined .....                              | 12-51 |
| Table 12-121: Projected targets for Lower BEV Production (CO <sub>2</sub> grams/mile) - cars and trucks combined.....                                 | 12-51 |
| Table 12-122: Projected achieved levels for Lower BEV Production (CO <sub>2</sub> grams/mile) - cars and trucks combined .....                        | 12-51 |
| Table 12-123: BEV penetrations for Lower BEV Production - cars and trucks combined.....   | 12-51 |
| Table 12-124: PHEV penetrations for Lower BEV Production - cars and trucks combined ..  | 12-51 |
| Table 12-125: Average incremental vehicle cost vs. No Action case for Lower BEV Production - cars and trucks combined.....                            | 12-52 |
| Table 12-126: Projected targets for No Additional BEVs Beyond the No Action Case (CO <sub>2</sub> grams/mile) - cars and trucks combined .....        | 12-52 |
| Table 12-127: Projected achieved levels for No Additional BEVs Beyond the No Action Case (CO <sub>2</sub> grams/mile) - cars and trucks combined..... | 12-52 |
| Table 12-128: BEV penetrations for No Additional BEVs Beyond the No Action Case - cars and trucks combined .....                                      | 12-52 |
| Table 12-129: PHEV penetrations for No Additional BEVs Beyond the No Action Case - cars and trucks combined .....                                     | 12-52 |
| Table 12-130: Average incremental vehicle cost vs. No Action case for No Additional BEVs Beyond the No Action Case - cars and trucks combined.....    | 12-52 |
| Table 12-131: Projected GHG Targets, Final Standards - Medium Duty Vans .....   | 12-53 |
| Table 12-132: Projected GHG Targets, Final Standards - Medium Duty Pickups.....   | 12-53 |
| Table 12-133: Projected GHG Targets, Final Standards - Combined .....   | 12-53 |
| Table 12-134: Achieved GHG Levels, Final Standards - Medium Duty Vans .....   | 12-54 |

|  |       |
|--|-------|
| Table 12-135: Achieved GHG Levels, Final Standards - Medium Duty Pickups.....                        | 12-54 |
| Table 12-136: Achieved GHG Levels, Final Standards - Combined .....                                  | 12-54 |
| Table 12-137: Projected GHG Targets (Mg), Final Standards - Medium Duty Vans .....                   | 12-55 |
| Table 12-138: Projected GHG Targets (Mg), Final Standards - Medium Duty Pickups .....                | 12-55 |
| Table 12-139: Projected GHG Targets (Mg), Final Standards - Medium Duty Combined ....                | 12-55 |
| Table 12-140: Achieved GHG Levels (Mg), Final Standards - Medium Duty Vans .....                     | 12-55 |
| Table 12-141: Achieved GHG Levels (Mg), Final Standards - Medium Duty Pickups.....                   | 12-55 |
| Table 12-142: Achieved GHG Levels (Mg), Final Standards - Medium Duty Combined.....                  | 12-56 |
| Table 12-143: GHG Credits/Debits Earned (Mg), Final Standards - Medium Duty Combined .               | 12-56 |
| Table 12-144: Projected Manufacturing Costs Per Vehicle, Final Standards - Medium Duty Vehicles..... | 12-56 |
| Table 12-145: Projected Manufacturing Costs Per Vehicle, Final Standards - Medium Duty Vans .....    | 12-57 |
| Table 12-146: Projected Manufacturing Costs Per Vehicle, Final Standards - Medium Duty Pickups.....  | 12-57 |
| Table 12-147: Projected Manufacturing Costs Per Vehicle, Final Standards - Medium Duty Combined..... | 12-57 |
| Table 12-148: Projected BEV Penetrations, No Action - Medium Duty Vans .....                         | 12-58 |
| Table 12-149: Projected BEV Penetrations, No Action - Medium Duty Pickups.....                       | 12-58 |
| Table 12-150: Projected BEV Penetrations, No Action - Medium Duty Combined.....                      | 12-58 |
| Table 12-151: Projected PHEV Penetrations, No Action - Medium Duty Vans.....                         | 12-58 |
| Table 12-152: Projected PHEV Penetrations, No Action - Medium Duty Pickups .....                     | 12-58 |
| Table 12-153: Projected PHEV Penetrations, No Action - Medium Duty Combined .....                    | 12-59 |
| Table 12-154: Projected BEV Penetrations, Final Standards - Medium Duty Vans .....                   | 12-59 |
| Table 12-155: Projected BEV Penetrations, Final Standards - Medium Duty Pickups.....                 | 12-59 |
| Table 12-156: Projected BEV Penetrations, Final Standards - Medium Duty Combined.....                | 12-59 |
| Table 12-157: Projected PHEV Penetrations, Final Standards - Medium Duty Vans.....                   | 12-60 |
| Table 12-158: Projected PHEV Penetrations, Final Standards - Medium Duty Pickups .....               | 12-60 |
| Table 12-159: Projected PHEV Penetrations, Final Standards - Medium Duty Combined ....               | 12-60 |

|  |       |
|--|-------|
| Table 12-160. Projected targets with Low Battery Costs for No Action case and final standards (CO <sub>2</sub> grams/mile) - Medium Duty Combined .....          | 12-60 |
| Table 12-161. Projected achieved levels with Low Battery Costs for No Action case and final standards (CO <sub>2</sub> grams/mile) - Medium Duty Combined .....  | 12-61 |
| Table 12-162. BEV penetrations with Low Battery Costs for No Action case and final standards - Medium Duty Combined .....  | 12-61 |
| Table 12-163. PHEV penetrations with Low Battery Costs for No Action case and final standards - Medium Duty Combined.....  | 12-61 |
| Table 12-164. Average incremental vehicle manufacturing cost vs. No Action case for Low Battery Costs, final standards - Medium Duty Combined.....               | 12-61 |
| Table 12-165. Projected targets with High Battery Costs for No Action case and final standards (CO <sub>2</sub> grams/mile) - Medium Duty Combined .....         | 12-61 |
| Table 12-166. Projected achieved levels with High Battery Costs for No Action case and final standards (CO <sub>2</sub> grams/mile) - Medium Duty Combined ..... | 12-61 |
| Table 12-167. BEV penetrations with High Battery Costs for No Action case and final standards - Medium Duty Combined.....  | 12-61 |
| Table 12-168. PHEV penetrations with High Battery Costs for No Action case and final standards - Medium Duty Combined.....                                       | 12-62 |
| Table 12-169. Average incremental vehicle manufacturing cost vs. No Action case for High Battery Costs, final standards - Medium Duty Combined.....              | 12-62 |
| Table 12-170: Projected targets for No Credit Trading (CO <sub>2</sub> grams/mile) - Medium Duty Combined.....   | 12-62 |
| Table 12-171: Projected achieved levels for No Credit Trading (CO <sub>2</sub> grams/mile) - Medium Duty Combined.....   | 12-62 |
| Table 12-172: BEV penetrations for No Credit Trading - Medium Duty Combined.....   | 12-62 |
| Table 12-173: PHEV penetrations for No Credit Trading - Medium Duty Combined .....   | 12-62 |
| Table 12-174: Average incremental vehicle cost vs. No Action case for No Credit Trading - Medium Duty Combined .....   | 12-62 |
| Table 12-175: Projected targets for No New BEVs Above Base Year MY 2022 Fleet (CO <sub>2</sub> grams/mile) - cars and trucks combined .....                      | 12-63 |
| Table 12-176: Projected achieved levels for No New BEVs Above Base Year MY 2022 Fleet (CO <sub>2</sub> grams/mile) - cars and trucks combined.....               | 12-63 |
| Table 12-177: BEV penetrations for No New BEVs Above Base Year MY 2022 Fleet - cars and trucks combined.....   | 12-63 |

Table 12-178: PHEV penetrations for No New BEVs Above Base Year MY 2022 Fleet - cars and trucks combined ..... 12-63

Table 12-179: Average incremental vehicle cost vs. No Action case for No New BEVs Above Base Year MY 2022 Fleet, final - cars and trucks combined ..... 12-63

Table 12-180: Projected targets for No New BEVs Above Base Year MY 2022 Fleet (CO<sub>2</sub> grams/mile) - Medium Duty Combined..... 12-63

Table 12-181: Projected achieved levels for No New BEVs Above Base Year MY 2022 Fleet (CO<sub>2</sub> grams/mile) - Medium Duty Combined. .... 12-64

Table 12-182: BEV penetrations for No New BEVs Above Base Year MY 2022 Fleet - Medium Duty Combined. .... 12-64

Table 12-183: PHEV penetrations for No New BEVs Above Base Year MY 2022 Fleet - Medium Duty Combined. .... 12-64

Table 12-184: Average incremental vehicle cost vs. No Action case for No New BEVs Above Base Year MY 2022 Fleet - Medium Duty Combined. .... 12-64



## List of Figures

|  |      |
|--|------|
| Figure 1-1. Light-Duty Sales by Vehicle Type (U.S. EPA 2022) .....   | 1-4  |
| Figure 1-2. Change in Car and Truck Regulatory Class Market Share, 2012-2021 MY .....                                    | 1-4  |
| Figure 1-3. Effect of Fleet Shift on Average CO <sub>2</sub> Standard. ....  | 1-5  |
| Figure 1-4. Footprint Response to Slope Sweeps, Sedan/Wagon Body Style.....  | 1-8  |
| Figure 1-5. Footprint Response to Slope Sweeps, (Car Reg Class) CUV/SUV Body Style. ....                                 | 1-8  |
| Figure 1-6. Increase in Tailpipe CO <sub>2</sub> Emissions: MY 2019 AWD vs. 2WD Crossovers.....                          | 1-9  |
| Figure 1-7. GCWR-Torque Relationship, MY 2019 Light Truck Data. ....   | 1-11 |
| Figure 1-8. Incremental CO <sub>2</sub> as a Function of Increased Towing Capacity. ....                                 | 1-12 |
| Figure 1-9. Tow Rating-Footprint Relationship, MY 2019 Trucks.....   | 1-13 |
| Figure 1-10. AWD and Utility Offset Applied to Establish Truck Curve (100 percent ICE)...                                | 1-14 |
| Figure 1-11. AWD and Utility Offset Applied to Establish Truck Curve (Scaled).....                                       | 1-15 |
| Figure 1-12. Comparison of Average Footprint to Base Year Footprint for Final Standards ...                              | 1-16 |
| Figure 1-13. Sales-weighted Footprint of Full-Size Pickups, 2012-2021 MY .....   | 1-17 |
| Figure 1-14. Car and Truck Curves, Scaled, with Cutpoints .....  | 1-18 |
| Figure 1-15: Heavy-duty Phase 2 work factor-based GHG standards for medium-duty pickups and vans (81 FR 73478 2016)..... | 1-21 |
| Figure 1-16: Final MDV GHG target standards .....  | 1-25 |
| Figure 2-1: Compliance modeling workflow.....  | 2-3  |
| Figure 2-2: Comparison of OMEGA1 and OMEGA2.....   | 2-4  |
| Figure 2-3: Relationship of ALPHA, RSEs and OMEGA. ....  | 2-11 |
| Figure 2-4: Summary of components and architectures used in ALPHA’s modeling. ....                                       | 2-14 |
| Figure 2-5: Conventional vehicle architecture.....   | 2-15 |
| Figure 2-6: P0 Mild hybrid-electric vehicle architecture.....  | 2-16 |
| Figure 2-7: PowerSplit strong HEV and PHEV (& planetary gear arrangement).....   | 2-18 |
| Figure 2-8: P2 strong HEV and PHEV architecture. ....  | 2-19 |
| Figure 2-9: SP-P4 strong HEV and PHEV architecture from the REET report (Bhattacharjya, et al. 2023). ....               | 2-19 |
| Figure 2-10: P2-P4 PHEV architecture from the REET report (Bhattacharjya, et al. 2023)....                               | 2-20 |
| Figure 2-11: Battery electric vehicle architecture.....  | 2-20 |

|   |      |
|---|------|
| Figure 2-12: Schematic of equivalent circuit battery model used in ALPHA.....   | 2-25 |
| Figure 2-13: Power scaling example - Electric drive unit. ....  | 2-26 |
| Figure 2-14: Sample validation comparison of modeled versus measured data from a 2016 Toyota Prius Prime operating on the drive schedule between 680 to 820 seconds. ....   | 2-27 |
| Figure 2-15: Conventional Vehicles in the MY 2022 fleet - ALPHA combined cycle CO <sub>2</sub> g/mile values versus certification CO <sub>2</sub> g/mile where bubble sizes reflect production volumes. ....  | 2-37 |
| Figure 2-16: P0 mild hybrids in the MY 2022 fleet - ALPHA combined cycle CO <sub>2</sub> g/mile values versus certification CO <sub>2</sub> g/mile where both P0 and P1 model types were simulated using the ALPHA P0 model and bubble sizes reflect production volumes. ....   | 2-38 |
| Figure 2-17: PowerSplit HEVs and PS PHEVs in Charge-Sustaining-Mode in the MY2022 fleet - ALPHA combined cycle CO <sub>2</sub> g/mile values versus certification CO <sub>2</sub> g/mile values where both PowerSplit and Series-parallel vehicle model types were simulated using the PS model and bubble sizes reflect production volumes. .... | 2-40 |
| Figure 2-18: P2 HEVs and P2 PHEVs in Charge-Sustaining-Mode in the MY 2022 fleet - ALPHA combined cycle CO <sub>2</sub> g/mile values versus certification CO <sub>2</sub> g/mile where bubble sizes reflect production volumes. ....   | 2-42 |
| Figure 2-19: PowerSplit and P2 PHEVs both in Charge-Depleting-Mode in the MY 2022 fleet - ALPHA combined cycle kWh/100 miles values versus certification kWh/100 miles where bubble sizes reflect production volumes. ....  | 2-43 |
| Figure 2-20: BEVs in the MY 2022 fleet - ALPHA combined cycle kWh/100 miles values versus certification kWh/100 miles where both BEV and FCEV vehicle model types were simulated using a BEV model and bubble sizes reflect production volumes. ....  | 2-45 |
| Figure 2-21: Relationships between vehicle parameters for the MY 2021 fleet. ....   | 2-54 |
| Figure 2-22: Graphical results. ....  | 2-57 |
| Figure 2-23: MY 2032 Projected Vehicle Compliance Levels vs. Targets under Final Standards - Cars .....   | 2-58 |
| Figure 2-24: MY 2032 Projected Vehicle Compliance Levels vs. Targets under Final Standards - Trucks .....   | 2-59 |
| Figure 2-25: Distribution of Car Sales by Footprint, MY 2032 Vehicles .....   | 2-60 |
| Figure 2-26: NMC and LFP PEV battery pack direct manufacturing cost (100 kWh example)...  | 2-63 |
| Figure 2-27: Ni/Mn HEV battery pack direct manufacturing cost (1.5 kWh example). ....   | 2-63 |
| Figure 2-28: Volume weighted average pack direct manufacturing cost and marked-up cost per kWh after application of 45X credit. ....  | 2-67 |
| Figure 2-29: Example of a series-parallel hybrid drive system for a transverse/front-drive application. ....  | 2-83 |

|   |      |
|---|------|
| Figure 2-30: Redesign Years for Select Vehicles. ....   | 2-86 |
| Figure 3-1: Manufacturer Use of Key Technologies in Model Year 2022.....  | 3-2  |
| Figure 3-2: Gasoline Hybrid Engine Production Share by Vehicle Type. ....   | 3-4  |
| Figure 3-3: Production Share of BEVs, PHEVs, and FCEVs. ....  | 3-5  |
| Figure 3-4: Electric Vehicle Production Share by Vehicle Type. ....   | 3-6  |
| Figure 3-5: Plug-In Hybrid Vehicle Production Share by Vehicle Type.....  | 3-7  |
| Figure 3-6: Charge Depleting Range and Fuel Economy for BEVs and PHEVs.....   | 3-8  |
| Figure 3-7: Model Year 2022 Production of BEVs, PHEVs, and FCEVs. ....  | 3-9  |
| Figure 3-8: Examples of incomplete MDV chassis finished with customized bodies for specific applications. ....  | 3-10 |
| Figure 3-9: Rivian EDV 700 (left) and GM BrightDrop ZEVO 600 MDV (right) vans operated by Amazon and FedEx, respectively. ....  | 3-13 |
| Figure 3-10 North American battery and electric vehicle investments classified by manufacturing product .....   | 3-19 |
| Figure 3-11: Breadth of BIL and IRA supply and demand side incentives underway to build the supply chain. ....  | 3-25 |
| Figure 3-12: Share of top three producing countries for critical minerals and fossil fuels in 2019 (IEA). ....  | 3-26 |
| Figure 3-13: IEA accounting of share of refining volume of critical minerals by country (IEA 2022). ....  | 3-27 |
| Figure 3-14: Limit on battery GWh demand implemented in OMEGA, compared to projected battery manufacturing capacity and excess LCE supply. ....   | 3-37 |
| Figure 3-15: 2B-MAW Bin 1 In-use NO <sub>x</sub> standard with Ambient Temperature Correction and PEMS Accuracy Margin compared to 3B-MAW Bin 1 In-use NO <sub>x</sub> standard.....                      | 3-51 |
| Figure 3-16: Figure 8: 2B-MAW Bin 2 In-use NO <sub>x</sub> standard with Ambient Temperature Correction and PEMS Accuracy Margin Compared to 3B-MAW Bin 2 and Bin 3 In-use NO <sub>x</sub> standard. .... | 3-52 |
| Figure 3-17: MY2022-2023 MDV box and whisker plot showing the interquartile range (boxes) and data within 1.5X of the interquartile range (whiskers) for NMOG+NO <sub>x</sub> certification data... 3-    | 55   |
| Figure 3-18: Comparison between FTP and US06 NMOG+NO <sub>x</sub> certification values for MY 2023 vehicles with FTP certification values below 100 mg/mile.....  | 3-56 |
| Figure 3-19: Model Year 2023 NMOG+NO <sub>x</sub> FTP certification values as a function of engine displacement, MY 2023 fleet.....   | 3-62 |

|  |       |
|--|-------|
| Figure 3-20: Wall-flow GPF design. ....  | 3-66  |
| Figure 3-21: Composite cycle PM reduction at low and high GPF soot loading. ....   | 3-70  |
| Figure 3-22: Cycle-specific EC reduction. ....   | 3-71  |
| Figure 3-23: Composite cycle PAH reduction at low and high GPF soot loading. Sum of 26 filter collected PAHs shown on the left and sum of 26 gas phase PAHs shown on the right. .... | 3-72  |
| Figure 3-24: Filter-collected PAH emissions rates with no GPF, lightly loaded GPF, and heavily loaded GPF.....   | 3-73  |
| Figure 3-25: Cancer potency weighted toxicity of 20 filter-collected PAHs with no GPF, lightly loaded GPF, and heavily loaded GPF.....   | 3-74  |
| Figure 3-26: PM emissions from a MY 2019 F150, with and without a MY 2019 GPF. ....  | 3-75  |
| Figure 3-27: PM emissions from a MY 2021 F150 HEV, with and without a MY 2022 GPF. ....  | 3-76  |
| Figure 3-28: PM emissions from a MY 2022 F250, with and without MY 2022 GPFs. ....   | 3-77  |
| Figure 3-29: Test-to-test and lab-to-lab variability for 2021 F150 HEV with 2022 GPF. ....   | 3-78  |
| Figure 3-30: Test-to-test and lab-to-lab variability for 2021 Corolla. ....  | 3-78  |
| Figure 3-31: Vapor pressure of toluene and n-decane as a function of temperature. ....   | 3-79  |
| Figure 3-32: GPF direct manufacturing cost estimates.....  | 3-81  |
| Figure 3-33: Cycle-average GPF pressure drop as a function of test cycle.....  | 3-82  |
| Figure 3-34: Cycle-average GPF pressure drop as a function of the ratio of GPF size to average power required to drive US06 cycle. ....  | 3-83  |
| Figure 3-35: CO <sub>2</sub> increase caused by added GPF. Only the two light blue bars indicated are statistically significant to 95% confidence (p<0.05).....                      | 3-84  |
| Figure 3-36: Schematic of an ORVR system.....  | 3-86  |
| Figure 3-37: SAE J2841 FUF and finalized FUF for PHEV compliance.....  | 3-92  |
| Figure 3-38: Lifetime Total Grid Energy into Battery (less than 200-kWh).....  | 3-93  |
| Figure 3-39: FUFs with various data filtering sensitivities. ....  | 3-94  |
| Figure 3-40: BAR Regression FUF Curve fits with Sample-size Weighted. ....   | 3-95  |
| Figure 3-41: In-State and Out-of-State FUF Comparisons.....  | 3-99  |
| Figure 3-42: U.S. Retail Gasoline Prices. ....   | 3-100 |
| Figure 3-43: FUF Finalized, SAE FUF, and BAR Regression Fits at low gasoline prices. ....  | 3-100 |
| Figure 3-44. Grid Energy Consumptions during CDO vs PKE.....   | 3-101 |
| Figure 3-45. FUF vs Grid Energy Consumption at CD Engine Off.....  | 3-102 |

|  |       |
|--|-------|
| Figure 3-46. FUF vs Grid Energy into Battery (kWh).....  | 3-103 |
| Figure 3-47. FUF vs. Positive Kinetic Energy.....  | 3-103 |
| Figure 3-48. FUF Regression Fits with Different Filtering Criteria.....  | 3-104 |
| Figure 3-49. FUF Regression Fits with CD engine-on blended mode eVMT distance.....   | 3-105 |
| Figure 3-50: The Finalized FUF, SAE FUF, and ICCT Curves on 2-cycle combined GHG<br>emission-certified CD range .....                          | 3-108 |
| Figure 3-51: Toyota Prius: Sampling Distributions for the Blended UF for two Sample Sizes<br>(5,000 replicates).....                           | 3-111 |
| Figure 3-52: BMW 530E: Relative Standard Error vs. Sample Size for the Utility Factor based<br>on Bootstrap Sampling.....                      | 3-112 |
| Figure 3-53: Blended Utility Factor (UF) vs CD range, by model, with one-sided Dunnett<br>confidence intervals. ....                           | 3-113 |
| Figure 3-54: Blended Utility Factor by Gasoline-price Level for Selected Models.....   | 3-114 |
| Figure 3-55: Blended Utility Factor by Origin for Selected Models. ....  | 3-115 |
| Figure 3-56: 2013 Chevrolet 2.5L Ecotec LCV Engine Reg E10 Fuel BTE (%) (U.S. EPA<br>2023b). ....  | 3-118 |
| Figure 3-57: GT Power Baseline 2020 Ford 7.3L Engine from Argonne Report Tier 3 Fuel BTE<br>(%) (U.S. EPA 2023b). ....                         | 3-119 |
| Figure 3-58: 2013 Ford 1.6L EcoBoost Engine LEV III Fuel BTE (%) (U.S. EPA 2023b). ....  | 3-120 |
| Figure 3-59: 2015 Ford 2.7L EcoBoost V6 Engine Tier 3 Fuel BTE (%) (U.S. EPA 2023b). ...   | 3-121 |
| Figure 3-60: 2016 Honda 1.5L L15B7 Engine Tier 3 Fuel BTE (%) (U.S. EPA 2023b). ....   | 3-122 |
| Figure 3-61: Volvo 2.0L VEP LP Gen3 Miller Engine from 2020 Aachen Paper Octane<br>Modified for Tier 3 Fuel BTE (%) (U.S. EPA 2023b). ....     | 3-123 |
| Figure 3-62: Geely 1.5L Miller GHE from 2020 Aachen Paper Octane Modified for Tier 3 Fuel<br>BTE (%) (U.S. EPA 2023b).....                     | 3-124 |
| Figure 3-63: 2018 Toyota 2.5L A25A-FKS Engine Tier3 Fuel BTE (%) (U.S. EPA 2023b). ...   | 3-125 |
| Figure 3-64: Toyota 2.5L TNGA Prototype Hybrid Engine from 2017 Vienna Paper Octane<br>Modified for Tier 3 Fuel BTE (%) (U.S. EPA 2023b). .... | 3-126 |
| Figure 3-65: GT Power 2020 GM 3.0L Duramax Engine from Argonne Report Diesel Fuel BTE<br>(%) (U.S. EPA 2023b). ....                            | 3-127 |

|   |       |
|---|-------|
| Figure 3-66: Future 3.6L HLA Hybrid Concept Engine Tier 3 Fuel BTE (%) (adapted from VW 1.5L TSI evo Hybrid Concept 4 engine from 2019 Aachen Paper Octane Modified for Tier 3 Fuel). | 3-128 |
| Figure 3-67: Future 6.0L HLA Hybrid Concept Engine Tier 3 Fuel BTE (%) (adapted from VW 1.5L TSI evo Hybrid Concept 4 engine from 2019 Aachen Paper Octane Modified for Tier 3 Fuel). | 3-129 |
| Figure 3-68: 2014 Chevrolet 4.3L EcoTec3 LV3 Engine LEVIII Fuel - Cylinder Deac Enabled BTE (%) (U.S. EPA 2023b).   | 3-130 |
| Figure 3-69: 2014 Chevrolet 4.3L EcoTec3 LV3 Engine LEVIII Fuel - Cylinder Deac Disabled BTE (%) (U.S. EPA 2023b).  | 3-131 |
| Figure 3-70: 2010 Toyota Prius 60kW 650V MG2 EMOT Efficiency (%) (U.S. EPA 2023a).  | 3-132 |
| Figure 3-71: Est 2010 Toyota Prius 60kW 650V MG1 EMOT Efficiency (%) (U.S. EPA 2023a).  | 3-133 |
| Figure 3-72: 2011 Hyundai Sonata 30kW 270V EMOT Efficiency (%) (U.S. EPA 2023a).  | 3-134 |
| Figure 3-73: 2012 Hyundai Sonata 8.5kW 270V BISG Efficiency (%) (U.S. EPA 2023a).   | 3-135 |
| Figure 3-74: Generic IPM 150kW EDU Efficiency (%) (U.S. EPA 2023a).   | 3-136 |
| Figure 3-75: Percent Change in CO <sub>2</sub> Emissions from Tier 2 to Tier 3 Test Fuel (%)  | 3-155 |
| Figure 3-76: Percent Change in Carbon-Balance Fuel Economy from Tier 2 to Tier 3 Test Fuel (%)  | 3-156 |
| Figure 3-77: City/Highway Weighted Fuel Economy Difference Between Test Fuels for Different Calculation Methods, Shown by Vehicle (Fleet Average at Right)                            | 3-163 |
| Figure 4-1: Central case shareweight values for light-duty vehicles.  | 4-15  |
| Figure 4-2: Moderate third party PEV market shares with IRA.  | 4-17  |
| Figure 4-3: Faster BEV acceptance shareweight values by body style for LD vehicles.   | 4-20  |
| Figure 4-4: Slower BEV acceptance shareweight values by body style for light-duty.  | 4-22  |
| Figure 4-5: Curve fits for miles driven to a mid-trip charge event.   | 4-45  |
| Figure 4-6: Curve fits for the share of miles charged in mid-trip events.   | 4-46  |
| Figure 4-7: Maintenance cost per mile (2019 dollars) at various odometer readings.  | 4-51  |
| Figure 4-8: Repair cost per mile (2019 dollars) for a \$35,000 Car, Van/SUV and Pickup with various powertrains.  | 4-54  |
| Figure 4-9: Total new LD vehicle sales impacts, percent change from the No Action case.   | 4-64  |
| Figure 4-10: Workers per million dollars in sales, adjusted for domestic production.  | 4-76  |

|   |      |
|---|------|
| Figure 5-1: Modeling process flow highlighting the primary components for translating OMEGA’s national PEV stock projections and PEV attributes into hourly load profiles. ....   | 5-2  |
| Figure 5-2: Procedure for disaggregating OMEGA national PEV stock projections to IPM regions.....   | 5-3  |
| Figure 5-3: EVI-X National light-duty vehicle framework simulation showing spatiotemporal EV electricity demands for three separate use cases: typical daily travel (EVI-Pro), long-distance travel (EVI-RoadTrip), and ride-hailing (EVI-OnDemand). Adapted from Wood et al. (2023) with permission..... | 5-5  |
| Figure 5-4: Annual light- and medium-duty vehicle PEV charging loads (2030 and 2050 are shown) for each IPM region in the contiguous United States based on OMEGA charge demand for the final rule in 2030 (a) and 2050 (b). ....   | 5-7  |
| Figure 5-5: Yearly hourly (in EST) weekday and weekend load profiles for two IPM regions (ERC_WEST, west Texas; and ERC_REST, east Texas) broken out by charger type for an example OMEGA analytical scenario. ....   | 5-9  |
| Figure 5-6: Power sector modeling comparing results of the Bipartisan Infrastructure Law (BIL) and the Inflation Reduction Act (IRA). ....  | 5-12 |
| Figure 5-7: 2028 through 2050 power sector generation and grid mix. ....  | 5-15 |
| Figure 5-8: 2028 through 2050 power sector CO <sub>2</sub> emissions for final rule policy case (solid gray line) and no-action case (dashed line).....   | 5-16 |
| Figure 5-9: 2028 through 2050 power sector NO <sub>x</sub> emissions for final rule policy case (solid gray line) and no-action case (dashed line).....   | 5-16 |
| Figure 5-10: 2028 through 2050 power sector PM <sub>2.5</sub> emissions for final rule policy case (solid gray line) and no-action case (dashed line).....  | 5-17 |
| Figure 5-11: 2028 through 2050 power sector SO <sub>2</sub> emissions for final rule policy case (solid gray line) and no-action case (dashed line).....  | 5-17 |
| Figure 5-12: Electricity Market Module Regions (U.S. Energy Information Administraton 2019). ....   | 5-20 |
| Figure 5-13: Total Generation by IPM Region in 2028 and 2050 in No Action Case and Final Rule. ....   | 5-24 |
| Figure 5-14: Percentage of Total Generation from Renewable Energy Sources in 2028 and 2050 in No Action Case and Final Rule. ....   | 5-25 |
| Figure 5-15: Primary Energy Source by IPM Region in 2028 and 2050 in No Action Case and Final Rule.....   | 5-26 |
| Figure 5-16: Comparing CO <sub>2</sub> Emissions between the No Action Case and Final Rule in 2028 and 2050.....  | 5-27 |
| Figure 5-17: Comparing Mercury (Hg) Emissions between the No Action Case and Final Rule in 2028 and 2050.....   | 5-28 |

|  |      |
|--|------|
| Figure 5-18: Comparing NO <sub>x</sub> Emissions between the No Action Case and Final Rule in 2028 and 2050.....   | 5-28 |
| Figure 5-19: Comparing SO <sub>2</sub> Emissions between the No Action Case and Final Rule in 2028 and 2050.....   | 5-29 |
| Figure 5-20: Comparing PM <sub>2.5</sub> Emissions between the No Action Case and Final Rule in 2028 and 2050.....   | 5-30 |
| Figure 5-21: U.S. Public PEV Charging Infrastructure from 2011–2023 (Data Source: U.S. DOE, Alternative Fuels Data Center (AFDC 2024b) (AFDC 2024c).....   | 5-32 |
| Figure 5-22: Share of charging demand by location and type for the no-action case (left side of each pair of bars) and final rule (right side of each pair of bars) for 2028–2055. ....  | 5-40 |
| Figure 5-23: EVSE port counts by charging type for the final standards 2027–2055. ....   | 5-42 |
| Figure 5-24: EVSE port counts by charging type for the no-action case 2027–2055.....   | 5-42 |
| Figure 5-25: A comparison of the costs needed for distribution level upgrades for the no-action and action scenarios and showing the impacts of managed vs. unmanaged charging in California. ....                               | 5-59 |
| Figure 5-26: A comparison of the costs needed for distribution level upgrades for the no-action and action scenarios and showing the impacts of managed vs. unmanaged charging in Illinois (left) and Oklahoma (right).....      | 5-59 |
| Figure 5-27: A comparison of the costs needed for distribution level upgrades for the no-action and action scenarios and showing the impacts of managed vs. unmanaged charging in New York (left) and Pennsylvania (right). .... | 5-60 |
| Figure 5-28: National distribution-level cost comparison of the no action case with unmanaged growth to the FRM with managed growth and respective national average retail price of electricity.....                             | 5-60 |
| Figure 6-1: Important Factors Involved in Seeing a Scenic Vista (Malm, 2016).....  | 6-37 |
| Figure 6-2: Mandatory Class I Federal Areas in the U.S.....  | 6-38 |
| Figure 6-3: Nitrogen and Sulfur Cycling, and Interactions in the Environment. ....   | 6-41 |
| Figure 7-1: Counties designated nonattainment for PM <sub>2.5</sub> (1997, 2006, and/or 2012 standards)..  | 7-2  |
| Figure 7-2: 8-Hour ozone nonattainment areas (2008 Standard).....  | 7-3  |
| Figure 7-3: 8-Hour ozone nonattainment areas (2015 Standard).....  | 7-3  |
| Figure 7-4: Counties designated nonattainment for SO <sub>2</sub> (2010 standard). ....  | 7-5  |
| Figure 7-5: Map of the CMAQ 12 km modeling domain (noted by the purple box). ....  | 7-18 |
| Figure 7-6: Projected changes in annual average PM <sub>2.5</sub> concentrations in 2055 due to the rule...  | 7-21 |



|   |      |
|---|------|
| Figure 7-7: Projected changes in annual average PM <sub>2.5</sub> concentrations in 2055 from "onroad-only" emissions changes. ....                                 | 7-22 |
| Figure 7-8: Projected changes in 8-hour maximum average ozone concentrations in 2055 ozone season due to the rule. ....   | 7-24 |
| Figure 7-9: Projected changes in 8-hour maximum average ozone concentrations in 2055 ozone season from "onroad-only" emissions changes. ....                        | 7-25 |
| Figure 7-10 Projected change in 8-hour ozone design values in 2055 due to the Rule. ....  | 7-26 |
| Figure 7-11: Projected changes in annual average NO <sub>2</sub> concentrations in 2055 due to the rule. ...  | 7-27 |
| Figure 7-12: Projected changes in annual average NO <sub>2</sub> concentrations in 2055 from "onroad-only" emissions changes. ....                                  | 7-28 |
| Figure 7-13: Projected changes in annual average SO <sub>2</sub> concentrations in 2055 due to the rule. ....   | 7-29 |
| Figure 7-14: Projected changes in annual average SO <sub>2</sub> concentrations in 2055 from "onroad-only" emissions changes. ....                                  | 7-30 |
| Figure 7-15: Projected changes in annual average CO concentrations in 2055 due to the rule. ....  | 7-31 |
| Figure 7-16: Projected changes in annual average CO concentrations in 2055 from "onroad-only" emissions changes. ....   | 7-32 |
| Figure 7-17: Projected a) absolute changes and b) percent changes in annual average acetaldehyde concentrations in 2055 due to the rule. ....                       | 7-34 |
| Figure 7-18: Projected a) absolute changes and b) percent changes in annual average benzene concentrations in 2055 due to the rule. ....                            | 7-35 |
| Figure 7-19: Projected a) absolute changes and b) percent changes in annual average 1,3-butadiene concentrations in 2055 due to the rule. ....                      | 7-36 |
| Figure 7-20: Projected a) absolute changes and b) percent changes in annual average formaldehyde concentrations in 2055 due to the rule. ....                       | 7-37 |
| Figure 7-21: Projected a) absolute changes and b) percent changes in annual average naphthalene concentrations in 2055 due to the rule. ....                        | 7-38 |
| Figure 7-22: Projected a) absolute changes and b) percent changes in annual average acetaldehyde concentrations in 2055 from "onroad-only" emissions changes. ....  | 7-40 |
| Figure 7-23: Projected a) absolute changes and b) percent changes in annual average benzene concentrations in 2055 from "onroad-only" emissions changes. ....       | 7-41 |
| Figure 7-24: Projected a) absolute changes and b) percent changes in annual average 1,3-butadiene concentrations in 2055 from "onroad-only" emissions changes. .... | 7-42 |

|   |      |
|---|------|
| Figure 7-25: Projected a) absolute changes and b) percent changes in annual average formaldehyde concentrations in 2055 from "onroad-only" emissions changes.....                                 | 7-43 |
| Figure 7-26: Projected a) absolute changes and b) percent changes in annual average naphthalene concentrations in 2055 from "onroad-only" emissions changes. ....                                 | 7-44 |
| Figure 7-27: Projected changes in annual nitrogen deposition in 2055 due to the rule.....   | 7-45 |
| Figure 7-28: Projected changes in annual sulfur deposition in 2055 due to the rule.....   | 7-46 |
| Figure 7-29: Projected changes in annual nitrogen deposition in 2055 from "onroad-only" emissions changes. ....   | 7-47 |
| Figure 7-30: Projected changes in annual sulfur deposition in 2055 from "onroad-only" emissions changes. ....   | 7-47 |
| Figure 7-31: Distribution of PM <sub>2.5</sub> concentration reductions (µg/m <sup>3</sup> ) for each population group in 2055 from this final rule. ....   | 7-62 |
| Figure 7-32: Distribution of ozone concentration reductions (ppb) for each population group in 2055 from this final rule. ....  | 7-63 |
| Figure 8-1: ICE vehicle stock in OMEGA effects calculations.....  | 8-3  |
| Figure 8-2: BEV & PHEV stock in OMEGA effects calculations. ....  | 8-4  |
| Figure 8-3: Light- and medium-duty stock in OMEGA effects calculations. ....  | 8-4  |
| Figure 8-4: Share of ICE (including HEV), PHEV and BEV in the total light- and medium-duty stock in the No Action scenario. ....  | 8-5  |
| Figure 8-5: Share of ICE (including HEV), PHEV and BEV in the total light- and medium-duty stock under the Final standards.....   | 8-5  |
| Figure 8-6: Share of ICE (including HEV), PHEV and BEV in the total light- and medium-duty stock under Alternative A. ....  | 8-6  |
| Figure 8-7: Share of ICE (including HEV), PHEV and BEV in the total light- and medium-duty stock under Alternative B. ....  | 8-6  |
| Figure 8-8 Recent and Projected Future Fatality Rates for Cars and Light Trucks (NHTSA 2023) .....  | 8-14 |
| Figure 8-9: Energy distribution (top) and cumulative energy use (bottom) over 10,000 miles for the MOVES onroad data, compared to FTP/HW regulatory cycles, weighted 55%/45%. ....                | 8-21 |
| Figure 8-10: Energy distribution (top) and cumulative energy use (bottom) over 10,000 miles for the new cycle mix (27% FTP, 6% US06 bag 1, 67% US06 bag 2) compared to the MOVES onroad data..... | 8-23 |
| Figure 8-11: Speed distribution for the new cycle mix (27% FTP, 6% US06 bag 1, 67% US06 bag 2) compared to the MOVES onroad data.....   | 8-25 |

|  |       |
|--|-------|
| Figure 8-12: EGU GHG emission rates in the no action, final and alternative scenarios (grams/kWh of US generation).....  | 8-32  |
| Figure 8-13: EGU criteria pollutant emission rates in the no action, final and alternative scenarios (grams/kWh of US generation).....   | 8-32  |
| Figure 8-14: US Net Imports and Crude Oil Spot Prices.....   | 8-40  |
| Figure 8-15: Global liquids demand; from (Cherry Ding 2022).....   | 8-42  |
| Figure 8-16: Distillation capacity change by region; from (Cherry Ding 2022).....  | 8-43  |
| Figure 10-1: U.S. tight oil production by producing regions (in MMBD) and West Texas Intermediate (WTI) crude oil spot price (in U.S. Dollars per Barrel) Source: (U.S. EIA 2023) (U.S. EIA 2023).....   | 10-8  |
| Figure 10-2: Average U.S. fuel cost per vehicle mile driven of gasoline-powered vehicles and PEVs from 2011 to 2021 Sources: Electricity prices: (U.S. EIA 2022); Gasoline prices: (U.S. EIA 2022); Fuel economies: (U.S. EPA 2022).....         | 10-20 |
| Figure 10-3: Fuel cost per mile driven by gasoline-powered vehicles and PEVs for six states from 2011 to 2021 Sources: Electricity prices: (U.S. EIA 2022); Gasoline prices: (U.S. EIA 2022); Fuel economies: (U.S. EPA 2022).....               | 10-22 |
| Figure 10-4: Monthly percentage changes in U.S. retail electricity and gasoline prices from 2011 to 2021 Source: (U.S. EIA 2022).....  | 10-23 |
| Figure 10-5: U.S. electricity net imports as percentage of total electricity use from 2011 to 2020 and projected U.S. electricity net imports from 2021 to 2050. Source: (U.S. EIA 2023), (U.S. EIA 2023), (U.S. EIA 2023), (U.S. EIA 2023)..... | 10-25 |

## Executive Summary

Under its Clean Air Act (CAA) Section 202 authority, the Environmental Protection Agency (EPA) is finalizing new, more stringent emissions standards for criteria pollutants and greenhouse gases (GHG) for light-duty vehicles and Class 2b and 3 ("medium-duty") vehicles that phase-in over model years 2027 through 2032. In addition, EPA is finalizing GHG program revisions in several areas, including off-cycle and air conditioning credits, the treatment of battery electric vehicles (BEV) and plug-in hybrid electric vehicles (PHEV) in fleet average calculations, and vehicle certification and compliance. EPA is also finalizing new standards to control refueling emissions from incomplete medium-duty vehicles, and battery durability and warranty requirements for BEVs.

Despite the significant emissions reductions achieved by previous rulemakings as discussed in Section I.A.1 of the preamble, air pollution from motor vehicles continues to impact public health, welfare, and the environment. Emissions from motor vehicles contribute to ozone, particulate matter (PM), and air toxics. This air pollution is linked with premature death and other serious health impacts, including respiratory illness, cardiovascular problems, and cancer, and affects people nationwide, as well as those who live or work near transportation corridors. In addition, the effects of climate change represent a rapidly growing threat to human health and the environment, and are caused by GHG emissions from human activity, including motor vehicle transportation. Addressing these public health and welfare needs will require substantial additional reductions in criteria pollutants and GHG emissions from the transportation sector, which is the largest U.S. source of GHG emissions, representing 29 percent of total GHG emissions.<sup>1</sup> Within the transportation sector, light-duty vehicles are the largest contributor, at 58 percent, and thus comprise 16.5 percent of total U.S. GHG emissions,<sup>2</sup> even before considering the contribution of medium-duty Class 2b and 3 vehicles which are also included under this rule. GHG emissions have significant impacts on public health and welfare as evidenced by the well-documented scientific record, and as set forth in EPA's Endangerment and Cause or Contribute Findings under section 202(a) of the CAA.<sup>3</sup> As discussed in Section II.A of the preamble, major scientific assessments continue to be released that further advance our understanding of the climate system and the impacts that GHGs have on public health and welfare both for current and future generations, making it clear that continued GHG emission reductions in the motor vehicle sector are needed to protect public health and welfare.

Our analysis for these standards, as explained throughout the preamble and RIA, show that the standards will result in significant reductions in emissions of criteria pollutants, GHGs, and air toxics, resulting in significant benefits for public health and welfare. We estimate that this rule will achieve approximately 7.7 billion metric tons in net CO<sub>2</sub> reductions through 2055 and will continue to provide emission reductions thereafter. These GHG emission reductions will contribute toward reducing the probability of severe climate change related impacts which people of color, low-income populations and/or indigenous peoples may be especially vulnerable

---

<sup>1</sup> Inventory of U.S. Greenhouse Gas Emissions and Sinks: 1990–2021 (EPA-430-R-23-002, published April 2023).

<sup>2</sup> Ibid.

<sup>3</sup> 74 FR 66496, December 15, 2009; 81 FR 54422, August 15, 2016.

to. We also estimate that the standards will result in reduced vehicle operating costs for consumers and that the benefits of the program will significantly exceed the costs.

The health and environmental effects associated with GHG and criteria pollutant emissions are a classic example of a negative externality (an activity that imposes uncompensated costs on others). With a negative externality, an activity's social cost (the cost borne to society imposed as a result of the activity taking place) exceeds its private cost (the cost to those directly engaged in the activity). In this case, as described in Chapter 6, GHG and criteria pollutant emissions from light- and medium-duty vehicles impose public health and environmental costs on society. However, these added costs are not reflected in the costs of those using these vehicles. The current market and regulatory scheme do not correct this externality because firms in the market are rewarded for minimizing their production costs, including the costs of pollution control, and do not benefit from reductions in emissions. In addition, firms that may take steps to reduce air pollution may find themselves at a competitive disadvantage compared to firms that do not. The GHG and criteria pollutant emission standards that EPA is finalizing help address this market failure and reduce the negative externality from these emissions by providing a regulatory incentive for vehicle manufacturers to produce engines that emit fewer harmful pollutants and for vehicle owners to use those cleaner engines.

This Regulatory Impact Analysis (RIA) contains supporting documentation for the EPA rulemaking and addresses requirements in CAA Section 317 and requirements under Executive Order (E.O.) 12866 to estimate the benefits and costs of major new pollution control regulations. The preamble to the Federal Register notice associated with this document provides the full context for the EPA rule, and it references this RIA throughout.

## **RIA Chapter Summary**

This document contains the following Chapters:

### **Chapter 1: Development of GHG Standards and BEV Durability Requirements**

This chapter provides technical details supporting the development of the GHG standards for both light-duty and medium-duty vehicles, and a separate section that provides additional background on development of EPA's battery durability standards compared to those developed by the United Nations (UN) and California.

### **Chapter 2: Tools and Inputs Used for Modeling Technologies and Adoption Towards Compliance**

This chapter summarizes the tools and inputs used for modeling technologies, adoption of technologies, and vehicle compliance with the standards. This includes details regarding the OMEGA model, ALPHA vehicle simulation tools, and the Agency's approach to analyzing vehicle manufacturing costs, consumer demand, and vehicle operational costs. The chapter also includes a summary of modeling inputs that reflect our assessment of impacts due to the implementation of the Inflation Reduction Act of 2022.

### **Chapter 3: Analysis of Technology Feasibility for Reducing GHG and Criteria Pollutant Emissions**

This chapter provides EPA's analysis of technologies available for further reducing both GHG and criteria pollutant emissions and current technology trends. It also provides EPA's analysis supporting the revisions for on-board diagnostics and the revised PHEV utility factor.

### **Chapter 4: Consumer Impacts and Related Economic Considerations**

This chapter discusses consumer impacts of this rule, including the consumer purchase decision, the ownership experience, consumer-related benefits and costs, as well as the effect on new vehicle sales, and estimated employment effects. In the discussion of the purchase decision, we include costs consumers incorporate into their purchase decision, how consumers respond to costs, and how consumer perception of technologies change, or do not, over time. Within our discussion of the ownership experience, we include vehicle use and the effect on consumer savings and expenses, including vehicle miles traveled, rebound effect, fueling costs, maintenance and repair, and noise and congestion costs due to this rule. Consumer-related costs and benefits include components of social costs and benefits that are included in the benefit-cost analysis and that have direct consumer impacts. The discussion of new vehicle sales explains how vehicle sales were modeled, including an explanation of the elasticity of demand used in our analysis, as well as the estimated effect of the rule on total vehicle sales. We conclude the chapter with a description of employment effects, including potential impacts of the growing prevalence of PEVs, a quantitative estimate of partial employment impacts on sectors directly impacted by this rule, and discuss potential impacts on other related sectors.

### **Chapter 5: Electric Infrastructure Impacts**

This chapter provides EPA's analysis of plug-in electric vehicle (PEV) charge demand and regional distribution, electric power sector modeling including estimating retail electricity prices, and EPA's assessment of current and future PEV charging infrastructure. Finally, this chapter discusses electric grid resiliency.

### **Chapter 6: Health and Welfare Impacts**

The rule will impact emissions of GHGs, criteria pollutants, and air toxic pollutants. This chapter describes the health and welfare impacts associated with ambient concentrations of GHGs, criteria pollutants, and air toxics.

### **Chapter 7: Analysis of Air Quality Impacts of Light- and Medium-Duty Vehicles Regulatory Scenario**

For this final rule, EPA conducted an air quality modeling analysis of the proposed standards involving light- and medium-duty "onroad" vehicle emission reductions and corresponding changes in "upstream" emission sources like EGUs (electric generating units) and refineries. Chapter 7 presents the projected air quality impacts in 2055 as well as an analysis of the PM<sub>2.5</sub>- and ozone-related health benefits associated with improved air quality in 2055. We also present the results of a demographic analysis of how human exposure to air pollution in 2055 varies with sociodemographic characteristics relevant to potential environmental justice concerns in scenarios with and without the rule in place.

## **Chapter 8: OMEGA Physical Effects of the Final Standards and Alternatives**

This chapter describes the methods and approaches used within the OMEGA model to estimate physical effects of the standards. Physical effects refer to emission inventories, fuel consumption, oil imports, vehicle miles traveled including effects associated with the rebound effect, and safety effects. The cost and benefits of the rule are estimated based on our estimates of these physical effects and are discussed in Chapter 9 of this RIA.

## **Chapter 9: Costs and Benefits of the Final Standards in OMEGA**

This chapter presents the costs and benefits calculated within OMEGA. The results presented here show the estimated annual costs, fuel savings, and benefits of the program for the indicated calendar years (CY). The results also show the present-values (PV) and the equivalent annualized values (AV) of costs and benefits for the calendar years 2027–2055 using 2, 3, and 7 percent discount rates. For the estimation of the stream of costs and benefits, we assume that the MY 2032 standards apply to each year thereafter.

## **Chapter 10: Energy Security Impacts**

This chapter provides EPA's evaluation of the energy security impacts of the light- and medium-duty vehicle rule. It provides a review of historical and recent energy security literature and our assessment of potential electricity and oil security impacts.

## **Chapter 11: Small Business Flexibilities**

This chapter discusses the flexibilities EPA finalized to provide to small businesses for model years 2027 and later for both the final GHG and criteria pollutant emissions standards.

## **Chapter 12: Compliance Effects**

This chapter summarizes the outputs from OMEGA related to the standards and the two alternatives which were presented in Section III.F of the preamble. It provides EPA's detailed modeling results of GHG targets, projected achieved compliance GHG rates, as well as vehicle costs and technology penetrations. These projections are grouped by car and truck regulatory classes, and in select tables, using EPA's classification of body style in its OMEGA model.

# Chapter 1: Development of GHG Standards and PEV Durability Requirements

This chapter provides technical details supporting the development of the greenhouse gas (GHG) standards for both Light-duty and Medium-duty Vehicles, and a separate Section that provides additional background on development of EPA's battery durability standards compared to those developed by the UN and California.

## 1.1 Development of the final GHG standards for Light-Duty Vehicles

As a prelude to the development of the final standards, EPA first evaluated how the market (manufacturers and consumers) responded (and the implications on emissions) since the footprint-based standards were first established for 2012 model year (MY). We have witnessed a shift in sales mix from the car regulatory class to truck class (described in 1.3.1), and an increase in average vehicle footprint. One of the issues we assessed was potential ways to minimize potential erosion of projected GHG reductions due to changes in fleet mix that might be influenced by the program structure.

The Technical Support Document (TSD) supporting the 2017-2025 NPRM (U.S. EPA 2011) outlined EPA's rationale in its selection of footprint as the attribute for its GHG standards and provided a detailed discussion of the statistical methodology applied in fitting footprint curves to fleet data. EPA continues to believe that footprint is appropriate for attribute-based standards, and we did not reopen this issue in the rulemaking.<sup>4</sup>

In assessing new footprint curves, EPA wanted to a) reduce the likelihood of change to average vehicle footprint as a compliance strategy and b) to minimize the incentive to shift vehicle attributes and the resulting car/truck classification as a compliance strategy. The following steps were taken (discussed in 1.1.3):

- Establish a footprint slope for passenger vehicles (cars) that does not overly incentivize upsizing or downsizing
- Identify an appropriate CO<sub>2</sub> emissions offset for trucks (relative to passenger vehicles) to recognize the incremental tailpipe CO<sub>2</sub> due to inclusion of all-wheel drive (AWD)<sup>5</sup> and nominal towing capability, and incorporate it into a footprint curve for trucks
- Assess whether these slopes, of their own accord, incentivize a fleet shift towards larger or smaller vehicles
- Assess cutpoints based on observed trends in full size trucks, and reflective of equity concerns for smaller vehicles

---

<sup>4</sup> See 88 FR 29234 (May 5, 2023).

<sup>5</sup> We use the term AWD to include all types of four-wheel drive systems, consistent with SAE standard J1952.



### **1.1.1 Analysis of fleet changes since 2012**

During the past rulemakings for GHG standards, several stakeholders have urged the Agency to address what they viewed as overly generous CO<sub>2</sub> targets for light trucks. EPA received several comments on its 2021 NPRM requesting that the nature of the footprint curves, and of the dual standards for cars and trucks, be re-examined. In collective response to these comments, and as preliminary analysis, EPA felt that it was appropriate to assess changes in the fleet and their impact on performance of the light-duty GHG program. EPA has now gathered 10 years of sales data since the attribute-based GHG standards for light-duty vehicles first took effect in 2012 MY. While the light-duty GHG program has achieved significant emissions reductions over the past decade, EPA witnessed underperformance of achieved tailpipe GHG emissions rates compared to those that were originally projected. This underperformance can be attributed to the market shift towards SUVs and trucks, as well as a modest increase in average vehicle size.

#### **1.1.1.1 Car and Truck Regulatory Classes**

The separate car and truck curves stem from regulatory class definitions originally established by NHTSA in its corporate average fuel economy (CAFE) program for cars and trucks, as directed by passage of Energy Policy and Conservation Act (EPCA) in 1975 (Public Law 94-163 1975). EPCA originally defined passenger automobiles ("cars") as "any automobile (other than an automobile capable of off-highway operation) which the Secretary [i.e., NHTSA] decides by rule is manufactured primarily for use in the transportation of not more than 10 individuals." Under EPCA, there are two general groups of automobiles that qualify as non-passenger automobiles or light trucks:

- 1) those defined by NHTSA in its regulations as other than passenger automobiles due to their having not been manufactured "primarily" for transporting up to ten individuals; and
- 2) those expressly excluded from the passenger category by statute due to their capability for off-highway operation, regardless of whether they were manufactured primarily for passenger transportation. NHTSA's classification rule directly tracks those two broad groups of non-passenger automobiles in subsections (a) and (b), respectively, of 49 CFR Part 523.5 (49 CFR § 523.5 2022).

EPA stated the following reasons in its 2012 FRM (77 FR 62624 2012) as to why it adopted separate car and truck regulatory classes, and separate standards for each:

- First, some vehicles classified as trucks (such as pick-up trucks) have certain attributes not common on cars which attributes contribute to higher CO<sub>2</sub> emissions – notably high load carrying capability and/or high towing capability. Due to these differences, it is reasonable to separate the light-duty vehicle fleet into two groups.
- Second, EPA wished to harmonize key program design elements of the GHG standards with NHTSA's CAFE program where it was reasonable to do so. NHTSA is required by statute to set separate standards for passenger cars and for non-passenger cars.

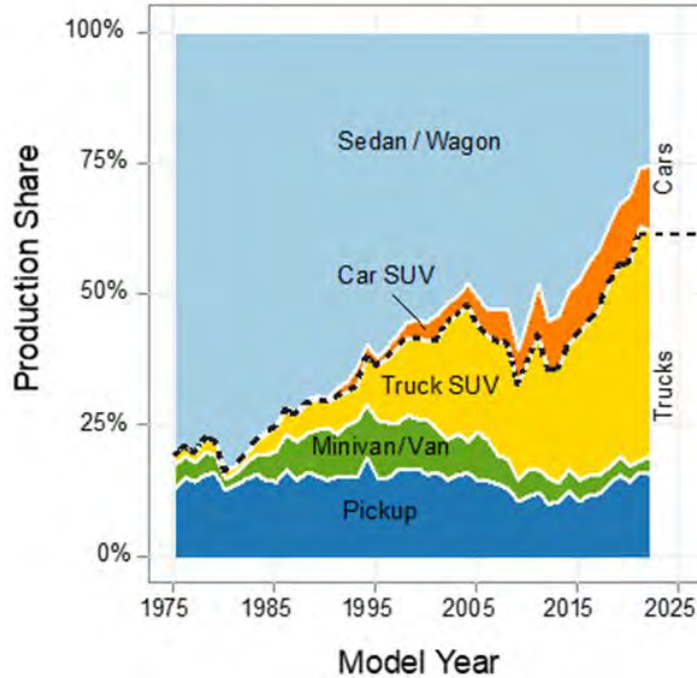
- Finally, most of the advantages of a single standard for all light-duty vehicles are also present in the two-fleet standards. Because EPA allows unlimited credit transfer between a manufacturer’s car and truck fleets, the two fleets can essentially be viewed as a single fleet when manufacturers consider compliance strategies. Manufacturers can thus choose on which vehicles within their fleet to focus GHG-reducing technology and then use credit transfers as needed to demonstrate compliance, just as they would if there was a single fleet standard.

Historically, for the same footprint vehicle, truck standards have been higher (less stringent) than their equivalent-sized car. For example, for a 50 sq. ft crossover vehicle, the AWD version (almost always classified as a truck) would be subject to a standard 40 or more g/mile higher than an equivalent 2WD version of that same model (classified as a car). Beyond MY 2021, the offset between the two curves will start to reduce but it is still significant. Table 1-1 shows a comparison of the GHG targets (and the calculated offset) for a 50-square foot car and truck crossover through the years. Certification data for MY 2019 vehicles comparing tailpipe CO<sub>2</sub> emissions of vehicle models which are sold as both cars and light trucks (such as crossovers), depending on their drivetrain - suggests that the empirical tailpipe CO<sub>2</sub> emissions offset is far less than the compliance offset which has been provided to crossover vehicles.

**Table 1-1. Comparison of Car and Truck GHG Targets for 50 Square-Foot Vehicles**

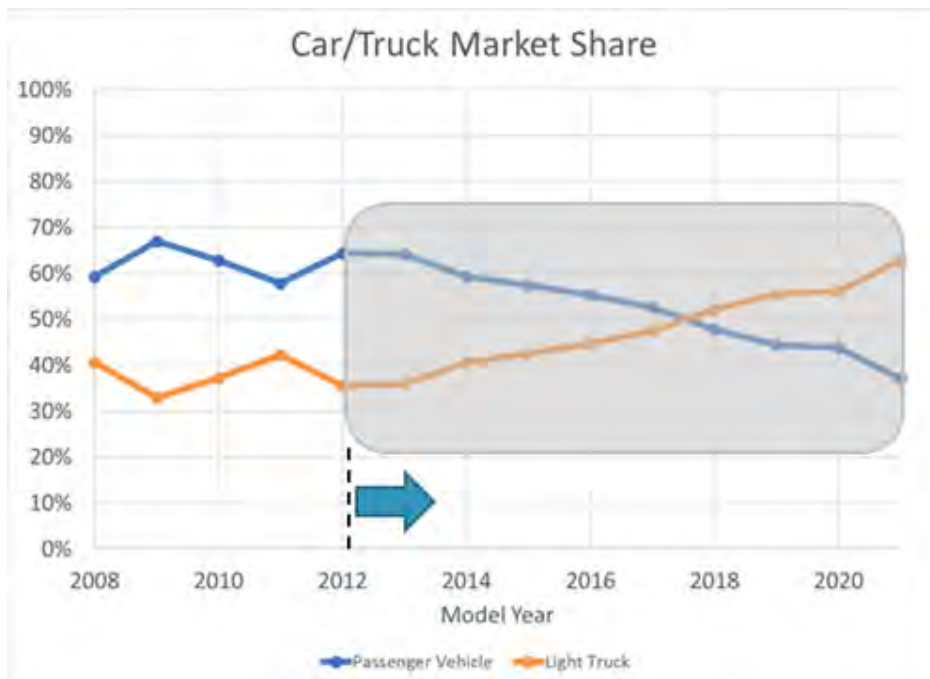
| Model Year | Car Target g/mi | Truck Target g/mi | Offset g/mi |
|------------|-----------------|-------------------|-------------|
| 2012       | 287             | 331               | 44          |
| 2017       | 235             | 282               | 46          |
| 2021       | 197             | 247               | 50          |
| 2026       | 142             | 172               | 30          |

Since the footprint-based light-duty GHG standards first took effect in MY 2012, the makeup of the fleet has changed significantly. In 2012, 64 percent of new vehicle sales were classified as passenger vehicles, with the remaining 36 percent of sales as light trucks. As of 2021, sales of sedans have declined; from 55 percent in 2012, they now represent only 26 percent of fleet sales. Sedans have largely been replaced with taller vehicles such as truck-like sport utility vehicles (SUVs) and crossover utility vehicles (CUVs). There has also been an increase in pickup truck share, from 10 percent to 16 percent in 2021. The shift in sales mix of vehicle types is shown in Figure 1-1.



**Figure 1-1. Light-Duty Sales by Vehicle Type (U.S. EPA 2022)**

In total, there has been a marked increase in the number of light truck sales: as of 2021, light trucks now account for 63 percent of new sales, and passenger vehicles only account for 37 percent of sales. This is illustrated in Figure 1-2.

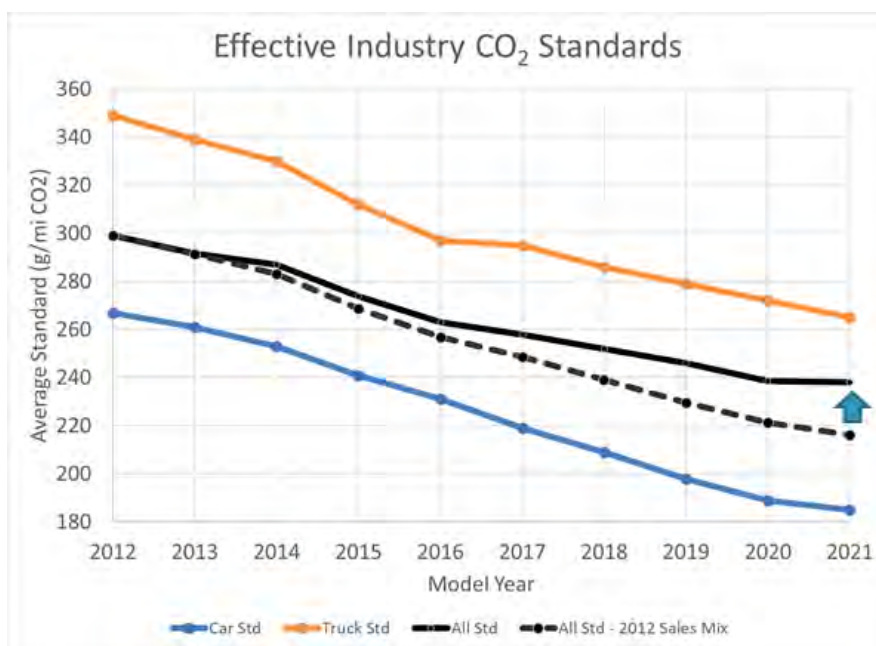


**Figure 1-2. Change in Car and Truck Regulatory Class Market Share, 2012-2021 MY**

The impact of this shift to light trucks on CO<sub>2</sub> emissions has been noteworthy. In its analysis supporting the 2012 rulemaking (which set standards for MY 2017-2025 vehicles) EPA's projected fleet mix for future years was unchanged from MY 2012 at 64 percent car and 36 percent truck<sup>6</sup>. For the 2021 standards, EPA projected that the MY 2021 fleet (based on the originally projected car/truck mix and average footprint) would need to meet an average CO<sub>2</sub> target of 217 g/mile.<sup>7</sup> However, the shift in actual car/truck mix to 37 percent car and 63 percent truck alone resulted in 14 g/mile higher standards by MY 2021.

Meanwhile, the fleet has increased its overall average footprint by over 5 percent (from 48.9 sq ft in 2012 to 51.5 sq ft in 2021), due to fewer small sedans, and an increase in average full-size pickup trucks. This shift has permitted compliance under higher numerical standards: the result of the increased average footprint alone resulted in an 8 g/mile increase in the MY 2021 fleet average GHG target compared to the MY 2012 average footprint.

In total, the sum of these effects has resulted in MY 2021 standards that are 22 g/mile higher on a fleetwide average than were originally projected. The effects of car/truck shift and footprint increase (combined) are illustrated in Figure 1-3. From 2012-2021, the GHG program has projected combined reductions in CO<sub>2</sub> emissions rates of 28 percent (or an average annual rate of 3.5 percent per year). During this period, the achieved industry CO<sub>2</sub> emissions performance value for new vehicles has only decreased from 287 g/mile in 2012 to 239 g/mile in 2021 - an average annual reduction of about 2 percent per year (U.S. EPA 2022).



**Figure 1-3. Effect of Fleet Shift on Average CO<sub>2</sub> Standard.**

<sup>6</sup> For the 2020 rule the projected car/truck mix was revised to 54 percent car and 46 percent truck, but it still underestimated the market share of trucks that would be sold.

<sup>7</sup> This has been adjusted from the published values to reflect differences in expected lifetime VMT for trucks compared to cars.

### **1.1.2 Relationship between GHG curve shape, stringency, and BEV share**

It is important to note that for the earlier rulemakings, footprint was selected as an attribute with a fleet that was almost exclusively comprised of internal combustion engine (ICE) vehicles. In contrast, footprint does not have any relationship with tailpipe emissions from BEVs or any other zero-emission vehicle. A fleet of exclusively battery electric vehicles would all emit zero g/mile tailpipe GHG, regardless of attribute (vehicle size, weight, tow rating, etc.); mathematically, the only appropriate "footprint curve" for an all-electric fleet would have a slope of zero (flat) and be set to zero g/mi. And so, as PEVs penetrate further into the fleet mix, the appropriate slope for the fleet will need to consider not just the current available technology of ICE vehicles, but the ratio of those ICE vehicles sold as a percentage of the entire fleet of new vehicles (including BEVs and PHEVs). For example, if only 50 percent of new vehicles sold were ICE vehicles, it would be reasonable to scale the slope of the curves by roughly 50 percent. In setting future fleet average standards, the anticipated decreasing level of ICE vehicles are thus factored into the setting of the car and truck slopes.

### **1.1.3 Development of appropriate GHG curve shape (slope and cut points)**

As discussed in Chapter 1.1 above, EPA believes that footprint is still an appropriate attribute for its standards curves and did not reopen this issue for the rulemaking. However, EPA assessed ways to modify the shape of the footprint curves and the relative difference between cars and trucks to minimize the incentive for manufacturers to change vehicle size or regulatory class as a compliance strategy, which is not a goal of the program and could in turn potentially reduce the projected GHG emissions reductions.

Beginning with the premise that the primary objective of light-duty vehicles (regardless of their car/truck regulatory class designation) is to move people and their incidental cargo, EPA first determined an appropriate curve slope for passenger vehicles (cars). The distinguishing features that provide more capability for trucks and the associated increase in tailpipe emissions (for ICE vehicles) are then used to build out a separate truck curve from the base car curve. The steps and the analysis performed are described below.

#### **1.1.3.1 Establishing slope of car curve**

EPA's OMEGA model, in addition to modeling the application of vehicle technology, also has the capability to project changes in vehicle size as a compliance response. In determining an appropriate slope for the car curve, EPA modeled a range of car slopes to evaluate the footprint response – that is, to assess the tendency of the fleet to upsize or downsize as a compliance strategy.

In theory, for ICE vehicles, where there is a generally consistent relationship between vehicle size and emissions, a footprint-based slope that is too steep will incentivize manufacturers to increase the size of their vehicles as a compliance strategy, whereas a slope too flat may encourage some downsizing. For BEVs, there is no relationship between footprint and tailpipe emissions, so any slope greater than zero should provide manufacturers with a compliance incentive (at some level) to upsize BEVs. If a fleet were comprised of entirely of BEV and ICE vehicles subject to the same footprint curve, the best compromise for determining a "neutral" slope would be one that strikes a balance between upsizing incentives for BEVs with downsizing incentives for ICE vehicles.

For any given vehicle, a manufacturer may be incentivized to increase footprint if the compliance benefit of higher GHG target values (and potentially less costly technology needed for compliance) and consumer valuation of vehicle size exceeds the additional cost of producing a larger vehicle and higher emissions associated with greater vehicle mass. In the OMEGA model inputs, we assumed a consumer valuation, or willingness-to-pay (WTP) of \$200/sq ft of vehicle footprint. While this is on the low end of the range suggested in the literature (Greene 2018), a higher WTP would create a stronger upsizing tendency, which would suggest an even flatter "size-neutral" slope than found in our analysis.

The slope that corresponded with a neutral response (overall, no change in the average footprint of ICE vehicles) for the predominantly ICE vehicle-base year fleet was 0.8 g/mi/square foot. As we discuss in Section III.C.2.ii of the preamble, as emissions control technology becomes increasingly more effective, the relationship between tailpipe emissions and footprint decreases proportionally; in the limiting case of vehicles with 0 g/mile tailpipe emissions such as BEVs, there is no relationship at all between tailpipe emissions and footprint. For a future level of stringency equivalent to 50 percent of the current fleet g/mi average, we scaled down the slope accordingly. In this example, the 0.8 slope would be scaled down to 0.4 (50 percent of the neutral-response slope we established).

To confirm that this slope would give us a neutral response over a mixed fleet of lower emitting vehicles with a range of technologies, we reviewed the footprint response (again, at a stringency corresponding to 50 percent of today's fleet average target) for slopes ranging from 0 to 0.8 g/mi/sq ft. Figure 1-4 (for sedans) and Figure 1-5 (car SUVs) show the final fleet average footprint, compared to the base year average footprint (in orange) for each slope tested. The overall fleet-neutral slope was determined to be 0.43 g/mi/sq ft. As can be seen, the shift in the two body styles balance out (about 0.5 sq ft increase for sedans and a 0.5 sq ft decrease for car SUVs).

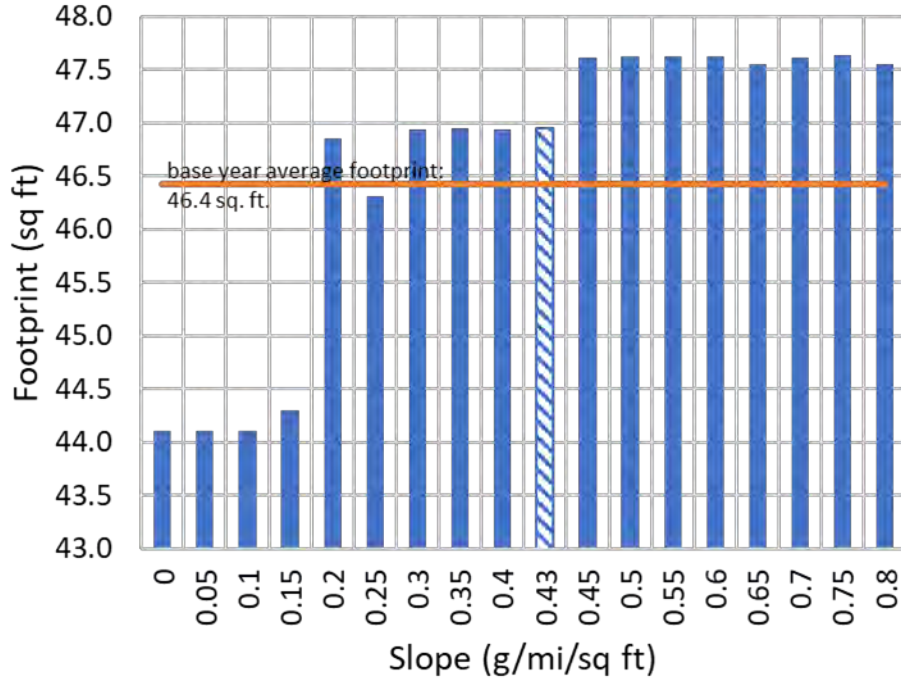


Figure 1-4. Footprint Response to Slope Sweeps, Sedan/Wagon Body Style.

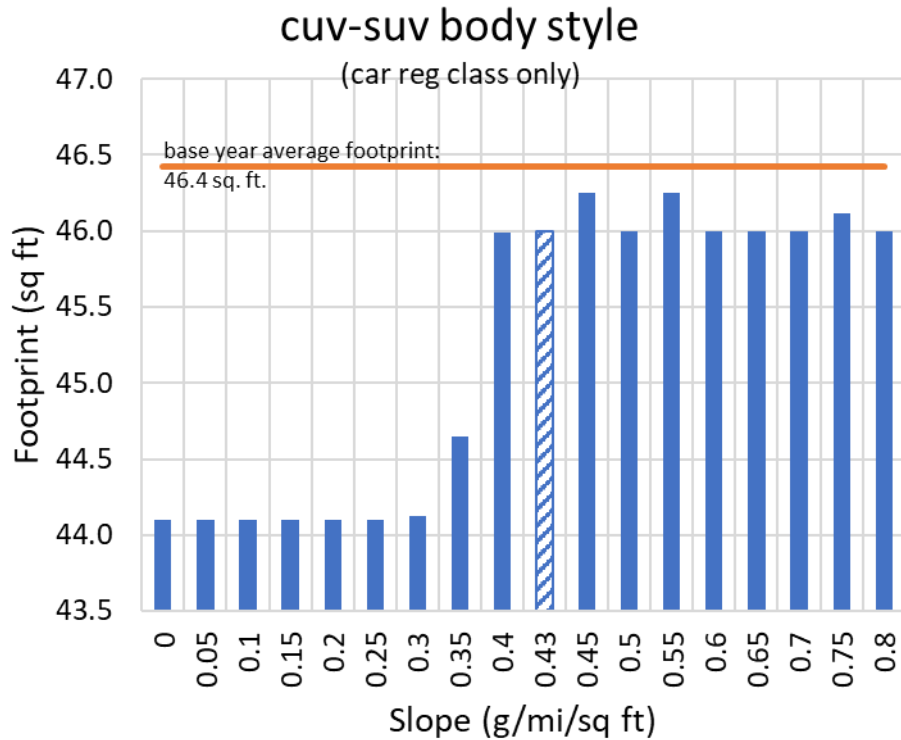


Figure 1-5. Footprint Response to Slope Sweeps, (Car Reg Class) CUV/SUV Body Style.

### 1.1.3.2 Development of truck curve

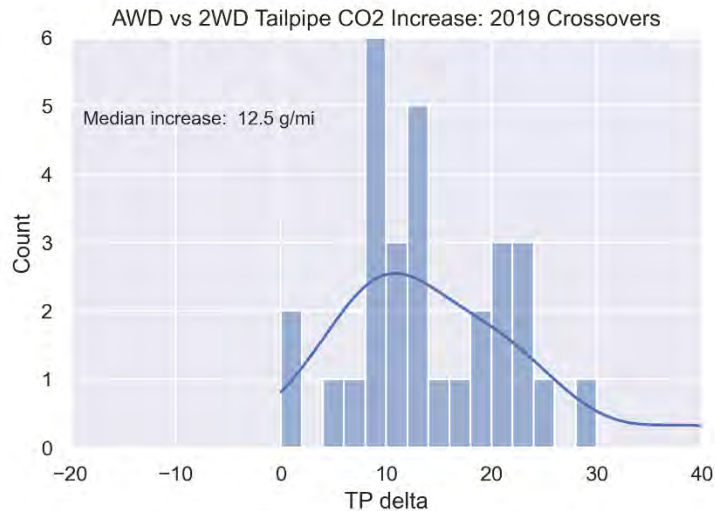
Historically, there has been a significant increase (offset) between the car and light truck footprint-based curves to reflect the additional utility of trucks. The large shift in sales from car crossovers to truck crossovers might suggest that the size of this offset was not appropriate for vehicles with similar towing and hauling capability - for example, crossover vehicle models (trucks) equipped with AWD compared to those same models with 2WD (cars). Most of these vehicles available with both driveline options exhibit the same tow rating and nearly identical GCWR.

In redesigning the truck curve, EPA considered the "base utility" of moving people for passenger vehicles and light trucks to be similar (this is especially true for crossover vehicles and wagons, for example). However, larger trucks which are designed for more towing and hauling capability do require design changes to allow for handling of these larger loads and this is reflected in increased engine capability, body-on-frame design, and greater structural mass. EPA analyzed empirical fleet data to quantify the additional tailpipe CO<sub>2</sub> resulting from these required design changes and use it as a basis for a "utility offset" that is built into the slope of the final truck curves.

The truck curve is based on the car curve, but with additional allowances for 1) AWD and 2) towing and hauling utility. The analysis that went into the determination of each offset, and the resulting truck slope, is detailed below.

#### 3) AWD Offset

EPA analyzed certification data (Ellies 2023) from MY 2019 (the latest at the time the analysis was completed) to compare the tailpipe CO<sub>2</sub> emissions of crossover vehicle models with 2WD and AWD driveline configurations and identical engines. In total, 32 vehicle models were offered in both a 2WD and an AWD version and were subject to passenger vehicle and light truck CO<sub>2</sub> compliance targets, respectively.



**Figure 1-6. Increase in Tailpipe CO<sub>2</sub> Emissions: MY 2019 AWD vs. 2WD Crossovers.**



Figure 1-6 shows the distribution of tailpipe increase between unique 2WD and AWD vehicle models. The median increase in tailpipe CO<sub>2</sub> is 12.5 g/mile for these models, although several models showed increases below 10 g/mi. As this characteristic is the only attribute distinguishing a “truck” crossover from a “car” crossover that should produce measurable tailpipe CO<sub>2</sub> differences, it forms the basis for the offset between the car and truck curves for vehicles of equivalent towing capacity. Based on this analysis, EPA's final footprint curves reflect an offset between the car and truck curves of 10 g/mile for ICE vehicles equipped with AWD.

#### 4) Towing and Hauling Utility Offset

In determining an offset for truck utility, EPA reviewed vehicle specifications available in the MY 2019 fleet data. One way to quantify a vehicle's utility (or maximum output) is by its gross combined weight rating (GCWR).<sup>8</sup> GCWR is the value specified by the vehicle manufacturer as the maximum weight of a loaded vehicle and trailer (40 CFR § 86.1803-01 2023).

In its simplest form,

$GCWR = GVWR + \text{maximum loaded trailer weight},$

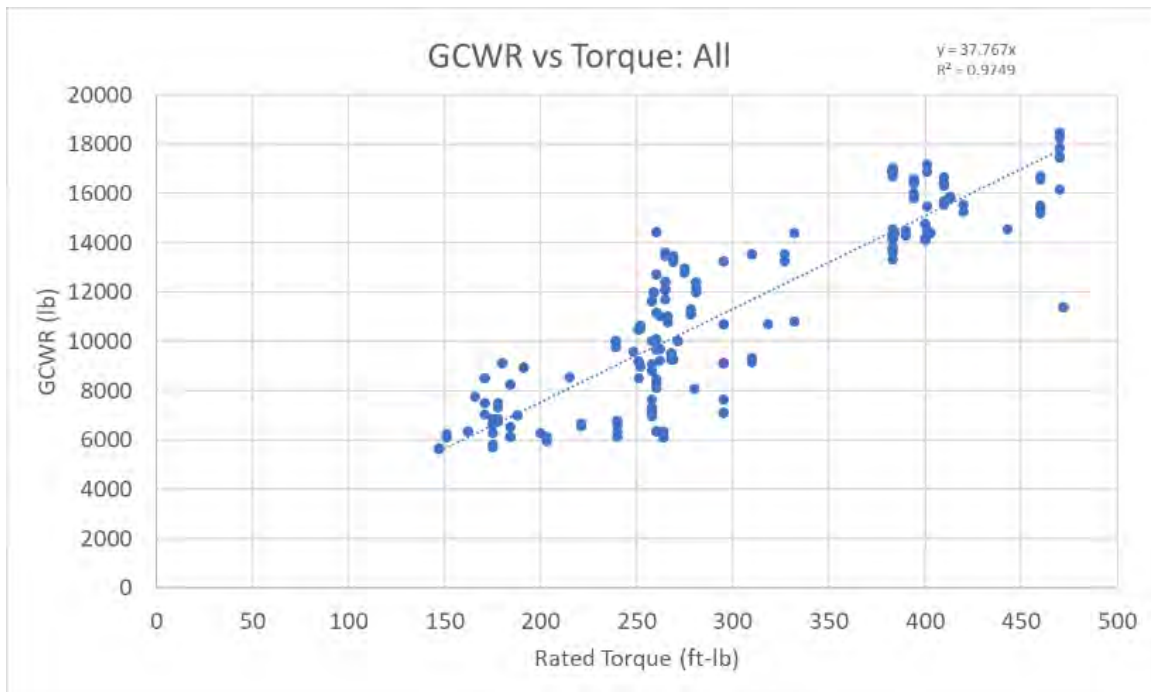
where:

GVWR (gross vehicle weight rating) is the value specified by the manufacturer as the maximum design loaded weight of a single vehicle (40 CFR § 86.1803-01 2023).

EPA first reviewed MY 2019 vehicle models and plotted GCWR vs engine performance. Of horsepower or engine torque, engine torque correlated best with a truck's utility. As shown in Figure 1-7, there is a positive correlation between a vehicle's GCWR and its rated engine torque.

---

<sup>8</sup> GVWR describes the maximum load that can be carried by a vehicle, including the weight of the vehicle itself. GCWR describes the maximum load that the vehicle can haul, including the weight of a loaded trailer and the vehicle itself. For more information, please refer to the Medium and Heavy-duty GHG Phase 2 FRM (81 FR 73478 2016).



**Figure 1-7. GCWR-Torque Relationship, MY 2019 Light Truck Data.**

As seen in the fleet data, vehicle models which are offered at a higher tow rating than the base model will be equipped with a more powerful engine (and accompanying transmission, driveline, and chassis improvements). From a modeling perspective EPA focused on the increase in engine torque based on the relationship observed above.

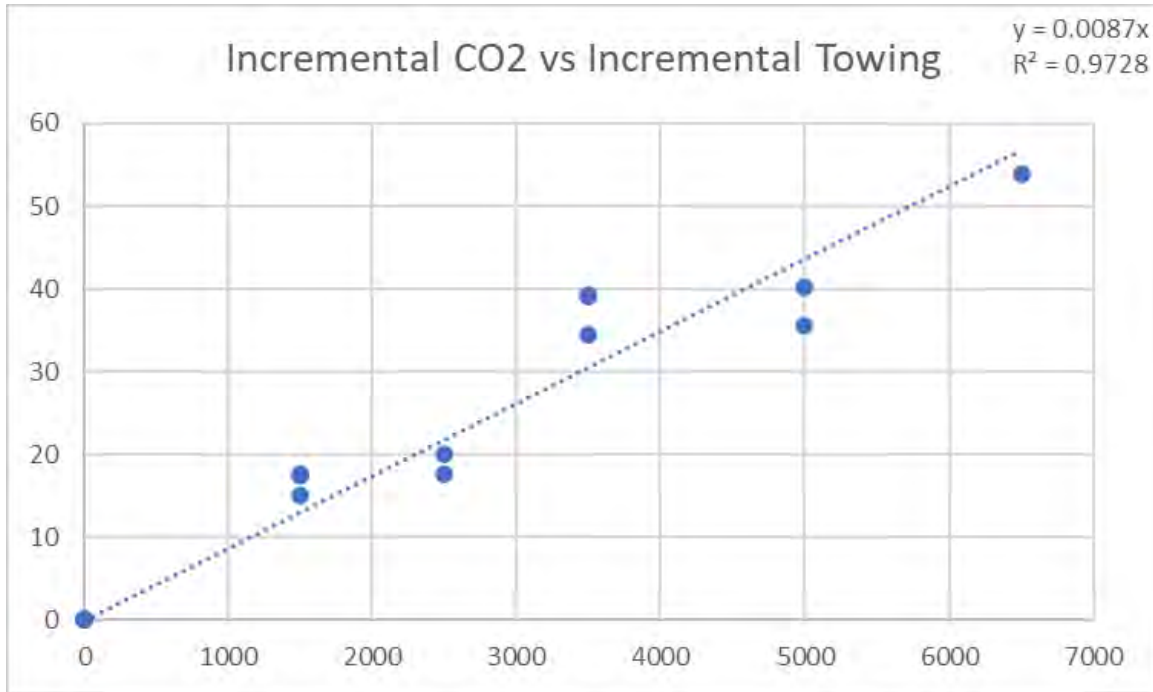
EPA then evaluated the increase in tailpipe CO<sub>2</sub> for additional towing capacity using response surface equations (RSEs) from ALPHA model results as follows:

- First, we estimated the required nominal engine torque for three vehicle models with different body styles (small pickup, SUV, and full-size pickup) at various tow rating levels by calculating the GCWR and applying the relationship seen in Figure 1-7.
- Then we scaled each engine model to an appropriate displacement (to match required torque) for various modeled engine architectures<sup>9</sup> based on each modeled engine's BMEP. Test weight (curb + 300 pounds) was increased slightly to account for heavier powertrain, driveline, suspension, and brakes that are required for greater towing capacity. Road loads were modified slightly based on this increased weight. We were then able to predict CO<sub>2</sub> based on the RSE results for a downsized turbocharged engine and various gasoline GDI engine models.

---

<sup>9</sup> ALPHA modeled engines include GDI with and without cylinder deactivation and Turbo Gas for pickups, and GDI and Atkinson for CUVs.

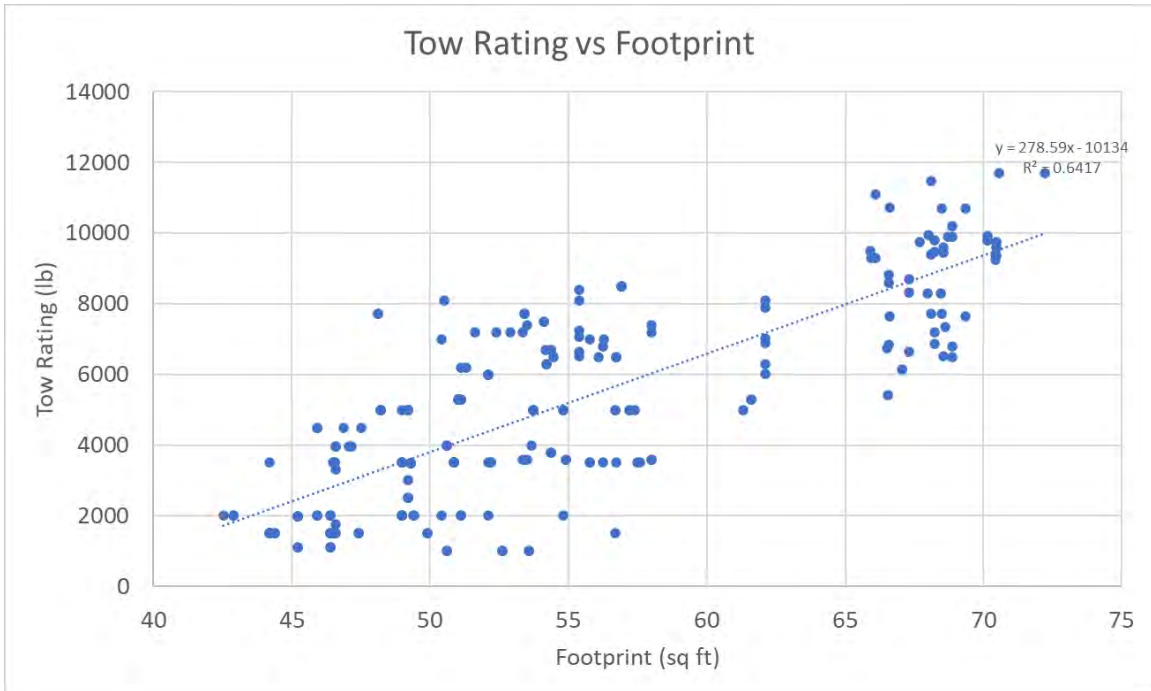
- The modeling results show the increase in CO<sub>2</sub> as a function of an increase in towing capacity in Figure 1-8. The data suggests that the average increase in CO<sub>2</sub> for a given vehicle is about 9 g/mile per additional 1000 pounds of tow capability.



**Figure 1-8. Incremental CO<sub>2</sub> as a Function of Increased Towing Capacity.**

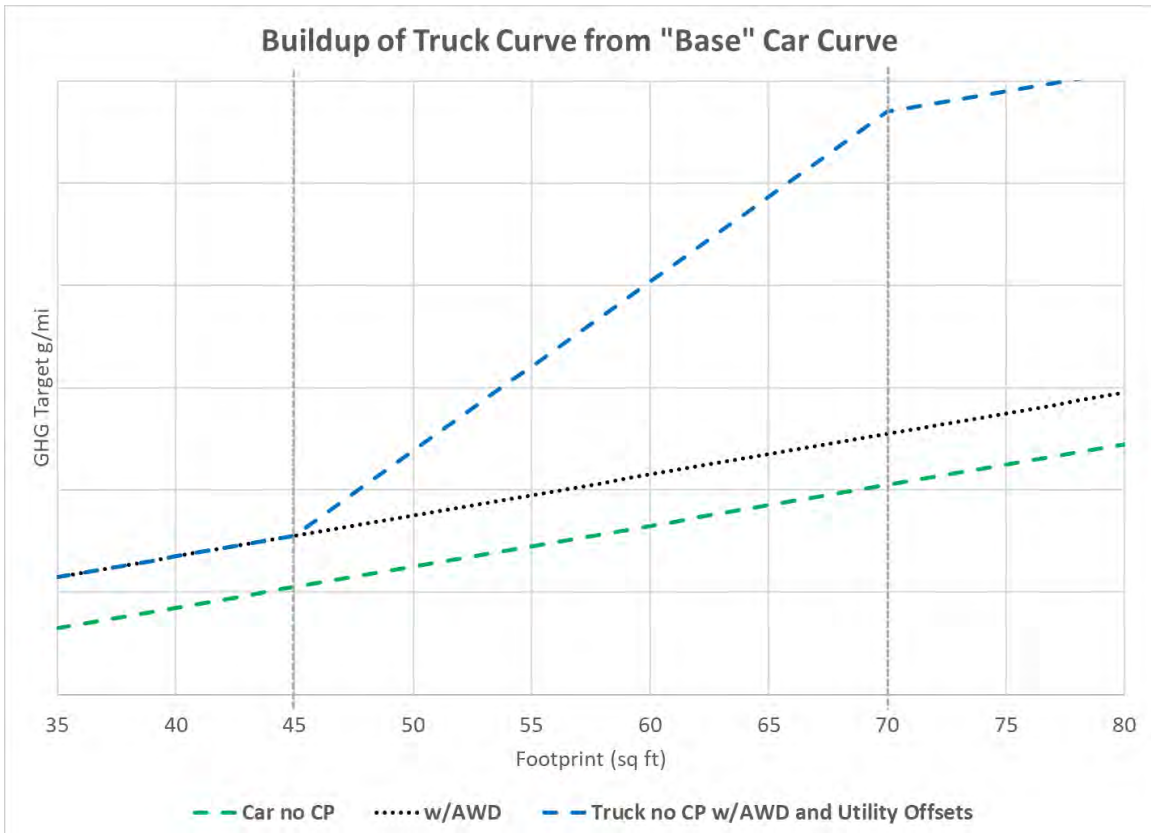
Finally, MY 2019 data shown in Figure 1-9 indicates that tow rating is directionally proportional with footprint (as longer wheelbases are required for stability during increased towing demands). The difference in towing capacity between a 70 square foot truck (at a sales-weight average tow rating slightly over 9000 pound) and that of a 45 square foot truck (with average tow rating just over 2000 pound) is 7000 pounds. Based on the relationship derived above for CO<sub>2</sub> vs. towing capacity, this would correspond to an additional 63 g/mile of tailpipe CO<sub>2</sub> between 45 and 70 square feet.<sup>10</sup> EPA combined these relationships to establish an appropriate footprint-based truck slope that is based on the additional utility that trucks are designed for. This represents the full utility-based offset of the truck curve for a 100 percent ICE vehicle fleet.

<sup>10</sup> EPA is not considering towing differences for trucks greater than 70 square feet or smaller than 45 square feet.



**Figure 1-9. Tow Rating-Footprint Relationship, MY 2019 Trucks.**

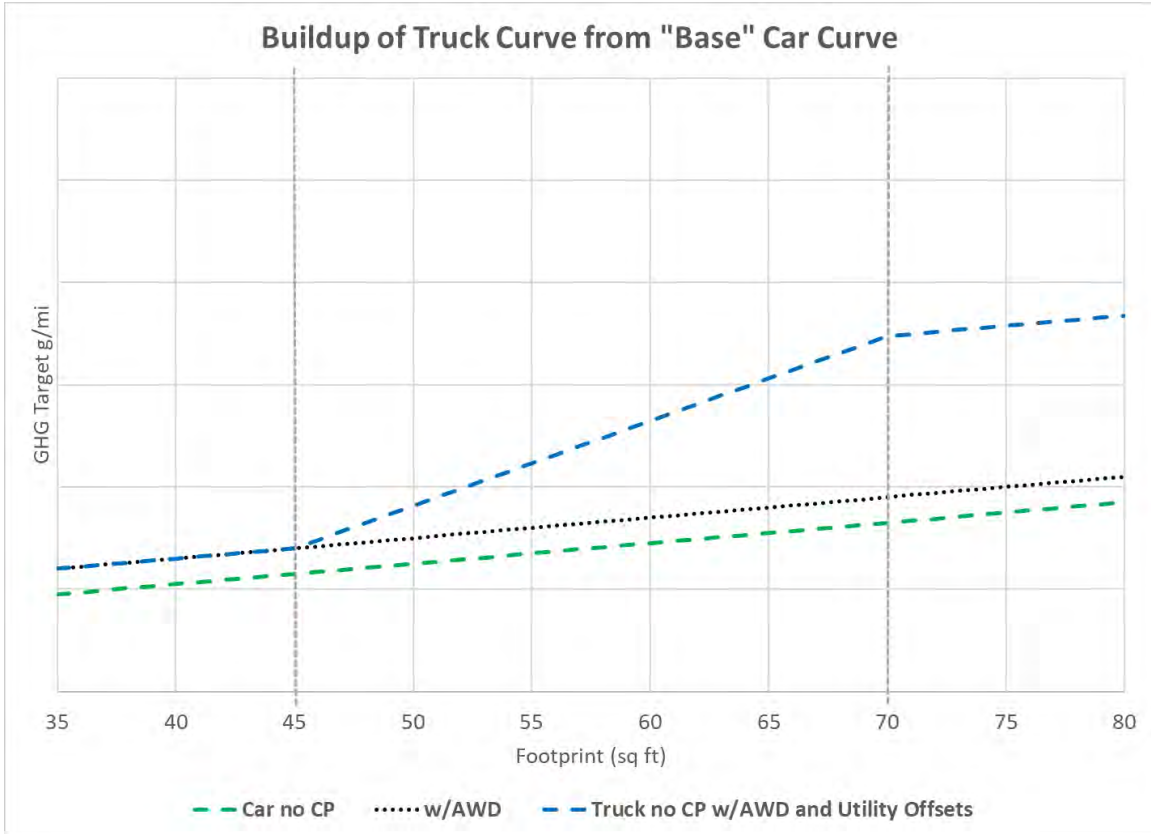
For a strictly ICE vehicle fleet, the AWD and utility offset would look as shown in Figure 1-10.



**Figure 1-10. AWD and Utility Offset Applied to Establish Truck Curve (100 percent ICE).<sup>11</sup>**

However, as described in Section III.C.2.ii of the preamble, we are scaling the car and truck curves as appropriate to reflect expected increases in technologies with increasingly lower tailpipe GHG emissions. For the 2030 fleet we are applying to these offsets a 50 percent factor (associated with an average tailpipe target that is nominally 50 percent of the base year target), as well as a 50 percent factor to the base car slope. We recognize that across our sensitivity analyses there is a wide range of technology penetrations, and believe this approach is appropriate to capture the range of low-GHG emitting technologies represented in our future projections. This reduces the AWD offset to 5 g/mile and the full-size truck utility offset to 31.5 g/mile as shown in Figure 1-11.

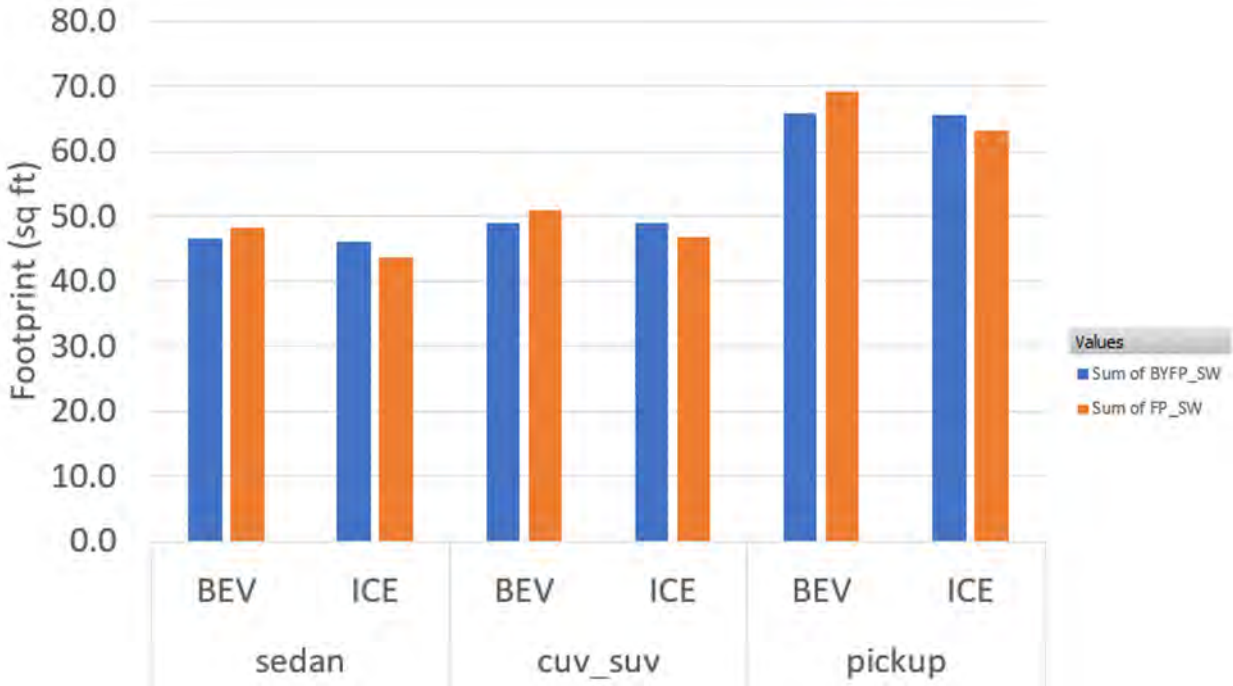
<sup>11</sup> For this figure and the subsequent figures, "no CP" indicates that no cutpoints were reflected in these plots.



**Figure 1-11. AWD and Utility Offset Applied to Establish Truck Curve (Scaled).**

### 1.1.3.3 Analysis of Footprint Response to Standards

To confirm that the slopes for car and truck curves would not incentivize a shift in vehicle size, we analyzed the projected trend in vehicle footprint for the standards to confirm a minimal overall change in vehicle size for the combined fleet. Figure 1-12 shows a comparison of 2020 base year footprint (blue) compared to the MY 2032 average projected footprint (orange) for the standards, for BEV and ICE vehicles, by body style. As can be seen, the BEVs increase slightly in size, while the ICE vehicles decrease slightly. These two tendencies offset each other to minimize the overall change in fleet size.



**Figure 1-12. Comparison of Average Footprint to Base Year Footprint for Final Standards**

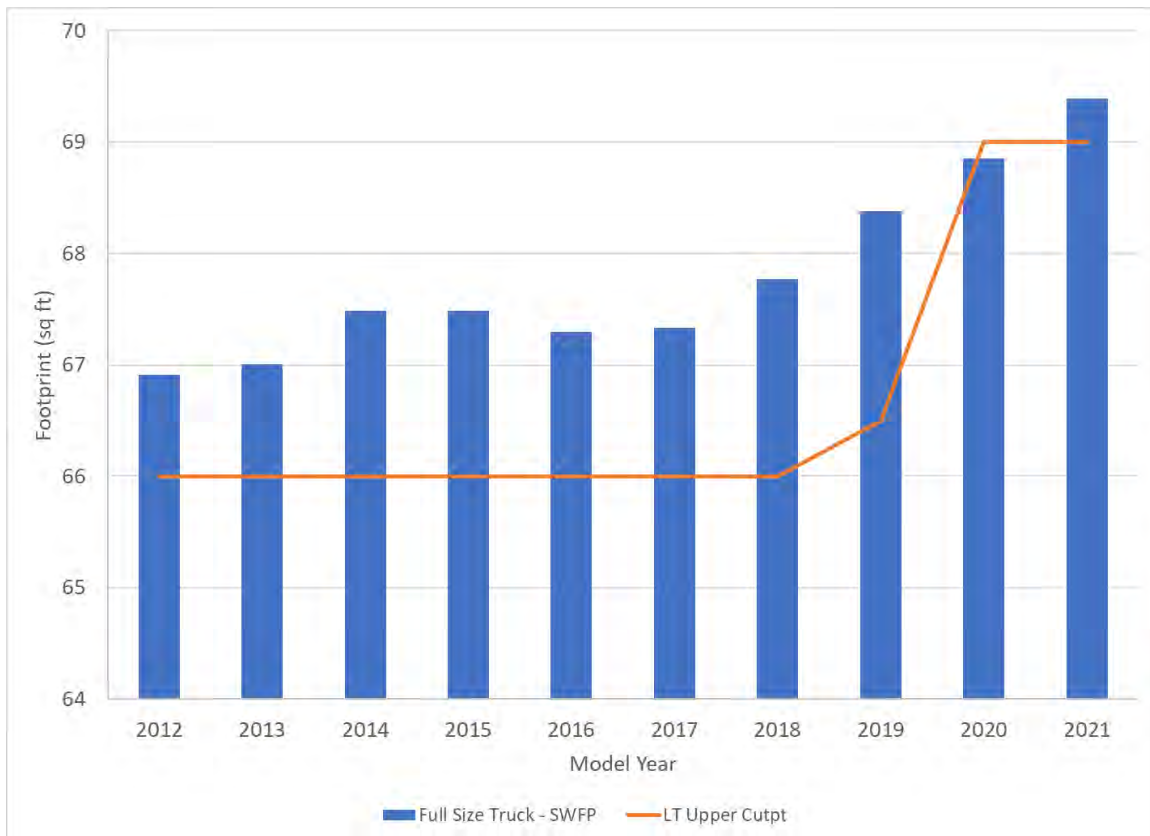
Table 1-2 shows the numerical MY 2032 average footprint (FP) for the various body styles for BEVs and ICE vehicles, and the fleet averages, compared to base year (MY 2020) footprint for the final standards. The overall change in average footprint (51.3 square feet) compared to the base year footprint (50.6) is minimal (an increase of 1 percent).

**Table 1-2: Comparison of MY 2032 Footprint to Base Year Footprint, Final Standards**

|              | BEV         |             | ICE         |             | Combined    |             |
|--------------|-------------|-------------|-------------|-------------|-------------|-------------|
|              | Base FP     | MY 2032 FP  | Base FP     | MY 2032 FP  | Base FP     | MY 2032 FP  |
| Sedan        | 46.5        | 48.1        | 46.0        | 43.7        | 46.4        | 47.1        |
| CUV/SUV      | 49.0        | 50.9        | 49.0        | 46.7        | 49.0        | 49.7        |
| Pickup       | 65.8        | 69.1        | 65.5        | 63.2        | 65.7        | 65.7        |
| <b>Total</b> | <b>49.7</b> | <b>51.7</b> | <b>52.7</b> | <b>50.3</b> | <b>50.6</b> | <b>51.3</b> |

### 1.1.3.4 Cut points

EPA evaluated the sales weight-average footprint for full size pickups in determining the appropriate upper truck cutpoint for this rule. Figure 1-13 shows that the average footprint has increased for full size pickups from 67 square feet to over 69 square feet in 2021. The upper cutpoint has increased from 66 square feet in MY 2018 to 69 square feet in 2021. To avoid any incentive to further upsize the full-size pickups, EPA is finalizing a provision that phases down the long-term upper truck cutpoint to 70 square feet.<sup>12</sup> The upper cutpoint for cars is unchanged at 56 square feet.



**Figure 1-13. Sales-weighted Footprint of Full-Size Pickups, 2012-2021 MY**

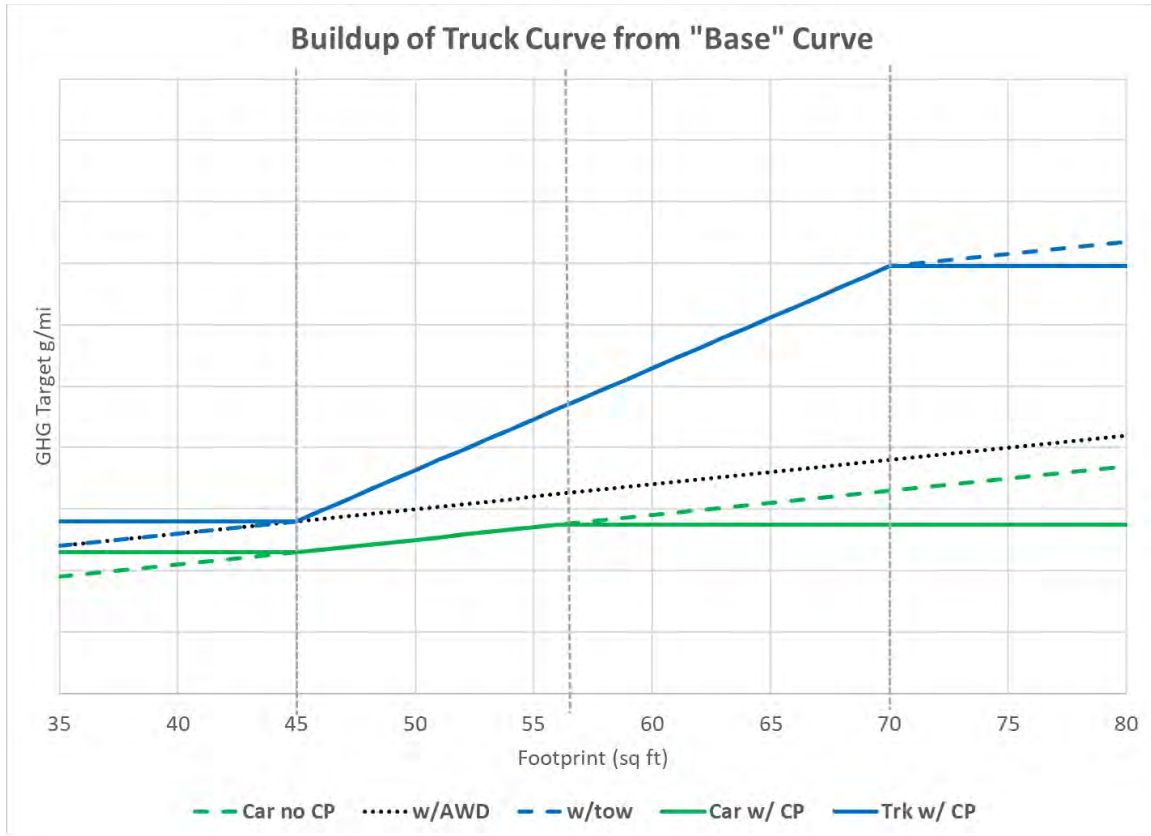
EPA is finalizing that vehicles smaller than 45 square feet should not be subject to more stringent standards based on an extrapolation of the utility offset approach described above. Many vehicle models smaller than 45 square feet, both cars and trucks, are offered and EPA does not want to discourage vehicles in this segment for equity and affordability concerns. These

<sup>12</sup> In the 2021 rule, for MYs 2023 and beyond the upper truck cutpoint was restored to the original 74 square foot value first finalized in 2012. EPA's final rule reduces the upper cutpoint beginning in MY 2027, with full phase down (from 74 in 2026) to 70 square feet by 2030.



include popular vehicles such as the Subaru Crosstrek, Nissan Kicks, the Chevy Trax, and the Honda HR-V.

Applying the cutpoints to the preceding methodology yields the final curve shape that is shown in Figure 1-14.



**Figure 1-14. Car and Truck Curves, Scaled, with Cutpoints**

## 1.2 Development of the final GHG standards for Medium-Duty Vehicles

### 1.2.1 History of GHG standards for Medium-Duty Vehicles

In the Phase 1 Heavy-duty rule, EPA established a GHG standards program structure for complete Class 2b and 3 heavy-duty vehicles (referred to in this rule as ‘medium-duty pickups and vans’) as part of a joint GHG and CAFE program with NHTSA (76 FR 57106 2011). The Phase 1 standards began to be phased-in for MY 2014 with the final Phase 1 stringency levels stabilizing in MY 2018. The Phase 1 program worked well to establish a first time GHG standards program for these work-oriented vehicles. The Phase 2 program established more stringent standards for MY 2027, phased in over MYs 2021–2027, requiring additional GHG reductions (81 FR 73478 2016). The MY 2027 standards would remain in place unless and until amended by the agency. Medium-duty vehicles (previously described as heavy-duty vehicles in the Phase 1 and Phase 2 HD GHG rules) with a gross vehicle weight rating (GVWR) between

8,501 and 10,000 pounds are classified in the industry as Class 2b motor vehicles while vehicles with GVWR between 10,001 and 14,000 pounds are classified as Class 3 motor vehicles.

Class 2b includes vehicles classified as medium-duty passenger vehicles (MDPVs) such as very large SUVs (40 CFR § 86.1803-01 2023). We are finalizing changes in the definition of MDPV in 40 CFR § 86.1803-01, as we described in Section III.E of the preamble. EPA performed a study to assess the GHG increases of a medium-duty pickup compared to a similar sized light-duty pickup when they are operated similarly as primarily unloaded vehicles transporting just the operator and also if they are lightly loaded with 1/2 the payload capacity. Results of this study are summarized in RIA Chapter 3.5. This comparison reflects the issue that medium-duty pickups have certain heavier duty design aspects (frames, axles, brakes, transmissions, etc.) intended for trailer towing work that negatively impact GHG emissions when they are only operated with lighter loads similar to the expected operation from a light-duty pickup.

Table 1-3 summarizes the chassis test data for the F150 and the F250, each tested in its original configuration and alternative configuration (as a 2b for the F150, and as a light-duty LDT4 for the F250). The F250 with the 7.3L engine, tested at a light-duty ETW of curb+300 pounds, emitted 172 g/mile more than the F150. Similarly, the F250 emitted 170 g/mile more than the F150 with both tested at ALVW.

**Table 1-3: GHG Emissions Comparison of LD and MD pickup**

| Test vehicle # | Model               | Test config | Targets |          |          |         |      |          |     |       |      |            |  | Notes |
|----------------|---------------------|-------------|---------|----------|----------|---------|------|----------|-----|-------|------|------------|--|-------|
|                |                     |             | A       | B        | C        | RLHP 50 | ETW  | Dyno cfg | FTP | HWF E | US06 | 55/45      |  |       |
| KFA20095       | 2019 F150           | LDT4 @ ETW  | 46.347  | 0.2527   | 0.03984  | 21.1    | 5142 | 4WD      | 476 | 322   | 515  | 407        | native config / 3 test avg.            |       |
|                | tested as 2b @ ALVW | 60.03       | 0.2527  | 0.03984  | 23.0     | 6698    | 4WD  | 529      | 359 | 591   | 452  | 3-test avg |  |       |
|                |                     |             |         |          | Delta    | 9%      | 30%  |          | 11% | 11%   | 15%  | 11%        |  |       |
| MDF250_RLD1    | tested as 2022 F250 | LDT4 @ ETW  | 48.87   | 0.12     | 0.050665 | 24.2    | 6896 | 4WD      | 682 | 454   | 707  | 579        | 3-test avg native config / 3 test avg. |       |
|                | 2b @ ALVW           | 59.33       | 0.12    | 0.050665 | 25.6     | 8373    | 4WD  | 736      | 483 | 808   | 622  |            |  |       |
|                |                     |             |         |          | Delta    | 6%      | 21%  |          | 8%  | 6%    | 14%  | 7%         |  |       |

The GHG emission difference observed in the data indicates that light- to medium-load operation results in much higher CO<sub>2</sub> emissions in the medium-duty pickup under similar passenger or payload conditions. The medium-duty pickup is designed primarily for regular towing and therefore may have higher emissions under other operating conditions compared to light-duty pickups designed more for transportation of passengers or cargo in the bed.

Because MDPVs are designed primarily to be used as light-duty passenger vehicles, they are regulated under the light-duty vehicle rules. Thus, the requirements for MDPVs in this rulemaking are the same as the light-duty pickups with respect to both GHG and criteria emission standards.

Historically, about 90 percent of medium-duty pickups and vans have been what are often referred to as "3/4-ton" and "1-ton" pickup trucks,<sup>13</sup> 12- and 15-passenger vans, and large work vans that are sold by vehicle manufacturers as complete vehicles, with no secondary manufacturer making substantial modifications prior to registration and use. Most of these vehicles are produced by companies with major light-duty markets in the United States, primarily Ford, General Motors, and Stellantis.<sup>14</sup> Often, the technologies available to reduce GHG emissions from this segment are similar to the technologies used for the same purpose on light-duty pickup trucks and vans, including both engine efficiency improvements (for gasoline and diesel engines) and vehicle efficiency improvements. In the Heavy-Duty Phase 1 (76 FR 57106 2011) and Phase 2 (81 FR 73478 2016) rules, EPA adopted GHG standards for medium-duty pickups and vans based on the whole vehicle (including the engine), expressed as grams of CO<sub>2</sub> per mile, consistent with the way these vehicles are regulated by EPA today for criteria pollutants.

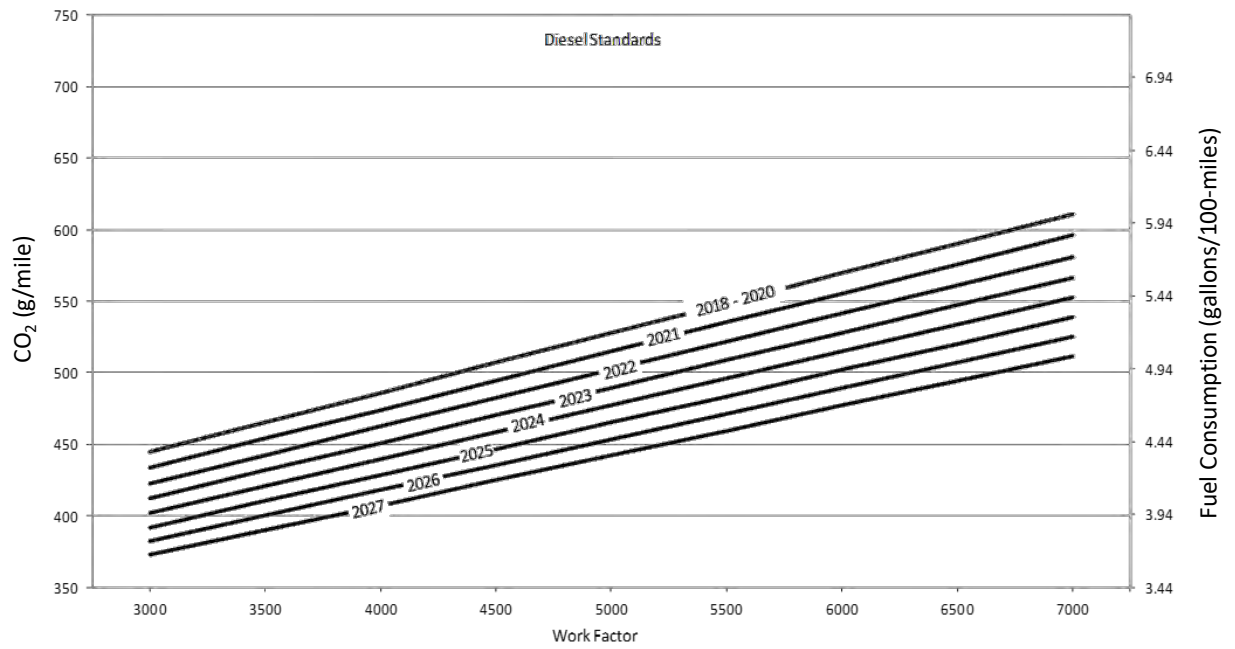
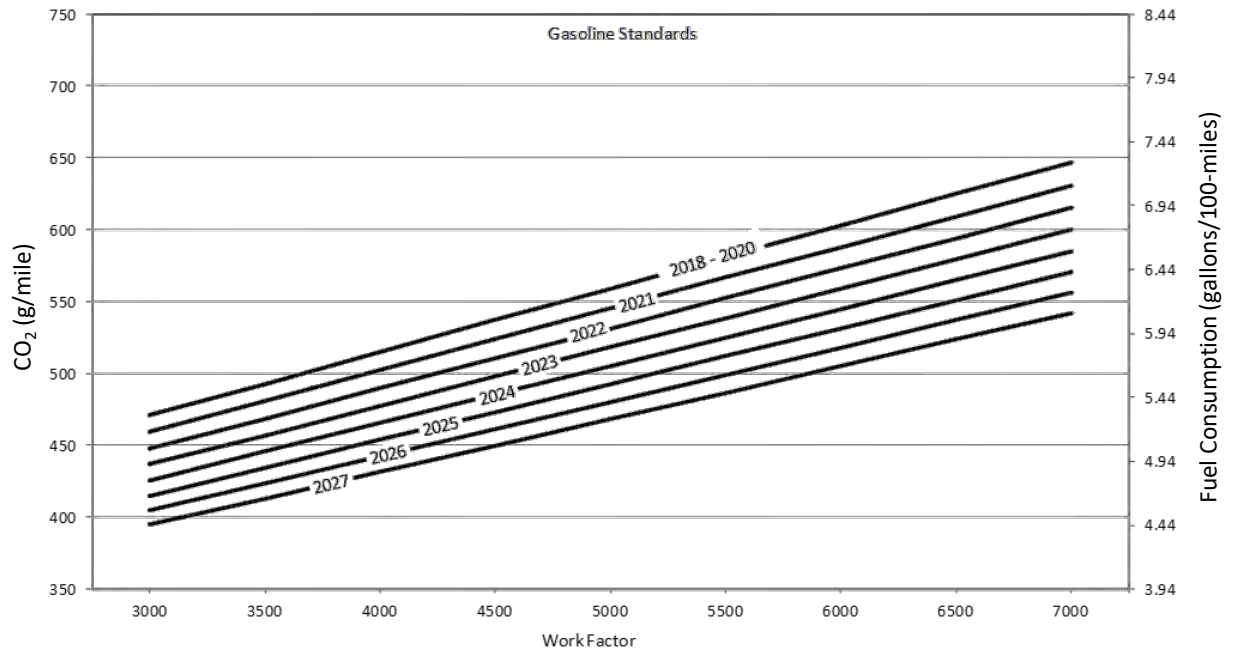
Vehicle testing for both the medium-duty and light-duty vehicle programs is conducted on chassis dynamometers using the drive cycles from the EPA Federal Test Procedure (Light-duty FTP or “city” test) and Highway Fuel Economy Test (HFET or “highway” test) (40 CFR § 1066.801 Subpart I 2023). For the light-duty GHG standards, EPA factored vehicle attributes into the standards by basing the GHG standards on vehicle footprint (the wheelbase times the average track width). For those standards, passenger cars and light trucks with larger footprints are assigned higher GHG targets (see Chapter 1.1.1.1). For HD pickups and vans, the agencies also set GHG standards based on vehicle attributes but used a work-based metric as the attribute rather than the footprint attribute utilized in the light-duty vehicle rulemaking. Work-based measures such as payload and towing capability are key among the parameters that characterize differences in the design of these vehicles, as well as differences in how the vehicles will be utilized. Buyers consider these utility-based attributes when purchasing a HD pickup or van. EPA therefore finalized Phase 1 and 2 standards for medium-duty pickups and vans based on a “work factor” attribute that combines the vehicle’s payload and towing capabilities, with an added adjustment for 4-wheel drive vehicles.

For Phase 1 and 2, the agencies adopted provisions such that each manufacturer’s fleet average standard is based on production volume-weighting of target standards for all vehicles that in turn are based on each vehicle’s work factor (76 FR 57106 2011) (81 FR 73478 2016). These target standards are taken from a set of curves (mathematical functions). The Phase 2 work factor GHG standards are shown in Figure 1-15 for reference. The agencies established separate standards for diesel and gasoline medium-duty pickups and vans. Note that this approach does not create an incentive to reduce the capabilities of these vehicles because less capable vehicles are required to have proportionally lower emissions and fuel consumption targets.

---

<sup>13</sup> "3/4-ton" and "1-ton" are common industry terms, not regulatory definitions. These terms typically refer to Class 2b and Class 3 trucks, respectively. For specific regulatory definitions for Class 2b and Class 3, please refer to 40 CFR § 86.1803-01.

<sup>14</sup> Formerly Fiat-Chrysler during the period when the Heavy-duty Phase 1 and 2 standards were developed.



**Figure 1-15: Heavy-duty Phase 2 work factor-based GHG standards for medium-duty pickups and vans (81 FR 73478 2016).**

### **1.2.2 Development of the final standards for Medium-Duty Vehicles**

Medium-duty-vehicles (MDV)<sup>15</sup> are similar to the light-duty trucks addressed in this program with respect to both technological opportunity for electrification as well as in terms of how they are manufactured. Several light-duty manufacturers are also the primary manufacturers of the majority of medium-duty pickups and vans. Medium-duty pickups and vans share close parallels to the light-duty program regarding how EPA has developed our medium-duty standards and compliance structures with the penetration of technologies such as electrification. The primary difference between the light-duty and the MDV standards is that MDV standards continue to be based on work attributes rather than vehicle footprint. MDV pickups and vans are true work vehicles that are designed for much higher towing and payload capabilities than are light-duty vehicles. The technologies applied to light-duty vehicles are not all applicable to MDVs at the same adoption rates, and the internal combustion engine technologies often produce a lower percent reduction in CO<sub>2</sub> emissions when used in many medium-duty vehicles. For example, electrification of an MDV pick-up designed and used solely for high towing capacity may be more challenging in the earlier years of the program. Conversely, delivery vans or payload-oriented pick-ups that operate over limited distances and daily routes present a significant opportunity for electrification, as evidenced by current last mile delivery companies' announcements and purchase orders for EVs in this segment. Due to this expected usage difference of MDVs, there are fewer parallels with the structure of the light-duty program. In addition, the phase-in provisions in the MDV program, although structurally different from those of the light-duty program due to CAA requirements, serve the same purpose, which is to allow manufacturers to achieve large reductions in emissions while providing a broad mix of products to their customers.

The form and stringency of the original Phase 1 and 2 standards curves were based on the performance of a set of vehicle, engine, and transmission technologies expected (although not required) to be used to meet the GHG emissions standards with full consideration of how these technologies were likely to perform in medium-duty vehicle specific testing and use. The technologies included:

- Advanced engine improvements for friction reduction and low friction lubricants
- Improved engine parasitics, including fuel pumps, oil pumps, and coolant pumps
- Valvetrain variable lift and timing
- Cylinder deactivation
- Direct gasoline injection
- Cooled exhaust gas recirculation
- Turbo downsizing of gasoline engines

---

<sup>15</sup> In our proposal we are defining a new MDV category that combines Class 2b and Class 3 and that excludes MDPV. For the full definition, please refer to Section III.A.1 of the Preamble to this rule.

- Diesel engine efficiency improvements
- Downsizing of diesel engines
- Electric power steering
- High efficiency transmission gear boxes and driveline
- Further improvements in accessory loads
- Additional improvements in aerodynamics and tire rolling resistance
- Low drag brakes
- Mass reduction
- Mild hybridization
- Strong hybridization
- Advanced 8 and higher speed automatic transmissions
- Diesel aftertreatment optimization
- BEV

Substantial opportunity still exists to further implement and make improvements to most of these technologies to achieve further reductions in GHG emissions beyond those achieved in the initial implementation of the Heavy-duty Phase 2 program as it applies to Class 2b and Class 3 vehicles (81 FR 73478 2016). Many of these technologies have not yet been implemented since the Phase 2 standards are still within a phase-in period continuing through MY 2027. The agency still expects to see additional penetration of many of these technologies.

The electrification of MDVs in the form of BEVs, particularly in delivery vans and some pick-ups, has the highest potential for GHG reductions of all technologies investigated by the agency. However, mild and strong hybridization and targeted PHEV implementation, particularly PHEV Class 2b pickup trucks, may also provide substantial GHG emission reductions as well as potential improvements in internal combustion engines, transmissions, and vehicle technologies.

### **1.2.2.1 Final MDV GHG Standards**

Our final GHG standards for all MDVs<sup>16</sup> are entirely chassis-dynamometer based and continue to be work-factor-based as with the previous heavy-duty Phase 2 standards. The standards also continue to use the same work factor (WF) and GHG target definitions (81 FR 73478 2016). The chassis dynamometer testing methodology for MDVs does not directly incorporate any GCWR related direct load or weight increases (e.g., trailer towing), however

---

<sup>16</sup> Pickup trucks, vans, incomplete vehicles, and other vehicles having GVWR between 8,501 and 14,000 pounds, excluding MDPVs. See section III.A.1 of the Preamble to this rule.

they would be reflected in the higher target standards when calculating the GHG targets using GCWR values above approximately 22,000 pounds, which approximately corresponds to work factors above 5,500 pounds. Without some limiting “cap” on GHG emissions, the resulting high target standards relative to actual measured performance would be unsupported within the test data used to demonstrate compliance and would generate windfall compliance credits for higher GCWR ratings. For the final rule, the GHG standards were thus flattened to a constant value for work factors above 5,500 pounds and for MY 2028 and later MDV. For further discussion of the rationale behind the final MDV GHG standards, please refer to Section III.C.3 of the Preamble for this final rule. The equations for MDV compliance with the final GHG standards are:

$$\text{CO}_{2e} \text{ Target (g/mi)} = [a \times \text{WF}] + b$$

$$\text{WF} = \text{Work Factor} = [0.75 \times [\text{Payload Capacity} + \text{xwd}] + [0.25 \times \text{Towing Capacity}]$$

$$\text{Payload Capacity} = \text{GVWR (pounds)} - \text{Curb Weight (pounds)}$$

$$\text{xwd} = 500 \text{ pounds if equipped with 4-wheel-drive, otherwise } 0 \text{ pounds}$$

$$\text{Towing Capacity} = \text{GCWR (pounds)} - \text{GVWR (pounds)};$$

and with coefficients:

**Table 1-4: Final coefficients for MDV GHG standards for WF ≤ 5,500 pounds**

| Model Year | a      | b   |
|------------|--------|-----|
| 2027       | 0.0348 | 268 |
| 2028       | 0.0339 | 270 |
| 2029       | 0.0310 | 246 |
| 2030       | 0.0280 | 220 |
| 2031       | 0.0251 | 195 |
| 2032       | 0.0221 | 170 |

**Table 1-5: Final coefficients for MDV GHG standards for WF > 5,500 pounds**

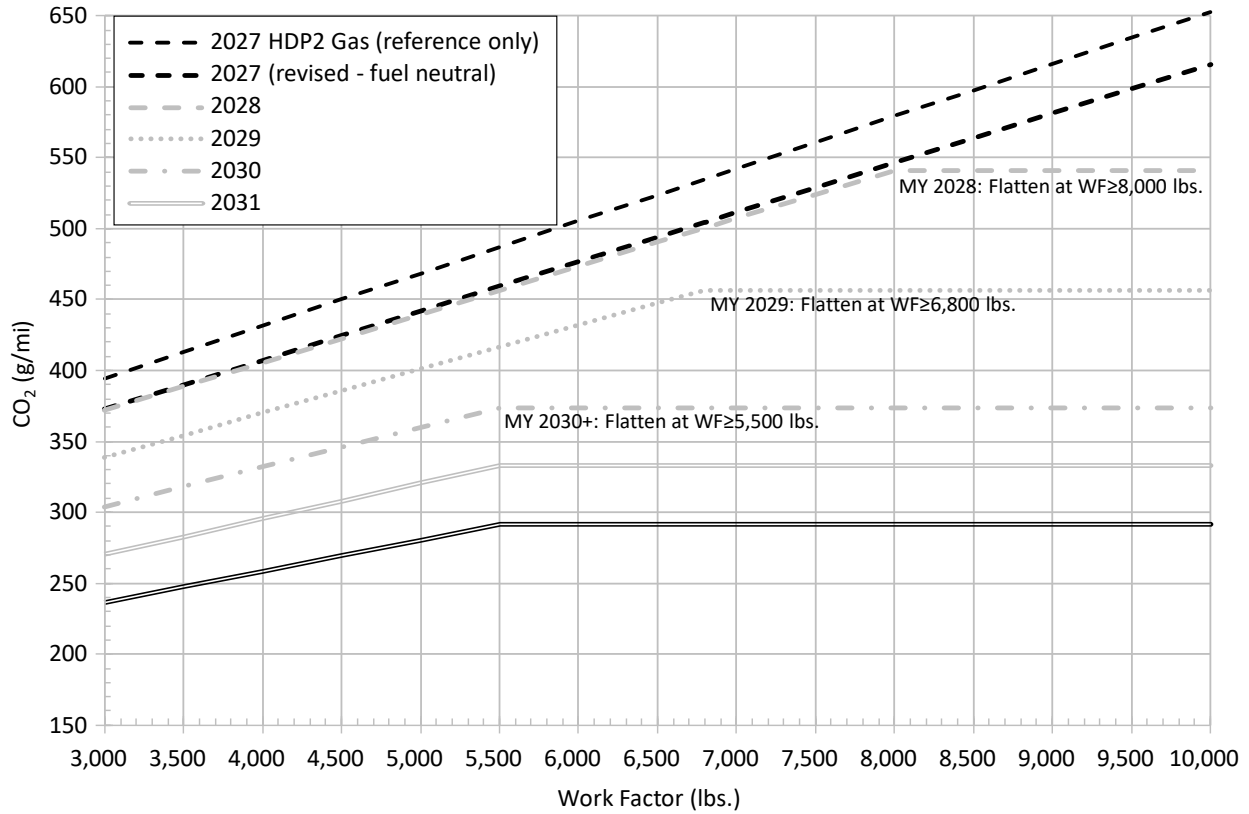
| Model Year | a      | b   |
|------------|--------|-----|
| 2027       | 0.0348 | 268 |
| 2028       | 0      | 456 |
| 2029       | 0      | 417 |
| 2030       | 0      | 374 |
| 2031       | 0      | 333 |
| 2032       | 0      | 292 |

The feasibility of the MYs 2027 - 2032 GHG standards is based primarily upon an assessment of the potential for a steady increase in MDV electrification, primarily within the van segment. Relative to all of MDV, OMEGA compliance results had approximately 20 percent of MDV sales as BEV in 2030, approximately 25 percent in 2031, and approximately 37 percent in 2032.

The feasibility of the initial year of compliance (2027) is from continued introduction of technologies phasing into use for compliance with HD GHG Phase 2 as described in RIA Chapter 1.2.2. Note that the fuel neutral standard in 2027 is a revision that would replace the last

year of phase-in into the HD Phase 2 GHG program and applies solely to MDVs within that program.

Beginning in MY 2027, the MDV GHG program moves gasoline, diesel, and PEV MDVs to fuel-neutral standards, i.e., identical standards regardless of the fuel or energy source used. Beginning in MY 2028, the GHG standards flatten above a work factor of 5,500 pounds.



**Figure 1-16: Final MDV GHG target standards**

### 1.3 Development of the final battery durability standards

As described in sections III.G.2 and III.G.3 of the Preamble, EPA is establishing new battery durability and warranty standards for PEVs.

In developing the standards, EPA took into consideration the provisions established in United Nations Global Technical Regulation No. 22, as well as the California Air Resources Board battery durability and warranty requirements under the Advanced Clean Cars II program.

Although EPA's durability and warranty provisions are not identical to either program, we recognize the fact that automakers may be subject to GTR No. 22 in markets outside the U.S., and that many may also be subject to the durability and warranty requirements under the State of California ACC II program. In considering the design and feasibility of the standards, EPA has considered the specific features and purposes of both programs and has considered opportunities for harmonization.



The following discussion provides background on GTR No. 22, and on the California Air Resources Board ACC II durability and warranty requirements. For a complete discussion of the requirements and their relation to these other programs, please refer to Preamble III.G.2 and III.G.3.

### **1.3.1 United Nations Global Technical Regulation No. 22 on In-Vehicle Battery Durability**

For several years, EPA has worked closely with the United Nations Economic Commission for Europe (UNECE) Working Party on Pollution and Energy (GRPE) to develop a world harmonized Global Technical Regulation (GTR) for In-vehicle Battery Durability for Electrified Vehicles, or GTR No. 22 (UN ECE 2022). This GTR was created within a GRPE Informal Working Group (IWG) known as Electric Vehicles and the Environment (EVE).

The EPA battery durability program is described primarily in Section III.G.2 of the Preamble. The program largely adopts the general framework and requirements described in GTR No. 22, with minor adaptations to incorporate established EPA test procedures and to achieve specific program objectives. In addition to the published GTR, the EVE also produced a document which outlines the technical justification and the development process of the GTR requirements (UN ECE 2021).

In 2015 the UNECE began studying the need for a GTR governing battery durability in light-duty vehicles. In 2021 it finalized GTR No. 22, which provides a regulatory structure for contracting parties to set standards for battery durability in light-duty BEVs and PHEVs. The European Commission and other contracting parties are currently working to adopt this standard in their local regulatory structures. EPA representatives chaired the informal working group that developed this GTR and worked closely with global regulatory agencies and industry partners to complete its development in a form that could be adopted in various regions of the world, including potentially the United States.

GTR No. 22 establishes a framework for regulating battery durability of BEVs and PHEVs by establishing durability metrics, durability performance monitoring requirements, minimum performance requirements, and procedures for determining monitor accuracy and determining compliance. It does not include battery warranty requirements. To monitor durability performance, it requires that manufacturers implement two ways of monitoring battery state-of-health (SOH): State of Certified Energy (SOCE) and State of Certified Range (SOCR). SOCE (and potentially in the future, SOCR) is then used to determine compliance with a Minimum Performance Requirement (MPR) at two points during the vehicle's life, as described below. In the current version of the GTR, the monitor requirements apply to Category 1-1, 1-2, and Category 2 vehicles. The MPR applies only to Category 1-1 and Category 1-2 vehicles. The IWG chose not to set an MPR for Category 2 vehicles at this time, largely because the early stage of adoption of these vehicles meant that in-use data regarding battery performance of these vehicles was difficult to obtain, and because these vehicles are more likely to have auxiliary work-related features that use power from the battery for non-propulsion purposes, and the impact of these features on battery life was not currently well characterized. MPR requirements for category 2 vehicles were therefore reserved for possible inclusion in a future amendment to the GTR.

SOCE is an estimate of remaining usable battery energy (UBE) capacity at a point in the vehicle's life, expressed as a percentage of the original UBE capacity when the vehicle was new. In most jurisdictions, including the U.S. and those that have adopted the WLTP, original UBE is already measured as part of the vehicle certification or range labeling process when the vehicle is new. The GTR requires the SOCE monitor estimate of remaining UBE capacity to be readable by the customer and by regulatory authorities. The algorithm for estimating and updating SOCE during the lifetime of the vehicle is left to the manufacturer. The SOCE monitor value is required to be on average no more than 5 percent higher than the actual value that would be obtained if the true remaining UBE capacity were to instead be determined by the test procedure that was used at certification. Accuracy is determined by a test program in which a statistical test is applied to test results from a sample of test vehicles within a defined test group.

SOCR is an estimate of the total electric driving range that the vehicle battery remains capable of providing at a point in the vehicle's life, expressed as a percentage of the original electric driving range when the vehicle was new. As with UBE, electric driving range is already measured and collected under applicable regional certification or type approval procedures when the vehicle is new. The GTR requires SOCR to be readable by regulatory authorities but not necessarily by the consumer. The SOCR monitor is also subject to the requirements for determination and reporting of monitor accuracy but is not currently subject to the accuracy requirement.

The GTR establishes a Minimum Performance Requirement (MPR) that specifies a minimum percentage retention of SOCE and SOCR at two points in the vehicle's life. During the first phase of implementation of the GTR, only the SOCE MPR will be enforced, although SOCR will be collected for information purposes. As shown in Table 1-6, the MPRs established by GTR No. 22 require retention of at least 80 percent SOCE at 5 years or 100,000 km (about 62,000 mi), and 70 percent SOCE at 8 years or 160,000 km (about 100,000 miles).

**Table 1-6. Battery durability performance requirements of UN GTR No. 22**

| Percent retention | of        | at      | Mileage    | Percent of sample must pass |
|-------------------|-----------|---------|------------|-----------------------------|
| 80%               | SOH (UBE) | 5 years | 100,000 km | 90%                         |
| 70%               |           | 8 years | 160,000 km |                             |

In the GTR, compliance with the SOCE MPR is determined for the vehicles within a given durability test group by collecting a large sample of SOCE monitor values from in-use vehicles at appropriate points in their life. The test group is compliant if at least 90 percent of the vehicles monitored meet the applicable SOCE MPR.

This Section has outlined the provisions of GTR No. 22. For a description of the specifics of the EPA battery durability program and how they compare to the provisions of the GTR, please refer to Section III.G.2 of the Preamble and to the regulatory text.

**1.3.2 California Air Resources Board battery durability and warranty provisions under the ACC II program**

In 2022, the California Air Resources Board (CARB), as part of its Advanced Clean Cars II (ACC II) program, established battery durability and battery warranty requirements as part of a

suite of customer assurance provisions designed to ensure that zero-emission vehicles maintain similar standards for usability, useful life, and maintenance as conventional vehicles. The performance requirements under the initial proposed version of the CARB durability standard were significantly more stringent than those of UN GTR No. 22. After taking public comment and consulting with the Board, the performance requirements were modified to a level closer to that of GTR No. 22, while certain aspects of the program remain more stringent than those of the GTR.

In contrast to GTR No. 22, the CARB battery durability requirement applies to electric driving range instead of capacity, and phases in according to model year (MY). As shown in

Table 1-7, for MYs 2026 through 2029, a vehicle test group is compliant if at least 70 percent of the vehicles in the group maintain 70 percent of certified range after 10 years or 150,000 miles (240,000 km). For MYs 2030 and later, a test group is compliant if, on average, the vehicles in the group maintain 80 percent of certified range after 10 years or 150,000 miles (240,000 km). Details on monitor accuracy requirements, thresholds for determination of non-conformance, and specific data reporting requirements are outlined in the regulations (State of California 2022a), (State of California 2022b).

The CARB warranty requirement also phases in by model year, but instead of range it refers to a state of health as expressed by usable battery energy (UBE). As shown in Table 1-8, for MYs 2026 to 2030, the battery must maintain 70 percent state of health after 8 years or 100,000 miles (160,000 km). For MYs 2031 and later, it increases to 75 percent state of health. The warranty requirement applies to the first purchaser and each subsequent purchaser. The warranty requirements are further outlined in the regulation (Title 13, California Code of Regulations 2022).

**Table 1-7. CARB ACC II battery durability requirements**

| Model years | Percent retention | of    | at       | Mileage    | Percent of sample must pass |
|-------------|-------------------|-------|----------|------------|-----------------------------|
| 2026-2029   | 70%               | Range | 10 years | 150,000 mi | 70%                         |
| 2030+       | 80%               |       |          |            | On average                  |

**Table 1-8. CARB battery warranty requirements**

| Model years | Percent retention | of        | at      | Mileage    |
|-------------|-------------------|-----------|---------|------------|
| 2026-2030   | 70%               | SOH (UBE) | 8 years | 100,000 mi |
| 2031+       | 75%               |           |         |            |

As described in the Preamble Sections III.G.2 and III.G.3, EPA is establishing battery durability and warranty standards that differ to some degree from those of the CARB program, but we have taken California's approach into consideration because we recognize that a substantial number of vehicles sold in the United States will be subject to California's requirements. The battery warranty requirements are implemented under the existing regulatory structure that establishes a minimum warranty for major emission control components, and thus retains similarities to the requirements under that program. The durability requirements are less stringent than the CARB program and have a greater similarity to those of GTR No. 22. For a

complete discussion of the requirements and their relation to these other programs, please refer to Sections III.G.2 and III.G.3 of the preamble.

## Chapter 1 References

- 40 CFR § 1066.801 Subpart I. 2023. (March 6). <https://www.ecfr.gov/current/title-40/chapter-I/subchapter-U/part-1066/subpart-I>.
- 40 CFR § 86.1803-01. 2023.
- 49 CFR § 523.5. 2022. <https://www.ecfr.gov/current/title-49/subtitle-B/chapter-V/part-523/section-523.5>.
- 76 FR 57106. 2011. (September 15). <https://www.govinfo.gov/content/pkg/FR-2011-09-15/pdf/2011-20740.pdf>.
- 77 FR 62624. 2012.
- 81 FR 73478. 2016. (October 25). <https://www.govinfo.gov/content/pkg/FR-2016-10-25/pdf/2016-21203.pdf>.
- Ellies, B. 2023. "Docket CUV Compliance Data Memo (Docket EPA-HQ-OAR-2022-0829)."
- Greene, et al. 2018. "Consumer willingness to pay for vehicle attributes: What do we know?" Transportation Research Part A.
- Public Law 94-163. 1975. (December 22). Accessed 1 8, 2023. <https://www.govinfo.gov/content/pkg/STATUTE-89/pdf/STATUTE-89-Pg871.pdf>.
- State of California. 2022a. "California Code of Regulations, title 13, section 1962.4."
- . 2022b. "California Code of Regulations, title 13, section 1962.7."
- Title 13, California Code of Regulations. 2022. Section 1962.7
- U.S. EPA. 2011. "Draft Joint Technical Support Document: Proposed Rulemaking for 2017-2025 Light-Duty Vehicle Greenhouse Gas Emission Standards and Corporate Average Fuel Economy Standards."
- U.S. EPA. 2022. "The EPA Automotive Trends Report: Greenhouse Gas Emissions, Fuel Economy, and Technology since 1975."
- UN ECE. 2021. "Proposal for a technical report on the development of a new UN Global Technical Regulation on In-Vehicle Battery Durability for Electrified Vehicles." November. [https://unece.org/sites/default/files/2021-10/GRPE-84-02e\\_0.pdf](https://unece.org/sites/default/files/2021-10/GRPE-84-02e_0.pdf).
- . 2022. "United Nations Global Technical Regulation on In-vehicle Battery Durability for Electrified Vehicles." April. <https://unece.org/transport/documents/2022/04/standards/un-gtr-no22-vehicle-battery-durability-electrified-vehicles>.

## **Chapter 2: Tools and Inputs Used for Modeling Technologies and Adoption Towards Compliance**

This chapter summarizes the tools and inputs used for modeling technologies, adoption of technologies, and vehicle compliance with the final standards. This includes details regarding the OMEGA model, ALPHA vehicle simulation tools, and the Agency's approach to analyzing vehicle manufacturing costs, consumer demand, and vehicle operational costs. The chapter also includes a summary of modeling inputs that reflect an assessment of impacts due to the implementation of the Inflation Reduction Act of 2022. We also discuss the rigorous technical evaluations and peer-review processes that were used in developing the modeling tools and technology inputs that were used in developing the standards. We describe the peer-review process for the OMEGA and ALPHA models in Chapters 2.3 and 2.4.9 respectively. We also discuss our detailed technical evaluation for battery cost estimates done in collaboration with national experts at the Argonne National Laboratory in Chapter 2.5.2.1, and extensive cost tear-down studies commissioned with an automotive consulting firm to develop estimates for non-battery costs in Chapter 2.5.2.2.

Much of the material in this and other chapters of this RIA reflects EPA's long-standing expertise in the area of mobile source emissions and regulatory standards development. EPA's Office of Transportation and Air Quality (OTAQ) has more than fifty years of experience in developing standards to reduce air pollution and greenhouse gas emissions from mobile sources. This work has historically involved not only broad stakeholder engagement and foundational work in regulatory design but also the development of deep scientific and technical expertise in the engineering and science surrounding the measurement, modeling, and control of mobile source emissions. This has included the development of sophisticated modeling tools to assess mobile source-related air quality problems; establishing national and international standards to reduce emissions; implementing standards through certification processes and in-use monitoring strategies; developing fuel efficiency programs and technologies; and researching, evaluating, and developing advanced technologies and new strategies for controlling emissions. Staff have a variety of technical, legal, policy, and communications backgrounds to work effectively with diverse stakeholders throughout this process. This includes employing well over a hundred staff with undergraduate and graduate degrees in mechanical engineering, electrical engineering, automotive engineering, computer science and engineering, chemical engineering, material science, physics, chemistry, and other engineering, science, and related fields, including economics. OTAQ also staffs and operates the National Vehicle and Fuel Emissions Laboratory (NVFEL) in Ann Arbor, Michigan. For nearly 50 years, NVFEL has been a world-class, state-of-the-art testing facility that provides emission testing support for EPA programs related to light- and heavy-duty vehicles, heavy-duty engines, and nonroad engines, including testing of gasoline and diesel engines and vehicles, HEVs, PHEVs, BEVs, electric machines, and high-voltage batteries. EPA staff each year conduct hundreds of tests of vehicles and engines to measure emissions, fuel economy, and performance. EPA also represents the U.S. at the United Nations World Forum for the Harmonization of Vehicle Regulations, where EPA OTAQ employees have chaired several working groups that have developed Global Technical Regulations to establish international test procedures and emission standards for light-duty vehicles, motorcycles, heavy-duty engines and vehicles, and electric vehicles. EPA OTAQ staff also routinely work with major independent technical automotive laboratories and engineering contractors – the same firms that are utilized by many of the light-, medium- and heavy-duty

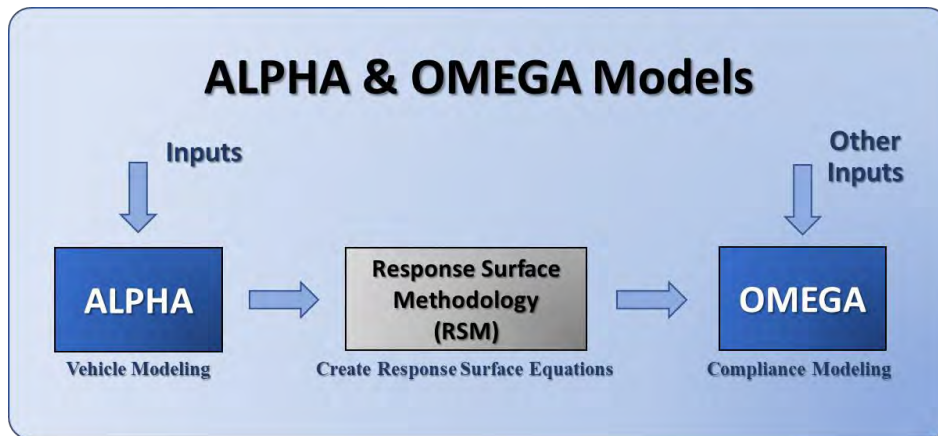
engine and vehicle manufacturers. These include multi-year contracts with Southwest Research Institute and FEV North America. EPA utilizes these contracts to expand its access to additional laboratory testing capabilities and expertise, including expertise in light-, medium- and heavy-duty vehicle technology assessments. OTAQ has established Cooperative Agreements with major transportation research universities, including the University of Michigan, the University of California – Davis, and Michigan State University. EPA OTAQ has utilized interagency agreements with several of the Department of Energy and the Department of Transportation National Laboratories to collaborate on transportation sources research investigations, and the National Vehicle and Fuel Emissions Laboratory has a long-standing, multi-decade Cooperative Research and Development Agreement with the major U.S. car manufacturers and the California Air Resources Board to “identify, encourage, evaluate and develop the instrumentation and techniques to accurately and efficiently measure emissions from motor vehicles.” EPA OTAQ staff have authored and co-authored hundreds of peer reviewed articles in the engineering, scientific, and economic literature, including publications by the Society of Automotive Engineers, the American Society of Mechanical Engineers, the Energy Policy Journal, the International Review of Environmental and Resource Economics, the World Electric Vehicle Journal, Transportation Research, the International Journal of Environmental Research and Public Health, and many others. EPA publications in the literature cover a wide range of topics, including the development of emission reduction technologies, new test vehicle and engine testing procedures, technology cost projections based on vehicle and sub-system tear-down assessments, vehicle and engine performance and emissions benchmarking, emission measurement programs, vehicle modeling techniques, vehicle fuel testing programs, and public health assessments of transportation emissions. EPA OTAQ employees have also frequently been asked to serve as peer reviewers for a number of these journals. EPA OTAQ employees working at the National Vehicle and Fuel Emissions Laboratory have also been granted over 100 U.S. patents covering a wide range of engine, and vehicle related technologies, including technologies for reducing criteria pollutant and GHG emissions, improving fuel efficiency, and technologies for the measurement of mobile source emissions.

## **2.1 Overview of EPA’s Compliance Modeling Approach**

EPA's technical analysis supporting emissions standards, at its highest level, is based on the following major tools that are used in the assessment of emissions reduction technologies and costs. These are, in order of execution: ALPHA, response surface modeling, and OMEGA. They are used in an integrated manner as follows:

- EPA's ALPHA model is a vehicle simulation tool used to predict tailpipe CO<sub>2</sub> emissions and energy consumption for advanced technologies. ALPHA is detailed in Chapter 2.4.
- Response surface methodology (RSM) incorporates ALPHA results for various vehicle technologies over thousands of vehicle combinations into response surface equations (RSE) which can be quickly referenced to characterize any future vehicle's GHG emissions based on its size, weight, power, and road loads. This approach is described in Chapter 2.4.10.

- EPA's manufacturer compliance model, OMEGA, incorporates RSEs, technology costs, and other inputs into its algorithms for finding cost-efficient pathways for manufacturers to achieve compliance with desired emissions standards. The compliance modeling produces a fleet of new light- and medium-duty vehicles for each analyzed model year, which OMEGA integrates into projections of the on-road vehicle stock and VMT. Finally, OMEGA tabulates the costs and benefits, emissions inventories, and physical effects that arise from the usage of vehicles over their lifetimes. A schematic of the overall analytical workflow is provided in Figure 2-1.



**Figure 2-1: Compliance modeling workflow.**

Finally, the results from OMEGA are used to inform its fleet onroad vehicle emissions model (MOVES) to generate fleet vehicle emissions and project benefits due to updated standards. A discussion of MOVES is provided in section 8.2.1.

### **2.1.1 OMEGA Compliance and Model Overview**

The OMEGA model has been developed by EPA to evaluate policies for reducing greenhouse gas (GHG) emissions from light-duty vehicles. Like the prior releases, this latest version is intended primarily to be used as a tool to support regulatory development by providing estimates of the effects of policy alternatives under consideration. These effects include the costs associated with emissions-reducing technologies and the monetized effects normally included in a societal benefit-cost analysis, as well as physical effects that include emissions quantities, fuel consumption, and vehicle stock and usage. In developing OMEGA version 2.0 (OMEGA2), the goal was to improve modularity, transparency, and flexibility so that stakeholders can more easily review the model, conduct independent analyses, and potentially adapt the model to meet their own needs.

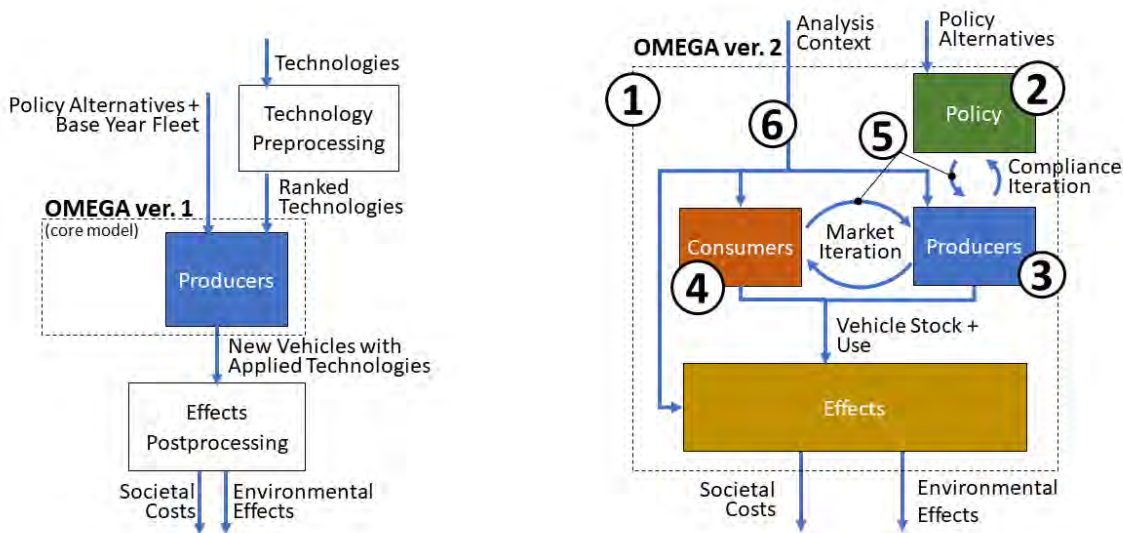
### **2.1.2 OMEGA Version 2.0**

EPA created OMEGA version 1.0 (OMEGA1) to analyze new GHG standards for light-duty vehicles proposed in 2011. The ‘core’ model performed the function of identifying manufacturers’ cost-minimizing compliance pathways to meet a footprint-based fleet emissions standard specified by the user. A preprocessing step involved ranking the technology packages to



be considered by the model based on cost-effectiveness. Postprocessing of outputs was performed separately using a spreadsheet tool, and later a scripted process which generated table summaries of modeled effects. An overview of OMEGA1 is shown on the left of Figure 2-2.

In the period since the release of OMEGA1, there have been significant changes in the light-duty vehicle market including technological advancements, a diversification of powertrain types across a wide range of vehicles, and the introduction of new mobility services. Advancements in battery electric vehicles (BEVs) with greater range, faster charging capability, and expanded model availability are particularly relevant when considering pathways for greater levels of emissions reduction in the future. OMEGA2 has been developed with these trends in mind. The model’s interaction between consumer and producer decisions allows a user to represent consumer responses to these new vehicles and services. The model also has been designed to have expanded capability to model a wider range of GHG program options, which is especially important for the assessment of policies that are designed to address future GHG reduction goals. In general, with the release of OMEGA2, the goal is to improve usability and flexibility while retaining the primary functions of OMEGA1. The right side of Figure 2-2 shows the overall model flow for OMEGA2 and highlights the main areas that have been revised and updated.



**Figure 2-2: Comparison of OMEGA1 and OMEGA2.**

The following updates constitute a summary of improvements in OMEGA2 from OMEGA1.

Update #1: Expanded model boundaries. In defining the scope of this model version, EPA has attempted to simplify the process of conducting a run by incorporating into the model some of the pre- and post-processing steps that had previously been performed manually. At the same time, EPA recognizes that an overly expansive model boundary can result in requirements for inputs that are difficult to specify. To avoid this, the input boundary has been set only so large as to capture the elements of the system it is assumed are responsive to policy. This approach helps to ensure that model inputs such as technology costs and emissions rates can be quantified using data for observable, real-world, characteristics and phenomena, and in that way enable transparency by allowing the user to maintain the connection to the underlying data. For the

assumptions and algorithms within the model boundary, the aim is transparency through well-organized model code and complete documentation.

Update #2: Independent Policy Module. OMEGA1 was designed to analyze a very specific GHG policy structure in which the vehicle attributes and regulatory classes used to determine emissions targets were incorporated into the code throughout the model. To make it easier to define and analyze other policy structures, the details regarding how GHG emissions targets are determined and how compliance credits are treated over time are now included in an independent Policy Module and associated policy inputs. This allows the user to incorporate new policy structures without requiring revisions to other code modules. Specifically, the producer decision module no longer contains any details specific to a GHG program structure, and instead functions only on very general program features such as fleet averaging of absolute GHG credits and required technology shares.

Update #3: Modeling of multi-year strategic producer decisions. As a policy analysis tool, OMEGA2 is intended to model the effect of policies that may extend well into the future, beyond the timeframe of individual product cycles. OMEGA2 is structured to consider producer decisions in a coherent manner across all the years in the analysis period. Year-by-year compliance decisions account for management of credits which can carry across years in the context of projections for technology cost and market conditions which change over time. The timeframe of a given analysis can be specified anywhere from near-term to long-term, with the length limited only by inputs and assumptions provided by the user.

Update #4: Addition of a consumer response component. The light-duty vehicle market has evolved significantly in the time since the initial release of OMEGA1. As the range of available technologies and services has grown wider, so has the range of possible responses to policy alternatives. The model structure for this version includes a Consumer Module that can be used to project how the light-duty vehicle market would respond to policy-driven changes in new vehicle prices, fuel operating costs, trip fees for ride hailing services, and other consumer-facing elements. The Consumer Module outputs the estimated consumer responses, such as overall vehicle sales and sales shares, as well as vehicle re-registration and use, which together determine the stock of new and used vehicles and the associated allocation of total VMT.

Update #5: Addition of feedback loops for producer decisions. OMEGA2 is structured around modeling the interactions between vehicle producers responding to a policy and consumers who own and use vehicles affected by the policy. These interactions are bi-directional, in that the producer's compliance planning and vehicle design decisions will both influence, and be influenced by, the sales and shares of vehicles demanded and the GHG credits assigned under the policy. Iterative feedback loops have now been incorporated between the Producer and Consumer modules to ensure that modeled vehicles would be accepted by the market at the quantities and prices offered by the producer, and between the Producer and Policy modules to account for the compliance implications of each successive vehicle design and production option considered by the producer. This update has been peer reviewed as detailed in Section 2.3.

Update #6: Use of absolute vehicle costs and emissions rates. OMEGA1 modeled the producer application of technologies to a fleet of vehicles that was otherwise held fixed across policy alternatives. With the addition of a consumer response component that models market share shifts, OMEGA2 utilizes absolute costs and emissions rates to compare vehicle design and purchase decisions across vehicle types and market classes.

The table below contains a list of OMEGA topics and the RIA chapters where those topics are discussed. This list is not comprehensive, though it may help understanding of the model, including its structure, inputs and outputs. For a qualitative discussion on analytical updates since the proposed rule that may have impacted OMEGA results, see Section IV.A.2 of the preamble.

**Table 2-1: OMEGA topics and their RIA Chapter locations**

| <b>Topic</b>  | <b>RIA Chapters</b>               |
|---|-----------------------------------|
| <b>Model structure/overview</b>                         |                                   |
| Model structure   | 2.2.1; 2.1.2; 2.2.2               |
| Inputs and outputs                                      | 2.1.1; 2.6                        |
| Module interactions                                     | 2.1.2; 2.2.2                      |
| Convergence   | 2.2.3                             |
|   |                                   |
| <b>Producer module</b>                                  |                                   |
| Overview  | 2.2.2                             |
| Cost methodology  | 2.5.1; 2.5.3; 2.6.1; 2.6.2; 2.6.4 |
| Absolute vs. incremental cost approach                  | 2.5.1                             |
| Learning-by-doing                                       | 2.5.3                             |
| Direct manufacturing costs                              | 2.5.2; 2.6.1; 2.6.2; 2.6.8        |
| Battery costs and battery sizing                        | 2.5.2.1                           |
| Indirect costs  | 2.5.4                             |
| Producer decisions                                      | 2.6.4                             |
|   |                                   |
| <b>Consumer Module</b>                                  |                                   |
| Overview  | 2.2.2                             |
| Purchase decision methodology                           | 2.6.3; 4.1                        |
| Generalized cost  | 2.6.4; 4.1.1; 4.2.2, Table 4-1    |
| Consumer purchase incentive                             | 2.6.8                             |
| Market shares, incl. shareweights                       | 4.1.2                             |
|   |                                   |
| <b>Policy Module</b>                                    |                                   |
| Overview  | 2.2.2                             |
|   |                                   |
| <b>Effects Module</b>                                   |                                   |
| Overview  | 8                                 |
| Physical effects  | 8                                 |
| VMT and rebound   | 4.2.1; 4.3.2; 8.3                 |
| Safety  | 8.4                               |
| Electricity and liquid fuel consumption                 | 4.3.3; 4.3.4; 8.5                 |
| Emissions   | 8.6                               |
| Energy security and oil imports                         | 8.7                               |
| New Vehicle Sales                                       | 4.4.1                             |
| VMT and rebound   | 4.2.1; 4.3.2                      |
| Costs   | 4.3                               |
| Technology costs  | 4.3.1                             |
| Insurance   | 4.3.6                             |
| Repair and maintenance                                  | 4.3.7                             |
| Noise and congestion                                    | 4.3.8                             |
|   |                                   |
| Social Benefits, Social Costs and Benefit-Cost Analysis | 9                                 |

## **2.2 OMEGA2 Model Structure and Operation**

### **2.2.1 Inputs and Outputs**

Like other models, OMEGA relies on the user to specify appropriate inputs and assumptions. Some of these may be provided by direct empirical observations, for example the number of currently registered vehicles. Others might be generated by modeling tools outside of OMEGA, such as physics-based vehicle simulation results produced by EPA's ALPHA model, or transportation demand forecasts from DOE's NEMS model. OMEGA has adopted data elements and structures that are generic, wherever possible, so that inputs can be provided from whichever sources the user deems most appropriate.

The inputs and assumptions are categorized according to whether they define the policies under consideration or define the context within which the analysis occurs. Policy alternative inputs describe the standards themselves, including the program elements and methodologies for determining compliance as would be defined for an EPA rule in the Federal Register and Code of Federal Regulations. Analysis context inputs and assumptions cover the range of factors that the user assumes are independent of the policy alternatives. The context inputs may include fuel costs, costs and emissions rates for a particular vehicle technology package, attributes of the existing vehicle stock, consumer demand parameters, existing GHG credit balances, producer decision parameters, and many more. The user may project changes in the context inputs over the analysis timeframe based on other sources, but for a given analysis year the context definition requires that these inputs are common across the policy alternatives being compared.

The primary outputs are the environmental effects, societal costs and benefits, and producer compliance status for a set of policy alternatives within a given analysis context. These outputs are expressed in absolute values, so that incremental effects, costs, and benefits can be evaluated by comparing two policy alternatives for a given analysis context. For example, comparing a No Action scenario to an Action (or Policy) Alternative. Those same policy alternatives can also be compared using other analysis context inputs to evaluate the sensitivity of results to uncertainty in particular assumptions. For example, comparing the incremental effects of a new policy in high fuel price and low fuel price analysis contexts.

### **2.2.2 Model Structure and Key Modules**

OMEGA2 has been set up so that primary components of the model are clearly delineated in such a way that changing one component of the model will not require code changes throughout the model. The four main modules — Producer, Consumer, Policy, and Effects — are each defined along the lines of their real-world analogs. Producers and consumers are represented as distinct decision-making agents, which each exist apart from the regulations defined in the Policy Module. Similarly, the effects, both environmental and societal, exist apart from producer and consumer decision-making agents and the policy. This structure allows a user to analyze policy alternatives with consistently defined producer and consumer behavior. It also provides users the option of interchanging any of OMEGA's default modules with their own, while preserving the consistency and functionality of the larger model.

**Producer Module:** This module generates potential decisions of the regulated entities (producers) in response to policy alternatives, while accounting for technology cost and availability, and constraints on vehicle production. The regulated entities can be specified as

individual companies, or considered in aggregate as a collection of companies, depending on the assumptions made by the user regarding how GHG credits are averaged or transferred between entities.

**Consumer Module:** This module projects a consumer response to the vehicle offerings generated by the producer module. The final projection is determined by iterating across multiple hypothetical vehicle offering scenarios, as described in Section 2.2.3. Under each scenario, the purchase decisions of consumers are modeled in response to vehicle price and consumers' preconceptions of their own driving behavior and likely fuel and operating costs, in combination with the consumer's consideration of other vehicle attributes and individual preferences.

**Policy Module:** This module determines the compliance status for a producer's possible fleet of new vehicles based on the characteristics of those vehicles and the policy defined by the user. Policies may be defined as performance-based standards using fleet averaging (for example, determining compliance status by the accounting of fungible GHG credits), as a fixed requirement without averaging (for example, a minimum required share of BEVs), or as a combination of performance-based standards and fixed requirements.

**Effects Module:** This module projects the physical and cost effects that result from the modeling of producers, consumers, and policy within a given analysis context. Examples of physical effects include the stock and use of registered vehicles, electricity, and gasoline consumption, and the GHG and criteria pollutant emissions from tailpipe and upstream sources. Examples of cost effects include vehicle production costs, ownership and operation costs, societal costs associated with GHG and criteria pollutants, and other societal costs associated with vehicle use.

### **2.2.3 Iteration and Convergence**

OMEGA2 is intended to find a solution which simultaneously satisfies producer, consumer, and policy requirements while minimizing the producer generalized costs. OMEGA2's Producer and Consumer modules represent distinct decision-making entities, with behaviors defined separately by the user. Without some type of interaction between these modules, the model would likely not arrive at an equilibrium of vehicles supplied and demanded. For example, a compliance solution which only minimizes producer generalized costs without consideration of consumer demand may not satisfy the market requirements at the fleet mix and level of sales preferred by the consumer. Similarly, the interaction between Producer and Policy modules ensures that with each subsequent iteration, the compliance status for the new vehicle fleet under consideration is correctly accounted for by the producer. Since there is no general analytical solution to this problem of alignment between producers, consumers, and policy which also allows model users to independently define producer and consumer behavior and the policy alternatives, OMEGA2 uses an iterative search approach (U.S. EPA 2024).

### **2.2.4 Analysis Resolution**

The policy response projections generated by OMEGA2 are centered around the modeled production, ownership, and use of light-duty vehicles. It would not be computationally feasible (nor would it be necessary) to distinguish between the approximately 15 million light-duty vehicles produced for sale each year in the US, and hundreds of millions of vehicles registered for use at any given time. Therefore, OMEGA is designed to operate using 'vehicles' which are

aggregate representations of individual vehicles, while still retaining sufficient detail for modeling producer and consumer decisions, and the policy response. The resolution of vehicles can be set for a given analysis and will depend on the user's consideration of factors such as the availability of detailed inputs, the requirements of the analysis, and the priority of reducing model run time.

### **2.3 OMEGA2 Peer Review**

The peer review was conducted during the development of OMEGA2 to facilitate implementation of peer review comments and suggestions into the completed version utilized in the Final Rule. This process was intended to gain additional insights for the updated structure, new modules, processing methods, and reporting methodology of OMEGA2.

#### **2.3.1 Charge Questions for the Peer Review:**

- The overall approach to the specified modeling purposes, the specific approaches chosen for modeling individual modules, and the methodologies chosen to achieve that purpose.
- The appropriateness and completeness of the contents of the input files.
- The types of information which can be input to the model point to both the flexibilities and constraints of the model.
- The accuracy and appropriateness of the model's conceptual algorithms and equations for technology application, market impacts, and calculation of compliance.
- The congruence between the conceptual methodologies and the program execution.
- Clarity, completeness, and accuracy of the model's visualization output, in which the technology application is displayed.
- Recommendations for any functionalities beyond what EPA has described as "future work."

#### **2.3.2 Information Received from Peer Review**

EPA's charge to the peer reviewers requested their expert opinions on the concepts and methodologies upon which the model relies and whether the OMEGA2 model correctly executes the associated algorithms. EPA's charge also asked the peer reviewers to comment on specific aspects of the model's design, execution, outputs, and documentation.

All peer reviewers commented favorably that they appreciated the increased capability and complexity of OMEGA2 over the previous OMEGA1 version as expressed in general comments:

- "A significantly enhanced EPA OMEGA2 over the earlier OMEGA1 version is an excellent and unique producer-consumer vehicle choice model by minimizing the resulting effects of societal costs and emissions subject to user-input emission policies. It is intended to find a solution which simultaneously satisfies producer, consumer,

and policy requirements while minimizing the producer generalized costs. The model and documentation available directly from Github provides the necessary detailed model scope description and modeling approach capabilities."

The peer reviewers provided numerous detailed comments and recommendations that indicated a thorough evaluation and good understanding of the model's design. The most common category of comments consisted of recommendations for improving the model's documentation by adding further explanations or specifics to enhance the user's understanding that were added in the final version of the model.

Another category of peer reviewer comments concerned the model's overall approach, including the functions of each module. Reviewers commented on specific details, recommended improvements, and noted inputs and results that would benefit from further explanation. Many peer reviewer recommendations for new or additional functionality focused on specific enhancements of the existing modules.

Certain topics were raised by multiple peer reviewers. For example, all peer reviewers commented on some aspect of the model's handling of greenhouse gas (GHG) emissions credits, especially as it relates to manufacturers banking these credits from one year to the next and, in some cases, how credit banking would interact with manufacturers' multi-year model development cycle. Reviewers also commented on the fact that the model does not currently include other aspects of firm profit-seeking compliance behavior, including changing vehicle attributes to shift regulatory classes. Peer reviewers also indicated that it was likely that wide-scale implementation of the technologies available in OMEGA2 could cause a significant change to overall fuel prices that should be considered. The peer reviewers also requested further explanation of how the OMEGA2 model processes hauling/non-hauling vehicles, all-wheel drive (AWD), and OMEGA2 model algorithm's treatment of iterative convergence on a final result.

As a result of the peer review, EPA implemented multiple model revisions and improvements, and expanded the OMEGA model's documentation and instructional materials. The peer review revisions were adopted for the model version used for the proposal, which was the basis for the version used for this final rulemaking. EPA's responses to individual peer review comments is provided in the full peer review report (U.S. EPA 2023). EPA has made improvements and updates to the OMEGA model compared to the version of the model reviewed by the peer reviewers (OMEGA version 2.0.0). Updates were made for the version used by EPA for the notice of proposed rulemaking (version 2.1.0), and further updates have been made since the proposal for this final rule in response to public comments (version 2.5.0). OMEGA is a state-of-the-art vehicle emissions compliance model, and has capabilities not available in any other vehicle emissions compliance model publicly available today. For example, OMEGA2 now incorporates certain consumer preferences via the new consumer module. The current OMEGA model reflects the agency's considered expertise in modeling the development and application of vehicle pollution control technologies over many decades, and EPA believes it is the best available model for modeling for this rulemaking. Over time, we recognize that what is considered state-of-the-art evolves - in response to new data, new modeling techniques, and the evolving scientific literature, and EPA anticipates future improvements to OMEGA, beyond the scope of the capabilities reflected in OMEGA 2.5.0, in response to future data, peer review, modeling techniques, and the literature.

## 2.4 ALPHA Full Vehicle Simulation and Response Surface Equations

ALPHA is a physics-based, forward-looking, full vehicle computer simulation capable of analyzing various vehicle types with different powertrain technologies, showing realistic vehicle behavior. The software tool is a MATLAB/Simulink based simulation.

ALPHA is capable of estimating CO<sub>2</sub> emission values for many different vehicle types and technology packages. OMEGA needs to quickly estimate the CO<sub>2</sub> emission values for each future vehicle considered along with estimates for future fleets. Because operating ALPHA in real time to conduct full vehicle simulations is time prohibitive, EPA developed a methodology of reproducing ALPHA model CO<sub>2</sub> values using an industry standard statistical technique known as response surface methodology (RSM). (Kleijnen 2015) This methodology is used to computationally access CO<sub>2</sub> results from a complete set of ALPHA model results by generating a collection of response surface equations (RSEs) that represent those simulation results. In 2018, EPA commissioned RTI International to conduct an independent peer review of an earlier version of the RSE methodology. (RTI International 2018)

ALPHA simulates a single combination of technologies (known as a technology package) across different combinations of vehicle parameters. Each set of ALPHA simulation outputs are processed to create the RSEs needed for each technology package addressed. These RSEs are subsequently used within OMEGA to quickly reproduce the ALPHA model estimates for CO<sub>2</sub> in real time for the various vehicle technologies. ALPHA's role in the creation of the RSEs for use within OMEGA is shown in Figure 2-3 and described in detail in Chapter 2.4.10.

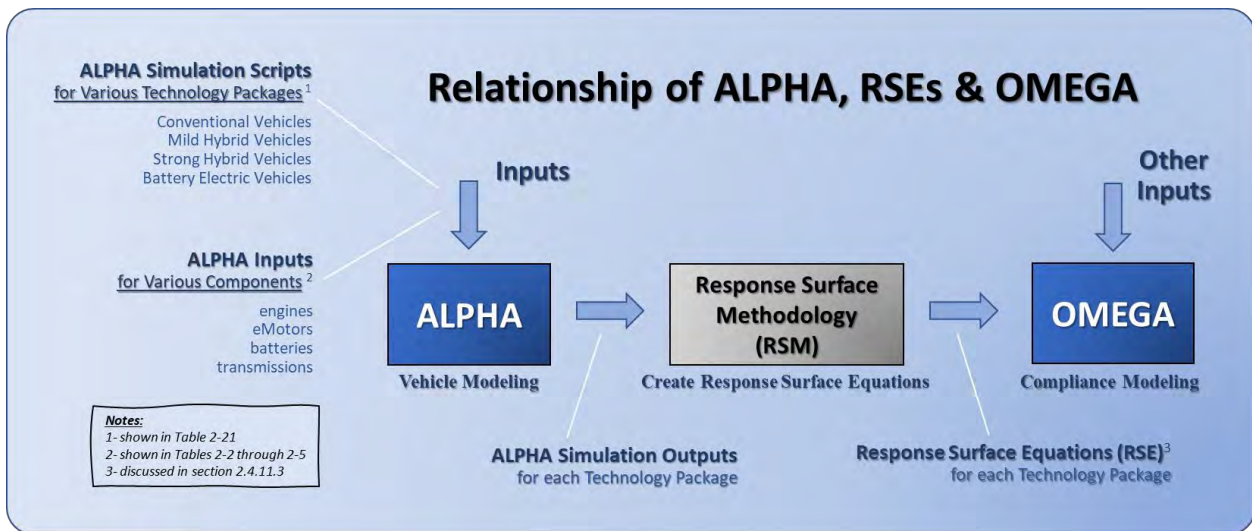


Figure 2-3: Relationship of ALPHA, RSEs and OMEGA.

### 2.4.1 General Description of ALPHA

Within ALPHA, an individual vehicle is defined by specifying the appropriate vehicle road loads (inertia weight and coast-down coefficients) and specifications of the powertrain



components. Powertrain components (e.g., engines, transmissions, e-motors) are individually parameterized and can be exchanged within the model draft.

Vehicle control strategies are also modeled, including engine accessory loading, deceleration fuel cut off (DFCO), hybrid behavior, torque converter lockup, and transmission shift strategy. Transmission shifting is parameterized and controlled by ALPHAshift, (Newman, Kargul and Barba 2015b) a shifting strategy algorithm that ensures an appropriate shifting strategy when engine size or vehicle loading changes. The control strategies used in ALPHA are modeled after strategies observed during actual vehicle testing.

The performance of vehicle packages defined within ALPHA can be modeled over any pre-determined vehicle drive cycle. To determine fuel consumption values used to calculate LD GHG rule CO<sub>2</sub> values, the FTP and HWFET cycles are simulated, separated by a HWFET prep cycle when required such as when simulating certification testing of start-stop vehicles and hybrids. ALPHA does not include a temperature model, so the FTP is simulated assuming warm component efficiencies for all test phases. Additional fuel consumption due to the FTP cold start is calculated in post-processing by applying a fuel consumption penalty to bags 1 and 2, depending on the assumed warmup strategy (refer to Section 5.3.3.2.5 of the *2016 Draft Technical Assessment Report* (U.S. EPA; U.S. DOT-NHTSA; CARB 2016)). In addition, other defined cycles can be used to simulate fuel economy in ALPHA. For example, the results from the US06, NEDC, and WLTP cycles (among others) are used to tune vehicle control strategy parameters to match simulation results to measured vehicle test results across a variety of conditions. In addition, performance cycles have been defined, which can be used to determine acceleration performance metrics.

#### **2.4.2 Overview of Previous Versions of ALPHA**

The Advanced Light-Duty Powertrain and Hybrid Analysis (ALPHA) tool was created by EPA to evaluate the Greenhouse Gas (GHG) emissions of Light-Duty (LD) vehicles. In addition, to provide additional flexibilities and transparency, EPA developed this in-house full vehicle simulation model that could freely be released to the public. Model development, along with the data collection and benchmarking that comes along with model calibration, is an extremely effective means of developing expertise and deeper understanding of technologies and their interactions. Better understanding of technologies contributes to a more robust regulatory analysis. Having a model available in-house allows EPA to make rapid modifications as new data is collected.

EPA began developing both light-and heavy-duty vehicle models simultaneously as these vehicles share many of the same basic components. The light-duty vehicle model (ALPHA), and the heavy-duty model (GEM), share much of the same basic underlying architecture.<sup>17</sup> ALPHA 2.1 and 2.2 were developed and used previously under *EPA's 2016 Draft Technical Assessment Report* (U.S. EPA; U.S. DOT-NHTSA; CARB 2016), the *2016 Proposed Determination* (U.S. EPA 2016a) (U.S. EPA 2016b), and the *2017 Final Determination* (U.S. EPA 2017a) (U.S. EPA 2017b).

---

<sup>17</sup> The GEM model has also been peer reviewed multiple times and was the subject of comment during the rulemaking adopting the second phase of GHG standards for heavy-duty vehicles and engines. See 81 FR 73530-531, 538-549.

As part of the Midterm Evaluation, EPA validated the ALPHA model using several sources including vehicle benchmarking, stakeholder data, and industry literature. To further enhance transparency, in May 2016, EPA completed an external peer review of ALPHA 2.0 (U.S. EPA 2023a). This peer review package included runnable MATLAB/Simulink source code along with the input data provided as part of the review.

### **2.4.3 Current version of ALPHA**

ALPHA 3.0 is the current version of the simulation tool used for this rule. The two primary changes in ALPHA 3.0 compared to the previous version of ALPHA (ALPHA 2.2) are the addition of electrified vehicle architectures (including hybrid, plug-in hybrid, and battery electric vehicles) and the addition of a robust structure to allow large numbers of simulations to characterize current and future fleets. A basic description of how ALPHA 3.0 works can be found online (U.S. EPA 2022c).

While ALPHA 3.0 continues to be refined and calibrated, the new electrified vehicle models of the version in use as of October 9, 2022, were externally peer-reviewed (U.S. EPA 2023a). The concepts and methodologies upon which the model relies were examined by peer reviewers to determine if these algorithms can deliver sufficiently accurate results. The results of the peer review are discussed in RIA Chapter 2.4.9.

Throughout this chapter, details are provided on the major technology assumptions built into ALPHA 3.0. EPA has also provided technical details in Chapter 3.5 which summarizes the ALPHA inputs used for this rule. In the time since ALPHA development began, EPA has published over twenty peer-reviewed papers describing ALPHA and the results of key testing, validation, and analyses (U.S. EPA 2023a) (U.S. EPA 2022b).

### **2.4.4 ALPHA Models for Conventional and Electrified Vehicle Architectures**

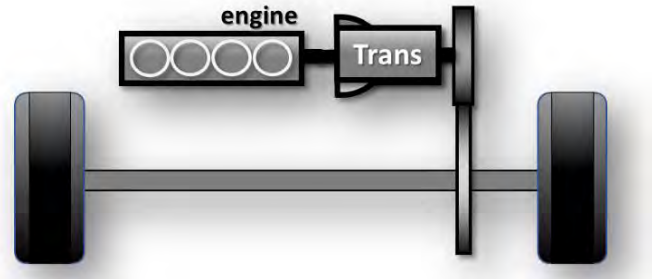
One of the most significant changes in ALPHA 3.0 is the addition of new electrified vehicle architecture models. Early in the development phase of ALPHA 3.0, EPA conducted research to determine which electrified vehicle architectures should be included in ALPHA's suite of models (Zhuanga, et al. 2020). Based on trends of the various hybrid and electric vehicles available for sale in the U.S. in recent years, the conclusion was the electrified vehicle market could be modeled in ALPHA 3.0 with the addition of five hybrid vehicle architectures and one battery electric vehicle architecture along with the base conventional vehicle architecture, all summarized in Figure 2-4.

|                          | Components  |        |                                       |                     | Architecture |
|--------------------------|-------------|--------|---------------------------------------|---------------------|--------------|
| Conventional Vehicle     |             | Engine |                                       | Trans               |              |
| P0 Mild Hybrid           | 48V Battery | Engine | electric starter generator            | Trans               |              |
| P2 Hybrid                | HV Battery  | Engine | electric starter generator (optional) | Trans               |              |
| P2-P4 Hybrid (REET)      | HV Battery  | Engine | e-motor / generator                   | Trans               |              |
| SP-P4 Hybrid (REET)      | HV Battery  | Engine | generator                             | e-motor / generator |              |
| PowerSplit Hybrid        | HV Battery  | Engine | e-motor / generator                   | planetary gear      |              |
| Battery Electric Vehicle | HV Battery  |        | e-motor / generator                   |                     |              |

Figure 2-4: Summary of components and architectures used in ALPHA’s modeling.

#### 2.4.4.1 Conventional Vehicle Architecture

The CO<sub>2</sub> performance for all conventional vehicles is modeled using the basic engine plus transmission architecture shown in Figure 2-5. Different types of engines and transmissions (including their many operational strategies such as cylinder deactivation, engine stop/start control, engine deceleration fuel cut off) can be scaled to suit the different vehicle models. For this rule, conventional vehicles are modeled using the same model described in Chapter 2.3.3.3 of the Proposed Determination on the Appropriateness of the Model Year 2022-2025 Light-Duty Vehicle Greenhouse Gas Emissions Standards under the Midterm Evaluation: Technical Support Document (U.S. EPA 2016b).



**Figure 2-5: Conventional vehicle architecture.**

#### **2.4.4.2 Hybrid Electric Vehicle (HEV) Architectures**

There are a wide variety of possible hybrid-electric vehicle architectures, many of which are or have been represented in the fleet. To assess the scope of this variety, EPA used a recent hybrid architecture survey paper (Zhuanga, et al. 2020). Although other researchers may use a different terminology for specific architectures, in the interest of consistency, EPA adopted the categorization and nomenclature used by the authors in this survey paper for further discussion of hybrid-electric vehicle architectures.

The CO<sub>2</sub> performance of hybrid vehicles in ALPHA is modeled using one mild and four strong hybrid architectures. The mild hybrid architecture chosen was a parallel P0 configuration (referred to later as "P0"). The four strong hybrid architectures chosen were a light-duty vehicle PowerSplit configuration patterned after the Toyota Prius (referred to later as "PS"), a light-duty vehicle/truck parallel P2 configuration (referred to later as "P2"), a light-duty towing vehicle series-parallel configuration (referred to later as "SP-P4"), and finally medium-duty towing vehicle parallel P2-P4 plug-in configuration (referred to later as "P2-P4 PHEV").

While other mild and strong hybrid architectures also exist in the fleet, EPA's analysis in RIA Chapters 2.4.8.5 and 2.4.8.6 shows that these hybrid variations can be adequately modeled using the one mild hybrid and four core strong hybrid architectures chosen for incorporation into ALPHA 3.0.

An analysis of the MY 2022 light-duty vehicle fleet revealed that 36 percent of all hybrid vehicles in the MY 2022 fleet were mild hybrids, and the remaining 64 percent were strong hybrids (Table 2-2). Of the strong hybrids, 60 percent were based on PowerSplit architecture, 27 percent were based on P2 hybrid technology, and the remaining 13 percent were based on architectures such as series-parallel and pure series architectures. The following will discuss the different hybrid models incorporated into ALPHA 3.0 to simulate these different types of hybrid vehicles.

**Table 2-2: Percentage breakdown of mild and strong hybrids in the MY 2022 light-duty vehicle fleet**

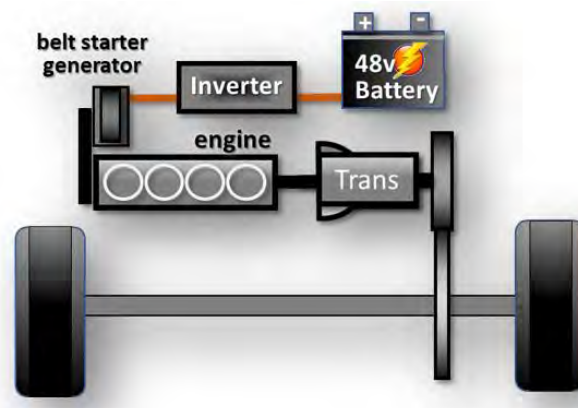
| ALPHA's Mild Hybrid Model | % of Mild Hybrids | % of all Hybrid Vehicles |
|---------------------------|-------------------|--------------------------|
| P0 Mild Hybrids           | 83.5%             | 30.1%                    |
| P1 Mild Hybrids           | 16.5%             | 5.9%                     |

| ALPHA's Strong Hybrid Model | % of Strong Hybrids | % of all Hybrid Vehicles |
|-----------------------------|---------------------|--------------------------|
| PowerSplit Strong Hybrids   | 59.9%               | 38.3%                    |
| PowerSplit PHEVs            |                     |                          |
| P2 Strong Hybrids           | 26.8%               | 17.1%                    |
| P2 PHEVs                    |                     |                          |
| Other Hybrids               | 13.3%               | 8.6%                     |
| Other PHEVs                 |                     |                          |

#### 2.4.4.2.1 Mild Hybrid Architectures

Mild hybrids are modeled within ALPHA using a 48V P0 architecture, which includes a conventional engine and transmission along with a starter/generator mounted on the front of the engine and connected through a belt and pulley, as shown in Figure 2-6. The battery energy capacity of a typical mid-sized mild hybrid vehicle is around 0.25 kWh. ALPHA is capable of simulating the operation of P0 mild hybrid technology and engine start-stop technology, each separately, or combined, depending upon the configuration of the vehicle being simulated. For the purposes of this rulemaking, P0 mild hybrids simulations combine both P0 mild hybrid and engine start-stop technologies.



**Figure 2-6: P0 Mild hybrid-electric vehicle architecture.**

Table 2-2 shows that 84 percent of the mild hybrids in the MY 2022 LD fleet are based on a P0 design. Stellantis /Ram and Volkswagen were the two biggest producers of P0 mild hybrid vehicles in the fleet. The other 16 percent of mild hybrids were based on a P1 design, where the

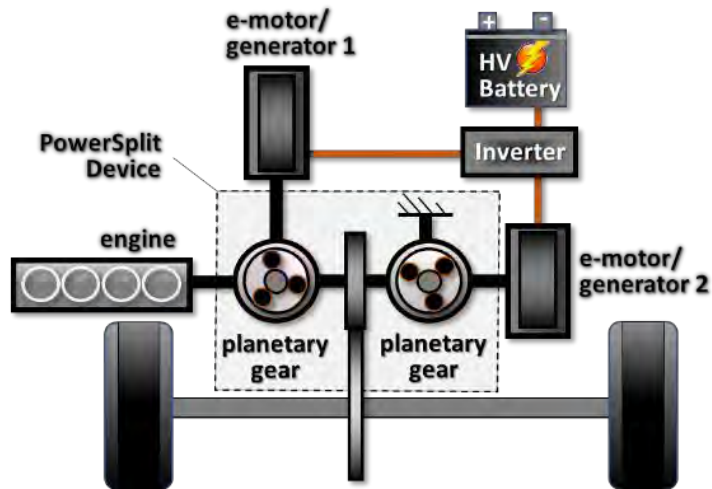
starter generator is directly mounted on the backside of the engine without the use of a belt. Mercedes was the only manufacturer of P1 mild hybrids in 2022.

Analysis of P0 and P1 hybrids in the MY 2022 fleet presented later in Chapter 2.4.8.5, indicates the P1 variant of mild hybrids, although more efficient than the P0 architecture, can be reasonably represented by ALPHA's P0 mild hybrid model. Consequently, the ALPHA P0 model was chosen to simulate all the mild hybrids associated with this rule.

#### **2.4.4.2.2 Strong Hybrid and PHEV Architectures**

ALPHA 3.0 uses four distinct models to simulate strong hybrid-electric vehicles (HEVs) and strong plug-in hybrid electric vehicles (PHEVs) in the U.S. vehicle fleet. Within each model, both HEV and PHEV simulations use the same base supervisory controllers to determine engine and electric motor operation. However, SOC ranges and load level SOC targets differ since the HEVs and PHEVs operate at different SOC levels.

**The PowerSplit strong HEV and PHEV architecture** is shown in Figure 2-7. This architecture includes a dedicated hybrid engine specifically designed to provide higher efficiency at the more stable engine loads possible with a PowerSplit powertrain. ALPHA 3.0 models the PowerSplit device using a planetary arrangement like that in the third-generation Prius, with the engine mated to the planetary carrier gear, the Motor/Generator 1 (MG1) connected to the sun gear, and the Motor/Generator 2 (and its associated planetary gear) connected to both the ring gear and drive axle (through the final drive gear). The PowerSplit device divides the torque between the engine, MG1, and the MG2/drive axle to provide the needed torque to the wheels while optimizing efficiency of the powertrain components. The battery for a typical mid-sized PowerSplit hybrid electric vehicle is around 1.5 kWh. The battery energy capacity of a similar sized plug-in hybrid (PHEV) version of PowerSplit hybrid is around 14 kWh. In ALPHA, the same base PowerSplit supervisory controller is used to simulate both HEVs and PHEVs, but with different SOC ranges and load level SOC targets. Table 2-2 illustrates that 60 percent of the strong hybrid vehicles in the MY 2022 fleet are the PowerSplit architecture (including both strong hybrids and PHEVs). The biggest producer of PowerSplit hybrids in MY 2022 by far (both by number of vehicle models and total sales) was Toyota. Ford, Stellantis, and Subaru also offered a plug-in version of the PowerSplit architecture on at least one vehicle model.



**Figure 2-7: PowerSplit strong HEV and PHEV (& planetary gear arrangement).**

The PowerSplit model also delivered suitable CO<sub>2</sub> predictions for other strong hybrid designs (e.g., series-parallel architecture), which represent 13 percent<sup>18</sup> of the remaining MY 2022 hybrid fleet. In total, ALPHA’s PowerSplit strong hybrid model was used to simulate 73 percent of the MY 2022 strong hybrid fleet.

**The P2 strong HEV and PHEV architecture** illustrated in Figure 2-8 is the second strong hybrid-electric model used within ALPHA. This hybrid architecture uses a conventional or a dedicated hybrid engine and a conventional 6 speed (or higher) automatic transmission with a clutch and electric motor/generator in place of the standard torque converter for a conventional vehicle. The P2 architecture has higher power and torque capability due to the full power engine and transmission and is suitable for truck and large SUV applications with towing capability. The battery energy capacity of a typical P2 strong hybrid vehicle is around 1.5 kWh (same as the PowerSplit strong hybrid). The battery capacity of a similar sized plug-in hybrid (PHEV) version of P2 hybrid is around 16 kWh. In ALPHA, the same base P2 supervisory controller is used to simulate both HEVs and PHEVs, but with different SOC ranges and load level SOC targets. Table 2-2 shows that 27 percent of the strong hybrids in the MY 2022 fleet are based on a P2 design (including both strong hybrids and PHEVs). Leading manufacturers of P2 hybrid and plug-in hybrid vehicles include Hyundai/Kia, BMW, Ford, and Porsche AG.

---

<sup>18</sup> Nearly all these remaining vehicles are based on a series-parallel hybrid design like the Honda Accord hybrid. While the CO<sub>2</sub> performance of a series-parallel hybrid can be estimated using a PowerSplit hybrid architecture, EPA developed a dedicated series-parallel model for characterizing future PHEVs using ALPHA.

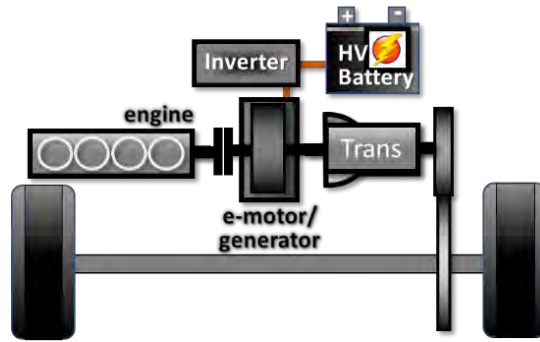


Figure 2-8: P2 strong HEV and PHEV architecture.

The SP-P4 strong HEV and PHEV architecture shown in Figure 2-9 was developed so ALPHA could simulate advanced hybrid vehicles in future light-duty fleets. The SP-P4 architecture was specifically developed for future LD truck and large SUV HEV and PHEV applications with towing capability. This model was not used to model any vehicles in the MY2022 base-year fleet. More information about this hybrid architecture can be found in EPA's report on the Range-Extended Electric Truck (REET) (Bhattacharjya, et al. 2023).

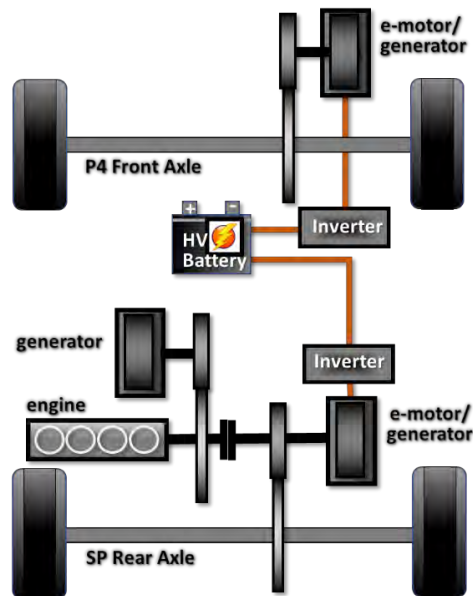


Figure 2-9: SP-P4 strong HEV and PHEV architecture from the REET report (Bhattacharjya, et al. 2023).

The P2-P4 PHEV architecture shown in Figure 2-10 was developed so ALPHA could simulate advanced PHEV vehicles in future medium-duty fleets. The P2-P4 PHEV architecture was specifically developed for future MD truck PHEV applications with towing capability. This model was not used to model any vehicles in the MD base-year fleet. More information about this hybrid architecture can be found in EPA's report on the Range-Extended Electric Truck (REET) (Bhattacharjya, et al. 2023).



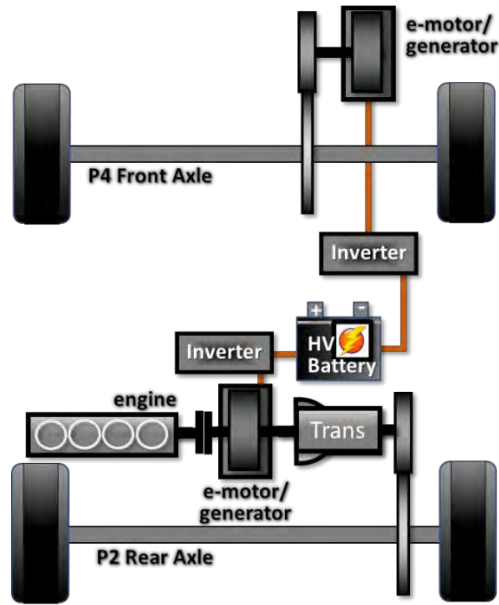


Figure 2-10: P2-P4 PHEV architecture from the REET report (Bhattacharjya, et al. 2023).

#### 2.4.4.3 Battery Electric Vehicle Architecture (BEV)

The energy consumption performance of battery electric vehicles (BEVs) is modeled using a battery and an electric drive unit (EDU) consisting of inverter, motor/generator, and gearing assembly as shown in

Figure 2-11. The battery energy capacity for a typical mid-sized vehicle with a 300-mile range is around 80-100 kWh.

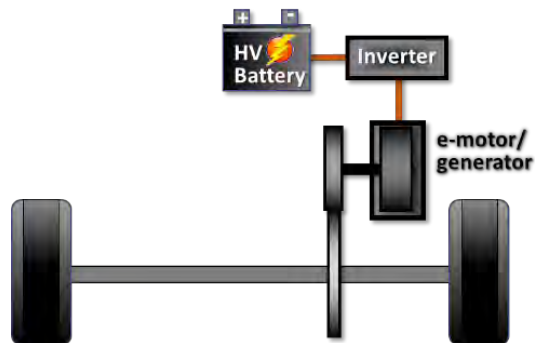


Figure 2-11: Battery electric vehicle architecture.

### **2.4.5 Engine, E-motor, Transmission, and Battery Components**

To assess advanced vehicle powertrain technologies for regulatory feasibility, the National Center for Advanced Technology (NCAT) within the National Vehicle and Fuels Emission Laboratory, benchmarks advanced vehicle powertrain technologies. Using their experience and expertise in laboratory benchmarking, EPA has been able to characterize engine and transmission controls, energy consumption, and emissions impacts of manufacturer powertrain technologies under operating conditions. These characterizations are then provided as inputs for complete vehicle simulations using its ALPHA model. EPA's engine, electric motor and transmission benchmarking methods have been peer reviewed during the publishing process for their publicly available SAE technical papers (U.S. EPA 2022b).

ALPHA stores engine, transmission, e-motor, and battery component data in ALPHA input files. The data included in each of the ALPHA inputs comes from various sources including EPA and other National Laboratory benchmark testing, GT-Power combustion modeling, contracted benchmark testing, and technical papers. Each input dataset receives extensive quality analysis from EPA's benchmarking and engineering team to identify and remove any errors, document primary sources of data, apply best practices when extrapolating to very low or high speeds/torques, and ensure consistency between similar ALPHA input files.

The rest of this chapter discusses the various ALPHA input files for the internal combustion engines, electric inverters/motors, batteries, and transmissions used for this rule. These ALPHA inputs are listed in Table 2-3 through Table 2-6 and described in detail in RIA Chapter 3.5 Light-Duty Engines. Table 2-3 identifies the internal combustion engines that ALPHA uses for this rule. The details of each engine ALPHA input listed are described in the RIA Chapter 3.5.1. Detailed information about the engines (engine efficiency map, inertia, DFCO, fuel penalties, cylinder deactivation features, fuel used, etc.) can be found in the data package associated with each engine (U.S. EPA 2022b) (U.S. EPA 2023c). The qualifiers in the Engine RSE Code column are defined as: SLA- Standard Load Application, HLA- High Load Application, MDV- medium-duty vehicle, ICE- non-hybridized internal combustion engine, P2- HEV with electric motor in the P2 position, PS- PowerSplit HEV, P2P4 - AWD P2 type PHEV, and SPP4 - AWD series-parallel PHEV.

**Table 2-3: Engine ALPHA input maps used to create ALPHA outputs for RSEs**

| Configuration                                | Engine RSE Code      | ALPHA Component Name  | Data Source   |
|--|----------------------|---|---|
| Port Fuel Injection<br>Large Bore            | PFI<br>(MDV or HLA)  | GT Power Baseline 2020 Ford 7.3L<br>Engine from Argonne Report Tier 3 Fuel                            | Technical Report<br>(Argonne/SwRI)                            |
| Gas Direct<br>Injection                      | GDI                  | 2013 Chevrolet 2.5L Ecotec LCV Engine<br>Reg E10 Fuel   | Contracted Testing<br>(FEV)                                   |
| Gas Direct<br>Injection                      | GDI<br>(HLA)         | 2014 Chevrolet 4.3L EcoTec3 LV3 Engine<br>LEVIII Fuel   | EPA-NCAT Testing  |
| Turbo Gas                                    | TDS11                | 2013 Ford 1.6L EcoBoost Engine LEV III<br>Fuel  | EPA-NCAT Testing  |
| Turbo Gas                                    | TDS<br>(HLA)         | 2015 Ford 2.7L EcoBoost Engine Tier 3<br>Fuel   | EPA-NCAT Testing  |
| Turbo Gas                                    | TDS<br>(SLA)         | 2016 Honda 1.5L L15B7 Engine Tier 3<br>Fuel   | EPA-NCAT Testing  |
| Turbo Gas Miller                             | MILLER (ICE)         | Volvo 2.0L VEP LP Gen3 Miller Engine<br>from 2020 Aachen Paper Octane Modified<br>for Tier 3 Fuel     | Technical Paper (2020<br>Aachen)                              |
| Turbo Gas Miller<br>Dedicated Hybrid         | MILLER<br>(P2 or PS) | Geely 1.5L Miller GHE from 2020 Aachen<br>Paper Octane Modified for Tier 3 Fuel                       | Technical Paper (2020<br>Aachen)                              |
| Atkinson                                     | ATK                  | 2018 Toyota 2.5L A25A-FKS Engine Tier<br>3 Fuel   | EPA-NCAT Testing  |
| Atkinson<br>Dedicated Hybrid                 | DHE<br>(P2 or PS)    | Toyota 2.5L TNGA Prototype Hybrid<br>Engine from 2017 Vienna Paper Octane<br>Modified for Tier 3 Fuel | Technical Paper (2017<br>Vienna)                              |
| Turbo Diesel                                 | DIESEL               | Duramax 3.0L  | Technical Report<br>(Argonne/SwRI)                            |
| High Load<br>Application<br>Dedicated Hybrid | MILLER<br>(SPP4)     | Future 3.6L HLA Hybrid Concept Engine<br>Tier 3 Fuel  | VW 1.5L TSI evo<br>Hybrid Concept 4 from<br>2019 Aachen Paper |
| High Load<br>Application<br>Dedicated Hybrid | MILLER<br>(P2P4)     | Future 6.0L HLA Hybrid Concept Engine<br>Tier 3 Fuel  | VW 1.5L TSI evo<br>Hybrid Concept 4 from<br>2019 Aachen Paper |

### 2.4.5.1 Electric Drive Components

Table 2-4 shows the three types of electric drive components that ALPHA uses for this rule.

- **BISG** - Belt Integrated Starter Generator consisting of an inverter, an electric motor, and the engine's front-end pulley/belt drive.
- **EDU** - Electric Drive Unit consisting of an inverter, an electric motor, and the drive gearing.
- **EMOT** - Electric Motor consisting of an inverter and an electric motor (the gear losses are accounted for elsewhere and not within this device).

The details of each electric motor ALPHA input listed are described in the RIA Chapter 3.5.2. Detailed information about the electric component (efficiency map, losses, gear ratios, etc.) can

be found in the data package associated with each component (U.S. EPA 2023a) (U.S. EPA 2023b).

**Table 2-4: Electric motor/related ALPHA input maps for electrified vehicles used to create ALPHA outputs for RSEs**

| Type | ALPHA Component Name  | Data Source  |
|------|---|--------------|
| EMOT | 2010 Toyota Prius 60kW 650V MG2 EMOT  | ORNL         |
| EMOT | Est 2010 Toyota Prius 60kW 650V MG1 EMOT  | ORNL / NCAT  |
| EMOT | 2011 Hyundai Sonata 30kW 270V EMOT  | ORNL         |
| BISG | 2012 Hyundai Sonata 8.5kW 270V BISG   | ORNL         |
| EDU  | Generic IPM 150kW EDU   | NCAT         |
| EMOT | 3 modern IPM electric motor/inverters used in future LD and MD PHEVs with towing capability | Confidential |

#### **2.4.5.2 Transmissions**

Table 2-5 identifies the automatic transmissions used for this rule. These transmission models are all traditional step automatic transmissions and are used to represent all drivetrains in conventional and electrified vehicles (except for PowerSplit vehicles and BEVs). Transmission losses as a function of load and gear number are built into the ALPHA input. The torque converter efficiency and lockup logic are also programmed into each ALPHA input. The shifting logic for each transmission is built into a function called ALPHA-shift. The TRX\_ECVT\_FWD transmission supplies the planetary gear ratios and the gear mesh efficiency for the PowerSplit drivetrain. EPA did not perform any additional transmission testing for this rulemaking.

For more information on most of these transmissions, please refer to the description of ALPHA in the *2016 Final Determination* (U.S. EPA 2017b).

**Table 2-5: Transmission ALPHA inputs used to create ALPHA outputs for RSEs**

| Type                                   | ALPHA Component Name |
|--|----------------------|
| 5-spd FWD AT                           | TRX10_FWD            |
| 5-spd RWD AT                           | TRX10_RWD            |
| 6-spd FWD AT                           | TRX11_FWD            |
| 6-spd RWD AT                           | TRX11_RWD            |
| Adv 6-spd FWD AT (no torque converter) | TRX12_FWD_P2_Hybrid  |
| Adv 6-spd FWD AT                       | TRX12_FWD            |
| Adv 6-spd RWD AT                       | TRX12_RWD            |
| 8-spd FWD AT                           | TRX21_FWD            |
| 8-spd RWD AT                           | TRX21_RWD            |
| Adv 8-spd FWD AT (no torque converter) | TRX22_FWD_P2_Hybrid  |
| Adv 8-spd FWD AT                       | TRX22_FWD            |
| Adv 8-spd RWD AT                       | TRX22_RWD            |
| PS Planetary Gear                      | TRX_ECVT_FWD         |
| Surrogate for BEV Transmission         | BEV transmission     |

### 2.4.5.3 Batteries

Table 2-6 lists the drive battery packs used in electrified vehicles. EPA did not test any battery packs for this rulemaking. We relied on battery equivalent circuit data provided by Southwest Research Institute and other sources.

**Table 2-6: Battery ALPHA inputs used to create ALPHA outputs for RSEs**

| Type                 | ALPHA Component Name               | Used For   |
|----------------------|------------------------------------|------------|
| 48-Volt Battery      | battery_base_A123_48V_8Ah          | P0         |
| High-Voltage Battery | battery_base_Samsung_LI_Power_mod2 | PowerSplit |
| High-Voltage Battery | battery_base_9p8_kWh_NCM           | P2         |
| High-Voltage Battery | battery_pack_NMC_58kWh             | BEV        |

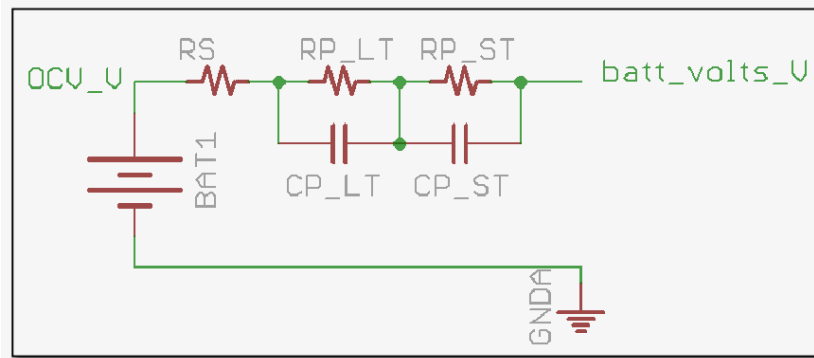
An equivalent circuit model, as shown in Figure 2-12 is used for the battery cells in the ALPHA. The following parameters are used to define the high voltage battery model:

- Open circuit voltage (OCV\_V)
- Series resistance (RS) to model ohmic effects
- Short time constant resistor and capacitor (RP\_ST and CP\_ST) to model charge transfer dynamics

- Long time constant resistor and capacitor (RP\_LT and CP\_LT) to model diffusion dynamics

The ALPHA framework allows for these parameters to be a function of multiple variables such as state of charge (SOC), temperature, etc. The SOC is estimated based on coulomb counting. Additionally, the model also contains a basic thermal model that estimates battery temperature based on the losses.

Specifically, for the HEV and BEV models validated for the program, the propulsion battery parameters are a function of SOC (at minimum) and temperature (when data was available). Further, it was decided that using a series resistance (RS) was sufficient based on the performance of the model compared to the vehicle test data, so the short- and long-time constants are disabled in such scenarios but can be enabled if data is available.



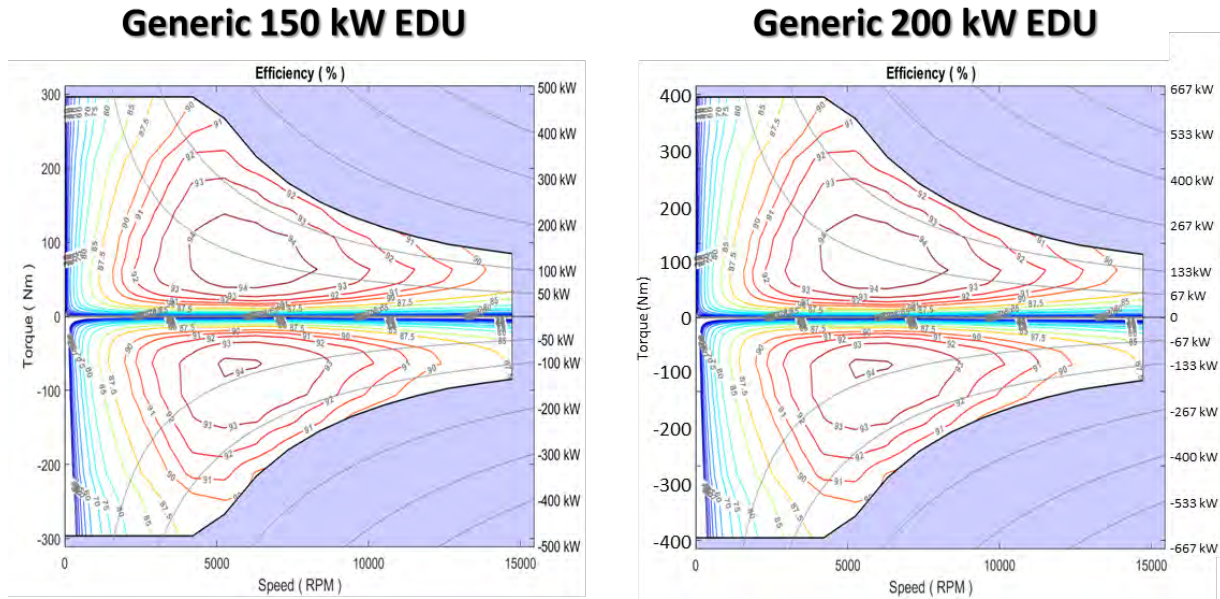
**Figure 2-12: Schematic of equivalent circuit battery model used in ALPHA.**

#### **2.4.6 Scaling rules for ALPHA input maps**

As described in the previous chapter, subcomponents (engines, transmissions, e-motors, and/or batteries) are included in the ALPHA input component library for use in conventional, hybrid, or battery electric architecture models described in Chapter 2.4.4. The specific inputs are chosen to best estimate the performance of the various vehicle technology packages within the vehicle architecture modeled. To appropriately simulate the CO<sub>2</sub> performance of a specific vehicle (with its particular mass, engine power, transmission torque capacity, road load, etc), ALPHA engine, transmission, and e-motor inputs need to be scaled up or down in size to match the size of the simulated vehicles.

EPA scales its engine maps based on cylinder count, surface to volume ratio of the cylinders, and total displacement. For engines and transmissions, the scaling and sizing methodology is the same as previously used in the Proposed Determination on the Appropriateness of the Model Year 2022-2025 Light-duty Vehicle Greenhouse Gas Emissions Standards under the Midterm Evaluation [described in section 2.3.3.3 of the Technical Support Document (U.S. EPA 2016b) (DeKraker, et al. 2017)].

The scaling methodology used in ALPHA for e-motors and electric drive units is simpler than for engines and is accomplished solely by adjusting the y-axis (torque) of the input map while maintaining the same maximum speed, as shown in Figure 2-13.



**Figure 2-13: Power scaling example - Electric drive unit.**

### **2.4.7 Tuning ALPHA's Electrified Vehicle Models Using Vehicle Validations**

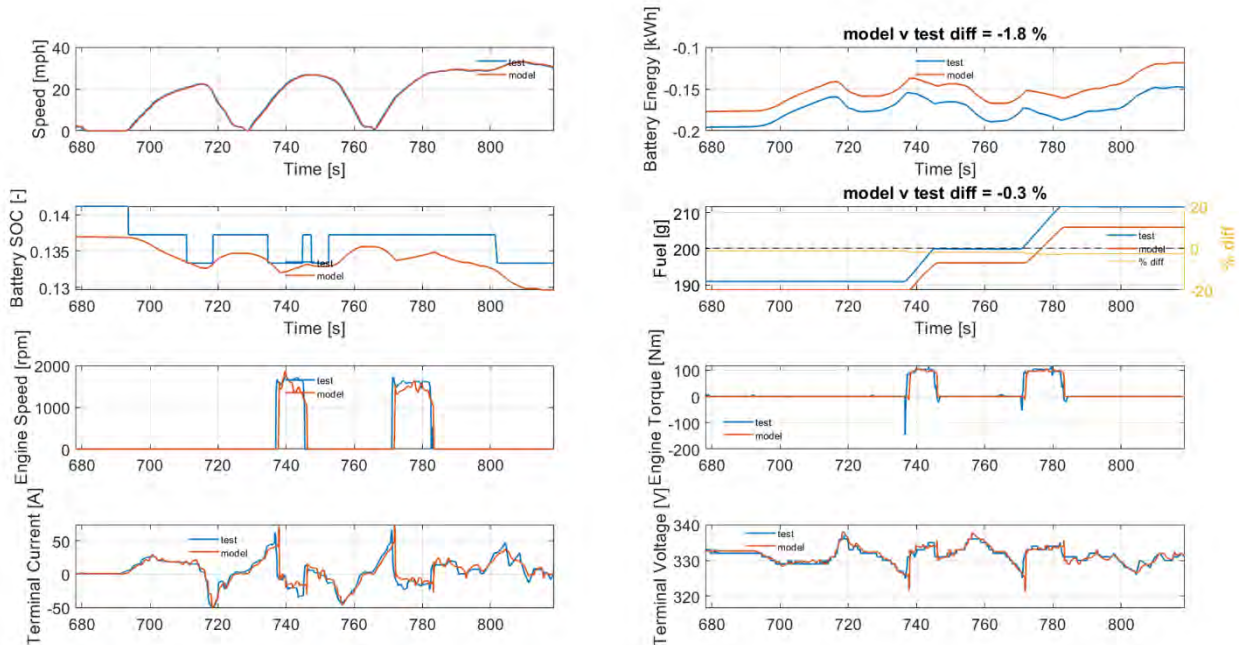
Using the architectures and ALPHA component input data described above, the HEV models (P0, P2, and PowerSplit), and BEV models were developed, calibrated, tuned, and validated using detailed test data measured in a laboratory from specific vehicles listed in Table 2-7 while driven over the EPA city, highway, and US06 regulatory drive cycles.

**Table 2-7: Table of test data vehicles used to validate ALPHA.**

| Model                             | Validation Vehicle             | Notes  |
|-----------------------------------|--------------------------------|--|
| P0<br>Mild Hybrid                 | 2013 Chevrolet Malibu Eco      | -Validation of ALPHA's P0 mild hybrid model was previously completed during the Midterm Evaluation. [9]<br>- Slight updates have been made since then based on data from chassis testing done on 2018 Jeep Wrangler eTorque and 2020 Dodge Ram eTorque vehicles. |
| PowerSplit<br>Strong Hybrid       | 2017 Toyota Prius Prime PHEV   | While this vehicle is a PHEV, the ALPHA validation of ALPHA's PowerSplit model primarily focused on "charge sustaining" operation.   |
| P2<br>Strong Hybrid               | 2016 Hyundai Sonata PHEV       | While this vehicle is a PHEV, the ALPHA validation of ALPHA's P2 hybrid model primarily focused on "charge sustaining" operation.  |
| SP-P4 Strong<br>Hybrid &<br>PHEV  | AWD F-150                      | While this vehicle is a PHEV, the ALPHA validation of ALPHA's SP hybrid model primarily focused on "charge sustaining" operation.  |
| P2-P4 PHEV                        | AWD F-150 &<br>RAM 2500 trucks | While this vehicle is a PHEV, the ALPHA validation of ALPHA's P2 hybrid model primarily focused on "charge sustaining" operation.  |
| Battery Electric<br>Vehicle (BEV) | 2018 Tesla Model 3             |  |

Each electrified vehicle model was tuned to achieve similar operational behavior for the engine, transmission, electric motors, and battery, as observed in actual vehicle test data. For example, Figure 2-14 compares data from the PowerSplit model against the corresponding

measured test data on a 2016 Toyota Prius Prime. This validation process is similar to what was done previously for conventional vehicles. (Newman, Kargul and Barba 2015a)



**Figure 2-14: Sample validation comparison of modeled versus measured data from a 2016 Toyota Prius Prime operating on the drive schedule between 680 to 820 seconds.**

Table 2-8 summarizes the final results of the strong hybrid and BEV models. For the PowerSplit strong hybrid model, the ALPHA simulated combined city-highway CO2 grams per mile was 1.7 percent higher than that of the 2017 Toyota Prius Prime driven on the dynamometer. For the P2 strong hybrid model, the combined city-highway simulation results were 3.6 percent higher than the 2016 Hyundai Sonata PHEV tested on the chassis dyno. Finally, the combined results from the BEV model were 1.9 percent higher than the test data from the 2018 Tesla Model 3.



**Table 2-8: Percent difference of ALPHA vehicle validation simulation versus benchmarking test data.**

| <b>Model: Validation Vehicle</b>                           | <b>Hot UDDS</b> | <b>HW</b> | <b>US06</b> | <b>Combined (hot-UDDS&amp;HW)</b> | <b>Units</b>                        |
|--|-----------------|-----------|-------------|-----------------------------------|-------------------------------------|
| Power Split Strong Hybrid:<br>2017 Toyota Prius Prime PHEV | 0.0%            | 3.8%      | -2.7%       | <b>1.8%</b>                       | % Diff<br>CO <sub>2</sub><br>g/mile |
| P2 Strong Hybrid:<br>2016 Hyundai Sonata PHEV              | 0.9%            | 6.8%      | -1.4%       | <b>3.3%</b>                       | % Diff<br>CO <sub>2</sub><br>g/mile |
| Battery Electric Vehicle:<br>2018 Tesla Model 3            | 3.8%            | -0.5%     | 2.8%        | <b>1.8%</b>                       | % Diff<br>kWh/mi                    |

**ALPHA Tuning of the SP-P4 Strong HEV/PHEV and P2-P4 PHEV models:** Since the SP-P4 and P2-P4 PHEV models represent future vehicles, it was not possible to compare the computer model results against either test vehicle or certification data. However, it was possible to compare the ALPHA results for these models to the corresponding GT-Drive model results in the REET study (Bhattacharjya, et al. 2023) as shown in Table 2-9. ALPHA was able to match the GT-Drive results within +/- 4 percent.

**Table 2-9: Comparison of ALPHA results from SP-P4 Strong HEV/PHEV and P2-P4 PHEV models to the results from the GT-Drive versions of these model in EPA's REET study (Bhattacharjya, et al. 2023).**

| <b>Series-Parallel (SP-P4) gCO<sub>2</sub>/mile</b> |              |              |              |                                  |
|---|--------------|--------------|--------------|----------------------------------|
|   | <b>UDDS</b>  | <b>HwFET</b> | <b>US06</b>  |                                  |
| ALPHA   | 251.1        | 274.9        | 374.0        | <b>F-150<br/>Gasoline DHE</b>    |
| GT-DRIVE  | 244.1        | 267.2        | 363.7        |                                  |
| difference  | <b>2.9%</b>  | <b>2.9%</b>  | <b>2.8%</b>  |                                  |
| <b>Parallel (P2-P4) gCO<sub>2</sub>/mile</b>        |              |              |              |                                  |
|   | <b>UDDS</b>  | <b>HwFET</b> | <b>US06</b>  |                                  |
| ALPHA   | 249.0        | 292.5        | 398.3        | <b>F-150<br/>Gasoline DHE</b>    |
| GT-DRIVE  | 259.2        | 291.8        | 391.5        |                                  |
| difference  | <b>-3.9%</b> | <b>0.2%</b>  | <b>1.7%</b>  |                                  |
| ALPHA   | 330.6        | 359.8        | 483.7        | <b>RAM 2500<br/>Gasoline DHE</b> |
| GT-DRIVE  | 326.1        | 358.9        | 466.1        |                                  |
| difference  | <b>1.4%</b>  | <b>0.3%</b>  | <b>3.8%</b>  |                                  |
| ALPHA   | 310.4        | 336.7        | 453.8        | <b>RAM 2500<br/>Diesel</b>       |
| GT-DRIVE  | 321.8        | 349.1        | 459.5        |                                  |
| difference  | <b>-3.5%</b> | <b>-3.6%</b> | <b>-1.2%</b> |                                  |

**Overall observations of ALPHA’s validation results:** The differences of the combined city-highway results between the test vehicle's data and ALPHA's simulation fall within EPA’s goal for a validation. In its validation efforts, EPA typically targets results to be within +/- 4 percent difference between the test vehicle and the simulation results for the combined city and highway cycles.

In some cases, for individual cycles the difference can be close to or above the targeted value for acceptable reasons. There could be several reasons for differences between simulation and actual validation test data, including:

- The engine maps used for the validation are similar, but not identical, to the engine in the tested vehicle. If the actual vehicle engine map were available as an ALPHA input, the results might have been closer to the vehicle test data.
- It is possible that coast-down coefficient adjustments for electrified vehicles do not adequately account for the losses that occur when the electric motor is always connected to the input of the transmission. (Moskalik 2020)
- The as-driven speed trace in some cases contain additional signal noise that made it unsuitable for simulation. In these cases, the target speed traces for the simulated cycles were used instead, but these simulations would be missing the small variations caused by the "true" as-driven trace.
- The precise amount of braking energy (regen) that can be captured varies from cycle-to-cycle as well as with vehicle-to-vehicle.

Considering the factors listed above, and the good match between the operational behavior of the model and the tested vehicle, the initial validations of these models are robust enough to be suitable for their ultimate use to estimate fleet-wide emissions. The difference percentages of the individual cycle results noted during the validation are small enough to meet the combined cycle goal of the validation and not require any adjustments. The next chapter shows how well each of the validated electrified vehicle models can simulate other variant vehicles (vehicles that are technology-wise similar to the vehicles used to validate the model).

#### **2.4.7.1 Verifying the Validated Strong Hybrid and BEV Models against Variant Vehicles**

Since ALPHA architecture models are intended to simulate a range of vehicles, it is helpful to compare ALPHA results to data from multiple tests on multiple vehicles. Therefore, the next step in the validation process was to verify the ALPHA model against a number of technically similar, but different, vehicles (think of these other vehicles as "sibling" or "cousin" vehicles). These variant vehicles were selected because they have very similar powertrain designs and control strategies to the initial validation vehicle, yet they may be of different size and make. Additionally, the certification data originates from different vehicles, drivers, equipment, and laboratories, all of which increases the variability of the comparisons, and can yield a measure of how well the validated model can simulate other vehicles.

Once each vehicle model was developed and tuned to provide similar behavior as its test vehicle, CO<sub>2</sub> (for hybrid operation) and energy consumption (for BEVs and PHEVs running in charge depleting mode) results were compared for other "variant" vehicles from the same manufacturer with very similar powertrain designs as the original validation vehicle. Since there were no dynamometer test data for these variant vehicles, the ALPHA simulation results were checked to see how closely they agreed with available vehicle Certification data. These results of the ALPHA model validations and their variant verifications for the strong hybrids and BEVs are summarized in Table 2-10.

**Table 2-10: Percent difference of variant vehicle ALPHA simulations versus certification data.**

| Verification of Variant Vehicles                                    | City   | HW    | US06  | Combined (City & HW) | units                                  | # vehs. |
|---|--------|-------|-------|----------------------|--|---------|
| Power Split Strong Hybrid Variants:<br>2017 Toyota Prius Prime PHEV | -4.8%* | -2.1% | -5.1% | -3.56%               | Avg % diff CO <sub>2</sub> g/mi        | 5       |
|   | 2.9%*  | 2.5%  | 3.8%  | 2.54%                | Std-dev of % diff CO <sub>2</sub> g/mi |         |
| P2 Strong Hybrid variants:<br>2016 Hyundai Sonata PHEV              | -0.7%* | 5.6%  | 7.9%  | 1.92%                | Avg % diff CO <sub>2</sub> g/mi        | 2       |
|   | 3.9%*  | 3.2%  | 3.0%  | 3.61%                | Std-dev of % diff CO <sub>2</sub> g/mi |         |
| Battery Electric Vehicle:<br>2018 Tesla Model 3                     | 5.9%** | 1.6%  | n/a   | 3.91%                | Avg % diff kWh/mi                      | 12      |
|   | 2.3%** | 2.7%  | n/a   | 2.33%                | Std-dev of % diff kWh/mi               |         |

\* cold-start FTP \*\* warm-UDDS

The top row of Table 2-10 summarizes the average difference between ALPHA estimated CO<sub>2</sub> g/mile and Certification CO<sub>2</sub> g/mile for five Toyota variants of the Prius Prime PowerSplit design operating in charge sustaining mode. The comparison shows the average CO<sub>2</sub> percent difference over the three drive cycles (FTP, HW, and US06) to be -4.8 percent, -2.1 percent, and -5.1 percent, respectively. The average percent difference of the combined (FTP-HW) CO<sub>2</sub> values is shown to be -3.6 percent. The standard deviation of these combined averages is shown to be 3.8 percent.

The center row of Table 2-10 summarizes the average difference between a P2 strong hybrid vehicle's ALPHA estimated CO<sub>2</sub> g/mile and its Certification CO<sub>2</sub> g/mile for two Hyundai/Kia variants of the Sonata P2 Hybrid design operating in charge sustaining mode. This comparison shows the average CO<sub>2</sub> percent difference over the three drive cycles (FTP, HW, and US06) to be -0.7 percent, 5.6 percent, and -7.9 percent, respectively. The average percent difference of the combined (cold FTP-HW) CO<sub>2</sub> values is shown to be 1.9 percent. The standard deviation of these combined averages is shown to be 3.6 percent.

The bottom row of Table 2-10 summarizes the average difference between a Tesla BEV's ALPHA estimated energy consumption (kWh/mi) and its Certification energy consumption (kWh/mi) for 12 variants of the Tesla Model 3 design. This comparison shows the average kWh/mi percent difference between two available drive cycles (FTP and HW) to be 5.9 percent and 1.6 percent, respectively; no US06 Certification data were available for this comparison. The average percent difference of the combined (FTP-HW) CO<sub>2</sub> values is shown to be 3.9 percent. The standard deviation of these combined averages is shown to be 2.3 percent.

Comparing the combined city-highway averages of the variant vehicle simulations in Table 2-10 to the vehicle validation combined averages in Table 2-8 shows a slight increase in variability, which was expected given the validated model was tuned using a specific validation vehicle, yet asked to estimate results for slightly different vehicles. There could be several reasons for differences between simulation and actual certification test data, including:

- Certification values inherently contain some variability since they are driven and measured in different laboratories. The typical test-to-test variation of chassis

dynamometer certification testing can be +/-3 percent due to a variety of factors such as different drivers, measurement equipment, fuel, and facilities.

- In addition, for hybrid and PHEV vehicles, certification testing follows the recommended practice in the 2010 revision of SAE Standard J1711 (SAE 2010). This standard allows a net energy change in the battery over a test of up to +/-1 percent of the total fuel energy consumed, while not requiring the measured CO<sub>2</sub> value to be corrected (unlike in the ALPHA simulations). Depending on the average efficiency of the engine and electrical system, this variation could alter fuel usage (and CO<sub>2</sub> emissions) by +/-2 to 3 percent.

Considering the factors listed above, the variant vehicle simulation results in Table 2-10 are quite good. With a large number of test vehicles, the test-to-test variations of certification data would tend to cancel out as will be shown in Chapter 2.4.8 where ALPHA's ability to model large fleets is discussed.

Since the SP-P4 strong HEV/PHEV and P2-P4 PHEV models represent future vehicles that are not yet in production, it was not possible to compare the ALPHA model results against certification data of any variant vehicles.

#### **2.4.7.2 P0 Mild Hybrid Validation Efforts**

The ALPHA validation for P0 mild hybrid vehicles was done during the Midterm Evaluation (Lee, et al. 2018), consequently there is no recent P0 mild hybrid vehicle validation data shown in Table 2-11. Instead, a different approach was taken to validate the accuracy of the P0 model. The first two rows of data in Table 2-11 summarize the differences of ALPHA CO<sub>2</sub> simulations of 24 conventional vehicles with both P0 mild hybrid and engine start-stop technology applied compared to the ALPHA CO<sub>2</sub> simulations of the same vehicles with neither technology applied. The ALPHA simulation data shows an average combined (FTP-HW) CO<sub>2</sub> reduction of 9.3 percent when applying both P0 mild hybrid and engine start-stop technologies to conventional vehicles.

The next two rows of data in Table 2-11 document the differences between five comparisons of EPA certification results of P0 mild hybrids with engine start-stop applied against the EPA certification results of similar conventional vehicles without applying both the P0 mild hybrid and engine start-stop technologies. The EPA certification data shows an average combined (FTP-HW) CO<sub>2</sub> reduction of 10.9 percent when applying both P0 mild hybrid and engine start-stop technologies to a conventional vehicle. These results verify that ALPHA simulates P0 mild hybrid combined with engine start-stop technologies within -1.6 percent.

**Table 2-11: Estimated CO<sub>2</sub> reductions with both P0 mild hybrid & engine start-stop technologies applied to the comparable conventional vehicle.**

| MY 2019 P0 Mild Hybrids                   | Cold-Start FTP | HW    | US06 | Combined (cold-FTP & HW) | units  | # vehs. |
|---|----------------|-------|------|--------------------------|--|---------|
| ALPHA of P0 vs ALPHA sim of conv vehicles | 13.3%          | 2.1%  | n/a  | <b>9.3%</b>              | avg % diff CO <sub>2</sub> for all pairs of sims.            | 24      |
|   | 2.4%           | 0.5%  | n/a  | <b>1.8%</b>              | std-dev of \$diff CO <sub>2</sub> for all pairs of sims.     |         |
| Cert of P0 vs Cert of conv vehicles       | 13.8%          | 5.1%  | n/a  | <b>10.9%</b>             | avg % diff CO <sub>2</sub> for all pairs of Cert data        | 5       |
|   | 2.7%           | 2.0%  | n/a  | <b>1.5%</b>              | std-dev of \$diff CO <sub>2</sub> for all pairs of Cert data |         |
| Difference of CO <sub>2</sub> averages    | -0.5%          | -3.0% | n/a  | <b>-1.6%</b>             | difference of avg % diff CO <sub>2</sub>                     | -       |

### **2.4.8 Verifying ALPHA's Ability to Simulate Entire Fleets**

To demonstrate that ALPHA is capable of modeling large fleets with a wide variety of technologies, ALPHA3 was used to simulate the entire MY 2022 light-duty base year fleet. To model the performance of these vehicles, data collected by EPA for compliance purposes, together with information from other sources including laboratory vehicle benchmarking, were used to calculate various metrics for vehicle and technology characteristics that are related to fuel economy and GHG emissions. The process used was similar to that used by EPA in 2018. (Bolon, et al. 2018)

#### **2.4.8.1 Data Sources to Determine MY 2022 Light-Duty Fleet Parameters**

Vehicle specification data that is relevant to characterizing emissions-reducing technologies are available from multiple sources. Because these data sources were generally not originally developed for this particular use, any single source will often provide only partial coverage of vehicle models over the years of interest, and production volume data necessary for generating aggregate statistics is often lacking. This chapter describes a methodology for consolidating data from multiple sources, while maintaining the integrity of the original data.

The most basic obstacle to consolidating data sets is variation in how vehicles are classified in different data sources. This might include variation in the level of detail as well as variation in the particular dimensions along which vehicles are characterized. Even when various data sets share a common categorization method, merging multiple sources may still be complicated when one or more of the data sets does not include the entire range of vehicles.

The primary data source used by EPA to characterize the GHG performance of the existing fleet is the certification data submitted by manufacturers to EPA's VERIFY database. The data pertain mainly to vehicle emissions performance collected in dynamometer testing, and include a general classification of engines, transmissions, and drive systems. Also included are vehicle characteristics related to road loads: dynamometer target and set coefficients, road load horsepower, and test weights. Additional data are obtained from the "2022 Test Car List" available on EPA's "Data on Cars Used for Testing Fuel Economy" (U.S. EPA 2022e) and FuelEconomy.gov (US DOE & EPA 2024) websites, both of which are publicly available.

In addition to the information in datasets maintained by EPA, additional vehicle specifications and technology details can be obtained through other public and commercially available sources of vehicle data such as Edmunds.com, Wards Automotive (Penton) and AllData Repair (AllData LLC).

For the MY 2022 base year light-duty fleet, there were a total of 1305 distinct vehicle model types.

### 2.4.8.2 Vehicle Parameters

Using these aggregated data sources, a technology assignment of the powertrain for each vehicle was made based on the nominal technology description in the data source. The categories used to differentiate powertrain components are shown in Table 2-12.

**Table 2-12: Powertrain components and categories.**

| Component Category         | Applicable to                 | Values   |
|----------------------------|-------------------------------|--|
| Level of electrification   | All vehicles                  | Conventional, mild hybrid, strong hybrid, strong PHEV, or battery electric vehicle         |
| Start-stop                 | Conventional vehicles         | Y or N   |
| Type of hybridization      | Mild hybrids                  | P0 or P1   |
|                            | Strong hybrids/PHEVs          | PowerSplit, P2, series-parallel, or series   |
| Engine type                | Non-BEVs                      | diesel, PFI naturally aspirated, GDI naturally aspirated, turbocharged, supercharged, none |
| Transmission type          | Conventional and mild hybrids | AT, CVT, DCT, manual   |
|                            | Strong hybrids/PHEVs          | Specialty  |
|                            | BEVs                          | Direct drive   |
| Number of gears            | Step transmissions            | Number   |
| Cylinder deactivation      | Non-BEVs                      | Discrete, continuous, or none  |
| Engine power               | Non-BEVs                      | Power (HP)   |
| Engine displacement        | Non-BEVs                      | Displacement (liters)  |
| Engine number of cylinders | Non-BEVs                      | 3/4/6/8/10/12  |
| Electric motor power       | BEVs and hybrids              | Power (kW)   |
| Battery size               | BEVs and hybrids              | Energy (kWh)   |

In addition to the powertrain description, other vehicle parameters are necessary to simulate individual vehicles within ALPHA. These parameters, shown in Table 2-13, were also pulled from the data sources.

**Table 2-13: Vehicle Parameters.**

| Parameter                                  | Values / Units                                  |
|--|---|
| Equivalent test weight (ETW)               | lbm   |
| Drive type                                 | FWD, RWD, or AWD                                |
| Vehicle coast-down target values (A, B, C) | A (lbf), B (lbf/mph), C (lbf/mph <sup>2</sup> ) |
| n/v ratio                                  | rpm/mph   |
| Footprint                                  | Square feet                                     |
| Production volume                          | Number of units                                 |
| Frame style                                | Unibody v. body on frame                        |
| Towing capacity                            | lbm   |

### 2.4.8.3 Electrified Powertrain Model Assignments

Based on the level of electrification and the type of hybridization, vehicle model types in the MY 2022 light-duty fleet were separated into individual groups to which the appropriate ALPHA model was applied. These groups are shown in Table 2-14.

Generally, vehicles without electrified components were grouped as conventional vehicles, while vehicles without internal combustion engines were grouped as BEVs. These include fuel cell electric vehicles (FCEVs), which make up around 0.02 percent of the fleet. For hybrid vehicles, those with P1 or P0 architectures were considered mild hybrids and modeled with ALPHA's P0 model. For strong hybrids and PHEVs, vehicles with P2 architectures were modeled with ALPHA's P2 model, and the remainder of the hybrid fleet (the vast majority) was modeled with the PowerSplit model.

**Table 2-14: Vehicle model type assignments in MY 2022 light-duty fleet.**

| Vehicle architecture groups                       | ALPHA model                | Number of vehicle model types |
|---|----------------------------|-------------------------------|
| Conventional vehicles, with or without stop-start | Conventional vehicle model | 1018                          |
| Mild hybrids (P0 and P1)                          | P0 model                   | 91                            |
| Strong hybrids and PHEVs with P2 architecture     | P2 model                   | 60                            |
| All other strong hybrids and PHEVs                | PowerSplit model           | 40                            |
| BEVs and FCEVs                                    | BEV model                  | 96                            |

### 2.4.8.4 Modeling Conventional Vehicles in the Fleet

To model conventional vehicles, available ALPHA maps for powertrain components were assigned to each vehicle, depending on which map had attributes closest to the engine in the specific vehicle being modeled. Engines in conventional vehicles were mapped to the ALPHA input engine maps given in Table 2-3. The engine assignment was generally based on aspiration. Previous investigation had determined that modern PFI and GDI engines have similar performance, and thus these engines were grouped together as naturally aspirated (NA) engines. Other groups were diesel engines, boosted engines, and Atkinson engines. For boosted engines, some engine families with better performance were assigned to use an advanced turbocharged engine.

For some engine categories, different engine maps were specified depending on whether the modeled vehicle was categorized as a towing vehicle or not. For this purpose, all vehicles that had an OEM-defined towing capacity and/or were large body-on-frame vehicles were classified as towing/hauling, high load application (HLA) vehicles. This category encompassed large and mid-sized pickup trucks, most large SUVs, and large vans. HLA vehicle model types with NA or standard turbo engines were assigned ALPHA engines which reflected the towing requirement. The assignment of ALPHA engines to conventional base year fleet vehicles is given in Table 2-15. For each vehicle model type, the engine model was scaled to match either the given power of the engine (power scaling), or to match the engine displacement (displacement scaling) as described in Chapter 2.4.6 (DeKraaker, et al. 2017).



**Table 2-15: Assignments of engines used to simulate MY 2022 base year fleet conventional vehicle model types, based on engines in Table 2-3.**

| Engine Categories                | Modeled As    | Scaling      | ALPHA engine input             |
|----------------------------------|---------------|--------------|--------------------------------|
| Diesel engines                   | Diesel engine | power        | 2020 GM 3.0L Duramax           |
| PFI and GDI NA engines (non-HLA) | GDI engine    | power        | 2013 Chevrolet 2.5L Ecotec LCV |
| PFI and GDI NA engines (HLA)     | GDI engine    | displacement | GTPower 2020 Ford 7.3L         |
| Atkinson engines                 | Atkinson      | power        | 2018 Toyota 2.5L A25A-FKS      |
| Turbocharged engines (non-HLA)   | TDS engine    | power        | 2013 Ford Ecoboost 1.6L        |
| Turbocharged engines (HLA)       | TDS engine    | power        | 2015 Ford EcoBoost 2.7L        |
| Supercharged engines             | TDS engine    | displacement | 2013 Ford Ecoboost 1.6L        |
| Advanced turbocharged engines    | Adv. TDS      | power        | 2016 Honda 1.5L L15B7          |

Transmissions in conventional vehicle model types were mapped to one of five automatic step transmissions given in Table 2-5. Available production transmission varieties, including step automatic transmissions (ATs), CVTs, DCTs, and manual transmissions were mapped to one of these five modeled transmissions used in ALPHA. Although the behavior of the modeled TRX ATs is not identical to other transmission varieties, the overall effect on powertrain efficiency and thus GHG emissions is similar.

Losses in the transmission and differential were modified depending on whether the vehicle was a front or rear wheel drive. This mapping is very similar to the process used by EPA in earlier rulemakings (U.S. EPA 2016b). Losses in the transmission were scaled to the peak torque of the engine.

**Table 2-16: Transmissions used to simulate MY 2022 base year fleet conventional vehicles, based on transmissions given in Table 2-5.**

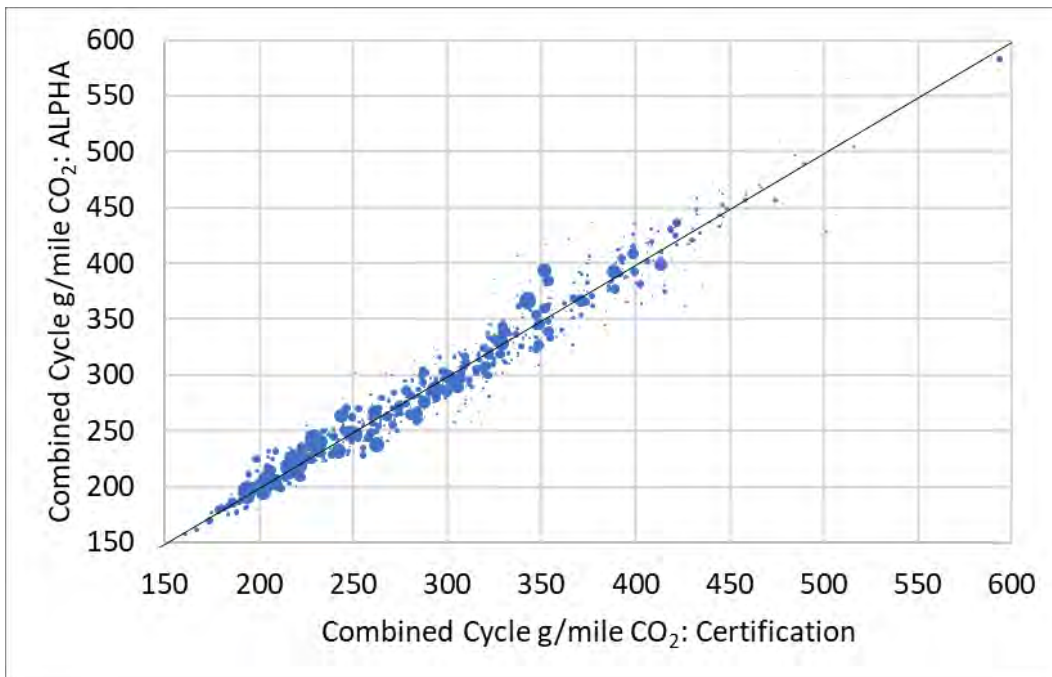
| Transmission Categories                | Modeled As | Source / Notes                           |
|--|------------|--|
| 4- and 5-spd ATs, 5- and 6-spd manuals | TRX10      | Five-speed from 2007 Toyota Camry        |
| 6-spd ATs                              | TRX11      | Six-speed GM 6T40                        |
| All DCTs, 7-spd manuals                | TRX12      | Six-speed with advanced loss reduction   |
| 7-spd and above ATs, older CVTs        | TRX21      | Eight-speed FCA 845RE                    |
| Newer CVTs                             | TRX22      | Eight-speed with advanced loss reduction |

With the appropriate powertrain assigned, each vehicle was simulated in ALPHA over the 3-bag FTP and HWFET cycles, using the vehicle parameters in Table 2-13.

The grams per mile (g/mi) CO<sub>2</sub> values from the ALPHA simulation were compared to certification values; the production weighted averages of the differences, both in absolute g/mile and in percent, are given in 2-17. A scatter plot of the ALPHA versus certification values is shown in Figure 2-15. The sizes of the bubbles in the plot reflect production volumes for each vehicle.

**Table 2-17: Conventional vehicle model type in the MY 2022 fleet - ALPHA CO<sub>2</sub> g/mile values versus certification CO<sub>2</sub> g/mile.**

|                                       | <b>FTP</b>   | <b>HW</b>    | <b>Combined</b> |
|---------------------------------------|--------------|--------------|-----------------|
| Production weighted average g/mile    | -11.2 g/mile | +12.4 g/mile | -0.6 g/mile     |
| Production weighted std. dev. g/mile  | 18.4 g/mile  | 13.3 g/mile  | 13.1 g/mile     |
| Production weighted average percent   | -3.0%        | +5.2%        | -0.1%           |
| Production weighted std. dev. percent | 5.2%         | 5.2%         | 4.5%            |



**Figure 2-15: Conventional Vehicles in the MY 2022 fleet - ALPHA combined cycle CO<sub>2</sub> g/mile values versus certification CO<sub>2</sub> g/mile where bubble sizes reflect production volumes.**

The production weighted average of the ALPHA CO<sub>2</sub> values is within 0.1 percent of the certification values and is within 1 g/mile of the certification value average. The graph in Figure 2-15 clearly indicates there is some scatter in the results; however, over 60 percent of the vehicles in the fleet were simulated within 10 g/mile of certification values, and nearly 90 percent of the fleet was simulated within 20 g/mile. Generally, the more substantial outliers (i.e., those model types where the ALPHA simulation was not as well matched to the certification values) were low-volume vehicles.

#### **2.4.8.5 Modeling Mild Hybrids in the Fleet**

All mild hybrids were modeled using a P0 BISG model with engine start-stop, (Lee, et al. 2018) using the BISG motor from Table 2-4 and the 48V battery from Table 2-6. The mild hybrids in the fleet are produced by multiple manufacturers with different operational strategies

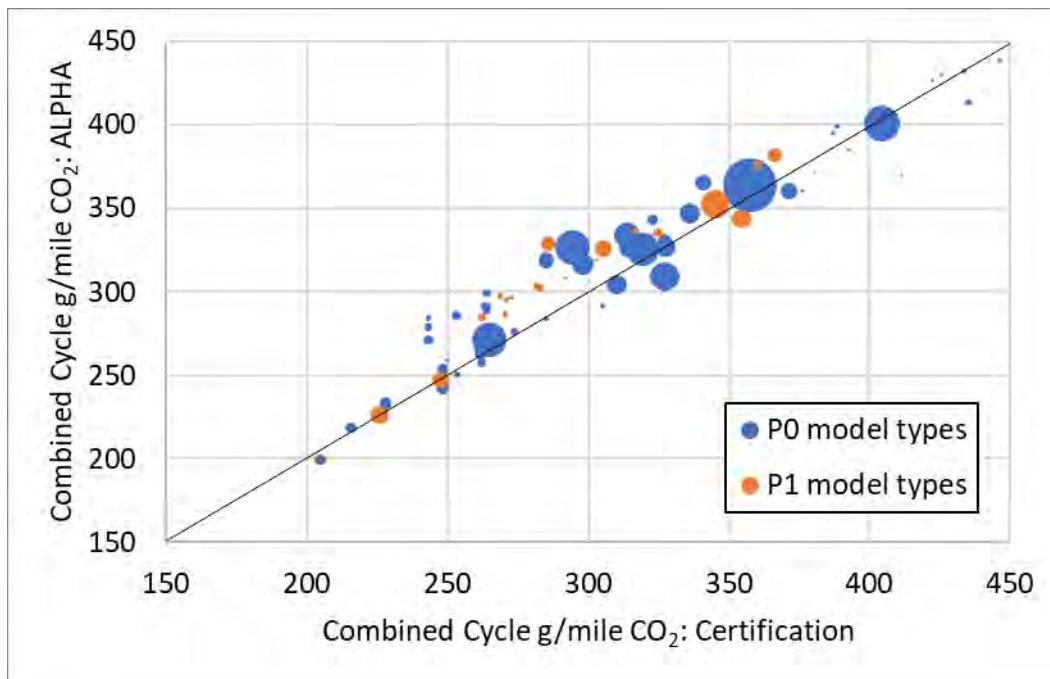
and configurations (P0 v. P1 configurations, and 48V v. 12V architecture). However, a single P0 model was used to represent all mild hybrid vehicles.

The engines and transmissions for mild hybrids were assigned and scaled in the same way as for conventional vehicles. The motor power and battery pack capacity in the simulation were scaled to match the values of these components in the vehicle model type being simulated.

Each vehicle was simulated in ALPHA over the combined FTP and HWFET cycles using the parameters in Table 2-13. The g/mile CO<sub>2</sub> values from the ALPHA simulation were compared to certification values; the production weighted average of the difference is given in Table 2-18. A scatter plot of the ALPHA versus certification values is shown in Figure 2-16.

**Table 2-18: P0 mild hybrids in the MY 2022 fleet - ALPHA CO<sub>2</sub> g/mile values versus certification CO<sub>2</sub> g/mile.**

|                                       | <b>FTP</b>  | <b>HW</b>    | <b>Combined</b> |
|---------------------------------------|-------------|--------------|-----------------|
| Production weighted average g/mile    | -5.1 g/mile | +25.2 g/mile | +8.5 g/mile     |
| Production weighted std. dev. g/mile  | 21.6 g/mile | 8.6 g/mile   | 14.0 g/mile     |
| Production weighted average percent   | -1.0%       | +9.9%        | +2.9%           |
| Production weighted std. dev. percent | 5.9%        | 3.4%         | 4.7%            |



**Figure 2-16: P0 mild hybrids in the MY 2022 fleet - ALPHA combined cycle CO<sub>2</sub> g/mile values versus certification CO<sub>2</sub> g/mile where both P0 and P1 model types were simulated using the ALPHA P0 model and bubble sizes reflect production volumes.**

The same P0 architecture was used to simulate the performance of all mild hybrids; notably, both P0 and P1 architectures were represented by a P0 model. The P0 and P1 model types are illustrated separately in Figure 2-16. Even though the architecture in the actual vehicle model type differed, the P0 model reasonably represented both P0s and P1s. For all mild hybrids, the production weighted average of the difference between ALPHA simulation and certification CO<sub>2</sub>

values was 2.9 percent, or 8.5 g/mile. Individually, the P0 and P1 model types were simulated to similar degrees of accuracy: for P0 model types, the production weighted average difference was 2.9 percent, or 8.4 g/mile, and for P1 model types, the same average difference was 3.1 percent, or 9.4 g/mile.

#### **2.4.8.6 Modeling Strong Hybrids in the Fleet**

As shown in Table 2-14, the strong hybrids and PHEVs were divided into two categories, covered separately in the following subchapters. The parallel P2 hybrids were modeled as P2s, and the remainder of the strong hybrid fleet were modeled as PowerSplits. For many of these strong hybrids, the engine was assumed to be a dedicated hybrid engine (DHE), utilizing either an Atkinson cycle DHE or (in the case of turbocharged engines) a Miller cycle DHE, based on the two dedicated hybrid engines given in Table 2-3. However, performance oriented strong P2 hybrids in the fleet do not contain dedicated hybrid engines; rather, their engines are more similar to those in non-hybrid vehicles. For these vehicles, a non-DHE NA or turbo engine was chosen with the process used for conventional vehicles. Likewise, the electric motors for strong hybrids are based on the motors shown in Table 2-4, and the batteries are based on the batteries from Table 2-6.

The range of strong hybrids in the fleet covers multiple manufacturers, vehicle applications, hybrid configurations, and operational strategies. Additionally, not all strong hybrids have a dedicated hybrid engine as modeled in ALPHA. However, it was judged that using these two strong hybrid models would be reasonably representative of the fleet.

In a similar way to conventional vehicles, the engine model in each hybrid vehicle was resized to match the given power of the vehicle engine as discussed above. The electric drive motors were sized to provide power proportional to the engine power based on the configuration of the original vehicle used to validate the P2 or PowerSplit model. Having a consistent ratio of electric motor and engine sizes allowed the simulation to use the same control algorithms for every vehicle model type, effectively representing the wide variation that exists in the original fleet with just two models in ALPHA. Battery sizes were assigned according to the given value for the vehicle from EPA's 2022 fleet parameter file (described in Chapter 2.4.8.1).

The same models were used to simulate the operation of non-plug-in HEVs and the charge sustaining operation of PHEVs, with some minor differences in component sizing. PHEVs generally have larger battery sizes, and thus the allowable SOC fluctuations during charge sustaining mode were reduced. Additionally, for the P2 model, the nominal e-motor sizes for PHEVs were increased to allow for all-electric operation over the drive cycles during charge depleting mode.

##### **2.4.8.6.1 PowerSplit modeling (HEVs and Charge-Sustaining-Mode PHEVs)**

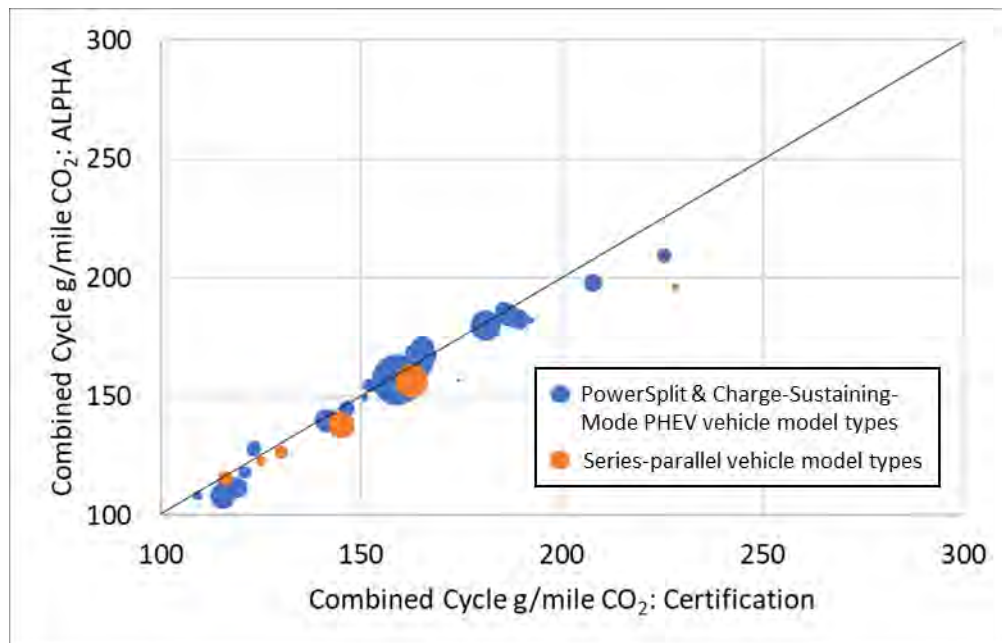
For the vehicle model types modeled as power splits, the engine and drive motor were connected using a planetary gearset based on the Toyota Prius. Both e-motors in the system were sized as a function of the rated engine power to keep the power values in the system proportional.

Each vehicle was simulated in ALPHA over the 4-bag FTP and HWFET cycles, using the vehicle parameters in Table 2-13. PHEVs were simulated in both charge sustaining and charge depleting mode (discussed later in Chapter 2.4.8.6.3). The g/mile CO<sub>2</sub> values from the ALPHA

simulation were compared to certification values; the production weighted average of the difference is given in Table 2-19.

**Table 2-19: PowerSplit HEVs and PS PHEVs in Charge-Sustaining-Mode in the MY 2022 fleet - ALPHA CO<sub>2</sub> g/mile values versus certification CO<sub>2</sub> g/mile.**

|                                       | <b>FTP</b>  | <b>HW</b>   | <b>Combined</b> |
|---------------------------------------|-------------|-------------|-----------------|
| Production weighted average g/mile    | -8.1 g/mile | +4.9 g/mile | -2.2 g/mile     |
| Production weighted std. dev. g/mile  | 5.6 g/mile  | 5.1 g/mile  | 4.6 g/mile      |
| Production weighted average percent   | -5.2%       | +2.8%       | -1.5%           |
| Production weighted std. dev. percent | 3.1%        | 3.2%        | 2.8%            |



**Figure 2-17: PowerSplit HEVs and PS PHEVs in Charge-Sustaining-Mode in the MY2022 fleet - ALPHA combined cycle CO<sub>2</sub> g/mile values versus certification CO<sub>2</sub> g/mile values where both PowerSplit and Series-parallel vehicle model types were simulated using the PS model and bubble sizes reflect production volumes.**

A scatter plot of the ALPHA versus certification values for vehicles modeled as PowerSplit hybrids in the 2022 fleet is shown in Figure 2-17. The ALPHA PS model was used to simulate both PowerSplit and series-parallel hybrids. The simulation results of the PowerSplit and series-parallel hybrid types are illustrated separately in Figure 2-17. The PS model overall does quite well in simulating the certification results, with an average difference under 2 percent and a low standard deviation.

For PowerSplit vehicle model types, the production weighted average difference between ALPHA simulation and certification CO<sub>2</sub> values is very low, at -1.4 percent, or -2.2 g/mile. For series-parallel vehicle model types, the same comparison difference is somewhat larger, at -3.7 percent, or -5.8 g/mile. This may be due to the limited number of vehicle model types available

since those used produced simulated results close to the certification values. Although the PowerSplit and series-parallel architectures are clearly different in practice, the ALPHA PS model does produce fairly equivalent CO<sub>2</sub> values when used to simulate either architecture.

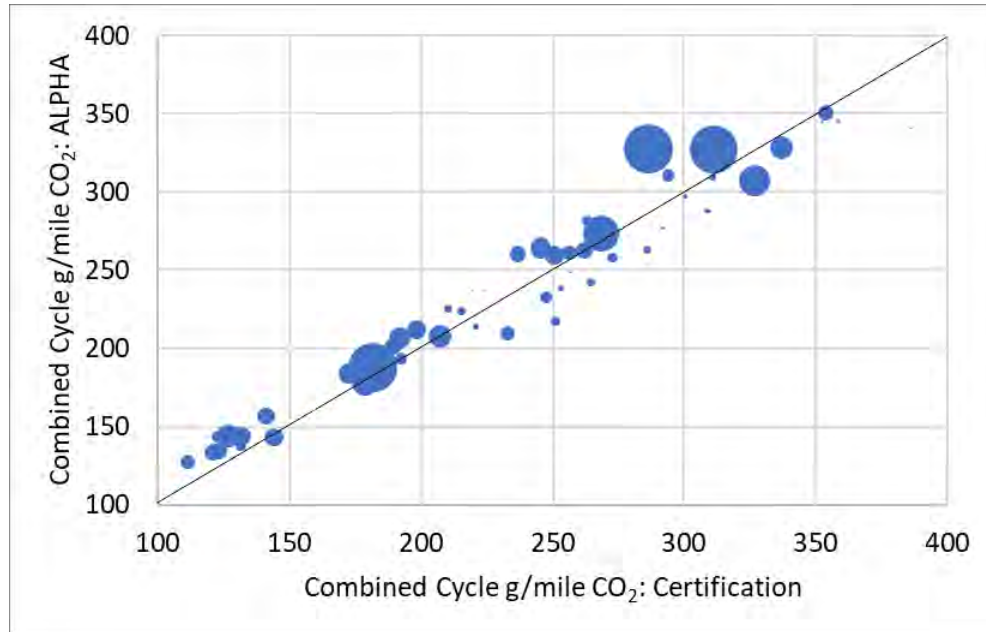
**2.4.8.6.2 P2 modeling (HEVs and Charge-Sustaining-Mode PHEVs)**

For the vehicles modeled as a P2, the chosen engine was coupled to either a six- or eight-speed transmission, depending on the number of gears in the modeled vehicles. These P2 transmissions were based on the TRX12 and TRX22, with the torque converter removed.

P2 vehicles were simulated in ALPHA over the 4-bag FTP and HWFET cycles, using the parameters in Table 2-13. The g/mile CO<sub>2</sub> values from the ALPHA simulation were compared to certification values; the production weighted average of the difference is given in Table 2-20. A scatter plot of the ALPHA versus certification values for P2 hybrid vehicles in the 2022 fleet is shown in Figure 2-18.

**Table 2-20: P2 HEVs and P2 PHEVs in Charge-Sustaining-Mode in the MY 2022 fleet - ALPHA CO<sub>2</sub> g/mile values versus certification CO<sub>2</sub> g/mile.**

|                                       | <b>FTP</b>  | <b>HW</b>    | <b>Combined</b> |
|---------------------------------------|-------------|--------------|-----------------|
| Production weighted average g/mile    | +2.6 g/mile | +20.6 g/mile | +10.7 g/mile    |
| Production weighted std. dev. g/mile  | 22.0 g/mile | 16.2 g/mile  | 16.0 g/mile     |
| Production weighted average percent   | +2.6%       | +8.7%        | +5.0%           |
| Production weighted std. dev. percent | 8.2%        | 5.6%         | 6.2%            |



**Figure 2-18: P2 HEVs and P2 PHEVs in Charge-Sustaining-Mode in the MY 2022 fleet - ALPHA combined cycle CO<sub>2</sub> g/mile values versus certification CO<sub>2</sub> g/mile where bubble sizes reflect production volumes.**

Here, the ALPHA simulation on average has 5.0 percent, or 10.7 g/mile higher CO<sub>2</sub> than the certification values. It should be noted there are a low number of P2 model types, with only five model types accounting for half of the total production volume. Figure 2-18 shows that two of the highest volume vehicles have CO<sub>2</sub> values over-predicted by ALPHA. If the unweighted average were used in calculation, the difference is +2.1 percent, which indicates the sales mix, particularly the highest volume model type, is influencing the sales-weighted average.

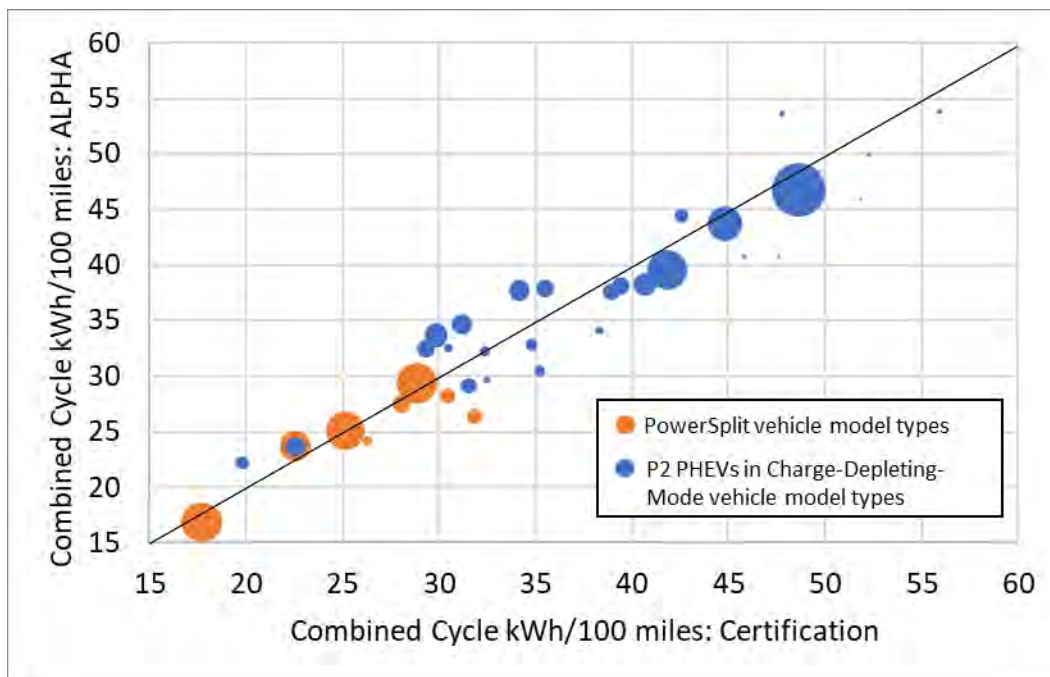
#### **2.4.8.6.3 Charge depleting mode for PHEVs**

The charge depleting operation of both PowerSplit and P2 PHEVs was also simulated. ALPHA simulations over the certification drive cycles track direct current (D/C) energy consumed from the battery, while certification values reflect the alternating current (A/C) energy required to recharge the vehicle. Thus, the ALPHA D/C cycle simulation results were converted into the equivalent A/C recharging energy required. The ratio of D/C electric energy consumed to A/C energy used to charge the vehicle was assumed to be 0.87, based on an average of available vehicle data from certification applications for battery electric vehicles. This factor was applied to all PHEV simulation results to convert from D/C energy to A/C energy values.

These A/C energy values were compared to certification values. The operation of and results from PowerSplit and P2 charge depleting operation were similar, and thus the results from both architectures are presented together. The production weighted averages of the differences are given in Table 2-21. A scatter plot of the ALPHA versus certification values is shown in Figure 2-19 for both architectures.

**Table 2-21: PowerSplit and P2 PHEV both in Charge-Depleting-Mode in the MY 2022 fleet - ALPHA kWh/100 miles values versus certification kWh/100 miles.**

|   | FTP                 | HW                  | Combined            |
|---|---------------------|---------------------|---------------------|
| Production weighted average kWh/100 miles   | +0.37 kWh/100 miles | -1.43 kWh/100 miles | -0.44 kWh/100 miles |
| Production weighted std. dev. kWh/100 miles | 2.22 kWh/100 miles  | 2.18 kWh/100 miles  | 1.99 kWh/100 miles  |
| Production weighted average percent         | +1.6%               | -3.4%               | -0.8%               |
| Production weighted std. dev. percent       | 7.1%                | 5.8%                | 6.0%                |



**Figure 2-19: PowerSplit and P2 PHEVs both in Charge-Depleting-Mode in the MY 2022 fleet - ALPHA combined cycle kWh/100 miles values versus certification kWh/100 miles where bubble sizes reflect production volumes.**

The data shown represent charge depleting operation of both PowerSplit and P2 vehicles. Individually, ALPHA results are very similar. For PowerSplit model types, the production weighted average of the difference between ALPHA simulation and certification consumption values is -1.1 percent, or -0.26 kWh/100 miles. For P2 PHEVs, the same comparison difference is -0.6 percent or -0.56 kWh/100 miles.

#### 2.4.8.7 Modeling Battery Electric Vehicles in the Fleet

A single model was used to represent all battery electric vehicles. This model used an electric drive unit, as shown in Table 2-4, which was resized to match the rated power of each BEV. Like PHEVs, ALPHA simulations over the certification drive cycles track D/C energy consumed from the battery, while certification values reflect the A/C energy required to recharge the vehicle. Thus, the ALPHA D/C cycle simulation results were converted into the equivalent A/C recharging energy required using a ratio of 0.87, based on an average of available vehicle data



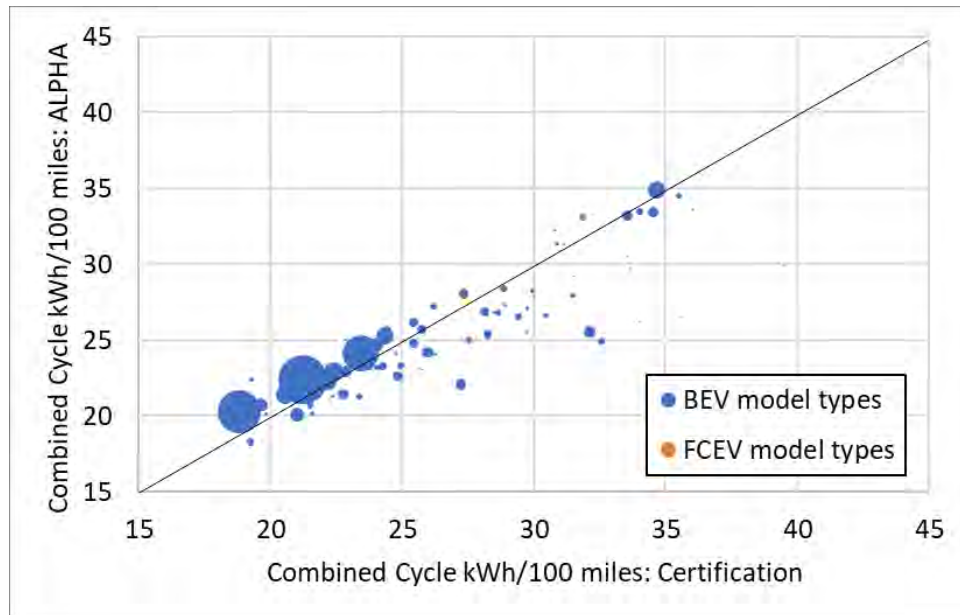
from certification applications for battery electric vehicles. This factor was applied to all BEV simulation results to convert to A/C energy values.

Fuel cell vehicle model types were also simulated using the BEV model. For FCEVs, certification values were converted into an equivalent kWh/100 miles metric to have units comparable to BEVs. For the simulation, a constant fuel cell system efficiency of 57 percent was assumed, based on the fuel cell efficiency at low powers as reported by NREL (NREL 2019). The ALPHA D/C cycle simulation results were converted into kWh/100 miles of hydrogen energy required for each drive cycle using this factor.

Battery electric vehicles were simulated in ALPHA over the UDDS and HWFET cycles, using the parameters in Table 2-13. The D/C kWh/100 miles values from the ALPHA simulation were converted to effective A/C kWh/100 miles values by dividing by the appropriate factor of 0.87 (for BEVs) or 0.57 (for FCEVs). The resulting simulation values were compared to certification values; the production weighted average of the difference is given in Table 2-22. A scatter plot of the ALPHA versus certification values is shown in Figure 2-20.

**Table 2-22: BEVs in the MY 2022 fleet - ALPHA kWh/100 miles values versus certification kWh/100 miles**

|   | <b>UDDS</b>        | <b>HW</b>           | <b>Combined</b>     |
|---|--------------------|---------------------|---------------------|
| Production weighted average kWh/100 miles   | +0.71 kWh/100 mile | +0.13 kWh/100 miles | +0.45 kWh/100 miles |
| Production weighted std. dev. kWh/100 miles | 1.68 kWh/100 miles | 1.48 kWh/100 miles  | 1.52 kWh/100 miles  |
| Production weighted average percent         | +4.1%              | +1.2%               | +2.7%               |
| Production weighted std. dev. percent       | 6.6%               | 5.5%                | 5.9%                |



**Figure 2-20: BEVs in the MY 2022 fleet - ALPHA combined cycle kWh/100 miles values versus certification kWh/100 miles where both BEV and FCEV vehicle model types were simulated using a BEV model and bubble sizes reflect production volumes.**

The production weighted average of the difference between ALPHA simulation and certification consumption values for BEVs was 2.7 percent, or 0.45 kWh/100 miles. For FCEV model types, the ALPHA simulation results were nearly identical, at 2.8 percent or 0.86 kWh/100 miles. Both FCEVs and BEVs are represented in Figure 2-20; however, the small production volume of FCEVs make them difficult to distinguish in the figure.

#### 2.4.8.8 Summary of ALPHA's Ability to Simulate Entire Fleets

After validating the electrified vehicle models using test data from validation vehicles and verifying that the models can simulate similar variant vehicles, the final validation step is to verify that ALPHA can simulate entire vehicle fleets containing a wide range of different powertrain technologies.

Table 2-23 summarizes production weighted average differences between the ALPHA simulations and the certification values for each type of vehicle architecture across the MY 2022 fleet. The close match between ALPHA simulation and certification results verifies ALPHA electrified vehicle models are fit for use in large-scale fleet-wide simulations. For example, the production weighted average difference between ALPHA simulations and certification values across all the vehicle models in the entire MY 2022 fleet was 0.2 percent. An alternative method of comparison, applying equal significance to each vehicle model type in the fleet, results in an unweighted average difference of under 0.1 percent.

**Table 2-23: Summary of ALPHA Simulations vs Certification Values for MY 2022 Fleet**

| Vehicle Type  | ALPHA Model | Production weighted Average Difference Between ALPHA Simulations and Certification Values | Unweighted Average Difference Between ALPHA Simulations and Certification Values |            |
|---|-------------|---|--|------------|
| Entire MY2022 Fleet   | all         | +0.2%   | +0.1%  |            |
| Conventional Vehicles   | CV          | -0.1%   | -0.1%  | Table 2-17 |
| P0/P1 Mild Hybrids  | P0          | +2.9%   | +3.5%  | Table 2-18 |
| PowerSplit & Series-Parallel HEVs and PHEVS (in charge-sustaining mode) | PS          | -1.8%   | -1.2%  | Table 2-19 |
| Parallel P2 HEVs and PHEVS (in charge-sustaining mode)                  | P2          | +5.0%   | +2.1%  | Table 2-20 |
| PowerSplit and Parallel P2 PHEVs (both in charge-depleting mode)        | PS & P2     | -0.8%   | -2.0%  | Table 2-21 |
| Battery Electric Vehicles   | BEV         | +2.7%   | -2.8%  | Table 2-22 |

While on average, the ALPHA simulation values are close to the certification values in this comparison of the entire MY 2022 fleet, there are some differences. There could be several reasons for differences between simulation and actual certification test data due to variability in the certification values, including:

- Certification values contain some variability because they are derived from measured laboratory test data. The typical test-to-test variation of chassis dynamometer testing can be +/-3 percent due to a variety of factors such as different drivers, measurement equipment, fuel, and facilities.
- In addition, for hybrid and PHEV vehicles, certification testing for the MY 2022 fleet followed the recommended practice in the 2010 revision of SAE Standard J1711 (SAE 2010). This standard allows a net energy change in the battery over a test of up to +/-1 percent of the total fuel energy consumed, while (unlike in the ALPHA simulations) the measured CO<sub>2</sub> value is not corrected. Depending on the average efficiency of the engine and electrical system, this variation could alter fuel usage (and CO<sub>2</sub> emissions) by +/-2 percent or even +/-3 percent.

With large numbers of vehicle model types, these variations tend to cancel out (as seen in the modeling of conventional vehicles, which contain by far the largest number of vehicle model types). However, with smaller numbers of vehicle model types, as in the hybrid vehicle models, the variability in certification values may influence the values seen in Table 2-23. This is particularly apparent when just a few vehicles have relatively high production volumes, as seen in the P2 simulations where only five vehicle model types account for half of the total production

volume. In this case, if the unweighted average were used for comparison rather than the production weighted average, the average difference is +2.1 percent rather than +5.0 percent. The noticeable difference between production weighted and unweighted averages demonstrates that most of this variation is caused by the few vehicle model types with the highest total production volumes. A different mix of vehicle model types, or relative production volumes, would likely result in a different average (due to the natural variations in certification test data as discussed above) and thus the differences in Table 2-23 are within the expected range making the ALPHA vehicle models suitable for their ultimate use for estimating current and future fleet-wide emissions.

#### **2.4.9 Peer-Reviewing ALPHA Electrified Models**

After preparing ALPHA 3.0 to correctly simulate electrified vehicles, it was submitted to a peer review process to examine its structure, operation, and simulation results to determine the effectiveness of various vehicle technologies via simulation. The scope of the peer-review was limited to the concepts and methodologies upon which the model relies and whether the model can be expected to execute these algorithms correctly for the new electrified vehicle architectures added to ALPHA. (ICF International 2022)

The peer review is centered on the five vehicle models detailed in Table 2-24. The table summarizes the configuration of each model provided for the peer review. The ETW and road loads provided in the peer review were for a generalized mid-sized car and do not correspond to any particular vehicle in the fleet. The Toyota Atkinson 2.5L engine was chosen based on the base conventional vehicle and maintained for the electrified models to allow the CO<sub>2</sub> performance of each model to be directly compared without the confounding factor of changing engines. The transmission selected was a 6-speed automatic transmission (TRX12) and again maintained for the P0 and P2 models. The PowerSplit, P2, and BEV models (including engine and e-motor scaling) used for the peer review was the same as that described in the chapter above.

**Table 2-24: Details of ALPHA 3.0 models peer reviewed.**

| <b>Model</b> | <b>ETW</b> | <b>Road Load (A, B, C terms)</b> | <b>Engine Component Name</b>                             | <b>Trans</b>         | <b>E-motor/EDU Component Name</b>                            | <b>Engine and E-motor scaling for peer review vehicle</b>  |
|--------------|------------|----------------------------------|--|----------------------|--|--|
| Conv.        | 3500       | 30, 0, 0.02                      | engine_2018_Toyota_A25AFKS_2L5_Tier2.m (scaled to 150kw) | TRX12                | NA   | Engine: power scale  |
| P0           | 3500       | 30, 0, 0.02                      | engine_2018_Toyota_A25AFKS_2L5_Tier2.m (scaled to 150kw) | TRX12                | emachine_2012_Hyundai_Sonata_8p5kW_270V_BISG.m               | Engine: power scale<br>E-motor: power scaling based on engine size (11kw for peer review)        |
| PS PHEV      | 3500       | 30, 0, 0.02                      | engine_2018_Toyota_A25AFKS_2L5_Tier2.m (scaled to 150kw) | Internal to PS model | MG1 and MG2: emachine_2010_Toyota_Prius_60kW_650V_MG2_EMOT.m | Engine: Displacement scaling<br>E-motor: Power scaling based on engine size (MG1 86kw MG2 106kw) |
| P2 PHEV      | 3500       | 30, 0, 0.02                      | engine_2018_Toyota_A25AFKS_2L5_Tier2.m (scaled to 150kw) | TRX12                | emachine_2011_Hyundai_Sonata_30kW_270V_EMOT.m                | Engine: power scale<br>E-motor: power scaling based on engine size (65kw)                        |
| EV           | 4250       | 30, 0, 0.02                      | NA   | 9.5:1 single speed   | emachine_IPM_150kW_350V_EDU.m                                | E-motor: Power scaling based on road load 150kw  |

Each sub-model provided to the peer reviewers was validated against a combination of internally and externally collected vehicle operational data while running the vehicle on a vehicle dynamometer over the EPA city, highway, and US06 regulatory cycles (as described above in Chapter 2.4.7). EPA's approach for validations was to use detailed 10Hz CAN and discrete sensor vehicle benchmarking data to set up the model structure and tune it based on e-motor and battery current and voltage, engine speed and load, battery SOC, etc., to generally achieve within 2-4 percent agreement with the CO<sub>2</sub> measured over the city, highway, and US06 EPA regulatory cycles, as shown in Table 2-8. Once the benchmarking test vehicle validation target was achieved (generally after 3-6 months of work), the validated model was applied to variant vehicles with the same powertrain design from the same manufacturer to achieve within 3-6 percent agreement on CO<sub>2</sub> with EPA certification data over the combined FTP/Highway cycle. Then the validated model was applied to the broader fleet of similar technology hybrid/BEV vehicles to understand the variation in the hybrid/BEV performance (CO<sub>2</sub> g/mile or kWh/mile) across manufacturers.

#### **2.4.9.1 Charge Questions for the ALPHA Peer Review**

- Does EPA's overall approach to the stated purpose of the model (demonstrate technology effectiveness for various fuel economy improvement technologies) and attributes embody that purpose?
- What is the appropriateness and completeness of the overall model structure and its components, such as:
- The breadth of component models/technologies compared to the current/future light-duty fleet.
- The performance of each component model, including the reviewer's assessment of the underlying equations and/or physical principles coded into that component.
- The input and output structures and how they interface with the model to obtain the expected result, i.e., fuel/energy consumption and CO<sub>2</sub> over the given driving cycles.
- The use of default or dynamically generated values to create reasonable models from limited data sets.
- Does the ALPHA model use good engineering judgement to ensure robust and expeditious program execution?
- Does the ALPHA model generate clear, complete, and accurate output/results (CO<sub>2</sub> emissions or fuel efficiency output file)?
- Do you have any recommendations for specific improvements to the functioning or the quality of the outputs of the model?

### **2.4.9.2 Information Received from the Peer Review**

General observations:

- The overall approach to the stated purpose of the model and attributes embodies the goals as outlined.
- ALPHA model's structure and its components are sufficiently appropriate and complete to achieve the stated purpose.
- The output results and output files are labeled appropriately and are relatively complete. The results are generated across log files, console output, and figures, which should provide users with a good amount of summary and detailed results.

In addition to the key themes and comments summarized here, reviewers provided numerous other specific observations and recommendations for the ALPHA model in response to EPA's individual charge questions, as documented in the peer review report (U.S. EPA 2023).

### **2.4.10 Estimating CO<sub>2</sub> Emissions of Future Fleets**

The variety of powertrain components (engines, transmissions, drive types, and electrification architectures) modeled by ALPHA and described in Chapter 2.4.4 produces a range of representative technology options available to manufacturers in the OMEGA model. In total, for the final rule, the OMEGA model considers 542 unique technology combinations for each light-duty vehicle: 360 conventional ICE packages, 120 mild hybrids, 26 hybrids, 33 PHEVs, and 3 BEV combinations.

To estimate CO<sub>2</sub> emissions in future fleets, OMEGA uses a set of response surface equations (RSEs) based on ALPHA simulation outputs (results). To define each RSE, technology packages (consisting of specific combinations of components) were identified. Then, an ALPHA simulation matrix run was created, sweeping vehicle parameters (road loads, vehicle power, and weight) over a defined range so that the RSE could be applied to any vehicle. A unique ALPHA simulation output is created for each vehicle parameter setting of the sweep. When applied over a wide range of road loads and relative power levels, there are an infinite number of possible combinations that can be characterized with response surface equations.

OMEGA also has several MDV technology options - 74 unique technology packages of advanced ICE (gas and diesel) engines, range-extended P2P4 PHEVs, and BEVs - for manufacturers to choose from in the medium-duty sector. Due to requirements for higher load operation for extended periods of time for MDVs, many of the light-duty RSEs (for example: power split hybrids, engines with cylinder deactivation, Atkinson engines, etc.) were not considered candidate technologies for this use case.

#### **2.4.10.1 Technology Packages used to create RSEs for OMEGA**

ALPHA simulation outputs used to create the RSEs consisted of CO<sub>2</sub> emissions or electric energy consumption over each bag of the standard dynamometer cycles, FTP, HWFET, and US06. Each RSE represents the results from simulating a single combination of technologies known as a technology package across different combinations of vehicle parameters. The total number of possible combinations of technologies are shown in Table 2-25, although not all the

technology packages were used to make RSEs. EPA's website contains a copy of the ALPHA output files that were generated to create the RSEs. Those output files contain data about each technology used to create the vehicle technology packages for both light- and medium-duty vehicles. The output files are located on EPA's ALPHA Tool webpage (U.S. EPA 2023a).

The components used to create each **light-duty vehicle technology package** are shown below in Table 2-25.

- For *conventional* and *mild hybrid* (P0) vehicles, powertrain technology packages were created for most combinations of engines and transmissions shown in Table 2-25. SLA RSEs have front-wheel-drive, rear-wheel-drive, and all-wheel-drive variants. HLA RSEs have rear-wheel-drive and all-wheel-drive variants. Finally, for each combination, different packages were created (a) without stop-start technology, (b) with stop-start technology, and (c) with a mild hybrid P0 technology.

For *strong hybrid* vehicles, technology packages were created (PowerSplit HEV, P2 HEV, and SP-P2 PHEV models), using the dedicated hybrid engines in Table 2-25.

Additional technology packages were created for *battery electric vehicles* (BEVs) using the electrification drive unit shown in Table 2-25.

**Table 2-25: List of Technology packages for LDV/LDT RSEs<sup>19</sup>.**

| Engine Name   | Configuration RSE Code                              | Drive RSE Code              | Transmission RSE Code     | Electrification RSE Code               |
|---|---|-----------------------------|---------------------------|--|
| <b>RSEs for Conventional Vehicles:</b>  |   |                             |                           |  |
|   | <b>13</b>   | <b>3</b>                    | <b>5</b>                  | <b>3</b>                               |
| 2013 Chevrolet 2.5L Ecotec LCV Engine Reg E10 Fuel  | GDI<br>(gas direct injection -SLA only)             | FWD                         | TRX10<br>(5-spd)          | SS0<br>(no stop-start)                 |
| 2013 Chevrolet 2.5L Ecotec LCV Engine Reg E10 Fuel + discrete CDA modifier                  | GDI_DEAC_D<br>(GDI+discrete CDA -SLA only)          | RWD                         | TRX11<br>(6-spd)          | SS1<br>(stop-start)                    |
| 2013 Chevrolet 2.5L Ecotec LCV Engine Reg E10 Fuel + continuous CDA modifier                | GDI_DEAC_C<br>(GDI+continuous CDA -SLA only)        | AWD                         | TRX12<br>(6-spd adv)      | P0<br>(48V mild HEV)                   |
| 2018 Toyota 2.5L A25A-FKS Engine Tier 3 Fuel  | ATK<br>(Atkinson -SLA only)                         |                             | TRX21<br>(8-spd)          |  |
| 2018 Toyota 2.5L A25A-FKS Engine Tier 3 Fuel + continuous CDA modifier                      | ATK_DEAC_C<br>(Atkinson+continuous CDA -SLA only)   |                             | TRX22<br>(8-spd adv)      |  |
| 2013 Ford EcoBoost 1.6L Engine Tier 3 Fuel  | TDS11<br>(TDS11:SLA only)                           |                             |                           |  |
| 2016 Honda 1.5L L15B7 Engine Tier 3 Fuel  | TDS<br>(TDS12:SLA only)                             |                             |                           |  |
| 2015 Ford EcoBoost 2.7L Engine Tier 3 Fuel  | TDS<br>(HLA only)                                   |                             |                           |  |
| 2014 Chevrolet 4.3L EcoTec3 LV3 Engine LEVIII Fuel  | GDI<br>(gas direct injection -HLA only)             |                             |                           |  |
| 2014 Chevrolet 4.3L EcoTec3 LV3 Engine LEVIII Fuel + discrete CDA                           | GDI_DEAC_D<br>(GDI+discrete CDA -HLA only)          |                             |                           |  |
| 2014 Chevrolet 4.3L EcoTec3 LV3 Engine LEVIII Fuel + continuous CDA modifier                | GDI_DEAC_C<br>(GDI+continuous CDA -HLA only)        |                             |                           |  |
| Volvo 2.0L VEP LP Gen3 Miller Engine from 2020 Aachen Paper Octane Modified for Tier 3 Fuel | MILLER<br>(Miller)                                  |                             |                           |  |
| 2020 Ford 7.3L  | PFI<br>(gas PFI large bore -HLA only)               |                             |                           |  |
| <b>RSEs Strong Hybrid Vehicles:</b>   |   |                             |                           |  |
|   | <b>6</b>  | <b>3</b>                    | <b>3</b>                  | <b>5</b>                               |
| Toyota 2.5L TNGA Prototype Hybrid Engine from 2017 Vienna Paper Tier 3 Fuel                 | DHE<br>(Atkinson DHE for PS or P2 only-SLA)         | FWD<br>(for PS & P2 only)   | TRX12<br>(for P2 only)    | PS<br>(PowerSplit HEV)                 |
| Geely 1.5L GHE Miller from 2020 Aachen Paper Tier 3 Fuel (PS, P2 only)                      | MILLER<br>(Miller DHE for PS or P2 only)            | RWD<br>(for P2 only)        | TRX22<br>(for P2 only)    | P2<br>(P2 HEV)                         |
| Future 3.6L HLA Hybrid Concept Engine Tier 3 Fuel   | MILLER<br>(Miller DHE for SPP4 only -HLA only)      | AWD<br>(for SPP4 & P2 only) | TRXECVTF<br>(for PS only) | PS_PHEV<br>(PS plug-in HEV)            |
| 2015 Ford EcoBoost 2.7L Engine Tier 3 Fuel  | TDS<br>(for P2 & SPP4 -HLA only)                    |                             |                           | P2_PHEV<br>(P2 plug-in HEV)            |
| 2013 Chevrolet 2.5L Ecotec LCV Engine Reg E10 Fuel  | GDI<br>(for P2 -SLA only)                           |                             |                           | SPP4_HEV<br>(Series-parallel P4 HEV)   |
| 2020 Ford 7.3L  | PFI<br>(gas PFI large bore for P2 & SPP4 -HLA only) |                             |                           | SPP4_PHEV<br>(Series-parallel P4 PHEV) |
| <b>RSEs for Battery Electric Vehicles:</b>  |   |                             |                           |  |
|   |   | <b>3</b>                    |                           | <b>1</b>                               |
|   |   | FWD                         |                           | LDV/LDT BEV<br>EDU                     |
|   |   | RWD                         |                           |  |
|   |   | AWD                         |                           |  |

<sup>19</sup> Table note: combinations are not a factorial of all options (i.e., in some cases some combinations do not apply)



A breakdown of components applied to candidate **medium-duty vehicle technology packages** is shown below in Table 2-26. Medium-duty vehicles, especially pickup trucks, are designed for extended high-load operation which requires a different subset of engines. EPA also modeled the P2P4 PHEV strong hybrid option for medium-duty vehicles.

**Table 2-26: List of Technology packages for medium-duty vans and pickups for RSEs.**

| Engine Name                                       | Configuration RSE Code                  | Drive RSE Code | Transmission RSE Code | Electrification RSE Code |
|---|---|----------------|-----------------------|--------------------------|
| <b>RSEs for Conventional Vehicles:</b>            | <b>3</b>                                | <b>2</b>       | <b>5</b>              | <b>2</b>                 |
| 2020 Ford 7.3L                                    | PFI<br>(gas PFI large bore)             | RWD            | TRX10<br>(5-spd)      | SS0<br>(no stop-start)   |
| Chevy Duramax 3.0L                                | DIESEL<br>(turbo diesel)                | AWD            | TRX11<br>(6-spd)      | SS1<br>(stop-start)      |
| 2015 Ford EcoBoost 2.7L Engine Tier 3 Fuel        | TDS<br>(TDS12:truck)                    |                | TRX12<br>(6-spd adv)  |                          |
|   |   |                | TRX21<br>(8-spd)      |                          |
|   |   |                | TRX22<br>(8-spd adv)  |                          |
| <b>RSEs for Plug-In Hybrid Vehicles:</b>          | <b>3</b>                                | <b>1</b>       | <b>2</b>              | <b>1</b>                 |
| 2020 Ford 7.3L                                    | PFI (gas PFI large bore)                | AWD            | TRX12<br>(6-spd adv)  | MDV_P2P4_REET_PHEV       |
| 2015 Ford EcoBoost 2.7L Engine Tier 3 Fuel        | TDS (TDS12:truck)                       |                | TRX22<br>(8-spd adv)  |                          |
| Future 6.0L HLA Hybrid Concept Engine Tier 3 Fuel | MILLER (Miller dedicated hybrid engine) |                |                       |                          |
| <b>RSE for Battery Electric Vehicles:</b>         |   | <b>3</b>       |                       | <b>1</b>                 |
|   |   | FWD            |                       | LDV/LDT BEV EDU          |
|   |   | RWD            |                       |                          |
|   |   | AWD            |                       |                          |

#### 2.4.10.2 Vehicle Parameter Sweeps for each Technology Package

For each technology package, ALPHA 3.0 was used to provide data with which to construct an RSE. To construct each RSE, a series of ALPHA simulations were performed using the same technology package, but with different combinations of vehicle parameters, so that a single RSE could be used to accurately characterize the performance of a range of different vehicles.

##### 2.4.10.2.1 Swept Vehicle Parameters and Their Values

The vehicle parameters chosen for RSE development directly relate to vehicle parameters used in certification dynamometer testing. These parameters were:

- Equivalent test weight (ETW).
- Road load horsepower at 20 mph, calculated from the target coefficients (this value is substantially dominated by rolling resistance losses).
- Road load horsepower at 60 mph, calculated from the target coefficients (this value is substantially dominated by aerodynamic losses).
- Rated power of primary power source (engine or electric motor).

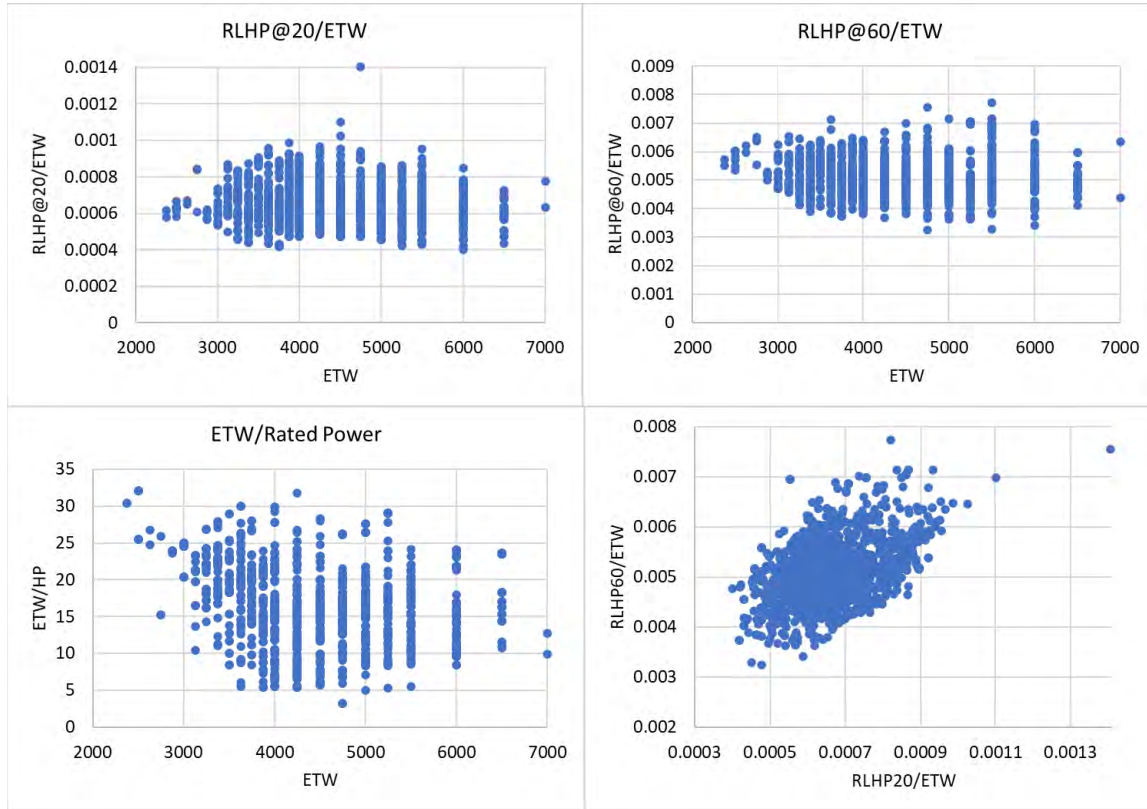
The calculated road loads at 20 mph and 60 mph were chosen to characterize vehicle losses rather than the coefficient of rolling resistance and drag coefficient. The choice of road loads to characterize losses ensures that all road load losses in base year vehicles are correctly accounted for, while the choice of two widely separated speeds gives parameters combinations where road loads dominated by rolling resistance (at low speed) and aero resistance (at high speed) can be separately altered.

In choosing which combinations of parameters to simulate, combinations of parameters that would not appear in the real fleet were avoided. For example, vehicles with very high ETW would not also have low road loads, as both weight and road load are correlated to vehicle size. With that in mind, rather than independently setting the value of each parameter, values of road loads and engine/motor power were chosen to be proportional to ETW. In other words, the parameters set were:

- Equivalent test weight (ETW)
- Road load horsepower at 20 mph / ETW (RLHP@20/ETW)
- Road load horsepower at 60 mph / ETW (RLHP@60/ETW)
- ETW / rated power (ETW/HP)

To determine the ranges of these parameters for light-duty RSEs, the values of ETW, target coefficients, and rated power using the "2021 Test Car List" from EPA's publicly available "Data on Cars used for Testing Fuel Economy" website (U.S. EPA 2022e). As shown in Figure 2-21, ETW values range from 2500 pounds to 7000 pounds, and the values of RLHP@20/ETW, RLHP@60/ETW, and ETW/HP are roughly consistent across the span of ETW.

Additionally, the road loads at 20 mph and 60 mph are related, and thus so are the values of RLHP@20/ETW and RLHP@60/ETW. When choosing parameters to simulate, only combinations of RLHP@20/ETW and RLHP@60/ETW that were near the envelope of points shown in Figure 2-21 were chosen.



**Figure 2-21: Relationships between vehicle parameters for the MY 2021 fleet.**

For each RSE, discrete values of ETW, corresponding to test weight bins, were chosen spanning from 3000 pounds to 10,000 pounds. For each ETW, a matrix of RLHP@20/ETW and RLHP@60/ETW values were chosen which spanned the point cloud shown in Figure 2-21. Combinations of ETW, RLHP@20/ETW, and RLHP@60/ETW that fell outside the range of values in the fleet were eliminated from consideration.

Finally, for conventional vehicles, engine sizes were assigned so that the ETW/HP spanned the values shown in Figure 2-21. The engine sizes for the LD applications were chosen from the displacements listed in Table 2-27; for MD applications only the V6 and V8 configurations were used. For hybrid vehicles, the same set of engine sizes were used. For BEVs, electric motor sizes were chosen in 50kW increments from 50 kW to 500 kW.

**Table 2-27: Engine displacements used in RSE construction.**

| Engine configuration | Displacements    |
|----------------------|------------------|
| I3                   | 1.0L, 1.4L, 1.8L |
| I4                   | 1.6L, 2.2L, 2.8L |
| V6                   | 2.5L, 3.4L, 4.3L |
| V8                   | 4.0L, 5.5L, 7.0L |

#### **2.4.10.2.2 Values of Parameters Used for ALPHA Simulations**

The ALPHA simulation uses various input parameters to set up the vehicle simulation. A batch run was created for each RSE, using the powertrain configuration for that RSE. For each combination of swept vehicle parameters, the powertrain was sized according to the engine displacement or BEV EDU power specified.

The quadratic target coefficients (designated "A," "B," and "C" for the constant, linear, and quadratic term, respectively) were determined using the values of RLHP@20 and RLHP@60. To do so, the linear (B) coefficient was assumed to be 0.22 pounds/mph for LD applications and 0.96 for MD applications, representing the average value for that coefficient in the MY 2021 fleet. The constant (A) and quadratic (C) coefficients were then calculated to give the correct values for RLHP@20 and RLHP@60. Although this method does constrain the range of coefficients generated (as the linear term B is always the same), the resulting quadratic target force curve accurately reflects a wide range of target curves. For example, recalculating the target coefficients of the MY 2021 fleet with this methodology results in a difference between the original and recalculated curves at 40 mph (midway between 20 and 60) of less than 4 percent for over 97 percent of the vehicles.

For hybrid vehicles, the electric machines and batteries used in the RSE ALPHA runs were also scaled. For each hybrid configuration, the electric machine power was maintained as a constant percentage of the engine power.

#### **2.4.10.2.3 ALPHA Simulation Outputs for RSEs**

The ALPHA runs for each RSE consisted of a series of simulations using a single powertrain, but with different combinations of swept parameters. Each run simulated vehicle performance on the FTP, HWFET, and US06 cycles.

For conventional and hybrid vehicles, the ALPHA 3.0 outputs consisted of CO<sub>2</sub> emissions for each phase of each simulated cycle. For electric vehicles, the ALPHA3 outputs consisted of energy usage for each phase of each simulated cycle.

#### **2.4.10.3 Transforming ALPHA Simulation Outputs into RSEs for OMEGA**

The OMEGA model requires a complete set of full-vehicle efficiency simulations for the entire vehicle fleet represented in this rule. To create this full set of simulations using a tool such as the ALPHA model alone would require an unrealistic number of resources as millions of simulation runs would be required to generate the resolution required to satisfy the requirements of the OMEGA model.

To provide the necessary resolution for the OMEGA model while maintaining a realistic number of ALPHA simulations, EPA implemented a peer reviewed (RTI International 2018) Response Surface Methodology (RSM) (Kleijnen 2015). As described above, the inputs to the RSM are a controlled set of ALPHA simulation outputs. The output from the RSM is a set of Response Surface Equations (RSEs) suitable for the OMEGA model.

### 2.4.10.3.1 Steps to Create an RSE from the RSM

For this example, 157 ALPHA model results were generated from FTP CO<sub>2</sub> Bag 1 representing vehicles with GDI engines, Continuous DEAC, TRX21 Transmissions, FWD, and Start-Stop.

Step 1: Compile the ALPHA model results. Table 2-28 contains a sample of the 157 results from Bag 1 CO<sub>2</sub> showing the 4 inputs and the CO<sub>2</sub> output:

**Table 2-28: Sample results.**

| RLHP20  | RLHP60 | HP_ETW   | ETW  | CO <sub>2</sub> |
|---------|--------|----------|------|-----------------|
| 0.0005  | 0.003  | 0.032258 | 3250 | 204.8645        |
| 0.0005  | 0.0065 | 0.032258 | 3250 | 248.2313        |
| 0.00075 | 0.004  | 0.032258 | 4250 | 293.0054        |
| 0.00075 | 0.006  | 0.032258 | 3250 | 254.2941        |
| 0.00075 | 0.006  | 0.032258 | 4250 | 326.5969        |
| 0.001   | 0.005  | 0.032258 | 3250 | 252.8225        |

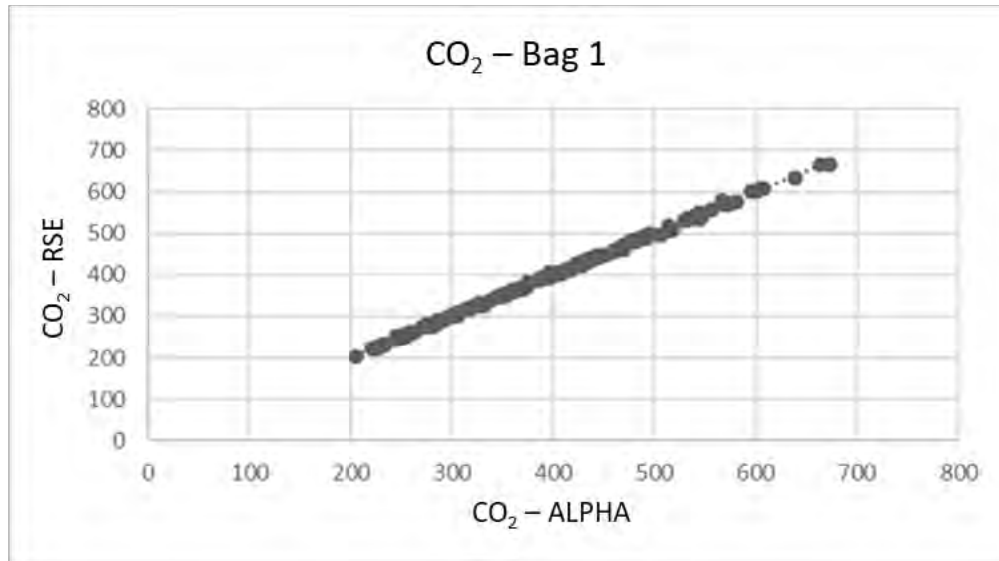
Step 2: Generate the RSE from a commercial or open-source product. EPA utilized the popular open-source Python language (Foundation, Python 2023) including the sklearn library (Foundation, sklearn 2023) to generate the RSE:

$$\begin{aligned} \text{CO}_2\text{-RSE} = & (11.6954329620654 + \text{RLHP20} * -19931.541254933 + \text{RLHP60} * - \\ & 3972.87047794276 + \text{HP\_ETW} * 491.637862683 + \text{ETW} * 3.59189981164081\text{E-}02 + \text{RLHP20} \\ & * \text{RLHP60} * -605147.450118866 + \text{RLHP20} * \text{HP\_ETW} * -114528.849261411 + \text{RLHP20} * \\ & \text{ETW} * 16.4326074843966 + \text{RLHP60} * \text{HP\_ETW} * -14364.8208136198 + \text{RLHP60} * \text{ETW} * \\ & 3.88487044872695 + \text{HP\_ETW} * \text{ETW} * 9.75218337820661\text{E-}02 + \text{RLHP20} * \text{RLHP20} * \\ & 19630639.3025487 + \text{RLHP60} * \text{RLHP60} * 495588.873797923 + \text{HP\_ETW} * \text{HP\_ETW} * \\ & 700.465061662175 + \text{ETW} * \text{ETW} * -7.38489713757848\text{E-}09) \end{aligned}$$

Step 3: Verify the output. Table 2-29 adds an additional column containing the results from the RSE and Figure 2-22 shows all 157 ALPHA results vs 157 RSE results.

**Table 2-29: Tabular results.**

| RLHP20  | RLHP60 | HP_ETW   | ETW  | CO <sub>2</sub> | CO <sub>2</sub> -RSE |
|---------|--------|----------|------|-----------------|----------------------|
| 0.0005  | 0.003  | 0.032258 | 3250 | 204.8645        | 203.0853             |
| 0.0005  | 0.0065 | 0.032258 | 3250 | 248.2313        | 247.1682             |
| 0.00075 | 0.004  | 0.032258 | 4250 | 293.0054        | 294.2893             |
| 0.00075 | 0.006  | 0.032258 | 3250 | 254.2941        | 252.7991             |
| 0.00075 | 0.006  | 0.032258 | 4250 | 326.5969        | 327.4422             |
| 0.001   | 0.005  | 0.032258 | 3250 | 252.8225        | 254.8888             |



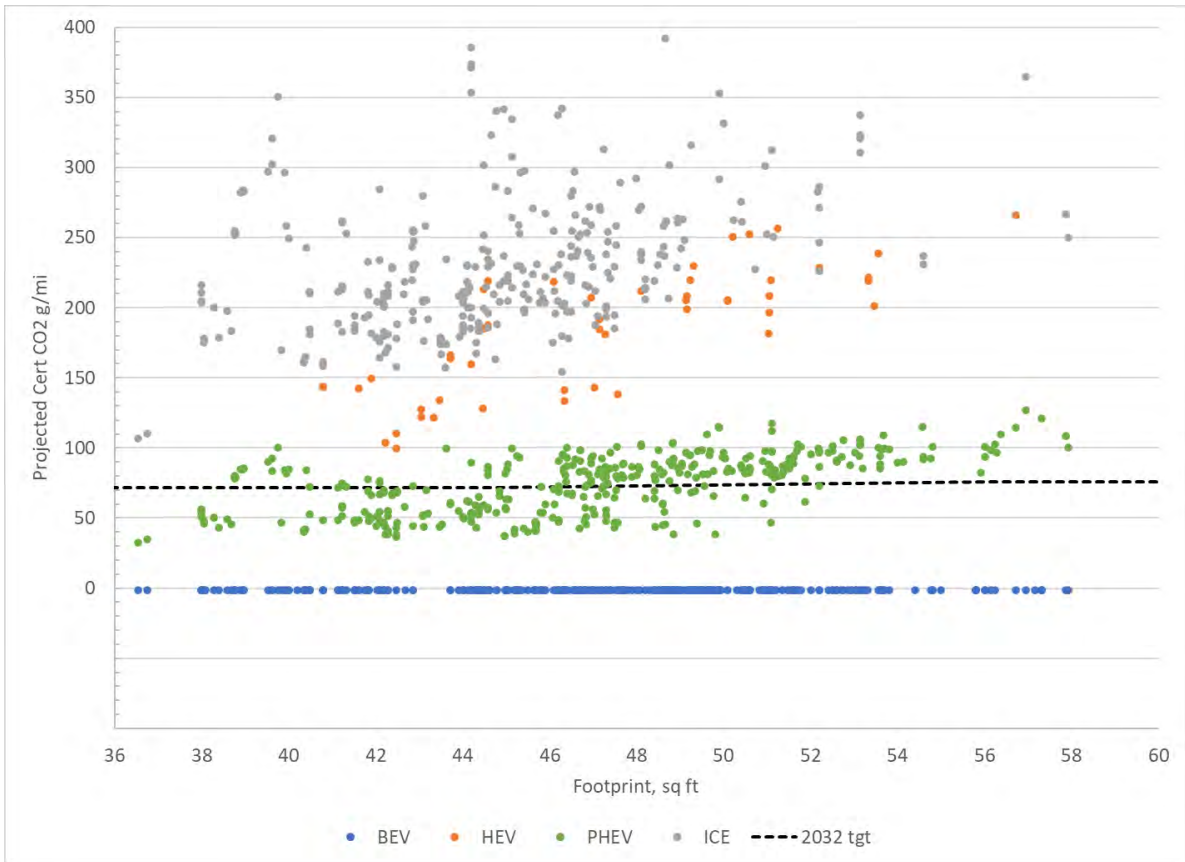
**Figure 2-22: Graphical results.**

The validated RSE can now be used by the OMEGA model to generate a CO<sub>2</sub> value (or energy consumption rate, for BEVs) for any vehicle within the range of the controlled set of ALPHA model simulation results. Utilizing the RSM results in a reduction of simulation and storage resources by approximately a factor of 100.

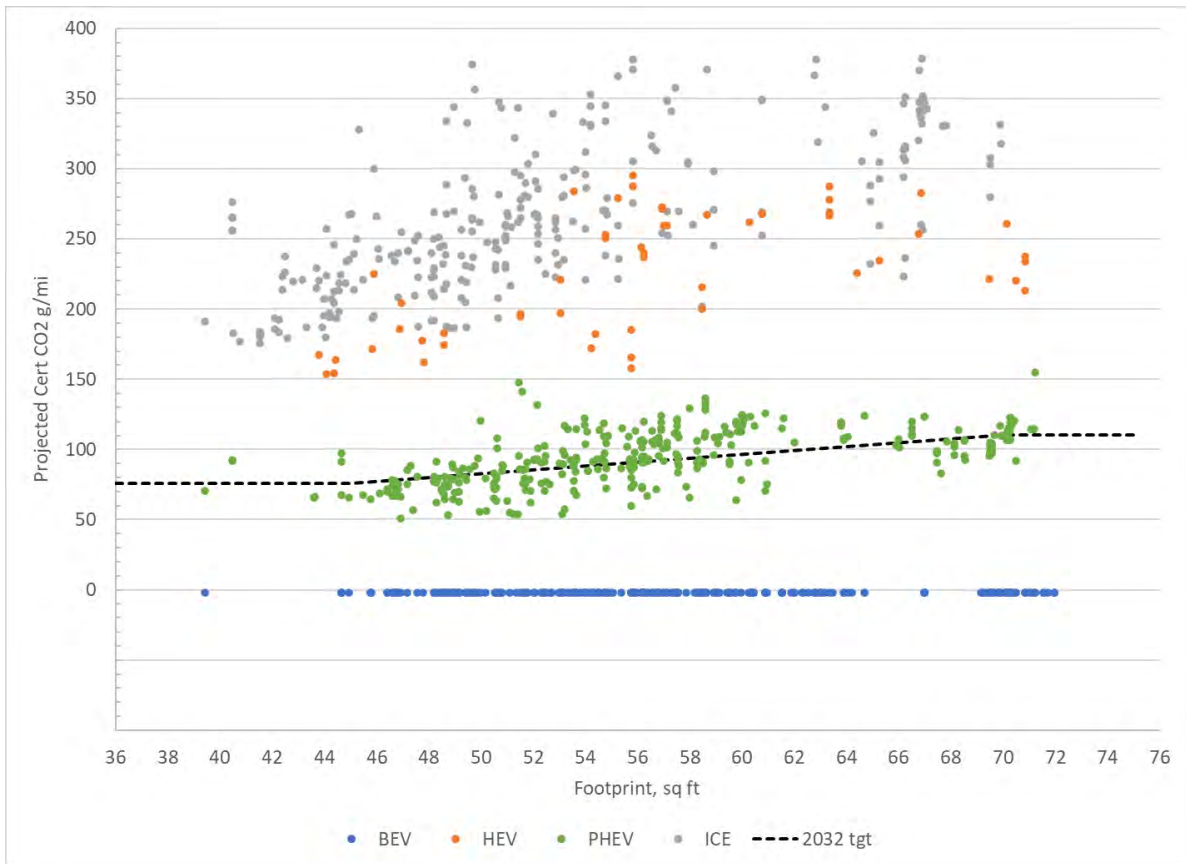
**2.4.11 Illustration of Vehicle-specific CO<sub>2</sub> Performance Compared to Footprint CO<sub>2</sub> Targets**

Because the standards are performance based, improvements in all vehicle and powertrain technologies will contribute to a vehicle manufacturer's compliance.

Below, we show an example of projected vehicle-specific OMEGA compliance CO<sub>2</sub> levels (in g/mi), for the range of technology RSEs generated from ALPHA applied to the base year fleet in MY 2032. Figure 2-23 and Figure 2-24 show the projected g/mi for MY 2032 cars and light trucks, respectively, in comparison to the final standards footprint-based targets. These plots are intended to illustrate the variety of technologies and vehicle compliance levels which exist in the central case modeling results. Together, the combination of these vehicles represents one possible compliance path for the industry, although the individual firms (and the industry as a whole) may choose alternative combinations of technologies to comply with the standards.



**Figure 2-23: MY 2032 Projected Vehicle Compliance Levels vs. Targets under Final Standards - Cars**

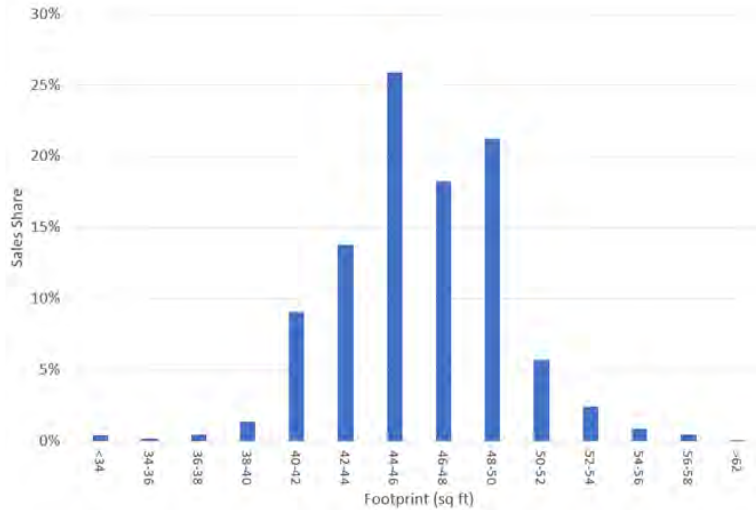


**Figure 2-24: MY 2032 Projected Vehicle Compliance Levels vs. Targets under Final Standards - Trucks**

As can be seen, PHEVs, as modeled<sup>20</sup>, are generally clustered around the individual vehicle footprint-based targets, with some models above the targets and some below. PHEVs with varying levels of all-electric range could have compliance CO<sub>2</sub> levels higher or lower than these projections. The figures also do not include the effect of sales weighting, nor do they preclude any specific vehicle model from being part of a compliant fleet, as compliance is determined on a fleetwide basis. For example, the distribution of car sales, by footprint, provided in Figure 2-25 shows that 97% of all car sales in MY 2032 are projected to have footprints of 52 square feet or less. Figure 2-23 then supports EPA's judgment that, for at least the vast majority of the light duty fleet, there exists a PHEV technology option that could meet each vehicle's individual footprint-based target, and thus the industry could meet the final standards with only PHEVs.

<sup>20</sup> As we describe in Chapter 2.6.1.7 of this RIA, light-duty vehicle PHEV batteries were sized and modeled to provide 40 miles of all-electric range capability over the US06 test.





**Figure 2-25: Distribution of Car Sales by Footprint, MY 2032 Vehicles**

Chapter 12 of this RIA provides details of our projections of modeled technology penetrations and fleet CO<sub>2</sub> compliance levels compared to the final standards.

## 2.5 Cost Methodology

EPA has developed several new approaches to estimating technology costs relative to our past GHG and criteria emission analyses. We describe those new approaches here. Despite our new approaches, we continue to first estimate direct manufacturing costs and apply to those costs the well understood learning-by-doing methodology to estimate how those costs are expected to change going forward (U.S. EPA 2016). We then apply established markups to those direct manufacturing costs to estimate the indirect costs (e.g., research, development, etc.) associated with the technology. We provide more detail here in Chapter 2.5 and in Chapter 2.6.

### 2.5.1 Absolute vs. incremental cost approach

Powertrain costs used in OMEGA are based on a combination of prior GHG and/or criteria air pollutant rulemaking analyses (e.g., EPA's LD Tier 3 rule), and on new work. However, in contrast to previous rulemaking analyses, all costs used in this analysis are expressed as cost curves rather than as discrete costs for specific pieces of technology. More importantly, costs are now determined as absolute costs rather than incremental costs and geared toward generating full vehicle costs rather than the incremental costs considered in previous analyses. That is, when the cost of a new piece of technology or package of technologies is assigned, it is in terms of its absolute cost instead of the incremental cost relative to the older or less capable piece of technology or package of technologies that it replaces. This is an important aspect of the OMEGA technology costs because OMEGA now incorporates a consumer choice element. This means that the impacts of, for example, a \$40,000 BEV versus a \$35,000 ICE vehicle of similar utility (i.e., a 14 percent increase for the BEV) is a much different consideration than a \$6,000 incremental BEV cost versus a \$1,000 incremental ICE cost (a 500 percent increase for the BEV). This perspective change more accurately reflects the consumer's consideration of options.

## **2.5.2 Direct manufacturing costs**

### **2.5.2.1 Battery cost modeling methodology**

For this final rule, EPA updated the battery cost inputs to OMEGA. In the proposal analysis, EPA had used ANL BatPaC 5.0 to develop base year (MY 2022) battery costs, expressed as a cost per kWh as a function of battery gross energy capacity (kWh). Costs for future years were then estimated by applying a cost reduction due to learning, based on cumulative Gigawatt-hours (GWh) of battery production necessary to supply the number of BEVs that OMEGA placed in the analysis fleet up to that analysis year.<sup>21</sup> Finally, we applied additional cost reductions based on our assessment of the future impact of the 45X cell and module production tax credit provisions of the Inflation Reduction Act.

For this final rule analysis, we considered public comments that addressed the battery costs and costing methodology used in the proposal. We also proceeded with additional study and consideration of sources and planned new work that we described in the proposal. As a result, we have made a number of updates to our battery cost estimates. These changes and the reasons for them are discussed in more detail in Section IV.C.2 of the Preamble to the rulemaking. The remainder of this chapter describes how battery costs were developed for the final rule analysis.

#### **2.5.2.1.1 Battery sizing**

Battery cost is an important input to the compliance analysis, which is performed using the OMEGA model. When placing a PEV into the analysis fleet, the OMEGA model determines the gross battery capacity (kWh) that the vehicle will require, based on its energy consumption (kWh/mi), range target (mi), and other requirements. The direct manufacturing cost for a pack of that capacity in a given year of the analysis is then estimated by use of a battery cost equation (for 2023 through 2035) and a 1.5 percent reduction per year past 2035. The resulting battery cost estimate becomes a term in the total direct manufacturing cost of the vehicle.

Determining the correct gross battery capacity is important because this determines the energy consumption of the vehicle (which is in turn a result of battery weight) and also battery cost. Gross battery capacity is generally a function of the desired electric driving range (a discussion of OMEGA assumptions for BEV and PHEV ranges are provided in sections 2.6.1.6 and 2.6.1.7), the maximum fraction of gross battery capacity that is usable during a range test (usable battery energy (UBE) fraction, in percent), and the on-road direct current (DC) energy consumption of the vehicle. The driving range for BEVs is assumed to be 75 percent of the 55/45 2-cycle range which is consistent with higher volume BEVs in the market today and which we expect to be more representative of future PEVs.<sup>22</sup> Usable energy fraction is set at 0.95 for BEVs and 0.75 for PHEVs.<sup>23</sup> DC energy consumption is the average amount of on-road DC energy required from the battery per mile driven on the relevant cycles. Note that this is not the same as the energy consumption reported in the Fuel Economy guide, which includes charging losses incurred between the grid power outlet and the battery. Charging losses are important for calculating upstream emissions but must be excluded for battery sizing because battery capacity

---

<sup>21</sup> The use of cumulative GWh of battery production as an input to the learning cost reduction was new to the proposal for this rule.

<sup>22</sup> While it varies by model, the current FE label range for BEVs is between 70-75 percent of the 2-cycle range.

<sup>23</sup> HEV usable energy fraction is set at 0.50.

for a given range is a function of DC energy consumption. DC energy consumption is derived from a precomputed response surface generated by ALPHA results, using curb weight and other vehicle attributes as inputs to the response surface. Curb weight is intimately tied to battery capacity, via the effect of battery weight on total vehicle weight. This requires an iterative process that OMEGA must perform in order to determine curb weight simultaneously with arriving at the necessary battery size.

In the first step, OMEGA calculates the on-road DC energy consumption (Wh/mi) as a function of vehicle parameters including curb weight (which includes a battery weight determined by later steps). Next it estimates gross battery capacity, using DC energy consumption, driving range, and usable energy fraction, according to the formula:

$$(Wh)_{Gross\ Capacity} = \left( \frac{Wh}{mi} \right)_{DC\ energy\ consumption} \times \frac{driving\ range\ in\ miles}{usable\ energy\ fraction}$$

Next it estimates battery weight, using estimated gross capacity required (Watt-hours or Wh) and a specific energy (Wh/kg) assigned to the given year of the analysis based on the 2023 ANL battery costing study:

$$(kg)_{Battery\ Weight} = \frac{(Wh)_{Gross\ Capacity}}{Wh/kg}$$

Finally, it returns to the first step with the new battery weight, until the battery weight stops changing (converges).

### 2.5.2.1.2 Battery costs for 2023 to 2035

To begin estimating cost for a pack in a given year of the analysis, OMEGA first requires battery cost to be input as a pack-level cost per kWh, as a function of its gross capacity in kWh and the model year.

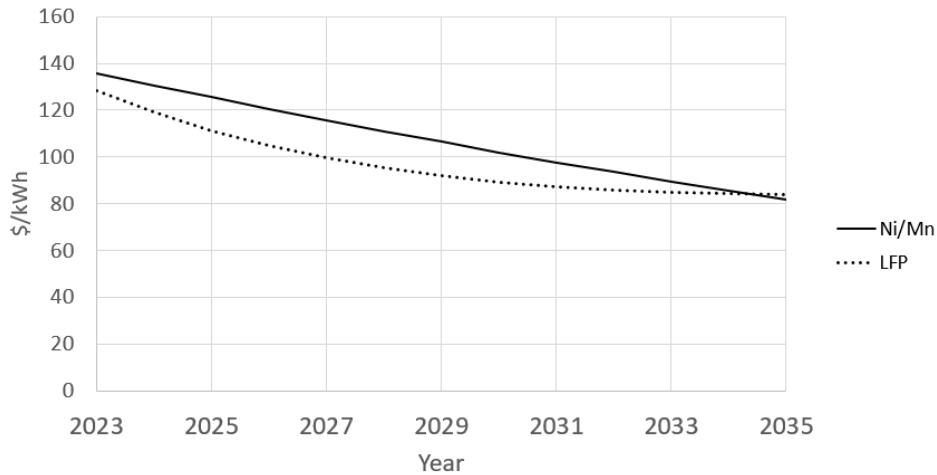
As described in Preamble IV.C.2, input cost functions for Nickel-Manganese (Ni/Mn, including NMC) and Iron phosphate (LFP) cathode chemistries were developed by Argonne National Laboratory for reference by EPA and NHTSA in their respective rulemakings (ANL 2024). This work by ANL used the latest version of the BatPaC model and included a set of custom inputs representing expected mineral prices over time (as forecast by Benchmark Mineral Intelligence), and advancements in chemistry and manufacturing according to a technology roadmap for 2023 to 2035 developed by ANL battery scientists. The resulting equations are correlations of a larger data set across many battery specifications and capacities. They express pack cost as a function of kWh and model year. The battery pack cost correlation equations, as shown below, employ a different set of coefficients for each of PEV Ni/Mn, PEV LFP, and HEV batteries; the variables *x* and *y* correspond to pack energy and model year, respectively.

$$$/kWh = A + \frac{B}{x^C} - D(y - 2023)e^{E(y-2023)}$$

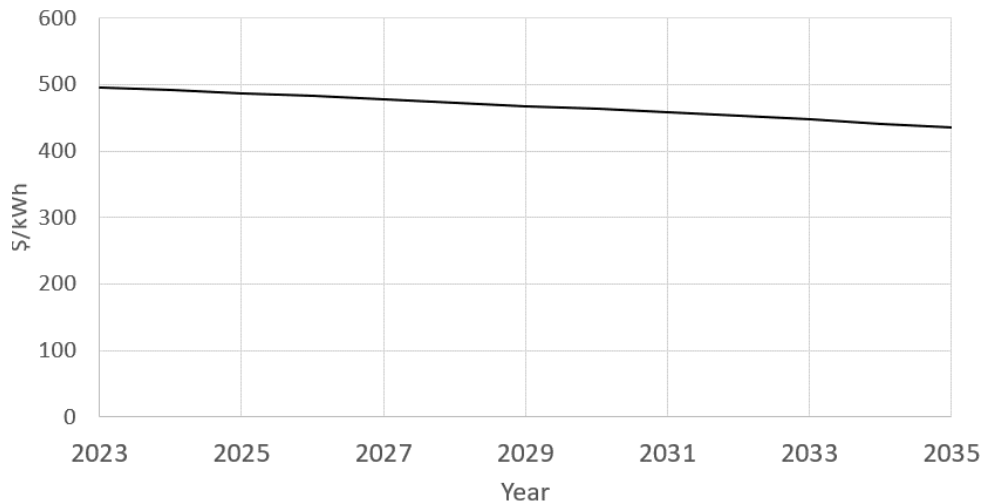
**Table 2-30: ANL cost equation coefficients for HEV and PEV batteries (\$50/hr labor).**

| Battery pack chemistry and application | A     | B     | C      | D     | E        |
|--|-------|-------|--------|-------|----------|
| Ni/Mn for HEV (5kWh or less)           | 122.9 | 509.6 | 0.7649 | 4.443 | 0.01018  |
| Ni/Mn for PEV                          | 128.9 | 1480  | 1.164  | 5.278 | -0.0129  |
| LFP for PEV                            | 120.6 | 1535  | 1.148  | 10.04 | -0.08346 |

Figure 2-26 and Figure 2-27 show examples of how these equations characterize the direct manufacturing cost for PEV and HEV batteries from 2023 to 2035, using an example of a 100 kWh and 1.5 kWh pack, respectively.



**Figure 2-26: NMC and LFP PEV battery pack direct manufacturing cost (100 kWh example).**



**Figure 2-27: Ni/Mn HEV battery pack direct manufacturing cost (1.5 kWh example).**

Specific energy (Wh/kg) of a battery pack has an indirect effect on battery cost in its determination of the weight of the battery and hence the amount of battery energy necessary to

meet a given range target. The ANL work to project future costs of battery packs also extended to the specific energy of the pack, which is reported by BatPaC in addition to the cost and other results. EPA is using the equation and coefficients in the table below.

$$Wh/kg = 1000 \left[ A + \frac{B}{x^C} - D(y - 2023)e^{E(y-2023)} \right]^{-1}$$

**Table 2-31: ANL cost equation coefficients for HEV and PEV batteries.**

| Battery pack chemistry and application | A     | B      | C     | D      | E        |
|--|-------|--------|-------|--------|----------|
| Ni/Mn for HEV (5kWh or less)           | 5.22  | 13.398 | 0.941 | 0.359  | -0.081   |
| Ni/Mn for PEV                          | 5.266 | 20.6   | 1.129 | 0.3537 | -0.08158 |
| LFP for PEV                            | 6.602 | 26.62  | 1.016 | 0.3597 | -0.09757 |

More information about the inputs and assumptions for the ANL study are available in the ANL report (ANL 2024).

For PEV batteries, the input costs to OMEGA are a weighted average of the ANL cost equations for Ni/Mn and LFP cathode chemistries. Specific energy is weighted in the same way. To determine an appropriate share of LFP vs. NMC, we worked in conjunction with NHTSA. Each agency consulted subscription forecasts of future LFP market share, EPA referring to available data from Benchmark Mineral Intelligence (BMI) and NHTSA referring to available data from Rho Motion. EPA's BMI access included a forecast of U.S. and North American cathode powder production, and NHTSA's Rho Motion access included a forecast of battery chemistry usage in future U.S. BEVs and PHEVs. EPA and NHTSA consider cathode powder production and forecast battery usage in vehicles to represent two relevant perspectives on the matter of future representation of LFP in the U.S. vehicle battery market. Both forecasts describe a similar scenario in which LFP share rises for several years and levels off over time. We worked with NHTSA to arrive at a generalized year by year estimate of LFP share potential by averaging the forecasts of the two sources and smoothing the resultant curve.

Table 2-32 shows the result, indicating a gradual rise in LFP share from 2023 to 2029, leveling off afterward at just under 20 percent. Representing gradual growth in share of LFP in this way is consistent with public comments contending that rapid growth in battery demand may place pressure on supplies and prices of critical minerals, as LFP is significantly less exposed to these risks due to the absence of cobalt, nickel, and manganese.

**Table 2-32: U.S. PEV battery cathode chemistry market projections, 2023 to 2035.**

| Year | LFP share | Ni/Mn share |
|------|-----------|-------------|
| 2023 | 8%        | 92%         |
| 2024 | 10%       | 90%         |
| 2025 | 16%       | 84%         |
| 2026 | 17%       | 83%         |
| 2027 | 18%       | 82%         |
| 2028 | 19%       | 81%         |
| 2029 | 19%       | 81%         |
| 2030 | 19%       | 81%         |
| 2031 | 19%       | 81%         |
| 2032 | 19%       | 81%         |
| 2033 | 19%       | 81%         |
| 2034 | 19%       | 81%         |
| 2035 | 19%       | 81%         |

As described in Preamble IV.C.2, to represent the possible effect of temporarily elevated mineral prices on battery cost in the short term, for the years 2023 through 2025 we kept battery costs at the same level as for 2023. We note that since the 2021 rule, it has become increasingly clear that mineral costs have risen sufficiently to interrupt historical trends of continuous battery cost reduction. For example, the BNEF 2021 battery price survey indicated that the pace of reduction had slowed considerably and predicted that costs may not reach \$100/kWh (at pack level) until 2024. The next year, the BNEF 2022 battery price survey reported that costs had increased by 7 percent over the previous year, for the first time since the survey has been conducted. At that time, elevated prices appeared likely to persist for some amount of time due to increased mineral prices.

In late November 2023, the 2023 BNEF battery price survey indicated that battery prices had resumed their downward trend, dropping 14 percent from 2022. EPA considered whether or not this development warranted removal of the 2023 to 2025 cost plateau for the FRM analysis. In consultation with DOE, ANL, and NHTSA, we decided to keep the plateau due to the prospect for continued uncertainty in the short term regarding mineral prices. Since that decision was made, we note that leading analyst firms continue to predict a sustained reduction in most mineral costs through at least 2027, further suggesting that the plateau represents a conservative assumption.

Also as described in Preamble IV.C.2, because the ANL cost equations define costs for future years from 2023 through 2035, we discontinued our practice from the proposal of deriving these costs by means of a learning curve equation.

More discussion of the OMEGA model and the OMEGA results can be found in Preamble IV.C and elsewhere in this RIA. For additional discussion of the battery costing method and

sources considered, and a comparison between the battery costs derived in this analysis and those of the proposal, see Preamble Section IV.C.2.

### **2.5.2.1.3 Battery costs for 2036 to 2055**

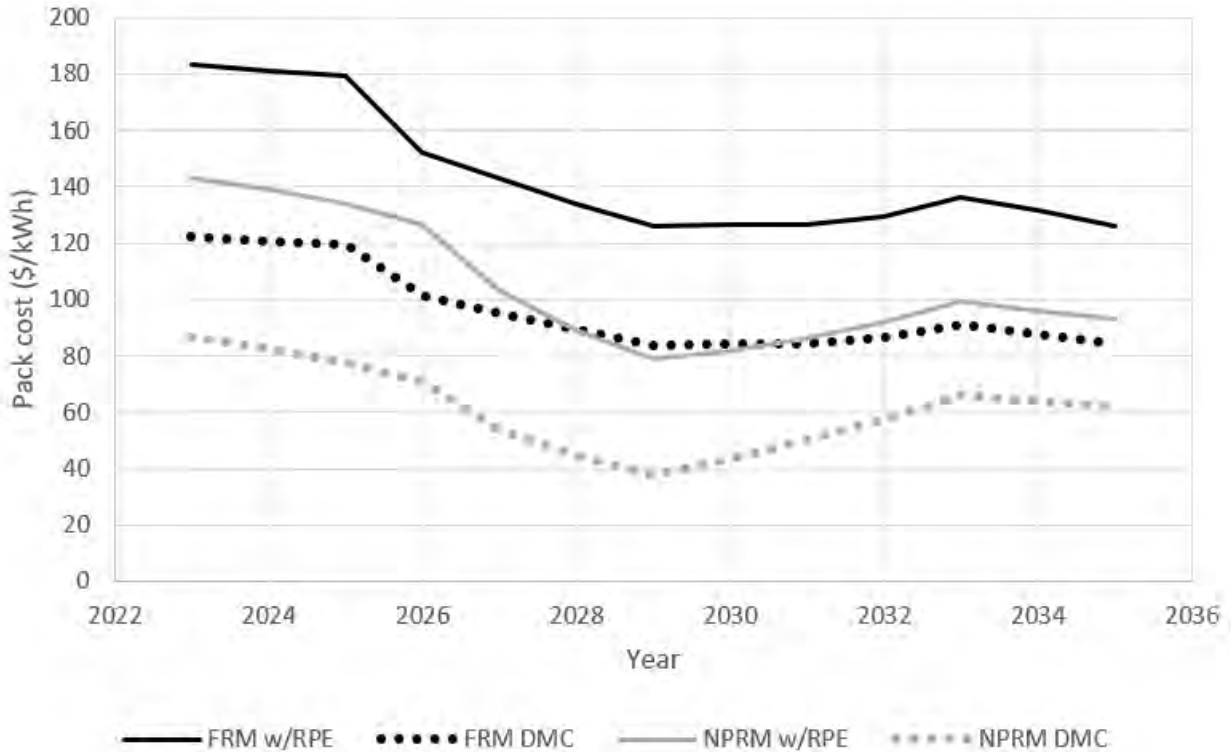
The ANL equations are limited to projecting battery pack costs from 2023 to 2035. Beyond 2035, such long-term estimates are by their nature more uncertain than shorter-term estimates and are difficult to model by assuming a specific technology roadmap. Often, analysts model costs over the longer term by applying an annual percentage cost reduction rate. We adopted this approach for the years after 2035, applying a 1.5 percent per year reduction, which results in a decline to about \$60/kWh by 2055. Note that we apply this 1.5 percent per year reduction regardless of whether it is the No Action or Action policy scenario being run in OMEGA. For more discussion of the rationale for this learning rate, see Preamble IV.C.2.

### **2.5.2.1.4 Battery cost reductions due to Inflation Reduction Act**

To reflect the anticipated effect of the Inflation Reduction Act on battery costs to manufacturers, we applied a further cost reduction based on the Section 45X Advanced Manufacturing Production Tax Credit. This provision of the IRA provides a \$35 per kWh tax credit for manufacturers of battery cells, and an additional \$10 per kWh for manufacturers of battery modules, as well as a credit equal to 10 percent of the manufacturing cost of electrode active materials and another 10 percent for the manufacturing cost of critical minerals (all applicable to manufacture in the United States). The credits, with the exception of the critical minerals credit, phase out from 2030 to 2032.

Since the proposal, work was conducted by DOE and ANL to assess the rate of growth and likely operating capacities of North American battery manufacturing plants announced or under construction and relate this data to the likely access to 45X credits across the PEV fleet. This work is cited and discussed in Section IV.C.2 of the preamble. For the purpose of modeling, we conservatively estimated an average credit amount per kWh that can be realized across the industry as a whole in each year from now until 2032. Section 2.6.8 of the RIA shows the estimated yearly average credit amounts for 45X that were input to OMEGA. For a full discussion of how EPA determined which 45X credits would be modeled and the values used in OMEGA, see the preamble at section IV.C.2.

Figure 2-28 shows an example of the resulting effect on average pack direct manufacturing costs (DMC) generated by OMEGA in the central case of the proposal, after application of the 45X credit. The 45X cell and module credits per kWh were applied not to the direct manufacturing cost per kWh, but to the marked-up cost per kWh (that is, after multiplying the direct manufacturing cost by the 1.5 retail price equivalent (RPE)). Because RPE is meant to be a multiplier against the direct manufacturing cost, and the 45X credit does not reduce the actual direct manufacturing cost at the factory but only compensates the cost after the fact, it is most appropriate to apply the 45X credit to the marked-up cost. The 45X cell and module credits per kWh were applied by first marking up the direct manufacturing cost by the 1.5 RPE factor to determine the indirect cost (i.e., 50 percent of the manufacturing cost), then deducting the credit amount from the marked-up cost to create a post-credit marked-up cost. The post-credit direct manufacturing cost would then become the post-credit marked-up cost minus the indirect cost.



**Figure 2-28: Volume weighted average pack direct manufacturing cost and marked-up cost per kWh after application of 45X credit.**

EPA did not apply a further cost reduction to represent the 10 percent electrode active material or critical mineral production credits that are also available under 45X. Rationale for this decision may be found in Section IV.C.2 of the preamble. The implementation of battery costs as OMEGA inputs is described in Chapter 2.6.1.4 of this RIA for HEVs and Chapter 2.6.1.5 of this RIA for BEVs and PHEVs.

### 2.5.2.2 Non-Battery Cost Approach

For non-battery powertrain costs that were used in the proposed rule, EPA referred to a variety of industry and academic sources, focusing primarily on teardowns of components and vehicles conducted by leading engineering firms. For the final rule, we have largely updated these costs with information from the FEV teardown and related work performed by FEV to review the costs we had used in the proposal and develop scaling factors suitable for estimating costs for different vehicle types across the analysis. The latter of this work is discussed in the next section. In this section we primarily review the types of sources that EPA typically relies upon for determining direct manufacturing costs in this and previous analyses.

The equations used in OMEGA for the non-battery electrified vehicle cost estimates used in this final rule analysis may be found in Chapter 2.6 of this RIA.

While EPA relies on a variety of sources to establish direct manufacturing costs for vehicle components, we have long considered teardown studies to be the preferred means for doing so. EPA has previously estimated non-battery costs by commissioning teardown studies of early-



stage EV technologies. For past rulemakings, we contracted with FEV North America to conduct teardowns of electrified vehicle components that were available at the time in order to establish direct manufacturing costs under high-volume production in a rigorous and transparent way.

Since then, the ongoing evolution of electrified vehicles has led to the emergence of improved or entirely new components that benefit from improved manufacturing efficiencies, component integration, and platform optimization. These developments call for ongoing updates to the way we characterize and quantify vehicle costs. For example, in some cases, specific components that we costed in the past may have become integrated with other components, or their design has changed so they use less costly materials or can be manufactured in a more efficient way. The vehicle platforms that incorporate these components may also have changed to optimize their integration with the rest of the vehicle.

Third-party teardowns of vehicles and components have become more widely available from a number of engineering firms, and at times we have consulted these sources to augment our commissioned work. For example, to develop the costs that were used in the proposal to this rule, EPA acquired several commercial teardown reports to inform these changes and to represent the manufacturing cost of today's electrified vehicle components as accurately as possible (Munro and Associates 2020a) (Munro and Associates 2021) (Munro and Associates 2020b) (Munro and Associates 2016) (Munro and Associates 2020c) (Munro and Associates 2018). EPA then worked jointly with CARB to analyze the data in these reports.

As previously described in the proposal to this rule, we also commissioned a new full-vehicle teardown of two vehicles with FEV North America and have now completed this work (FEV Consulting Inc. 2022). FEV tore down a 2021 Volkswagen ID.4 BEV and a 2021 Volkswagen Tiguan, an ICE vehicle relatively equivalent to the ID.4 in size and function. This work has also undergone peer review.

This project was initiated in part due to the realization that platform optimization is likely to affect a variety of cost comparisons between ICE and BEV vehicles. For example, platform optimization, particularly for BEVs, could potentially lead to differences in indirect costs that are experienced by the manufacturer (such as assembly cost, certification cost, and calibration cost). We also considered that the differences between a platform-optimized BEV and a platform-optimized ICE vehicle might call for an absolute costing approach, instead of assuming that a BEV can be costed as an ICE vehicle with ICE components removed and BEV components added.

The study was therefore designed not only to provide an additional source for vehicle component cost data, but also to inform several issues that are commonly cited with regard to the difference in cost between conventional and battery electric vehicles. Because ICE vehicles and BEVs are likely to be built on different dedicated platforms, the study was designed as a ground-up study for which a complete costed bill of materials would be developed for every component of each vehicle, including structural and other non-powertrain components. This would support our intention to move to a costing regime based on absolute vehicle costs instead of relative or incremental costs (as previously described in 2.5.1), and to allow comparisons to be made on a vehicle-system basis to identify significant potential cost efficiencies attributable to a dedicated BEV platform. FEV was also asked to comment on potential differences in indirect costs for BEV design, certification, and calibration that might become apparent on a close inspection of the components, their system integration, and their assembly characteristics. We also specified

that a detailed labor assessment be performed for each component, in order to shed light on differences in amount and type of assembly labor required for production. An additional task under this work assignment was to evaluate the non-battery HEV and PEV costs EPA has described under RIA Section 2.6.1, with respect to the cost values used and the method of scaling these costs across different vehicle performance characteristics and vehicle classes.

Delivery of the primary teardown study results by FEV occurred in February 2023 and a peer review was completed in mid-2023.

An additional FEV review of EPA's non-battery costs and scaling recommendations was made available in a memo to the docket entitled "EV Non-Battery Cost Review by FEV." Additional reports and presentations on this work have since been placed in the docket (Cherry and Sherwood 2023). Through this work, we have updated our powertrain cost inputs for ICE vehicles as well as non-battery costs for electrified vehicles.

### **2.5.2.3 Powertrain Cost Scaling Exercise for ICE, HEV, PHEV, and all Electrified Vehicle Non-Battery Costs**

As noted in a docket memorandum, EPA contracted FEV to conduct a scaling exercise to develop up-to-date powertrain cost curves that could be used as inputs to OMEGA. (Cherry and Sherwood 2023) As a result of that effort, we have updated nearly all of our powertrain costs, including the non-battery technologies used in BEV, PHEV, and HEV powertrains. Chapter 2.6.1 of this RIA presents all of those new powertrain cost curves. In general, the updated cost curves result in lower powertrain costs for nearly all powertrain technologies, with ICE powertrain costs being reduced somewhat more than those for electrified powertrains. As a result, the incremental costs when moving from ICE-only to any electrified powertrain have increased somewhat since the NPRM. Importantly, the scaling effort provided ICE, HEV, PHEV, and BEV powertrain costs that were generated using the same methodology.

### **2.5.3 Approach to cost reduction through manufacturer learning**

Within OMEGA, learning factors are applied to technology costs as shown in Table 2-33. These learning factors were generated with the expectation that learning on ICE body structure technologies would slow, relative to their traditional rates, in favor of a focus on HEV, PHEV, and BEV technologies.

Importantly, the learning factors shown are multiplicative scaling factors indexed to 2022. The costs presented below in Chapter 2.6 represent first year costs and the learning factors shown in Table 2-33 are applied to those first-year costs to arrive at costs for subsequent years.

Learning applied to BEV, PHEV, and HEV battery costs in MY 2036 and later was done as described in Chapter 2.5.2.1.3.

**Table 2-33: Learning Factors Applied in OMEGA, Indexed to 2022<sup>a</sup>.**

| Model Year | Traditional ICE Powertrain & All Glider Costs | HEV, PHEV & BEV Non-Battery Costs and Non-Traditional ICE Powertrain Costs |
|------------|---|--|
| 2022       | 1.00  | 1.00   |
| 2023       | 1.00  | 0.86   |
| 2024       | 0.99  | 0.79   |
| 2025       | 0.99  | 0.74   |
| 2026       | 0.99  | 0.70   |
| 2027       | 0.98  | 0.67   |
| 2028       | 0.98  | 0.65   |
| 2029       | 0.98  | 0.63   |
| 2030       | 0.97  | 0.61   |
| 2031       | 0.97  | 0.59   |
| 2032       | 0.97  | 0.58   |
| 2033       | 0.96  | 0.57   |
| 2034       | 0.96  | 0.56   |
| 2035       | 0.96  | 0.55   |
| 2036       | 0.95  | 0.54   |
| 2037       | 0.95  | 0.53   |
| 2038       | 0.95  | 0.52   |
| 2039       | 0.95  | 0.51   |
| 2040       | 0.94  | 0.51   |
| 2041       | 0.94  | 0.50   |
| 2042       | 0.94  | 0.50   |
| 2043       | 0.94  | 0.49   |
| 2044       | 0.93  | 0.49   |
| 2045       | 0.93  | 0.48   |
| 2046       | 0.93  | 0.48   |
| 2047       | 0.92  | 0.47   |
| 2048       | 0.92  | 0.47   |
| 2049       | 0.92  | 0.46   |
| 2050       | 0.92  | 0.46   |
| 2051       | 0.92  | 0.45   |
| 2052       | 0.91  | 0.45   |
| 2053       | 0.91  | 0.45   |
| 2054       | 0.91  | 0.44   |
| 2055       | 0.91  | 0.44   |

<sup>a</sup>Learning factors are indexed to 2022. Note that traditional ICE powertrain technologies include things like the low voltage battery and its harness even if equipped on a BEV, PHEV, or HEV.

### **2.5.4 Indirect costs**

To produce a unit of output, vehicle manufacturers incur direct and indirect costs. Direct costs include cost of materials and labor costs. Indirect costs are all the costs associated with producing the unit of output that are not direct costs – for example, they may be related to production (such as research and development, R&D), corporate operations (such as salaries, pensions, and health care costs for corporate staff), or selling (such as transportation, dealer support, and marketing). Indirect costs are generally recovered by allocating a share of the costs to each unit of goods sold. Although it is possible to account for direct costs allocated to each unit of goods sold, it is more challenging to account for indirect costs allocated to a unit of goods sold. To make a cost analysis process more feasible, markup factors, which relate total indirect costs to total direct costs, have been developed. These factors are often referred to as a retail price equivalent (RPE) markup.

EPA has frequently used cost multipliers to predict the resultant impact on costs associated with manufacturers’ responses to regulatory requirements. The best approach, if it were possible, to determining the impact of changes in direct manufacturing costs on a manufacturer’s indirect

costs would be to estimate the cost impact on each indirect cost element. However, doing this within the constraints of an agency’s time or budget is not always feasible, or the technical, financial, and accounting information to carry out such an analysis may simply be unavailable.

The RPE multiplier, or RPE markup factor, is based on an examination of historical financial data contained in 10-K reports filed by manufacturers with the Securities and Exchange Commission. It represents the ratio between the retail price of motor vehicles and the direct costs of all activities that manufacturers engage in. The RPE markup provides, at an aggregate level, the relative shares of revenues (Revenue = Direct Costs + Indirect Costs + Net Income) to direct manufacturing costs as shown in Table 2-34. Using the RPE markup implicitly assumes that incremental changes in direct manufacturing costs produce common incremental changes in all indirect cost contributors as well as net income. However, a concern in using the RPE markup in cost analysis for new technologies added in response to regulatory requirements is that the indirect costs of vehicle modifications are not likely to be the same for different technologies. For example, less complex technologies could require fewer R&D efforts or less warranty coverage than more complex technologies. In addition, some simple technological adjustments may, for example, have no effect on the number of corporate personnel and the indirect costs attributable to those personnel. The use of a single RPE markup, with its assumption that all technologies have the same proportion of indirect costs, is likely to overestimate the costs of less complex technologies and underestimate the costs of more complex technologies.

**Table 2-34: Retail Price Equivalent Factors in the Heavy-Duty and Light-Duty Industries (Rogozhin 2009).**

| Cost Contributor                                 | Contribution to Cost |
|--|----------------------|
| Direct manufacturing cost                        | 1.0                  |
| Warranty   | 0.03                 |
| R&D  | 0.05                 |
| Other (administrative, retirement, health, etc.) | 0.36                 |
| Profit (cost of capital)                         | 0.06                 |
| Retail price equivalent                          | 1.50                 |

To address this concern, modified multipliers were developed by EPA, working with a contractor, for use in past EPA rulemakings. (Rogozhin 2009) Those modified multipliers were referred to Indirect Cost Multipliers, or ICMs, and EPA applied low magnitude ICMs (i.e., <the 1.5 RPE) to low complexity technologies and high magnitude ICMs (i.e., >the 1.5 RPE) to high complexity technologies. This way, we could analyze the possible pathways toward compliance with GHG regulations via, for example, application of many low complexity technologies versus few high complexity technologies. In other words, we could weigh one technology against another in a more finely tuned way.

The ICM approach served us well when dealing with incremental technology applications and incremental costs for those technologies as was done in the 2010 and 2012 final rules (75 FR 25324 2010, 77 FR 62624 2012). However, as noted above, we no longer use that approach to estimate compliance pathways. In contrast, since we now consider the whole vehicle and its total cost and performance toward compliance, we no longer need the fine tuning of one technology versus another that the ICM approach provided. As a result, for this analysis, we are using the full RPE markup as the indirect cost markup as we did in our 2021 final rule (86 FR 74434 2021).

## **2.6 Inputs and Assumptions for Compliance Modeling**

The following subsections provide details on the technology cost methodology, including equations and values applied in the OMEGA input files, for the final rulemaking.

### **2.6.1 Powertrain Costs**

Table 2-35 shows the engine, exhaust system and, fuel system costs used for any vehicle equipped with an internal combustion engine. Table 2-38 shows the driveline costs used for all vehicles. Table 2-40 shows additional electrified driveline costs used for HEVs, PHEVs, and BEVs. Note that, with the exception of the high voltage battery costs summarized in Figure 2-28 and the gasoline particulate filter (GPF) cost shown in Table 2-35, any cost denoted as having a 2022 cost basis is from the work discussed in Chapter 2.5.2.3. The high voltage battery costs, which are denoted as having a 2022 dollar basis, are from the DOE/ANL work discussed in Chapter 2.5.2.1. The GPF cost curve was developed by EPA and is discussed in Chapter 3.2.2. Costs denoted with a dollar basis other than 2022 are from prior EPA work.

### 2.6.1.1 Engine, exhaust and fuel system costs

**Table 2-35: Engine, exhaust, and fuel system costs used for ICE, HEV and PHEV.**

| Item                        | Engine Config | Body Style | Value   | Dollar Basis |
|-----------------------------|---------------|------------|---|--------------|
| cylinder deac FC            | I             | -          | 169 * Markup  | 2022         |
| cylinder deac FC            | V             | -          | 221 * Markup  | 2022         |
| cylinder deac PD            | -             | -          | (-1.0603 * CYL ** 2 + 28.92 * CYL - 8.6935) * Markup  | 2006         |
| direct injection            | I             | -          | 212 * Markup  | 2022         |
| direct injection            | V             | -          | 319 * Markup  | 2022         |
| Cooled EGR                  | -             | -          | 100 * Markup  | 2022         |
| Engine block                | I             | -          | (324.71*LITERS + 680) * Markup  | 2022         |
| Engine block                | V             | -          | (246.87*LITERS + 1215) * Markup   | 2022         |
| Diesel engine block scaler  | -             | -          | 1.5   |              |
| Turbo Charger               | I             | -          | 429 * Markup  | 2022         |
| Turbo Charger               | V             | -          | 756 * Markup  | 2022         |
| VVT                         | I             | -          | 100 * Markup  | 2022         |
| VVT                         | V             | -          | 200 * Markup  | 2022         |
| Atkinson                    | -             | -          | (4.907 * CYL ** 2 - 29.957 * CYL + 130.18) * Markup   | 2010         |
| Non-EAS                     | I             | -          | 250 * Markup  | 2022         |
| Non-EAS                     | V             | -          | 350 * Markup  | 2022         |
| Fuel storage                | -             | pickup     | 571.45 * Markup   | 2022         |
| Fuel storage                | -             | sedan      | 467.55 * Markup   | 2022         |
| Fuel storage                | -             | cuv_suv    | 519.5 * Markup  | 2022         |
| TWC substrate               | -             | -          | (6.108 * LITERS * TWC_SWEPT_VOLUME + 1.95456) * Markup  | 2012         |
| TWC washcoat                | -             | -          | (5.09 * LITERS * TWC_SWEPT_VOLUME) * Markup   | 2012         |
| TWC canning                 | -             | -          | (2.4432 * LITERS * TWC_SWEPT_VOLUME) * Markup   | 2012         |
| TWC swept volume            | -             | -          | 1.2 multiplier applied to engine displacement   |              |
| TWC Pt grams/liter          | -             | -          | 0   |              |
| TWC Pd grams/liter          | -             | -          | 2   |              |
| TWC Rh grams/liter          | -             | -          | 0.11  |              |
| TWC PGM                     | -             | -          | (PT_GRAMS_PER_LITER_TWC * LITERS * TWC_SWEPT_VOLUME * PT_USD_PER_OZ * OZ_PER_GRAM + PD_GRAMS_PER_LITER_TWC * LITERS * TWC_SWEPT_VOLUME * PD_USD_PER_OZ * OZ_PER_GRAM + RH_GRAMS_PER_LITER_TWC * LITERS * TWC_SWEPT_VOLUME * RH_USD_PER_OZ * OZ_PER_GRAM) * Markup |              |
| Troy oz/gram                | -             | -          | 0.0322  |              |
| PT USD PER OZ               | -             | -          | 1030  |              |
| PD USD PER OZ               | -             | -          | 2331  |              |
| RH USD PER OZ               | -             | -          | 17981   |              |
| Gasoline particulate filter | -             | -          | (42.269 * LITERS + 22.213) * Markup   | 2022         |
| Diesel EAS                  | -             | -          | 700 * LITERS * Markup   | 2020         |
| Markup                      | -             | -          | 1.5   |              |

FC=full continuous cylinder deactivation; PD=partial discrete cylinder deactivation; LITERS=engine displacement in liters; GEARS=the number of forward gears; CYL=number of cylinders; I=Inline configuration; V=V configuration; FWD=front wheel drive; RWD=rear wheel drive; AWD=all wheel drive; EGR=Exhaust gas recirculation; VVT=Variable valve timing; EAS=exhaust aftertreatment system; Non-EAS=exhaust system excluding the exhaust aftertreatment system; HVAC=heating, ventilation, air conditioning; TWC=three-way catalyst; Pt=Platinum; Pd=Palladium; Rh=Rhodium.

### 2.6.1.1.1 Cylinder Deactivation

The costs of partial discrete cylinder deactivation are based on past EPA analyses as shown in Table 2-36.

**Table 2-36: Cylinder Deactivation Costs used to generate a partial discrete cost curve for OMEGA.**

| Item                                | DMC | Dollar Basis |
|-------------------------------------|-----|--------------|
| Partial discrete, 3-cylinder engine | 76  | 2006         |
| Partial discrete, 4-cylinder engine | 76  | 2006         |
| Partial discrete, 6-cylinder engine | 136 | 2006         |
| Partial discrete, 8-cylinder engine | 152 | 2006         |

Using these values, the following cost curve was generated for use in OMEGA.

$$Deac_{PD} = (-1.0603 \times CYL^2 + 28.92 \times CYL - 8.6935) \times Markup$$

Where,

$CYL$  = the number of cylinders on the engine

$Markup$  = the markup to cover indirect costs

The costs for full continuous cylinder deactivation are based on the FEV cost scaling work and are calculated as shown in Table 2-35.

### 2.6.1.1.2 Atkinson Cycle Engine

The costs for Atkinson cycle engine (ATK) are based on costs used in past EPA analyses. Those costs are shown in Table 2-37.

**Table 2-37: Atkinson Cycle Engine Costs used to generate a cost curve for OMEGA.**

| Item                   | DMC | Dollar Basis |
|------------------------|-----|--------------|
| ATK, 3-cylinder engine | 86  | 2010         |
| ATK, 4-cylinder engine | 86  | 2010         |
| ATK, 6-cylinder engine | 129 | 2010         |
| ATK, 8-cylinder engine | 204 | 2010         |

Using these values, the following cost curves were generated for use in OMEGA.

$$AtkinsonCycleEngine = (4.907 \times CYL^2 - 29.957 \times CYL + 130.18) \times Markup$$

Where,

$CYL$  = the number of cylinders on the engine

$Markup$  = the markup to cover indirect costs

### 2.6.1.1.3 Gasoline Particulate Filter

The gasoline particulate filter (GPF) cost is a new cost for this analysis and has been updated since the NPRM. This is described in detail in Chapter 3.2.2. The cost curve used in OMEGA is shown below. Note that the GPF costs are applied only in the action case if GPFs are expected for compliance with new gasoline PM standards.

$$GPF = (42.269 \times LITERS + 22.213) \times Markup$$

Where,

*LITERS* = the engine displacement in liters

*Markup* = the markup to cover indirect costs

### 2.6.1.1.4 Three-way Catalyst

OMEGA's three-way catalyst (TWC) costs are based largely on the approach used in the light-duty highway Tier 3 criteria pollutant rule. In the Tier 3 rule, EPA presented cost curves to estimate costs for the individual components of a TWC: the substrate; the washcoat; the canning; and the platinum group metals (PGM, consisting of platinum (Pt), palladium (Pd) and rhodium (Rh)). The four cost curves are shown below.

$$TWC_{substrate} = (6.108 \times 1.2 \times LITERS + 1.955) \times Markup$$

$$TWC_{washcoat} = (5.09 \times 1.2 \times LITERS) \times Markup$$

$$TWC_{canning} = (2.4432 \times 1.2 \times LITERS) \times Markup$$

$$TWC_{PGM} = (Pt_{gpl} \times Pt_{\$/TroyOz} + Pd_{gpl} \times Pd_{\$/TroyOz} + Rh_{gpl} \times Rh_{\$/TroyOz}) \times 1.2 \times LITERS \times \frac{TroyOz}{gram}$$

Where,

*LITERS* = the engine displacement in liters

1.2 = factor to account for the swept volume of the TWC (i.e., total TWC volume is 1.2x engine displacement)

*Pt<sub>gpl</sub>* = Platinum grams/liter, set to 0 in this analysis

*Pd<sub>gpl</sub>* = Palladium grams/liter, set to 2 in this analysis

*Rh<sub>gpl</sub>* = Rhodium grams/liter, set to 0.11 in this analysis

*Pt<sub>\\$/TroyOz</sub>* = Platinum cost per Troy ounce, set to \$1,030 in this analysis



$Pd_{\$/TroyOz}$  = Palladium cost per Troy ounce, set to \$2,331 in this analysis

$Rh_{\$/TroyOz}$  = Rhodium cost per Troy ounce, set to \$17,981 in this analysis

$TroyOz$  = Troy ounces

$TroyOz/gram$  = 0.0322, or 31.1 grams per Troy Oz

$Markup$  = the markup to cover indirect costs

#### **2.6.1.1.5 Diesel Exhaust Aftertreatment System**

OMEGA's diesel exhaust aftertreatment system (diesel EAS) costs are structured for consistency with the recent heavy-duty final rule (88 FR 4296 2023). The cost curve is as shown below.

$$Diesel\ EAS = (700 \times LITERS) \times Markup$$

Where,

$Diesel\ EAS$  = diesel exhaust aftertreatment system cost

$LITERS$  = the engine displacement in liters

$Markup$  = the markup to cover indirect costs

## 2.6.1.2 Driveline System Costs for all Vehicles

**Table 2-38: Driveline system costs for all vehicles.**

| Item                       | Drive System | Engine Config | Body Style | Value   | Dollar Basis |
|----------------------------|--------------|---------------|------------|---|--------------|
| ICE transmission           | FWD          | -             | -          | (140.11 * GEARS + 52.674) * Markup                                    | 2022         |
| ICE transmission           | RWD          | -             | -          | (140.11 * GEARS + 52.674) * Markup                                    | 2022         |
| ICE transmission           | AWD          | -             | pickup     | (140.11 * GEARS + 52.674 + 544.28) * Markup                           | 2022         |
| ICE transmission           | AWD          | -             | sedan      | (140.11 * GEARS + 52.674 + 281) * Markup                              | 2022         |
| ICE transmission           | AWD          | -             | cuv_suv    | (140.11 * GEARS + 52.674 + 339.37) * Markup                           | 2022         |
| P0 HEV transmission        | FWD          | -             | -          | (140.11 * GEARS + 1.73 * KW_P0 + 178) * Markup                        | 2022         |
| P0 HEV transmission        | RWD          | -             | -          | (140.11 * GEARS + 1.73 * KW_P0 + 178) * Markup                        | 2022         |
| P0 HEV transmission        | AWD          | -             | -          | (140.11 * GEARS + 1.73 * KW_P0 + 178) * Markup                        | 2022         |
| P2 HEV/PHEV transmission   | FWD          | -             | -          | (140.11 * GEARS + 1.73 * KW_P2 + 178) * Markup                        | 2022         |
| P2 HEV/PHEV transmission   | RWD          | -             | -          | (140.11 * GEARS + 1.73 * KW_P2 + 178) * Markup                        | 2022         |
| P2 HEV/PHEV transmission   | AWD          | -             | -          | (140.11 * GEARS + 1.73 * KW_P2 + 178 + 1.1097 * KW_P4 + 323) * Markup | 2022         |
| PS HEV/PHEV transmission   | FWD          | -             | -          | 1587.77 * Markup  | 2022         |
| PS HEV/PHEV transmission   | RWD          | -             | -          | 1587.77 * Markup  | 2022         |
| PS HEV/PHEV transmission   | AWD          | -             | -          | (1587.77 + 1.1097 * KW_P4 + 323) * Markup                             | 2022         |
| Start stop                 | -            | -             | -          | 200 * Markup  | 2022         |
| High efficiency alternator | -            | -             | -          | (150) * Markup  | 2015         |
| Low voltage battery        | -            | -             | -          | 60 * Markup   | 2022         |
| ICE low voltage harness    | -            | -             | pickup     | 60.31 * Markup  | 2022         |
| ICE low voltage harness    | -            | -             | sedan      | 50.26 * Markup  | 2022         |
| ICE low voltage harness    | -            | -             | cuv_suv    | 50.26 * Markup  | 2022         |
| BEV low voltage harness    | FWD;<br>RWD  | -             | pickup     | 110.42 * Markup   | 2022         |
| BEV low voltage harness    | FWD;<br>RWD  | -             | sedan      | 101.62 * Markup   | 2022         |
| BEV low voltage harness    | FWD;<br>RWD  | -             | cuv_suv    | 100.44 * Markup   | 2022         |
| BEV low voltage harness    | AWD          | -             | pickup     | 157.75 * Markup   | 2022         |
| BEV low voltage harness    | AWD          | -             | sedan      | 143.48 * Markup   | 2022         |
| BEV low voltage harness    | AWD          | -             | cuv_suv    | 145.17 * Markup   | 2022         |
| HEV low voltage harness    | -            | -             | pickup     | 60.31 * Markup  | 2022         |
| HEV low voltage harness    | -            | -             | sedan      | 50.26 * Markup  | 2022         |
| HEV low voltage harness    | -            | -             | cuv_suv    | 50.26 * Markup  | 2022         |
| PHEV low voltage harness   | -            | -             | pickup     | 172.31 * Markup   | 2022         |
| PHEV low voltage harness   | -            | -             | sedan      | 143.59 * Markup   | 2022         |
| PHEV low voltage harness   | -            | -             | cuv_suv    | 143.59 * Markup   | 2022         |
| ICE Powertrain cooling     | -            | I             | pickup     | 334.04 * Markup   | 2022         |
| ICE Powertrain cooling     | -            | V             | pickup     | 374.53 * Markup   | 2022         |
| ICE Powertrain cooling     | -            | I             | sedan      | 308.68 * Markup   | 2022         |
| ICE Powertrain cooling     | -            | V             | sedan      | 346.09 * Markup   | 2022         |
| ICE Powertrain cooling     | -            | I             | cuv_suv    | 308.68 * Markup   | 2022         |
| ICE Powertrain cooling     | -            | V             | cuv_suv    | 346.09 * Markup   | 2022         |
| HEV Powertrain cooling     | -            | I             | pickup     | 519.13 * Markup   | 2022         |
| HEV Powertrain cooling     | -            | I             | sedan      | 493.78 * Markup   | 2022         |
| HEV Powertrain cooling     | -            | I             | cuv_suv    | 493.78 * Markup   | 2022         |
| HEV Powertrain cooling     | -            | V             | pickup     | 559.63 * Markup   | 2022         |
| HEV Powertrain cooling     | -            | V             | sedan      | 531.19 * Markup   | 2022         |
| HEV Powertrain cooling     | -            | V             | cuv_suv    | 531.19 * Markup   | 2022         |
| PHEV Powertrain cooling    | -            | I             | pickup     | 538.5 * Markup  | 2022         |
| PHEV Powertrain cooling    | -            | I             | sedan      | 513.21 * Markup   | 2022         |
| PHEV Powertrain cooling    | -            | I             | cuv_suv    | 513.21 * Markup   | 2022         |
| PHEV Powertrain cooling    | -            | V             | pickup     | 579.07 * Markup   | 2022         |
| PHEV Powertrain cooling    | -            | V             | sedan      | 550.63 * Markup   | 2022         |

| Item                                      | Drive System | Engine Config | Body Style | Value                        | Dollar Basis |
|---|--------------|---------------|------------|------------------------------|--------------|
| PHEV Powertrain cooling                   | -            | V             | cuv_suv    | 550.63 * Markup              | 2022         |
| BEV Powertrain cooling                    | FWD;<br>RWD  | -             | pickup     | 632.33 * Markup              | 2022         |
| BEV Powertrain cooling                    | FWD;<br>RWD  | -             | sedan      | 383.54 * Markup              | 2022         |
| BEV Powertrain cooling                    | FWD;<br>RWD  | -             | cuv_suv    | 413.13 * Markup              | 2022         |
| BEV Powertrain cooling                    | AWD          | -             | pickup     | 709.81 * Markup              | 2022         |
| BEV Powertrain cooling                    | AWD          | -             | sedan      | 456.71 * Markup              | 2022         |
| BEV Powertrain cooling                    | AWD          | -             | cuv_suv    | 602.00 * Markup              | 2022         |
| HVAC                                      | -            | -             | -          | 472.76 * Markup              | 2022         |
| A/C leakage                               | -            | -             | -          | (63) * Markup                | 2010         |
| A/C efficiency                            | -            | -             | -          | (40) * Markup                | 2010         |
| KW_RDU share                              | -            | -             | -          | 0.65 * total e-machine power |              |
| KW_FDU share                              | -            | -             | -          | 1 - KW_RDU share             |              |
| KW_P0 share; KW_P2 share<br>(used for PS) | FWD;<br>RWD  | -             | -          | 1.0 * total e-machine power  |              |
| KW_P2 share                               | AWD          | -             | -          | 0.5 * total e-machine power  |              |
| KW_P4 share                               | AWD          | -             | -          | 1 - KW_P2 share              |              |
| Markup                                    | -            | -             | -          | 1.5                          |              |

P0, P2 and PS refer to HEV and PHEV architectures; FWD=front wheel drive; RWD=rear wheel drive; AWD=all wheel drive; KW\_DU=total e-machine power; KW\_RDU=rear drive unit power; KW\_FDU=front drive unit power; KW\_P2=primary motor power; KW\_P4=secondary motor power; HVAC=heating, ventilation, air conditioning.

### 2.6.1.2.1 High Efficiency Alternator

OMEGA's high efficiency alternator cost is based on past EPA analyses and is calculated according to the equation shown below.

$$HighEfficiencyAlternator = 150 \times Markup$$

Where,

*Markup* = the markup to cover indirect costs

### 2.6.1.2.2 Air Conditioning

Air conditioning (A/C) system costs are based on past EPA analyses and are shown in Table 2-39.

**Table 2-39: Air Conditioning System Costs in OMEGA.**

| Item                        | DMC         | Dollar Basis |
|-----------------------------|-------------|--------------|
| A/C efficiency improvements | 40 * Markup | 2010         |
| A/C leakage control         | 63 * Markup | 2010         |
| Markup                      | 1.5         |              |

OMEGA uses these costs as-is, other than applying the markup to account for indirect costs and adjusting to the appropriate dollar basis.

### 2.6.1.3 Electrified Driveline System Costs for HEV, PHEV, and BEV

**Table 2-40: Electrified driveline system costs for HEV, PHEV, and BEV.**

| Item                                   | Drive System | Body Style | Value  | Dollar Basis |
|--|--------------|------------|--|--------------|
| P0 & P2 HEV/PHEV Gearbox               | AWD          | sedan      | 281 * Markup   | 2022         |
| P0 & P2 HEV/PHEV Gearbox               | AWD          | cuv_suv    | 339.37 * Markup  | 2022         |
| P0 & P2 HEV/PHEV Gearbox               | AWD          | pickup     | 544.28 * Markup  | 2022         |
| BEV Gearbox                            | FWD;<br>RWD  | pickup     | 544.28 * Markup  | 2022         |
| BEV Gearbox                            | FWD;<br>RWD  | sedan      | 281.00 * Markup  | 2022         |
| BEV Gearbox                            | FWD;<br>RWD  | cuv_suv    | 339.37 * Markup  | 2022         |
| BEV Gearbox                            | AWD          | pickup     | 2 * 544.28 * Markup  | 2022         |
| BEV Gearbox                            | AWD          | sedan      | 2 * 281.00 * Markup  | 2022         |
| BEV Gearbox                            | AWD          | cuv_suv    | 2 * 339.37 * Markup  | 2022         |
| BEV e-motor                            | FWD          | -          | (1.1097*KW_DU + 323.22) * Markup   | 2022         |
| BEV e-motor                            | RWD          | -          | (1.1097*KW_DU + 323.22) * Markup   | 2022         |
| BEV e-motor                            | AWD          | -          | ((0.77*KW_FDU+225.33) + (1.1097*KW_RDU + 323.22)) * Markup   | 2022         |
| HEV/PHEV Inverter                      | FWD          | -          | (1.26 * KW_P2 + 559) * Markup  | 2022         |
| HEV/PHEV Inverter                      | RWD          | -          | (1.26 * KW_P2 + 559) * Markup  | 2022         |
| HEV/PHEV Inverter                      | AWD          | -          | ((1.26 * KW_P2 + 559) + (1.26 * KW_P4 + 559)) * Markup   | 2022         |
| BEV Inverter                           | FWD          | -          | (1.26 * KW_DU + 559) * Markup  | 2022         |
| BEV Inverter                           | RWD          | -          | (1.26 * KW_DU + 559) * Markup  | 2022         |
| BEV Inverter                           | AWD          | -          | ((1.26 * KW_FDU + 559) + (1.26 * KW_RDU + 559)) * Markup   | 2022         |
| BEV high voltage harness               | FWD;<br>RWD  | pickup     | 274.32 * Markup  | 2022         |
| BEV high voltage harness               | FWD;<br>RWD  | sedan      | 248.87 * Markup  | 2022         |
| BEV high voltage harness               | FWD;<br>RWD  | cuv_suv    | 244.87 * Markup  | 2022         |
| BEV high voltage harness               | AWD          | pickup     | 363.16 * Markup  | 2022         |
| BEV high voltage harness               | AWD          | sedan      | 337.21 * Markup  | 2022         |
| BEV high voltage harness               | AWD          | cuv_suv    | 333.71 * Markup  | 2022         |
| HEV high voltage harness               | -            | pickup     | 81.09 * Markup   | 2022         |
| HEV high voltage harness               | -            | sedan      | 67.58 * Markup   | 2022         |
| HEV high voltage harness               | -            | cuv_suv    | 67.58 * Markup   | 2022         |
| PHEV high voltage harness              | -            | pickup     | 246.09 * Markup  | 2022         |
| PHEV high voltage harness              | -            | sedan      | 205.07 * Markup  | 2022         |
| PHEV high voltage harness              | -            | cuv_suv    | 205.07 * Markup  | 2022         |
| BEV/PHEV Charge cord                   | -            | -          | 111 * Markup   | 2022         |
| HEV DC-DC converter                    | -            | -          | 250 * Markup   | 2022         |
| BEV DC-DC converter + onboard charger  | -            | -          | 57 * KW_OBC * Markup   | 2022         |
| PHEV DC-DC converter + onboard charger | -            | -          | 57 * KW_OBC * Markup   | 2022         |
| KW_OBC                                 | -            | -          | For battery kWh<100, KW_OBC=11<br>For battery kWh>=100, KW_OBC=19  |              |
| BEV/PHEV High voltage battery NMC      | -            | -          | (128.9 + 1480 / (KWH ** 1.164) - 5.278 * (MODEL_YEAR - 2023) * e ** (-0.0129 * (MODEL_YEAR - 2023))) * KWH * Markup  | 2022         |
| BEV/PHEV High voltage battery LFP      | -            | -          | (120.6 + 1535 / (KWH ** 1.148) - 10.04 * (MODEL_YEAR - 2023) * e ** (-0.08346 * (MODEL_YEAR - 2023))) * KWH * Markup | 2022         |

| Item  | Drive System | Body Style | Value   | Dollar Basis |
|---|--------------|------------|---|--------------|
| HEV High voltage battery NMC  | -            | -          | $(122.9 + 509.6 / (\text{KWH}^{**} 0.7649) - 4.443 * (\text{MODEL\_YEAR} - 2023)) * e^{**} (0.01018 * (\text{MODEL\_YEAR} - 2023))) * \text{KWH} * \text{Markup}$ | 2022         |
| High voltage battery learning   | -            | -          | $(1 - 0.015) ** (\max(\text{CALENDAR\_YEAR}, 2035) - 2035)$   |              |
| KW_RDU share  | -            | -          | -   |              |
| KW_FDU share  | -            | -          | -   |              |
| KW_P0 share; KW_P2 share (used for PS)  | FWD;<br>RWD  | -          | -   |              |
| KW_P2 share   | AWD          | -          | -   |              |
| KW_P4 share   | AWD          | -          | -   |              |
| Markup  | -            | -          | 1.5   |              |
| FWD=front wheel drive; RWD=rear wheel drive; AWD=all wheel drive; KW_DU=total e-machine power; KW_RDU=rear drive unit power; KW_FDU=front drive unit power; KW_P2=primary motor power; KW_P4=secondary motor power; KWH=gross battery energy capacity; KW_OBC=onboard charger power; DC=direct current; NMC=nickel metal carbide; LFP=lithium iron phosphate. Note that "***" denotes an exponent; e=2.718. |              |            |   |              |

#### 2.6.1.4 HEV and Mild HEV Battery Costs

As previously described in Chapter 2.5.2.1.2, OMEGA uses the HEV battery cost curve developed by ANL and shown below. OMEGA uses this equation for both mild and strong HEVs.

$$HEV (Ni/Mn) \$/kWh = \left[ 122.9 + \frac{509.6}{kWh^{0.7649}} - 4.443(MY - 2023)e^{-0.01018(MY-2023)} \right] \times Markup$$

Where,

*kWh* = the gross energy capacity of the battery in kilowatt hours

*MY* = model year

*Markup* = the markup to account for indirect costs

#### 2.6.1.5 BEV and PHEV Battery Costs

As described previously in Section 2.5.2.1.2, EPA is using a set of cost equations for PEV batteries developed by ANL, which EPA uses for BEV and PHEV batteries. EPA is modeling longer-range PHEVs, and the equations were developed by ANL to be inclusive of longer-range PHEVs that would utilize battery capacities at the lower end of the range of kWh covered by the equation.

$$BEV (NiMn) \$/kWh = \left[ 128.9 + \frac{1480}{kWh^{1.164}} - 5.278(MY - 2023)e^{-0.0129(MY-2023)} \right] \times Markup$$

$$BEV (LFP) \$/kWh = \left[ 120.6 + \frac{1535}{kWh^{1.148}} - 10.04(MY - 2023)e^{-0.08346(MY-2023)} \right] \times Markup$$

$$PHEV (NiMn) \$/kWh = \left[ 128.9 + \frac{1480}{kWh^{1.164}} - 5.278(MY - 2023)e^{-0.0129(MY-2023)} \right] \times Markup$$

$$PHEV (LFP) \$/kWh = \left[ 120.6 + \frac{1535}{kWh^{1.148}} - 10.04(MY - 2023)e^{-0.08346(MY-2023)} \right] \times Markup$$

Where,

*kWh* = the gross energy capacity of the battery in kilowatt hours

*MY* = model year

*Markup* = the markup to account for indirect costs shown in Table 2-34

Table 2-32 gives the assumed NMC/LFP share used in the OMEGA modeling for BEVs and PHEVs. For HEV batteries we assume 100 percent NMC chemistry.

#### 2.6.1.6 BEV Range Assumptions

For the purpose of compliance modeling, EPA assumed that all light-duty BEVs would be designed with 300 miles of label range, which is calculated as 300 miles divided by a 0.75 adjustment factor used for fuel economy labeling purposes. The average range of MY 2022 BEVs exceeded 300 miles for the first time, as discussed in Chapter 3.1.1.3 of the RIA. EPA assumed 150-mile range for its medium-duty BEV vans. The basis for this assumption is discussed in Chapter 3.1.2 of the RIA.

#### 2.6.1.7 PHEV Range Assumptions

Unlike ICE vehicles and BEVs, which operate under one dedicated fuel, PHEVs consume a combination of electricity and gasoline. As is discussed throughout this rulemaking, the charge-depleting range of a PHEV is directly related to the utility factor used to calculate each vehicle's compliance CO<sub>2</sub> value. Manufacturers have the flexibility to design PHEVs with a variety of charge-depleting range, from a minimal all-electric range, up to strong PHEVs which might exceed 100 miles of all-electric range. For the purposes of our compliance runs, EPA assumed that manufacturers would design PHEVs that would provide enough range to qualify as ZEVs under the ACC II and ACT programs being administered by California and participating Section 177 states. In OMEGA, EPA thus assumed that light-duty vehicle PHEV batteries would be sized for 40 miles of all-electric range over the US06 cycle, while medium-duty PHEVs would be sized to drive 75 miles over the UDSS while tested at ALVW.

#### 2.6.1.8 Additional discussion of PHEV Architectures

EPA recognizes that PHEVs can provide significant reductions in GHG emissions and that some vehicle manufacturers may choose to utilize this technology as part of their technology portfolio.

In general, EPA anticipates that individual component costs for PHEVs, such as power electronics costs, P4 gearbox costs and AWD costs would be similar to that of BEVs. We also expect that PHEVs, like BEVs, will have a variety of specific component sizings and architectures oriented to specific uses, such as in passenger cars, pickup trucks, and medium-duty vehicles.

For example, a series/parallel hybrid transmission for PHEVs may consist of:

- Motor-generator
- Starter-generator
- Clutch-pack to lock the ICE and starter generator to the motor generator for parallel operation

An example of such a series/parallel hybrid drive system for transverse front-drive applications is shown in Figure 2-29. Yamagishi and Ishikura provided a detailed description of application of a similar series-parallel drive system to the Honda Clarity PHEV (Yamagishi and Ishikura 2018). An application of this type of series/parallel drive to a front-engine/rear-drive application would require use of a drive shaft and separate, rear-mounted differential. AWD vehicles may include the cost of a series-parallel hybrid transmission with the addition of a P4 electric machine to either the front or rear depending on the application. One specific example is an LDT4 with OMEGA size-class 7 vehicle with:

- A combined electric drive system power of 240 kW
- A P4 induction machine for front axle electric-only drive
- A 3.0L Miller Cycle engine coupled to a series/parallel (S/P) drive single-speed transmission with a drive shaft and rear differential for rear axle drive
- The figure is adapted from a presentation by Prof. J.D. Kelly, Weber State University (Kelly 2020).



**Figure 2-29: Example of a series-parallel hybrid drive system for a transverse/front-drive application.**

### **2.6.2 Glider Costs**

Glider cost curves in OMEGA represent three different body-styles: sedan, CUV/SUV, and pickup; two different structure styles: unibody and ladder frame; two different primary materials: steel and aluminum; as well as non-structural elements. The relevant curves used in OMEGA are shown in Table 2-41. Note that "structure\_mass\_lbs" term shown in the table is determined according to the structure mass curves shown in Table 2-42.

Note that, unlike past EPA GHG analyses, OMEGA no longer models mass as a compliance strategy in discrete percentages of mass reduction. Instead, OMEGA calculates mass based on the factors shown in Table 2-42, with the compliance strategy decision based primarily on steel versus aluminum structure. Footprint may also change which would impact the mass of the vehicle, but the mass associated with potential footprint changes is a secondary effect of the footprint decision. In other words, footprint does not change as a result of mass reduction strategies and, instead, mass may change as a result of footprint strategies. The cost of the resultant mass is estimated using the equations shown in Table 2-41.



**Table 2-41: Glider Costs in OMEGA.**

| Item              | Body-style | Structure Material | DMC   | Dollar Basis |
|-------------------|------------|--------------------|---|--------------|
| Unibody structure | Sedan      | Steel              | $(1.5 * \text{structure\_mass\_lbs} + 1500) * \text{markup}$  | 2020         |
| Unibody structure | Sedan      | Aluminum           | $(3.4 * \text{structure\_mass\_lbs} + 1500) * \text{markup}$  | 2020         |
| Unibody structure | CUV/SUV    | Steel              | $(1.5 * \text{structure\_mass\_lbs} + 1700) * \text{markup}$  | 2020         |
| Unibody structure | CUV/SUV    | Aluminum           | $(3.4 * \text{structure\_mass\_lbs} + 1700) * \text{markup}$  | 2020         |
| Ladder structure  | CUV/SUV    | Steel              | $((1.5 * \text{structure\_mass\_lbs} + 550) + (1.5 * (0.66 * \text{structure\_mass\_lbs}) + 2000)) * \text{markup}$                                     | 2020         |
| Ladder structure  | CUV/SUV    | Aluminum           | $((1.5 * \text{structure\_mass\_lbs} + 550) + (3.4 * (0.66 * \text{structure\_mass\_lbs}) + 2000)) * \text{markup}$                                     | 2020         |
| Ladder structure  | Pickup     | Steel              | $((1.5 * \text{structure\_mass\_lbs} + 550) + (1.5 * (0.66 * \text{structure\_mass\_lbs}) + 2000)) * \text{markup}$                                     | 2020         |
| Ladder structure  | Pickup     | Aluminum           | $((1.5 * \text{structure\_mass\_lbs} + 550) + (3.4 * (0.66 * \text{structure\_mass\_lbs}) + 2000)) * \text{markup}$                                     | 2020         |
| Unibody structure | Pickup     | Steel              | $(1.5 * \text{structure\_mass\_lbs} + 1700) * \text{markup}$  | 2020         |
| Unibody structure | Pickup     | Aluminum           | $(3.4 * \text{structure\_mass\_lbs} + 1700) * \text{markup}$  | 2020         |
| Non-structure     | Sedan      | Various            | $(24.3 * \text{delta\_footprint} + 2.4 * \text{delta\_footprint} * (\text{vehicle.height\_in} - \text{vehicle.ground\_clearance\_in})) * \text{markup}$ | 2020         |
| Non-structure     | CUV/SUV    | Various            | $(24.9 * \text{delta\_footprint} + 2.6 * \text{delta\_footprint} * (\text{vehicle.height\_in} - \text{vehicle.ground\_clearance\_in})) * \text{markup}$ | 2020         |
| Non-structure     | Pickup     | Various            | $(18.2 * \text{delta\_footprint} + 2.1 * \text{delta\_footprint} * (\text{vehicle.height\_in} - \text{vehicle.ground\_clearance\_in})) * \text{markup}$ | 2020         |
| Markup            |            |                    | 1.5 RPE markup to account for indirect costs  |              |

**Table 2-42: Mass Calculations in OMEGA.**

| Item  | Body-style | Structure | Material | Value  |
|---|------------|-----------|----------|--|
| Null structure mass   | Sedan      | Ladder    |          | $2.2 * (5.5045 * \text{footprint} + 105.4)$  |
| Null structure mass   | Sedan      | Unibody   |          | $2.2 * (5.5045 * \text{footprint} + 105.4)$  |
| Null structure mass   | CUV/SUV    | Ladder    |          | $2.2 * (7.7955 * \text{footprint} + 127.48)$   |
| Null structure mass   | CUV/SUV    | Unibody   |          | $2.2 * (10.077 * \text{footprint} - 76.528)$   |
| Null structure mass   | Pickup     | Ladder    |          | $2.2 * (7.7955 * \text{footprint} + 127.48)$   |
| Null structure mass   | Pickup     | Unibody   |          | $2.2 * (10.077 * \text{footprint} - 76.528)$   |
| Structure mass lbs  |            |           | Steel    | null structure mass  |
| Structure mass lbs  |            | Ladder    | Aluminum | $(0.63 * 0.66 + 0.34) * \text{null structure mass}$  |
| Structure mass lbs  |            | Unibody   | Aluminum | $0.65 * \text{null structure mass}$  |
| Delta glider non-structure mass   | Sedan      |           |          | $(15.1 * \text{delta\_footprint} + 2.3 * \text{delta\_footprint} * (\text{vehicle.height} - \text{vehicle.ground\_clearance})/12)$ |
| Delta glider non-structure mass   | CUV/SUV    |           |          | $(17.3 * \text{delta\_footprint} + 2.5 * \text{delta\_footprint} * (\text{vehicle.height} - \text{vehicle.ground\_clearance})/12)$ |
| Delta glider non-structure mass   | Pickup     |           |          | $(18.1 * \text{delta\_footprint} + 1.9 * \text{delta\_footprint} * (\text{vehicle.height} - \text{vehicle.ground\_clearance})/12)$ |
| Note: footprint is in square feet; height and ground clearance are in inches; mass values are in pounds; 2.2 converts kilograms to pounds |            |           |          |  |

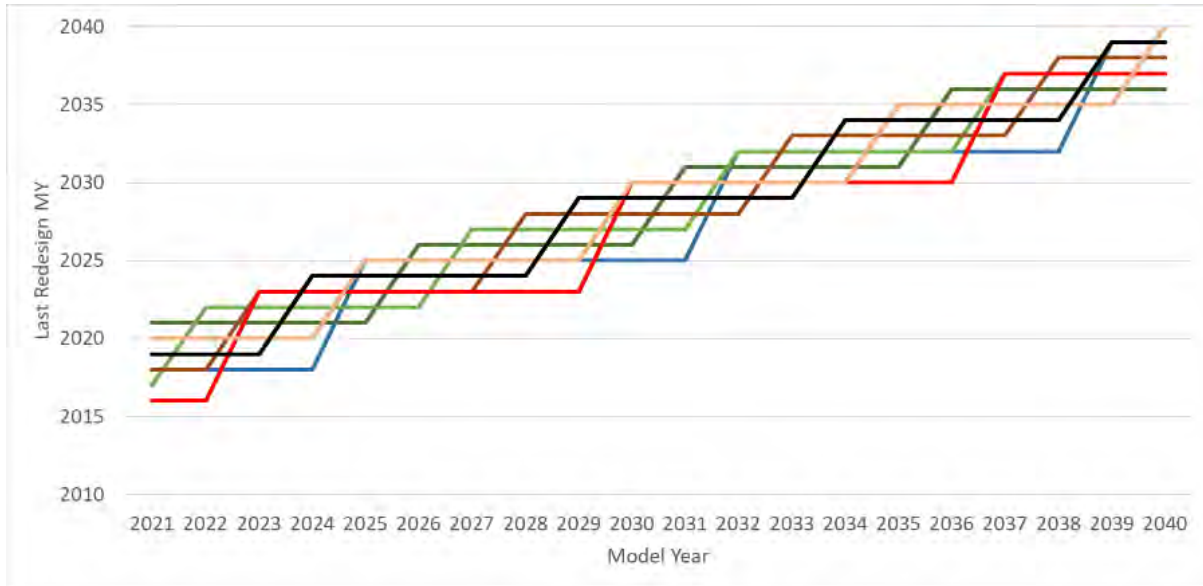
### **2.6.3 Consumer demand assumptions and PEV acceptance**

OMEGA estimates the share of PEVs demanded within each of three body styles as a function of the relative consumer generalized costs for PEV and ICE vehicles, and a PEV acceptance parameter, which we refer to as a shareweight parameter. The shareweight parameter changes over time to account for factors that are not included in the generalized costs, such as greater access to charging infrastructure or greater availability and awareness of PEVs. The determination of consumer generalized costs and share weights for ICE vehicles and PEVs is described in more detail in Chapter 4.1.

### **2.6.4 Producer decision modeling and constraints for technology adoption**

#### **2.6.4.1 Redesign schedules**

Consistent with past rulemakings, EPA has included redesign cycles as a constraint to restrict introduction of new technology for a given vehicle model to the cadence of a typical product cycle time. As implemented for this rule, OMEGA may only redesign a vehicle every 5 years for unibody vehicles and every 7 years for body-on-frame vehicles. An example of behavior for one manufacturer's vehicles can be seen in Figure 2-30.



**Figure 2-30: Redesign Years for Select Vehicles.**

EPA has populated its base year vehicles file with the year of last redesign for each model in the light duty fleet. Applying OMEGA's redesign constraints above with the distribution of redesign years across the industry yielded the following distribution of redesigns on a sales basis.

Table 2-43 provides a count of the discrete vehicle models and sales in MY 2032, the year in which they were last redesigned, and the corresponding sales volume that was redesigned in prior years. As can be seen, there is a fairly even distribution of vehicle model redesign years. Note that many vehicles which were redesigned in MY 2026 were eligible for another redesign in MY 2031.

**Table 2-43: MY 2032 Vehicles: Year of Last Redesign.**

| Year Redesigned | # of Models | Total Sales       | % of Sales  |
|-----------------|-------------|-------------------|-------------|
| 2026            | 10          | 83,818            | 1%          |
| 2027            | 38          | 823,932           | 5%          |
| 2028            | 201         | 2,601,172         | 17%         |
| 2029            | 284         | 2,849,875         | 19%         |
| 2030            | 284         | 3,250,190         | 21%         |
| 2031            | 358         | 4,136,099         | 27%         |
| 2032            | 284         | 1,641,242         | 11%         |
| <b>Totals</b>   | <b>1459</b> | <b>15,386,328</b> | <b>100%</b> |

#### 2.6.4.2 Materials and mineral availability

The development of a constraint on PEV production, which is based on an upper bound on GWh of battery production in each year of the analysis, can be found in Section 3.1.5 of this RIA.

Table 2-44 shows the limits, in terms of maximum industry GWh (available for production of U.S. vehicles) that resulted from this assessment and that are applied in OMEGA.

**Table 2-44: Industry Maximum Battery Production Limits (GWh), by Model Year.**

| MY        | 2022 | 2023 | 2024 | 2025 | 2026 | 2027 | 2028 | 2029 | 2030 | 2031 | 2032 | 2033 | 2034 | 2035 |
|-----------|------|------|------|------|------|------|------|------|------|------|------|------|------|------|
| GWh limit | 79   | 150  | 261  | 372  | 483  | 580  | 720  | 860  | 1000 | 1100 | 1200 | 1300 | 1400 | 1500 |

### **2.6.4.3 Credit Banking**

A number of individual manufacturers have accumulated banked credits from MY 2022 and earlier vehicles. These existing credits, shown in Table 2-45, are available for use as a compliance flexibility to carry-forward and offset debit generation in a future year. Given that manufacturers have not previously allowed credits to expire, EPA considers it reasonable to assume that manufacturers will utilize these historical credits. OMEGA allows the use of these historical credits for strategic debit generation in the early years of the analysis.

Credits generated during the analysis years of MY 2023 and later (i.e. not historical credits) are banked and carried forward to be available for use in years where the manufacturer does not comply due to, for example, strategic decision making related to considerations such as redesign intervals, available battery production, consumer demand or other modeled constraints. Debits generated during a particular analysis year are first offset by the use of any available credits from prior years. If any debit remains, the manufacturer will attempt to achieve a lower Mg CO<sub>2</sub> value in the subsequent year than is required by the standards. Those additional credits will be used as carry back credits to offset the prior debit. The maximum credit carry back timeframe is three years, as defined by the standards, so the amount of the offset is either one third, one half, or the entire debit amount depending on whether the number of years remaining before the debit would become past due is 3, 2, or 1 year, respectively.

**Table 2-45: Light-duty Vehicle Historical Mg CO<sub>2</sub> Credit Bank, by Model Year Vintage.**

|                | Credit Vintage (Model Year) |           |            |           |            |            |
|----------------|-----------------------------|-----------|------------|-----------|------------|------------|
|                | 2017                        | 2018      | 2019       | 2020      | 2021       | 2022       |
|                | 79                          | 150       | 261        | 372       | 483        | 580        |
| Aston Martin   |                             |           | 681        | 9,470     | 5,489      | 5,302      |
| BMW            | 2,259,136                   | 138,811   | 281,656    | 117,904   | 582,705    | 297,241    |
| Ferrari        | 1,047                       | 4,192     |            |           |            |            |
| Ford           |                             |           |            | 1,854,402 | 2,118,166  | 1,118,271  |
| General Motors |                             |           |            | 4,021,303 |            | 10,000,000 |
| Honda          | 2,938,779                   | 8,192,781 | 5,365,503  | 2,868,950 | 4,005,904  | 4,599,960  |
| Hyundai        |                             |           |            |           |            | 1,924,619  |
| JLR            |                             |           |            |           | 1,374,461  | 60,900     |
| Kia            |                             |           |            |           |            | -416,089   |
| Lucid          |                             |           |            |           |            | 97,261     |
| Mazda          |                             | 95,569    |            |           |            |            |
| Mercedes Benz  |                             |           |            |           |            | 4,123,493  |
| Mitsubishi     |                             | 144,541   | 105,497    | 56,866    | 476,697    | 559,669    |
| Nissan         | 1,170,458                   | 1,100,000 |            |           | 1,400,000  |            |
| Rivian         |                             |           |            |           |            | 1,385,539  |
| Stellantis     |                             | 6,406,741 | 1,107,0481 | 8443,887  | 12,000,000 |            |
| Subaru         | 2,156,402                   | 2,561,015 | 3,261,822  | 3,041,737 | 2,859,900  | 1,097,819  |
| Tesla          | 1,766                       | 53,704    |            | 208,003   | 13,928     | 60,395     |
| Toyota         | 1,944,036                   | 2,126,707 | 1,596,028  | 16,66,470 | 2,592,586  | 2,380,010  |
| Volvo          | 78,996                      | 778,606   | 316,651    | 215,898   | 831,916    | 1,119,171  |

#### 2.6.4.4 Credit Trading and Credit Market Efficiency

OMEGA uses a two-pass approach to model compliance. On the first pass, the individual manufacturers are consolidated to represent the industry as a whole. The resulting compliance decisions imply "perfect trading" of credits in which the application of technology is applied to individual vehicles in the most cost-effective manner across the entire industry. On the second pass, each manufacturer is modeled in isolation, with their Mg CO<sub>2</sub> goal (the CO<sub>2</sub> target with some offset) in a given year determined from the results from the first pass. To account for a possible future scenario where some portion of industry-wide credits are allowed to expire even as additional technology adoption is required for compliance, OMEGA has a "Credit Market Efficiency" parameter. This parameter value determines the degree to which debit-generating manufacturers from the first modeling pass seek lower Mg CO<sub>2</sub> values in the second pass.

If the Credit Market Efficiency parameter is set to zero, each manufacturer attempts to meet their own Mg CO<sub>2</sub> certification target value without benefiting from the option to purchase credits from other manufacturers. While EPA considers this scenario to be very unlikely given the history of a robust credit market over the past decade, we present results for a "No Trading" sensitivity in RIA Sections 12.1.4 and 12.2.4 for light and medium duty vehicles. If the Credit Market Efficiency is set to one, then the manufacturer Mg CO<sub>2</sub> goal for the second pass is set to the achieved value from the "perfect trading" first pass. If the Credit Market Efficiency is set somewhere in-between zero and one, then "imperfect" trading occurs. As implemented in

OMEGA, manufacturers that were under their Mg CO<sub>2</sub> target (i.e. generating credits) in the first pass will continue to do so on the second pass, and their Mg CO<sub>2</sub> goal will be based on their achieved value from the first pass. Those manufacturers that were over their Mg CO<sub>2</sub> target (i.e. generating debits) in the first pass will be required to apply additional technology to close the gap between their compliance target and achieved Mg CO<sub>2</sub>. In this case, vehicle production costs for those manufacturers will be somewhat higher in the second pass due to the lost credits.

For this rulemaking, EPA has used a Credit Market Efficiency of 0.8, so that over target (debit generating) manufacturers will attempt to close the gap with the compliance target by 20 percent on the second pass. This provides some additional credits for debit generating manufacturers to carry forward and act as a reserve in the event that credits are not purchased in some future year, for any reason. EPA derives this 0.8 value from the 5-year credit life, so that the accumulation of 20 percent reserve credits generated in each year would enable the complete offset of a deficit if no credits are purchased in the fifth year. In our modeling results, the net effect of the credit generators continuing to generate the same credits, and debit generators applying additional technology on the second pass is that there will be some excess of credits that will expire, thereby increasing overall compliance costs in a representation of an imperfect credit market.

#### **2.6.4.5 Producer Generalized Costs and compliance cost minimization**

The producer module in OMEGA determines vehicle technology packages and mix of powertrain types in order to minimize costs while satisfying consumer demand, regulatory requirements, and constraints on vehicle production. More specifically, OMEGA's producer decisions minimize "generalized cost", which includes the cost of manufacturing a vehicle and the producer's assumptions of consumer valuations for key vehicle characteristics that are relevant to modeling compliance. For this rulemaking, EPA has included the producer-assumed consumer valuation of fuel cost and vehicle size (footprint) in the producer generalized cost equation.

We estimate the producer-assumed consumer valuation of fuel cost based on 2.5 years of driving 15,000 miles per year, which is the same value we use for the actual consumer valuation of fuel costs in the new vehicle sales response. As discussed in Chapter 4.4, while there is some evidence that actual fuel cost valuation by consumers may be higher, EPA views the 2.5 year estimate as within the range of the literature, and appropriately conservative since lower-end estimates like this one will tend to indicate less emissions-reducing and fuel-saving technology adoption in the absence of stringent standards.

OMEGA allows manufactures to adjust vehicle footprints, which will influence the modeled vehicle weight, manufacturing cost, and emissions. Depending on the definition of the footprint-based standards, the CO<sub>2</sub> emissions target may also be affected. In terms of a compliance approach which minimizes generalized costs, manufacturers may benefit in some cases by increasing vehicle size, and in other cases by decreasing vehicle size. EPA's main intention for this modeling feature is to assist in the development of footprint curve slopes, with the aim of determining a size-neutral standard which does not incentivize manufacturers to shift the average size of vehicles as a compliance strategy. As discussed in preamble Section I.1.iii, we have used a consumer valuation of \$200 per square foot for increases in vehicle size. This valuation is not intended to capture the effect of differences in vehicle classes, and we did not aim to model substantial changes to vehicle footprints. Thus, we have constrained the allowable footprint

changes to a narrow range of plus or minus 5 percent relative to the base year value for each vehicle.

OMEGA's consumer module considers vehicle price as one of the important elements for modeling consumer purchase decision and powertrain choice (i.e. ICE, PHEV, or BEV), as discussed in Chapter 4.1 and Chapter 4.3. The producer has the ability to influence the price of a vehicle offered, even with no change in production cost, through the use of incentives and cross-subsidies. OMEGA implements an approach where revenue is held constant (relative to no cross-subsidies) while applying cross-subsidies to the powertrain types within each of the three market categories defined by body styles as sedan/wagons, crossover/SUVs, and pickups. For example, if a cost-minimizing compliance strategy involves relatively more BEVs, similar PHEVs, and fewer ICE vehicles, the producer module will generate a set of vehicle offerings where BEV prices are marked down and ICE prices are marked up while maintaining the sales-weighted average price of that vehicle segment. In practice this means that the lower-market-share vehicles will have higher dollar-per-vehicle price changes than the higher-market-share vehicles. If the market shares were equal, then the price increase of one segment would equal the price decrease of the other segment.

OMEGA users can specify a limit to the range of possible cross-subsidies. For this analysis, EPA constrained cross-subsidies to be within 5 percent of the marked up vehicle manufacturing cost. This value lies within the recent historical range of purchase incentives of roughly 3 to 8 percent of vehicle transaction price (Kelley Blue Book 2023a) (Kelley Blue Book 2023b). EPA considers that this is likely a conservative (i.e. low) limit of pricing flexibility, given additional evidence for within-model year price changes for individual nameplates, where manufacturers have made recent adjustments of 10 percent or more for both price decreases (Autoweek 2023) and price increases (GenSao 2022).

OMEGA considers IRA incentives that are provided directly to the consumer, specifically the IRA's 30D purchase incentives, as being applied on top of the producer's cross-subsidized price. These may work to either enhance or act against the producer's cross-subsidy. For example, if a producer's cost-minimizing strategy involves selling fewer BEVs in a given year than is demanded by consumers in the absence of cross-subsidies, they could mark up BEV prices while simultaneously the IRA purchase incentive may bring down the consumer's net purchase cost .

### **2.6.5 Manufacturing capacity**

In addition to availability of critical minerals, the ability to perform final assembly of vehicles that use them could also be understood as a potential constraint on increased production of BEVs. However, EPA notes that major manufacturers are already building a large amount of assembly plant manufacturing capacity both in the U.S. and abroad to meet future demand for these vehicles, and these efforts are poised to continue (see the discussions of announced manufacturer plans and investments in section I.A.2 and IV.C.2 of the preamble). Unlike critical minerals which have fundamental constraints on their production due to limited presence of these resources as well as a relatively long lead time for increasing their extraction, vehicle assembly capacity can respond relatively quickly to the necessary investment commitments. Given the relatively long lead time before MY 2027 when the standards would begin, EPA did not specifically impose a limit on vehicle assembly capacity. However, as described in Chapter 3.1.5 of this RIA, EPA did represent a reasonable rate of battery manufacturing ramp-up by using information about battery manufacturing facilities announced or in operation, and estimates of

lithium availability, to develop a constraint on annual GWh battery demand for use by OMEGA. For more discussion of manufacturing capacity and critical minerals, please see Section IV.C.7 of the preamble and Chapter 3.1 of this RIA.

#### **2.6.6 Fuel and electricity prices used in OMEGA**

OMEGA uses liquid fuel and electricity prices to estimate generalized costs as part of the compliance modeling algorithm. See Table 2-46 and Table 2-47Table 2-47, respectively. OMEGA also uses these fuel prices in estimating fuel expenditures and fuel savings that are included in the benefit-cost analysis results presented in Chapter 9 of this RIA. The OMEGA compliance model makes use of only the retail price while the effects calculations make use of both the retail and the pretax prices.

Note that OMEGA uses different electricity prices in different parts of the model. For compliance costs, electricity and liquid fuel prices play a role in producer/consumer decision-making in that they impact the fuel cost portion of the generalized cost. For compliance, OMEGA uses AEO 2023 electricity prices since those are the prices we believe consumers would be most familiar with and those are the prices AEO uses to generate future fleet mixes which are used to define the future body style and regulatory class mix projections in OMEGA's new vehicle market input file. For effects calculations, we use the electricity prices generated in the Integrated Planning Model and Retail Price Model work presented in Chapter 5 of this RIA. Those prices include impacts of the Inflation Reduction Act along with other market forces driving renewables into the grid mix while driving down electricity prices. Note also that our No Action effects and our Action effects use unique electricity prices as modeled by IPM.



**Table 2-46: AEO2023 Liquid Fuel Prices Used in OMEGA Compliance and Effects Modeling (2022 dollars).**

| Calendar Year | Gasoline            |                    | Diesel              |                    |
|---------------|---------------------|--------------------|---------------------|--------------------|
|               | Pre-tax (\$/gallon) | Retail (\$/gallon) | Pre-tax (\$/gallon) | Retail (\$/gallon) |
| 2027          | 2.53                | 3.05               | 3.20                | 3.74               |
| 2028          | 2.53                | 3.05               | 3.10                | 3.63               |
| 2029          | 2.54                | 3.06               | 3.11                | 3.65               |
| 2030          | 2.56                | 3.07               | 3.12                | 3.65               |
| 2031          | 2.56                | 3.06               | 3.15                | 3.67               |
| 2032          | 2.58                | 3.08               | 3.17                | 3.69               |
| 2033          | 2.59                | 3.09               | 3.19                | 3.71               |
| 2034          | 2.60                | 3.10               | 3.20                | 3.71               |
| 2035          | 2.61                | 3.10               | 3.23                | 3.74               |
| 2036          | 2.65                | 3.13               | 3.24                | 3.74               |
| 2037          | 2.66                | 3.14               | 3.26                | 3.76               |
| 2038          | 2.67                | 3.15               | 3.28                | 3.78               |
| 2039          | 2.68                | 3.16               | 3.29                | 3.78               |
| 2040          | 2.69                | 3.17               | 3.30                | 3.79               |
| 2041          | 2.69                | 3.16               | 3.33                | 3.81               |
| 2042          | 2.71                | 3.17               | 3.33                | 3.81               |
| 2043          | 2.70                | 3.16               | 3.35                | 3.83               |
| 2044          | 2.72                | 3.18               | 3.34                | 3.82               |
| 2045          | 2.72                | 3.18               | 3.35                | 3.82               |
| 2046          | 2.78                | 3.27               | 3.39                | 3.90               |
| 2047          | 2.78                | 3.27               | 3.40                | 3.91               |
| 2048          | 2.81                | 3.30               | 3.41                | 3.91               |
| 2049          | 2.82                | 3.30               | 3.42                | 3.92               |
| 2050          | 2.85                | 3.33               | 3.43                | 3.92               |
| 2051          | 2.88                | 3.36               | 3.43                | 3.93               |
| 2052          | 2.91                | 3.39               | 3.43                | 3.93               |
| 2053          | 2.95                | 3.42               | 3.44                | 3.93               |
| 2054          | 2.98                | 3.45               | 3.44                | 3.93               |
| 2055          | 3.01                | 3.48               | 3.45                | 3.93               |

**Table 2-47: Electricity Prices used in OMEGA Compliance and Effects Modeling (2022 dollars).**

| Calendar Year | Compliance Model | Effects No Action |                 | Effects Action   |                 |
|---------------|------------------|-------------------|-----------------|------------------|-----------------|
|               | Retail (\$/kWh)  | Pre-tax (\$/kWh)  | Retail (\$/kWh) | Pre-tax (\$/kWh) | Retail (\$/kWh) |
| 2027          | 0.130            | 0.112             | 0.119           | 0.112            | 0.118           |
| 2028          | 0.129            | 0.113             | 0.119           | 0.112            | 0.118           |
| 2029          | 0.128            | 0.110             | 0.116           | 0.109            | 0.116           |
| 2030          | 0.129            | 0.107             | 0.113           | 0.107            | 0.113           |
| 2031          | 0.129            | 0.106             | 0.113           | 0.107            | 0.113           |
| 2032          | 0.130            | 0.106             | 0.112           | 0.106            | 0.113           |
| 2033          | 0.132            | 0.105             | 0.111           | 0.106            | 0.112           |
| 2034          | 0.133            | 0.104             | 0.110           | 0.106            | 0.112           |
| 2035          | 0.134            | 0.103             | 0.109           | 0.106            | 0.112           |
| 2036          | 0.134            | 0.103             | 0.109           | 0.106            | 0.112           |
| 2037          | 0.135            | 0.103             | 0.110           | 0.106            | 0.112           |
| 2038          | 0.137            | 0.104             | 0.110           | 0.106            | 0.112           |
| 2039          | 0.138            | 0.104             | 0.110           | 0.105            | 0.112           |
| 2040          | 0.139            | 0.104             | 0.110           | 0.105            | 0.111           |
| 2041          | 0.140            | 0.103             | 0.109           | 0.105            | 0.111           |
| 2042          | 0.140            | 0.102             | 0.108           | 0.104            | 0.110           |
| 2043          | 0.140            | 0.102             | 0.107           | 0.104            | 0.110           |
| 2044          | 0.141            | 0.101             | 0.107           | 0.103            | 0.109           |
| 2045          | 0.141            | 0.100             | 0.106           | 0.102            | 0.108           |
| 2046          | 0.141            | 0.099             | 0.105           | 0.102            | 0.108           |
| 2047          | 0.140            | 0.098             | 0.104           | 0.101            | 0.107           |
| 2048          | 0.140            | 0.098             | 0.103           | 0.100            | 0.106           |
| 2049          | 0.140            | 0.097             | 0.102           | 0.099            | 0.105           |
| 2050          | 0.139            | 0.096             | 0.101           | 0.098            | 0.104           |
| 2051          | 0.137            | 0.096             | 0.101           | 0.098            | 0.104           |
| 2052          | 0.136            | 0.096             | 0.101           | 0.098            | 0.104           |
| 2053          | 0.135            | 0.096             | 0.101           | 0.098            | 0.104           |
| 2054          | 0.134            | 0.096             | 0.101           | 0.098            | 0.104           |
| 2055          | 0.133            | 0.096             | 0.101           | 0.098            | 0.104           |

### **2.6.7 Gross Domestic Product Price Deflators**

To adjust all monetary inputs used in OMEGA to a consistent dollar basis, OMEGA uses the gross domestic product (GDP) implicit price deflators shown in Table 2-48. These deflators were generated by the Bureau of Economic Analysis, Table 1.1.9, revised on April 27, 2023.

**Table 2-48: Gross domestic product implicit price deflators.**

| Calendar Year | GDP Implicit Price Deflator |
|---------------|-----------------------------|
| 2000          | 78.025                      |
| 2001          | 79.783                      |
| 2002          | 81.026                      |
| 2003          | 82.625                      |
| 2004          | 84.843                      |
| 2005          | 87.504                      |
| 2006          | 90.204                      |
| 2007          | 92.642                      |
| 2008          | 94.419                      |
| 2009          | 95.024                      |
| 2010          | 96.166                      |
| 2011          | 98.164                      |
| 2012          | 100                         |
| 2013          | 101.751                     |
| 2014          | 103.654                     |
| 2015          | 104.691                     |
| 2016          | 105.74                      |
| 2017          | 107.749                     |
| 2018          | 110.339                     |
| 2019          | 112.318                     |
| 2020          | 113.784                     |
| 2021          | 118.895                     |
| 2022          | 127.224                     |

### **2.6.8 Inflation Reduction Act**

OMEGA explicitly accounts for two elements of the Inflation Reduction Act in compliance modeling: the IRS Section 45X production tax credit of up to a combined \$45 per kWh for battery cells and modules, and the combined effect of the 30D Clean Vehicle Credit and the 45W Commercial Clean Vehicle credit. Note that the No Action and Action scenarios in OMEGA use identical treatment of IRA incentives.

The 45X production tax credit is treated within the modeling as a reduction in direct manufacturing costs, which in turn is assumed to result in a reduction in purchase price for the consumer after the application of the Retail Price Equivalent (RPE) factor. The credit phases out by statute from 2030 through 2032. For discussion of how EPA estimated these values, see section IV.C.2 of the preamble.

The resulting value of the credit applied in OMEGA, in terms of dollars per kWh of gross battery capacity, is shown in Table 2-49. These represent an average credit amount across the industry as a whole.

**Table 2-49: IRA Battery Production Tax Credits in OMEGA.**

| Year | Tax credit value (\$/kWh) | % of maximum available credit |
|------|---------------------------|-------------------------------|
| 2023 | \$22.50                   | 50.0%                         |
| 2024 | \$24.11                   | 53.6%                         |
| 2025 | \$25.71                   | 57.1%                         |
| 2026 | \$27.32                   | 60.7%                         |
| 2027 | \$28.93                   | 64.3%                         |
| 2028 | \$30.54                   | 67.9%                         |
| 2029 | \$32.14                   | 71.4%                         |
| 2030 | \$25.31                   | 75%                           |
| 2031 | \$19.69                   | 87.5%                         |
| 2032 | \$11.25                   | 100%                          |
| 2033 | \$0                       | -                             |

The IRS 30D and 45W Clean Vehicle Credits are reflected in the modeling through their effect on vehicle purchase costs, and therefore have an influence on the shares of PEVs demanded by consumers. The purchase incentive is assumed to be realized entirely by the consumer and does not impact the producer generalized cost value or the manufacturing cost. While the restrictions imposed by the IRA on the 30D credit (income, MSRP, critical mineral content, and manufacturing content) limit the vehicles which are eligible for the full \$7,500 incentive under 30D, we expect that manufacturers will work to increase the number of vehicles that qualify over time due to the high marketing value of the credit. Further, we expect that the IRS 45W Clean Commercial Vehicle Credit, which is not subject to many of the restrictions on the 30D credit, will likely impact a significant portion of PEV sales, through fleet purchases and also through reduced cost of vehicle leasing to consumers. For these reasons, we have conceptualized the purchase incentive as a combination of the average value 30D and 45W credits realized per PEV across the new vehicle fleet as a whole. The resulting values of the credit applied in OMEGA are shown in Table 2-50. For discussion of how EPA estimated these values, see section IV.C.2 of the preamble. We have also assessed sensitivities on the IRA assumptions as described further in Chapter 12.1.4 of this RIA.

**Table 2-50: IRS 30D and 45W Clean Vehicle Credit in OMEGA.**

| Model Year | Combined 30D and 45W Value | % of maximum available credit |
|------------|----------------------------|-------------------------------|
| 2023       | \$2925                     | 39%                           |
| 2024       | \$3225                     | 43%                           |
| 2025       | \$3300                     | 44%                           |
| 2026       | \$3300                     | 44%                           |
| 2027       | \$3600                     | 48%                           |
| 2028       | \$3750                     | 50%                           |
| 2029       | \$3900                     | 52%                           |
| 2030       | \$4125                     | 55%                           |
| 2031       | \$5075                     | 68%                           |
| 2032       | \$6000                     | 80%                           |
| 2033       | \$0                        | -                             |

## Chapter 2 References

75 FR 25324. 2010. (May 7). <https://www.govinfo.gov/content/pkg/FR-2010-05-07/pdf/2010-8159.pdf>.

77 FR 62624. 2012. (October 15). <https://www.govinfo.gov/content/pkg/FR-2012-10-15/pdf/2012-21972.pdf>.

86 FR 74434. 2021. (December 30). <https://www.govinfo.gov/content/pkg/FR-2021-12-30/pdf/2021-27854.pdf>.

88 FR 4296. 2023. (January 24). <https://www.federalregister.gov/documents/2023/01/24/2022-27957/control-of-air-pollution-from-new-motor-vehicles-heavy-duty-engine-and-vehicle-standards>.

ANL. 2024. Cost Analysis and Projections for U.S.-Manufactured Automotive Lithium-Ion Batteries. Argonne National Laboratory.

Autoweek. 2023. Ford Drops F-150 Lightning Prices, Citing Incoming Production Bump. 7 17. Accessed 3 6, 2024. <https://www.autoweek.com/news/industry-news/a44564656/ford-150-lightning-prices-2023/>.

Bhattacharjya, Shuvodeep, Paul Chambon, Graham Conway, Robert Mitchell, Piyush Bhagdikar, Kevin Whitney, Tom Reinhart, Kevin Hoag, Joseph McDonald, and Shabbir Ahmed. 2023. Heavy-light-duty and Medium-duty Range-extended Electric Truck Study. Contract Report, Ann Arbor, Michigan: US EPA.

Bolon, Kevin, Andrew Moskalik, Kevin Newman, Aaron Hula, Anthony Neam, and and Brandon Mikkelsen. 2018. "Characterization of GHG Reduction Technologies in the Existing Fleet." SAE Technical Paper 2018-01-1268. doi:10.4271/2018-01-1268.

Cherry, Jeff, and Todd Sherwood. 2023. "Availability of Cost Estimation Curves and Data Generated by FEV." U.S. EPA, August.

Dekraker, Paul, John Kargul, Andrew Moskalik, Kevin Newman, Mark Doorlag, and and Daniel Barba. 2017. "Fleet-Level Modeling of Real World Factors Influencing Greenhouse Gas Emission Simulation in ALPHA." SAE Int. J. Fuels Lubr. 10 (1): 217-235. doi:10.4271/2017-01-0899.

FEV Consulting Inc. 2022. "Cost and Technology Evaluation, Conventional Powertrain Vehicle Compared to an Electrified Powertrain Vehicle, Same Vehicle Class and OEM." Contract Report for the U.S. EPA, Contract No. 68HERC19D00008.

Foundation, Python Software. 2023. "Python." <https://www.python.org/>.

—. 2023. "sklearn." <https://pypi.org/project/sklearn/>.

- GenSao. 2022. Tesla Motors Club. 4 7. Accessed 3 6, 2024. <https://teslamotorsclub.com/tmc/threads/another-price-increase-tonight-04-06-2022.263312/#post-6594645>.
- ICF International. 2022. EPA-420-R-23-004: Peer Review of Electrified Vehicle Simulations within EPA's ALPHA Model. US EPA.
- Kelley Blue Book. 2023a. Average New Car Price Falling; Incentives Making a Comeback. 3 8. Accessed 03 6, 2024. <https://www.kbb.com/car-news/average-new-car-price-falling-incentives-making-a-comeback/>.
- . 2023b. U.S. New-Vehicle Prices Down Year over Year for Third Straight Month; Market Shifts toward Buyers as Incentives Climb, Profit Margins Squeezed. 12 11. Accessed 3 6, 2024. <https://www.prnewswire.com/news-releases/us-new-vehicle-prices-down-year-over-year-for-third-straight-month-market-shifts-toward-buyers-as-incentives-climb-profit-margins-squeezed-302011706.html>.
- Kleijnen, Jack P.C. 2015. "Response Surface Methodology." In Handbook of Simulation Optimization, by Michael C. Fu, 81-104. New York, NY: Springer. doi:10.1007/978-1-4939-1384-8.
- Lee, SoDuk, Jeff Cherry, Michael Safoutin, Anthony Neam, Joseph McDonald, and Kevin Newman. 2018. "Modeling and Controls Development of 48 V Mild Hybrid Electric Vehicles." SAE Technical Paper 2018-01-0413. doi:10.4271/2018-01-0413.
- Moskalik, Andrew. 2020. "Using Transmission Data to Isolate Individual Losses in Coastdown Road Load Coefficients." SAE International Journal of Advances and Current Practices in Mobility 4 (1): 2156-2171. doi:10.4271/2020-01-1064.
- Munro and Associates. 2018. "2017 Tesla Model 3 Cost Analysis."
- Munro and Associates. 2020c. "2020 Tesla Model Y Cost Analysis."
- Munro and Associates. 2020b. "3 Inverter Side-by-Side Analysis."
- Munro and Associates. 2021. "6 Inverter Side-by-Side Analysis."
- Munro and Associates. 2016. "BMW i3 Cost Analysis."
- Munro and Associates. 2020a. "Twelve Motor Side-by-Side Analysis."
- Newman, Kevin, John Kargul, and Dan Barba. 2015a. "Benchmarking and Modeling of a Conventional Mid-Sized Car Using ALPHA." SAE Technical Paper 2015-01-1140. doi:10.4271/2015-01-1140.
- Newman, Kevin, John Kargul, and Dan Barba. 2015b. "Development and Testing of an Automatic Transmission Shift Schedule Algorithm for Vehicle Simulation." SAE International Journal of Engines 8 (3). doi:10.4271/2015-01-1142.
- NREL. 2019. "Fuel Cell Electric Vehicle Durability and Fuel Cell Performance NREL/TP-5400-73011." <https://www.nrel.gov/docs/fy19osti/73011.pdf>.

Rogozhin, A., et al. 2009. "Using indirect cost multipliers to estimate the total cost of adding new technology in the automobile industry." *International Journal of Production Economics*.

RTI International. 2018. Peer Review of EPA's Response Surface Equation Report, Report EPA-420-R-18-006. EPA. <https://nepis.epa.gov/Exe/ZyPURL.cgi?Dockey=P100VK3Z.txt>.

SAE. 2010. "Recommended Practice for Measuring the Exhaust Emissions and Fuel Economy of Hybrid-Electric Vehicles, Including Plug-in Hybrid Vehicles." SAE Standard J1711.

U.S. EPA. 2023a. Advanced Light-Duty Powertrain and Hybrid Analysis (ALPHA) Tool. Accessed February 2, 2023. <https://www.epa.gov/regulations-emissions-vehicles-and-engines/advanced-light-duty-powertrain-and-hybrid-analysis-alpha>.

—. 2022c. "ALPHA Documentation 0.2.0 documentation." Accessed 11 17, 2022. [https://epa-alpha-model.readthedocs.io/\\_/downloads/en/latest/pdf/](https://epa-alpha-model.readthedocs.io/_/downloads/en/latest/pdf/).

—. 2023b. Combining Data into Complete eMotor ALPHA Maps. <https://www.epa.gov/vehicle-and-fuel-emissions-testing/combining-data-complete-emotor-alpha-maps>.

—. 2023c. Combining Data into Complete Engine ALPHA Maps. Accessed February 2, 2023. <https://www.epa.gov/vehicle-and-fuel-emissions-testing/combining-data-complete-engine-alpha-maps>.

U.S. EPA. 2016. "Cost Reduction through Learning in Manufacturing Industries and in the Manufacture of Mobile Sources, EPA-420-R-16-018." <https://nepis.epa.gov/Exe/ZyPDF.cgi?Dockey=P100PUSX.PDF>.

—. 2022e. "Data from Cars used for Testing Fuel Economy." <https://www.epa.gov/compliance-and-fuel-economy-data/data-cars-used-testing-fuel-economy>.

—. 2016a. "EPA-420-R-16-020: Proposed Determination on the Appropriateness of the Model Year 2022-2025 Light-Duty Vehicle Greenhouse Gas Emissions Standards under the Midterm Evaluation." November. <https://nepis.epa.gov/Exe/ZyPDF.cgi?Dockey=P100Q3DO.pdf>.

—. 2016b. "EPA-420-R-16-021: Proposed Determination on the Appropriateness of the Model Year 2022-2025 Light-Duty Vehicle Greenhouse Gas Emissions Standards under the Midterm Evaluation: Technical Support Document." November. Accessed November 3, 2022. <https://nepis.epa.gov/Exe/ZyPDF.cgi?Dockey=P100Q3L4.pdf>.

—. 2017a. "EPA-420-R-17-001: Final Determination on the Appropriateness of the Model Year 2022-2025 Light-Duty Vehicle Greenhouse Gas Emissions Standards under the Midterm Evaluation." <https://nepis.epa.gov/Exe/ZyPDF.cgi?Dockey=P100QQ91.pdf>.

—. 2017b. "EPA-420-R-17-002: Final Determination on the Appropriateness of the Model Year 2022-2025 Light-Duty Vehicle Greenhouse Gas Emissions Standards under the Midterm Evaluation: Response to Comments." January. <https://nepis.epa.gov/Exe/ZyPDF.cgi?Dockey=P100QQ9Y.pdf>.

U.S. EPA. 2023. External Peer Review of EPA's OMEGA Model. Peer Review Report, Ann Arbor: EPA.

—. 2024. OMEGA Documentation. <https://omega2.readthedocs.io/en/2.5.0/>.

U.S. EPA. 2023. Peer Review of Electrified Vehicle Simulations within EPA's ALPHA Model. Peer Review Report, Ann Arbor: EPA.

—. 2022b. Technical Publications and Presentations Concerning Benchmarking. Accessed 11 17, 2022. <https://www.epa.gov/vehicle-and-fuel-emissions-testing/benchmarking-advanced-low-emission-light-duty-vehicle-technology>.

U.S. EPA; U.S. DOT-NHTSA; CARB. 2016. "EPA-420-D-16-900: Draft Technical Assessment Report: Midterm Evaluation of Light-Duty Vehicle Greenhouse Gas Emission Standards and Corporate Average Fuel Economy Standards for Model Years 2022 - 2025." July. <https://nepis.epa.gov/Exe/ZyPDF.cgi/P100OXEO.PDF?Dockey=P100OXEO.PDF>.

US DOE & EPA. 2024. Download Fuel Economy Data. Accessed 02 07, 2024. <https://www.fueleconomy.gov/feg/download.shtml>.

Yamagishi, Tomoya, and Takashi Ishikura. 2018. "Development of Electric Powertrain for CLARITY PLUG-IN HYBRID, SAE No. 2018-01-0415." *Int. J. Alt. Power. (SAE)* 7 (3): 323-333. doi:10.4271/2018-01-0415.

Zhuanga, W., S. Li (Eben), X. Zhang, D. Kum, Z. Song, G. Yin, and F. Ju. 2020. "A survey of powertrain configuration studies on hybrid electric vehicles." *Journal of Applied Energy* 262 (114553). doi:10.1016/j.apenergy.2020.114553.



## **Chapter 3: Analysis of Technology Feasibility**

This chapter summarizes our assessment of the feasibility of the final greenhouse gas (GHG) and criteria pollutant emission standards. It includes a description of the wide range of emissions control technologies considered for criteria pollutant exhaust and evaporative emissions, GHG emissions control, and on-board diagnostics.

EPA has assessed the feasibility of the standards in light of current and anticipated progress by automakers in developing and deploying new emissions-reducing technologies. The primary body of our assessment of these topics resides in the preamble, where we develop our conclusions regarding technology feasibility including availability of advanced technologies, PEV feasibility, critical minerals, manufacturing capacity, and mineral security, as well as other aspects of feasibility of compliance with the standards. This Section 3.1 serves to provide a review of key topics relating to these aspects of feasibility and additional information we considered relating to GHG technology application to light- and medium-duty vehicles. For references and full discussion please refer to the specific preamble sections cited in each section and where applicable, other relevant sections of the preamble and RIA.

Section 3.1.1 reviews recent trends and feasibility of the wide range of light-duty vehicle technologies that manufacturers have available to meet the standards. Similarly, Section 3.1.2 discusses recent trends in medium-duty vehicle technology, focusing primarily on electrification. Section 3.1.3 reviews major highlights of our consideration of PEV technology feasibility, largely referring to the main arguments presented in Section IV.C.7 of the preamble to this rule. Section 3.1.4 provides a review of major highlights of our consideration of critical minerals, battery cell manufacturing, and mineral security, and also refers to Section IV.C.7 of the preamble. Section 3.1.5 provides technical detail on our development of a constraint on PEV market penetration used in OMEGA, based on our assessment of lithium availability and battery manufacturing capacity.

### **3.1 Vehicle Technologies and Trends**

#### **3.1.1 Light-Duty Vehicle Technologies and Trends**

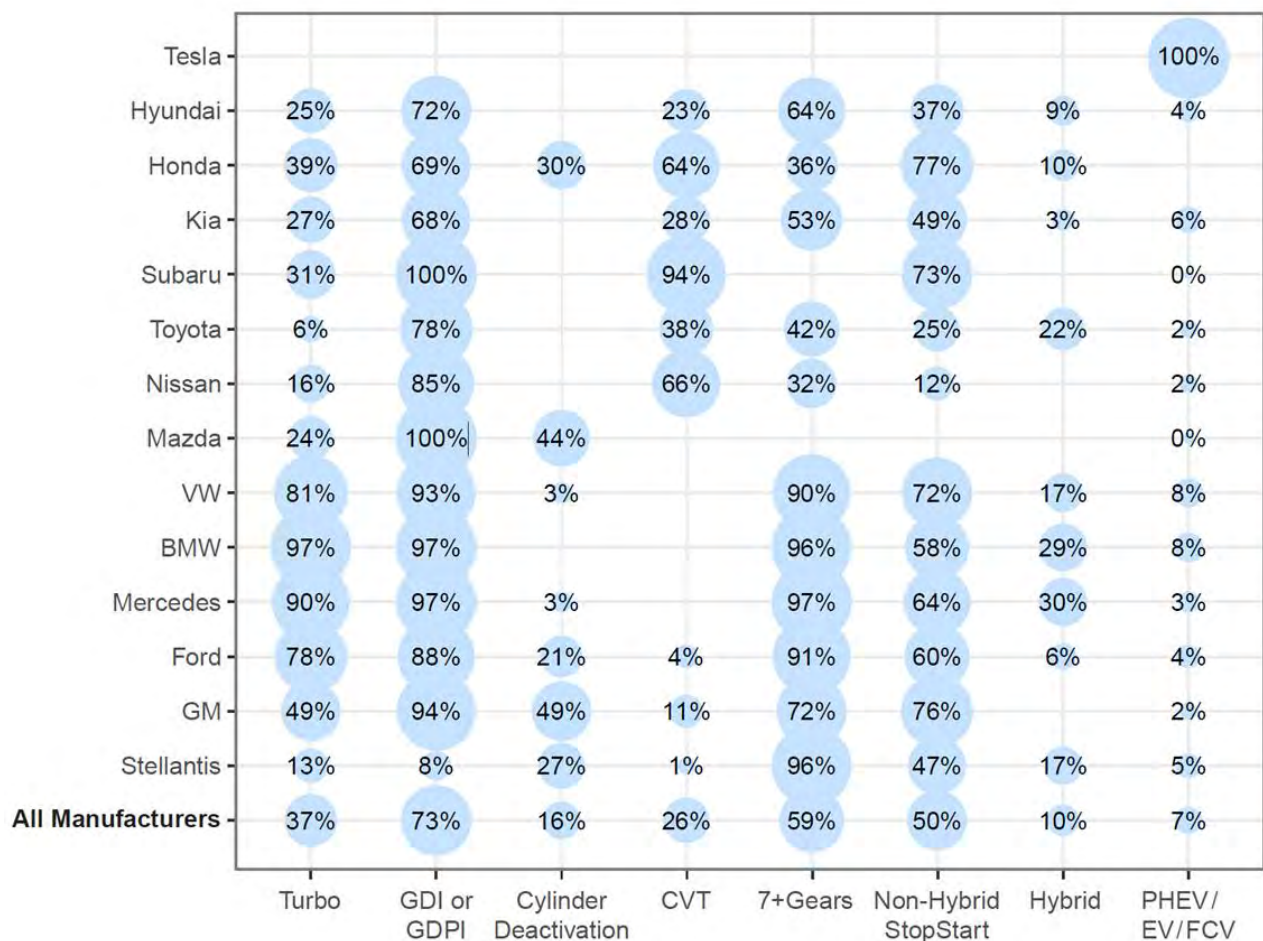
##### **3.1.1.1 Advanced ICE technologies**

Compliance with the EPA GHG standards over the past decade has been achieved predominantly through the application of advanced technologies to internal combustion engine (ICE) vehicles. For example, in the analyses performed for the 2012 rule (77 FR 62624 2012), the Draft Technical Assessment Report (TAR) for the Midterm Evaluation (MTE) of the 2022-2025 standards (U.S. EPA, CARB, U.S. DOT NHTSA 2016), the 2016 Proposed Determination (U.S. EPA 2016), and the 2021 rule (86 FR 74434 2021), a significant portion of EPA's analysis included an assessment of technologies available to manufacturers for achieving compliance with the standards. Advanced ICE technologies were identified as playing a major role in manufacturer compliance with the emission reductions required by those rules.

Innovation in the automobile industry has led to a wide array of technology available to manufacturers to achieve goals for performance, fuel economy and CO<sub>2</sub> emissions (U.S. EPA 2023). Figure 3-1 illustrates manufacturer-specific technology usage for model year 2022, with larger circles representing higher usage rates (U.S. EPA 2023). These technologies are all being used by manufacturers to, in part, reduce CO<sub>2</sub> emissions and increase fuel economy. Each of the

fourteen largest manufacturers have adopted several of these technologies into their vehicles, with many manufacturers achieving very high penetrations of several technologies. It is also clear that manufacturers’ strategies to develop and adopt new technologies are unique and vary significantly, as each manufacturer is choosing technologies that best meet the design requirements of their vehicles and the needs of their customer base.

Engine technologies such as turbocharged engines (Turbo) and gasoline direct injection (GDI) allow for more efficient engine design and operation. Cylinder deactivation (CD) allows for use of only a portion of the engine when less power is needed, while stop/start systems can turn off the engine entirely at idle to save fuel. Hybrid vehicles use a larger battery to recapture braking energy and provide power when necessary, allowing for a smaller, more efficiently operated engine. The hybrid category includes strong hybrid systems that can temporarily power the vehicle without engaging the engine and smaller “mild” hybrid systems that cannot propel the vehicle by electric power alone. Transmissions that have more gear ratios, or speeds, allow the engine to more frequently operate near peak efficiency. Two categories of advanced transmissions are shown in Figure 3-1. In model year 2022, hybrid vehicles reached a new high of 10 percent of all production. This increase was mostly due to the growth of hybrids in the truck SUV and pickup vehicle types.



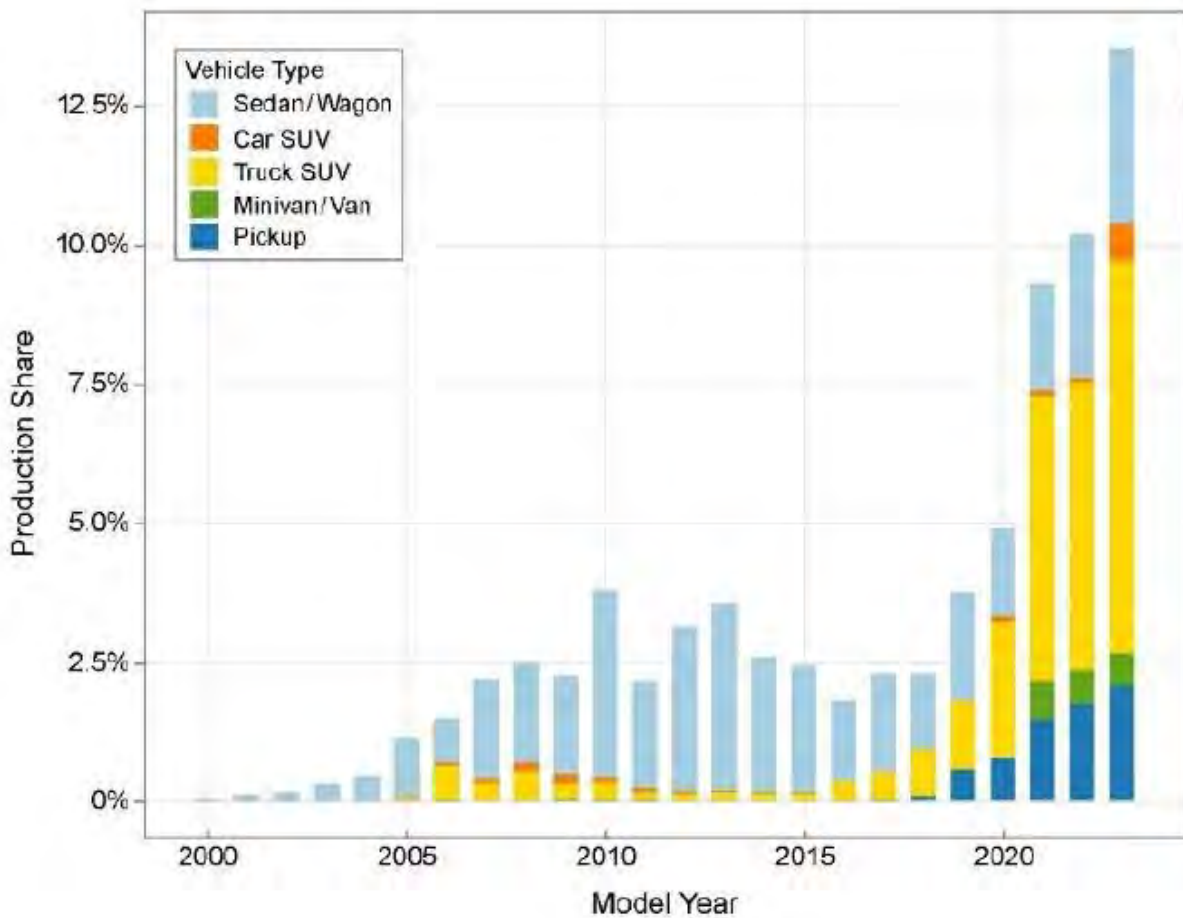
**Figure 3-1: Manufacturer Use of Key Technologies in Model Year 2022.**

### **3.1.1.2 Hybrid Electric Technologies**

Hybrid electric vehicles (HEVs) were first introduced in the U.S. marketplace in model year 2000 with the Honda Insight and the Toyota Prius. As more models and options were introduced, hybrid production increased to 3.8 percent of all vehicles in model year 2010, before declining somewhat over the next several years. However, in model year 2022 hybrid production reached a new high at 10.2 percent and is projected to reach 13.6 percent in model year 2023, as shown in Figure 3-2 (U.S. EPA 2023).

The growth in hybrid vehicles is largely attributable to growth outside of the sedan/wagon vehicle type. In model year 2020 the production of hybrids in the truck SUV category (largely mild HEVs) surpassed the production of sedan/wagon hybrids for the first time and did so by more than 50 percent. Hybrids also began to penetrate the pickup and minivan/van vehicle types. However, there remain very few hybrid car SUVs. Sedan/wagon hybrids accounted for only 25 percent of all hybrid production in model year 2022.

The growth of hybrids in the pickup vehicle type is largely due to the introduction of “mild” hybrid systems that are capable of regenerative braking and many of the same functions as other hybrids but utilize a smaller battery and an electrical motor that cannot directly drive the vehicle. These mild hybrids accounted for about 40 percent of hybrid production in model year 2022.



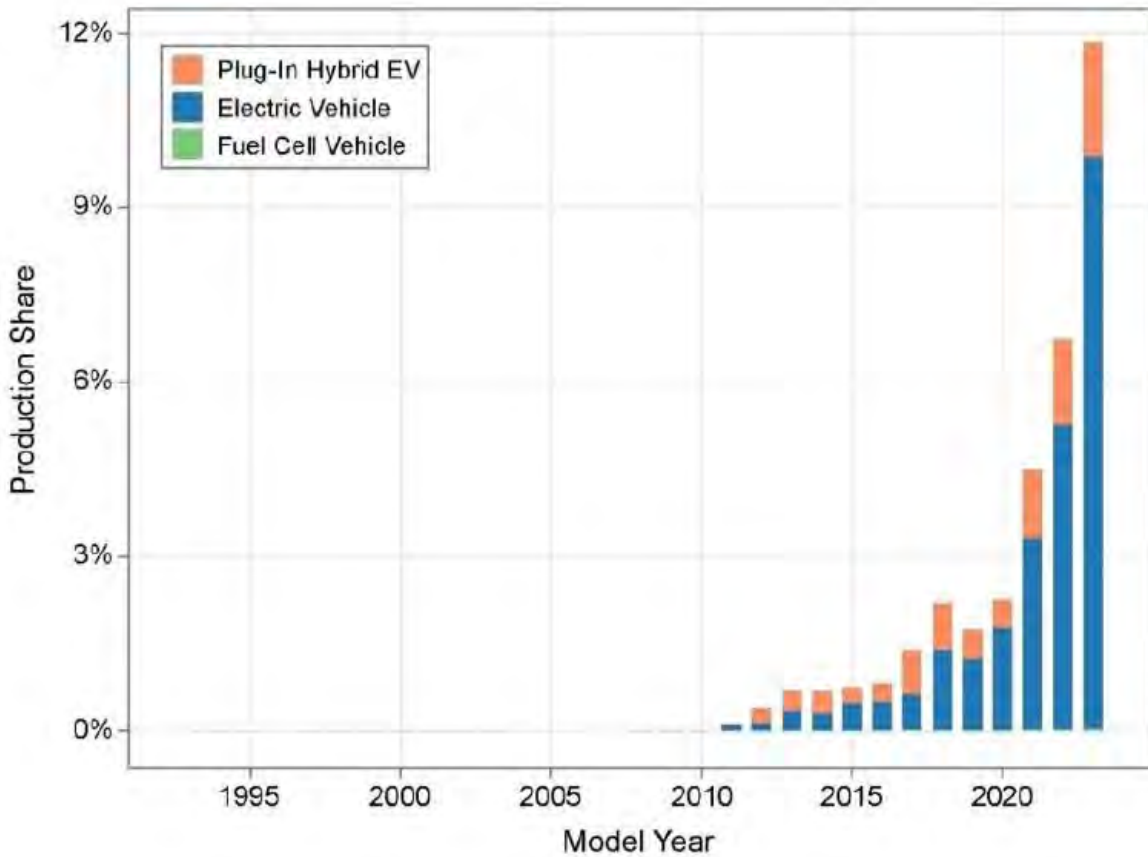
**Figure 3-2: Gasoline Hybrid Engine Production Share by Vehicle Type.**

### 3.1.1.3 Plug-in Electric Vehicle Technologies

The previously described trend in application of BEV and PHEV technologies to light-duty vehicles is evidence of a continuing shift toward electrification across the vehicle industry. As described in detail in the Executive Summary of the preamble (Section I.A.2), recent trends in market penetration of PEVs show that demand for these vehicles in the U.S. is increasing, as the production of new PEVs (including both BEVs and PHEVs) is roughly doubling each year. As also described at length in that section, manufacturers have increasingly allocated large amounts of new investment to electrification technologies including HEVs, PHEVs and BEVs. For more discussion of these rapidly increasing trends, see Section I.A.2 of the preamble.

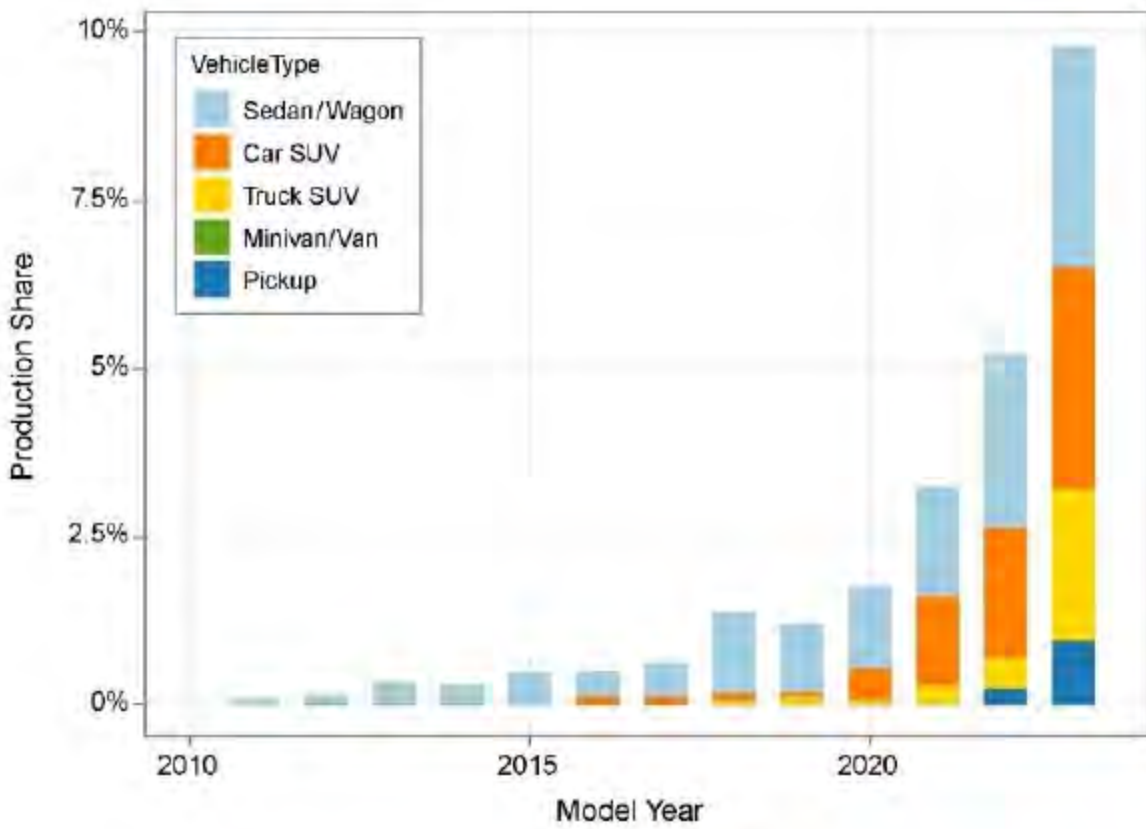
The production of BEVs and PHEVs has increased rapidly in recent years. Prior to model year 2011, BEVs were available, but generally only in small numbers for lease in California. In model year 2011 the first commercially available PHEV, the Chevrolet Volt, was introduced along with the Nissan Leaf BEV. Many additional models have been introduced since, and in model year 2022 combined BEV/PHEV production reached almost 7 percent of all new vehicles. Combined BEV and PHEV production is projected to reach a new high of 12 percent of all production in model year 2023. The trend in BEVs, PHEVs, and FCEVs are shown in Figure 3-3 (U.S. EPA

2023).

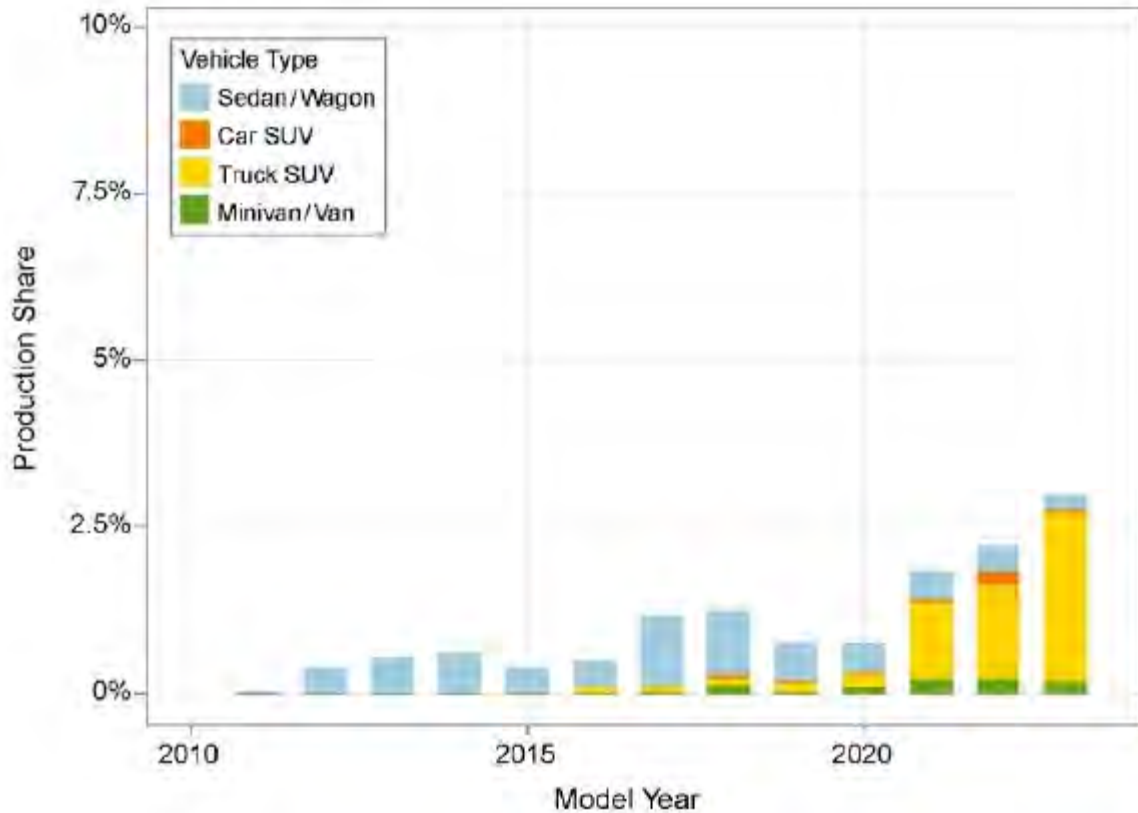


**Figure 3-3: Production Share of BEVs, PHEVs, and FCEVs.**

The inclusion of model year 2022 BEV, PHEV, and FCEV sales reduces the overall new vehicle average CO<sub>2</sub> emissions by 22 g/mi, and this impact will continue to grow if production of these vehicles increases. In model year 2021 there were three hydrogen FCEV models produced, but they were only available in the state of California and Hawaii and in very small numbers. However, there continues to be interest in FCEVs as a future technology. Figure 3-4 and Figure 3-5 (U.S. EPA 2023) show the production share by vehicle type for BEVs and PHEVs. Early production of BEVs was mostly in the sedan/wagon vehicle type, but recent model years have shown growth in car SUVs and truck SUVs. Electric pickup trucks are entering the market in model year 2022, along with new EV models across many of the vehicle types. Production of PHEVs has shifted from exclusively sedan/wagons to mostly truck SUVs, with limited production across the sedan/wagon, car SUV, and minivan/van vehicle types.



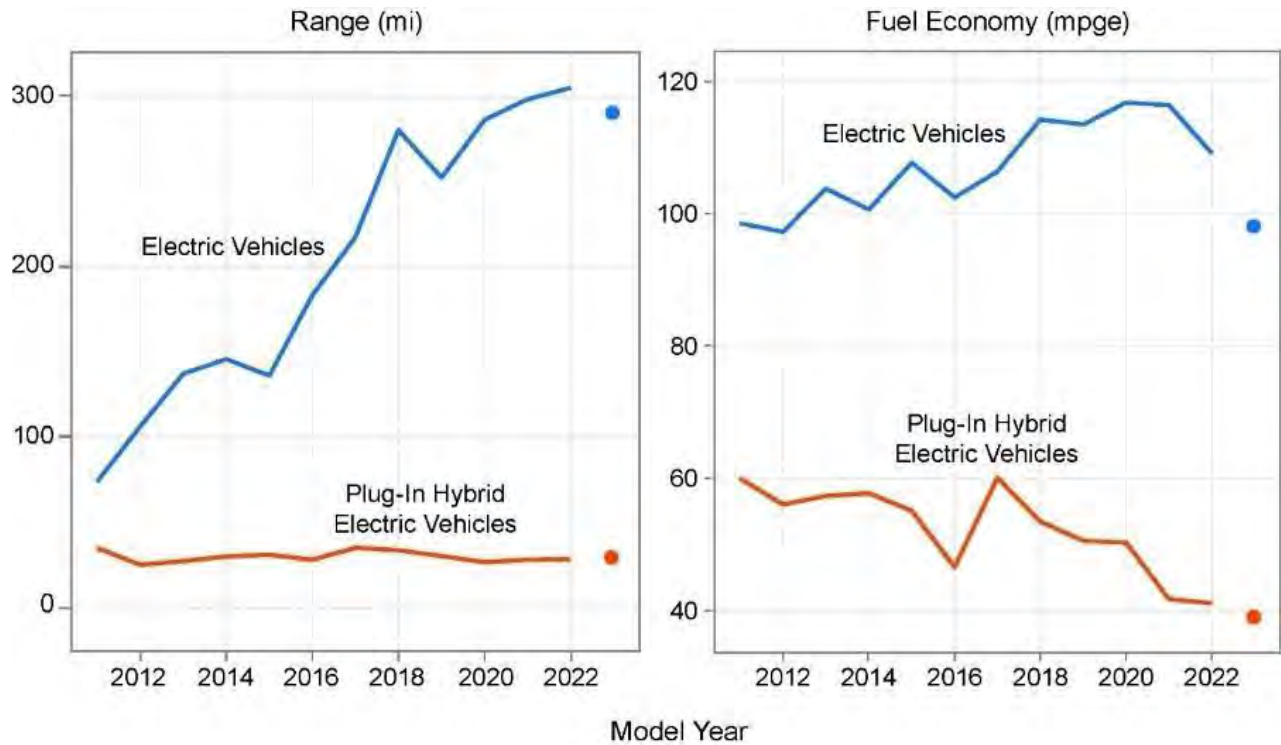
**Figure 3-4: Electric Vehicle Production Share by Vehicle Type.**



**Figure 3-5: Plug-In Hybrid Vehicle Production Share by Vehicle Type.**

Figure 3-6 (U.S. EPA 2023) shows the range and fuel economy trends for EVs and PHEVs. The average range of new BEVs has climbed substantially. In model year 2022 the average new BEV range is 305 miles, or more than four times the range of an average BEV in 2011. The range values shown for PHEVs are the charge-depleting range, where the vehicle is operating on energy in the battery from an external source. This is generally the electric range of the PHEV, although some vehicles also use the gasoline engine in small amounts during charge depleting operation. The average charge depleting range for PHEVs has remained largely unchanged since model year 2011.

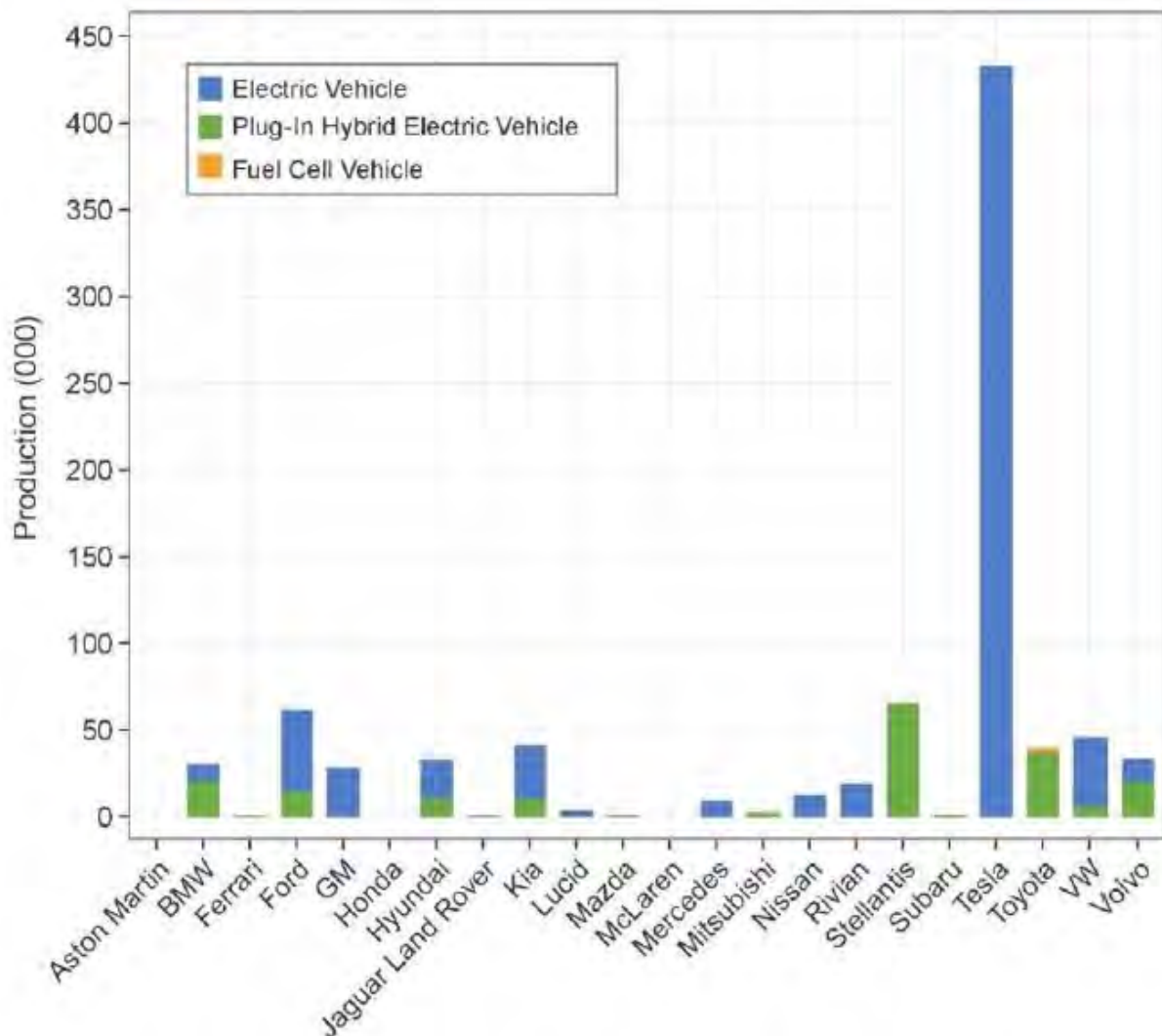
Along with improving range, the fuel economy of electric vehicles has also improved as measured in miles per gallon of gasoline equivalent (mpge). The fuel economy of electric vehicles increased by about 10 percent between model years 2011 and 2022 (a decrease in 2022 due to the introduction of larger vehicles). The combined fuel economy of PHEVs has been more variable but is about 30 percent lower in model year 2022 than in model year 2011. This decrease may be attributable to the growth of truck SUV PHEVs.



**Figure 3-6: Charge Depleting Range and Fuel Economy for BEVs and PHEVs.**

Figure 3-7 (U.S. EPA 2023) shows the model year 2022 production volume of BEVs, PHEVs and FCEVs. More than 1.3 million BEVs, PHEVs, and FCEVs were produced in the 2022 model year. Of those vehicles, about 78 percent were BEVs, 22 percent were PHEVs, and less than 1 percent were FCEVs.





**Figure 3-7: Model Year 2022 Production of BEVs, PHEVs, and FCEVs.**

### **3.1.2 Medium-duty Vehicle Technologies and Trends**

The medium-duty sector is also experiencing a shift toward electrification in a similar manner to the light-duty sector and within several important market segments. As cited in Section I.A of the preamble, numerous commitments to produce all-electric medium-duty delivery vans have been announced by large fleet owners including FedEx, Amazon, and Wal-Mart, in partnerships with various OEMs. This shift to full electrification from a fleet that is currently predominantly gasoline- and diesel-powered suggests that the operators of these fleets consider full electrification as the best available and most cost-effective technology for meeting their mission objectives, while also reducing the emissions from their business operations. Owing to the large size of these vehicle fleets, this segment alone is likely to represent a significant portion of the future electrification of the medium-duty vehicle fleet.

As described in Chapter 1.2.2.1 of the Regulatory Impact Analysis and within section III.A of the preamble, the Agency is using the term "Medium-duty vehicle" (MDV) for the first time within its regulations. MDVs are comprised of the following weight categories:

- Class 2b - 8,501 pounds to 10,000 pounds rated gross vehicle weight (GVWR)
- Class 3 - 10,001 to 14,000 pounds GVWR

MDV also excludes what EPA defines as medium-duty passenger vehicles (MDPVs), which are regulated along with light-duty vehicles and trucks. For more information, please refer to section III.A.1 of the preamble. MDVs can either be "incomplete" chassis cabs onto which customized body work or beds are added after their original manufacture or are "complete" pickup trucks or vans. Examples of incomplete vehicles customized for specific applications include motorhomes, ambulances, wreckers, panel vans, flatbeds, etc. See Figure 3-8. In model year 2020, less than 5 percent of MDV sales were incomplete vehicles, with the remainder being complete.



**Figure 3-8: Examples of incomplete MDV chassis finished with customized bodies for specific applications.**

MDV pickup trucks are generally built with heavier frames and designed with sufficient powertrain, brake and suspension systems to support significantly higher towing capability than found in light-duty pickup trucks. MDV pickup truck applications have considerable tow capability, which can be in excess of 20,000 pounds gross combined weight rating (GCWR) pickups with gasoline engines and can be over 40,000 pounds GCWR for pickups with diesel engines. MDV vans have comparable payload carrying ability to MDV pickups; however, they

typically have significantly lower tow capability with GCWR comparable to, or less than, many light-duty pickups.

There are both diesel engine and spark-ignition gasoline engine applications in MDV. Their shares of MDV sales are shown for both pickups, vans, and incomplete vehicles in Table 3-1. Both gasoline and diesel engines used in van applications and many gasoline engines used in pickup truck applications are derived from light-duty applications. Examples include the:

- Mercedes Benz OM654 diesel engine in the MY2023 Sprinter Van (engine family shared with the C-Class and E-Class passenger cars and GLC CUV sold outside the U.S.)
- Mercedes Benz M274 turbocharged GDI engine in the MY2023 Sprinter Van (engine family shared with the C-Class and E-Class passenger cars and GLC light-duty CUV)
- Ford 3.5L EcoBoost in the MY2015-2023 Transit Van (engine family shared with the 2011-2016 Ford F150 light-duty pickup)
- GM LWN diesel engine in the Chevrolet and GMC vans (engine family shared with Chevrolet Colorado light-duty pickup)
- RAM 6.4L Hemi in the RAM 2500 and 3500 pickups (engine family shared with RAM light-duty pickups, and Dodge, Jeep and Chrysler passenger cars and light-duty CUVs)
- GM L8T naturally aspirated GDI engine used in Chevrolet Silverado 2500HD and 3500HD pickups and G3500 vans and sharing the GM "Generation V" V8 engine family with many GM light-duty trucks, CUVs, SUVs and some passenger cars.

**Table 3-1: Percentage of MY2020 sales and sales volumes of pickup, van, and incomplete MDVs by fuel type.**

| Fuel Type*                | Pickups  |         | Vans     |        | Incomplete Vehicles |        | Grand Total |
|---------------------------|----------|---------|----------|--------|---------------------|--------|-------------|
|                           | Gasoline | Diesel  | Gasoline | Diesel | Gasoline            | Diesel |             |
| <b>MY2020 sales share</b> | 24.2%    | 37.1%   | 30.4%    | 3.7%   | 4.5%                | 0.1%   | 100%        |
| <b>MY2020 sales</b>       | 213,796  | 327,488 | 269,038  | 32,351 | 40,043              | 978    | 883,694     |

\*Other sources of powertrain energy, including electrification, accounted for <1% of MDV sales in MY2020.

While many gasoline engine families used for pickup truck applications share engine families and/or key design elements with light-duty applications, in some cases engine block materials may shift from cast aluminum alloy in light-duty applications to cast iron for MDV applications (e.g., GM L8T engine). In other cases, engine families are solely used in MDV and are also shared with heavier weight-class trucks above MDV, for example Ford's 7.3 L Super-Duty naturally aspirated, port-fuel-injected, gasoline engine used in the F250 and F350 MDV pickups, which is also used in the heavier Ford F450/550/600 and F650/750. Diesel equipped MDV pickup trucks are equipped with 6L and larger engines, some of which have peak torque ratings

in excess of 1000 ft-lbs. Diesel engines used in MDV pickup trucks have no light-duty counterparts and most also share engine families with significantly heavier classes of vehicles (e.g., weight classes 4 through 7) (40 CFR 86.1803-01 2023).

The use of commercial vans for last mile delivery in the U.S. has grown significantly since the start of the global COVID-19 pandemic, primarily through the growth of e-commerce.<sup>24</sup> In the U.S., 2021 e-commerce sales totaled \$870 billion, which represents an increase of over 14 percent from 2020, and over 50.5 percent compared to 2019. U.S. e-commerce represented just over 13.2 percent of all retail sales in 2021 (U.S. Census Bureau 2022). Globally, the automotive market supporting e-commerce was valued at over \$66 billion in 2021 and is expected to grow to over \$75 billion by the end of 2022 and to over \$213 billion by 2029. (Fortune Business Insights 2022). Based on the results of a recent pilot study of the electrification of commercial delivery vans and step vans, the North American Council for Freight Efficiency identified this segment as "100% electrifiable" (North American Council for Freight Efficiency 2021).

Vans using dedicated battery-electric vehicle (BEV) architectures are beginning to enter the U.S. market. The first mass-produced models became available for MY2023 and additional production volume and models have been announced for MY2024. Initial dedicated BEV van chassis have been predominantly targeted towards parcel delivery and include the GM BrightDrop Zevo 400 and Zevo 600; and the Rivian EDV 500 and EDV 700 (Rivian 2023) Figure 3-9 (BrightDrop 2023). Both GM and Rivian share key electric powertrain and battery storage components between their light-duty and/or MDPV BEV products and their dedicated BEV commercial van products, which provides improved economies of scale for their commercial BEV MDV vans. EPA does not require manufacturers to report the electric range of MDVs, however manufacturers and key customers (e.g., Amazon and FedEx) appear to be targeting approximately 150 miles of range based upon public data for battery pack capacity of approximately 135 kWh for the EDV700, approximately 115-kWh for the Zevo 400, and standard capacity of approximately 115-kWh for the Zevo 600 with an optional 165-kWh capacity (Seabaugh 2022) (BrightDrop 2022) (Battery Design 2022).<sup>25</sup>

---

<sup>24</sup> Commercial transactions, including retail sales, conducted electronically on the internet.

<sup>25</sup> BrightDrop useable pack capacity calculated from: public data on GM ultium prismatic NCMA cells at 103 Ah cell capacity, 3.7 VDC nominal cell voltage; public data on GM Ultium modules at 24 cells per module; and BrightDrop public data on the availability of 14 module and 20 module Ultium battery packs (Battery Design 2022) (BrightDrop 2022).



**Figure 3-9: Rivian EDV 700 (left) and GM BrightDrop ZEVO 600 MDV (right) vans operated by Amazon and FedEx, respectively.**

Although no PHEV pickup truck or MDV applications are yet in production, EPA believes the PHEV architecture may lend itself well to future applications, particularly MDV pickup truck applications at or below 10,000 pounds GVWR and MDV vans used outside of last-mile delivery applications and thus have included PHEV MDV within our analysis for the final rule. One major manufacturer, Stellantis, has announced that it will introduce a PHEV pickup for MY2024, although it is still unclear if the pickup will be an MDPV or an MDV (Stellantis 2023). A MDV PHEV pickup architecture could potentially provide several benefits: some amount of zero emission electric range (depending on battery size); increased total vehicle range during heavy towing and hauling operations using both charge depleting and charge sustaining modes (depending on ICE-powertrain sizing); job-site utility with auxiliary power capabilities similar to portable worksite generators, and the efficiency improvements normally associated with strong hybrids that provide regenerative braking, extended engine idle-off, and launch assist for high torque demand applications. Depending on the vehicle architecture, PHEVs used in MDV pickup applications may also offer additional capabilities, similar to BEV pickups, with respect to torque control and/or torque vectoring to reduce wheel slip during launch in trailer towing applications. In addition, PHEVs may help provide a bridge for commercial consumers that may not be ready to adopt a fully electric MDV pickup.

EPA has completed contract work to investigate likely technology architectures of both PHEV and internal combustion engine range-extended electric light-duty and MDV pickup trucks that provided data for the final rule. This study is summarized in Chapter 3.5.2 of the RIA. Costs for potential PHEV designs for this application are outlined in Chapter 2.6.1.4 of the RIA.

While the agency anticipates that electrification of vans will be a cost-effective compliance strategy for meeting the GHG and criteria pollutant standards, vehicle manufacturers may also choose to improve their conventional, ICE-based vehicles. MDV GHG emissions can be reduced via improving powertrain efficiency or by making improvements to road loads through improved aerodynamics, reduced tire rolling resistance and reduced vehicle weight. For a summary of conventional MDV GHG emissions control technology, please refer to Chapter 2.5 of the Heavy-duty Phase 2 GHG Regulatory Impact Analysis. MDV emissions that contribute to criteria air pollutants can be reduced by improvements to engine management systems, fuel systems, evaporative emissions control systems, catalyst systems, and via the addition of modern exhaust filtration systems such as the gasoline particulate filter (GPF). Many of the anticipated controls

for future MDVs share significant design elements with criteria pollutant emissions controls used for light-duty applications and are discussed in more detail in Chapter 3.2 of this RIA.

### **3.1.3 Review of Light- and Medium-Duty PEV Feasibility**

In this section we briefly review the major highlights of our assessment of feasibility of PEV technology.

The primary body of our PEV feasibility assessment resides in the preamble Section IV, where we analyze and cite relevant evidence and form our conclusions regarding PEV feasibility as well as other aspects of feasibility of compliance with the standards. For references and full discussion please refer to the specific preamble sections cited below and where applicable, other relevant sections of the preamble and RIA.

The technology trends outlined in the previous sections show that among other technologies, BEV and PHEV technologies are being increasingly employed across the fleet in both light-duty and medium-duty applications. This trend also serves as evidence that BEVs and PHEVs are seen not only as an effective and feasible means to comply with emissions regulations but also as an effective and attractive solution that can serve the functional needs of a large portion of light- and medium-duty vehicle buyers. This represents an opportunity to accelerate needed reductions in criteria pollutant and GHG emissions by encouraging continued uptake of these technologies in the U.S. light- and medium-duty vehicle fleet.

As noted previously, zero- and near-zero emissions technologies are more feasible and cost-effective now than at the time of prior rulemakings. The developments in vehicle electrification that have brought this about are driven in part by the industry's need to compete in a diverse market, as zero-emission transportation policies continue to be implemented across the world. Sections I.A.2 and IV.C.1 of the preamble provide a comprehensive analysis of recent events in the growth of electrification of the automotive sector, and established a number of important points, which are reviewed briefly below. Citations for the content in this section can be found in the parallel discussions in Sections I.A.2 and IV.C.1 of the preamble, unless specifically cited here.

One observation of that discussion was that growth in vehicle electrification is likely being driven in part by automakers' need to compete in a diverse global marketplace in which many countries are continuing to implement emissions-reducing or zero-emission transportation policies. Specifically, at least 20 countries across the world, as well as numerous local jurisdictions in the U.S. and abroad, have announced plans to shift all new passenger car sales to zero-emission vehicles in the coming years -- Norway by 2025; Austria, the Netherlands, Denmark, Iceland, India, Ireland, Israel, Scotland, Singapore, Sweden, and Slovenia by 2030, Canada, Chile, Germany, Thailand, and the United Kingdom by 2035, and France, Spain, and Sri Lanka by 2040. Many of these announcements extend to light commercial vehicles as well, and several also target a shift to 100 percent all-electric medium- and heavy-duty vehicle sales (Norway targeting 2030, Austria 2035, and Canada and the United Kingdom 2040). In addition, in March 2023 the European Union approved a measure to phase out sales of ICE passenger vehicles in its 27 member countries by 2035. Together, about half of annual global light-duty sales are in countries with various levels of zero-emission vehicle targets by 2035, up from about 25 percent in 2022. As of late 2023, 17 automotive brands globally had announced corporate targets for phasing out ICE technology, representing 32 percent of the global automotive market.

In 2023, 22 percent of new car registrations in the European Union were either BEVs or PHEVs, led by Norway which reached about 80 percent BEV and 89 percent combined BEV and PHEV sales. California finalized the Advanced Clean Cars II (ACC II) rule that specifies, by 2035, all new light-duty vehicles sold in the state are to be zero-emission vehicles. Twelve additional states have adopted all or most of the zero-emission vehicle phase-in requirements under ACC II, including Colorado, Delaware, Maryland, Massachusetts, New Jersey, New Mexico, New York, Oregon, Rhode Island, Vermont, Virginia, and Washington.

In addition to spurring industry development of BEV and PHEV technology, developments such as these suggest a growing global consensus that BEV and PHEV technologies are broadly feasible as emissions-reducing technologies. For additional details and citations regarding the domestic and global developments that we have briefly reviewed here, please refer to Sections I.A.2 and IV.C.1 of the preamble.

Preamble Sections I.A.2 and IV.C.1 also establish that demand for these vehicles in the U.S. is rapidly increasing, even under current standards. The production of new PEVs (including both BEVs and PHEVs) is growing steadily, expected to be 11.8 percent of U.S. light-duty vehicle production in MY 2023, up from 6.7 percent in MY 2022, 4.4 percent in MY 2021 and 2.2 percent in MY 2020. In California, new light-duty PEV sales have reached 25.1 percent through the third quarter of 2023, after reaching 18.8 percent in 2022, up from 12.4 percent in 2021. The number of PEV models available for sale in the U.S. has grown from about 24 in MY 2015 to about 60 in MY 2021 and over 180 in MY 2023, with offerings in a growing range of vehicle segments. MY 2023 BEVs and PHEVs are now available as sedans, sport utility vehicles, and pickup trucks, with the greatest offering in the crossover/SUV segment.

U.S. new PEV sales in 2023 surpassed 1.4 million, an increase of more than 50 percent over the 807,000 sales that occurred in 2022. This represents 9.1 percent of new light-duty passenger vehicle sales in 2023, up from 6.8 percent in 2022 and 3.2 percent the year before. Despite talk of a reduced rate of growth in PEV sales in 2023 (see Preamble I.A.2), the growth trend seen in previous years continues to be seen in 2023 data (see Figure 1 of Preamble I.A.2).

Before the Inflation Reduction Act (IRA) became law, analysts were already projecting that significantly increased penetration of plug-in electric vehicles would occur in the United States and in global markets. As fully discussed in Preamble I.A.2, projections have suggested rapid growth. In 2021, IHS Markit predicted a nearly 40 percent U.S. PEV share by 2030. Projections made in 2022 by Bloomberg New Energy Finance (BNEF) suggested that under then-current policy and market conditions, and prior to the IRA and this final rule, the U.S. was on pace to reach 43 percent PEVs by 2030, and when adjusted for the effects of the IRA, this estimate increased to 52 percent. Another study by the International Council on Clean Transportation (ICCT) and Energy Innovation that includes the effect of the IRA projects that the share of BEVs will increase to 56 to 67 percent by 2032. Although the assumptions and other inputs to these forecasts vary, they point to greatly increased penetration of electrification across the U.S. light-duty fleet in the coming years, without specifically considering the effect of increased emission standards under this rule.

A similar trend was seen in forecasts reviewed for the global market, showing that growth in PEV sales in the U.S. is part of a global trend. Global light-duty passenger PEV sales surpassed 10 million in 2022, up from 6.6 million in 2021, bringing the total number of PEVs on the road to more than 26 million globally. For fully-electric BEVs, global sales rose to 7.8 million in

2022, an increase of about 68 percent from the previous year and representing about 10 percent of the new global light-duty passenger vehicle market. Leading sales forecasts predict that PEV sales will continue to accelerate globally in the years to come. For example, in June 2023, Bloomberg New Energy Finance reported that global PEV sales were 10.5 million in 2022 and forecasted that annual sales will rise to 27 million in 2026 (implying an annual growth rate of about 27 percent from 2022), with total global PEV stock rising from 27 million in 2022 to more than 100 million by 2026.

In the preamble discussions we also cited extensive evidence that, while ICE vehicles and HEVs together retain the largest share of the market, the year-over-year growth in U.S. PEV sales suggests that an increasing share of new vehicle buyers are concluding that a PEV is the best vehicle to meet their needs. PEV owners often describe specific advantages of PEVs as key factors motivating their purchase, such as responsive acceleration, improved performance and handling, quiet operation, lower cost of ownership, and the ability to charge at home. A 2022 survey by Consumer Reports shows that, even at a time when many consumers are not yet as familiar with BEVs as with ICE vehicles, more than one-third of Americans would either seriously consider or definitely buy or lease a BEV today if they were in the market for a vehicle. Because familiarity with BEVs promotes acceptance (see for example section IV.C.6 of the preamble and RIA Chapter 4), this share is expected to rapidly grow as familiarity increases in response to increasing numbers of BEVs on the road and growing visibility of charging infrastructure. The U.S. Bureau of Labor Statistics has indicated that growing consumer demand and growing automaker commitments to electrification are important factors in the growth of PEV sales and that growth will be further supported by policy measures including the BIL and the IRA. Most PEV owners who purchase a subsequent vehicle choose another PEV, and often express resistance to returning to an ICE vehicle after experiencing PEV ownership. Many analysts believe that as PEVs continue to increase in market share, PEV ownership will continue to broaden its appeal as consumers gain more exposure and experience with the technology and with the benefits of PEV ownership, with some analysts suggesting that rapidly accelerating PEV adoption will then result.

We also cited evidence that, while PEVs are typically offered at a higher price than comparable ICE vehicles at this time, the price difference for BEVs, which have only an electric powertrain, is widely expected to narrow or disappear as the cost of batteries and other components fall in the coming years. Among other evidence, we noted that an emerging consensus suggests that purchase price parity is likely to begin occurring by the mid- to late-2020s for some vehicle segments and models, and for a broader segment of the market on a total cost of ownership (TCO) basis. By some accounts, a compact car with a relatively small battery (for example, a 40 kilowatt-hour (kWh) battery and approximately 150 miles of range) may already be possible to produce and sell for the same price as a compact ICE vehicle. For larger vehicles and/or those with a longer range (either of which necessitate a larger battery), many analysts expect examples of price parity to increasingly appear over the mid- to late-2020s.

Prospects for price parity improve greatly when considering state and federal purchase incentives. For example, the 30D Clean Vehicle Credit under the IRA provides a purchase incentive of up to \$7,500, effectively making some BEVs more affordable to buy today than comparable ICE vehicles. Kelley Blue Book already estimates that the lowest TCO for the full-size pickup and luxury car classes of vehicle are BEVs. Based on average annual mileage, BloombergNEF states that in the U.S., electric SUVs have already achieved lower TCO than



similar ICE vehicles, and for higher mileages, BEVs have lower TCO than similar small, medium, and large ICE vehicles. Because businesses tend to pay close attention to TCO of business property, TCO parity of BEVs is likely to be of particular interest to commercial owners and fleet operators.

As further evidence of the feasibility of BEVs and PHEVs as an emissions-reducing technology, we also cited a large number of announcements made by all of the major automakers in the past several years, signaling a rapidly growing shift in product development focus toward electrification. Section I.A.2 and IV.C.1 of the preamble introduces and provides citations for many of these announcements.

General Motors announced plans to become carbon neutral by 2040, including an effort to shift its light-duty vehicles entirely to zero-emissions by 2035. In March 2021, Volvo announced plans to make only electric cars by 2030, and Volkswagen announced that it expects half of its U.S. sales will be all-electric by 2030. In April 2021, Honda announced a full electrification plan to take effect by 2040, with 40 percent of North American sales expected to be fully electric or fuel cell vehicles by 2030, 80 percent by 2035 and 100 percent by 2040. In May 2021, Ford announced that they expect 40 percent of their global sales will be all-electric by 2030. In June 2021, Fiat announced a move to all electric vehicles by 2030, and in July 2021 its parent corporation Stellantis announced an intensified focus on electrification, including both BEVs and PHEVs, across all of its brands. Also in July 2021, Mercedes-Benz announced that all of its new architectures would be electric-only from 2025, with plans to become ready to go all-electric by 2030 where possible. In August 2021, many major automakers including Ford, GM, Stellantis, BMW, Honda, Volkswagen, and Volvo, as well as the Alliance for Automotive Innovation, expressed continued commitment to their announcements of a shift to electrification, and expressed their support for the goal of achieving 40 to 50 percent sales of zero-emission vehicles by 2030. In December 2021, Toyota announced plans to introduce 30 BEV models by 2030. In August 2023, Subaru announced that its previous plan to target 40 percent combined HEVs and BEVs was being revised to 50 percent BEVs globally by 2030.

In addition to BEV technology, some automakers have also indicated a strong role for PHEVs in their product planning. For example, Toyota continues to anticipate PHEVs forming an increasing part of their offerings, and Stellantis will be introducing a plug-in version of its Ram pickup for MY 2024. As discussed in more detail in Section IV.C.1 of the preamble, the number of PHEV and BEV models has steadily grown and manufacturer announcements signal the potential for significant growth in the years to come. We also showed a tabulation of these and other OEM announcements that indicates that the sales collectively implied by such announcements to date would amount to about 49 percent new light-duty zero-emission vehicle sales in the U.S. by 2030.

In the second half of 2023, some automakers announced changes to previously announced investment plans and made statements suggesting increased attention to PHEVs or HEVs in their future product plans. For example, in mid-2023, Ford paused construction (later restarted) of their recently announced battery plant in Marshall, Michigan, and in November 2023 announced a reduction in the size of the plant from 50 GWh to 20 GWh. Later in 2024 Ford also signaled a growing interest in producing HEVs and a shift from large BEV SUVs toward smaller BEVs, while General Motors indicated increased attention toward producing PHEVs in addition to BEVs. We review several other examples of announced adjustments to previously announced

investment or product plans in Section I.A.2 of the preamble. There we also noted that some industry analysts had connected such adjustments to a purported drop in PEV demand or a weakening of manufacturer interest in investing in PEV technology. In that discussion, we considered these developments carefully, particularly in light of the larger context of information about manufacturer plans, including comments submitted by the manufacturers on this rulemaking and our ongoing engagement with the manufacturers. Overall, EPA finds that the recent announcements do not reflect a significant change in manufacturer intentions regarding PEVs generally or specifically through the 2027-2032 timeframe of this rule. For more discussion on this topic, refer to section I.A.2 of the preamble.

In the Preamble we also cited evidence documenting numerous commitments to produce all-electric medium-duty delivery vans, which have been announced by large fleet owners including FedEx, Amazon, and Wal-Mart, in partnerships with various OEMs. For example, Amazon has deployed thousands of electric delivery vans in over 100 cities, with the goal of 100,000 vans by 2030. Many other fleet electrification commitments that include large numbers of medium-duty and heavier vehicles have been announced by large corporations in many sectors of the economy, including not only retailers like Amazon and Walmart but also consumer product manufacturers with large delivery fleets (e.g. IKEA, Unilever), large delivery firms (e.g. DHL, FedEx, USPS), and numerous firms in many other sectors including power and utilities, biotech, public transportation, and municipal fleets across the country. As another example, Daimler Trucks North America announced in 2021 that it expected 60 percent of its sales in 2030 and 100 percent of its sales by 2039 would be zero-emission.

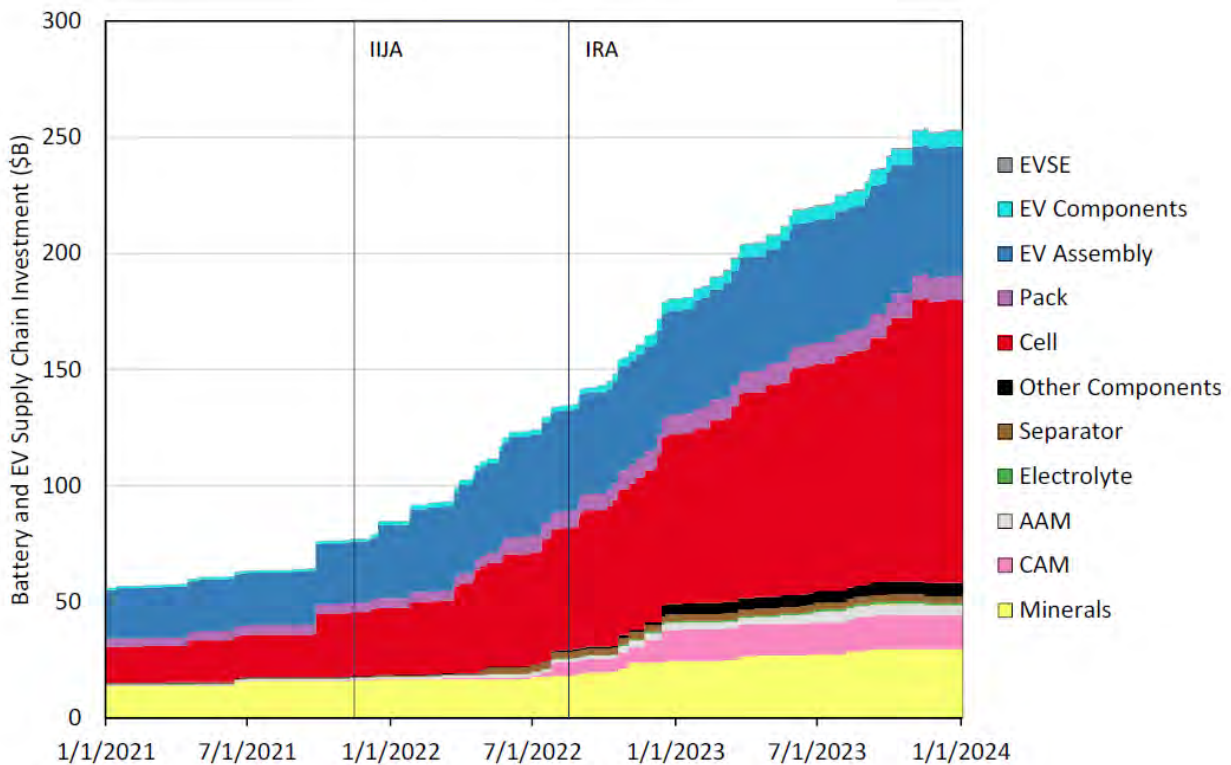
We also provided numerous citations showing evidence that these announcements and others like them continue a pattern over the past several years in which most major manufacturers have taken steps to aggressively invest in zero-emission technologies and reduce their reliance on the internal-combustion engine in various markets around the globe.

One cited analysis indicated that 37 of the world's automakers are planning to invest a total of almost \$1.2 trillion globally by 2030 toward electrification, a large portion of which would be used for construction of manufacturing facilities for vehicles, battery cells and packs, and materials. This would support up to 5.8 terawatt-hours of battery production and 54 million BEVs per year globally. Another cited analysis showed that a significant shift in North American investment is occurring toward electrification technologies, with more than 90 percent (\$36 billion of about \$38 billion) of total automaker manufacturing facility investments announced in 2021 being slated for electrification-related manufacturing in North America, with a similar proportion and amount on track for 2022.

In September 2021, Toyota announced large new investments in battery production and development to support an increasing focus on electrification, and in December 2021, announced plans to increase this investment. In December 2021, Hyundai closed its engine development division at its research and development center in Namyang, South Korea in order to refocus on BEV development. In summer 2022, Hyundai announced an investment of \$5.5 billion to fund new battery and electric vehicle manufacturing facilities in the state of Georgia, and recently announced a \$1.9 billion joint venture with SK to fund additional battery manufacturing in the U.S. In 2023, Ford announced plans for a new battery plant in Michigan, part of \$17.6 billion in investments in electrification announced by Ford and its partners since 2019. By mid-2023 the International Energy Agency indicated that as of the previous March, major manufacturers had

announced post-IRA investments in North American supply chains totaling at least \$52 billion, mostly in battery manufacturing, battery components and vehicle assembly. By January 2024, a White House accounting of BIL and IRA investments indicated that the total had increased to at least \$155 billion. The U.S. Department of Energy indicates this represents over \$120 billion in over 200 new or expanded minerals, materials processing, and manufacturing facilities and over \$35 billion in over 140 new or expanded sites for EV assembly, EV component, or charger manufacturing.

The following chart (Figure 3-10) more clearly illustrates how these and many other instances of North American investments in battery and electric vehicle and component manufacturing have added up to a picture of steady and robust growth in investment commitments in recent years (ANL 2024a).



**Figure 3-10 North American battery and electric vehicle investments classified by manufacturing product**

Manufacture and sale of PEVs is anticipated to grow significantly in the United States over the next decade as provisions of the Inflation Reduction Act of 2022 (IRA) continue to take effect (Public Law 117-169 2022). The IRA has key provisions that will reduce the cost of PEVs to consumers, reduce the cost of battery manufacturing in the U.S. for automakers, and foster significant emissions reductions from the U.S. electric power sector. Manufacturing-related provisions include the Domestic Manufacturing Conversion Grant Program, Advanced Technology Vehicle Manufacturing Program, expanded authorities for the DOE Loan Programs Office, and the 45X Advanced Manufacturing Production Credit. Incentives for the purchase of clean vehicles include the 30D Clean Vehicle Tax Credit, 45W Clean Commercial Vehicle

Credit, and the 25E credit for purchase of used clean vehicles. The 30C credit also addresses aspects of charging equipment cost. There are also power sector provisions such as the Clean Electricity Production and Investment Tax Credits as well as incentives for renewable electricity generation and grid battery storage. An Existing Nuclear Production Tax Credit is oriented to extending nuclear EGU service life. There is also a 45Q Carbon Capture and Storage Tax Credit.

For further discussion of the impacts of the IRA on the electric power sector, please refer to Chapter 5.2.3 of the RIA. Our modeling assumptions regarding IRA manufacturing and consumer purchase credits are discussed in more detail in Preamble IV.C.2 and elsewhere.

PEVs, which include BEVs and PHEVs, can fill the same role as ICE vehicles for most if not all light- and medium-duty vehicle owners. PHEVs have both an electric powertrain and a gasoline engine and as previously discussed in section IV.C.1 of the preamble, are particularly good candidates for some demanding heavy-duty applications, although BEVs are capable of these uses as well. BEVs rely solely on the battery for energy and so differ in some ways from ICE vehicles and PHEVs in the way they are refueled. Obviously, charging a BEV is not exactly the same as refueling an ICE vehicle with gasoline. While BEVs generally take longer to charge than an ICE vehicle takes to refuel, charging does not need to be attended and for many users can be done at home. BEVs can also be used in cold and hot climates. Just as with ICE vehicles, cold or hot weather can increase energy consumption due to use of cabin heating and cooling and defrosting. Because BEVs are more efficient, less waste heat is available to heat the cabin, so the energy must come from the battery. However, climate control requires only a fraction of the energy needed to drive a vehicle, and most of today's BEVs have a substantial driving range, often 300 miles or more, that can easily accommodate climate control needs. Heat pump technology can reduce energy consumption further and is increasingly being used in BEV climate control systems. Cold weather can also affect charging speed, but most BEVs are programmed to warm the battery while charging in cold temperatures and have thermal management systems to manage battery temperatures.

In addition to feasibility of PEV technology itself, EPA has also performed extensive analysis of other factors in PEV feasibility beyond the vehicle itself. These include the availability and projected growth of charging infrastructure both at home and in public places, the ability of the electric grid to support the additional electric demand for charging, and consumer acceptance of PEVs, among many other factors.

We expect that through 2055 the majority of light and medium duty PEV charging will occur at home, but we recognize the need for additional public charging infrastructure to support anticipated levels of PEV adoption. As discussed in preamble Section IV.C.5 of the preamble and RIA Chapter 5.3, charging infrastructure has grown rapidly over the last decade, and investments in charging infrastructure continue to grow. Based on our evaluation of the record, EPA has found that the market for charging is already responding to increased demand through investments from a wide range of public and private entities, and that it is reasonable to expect the market will continue to keep up with demand. We further anticipate these final standards will encourage additional investments in charging infrastructure.

EPA does not find that the increase in electricity consumption associated with modeled increases in PEV sales will adversely affect reliability of the electric grid, and, as explained in Section IV of this preamble and Chapter 5 of the RIA, more widespread adoption of PEVs could have significant benefits for the electric power system.

Our modeling also incorporates constraints related to consumer acceptance. Under our central case analysis assumptions, the model anticipates that consumers will in the near term tend to favor ICE vehicles over PEVs when two vehicles are comparable in cost and capability. Taking into account individual consumer preferences, we anticipate that PEV acceptance and adoption will continue to accelerate as consumer familiarity with PEVs grows, as demonstrated in the scientific literature on PEV acceptance and consistent with typical diffusion of innovation. Adoption of PEVs is expected to be further supported by expansion of key enablers of PEV acceptance, namely increasing market presence of PEVs, more model choices, expanding infrastructure, and decreasing costs to consumers. See also Section IV.C.5 of the preamble and RIA Chapter 4.

More detail about our technical assessment, and the assumptions for the production feasibility and consumer acceptance of PEVs is provided in Section IV of this preamble, and Chapters 2, 3, 4, and 6 of the RIA.

In considering feasibility of the standards, EPA also considered the impact of available compliance flexibilities on automakers' compliance options, as well as constraints posed by the typical cadence of manufacturer redesign cycles. In Section V.B of the preamble, we described how EPA's technical assessment accounts for redesign limits.<sup>26</sup> Once a redesign opportunity is encountered, we have assumed limits to the rate at which a manufacturer can ramp in the transition from an ICE to a BEV vehicle. We have also applied limits to the ramp up of battery production, considering the time needed to increase the availability of raw materials and expand battery production facilities. These limits as they are applied in OMEGA are discussed in Chapter 2 of the RIA.

We also consider feasibility from the perspective of critical mineral availability, manufacturing capacity for battery cells and related products and components, and mineral security, which are introduced in Section IV.C.7 of the preamble and further examined in the next section (3.1.4) of this RIA.

In Section V.B of the preamble, we cite many of our findings on feasibility to assess the overall technological feasibility and sufficiency of lead time necessary for manufacturers to meet the standards using the technologies that are available to them. Our assessment shows that there is sufficient lead time for the industry to deploy existing technologies, including increasing proportions of PEV technology, more broadly and thereby successfully comply with the final standards. There we also describe the levels of ICE vehicle, HEV, PHEV, and BEV penetration indicated by our compliance analysis. The central analysis combined with the various sensitivities we perform (for example, high and low battery costs, among others) show that manufacturers can comply with the standards with varying percentages of each technology.

#### **3.1.4 Additional Background on Critical Minerals and Manufacturing**

This RIA section provides (a) a brief review of some of the major points and evidence that EPA examined in reaching the conclusions presented in Section IV.C.7 of the preamble, and (b) additional background information that we considered regarding critical minerals. EPA has also

---

<sup>26</sup> In our compliance modeling, we have limited vehicle redesign opportunities in our compliance modeling to every 7 years for pickup trucks, and 5 years for all other vehicles.

carefully considered the findings of the March 2024 ANL report "Securing Critical Materials for the U.S. Electric Vehicle Industry" (ANL 2024b) as well as the February 2024 ANL Report "Quantification of Commercially Planned Battery Component Supply in North America through 2035" (ANL 2024a)

This Section 3.1.4 is meant to serve primarily as a review. The primary body of our assessment of battery cell and cell component manufacturing, critical minerals, and mineral security resides in the Preamble IV.C.7, where we analyze and cite all relevant evidence and form our conclusions regarding these topics as they relate to compliance with the standards. For references and full discussion please refer to the specific preamble sections cited below and where applicable, other relevant sections of the preamble and RIA.

#### **3.1.4.1 Review of Key Developments Considered**

In IV.C.7 of the preamble, we considered issues related to manufacturing capacity, critical minerals, and mineral security from the perspective of industry's ability to comply with the standards. In that discussion, we reviewed the key themes of public comments that we received on these topics and described the additional research we had conducted to address these comments and represent the latest and best additional information since the issuance of the proposal. There we presented the primary evidence and developed our conclusion that issues related to manufacturing capacity and critical mineral availability will not prevent manufacturers from meeting the standards, and that the standards can be met without adverse impact on national security.

The preamble discussion establishes a number of key observations about the status of critical minerals and manufacturing capacity, and the outlook for development of the supply chain in response to industry investment and government policy. This section provides a review of some of our key observations. For a full discussion of the evidence we considered and how we developed our findings, see Preamble IV.C.7.

We noted that about 57 percent of cells and 84 percent of assembled packs sold in the U.S. from 2010 to 2021 were manufactured in the U.S., and due to continued production largely by the same OEMs represented in the data, as well as the large amount of announced U.S. capacity under construction or planned, this is likely to continue to be the case going forward. This suggests that PEV production in the U.S. need not be heavily reliant on foreign manufacture of battery cells or packs as PEV penetration increases.

Many automakers are building battery and cell manufacturing facilities in the U.S. and are also taking steps to secure a supply of minerals and commodities either domestically or through FTA or allied trade partners to supply production for these plants. Our analysis of constructed and planned plant capacity for assembly of battery cells indicates that battery manufacturing capacity does not appear to pose a critical constraint to increased production of PEVs to meet anticipated globally or domestic demand. Domestically, our analysis of current capacity and construction announcements made by the major automakers and suppliers indicates that the U.S. will have more than enough cell manufacturing capacity to supply U.S. demand under the final standards.

We also drew observations regarding which minerals are of greatest concern as a potential constraint on PEV production during the time frame of the rule. Mineral demand for ICE catalyst

production is relatively stable and would not be expected to increase as a result of electrification. Rare earths used in permanent magnet motors have potential alternatives in the use of induction machines or other electric machine technologies that do not require rare-earth magnets, or in the use of advanced ferrite or other advanced magnets. On a quantity basis and probably also on a value basis, battery minerals are likely to be the most important mineral-related factor of consideration for PEV production during the time frame of the rule. Of these, the most attention is commonly given to lithium, nickel, cobalt, and graphite. Manganese is also used, but due to available world supplies and relative level of importance across the clean energy sector, it is not designated as critical by DOE.

Currently, most mining and refining of these minerals occurs outside of the U.S. The U.S. does not lack significant natural deposits of some of these minerals, for example graphite and lithium, but relatively little mining and refining capacity is currently in operation or remains undeveloped. The development of mining and refining capacity in the U.S. is a primary focus of industry toward building a robust domestic supply chain for electrified vehicle production. For example, LG Chem has announced plans for a cathode material production facility in Tennessee, said to be sufficient to supply 1.2 million high-performance electric vehicles per year by 2027. We review other announcements like this in the preamble and in this section.

We also noted that further development of a domestic mineral supply chain will be accelerated by the provisions of the Inflation Reduction Act (IRA) and the Bipartisan Infrastructure Law (BIL), as well as ongoing efforts by the Executive Branch. The IRA offers sizeable tax provisions that incentivize domestic production of batteries and critical minerals, including a \$7,500 Clean Vehicle Credit for vehicles manufactured in North America that use domestically produced components and mineral products, and production tax credits that apply to domestically produced cells, modules, electrode active materials, and critical minerals, that can reduce battery manufacturing cost by a third or more. Among much other funding, the BIL provides \$7.9 billion to support development of the domestic supply chain for battery manufacturing, recycling, and critical minerals. Provisions extend across critical minerals mining and recycling research, USGS energy and minerals research, rare earth elements extraction and separation research and demonstration, and expansion of DOE loan programs in critical minerals and recycling. Through these provisions DOE is actively working to prioritize points in the domestic supply chain to target with accelerated development, and rapidly funding those areas through numerous programs and funding opportunities. With BIL funding and matching private investment, more than half of the capital investment that the Department of Energy's Li-Bridge alliance considers necessary for supply chain investment to 2030 has already been committed.

Specifically, a large amount of funding for battery production is being offered by the federal government through IRA tax credits, loans through the DOE Loans Program Office, and DOE Office of Manufacturing and Energy Supply Chains (MESC), as seen in the following table (ANL 2024a):

**Table 3-2 Summary of Funding Programs for U.S. Battery Production**

| Program   | Funding Allocated* | Total Available** | Period of Availability  | Project Examples   |
|---|--------------------|-------------------|---|--|
| Battery Materials Processing Grants & Battery Manufacturing and Recycling Grants (MESC) | ~\$1.9B            | ~\$4.1B           | 2022-2026; Until Expended***  | CAM and AAM production, separator production, precursor materials production, battery cell production.                       |
| Domestic Manufacturing Conversion Grants (MESC)   | \$0                | \$2B              | To remain available through 9/30/2031   | Eligible projects include facilities to produce components for electric vehicles.  |
| ATVM (LPO)  | ~\$15.9B           | ~\$49.8B          | No restriction  | Battery cell production, lithium carbonate production, AAM production, foil production, CAM production.                      |
| Title 17 (LPO)  | \$398.6M           | \$60B             | No restriction  | Zinc bromine battery energy storage systems.   |
| 48C Qualifying Advanced Energy Tax Credit (IRS, MESC)                                   | \$0                | \$10B             | Until expended  | Eligible projects include production and recycling of clean energy technologies, critical minerals processing and recycling. |
| 45X Advanced Manufacturing Production Tax Credit (IRS)                                  | --                 | No limitation     | For critical minerals: permanent; For other items: full credit available between 2023-29 with phase down from 2030-32 | Eligible projects include battery components, critical minerals, inverters, components for solar and wind energy technology. |

\*Funding announced since 2021, as of February 2024, for projects related to the scope of the cited ANL study (cells, packs, CAM, AAM, electrolyte, foil, separator, precursor materials). Includes conditional commitments (LPO only)

\*\*For grants, the total available is the total allocated subtracted from the allocation, and indicates how much grant funding is left. For LPO, this number represents approximate loan authority available as of January 2024, reported by LPO.

\*\*\*For the purposes of this table, the Battery Materials Processing Grants & Battery Manufacturing and Recycling Grants are combined. These two programs are authorized separately in the IIJA. Their periods of availability are listed respectively.

A substantial portion of this supporting industrial policy is still unfolding. This includes final rulemaking and Treasury guidance for various details of the IRA tax credits; the submission, selection, and award of second round of funding from the Battery Materials Processing and Manufacturing Grants program by January 2025 (IIJA section 40207) and the 48C tax credit (Qualifying Advanced Energy Project Credit), and, respectively, final interpretive guidance and rulemaking from the Department of Energy and the Department of the Treasury on Foreign Entities of Concern (FEOC) and Excluded Entities for the 30D tax credit (Clean Vehicle Credit).

We also noted the following observations about forecast global supplies of refined critical minerals. An analysis by the Department of Energy's Li-Bridge based on data from a leading mineral analysis firm indicated that no shortage of cathode active material is expected globally through 2035. Despite recent short-term fluctuations in price, leading analyst firms currently are projecting mineral prices to stabilize through the second half of the 2020s. Prices for battery minerals have fallen considerably in the last year and forecasts to 2029 indicate that prices are expected to remain stable at or slightly lower than current levels. This forecast stability also suggests that industry sentiment does not expect a critical long-term shortage to develop given current resource identification and the current level of investment activity to develop resources as well as increase manufacturing capacity for all important inputs to cell production. For more discussion of these trends with specific references and examples, see Preamble IV.C.7.



EPA also noted that the global minerals industry is already anticipating and preparing for accelerated growth in demand for critical minerals resulting from already-existing expectations of greatly increased global PEV production and sales in the future, as well as expectations of growing demand for these materials in other areas of clean energy and decarbonization. Thus, in the context of evaluating the impact of the standards on demand for critical minerals and development of the domestic supply chain, EPA recognizes that much of the anticipated growth in global mineral demand stems not from the incremental effect of the standards but from these ongoing forces that are already driving the global industry to increase mineral production.

Relatedly, EPA noted also that the IRA, the BIL, and ongoing activity on the part of Executive Branch agencies are actively addressing the need for further development of the domestic supply chain to supply growing demand for critical minerals. The provisions of the IRA and BIL were in fact developed with the intent of growing the domestic supply chain for critical minerals and related products and to achieve mineral security as the industry pursues clean energy technology. Accordingly, EPA expects that the BIL and IRA will be very helpful toward meeting incremental needs of the supply chain under the standards.

|  | Extract | Refine/Process   | Recycle | Manufacture   | Assemble                           | Drive/Charge                                    |
|--|---------|--|---------|---|------------------------------------|---|
| IIJA 40207 Battery Grants                                    |         | Critical Minerals, Constituent Materials, Battery Components       |         |   |                                    |   |
| Advanced Technology Vehicle Manufacturing Loans              |         | Critical Minerals, Constituent Materials, Battery Cells, EV Wiring |         |   |                                    |   |
| Domestic Manufacturing Conversion Grants                     |         |  |         | LMHDV Electric Vehicles and Components                                      |                                    |   |
| Qualifying Advanced Energy Project Credit (48C) Program      |         | Critical Materials   |         | Electric Grid Mod. Equipm. & Components, LMHDEV Tech, Components, Materials |                                    |   |
| 45X Advanced Manufacturing Production Tax Credit             |         | Critical Minerals (10%), Electrode Active Materials (10%)          |         | Battery Cells (\$35/kWh) Modules (\$10/kWh)                                 |                                    |   |
| 30D Clean Vehicle Credit                                     |         | Critical Minerals from U.S. & FTA Countries                        |         | from N. America   | Battery Components from N. America | \$3,750 x 2 = \$7,500                           |
| 45W Commercial Clean Vehicle Credit                          |         |  |         |   |                                    | \$7,500 < 14,000 lbs.<br>\$40,000 ≥ 14,000 lbs. |
| 25E Previously-Owned Clean Vehicle Credit                    |         |  |         |   |                                    | \$4,000   |
| 30C Alternative Fuel Vehicle Refueling Infrastructure Credit |         |  |         |   |                                    | \$1,000/item home<br>\$100,000/item commercial  |

**Figure 3-11: Breadth of BIL and IRA supply and demand side incentives underway to build the supply chain.**

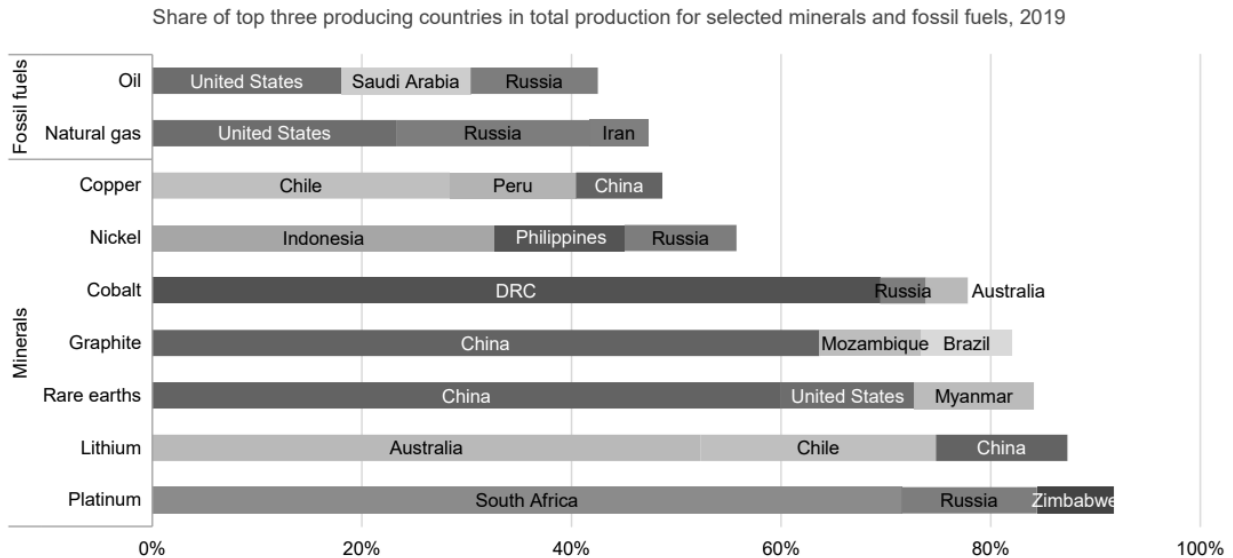
This section has provided only a brief review of some key highlights related to manufacturing capacity and critical minerals. The primary body of our assessment of battery cell and cell component manufacturing, critical minerals, and mineral security resides in the Preamble IV.C.7, where we analyze and cite all relevant evidence and form our conclusions regarding these topics as they relate to compliance with the standards. For references and full discussion please refer to the specific preamble sections cited below and where applicable, other relevant sections of the preamble and RIA.

### 3.1.4.2 Background on Global Distribution and Production of Critical Minerals

Here we provide background on the worldwide sources of critical minerals as they are currently understood. This discussion only presents additional background information that EPA considered in its analysis of critical minerals, in addition to that examined and discussed in the primary discussion. For our primary discussion on critical minerals, see section IV.C.7 of the preamble.

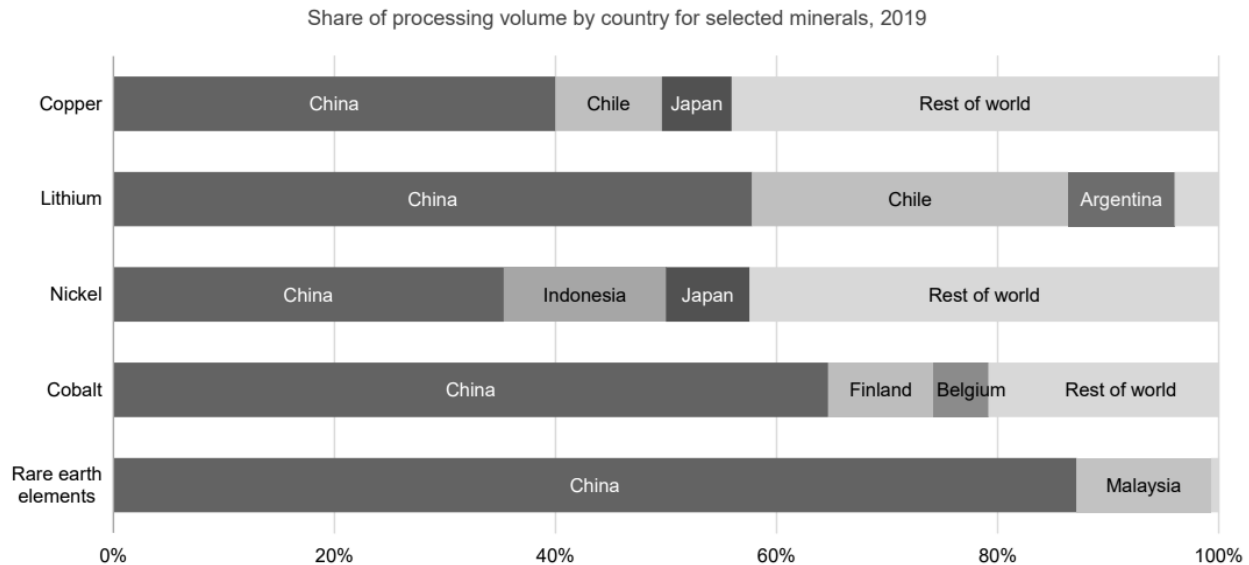
Section IV.C.7 of the Preamble discussed several critical minerals important to battery cell production including lithium, nickel, cobalt, graphite, and manganese. In that section we described these minerals and their processing into battery materials as being widely but not evenly distributed across the world.

As shown in Figure 3-12 the IEA estimates that in 2019 about 50 percent of global nickel production occurred in Indonesia, Philippines, and Russia, with the rest distributed around the world. Nearly 70 percent of cobalt originated from the Democratic Republic of Congo, with some significant production in Russia and Australia, and about 20 percent in the rest of the world. More than 60 percent of graphite production occurred in China, with significant contribution from Mozambique and Brazil for another 20 percent. About half of lithium was mined in Australia, with Chile accounting for another 20 percent, and China about 10 percent (IEA 2022).



**Figure 3-12: Share of top three producing countries for critical minerals and fossil fuels in 2019 (IEA).**

According to the Administration's 100-day review under E.O. 14017, of the major actors in mineral refining, 60 percent of lithium refining occurred in China, with 30 percent in Chile, and 10 percent in Argentina. 72 percent of cobalt refining occurred in China, with another 17 percent distributed among Finland, Canada, and Norway. 21 percent of Class 1 nickel refining occurred in Russia, with 16 percent in China, 15 percent in Japan, and 13 percent in Canada (The White House 2021). Similar conclusions were reached in an analysis by the International Energy Agency, shown in Figure 3-13.



**Figure 3-13: IEA accounting of share of refining volume of critical minerals by country (IEA 2022).**

Since the proposal, the Department of Energy (DOE) worked with ANL to provide an independent analysis of the outlook for critical minerals including nickel, cobalt, graphite, lithium, and manganese (ANL 2024b). ANL consulted the latest available announcements and forecasts to develop an up-to-date assessment of activity in advancing the availability of these minerals on a global and domestic basis. Findings from this work and how we considered them in our assessment are discussed in Section IV.C.7 of the preamble to this rule. A summary of some high level takeaways from this work relating to the distribution of minerals across the world are provided here.

Although the U.S. has nickel reserves, and opportunity also exists to recover significant nickel from mine waste remediation and similar activities, at present it is more convenient to import it from established producers in other countries, with 68 percent coming from Canada, Norway, Australia, and Finland, countries with which the U.S. has good trade relations; according to the USGS, ample reserves of nickel exist in the U.S. and globally, potentially constrained only by processing capacity (The White House 2021). ANL notes that currently, there is no Class I (battery grade) nickel production or refining in the U.S, and that there has been an influx of investment by China in Indonesia, a major global producer of nickel (ANL 2024b).

The U.S. has numerous cobalt deposits, but few are developed, although some have produced cobalt in the past; about 72 percent of U.S. cobalt consumption is currently imported (USGS 2020). ANL notes that China controls about 50 percent of cobalt production in the Democratic Republic of Congo (DRC), a major global producer of cobalt.

Similar observations may be made about graphite. The U.S. has significant deposits of natural graphite, but graphite has not been produced in the U.S. since the 1950s and significant known resources remain largely undeveloped (USGS 2022). ANL notes that China dominates natural graphite production and has been a major source of U.S imports. ANL also indicates that meeting U.S. demand with natural supply from free trade agreement (FTA) and Mineral Security Partnership (MSP) (State Department 2023) countries is unlikely in the near term, but medium term synthetic graphite scaling has potential to mitigate graphite risk (Reuters 2023). Another

concern is that in 2023, China imposed an export permit requirement on graphite, which will temporarily reduce graphite exports due to a 45-day application period for permits, and suggests that graphite exports from China may be controlled in the future. However, at this time it is not clear that this requirement will meaningfully impact exports over the long term, as similar permit requirements have existed on other exports; Wood Mackenzie reports that a change to material flows is unlikely, and that a graphite supply chain outside of China is rapidly developing (Wood Mackenzie 2023).

With regard to nickel, cobalt and graphite, ANL also identifies potential enabling approaches to mitigate the risks that they identify. For nickel, continued economic partnership and trade with non-FTA countries with significant capacity, such as Indonesia, Philippines, Botswana, South Africa, Papua New Guinea, Madagascar, Tanzania, and Zambia provide an avenue to securing supply. Efforts to strengthen battery recycling in the U.S and ally nations is also identified, as well as collaborative efforts with FTA and MSP partners to ensure mining project success (for example, financing promising projects in FTA and non-FTA countries. In the longer term, ANL also identifies use of battery chemistries that use less or no nickel. With regard to cobalt, the same approaches are identified, including economic partnership and trade with non-FTA countries including Indonesia, Philippines, Zambia, Papua New Guinea and Madagascar. For graphite, ANL identifies similar economic partnership and trade objectives, as well as strengthening synthetic graphite production capacity in the U.S. and ally nations.

ANL assesses that domestic lithium production is currently limited, but the next decade could see a surge from promising projects that are already underway, potentially satisfying domestic demand and allowing the U.S. to become a global leading producer of lithium depending in part on the progress of permitting and other contingencies common to any new mining operations. As described in Preamble IV.C.7, the U.S. government is actively working through various programs to streamline U.S. mining as well as promote and pursue partnerships and resource development opportunities in FTA countries, MSP countries, and allies. ANL also notes that in both the near and medium term, a significant portion of domestic lithium demand can be met by lithium in the U.S and in FTA countries, with several MSP partners likely to add capacity. ANL identifies several potential mitigation approaches for any remaining risk, including collaborative efforts with FTA and MSP partners to ensure mining project success in the U.S, FTA and non-FTA countries, pursuing offtake agreements for stockpiling lithium from U.S producers to alleviate downward price pressure that could discourage development of new sources, and strengthening recycling in the U.S. and ally nations.

ANL also extended its analysis to manganese, which EPA did not individually assess in the proposal as being of critical concern. ANL assesses that currently, there is no production of battery grade manganese in the U.S., but there are six facilities that process manganese ore in the U.S., and agrees with our initial assessment that compared to expected U.S. demand, manganese supply is not critical. However, most of the significant production is in non-FTA countries, primarily Australia, South Africa, and Gabon, with the latter currently accounting for two-thirds of U.S. manganese ore imports.

For nickel, ANL noted that there are significant efforts to scale nickel supply in FTA countries, with a majority of early-stage exploration projects in Australia and Canada. While the probability of these early-stage projects to add to capacity by 2035 is low, they indicate global efforts are taking place to scale nickel availability to meet global demand. Exploration efforts for

nickel in the U.S. specifically are currently limited, reflecting current geological sources and technology. About 50% of global mining is in Indonesia. Most Class I (battery grade) nickel is cost effective to produce from sulfide deposits, with the majority of supply likely to be originally sourced from Indonesia, Australia, Canada, Russia, and Philippine mines. Currently there is no Class I nickel production in the U.S., but ANL anticipates that some nickel mining supply could be refined into battery grade. ANL identifies several U.S. policy levers that could support build out of nickel battery grade refining and recycling capabilities, for example, the DOE Loan Programs Office (LPO), and funding under the Bipartisan Infrastructure Law (BIL) and Inflation Reduction Act(IRA). ANL concludes that international trade is likely to be important to strengthening U.S. supply of nickel.

Like nickel, there are significant efforts to scale cobalt supply in the FTA countries. Cobalt and nickel tend to be co-located and co-produced, so the same projects that produce nickel often also produce cobalt. The majority of early stage and exploration projects are in Australia and Canada. While probability of these early-stage projects to add to capacity by 2035 is small, they indicate global efforts to scale cobalt to meet global demand. Exploration efforts for cobalt in the U.S. is limited. While the Democratic Republic of Congo (DRC) is and will continue to be a key global source of cobalt mining supply (currently about 70 percent of global cobalt mining supply), other promising sources outside DRC include Indonesia and Australia. Importantly, the majority of global mined cobalt is currently refined in China. Cobalt production in the U.S. is very limited and there is no cobalt refinery, but several efforts exist to support build out of domestic cobalt refining. DOE concludes that trade with non-FTA countries including allies in addition to FTA and MSP partners will be key to securing cobalt supply for those lithium-ion chemistries that use it. ANL additionally identifies policy levers to promote both domestic production and supply partnerships with these nations. ANL also notes that other chemistries such as LFP do not need cobalt and are suitable for many applications.

Graphite has similarities to nickel and cobalt in that there are significant efforts to scale graphite supply in the FTA countries. The majority of early stage and exploration projects are in Canada and Australia. There is no current U.S. production of graphite from mine sources, and exploration efforts are currently limited. China is likely to continue to be the leading producer of natural graphite in the world, while in the near term other countries such as Tanzania, Mozambique, Canada, and Australia are likely to increase supply, diversifying global supply away from China. This suggests that in the near term and medium term, a significant portion of natural graphite will be in non-FTA countries. FTA countries (Canada and Australia) are likely to add natural graphite capacity over the medium term. The earliest U.S. production of natural graphite is anticipated in 2025 from Coosa County, Alabama with capacity of 7,500 metric tons per year, with the biggest project anticipated to come online in 2028 from Graphite Creek with capacity of 51,000 tons per year. In addition to natural graphite from mine sources, synthetic graphite shows promising opportunities with the earliest project anticipated to come online in 2024. International trade will likely continue to play a crucial role in securing graphite supply. Currently, the major U.S. source of imports other than China include Canada, Mexico, Madagascar, Brazil, and Mozambique, and these sources are likely to continue to be major sources of import for U.S. manufacturers.

Regarding lithium, DOE finds that there are significant efforts to scale lithium supply both domestically and also in the FTA countries. The majority of early stage and exploration projects are in Australia, Canada, and the U.S. DOE assesses that the U.S. is well positioned in securing

lithium materials domestically, particularly if all projects underway (particularly later stage projects) are successful. Global lithium mining supply is anticipated to more than double in the next five years. In fact, if lithium demand does not match this supply, it could lead to oversupply and create downward price pressure. Several U.S. projects are in the construction stage, including at Fort Cady, Thacker Pass, Rhyolite Ridge, and King Mountains, with others undergoing prefeasibility or feasibility studies, e.g., Great Salt Lake. Through such projects the U.S. lithium supply is expected to more than double by 2025, and the U.S. is poised to become a global key player in lithium industry if all ongoing projects come to fruition and can overtake current key players such as Australia, Argentina and Chile. The majority of U.S. lithium production is likely to come from brines, which are relatively cheaper to produce compared to lithium from spodumene deposits. Both in the near term and the medium term a significant portion of lithium will be available domestically and in FTA countries, likely enough to meet domestic demand. Several FTA and MSP partners, such as Canada and Germany, are likely to add capacity over the medium term, further strengthening U.S. lithium availability. DOE assesses that the U.S. largely has sufficient lithium supply to meet domestic demand of battery manufacturers under a number of reasonable demand scenarios. Only in the near term will the U.S. likely depend on imported lithium, and sufficient additional capacity exists in FTA countries to meet this import demand. Specifically, international trade will continue to be important in the next three years as the U.S. scales domestic production; from 2025, if all U.S. projects currently underway commence production and scale as expected, the U.S. may have sufficient lithium to meet domestic manufacturer demand with an opportunity to be a net exporter of lithium.

With regard to manganese, DOE assesses that both in the near term and medium term, a significant portion of manganese will be available domestically from non-FTA countries. While capacity in FTA and MSP partners is concentrated in a few countries such as Australia, Canada, and India, it is likely to be sufficient to meet U.S. demand in both the near and medium term. Conversely, because there is limited outlook for manganese production in the U.S. due to the poor quality of ore prospects, the U.S. is likely to depend on FTA-imported mining supply to meet domestic demand for the foreseeable future.

It is important to note that where U.S. mineral sources may be limited, importation from FTA countries is consistent with mineral sourcing requirements for the 30D clean vehicle credit. Even where minerals from non-FTA countries are used, this content does not prevent these vehicles from being sold in the U.S. market, and the mineral content they represent will become domestic content when recycled. DOE has performed additional analysis relating its domestic critical mineral findings to its projections of 30D/45W uptake which EPA uses in its analysis, and this analysis is described in the ANL critical minerals report (ANL 2024b).

In its assessment, DOE notes that a number of uncertainties affect every forward-looking assessment of mineral and manufacturing trends, and EPA has considered this fundamental layer of uncertainty which could cause these projections to prove either optimistic or pessimistic. It is well known in the forecasting and cyclical commodities industries that price volatility can be driven by demand or supply, or both. While oversupply is positive for battery cost in the short term, it can lead investors to consider some development projects uneconomical. Slow demand growth can be a factor in lower-than-expected prices. In a near term perspective, something as simple as a temporary drop in consumer demand due to changes in economic fundamentals can contribute to such a situation. Over the medium to long term, the same impact can result from

changes in policy, or technology disruption (e.g., substitution of one mineral for another, or alternative chemistries that eliminate the mineral as mentioned previously). Another uncertainty, particularly in the U.S., is permitting for new mining projects, which can take several years. Financing is also subject to uncertainty, as mining is considered to be a relatively high-risk investment that pays off over a long time frame, subject to the uncertain factors above. Political and social risks, such as war, changes in trade policy, and labor disputes are additional factors. In some cases, the location of a mine may be remote, leading to potential difficulties in attracting qualified labor.

While all of these uncertainties can have an impact on future projection of progress in mineral production, it is also true that all mineral production currently in operation has transcended these risks, often in periods of far less rapid growth in demand of the minerals involved. With the importance of battery minerals in many different sectors that are relevant to reducing pollution and GHG, demand for these minerals is rapidly growing. As these uncertainties are well understood to accompany most if not all mining investments, EPA does not consider these factors to be uniquely restrictive of the ability of the global industry to develop mineral production capacity in response to what is widely understood to be an era of robust demand.

This section has reviewed some supplemental information related to critical mineral sources. The primary body of our assessment of battery cell and cell component manufacturing, critical minerals, and mineral security resides in the preamble Section IV.C.7, where we analyze and cite all relevant evidence and form our conclusions regarding these topics as they relate to compliance with the standards. For references and full discussion please refer to the specific preamble sections cited below and where applicable, other relevant sections of the preamble and RIA.

#### **3.1.4.3 Enabling Approaches on Strengthening Supply Chains**

The 2024 ANL study titled "Securing Critical Minerals for the U.S. Electric Vehicle Industry" (ANL 2024b) was developed and published concurrently with the development of the final rule. EPA has carefully considered the extensive findings of this work and considers it thorough and up to date, representing some of the best available information on the status and outlook for critical mineral availability now and during the time frame of the rule. EPA has cited this study frequently in the preamble and in this RIA as a key reference in developing our outlook for critical minerals in the context of compliance with the standards.

In examining mineral supply and demand, the ANL study also pays close attention to the primary uncertainties relevant to increasing mineral production and availability, as well as a number of enabling approaches that U.S. government and industrial actors are pursuing as part of a broad strategy to further increase domestic critical mineral supply. These efforts are generally important to understanding how minerals and related products can be accessed reliably through a combination of domestic sources and through global partners including our FTA partners, MSP partners, and allies. We briefly mention some of these activities in section IV.C.7 of the preamble. Here we provide a further summary of some of the approaches specifically identified in the ANL study, to provide a sense of some of the enabling activities that are currently being pursued by the U.S. government. Citations, additional detail and further examples of current activities are available in the ANL study.

- Collaboration with trading partners is a major focus of attention. This involves diversifying supply chains beyond existing free trade agreements by strengthening trade with potential countries that have or could have significant capacity, as well as joint efforts with MSP partners to ensure the success of mineral projects in member countries through coordinated financial assistance, mobilizing both government and private capital, providing technical expertise, and streamlining ESG standards to include traceability standards. Collaboration could extend to financing promising projects within non-FTA countries by approaches such as leveraging existing and new interagency efforts across various agencies and departments such as State, Commerce, DOE, USAID, US DFC, USTDA and EXIM, in collaboration with the private financing sector.
- Improving the permitting process for critical minerals projects is another thrust of activity. The Biden-Harris Permitting Action Plan (May 2022) and subsequent implementation guidance (March 2023) identifies key steps including: acceleration of permitting through early cross-agency coordination, establishing clear timeline goals and tracking, engaging in early and meaningful outreach and communication with Tribal Nations, States, territories, and local communities, improving agency responsiveness, technical assistance, and support, and adequately resourcing agencies and using the environmental review process to improve environmental and community outcomes.
- Stockpiling and supply chain readiness is another focus. Strategic stockpiles can serve as a buffer against potential disruptions. This approach could also protect domestic projects to develop mining and recycling from intentional oversupply (product dumping) by actors aimed at reducing global competition. Efforts around stockpiling are already in progress. For example, DOD, DOE, and the State Department are laying the foundation for a new interagency process for stockpiling minerals. Other efforts to stabilize supply chain volatility and uncertainty include better data tracking and sharing, alert systems, and international partnerships to respond to supply chain disruptions.
- Increasing domestic recycling capacity can be a strong factor in reducing future need for new critical minerals. The Federal Consortium for Advanced Batteries (FCAB) developed a National Blueprint for Lithium Batteries, outlining near-term objectives to achieve the goal of scaling end-of-life reuse and recycling for minerals. The DOE has also announced \$37 million in available funding to improve the economics and industrial ecosystem for battery recycling.
- Advanced recycling techniques such as direct recycling can offer lower costs when, commercialized and scaled. The BIL funds research and development for advanced recycling; DOE has already announced more than \$45 million for advanced recycling projects, including direct recycling.



- Identifying non-traditional sources of critical materials that are available domestically, such as industrial by-products and mining waste streams, can also help meet minerals demand over time. The U.S. government is supporting efforts to fund research into non-traditional sources of minerals: for example, in February 2024, DOE announced it would invest \$17 million into projects to recover minerals from coal-based resources, and in November 2023 USGS announced \$2 million to 14 states to study critical minerals in mine waste. Research suggests that resource recovery from coal and mining waste may also help remediate abandoned mines.
- Workforce development can be promoted by coordination and collaboration with academic institutions and training centers to develop the next-generation workforce to serve the potentially growing domestic mining sector. For example: DOE, in collaboration with DOL, AFL-CIO, and other partners, launched the Battery Workforce Initiative through the National Energy Technology Laboratory (NETL) to develop training up and down the battery supply chain. Talon Metals and the United Steelworkers have also announced a joint workforce development partnership for the Tamarack Nickel Project. The FY24 NDAA directs that the Defense Department study the feasibility for and plan for the creation of a University Affiliated Research Center for Critical Minerals which would assess institutional capabilities and investments needed for workforce development to support needs related to critical materials. The Department of Commerce, through the CHIPS Act is funding workforce development across the battery supply chain in Missouri, New York, and Nevada.
- Strengthening environmental, social and governance (ESG) implementation can be key to reducing risk for mining projects to improve chance of production and reduce impact. Strategies include pursuing robust consultation with communities near where mining resources are located, and adherence to strong labor, human rights and environmental practices. Internationally, some USG efforts already exist to advance ESG compliance and to improve environmental and social outcomes of minerals development. DOE's Advanced Research Projects Agency-Energy (ARPA-E) is funding 16 projects across 12 states that aim to increase mineral yield while decreasing energy and emissions from mineral extraction. The U.S. Department of Labor (DOL) offers resources to companies looking to mitigate risks related to labor violations and programs to raise awareness and address international ESG. Through the IPEF Supply Chain Agreement, the U.S. is also engaged in a Labor Rights Advisory Board to promote worker rights across supply chains. The "Presidential Memorandum on Advancing Worker Empowerment, Rights, and High Labor Standards Globally" directs the Secretaries of State, Labor, Energy, Treasury, Homeland Security, and Commerce along with the Administrator of USAID and the U.S. trade representative to address labor rights across global supply chains.
- Community and tribal engagement is also important to addressing potential conflict between communities and mining interests, which increase risk and uncertainty to all stakeholders when mineral resources are identified for development. Many grants and

loans provided by the Department of Energy under BIL and IRA require applicants to submit a Community Benefit Plan, which is evaluated at 20 percent of the overall application; community agreements such as Community Benefit Agreements (CBAs) and other community and workforce agreements are strongly encouraged by these programs, which may provide funding to mining and materials processing initiatives. The DOE also sponsors programs that incentivize the transition of defunct mines into clean energy sites, including the Biden Administration's \$500 Million Program to Transform Mines Into New Clean Energy Hubs and the Qualifying Advanced Energy Project Credit (48C) Program.

ANL also notes, as EPA noted in the preamble discussion, that mineral substitution holds strong potential to reduce dependence on some minerals. For example, cobalt and nickel in cathode materials can be eliminated by iron phosphate which is appropriate for some applications and is already taking place. Sodium-based chemistries currently under development and beginning to enter production could reduce the need for lithium. Electrode compositions that improve energy density, safety, and cost, as well as new battery technologies like solid-state and Li-metal, can also help over the long term.

Through these and other examples the ANL study provides evidence of currently identified approaches, current activity, and relevant goals that are accompanying efforts to promote and maintain a secure supply of minerals and related products for U.S. industry.

### **3.1.5 Modeling Constraint on Rate of PEV Technology Penetration**

This section details how EPA developed a modeling constraint to represent a potential production-based limit on the rate of penetration of PEV technology into the fleet during the timeframe of the standards.

In modeling potential PEV penetration into the fleet as a result of the standards, EPA considered how best to represent any limitations that are likely to be imposed by the supply chain. Potential constraints on availability of minerals that are used in the manufacture of PEVs are particularly relevant to projecting practical limits on the rate of penetration of PEVs into the fleet in the future. EPA considered data from industry analysts, including Wood Mackenzie and Benchmark Minerals Intelligence, to pursue a quantitative and qualitative understanding of the future availability of these critical battery minerals during the time frame of the rule.

From a modeling perspective, the question of how to constrain the modeled rate of BEV penetration to remain within limits imposed by the developing supply chain is an important one. As part of the rulemaking analysis, EPA uses its OMEGA model to identify compliance pathways (in other words, applications of available technology to the fleet) by which manufacturers can meet the standards. The OMEGA model selects among available advanced vehicle technologies and applies them to the fleet in the most cost-effective way, given the cost of each technology and its effectiveness at achieving manufacturer compliance within the fleet averaging structure of the program. Although BEV technology has a higher absolute cost than many other technologies, it is particularly attractive to manufacturers because BEVs achieve zero tailpipe emissions and are credited with such under the compliance accounting. On the other hand, there is likely to be a limit to the rate at which BEV technology can phase into the fleet due to various constraining forces such as growth in consumer acceptance, timing of refresh/redesign

cycles, activation of battery cell and pack manufacturing capacity, and critical mineral availability, particularly in the early years of the analysis. If these constraints were not represented, the OMEGA model might select BEV technology at a rate that results in a faster penetration of BEVs into the fleet than these real-world constraints might practically allow. EPA implemented several constraints in the OMEGA model to account for these factors.

Consumer acceptance is discussed in more detail in Chapter 4 of this RIA, and its representation by means of S-curves in the OMEGA model is discussed in Chapter 2.6.3. Refresh/redesign cycles are also represented in the OMEGA model and are discussed in more detail in Chapter 2.6.4 of this RIA as well as IV.C of the Preamble.

To implement a constraint representing the potential for battery manufacturing capacity or critical mineral availability to constrain PEV production, EPA implemented a constraint in terms of Gigawatt-hours (GWh) of lithium-ion battery production per year that could be available for BEVs supplying the U.S. new vehicle fleet. As described below, we developed this constraint by considering estimates of existing and announced battery production capacity in North America and comparing these forecasts to estimates of projected lithium supply and demand. We considered available data on forecast battery manufacturing capacity, global lithium demand, and global lithium chemical production. As all such estimates concern prediction of future events and are by nature uncertain (particularly in the out years), we adopted a simplified approach that provided what we consider to be a reasonable and conservative view of future PEV production capacity as constrained by manufacturing and mineral supply.

We selected lithium supply as the primary mineral-based limiting factor for several reasons. In Preamble IV.C.7 we noted that cobalt, nickel, and manganese are important to today's leading battery chemistry formulations, but we also note that there is some flexibility in choice of cathode minerals, and in many cases, opportunity will exist to reduce cobalt and manganese content or to employ iron-phosphate cathode chemistries that do not utilize nickel, cobalt, or manganese. Graphite is used as the anode of most current and near-term PEV battery chemistries, and all require lithium in the form of lithium carbonate or lithium hydroxide in the electrolyte and the cathode. The role of natural graphite in many cases can be served by artificial graphite or highly refined hard or amorphous carbon. However, lithium has no substitute in commercially produced automotive applications at this time (however, see the discussion of alternatives to lithium under development, later in this section). Although the common chemistries vary in their need for either lithium hydroxide or lithium carbonate, either can potentially be produced from available lithium sources.

Further, and as described in greater detail in the preamble to the original proposal, we considered projections of cobalt, nickel, and lithium supply and demand published in 2022 by the International Energy Agency (IEA), which concluded that supply of cobalt and nickel should be sufficient to meet demand between 2020 and 2030 for the two most likely demand scenarios modeled, while lithium demand may begin to approach available supply after 2025. By contrast, as also described in the original proposal, projections made by DOE in November 2022 indicate that global supplies of cathode active material (and incidentally, lithium chemical products) are within the range of expected global demand through 2035.

In the preamble to the original proposal we described the development of our assessment that battery mineral supply is likely to be sufficient to meet the standards. The data examined also suggested that, among the primary critical minerals needed for battery manufacturing, growth in

demand for lithium would likely be the first to approach available supply, if a battery mineral shortage were to be encountered. Accordingly, we focused on lithium availability as a potential limiting factor on the rate of growth of PEV production, and thus the most appropriate basis for establishing a modeling constraint on PEV penetration into the fleet over the time frame of the rule.

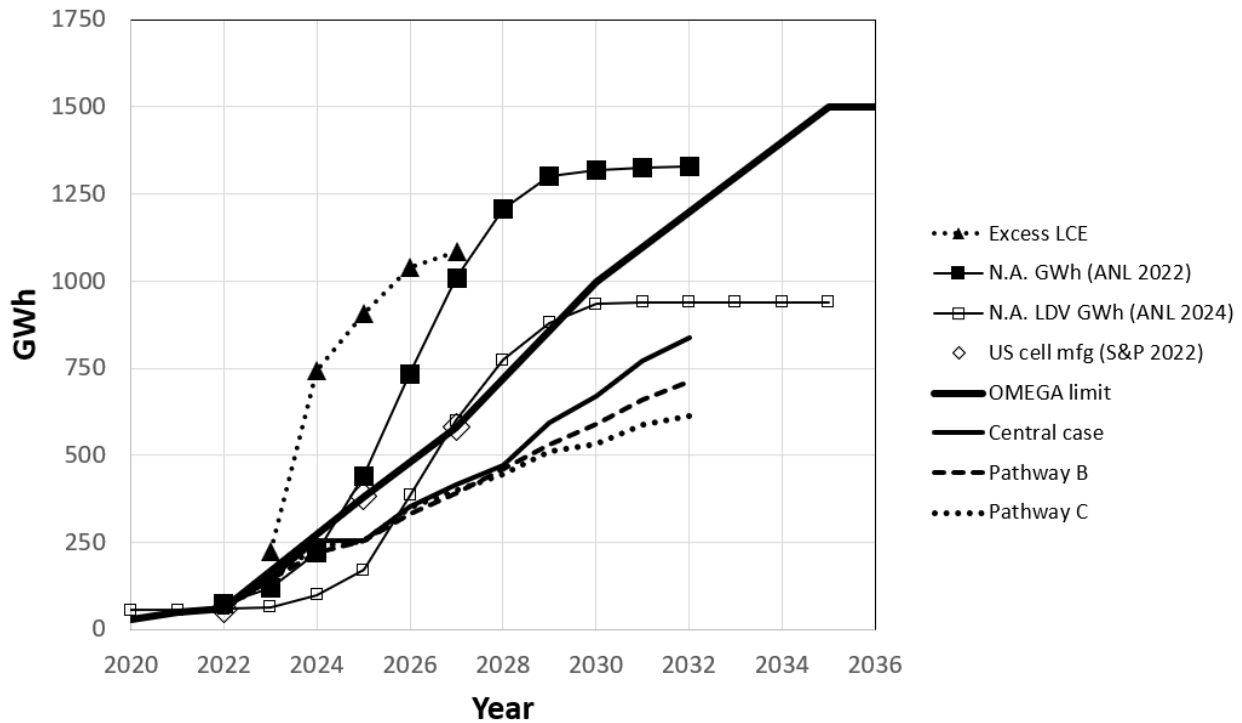
With regard to battery manufacturing capacity in the U.S., we considered estimates of announced manufacturer plans and currently installed capacity as reported in mid-2022 by S&P Global and in late 2022 by Argonne National Laboratory (ANL 2022). S&P Global indicated that U.S. battery manufacturing capacity will reach 382 GWh by 2025 (S&P Global 2022a), and 580 GWh by 2027. (S&P Global 2022b).

Although these forecasts suggest that planned manufacturing facility capacity could be a potential basis for a modeling constraint on battery production, this would not reflect the possibility that operating capacity could be constrained by mineral availability. We thus sought to condition these production capacities by comparing them to estimates of global lithium supply and demand.

Here it is relevant to note that, although the Inflation Reduction Act incentivizes use of domestically sourced and processed mineral products, it only ties these products to availability of the related tax incentives (primarily the Clean Vehicle Credit under 30D) and does not prohibit use of imported mineral products by manufacturers that cannot secure domestic sources. Thus, it is the global supply for lithium, not only domestically sourced supply, that potentially constrains battery production.

We then referred to proprietary projections of lithium chemical capacity obtained from Wood Mackenzie through a service subscription (Wood Mackenzie 2022). Forecast lithium production in tons per year was reported as lithium carbonate equivalent (LCE) which EPA converted to GWh of gross battery capacity using a widely accepted conversion factor. As a first-order, conservative approximation of lithium availability to supply U.S. demand, we first subtracted the Wood Mackenzie projections of U.S. lithium demand from their projections of global demand, to estimate a "rest of world" (ROW) lithium demand trajectory. We then calculated the difference between the ROW demand trajectory and the Wood Mackenzie high and low estimates of global lithium chemical production. This difference was taken to represent a hypothetical lithium production capacity that would be available to the U.S. market, assuming that ROW demand was satisfied first, and growing demand did not generate a demand response among lithium suppliers beyond what is already represented in the forecast. This is a conservative assumption, as market forces would ultimately play some role in determining distribution, and increased demand would likely result in higher prices and greater market certainty for investment in additional supply capacity. We also noted that the resulting availability curve would be most applicable to earlier years, as the data on which it was based does not represent likely industry response to increased lithium demand as the market continues to grow. For this reason, we do not depict the supply curves beyond 2027 due to the lack of modeled demand response in the underlying data.

Figure 3-14 shows the S&P and Argonne battery plant production capacity estimates plotted against the calculated lithium carbonate equivalent (LCE) production capacity potentially available to the U.S. market after global projected demand is satisfied (in estimated battery GWh equivalent).



**Figure 3-14: Limit on battery GWh demand implemented in OMEGA, compared to projected battery manufacturing capacity and excess LCE supply.**

We then examined this data to establish a conservative but reasonable limit on GWh battery supply for use by the OMEGA model. First, we noted that the S&P estimate of U.S. battery manufacturing plant production capacity, which due to its earlier date of origin is conservative with respect to today and extends only to 2027, is well beneath the low estimate of hypothetical "excess" lithium supply. This suggests that lithium supply is more than sufficient to sustain the S&P estimate of U.S. plant operation at full capacity.

The ANL 2022 accounting of U.S. plant capacity is larger than the S&P accounting, reflecting the pace of newer announcements. It begins to exceed the low estimate of excess lithium supply in 2026 but is still well within the upper limit afterward.

As a conservative bound on battery production capacity for the OMEGA model, we thus followed the S&P trajectory to 2027 at 580 GWh. This trajectory stays within lower expected lithium excess capacity for the first several years, when limited time is available for new capacity to come on-line.

Past 2027, estimates of "excess" lithium as a difference between ROW demand and a current accounting of global supply become less informative, because a demand response is not built into the supply data. Therefore, uncertainty about the supply-demand balance against ROW demand increases as the time horizon increases. In general, analysts believe that as demand for a mineral commodity remains strong over time, investment in mining operations and exploration will consistently increase, which leads to unknown or previously unprofitable geological sources to become available (Sun, Ouyang and Hao 2022). In resonance with this fact, we noted that it

seems very unlikely from an investment point of view that manufacturers and battery suppliers would plan to construct plant capacity to come online in 2030 if it exceeds their expectation of availability of mineral products to supply the plant's production. Given the amount of lead time in the time frame past 2027 and the current level of activity in development of supply chain capacity across the world, we considered it reasonable to expect that the ANL estimate for 2030 at 1320 GWh should be feasible to supply. However, to retain a conservative estimate to reflect uncertainty, for the purpose of creating a constraint line we retained the previous estimate of 1000 GWh ANL had provided at the time of the proposal and which we had used in the proposal. We then continued a similar rate of increase to 2035 at 1500 GWh. Passing through these three defined points results in an almost linear growth rate that we then adopted as the annual battery GWh production limit for OMEGA modeling purposes, which is unchanged from the proposal. We flattened the limit at 1500 GWh after 2035 due to lack of data for that time period.

Since the proposal, an updated and more detailed estimate by Argonne National Laboratory was published in March 2024 (ANL 2024a). This included a 36 month delay time from anticipated plant opening date to operation at full capacity using a linear ramp up. This study is described in more detail in section IV.C.2 and IV.C.7 of the preamble. The figure above shows the ANL 2024 estimate for North American cell manufacturing capacity that is designated for light-duty vehicles (excluding uses for heavy-duty vehicles and stationary applications). These later and more specific estimates of North American manufacturing capacity continue to be in excess of the demand projected by the final standards and Pathways B and C. Because during the time frame of the rule the projected GWh demand under the central case and the alternative pathways B and C do not exceed the updated ANL 2024 manufacturing capacity projection nor the GWh constraint that was developed for the proposal, the GWh constraint is not controlling on the results. EPA therefore did not consider it necessary or useful to modify the GWh constraint for the FRM analysis as there was no evidence of reduced lithium availability that would suggest the constraint should be tightened and it was not controlling on the result.

Here it is also important to note, again, that our estimate of lithium available to the U.S., as the difference between currently anticipated global lithium supply and ROW demand, would be expected to be a conservative estimate because it quantifies only currently known sources of lithium that would not be subject to demand elsewhere, and does not reflect the development of additional sources over time.

The numeric values for the annual GWh limit input to OMEGA are provided in RIA Chapter 2.6.4.2. More details on how OMEGA calculates BEV battery capacities that are summed to a fleet GWh production capacity is provided in RIA Chapter 2.5.2.1.1.

### **3.2 Criteria and Toxic Pollutant Emissions Standards**

EPA is finalizing changes to criteria pollutant emissions standards for both light-duty vehicles and medium duty vehicles (MDV). Light-duty vehicles include LDV, LDT, and MDPV. NMOG+NO<sub>x</sub> changes for light-duty vehicles include a declining fleet average standard, the elimination of higher certification bins, a requirement for the same fleet average standard to be met across four test cycles (25°C FTP, HFET, US06, SC03), a change from a fleet average NMHC standard to a fleet average NMOG+NO<sub>x</sub> standard in the -7°C FTP test, and three NMOG+NO<sub>x</sub> provisions aligned with the CARB Advanced Clean Cars II program.

NMOG+NO<sub>x</sub> changes for MDV include a fleet average that declines from 2027-2033 in the early compliance program or steps down in 2031 in the default program, the elimination of higher certification bins, a requirement for the same fleet average emissions standard to be met across four test cycles (25°C FTP, HFET, US06, SC03), and a new fleet average NMOG+NO<sub>x</sub> standard in the -7°C FTP. EPA is also finalizing in-use standards for spark ignition and compression ignition MDV with GCWR above 22,000 pounds from proposed Alternative 2 that are consistent with MY 2031 and later California chassis-certified MDV in-use emissions standards.

EPA is finalizing a continuation of light-duty vehicle and MDV fleet average FTP NMOG+NO<sub>x</sub> standards that include both ICE-based and zero emission vehicles in a manufacturer's compliance calculation. Performance-based standards that include both ICE and zero emission vehicles are consistent with the existing NMOG+NO<sub>x</sub> program as well as the GHG program. EPA considers the availability of battery electric vehicles as a compliance strategy in determining the appropriate fleet average standards. Given the cost-effectiveness of BEVs for compliance with both criteria pollutant and GHG standards, EPA anticipates that most (if not all) automakers will include BEVs in their compliance strategies. However, the standards continue to be a performance-based fleet average standard with multiple paths to compliance, depending on choices manufacturers make about deployment of a variety of emissions control technologies for ICE as well as electrification and credit trading.

EPA is finalizing a PM standard of 0.5 mg/mi for light-duty vehicles and MDV that must be met across three test cycles (-7°C FTP, 25°C FTP, US06), a requirement for PM certification tests at the test group level, and a requirement that every in-use vehicle program (IUV) test vehicle is tested for PM. The 0.5 mg/mi standard is a per-vehicle cap, not a fleet average.

EPA is finalizing CO and formaldehyde (HCHO) emissions requirement changes for light-duty vehicles and MDVs including transitioning to emissions caps (as opposed to bin-specific standards) for all emissions standards, a requirement that CO emissions caps be met across four test cycles (25°C FTP, HFET, US06, SC03), and a CO emissions cap for the -7°C FTP that is the same for all light-duty vehicles and MDVs.

EPA is finalizing a refueling standards change to require incomplete MDVs to have the same on-board refueling vapor recovery standards as complete MDVs.

EPA is finalizing that light-duty vehicle 25°C FTP NMOG+NO<sub>x</sub> credits and -7°C FTP NMHC credits (converting to NMOG+NO<sub>x</sub> credits) may be carried into the new program. MDV 25°C FTP NMOG+NO<sub>x</sub> credits may only be carried into the new program if a manufacturer selects the early compliance pathway. New credits may be generated, banked, and traded within the new program to provide manufacturers with flexibilities in developing compliance strategies.

The finalized criteria pollutant phase-in schedules apply to NMOG+NO<sub>x</sub> bin structure, -7°C NMOG+NO<sub>x</sub>, PM, CO, HCHO, -7°C CO, and three light-duty vehicles provisions aligned with CARB ACC II, and standards for MDV with GCWR above 22,000 pounds.

Chapters 3.2.1 through 3.2.4 summarize the standards being finalized for light-duty vehicles and MDV for NMOG+NO<sub>x</sub>, PM, CO, and HCHO, and in-use standards for high GCWR MDV.

Chapter 3.2.5 and Section III.D.2 of the preamble demonstrate the feasibility of the NMOG+NO<sub>x</sub> standards including the NMOG+NO<sub>x</sub> light-duty vehicle provisions aligned with

the CARB ACC II program. Chapter 3.2.6, together with Section III.D.3 of the preamble, demonstrate emission control technology and measurement procedure readiness, emissions benefits, and the importance of the three certification test cycles for the PM standards, as well as quantifying GPF cost and impact on CO<sub>2</sub> emissions. Section III.D.4 of the preamble demonstrates the feasibility of the CO standards. Chapter 3.2.7 and Section III.D.6 of the preamble demonstrate the feasibility of the refueling emissions standards.

### **3.2.1 NMOG+NO<sub>x</sub> Standards**

The final NMOG+NO<sub>x</sub> standards, including declining fleet averages, the elimination of higher certification bins, a requirement for the same fleet average emissions standard to be met across four test cycles (25°C FTP, HFET, US06, SC03), a change from a fleet average NMHC standard to a fleet average NMOG+NO<sub>x</sub> standard in the -7°C FTP test, three NMOG+NO<sub>x</sub> provisions aligned with CARB ACC II for light-duty vehicles, and MDV in-use emissions standards, are discussed in Section III.D.2 of the preamble. For reference, the final NMOG+NO<sub>x</sub> standards for light-duty vehicles and MDV are shown in the tables below.

#### **3.2.1.1 NMOG+NO<sub>x</sub> Bin Structure for Light-Duty and MDV**

The final bin structure for light-duty vehicles and MDV is shown in Table 3-3. The upper six bins (Bin 75 to Bin 170) are only available to MDV. For light-duty vehicles, the finalized bin structure removes the two highest Tier 3 bins (Bin 160 and Bin 125) and adds new bins such that the bins increase in 5 mg/mi increments from Bin 0 to Bin 70. For MDV, the finalized bin structure also moves away from separate bins for Class 2b and Class 3 vehicles, adopting light-duty vehicle bins along with higher bins only available to MDV. In part due to comments received from MDV manufacturers, the final MDV-only bins have been harmonized with bins used for compliance with California chassis-certified MDV standards with the exception of elimination of any bins higher than Bin 170. The highest bin was also changed from Bin 160 to Bin 170 to better align with the California ACC II program and to serve as a cap on MDV emissions.



**Table 3-3: Light-duty vehicle and MDV NMOG+NO<sub>x</sub> bin structure.**

| Bin       | NMOG+NO <sub>x</sub> (mg/mi) |
|-----------|------------------------------|
| Bin 170*  | 170                          |
| Bin 150*  | 150                          |
| Bin 125*  | 125                          |
| Bin 100*  | 100                          |
| Bin 85*   | 85                           |
| Bin 75*   | 75                           |
| Bin 70    | 70                           |
| Bin 65    | 65                           |
| Bin 60    | 60                           |
| Bin 55    | 55                           |
| Bin 50    | 50                           |
| Bin 45    | 45                           |
| Bin 40    | 40                           |
| Bin 35    | 35                           |
| Bin 30    | 30                           |
| Bin 25    | 25                           |
| Bin 20    | 20                           |
| Bin 15    | 15                           |
| Bin 10    | 10                           |
| Bin 5     | 5                            |
| Bin 0     | 0                            |
| *MDV only |                              |

**3.2.1.2 Light-Duty NMOG+NO<sub>x</sub> Standards and Test Cycles**

The finalized NMOG+NO<sub>x</sub> fleet average standards for MY 2027 and later light-duty vehicles are shown in Table 3-4. The same bin-specific numerical standard must be met across four test cycles: 25°C FTP, HFET, US06, and SC03. Vehicles that are not part of the phase-in percentages described in Section III.D.1 of the preamble are considered interim vehicles, which must continue to demonstrate compliance with all Tier 3 regulations with the exception that all vehicles (interim and those that are part of the phase-in percentages) contribute to the Tier 4 light-duty vehicle NMOG+NO<sub>x</sub> declining fleet average described shown in Table 3-4.

**Table 3-4: LDV, LDT and MDPV NMOG+NO<sub>x</sub> standards for 25°C FTP, US06, HFET and SC03.**

| Model Year                                | LDV, LDT1-2 (GVWR ≤ 6000 lb)<br>NMOG+NO <sub>x</sub> (mg/mi) | LDT3-4 (GVWR 6001-8500 lb) and MDPV<br>NMOG+NO <sub>x</sub> (mg/mi) |       |
|---|--|---|-------|
|   |  | default   | early |
| 2026*                                     | 30*  | 30*   | 30*   |
| 2027                                      | 25   | 30*   | 25    |
| 2028                                      | 23   | 30*   | 23    |
| 2029                                      | 21   | 30*   | 21    |
| 2030                                      | 19   | 15  | 19    |
| 2031                                      | 17   | 15  | 17    |
| 2032 and later                            | 15   | 15  | 15    |
| * Tier 3 standards provided for reference |  |   |       |

### 3.2.1.3 NMOG+NO<sub>x</sub> Standards for MDV

The final MDV NMOG+NO<sub>x</sub> standards are shown in Table 3-5 for optional early compliance and in Table 3-6 for default compliance. The CAA requires 4 years of lead time and 3 years of standards stability for heavy-duty vehicles, and MDV fall under the CAA definition for heavy-duty vehicles. Under default compliance, MDVs will continue to meet Tier 3 standards through the end of MY 2031 and then MDVs will proceed to meeting a 75 mg/mi NMOG+NO<sub>x</sub> standard in a single step in MY 2031 (Table 3-6) in order to comply with CAA provisions for regarding standards stability. Under default compliance, MDV may not carry forward Tier 3 NMOG+NO<sub>x</sub> credits into the Tier 4 program. The optional early compliance path has declining NMOG+NO<sub>x</sub> standards that gradually phase-in from MY 2027 through MY 2033. MDV manufacturers opting for early compliance may carry forward Tier 3 NMOG+NO<sub>x</sub> credits into the Tier 4 program when Tier 3 is closed out, up to the end of the Tier 3 five-year credit lifeTable 3-5.

Note that the phase-in percentages from Section III.D.1.i of the preamble also apply. MDV that are not part of the phase-in percentages summarized in Section III.D.1.ii of the preamble and are considered interim vehicles, which must continue to demonstrate compliance with all Tier 3 standards and regulations with the exception that all vehicles (interim and those that are part of the phase-in percentages) contribute to the Tier 4 MDV NMOG+NO<sub>x</sub> declining fleet average.

Certification data show that for MY 2022-2023, 75 percent of sales-weighted Class 2b and 3 gasoline vehicle certifications were below 120 mg/mi in FTP and US06 tests. Diesel-powered MDVs designed for high towing capability (i.e., GCWR above 22,000 pounds) had higher emissions, however 75 percent were still below 180 mg/mi NMOG+NO<sub>x</sub>. The year-over-year fleet average FTP standards for MDV and the rationale for the manufacturer's choice of early compliance and default compliance pathways is described in Section III.D.1 of the preamble. For further discussion of MDV NMOG+NO<sub>x</sub> feasibility, please refer to Chapter 3.2 of the RIA.

The final MDV NMOG+NO<sub>x</sub> standards are based on applying existing light-duty vehicle technologies, including electrification, to MDV. As with the light-duty vehicle categories, EPA anticipates that there will be multiple compliance pathways, such as increased electrification of vans together with achieving 120 mg/mile NMOG+NO<sub>x</sub> for ICE-powered MDV. Present-day MDV engine and aftertreatment technology allows fast catalyst light-off after cold-start followed by closed-loop A/F control and excellent exhaust catalyst emission control on MDV, even at the adjusted loaded vehicle weight, ALVW [(curb + GVWR)/2] test weight, which is higher than loaded vehicle weight, LVW (curb + 300 pounds) used for testing light-duty vehicles. Diesel MDV are adopting more advanced SCR systems for NO<sub>x</sub> emissions control that incorporate dual-injection systems for urea-based reductant similar to SCR systems that have been developed to meet more stringent NO<sub>x</sub> standards for MY 2024 and later heavy-duty engine standards in California and federal MY 2027 and later heavy-duty engine standards. The final MDV standards begin to take effect after 2031. While the originally proposed date of 2030 for default compliance was fully consistent with the CAA section 202(a)(3)(C) lead time requirement for these vehicles, EPA delayed implementation in the final rule to provide additional lead time based in part on comments received from auto manufacturers expressing concerns that additional lead time was important for compliance. Similarly, the early compliance pathway was delayed by one year relative to our proposal.

**Table 3-5: MDV fleet average NMOG+NO<sub>x</sub> standards under the early compliance pathway†.**

| Model Year  | NMOG+NO <sub>x</sub> (mg/mi) |         |
|---|------------------------------|---------|
|   | Class 2b                     | Class 3 |
| 2026  | 178*                         | 247*    |
| 2027  | 175                          |         |
| 2028  | 160                          |         |
| 2029  | 140                          |         |
| 2030  | 120                          |         |
| 2031**  | 100                          |         |
| 2032**  | 80                           |         |
| 2033 and Later**  | 75                           |         |
| † Please refer to section III.D.1 for further discussion of the early compliance and default compliance pathways<br>* Tier 3 FTP fleet average standards provided for reference<br>** MDV with a GCWR greater than 22,000 pounds must also comply with additional moving average window (MAW) in-use testing requirements |                              |         |

**Table 3-6: MDV fleet average chassis dynamometer FTP NMOG+NO<sub>x</sub> standards under the default compliance pathway\*.**

| Model Year  | MDV NMOG+NO <sub>x</sub> (mg/mi) |         |
|---|----------------------------------|---------|
|   | Class 2b                         | Class 3 |
| 2026  | 178*                             | 247*    |
| 2027  | 178*                             | 247*    |
| 2028  | 178*                             | 247*    |
| 2029  | 178*                             | 247*    |
| 2030  | 178*                             | 247*    |
| 2031**  | 75†                              |         |
| 2032**  | 75†                              |         |
| 2033 and later  | 75†                              |         |
| † Please refer to section III.D.1 for further discussion of the early compliance and default compliance pathways<br>* Tier 3 FTP fleet average standards provided for reference<br>** MDV with a GCWR greater than 22,000 pounds must also comply with additional moving average window (MAW) in-use testing requirements |                                  |         |

If a manufacturer has a fleet mix with relatively high sales of MDV BEV, that would ease compliance with MDV NMOG+NO<sub>x</sub> fleet average standards for MDV ICE-powered vehicles. An option also remains for manufacturers of high GCWR MDV to choose engine-certification as a light-heavy-duty engine as an additional compliance flexibility. This would allow some manufacturers to choose the option of moving vehicles with the highest towing capability out of the fleet-average chassis-certified standards and into the heavy-duty engine program. If a manufacturer has a fleet mix with relatively low BEV sales, then improvements in NMOG+NO<sub>x</sub> emissions control for ICE-powered vehicles would be required to meet the fleet average standards and/or more capable high GCWR MDV could be moved into the heavy-duty engine program. Improvements to NMOG+NO<sub>x</sub> emissions from ICE-powered vehicles are feasible with available engine, aftertreatment, and sensor technology, and has been shown within an analysis of MY 2022-2023 MDV certification data (see RIA Chapter 3.2). Fleet average NMOG+NO<sub>x</sub>

will continue to decline to well below the final Tier 3 NMOG+NO<sub>x</sub> standards of 178 mg/mi and 247 mg/mi for Class 2b and 3 vehicles, respectively.

The final standards require the same MDV numerical standards be met across all four test cycles, the 25°C FTP, HFET, US06, and SC03, consistent with the approach for light-duty vehicles described in Section III.D.2.iii of the preamble. This would mean that a manufacturer certifying a vehicle to bin 75 would be required to meet the bin 75 emissions standards for all four cycles.

Meeting the same NMOG+NO<sub>x</sub> standard across four cycles is an increase in stringency from Tier 3, which had one standard over the FTP and less stringent bin standards for the HD-SFTP (weighted average of  $0.35 \times \text{FTP} + 0.28 \times \text{HDSIM} + 0.37 \times \text{SC03}$ , where HDSIM is the driving schedule specified in 40 CFR 86.1816-18(b)(1)(ii)). Previous MDV control technologies allow closed-loop A/F control and high exhaust catalyst emissions conversion throughout the US06 and SC03 cycles, so compliance with higher numerical emissions standards over these cycles is no longer needed. Manufacturer submitted certification data and EPA testing show that Tier 3 MDV typically have similar NMOG+NO<sub>x</sub> emissions in US06 and 25°C FTP cycles, and NMOG+NO<sub>x</sub> from the HFET and SC03 are typically much lower. Testing of a 2022 F250 7.3L at EPA showed average NMOG+NO<sub>x</sub> emissions of 56 mg/mi in the 25°C FTP and 48 mg/mi in the US06. Manufacturer-submitted certifications show that MY 2021+2022 gasoline Class 2b trucks achieved, on average, 69 mg/mi in the FTP, 75 mg/mi in the US06, and 18 mg/mi in the SC03. MY 2021+2022 gasoline Class 3 trucks achieved, on average, 87 mg/mi in the FTP and 25 mg/mi in the SC03.

Several Tier 3 provisions will end with the elimination of the HD-SFTP and the combining of bins for Class 2b and Class 3 vehicles. First, Class 2b vehicles with power-to-weight ratios at or below 0.024 hp/pound may no longer replace the full US06 component of the SFTP with the second of three sampling bags from the US06. Second, Class 3 vehicles may no longer use the LA-92 cycle in the HD-SFTP calculation but will instead have to meet the NMOG+NO<sub>x</sub> standard in each of four test cycles (25°C FTP, HFET, US06, and SC03). Third, the SC03 may no longer be replaced with the FTP in the SFTP calculation.

The final standards do not include relief provisions for MDV 25°C FTP NMOG+NO<sub>x</sub> certification at high altitude conditions (1520-1720 m), as is being finalized for light-duty vehicles. Modern engine systems can use idle speed, engine spark timing, valve timing, and other controls to offset the effect of lower air density on catalyst light-off at high altitudes.

EPA is also setting a new -7°C FTP NMOG+NO<sub>x</sub> fleet average standard of 300 mg/mi for gasoline and diesel MDV. EPA testing has demonstrated the feasibility of a single fleet average -7°C FTP NMOG+NO<sub>x</sub> standard of 300 mg/mi across light-duty vehicles and MDV. EPA did not include EVs in the assessment of the fleet average standard and therefore EVs and other zero emission vehicles are not included and not averaged into the fleet average -7°C FTP NMOG+NO<sub>x</sub> standards.

Since -7°C FTP and 25°C FTP are both cold soak tests that include TWC operation during light-off and at operating temperature, it is appropriate to apply the same Tier 3 useful life to both standards. Additional discussion on the feasibility of the standards can be found in Chapter 3.2.5.

### 3.2.2 PM Standard for Light-Duty and Medium-Duty Vehicles

The final PM standard is presented in Section III.D.3 of the preamble. GPF technology, GPF benefits and feasibility of the standard, importance of test cycles, a GPF cost, and GPF impact on CO<sub>2</sub> emissions are discussed in RIA Chapter 3.2.6.

For reference, the final light-duty PM standard is shown in Table 3-7 and the final MDV PM standard is shown in Table 3-8.

**Table 3-7: Light-duty PM standard.**

| Test Cycle | Tier 3 Standard (mg/mi) | Final PM Standard (mg/mi) |
|------------|-------------------------|---------------------------|
| 25°C FTP   | 3                       | 0.5                       |
| US06       | 6                       | 0.5                       |
| -7°C FTP   | Not applicable          | 0.5                       |

**Table 3-8: MDV PM standard.**

| Test Cycle | Tier 3 Standard (mg/mi)                          | Final PM Standard (mg/mi) |
|------------|--|---------------------------|
| 25°C FTP   | 8 (Class 2b)<br>10 (Class 3)                     | 0.5                       |
| US06       | 10 over SFTP (Class 2b)<br>7 over SFTP (Class 3) | 0.5                       |
| -7°C FTP   | Not applicable                                   | 0.5                       |

### 3.2.3 CO and Formaldehyde (HCHO) Standards

The final CO and formaldehyde (HCHO) standards are described in detail within Section III.D.4 of the preamble. For reference, the light-duty vehicle standards are shown in Table 3-9 and the MDV standards are shown in Table 3-10.

**Table 3-9: Light-duty CO and HCHO standards.**

|  |      |
|--|------|
| CO cap for 25°C FTP, HFET, SC03 (g/mi) | 1.7  |
| CP cap for US06 (g/mi)                 | 9.6  |
| CO cap for -7°C FTP (g/mi)             | 10.0 |
| HCHO cap for 25°C FTP (g/mi)           | 4    |

**Table 3-10: MDV CO and HCHO standards.**

|  |      |
|--|------|
| CO cap for 25°C FTP, HFET, SC03 (g/mi) | 3.2  |
| CP cap for US06 (g/mi)                 | 25   |
| CO cap for -7°C FTP (g/mi)             | 10.0 |
| HCHO cap for 25°C FTP (g/mi)           | 6    |

CO standards for the 25°C FTP, SC03, and US06 are harmonized with those of the California LEV IV program for light-duty vehicles, and with California Class 2b standards for all MDV.

There is currently significant overcompliance within the Tier 3 program for CO over the FTP. CO emissions over the 25 °C FTP are very low due to the need to maintain low cold-start and running NMOG emissions in order to meet FTP NMOG+NO<sub>x</sub> standards. The SC03 is a hot running cycle with moderate load, and thus has comparable or lower CO emissions compared to

the 25°C FTP. The US06 has higher CO emissions, but only has a 27% weighting under the Tier 3 composite SFTP standards. An analysis of 2024 certification data shows significant overcompliance with Tier 3 FTP CO standards even when averaging across all bin levels (see Table 3-11).

**Table 3-11: Average<sup>†</sup> FTP, SC03, US06 and composite SFTP CO emissions for MY 2024 test groups certified to Tier 3 that overlap with Tier 4 Standard Bins**

| Class    | Cert. Bin | FTP CO Cert. Level (g/mi) | $\sigma(n-1)$ | Tier 3 FTP CO Standard (g/mi) | SC03 CO Cert. Level (g/mi) | $\sigma(n-1)$ | US06 CO Cert. Level (g/mi) | $\sigma(n-1)$ | SFTP CO Cert. Level (g/mi) | $\sigma(n-1)$ | Tier 3 SFTP CO Standard (g/mi) |
|----------|-----------|---------------------------|---------------|-------------------------------|----------------------------|---------------|----------------------------|---------------|----------------------------|---------------|--------------------------------|
| LD       | 30        | 0.27                      | 0.21          | 1.0                           | 0.41                       | 0.31          | 0.96                       | 1.3           | 0.52                       | 0.56          | 4.2                            |
| LD       | 50        | 0.51                      | 0.30          | 1.7                           | 0.55                       | 0.41          | 1.1                        | 2.0           | 0.69                       | 0.80          | 4.2                            |
| LD       | 70        | 0.47                      | 0.29          | 1.7                           | 0.43                       | 0.30          | 1.0                        | 1.1           | 0.61                       | 0.51          | 4.2                            |
| Class 2b | 170       | 0.70                      | 0.08          | 4.2                           | 0.78                       | 0.59          | 1.7                        | 2.1           | 0.99                       | 0.82          | 12                             |

\* Average and standard deviation [ $\sigma(n-1)$ ] at each bin level for all MY2024 spark-ignition test groups for which Tier 3 Bins overlap with Tier 4 bins. Note that no MY 2024 data was found within current certification data for LD Tier 3 Bin 20 and insufficient data was found for SFTP calculation for Class 2b Bin 150.

Assuming certification levels of 0.5 g/mi over the FTP and SC03 would allow compliance with the 4.2 g/mi CO composite LD SFTP standard of 4.2 g/mi with US06 CO emissions results as high as 13.7 g/mi. Similarly, assuming FTP and SC03 CO certification levels of 0.8 for MDV would allow compliance with the 12 g/mi CO composite Class 2b SFTP standard of 12 g/mi with US06 CO emissions results as high as 40 g/mi.

The LEV IV program caps US06 emissions at approximately what would be allowable under the Tier 3 composite SFTP standard if FTP and SC03 are near the FTP standard for CO (Table 3-12). When also considering the NMOG levels needed to comply with NMOG+NO<sub>x</sub> standards, this serves to cap back sliding on the US06 that might occur under an SFTP composite standard.

**Table 3-12: Comparison of LEV IV CO standards calculated as a composite SFTP to the Tier 3 SFTP composite CO Standards**

| Vehicle Category | Bin                       | LEV IV Standards |                 |                | SFTP (Composite calculated from LEV IV standards) | T3 SFTP Standards |
|------------------|---------------------------|------------------|-----------------|----------------|---|-------------------|
|                  |                           | FTP CO (g/mi)    | SC03 CO* (g/mi) | US06 CO (g/mi) |   |                   |
| LD               | 0-30                      | 1                | 1               | 9.6            | 3.408   | 4.2               |
| LD               | 35-70                     | 1.7              | 1.7             | 9.6            | 3.912   | 4.2               |
| 2B               | 75-150                    | 3.2              | 3.2             | 25             | 9.304   | 12                |
| 2B               | 170                       | 4.2              | 4.2             | 25             | 10.024  | 12                |
|                  | SFTP Composite Weighting: | 0.35             | 0.37            | 0.28           |   |                   |

\* LEV IV does not set SC03 standards for MDV. For purposes of comparison to Tier 3, SC03 was set to the FTP CO standard, which is consistent with the LEV IV CO standards for LD.

### **3.2.4 In-use Standards for High GCWR Medium-Duty Vehicles.**

The Agency proposed requiring high GCWR MDVs, defined as MDV with a gross combined weight rating (GCWR) above 22,000 pounds, to be subject to heavy-duty engine certification instead of chassis-certification for criteria air pollutant standards. Within the proposed rule, the Agency asked for comment on three alternatives to engine certification of high GCWR MDV:

1. MDV above 22,000 pounds GCWR would comply with the MDV chassis dynamometer standards with the introduction of additional engine-dynamometer-based standards over the Supplemental Emissions Test as finalized within the Heavy-duty 2027 and later standards;
2. MDV above 22,000 pounds GCWR would comply with the MDV chassis dynamometer standards with additional in-use testing and standards comparable to those used within the California ACC II;
3. Introduction of other test procedures for demonstration of effective criteria pollutant emissions control under the sustained high-load conditions encountered during operation above 22,000 pounds GCWR.

The Agency is adopting Alternative 2 for the final rule. Alternative 2 includes PEMS-based moving-average-window in-use standards that are harmonized with California in-use standards for chassis-certified MDV. The Agency is not finalizing mandatory engine certification for compliance with criteria pollutant emissions standards for high GCWR MDV; however, there is still an option that allows manufacturers to choose compliance with light-heavy-duty engine standards for high GCWR MDV in lieu of compliance with MDV test procedures and standards. For further information, please see Section III.D.5 of the preamble.

#### **3.2.4.1 Background on California ACC II/LEV IV Medium-Duty Vehicle In-use Standards**

As part of ACC II and LEV IV programs, California established in-use testing requirements for chassis-certified LEV IV MDV with a GCWR greater than 14,000 pounds using PEMS-based moving average window (MAW) in-use standards. California's in-use test procedures and standards for chassis-certified MDV are based upon California's MAW in-use test procedures and standards for heavy-duty engines. Under California's program, chassis-certified diesel MDV with a GCWR greater than 14,000 pounds meet NO<sub>x</sub>, NMHC, CO, and PM in-use emissions standards over a three-bin MAW (3B-MAW) with bins representing idle operation (less than or equal to 6 percent engine load), low-load operation (above 6 percent engine load and less than or equal to 20 percent engine load) and medium-high operation (above 20 percent engine load) at up to GCWR. Chassis-certified gasoline MDV with a GCWR greater than 14,000 pounds attest to meeting NO<sub>x</sub>, NMHC, CO, and PM in-use emissions standards over a single MAW (1B-MAW) at up to GCWR (California Environmental Protection Agency, Air Resources Board 2022). Note that under these provisions, chassis certified MDV with a GCWR greater than 14,000 pounds are required to meet g/bhp-hr MAW standards instead of g/mi MAW standards and use a FTP CO<sub>2</sub> family certification level (FCL) calculated either from chassis dynamometer test results or engine dynamometer test results. The chassis dynamometer FCL definition uses OBD torque data collection together with CO<sub>2</sub> emissions measurement during chassis-dynamometer testing. The California MDV in-use standards also include a conformity factor

(CF) for in-use compliance that is multiplied by each emissions standard. The CF is set to 2.0 for MYs 2027 through 2029. The CF is set to 1.5 for MY 2030 and subsequent model year vehicles.

#### **3.2.4.2 Background on Federal MAW Standards and Procedures for Light-Heavy-duty Engines and California Harmonization with Federal Standards**

In January 2023, the Agency finalized MAW in-use test procedures and NO<sub>x</sub>, PM, HC and CO in-use standards for heavy-duty diesel engines based upon a two-bin moving average window (2B-MAW) instead of California's 3B-MAW. The Federal 2B-MAW standards also applied a separate temperature correction to light-heavy-duty diesel engine (LHDDE) NO<sub>x</sub> standards than the temperature correction used for medium- and heavy-heavy-duty diesel engines. The Agency established 1B-MAW test procedures for gasoline heavy-duty engines comparable to the California procedures, however the Agency did not establish 1B-MAW standards for heavy-duty gasoline engines.

The Federal 2B-MAW procedures for diesel engines are based upon two 300-second moving average window (MAW) operational bins. Bin 1 represents extended idle operation and other very low ( $\leq 6$  percent) load operation where exhaust temperatures may drop below the optimal temperature for aftertreatment function. Bin 2 represents higher load operation ( $>6$  percent). The California 3B-MAW procedures differ chiefly by dividing Bin 2 into Bin 2 and Bin 3, with Bin 2 representing operation from 6 percent to 20 percent load and Bin 3 having operation at greater than 20 percent load.

Within the Federal in-use procedures, CO<sub>2</sub> emissions rates normalized to the maximum CO<sub>2</sub> rate of the engine are used as a surrogate for engine power within the bin definitions. The maximum CO<sub>2</sub> rate is defined as the engine's rated maximum power multiplied by the engine's CO<sub>2</sub> family certification level (FCL) for the FTP certification cycle.

In June 2023, a final agreement was signed by representatives of the California Air Resources Board (CARB), the Truck and Engine Manufacturers Association, Cummins, Daimler Truck, General Motors, Hino, Isuzu, Navistar, PACCAR, Stellantis, and Volvo. As part of this agreement, CARB proposed adopting the Federal 2B-MAW test procedures and standards from 40 CFR part 1036 for diesel heavy-duty engines with no changes to California's 1B-MAW standards and procedures for gasoline heavy-duty engines. It is not yet clear when California harmonization with the Federal 2B-MAW will be finalized by CARB.

California has previously maintained consistent MAW standards and procedures between their in-use medium-duty chassis-certified Tier IV program and their medium-duty engine-certified program, however it is also unclear when chassis-certified MDV will be moved to 2B-MAW procedures and standards within California's program.

#### **3.2.4.3 In-Use Testing Requirements for Chassis-Certified High GCWR Medium-Duty Vehicles Using the Moving Average Window (MAW).**

The agency is finalizing criteria pollutant standards based on chassis-certification along with additional in-use standards for high GCWR MDV. We are also finalizing optional engine-certification for high GCWR MDV, however we are not finalizing a requirement for engine-certification for these vehicles. See Section III.D.5.iv of the preamble for further description of the option to certify engines under 40 CFR part 1036. The rest of this section describes the in-use



standards and procedures for high-GCWR MDVs certified to criteria pollutant emission standards under 40 CFR part 86, subpart S.

The agency is finalizing in-use standards for MY 2031 and later high GCWR MDVs consistent with the California provisions for certification and in-use standards for chassis-certified MDV based on moving average windows (i.e., Alternative 2 in the proposal). Consistent with the proposal, note that this differs from the California program with respect to applicability. The Federal in-use standards only apply for MDV with a GCWR greater than 22,000 pounds whereas the California program applies for vehicles above 14,000 pounds GCWR.

Manufacturers of high GCWR diesel MDV may choose between compliance with CARB's adopted 3B-MAW standards or EPA's adopted 2B-MAW standards.

The final in-use test procedures and standards for high GCWR MDV are based upon Federal heavy-duty in-use test procedures and standards for light-heavy-duty engines with some modifications that include:

1. Optionally allow FCL to be derived entirely from chassis dynamometer testing, emissions measurement, and OBD data collection.
2. Addition of an option for 3B-MAW standards and procedures for high GCWR diesel MDV. Note that the 3B-MAW standards specified in this final rule incorporate California's full-phase-in conformity factor of 1.5.
3. Addition of 1B-MAW standards for high GCWR spark-ignition MDV.

The high GCWR gasoline MDV standards are summarized in Table 3-13. High GCWR diesel 3B-MAW standards and off-cycle bin definitions are summarized in Table 3-14 and Table 3-15. High GCWR diesel 2B-MAW standards and off-cycle bin definitions are summarized in Table 3-16 and Table 3-17. Note that the 2B-MAW standards also include a PEMS accuracy margins, which are summarized in Table 3-18. The 2B-MAW and 3B-MAW NO<sub>x</sub> standards, including any applicable accuracy margins and temperature corrections, are compared in Figure 3-15 and Figure 3-16. For further details regarding the finalized high GCWR MDV in-use standards, please refer to 40 CFR 86.1811-27(e). For further details regarding the finalized high GCWR MDV in-use test procedures, please refer to 40 CFR 86.1845-04(h).

**Table 3-13: Spark-Ignition Standards for Off-Cycle Testing of High GCWR MDV.**

| NO <sub>x</sub><br>mg/hp·hr   | HC<br>mg/hp·hr | PM<br>mg/hp·hr | CO<br>g/hp·hr |
|---|----------------|----------------|---------------|
| 30  | 210            | 7.5            | 21.6          |
| a Standards already include a conformity factor of 1.5 and Accuracy Margins do not apply.<br>b There is no applicable temperature condition, $\bar{T}_{amb}$ , for spark-ignition vehicles certifying to moving average window standards.<br>c In-use standards for spark-ignition vehicles are not divided into separate operation bins. |                |                |               |

**Table 3-14: Compression-Ignition Standards for Off-Cycle Testing of High GCWR MDV Over the 3B-MAW Procedures.**

| Off-cycle Bin <sup>a,b,c</sup> | NO <sub>X</sub> | HC mg/hp·hr | PM mg/hp·hr | CO g/hp·hr |
|--------------------------------|-----------------|-------------|-------------|------------|
| Bin 1                          | 7.5 g/hr        |             |             |            |
| Bin 2                          | 75 mg/hp·hr     | 21          | 7.5         | 23.25      |
| Bin 3                          | 30 mg/hp·hr     | 21          | 7.5         | 23.25      |

a Vehicles optionally certifying to 3-bin moving average window standards.  
b Standards already include a conformity factor of 1.5 and Accuracy Margins do not apply.  
c There is no applicable temperature condition,  $\bar{T}_{amb}$ , for vehicles certifying to 3-bin moving average window standards.

**Table 3-15: Criteria for 3B-MAW Off-Cycle Bins.**

| Bin   | Normalized CO <sub>2</sub> emission mass over the 300 second test interval |
|-------|--|
| Bin 1 | $mCO_{2,norm,testinterval} \leq 6.00\%$ .                                  |
| Bin 2 | $6.00\% < mCO_{2,norm,testinterval} \leq 20.00\%$                          |
| Bin 3 | $mCO_{2,norm,testinterval} > 20.00\%$ .                                    |

**Table 3-16: Compression-Ignition Standards for Off-Cycle Testing Over the 2B-MAW.**

| Off-cycle Bin <sup>a</sup> | NO <sub>X</sub> <sup>b</sup> | Temperature adjustment <sup>c</sup> | HC mg/hp·hr | PM mg/hp·hr | CO g/hp·hr |
|----------------------------|------------------------------|-------------------------------------|-------------|-------------|------------|
| Bin 1                      | 10.0 g/hr                    | $(25.0 - \bar{T}_{amb}) \cdot 0.25$ |             |             |            |
| Bin 2                      | 58 mg/hp·hr                  | $(25.0 - \bar{T}_{amb}) \cdot 2.2$  | 120         | 7.5         | 9          |

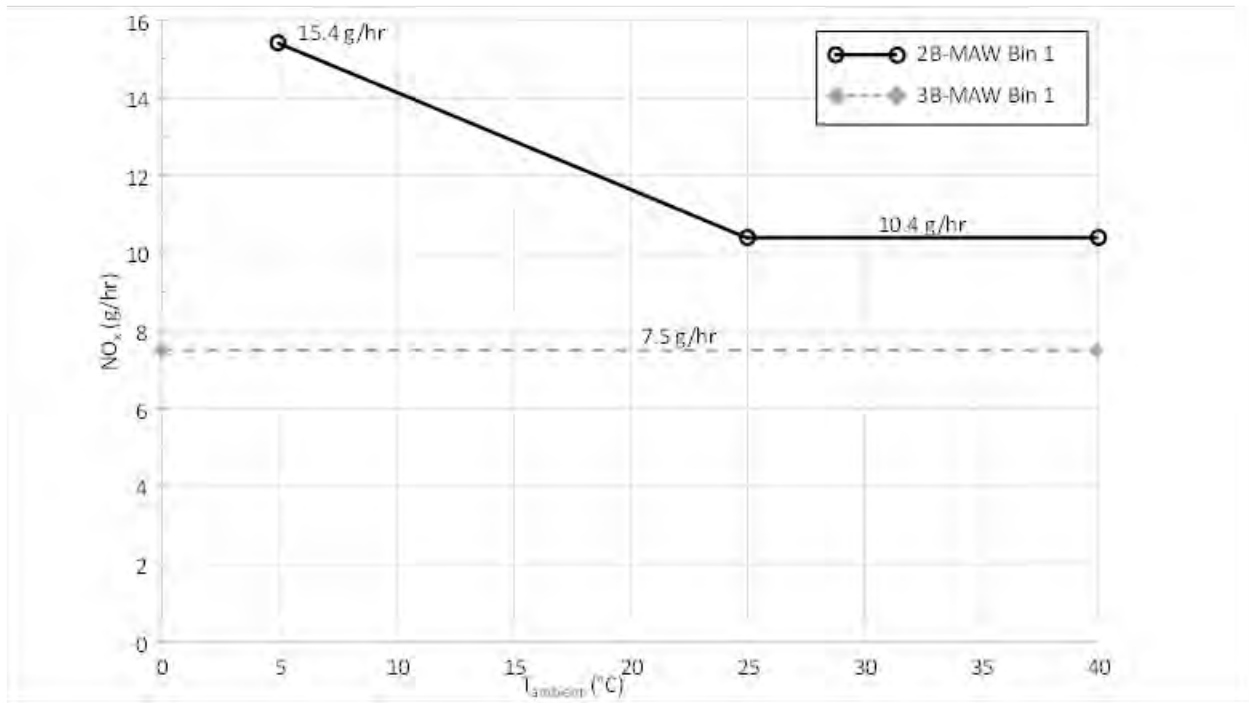
a Vehicles and engines certifying to 2-bin moving average window standards.  
b Use Accuracy Margins from 40 CFR 1036.420 (a).  
c  $\bar{T}_{amb}$  is the mean ambient temperature over a shift-day, or equivalent. Adjust the off-cycle NO<sub>X</sub> standard for  $\bar{T}_{amb}$  below 25.0 °C by adding the calculated temperature adjustment to the specified NO<sub>X</sub> standard. Round the temperature adjustment to the same precision as the NO<sub>X</sub> standard for the appropriate bin. If you declare a NO<sub>X</sub> FEL for the engine family, do not apply the FEL scaling calculation from 40 CFR 1036.104(c)(3) to the calculated temperature adjustment.

**Table 3-17: Criteria for 2B-MAW Off-Cycle Bins.**

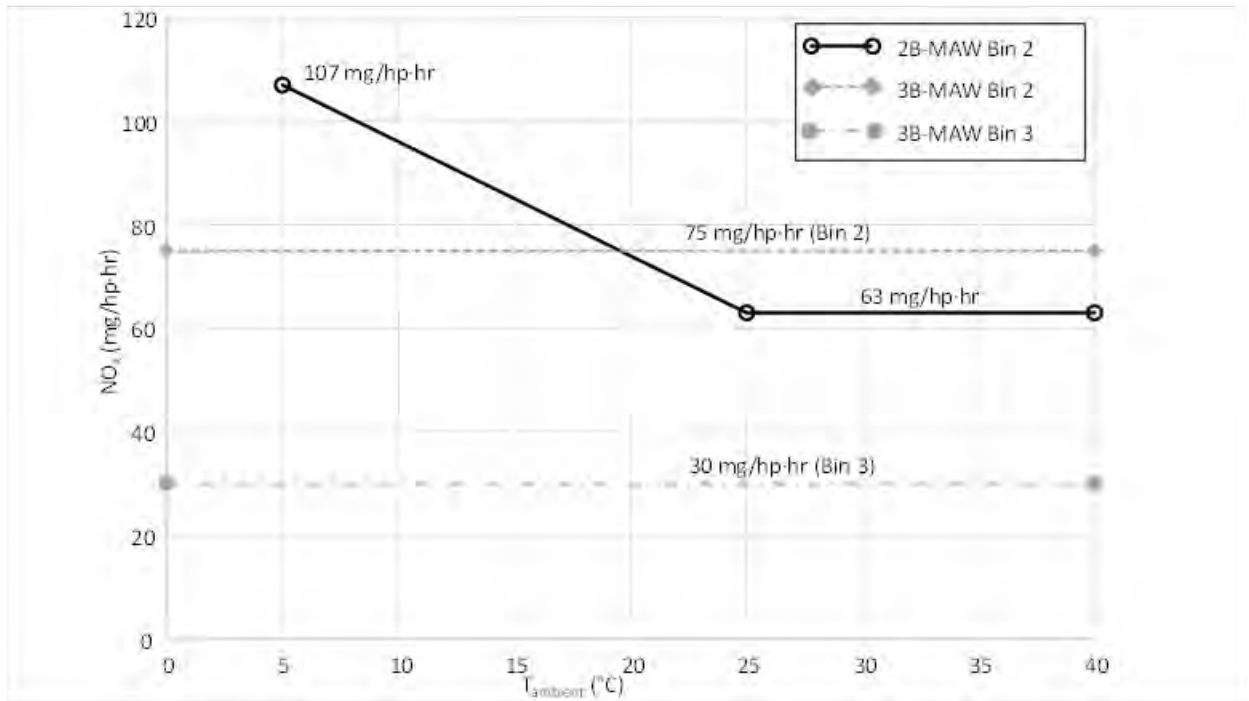
| Bin   | Normalized CO <sub>2</sub> emission mass over the 300 second test interval |
|-------|--|
| Bin 1 | $mCO_{2,norm,testinterval} \leq 6.00\%$ .                                  |
| Bin 2 | $mCO_{2,norm,testinterval} > 6.00\%$ .                                     |

**Table 3-18: Accuracy Margins for In-Use Testing Over the 2B-MAW.**

|       | NO <sub>X</sub> | HC          | PM         | CO             |
|-------|-----------------|-------------|------------|----------------|
| Bin 1 | 0.4 g/hr        |             |            |                |
| Bin 2 | 5 mg/hp·hr      | 10 mg/hp·hr | 6 mg/hp·hr | 0.025 g/hp·hr. |



**Figure 3-15: 2B-MAW Bin 1 In-use NO<sub>x</sub> standard with Ambient Temperature Correction and PEMS Accuracy Margin compared to 3B-MAW Bin 1 In-use NO<sub>x</sub> standard.**



**Figure 3-16: Figure 8: 2B-MAW Bin 2 In-use NO<sub>x</sub> standard with Ambient Temperature Correction and PEMS Accuracy Margin Compared to 3B-MAW Bin 2 and Bin 3 In-use NO<sub>x</sub> standard.**

#### **3.2.4.4 Optional High GCWR Medium-Duty Vehicles Engine Certification**

The final rule includes the option for engine-based certification to emission standards for both spark ignition and compression ignition (diesel) engines, and complete and incomplete vehicles that have GCWR above 22,000 pounds. Engine certification would require compliance with all the same engine certification criteria pollutant requirements and standards as for MY 2027 and later engines installed in Class 4 and higher heavy-duty vehicles, including the recently adopted NO<sub>x</sub>, HC, PM, and CO standards, useful life, warranty and in-use requirements. 88 FR 4296 (Jan. 24, 2023). Complete MDVs would still require chassis dynamometer testing for demonstrating compliance with GHG standards as described in Section III.C.3 of the preamble and are included within the fleet average MDV GHG emissions standards along with the other MDVs. Manufacturers would have the option to certify incomplete MDVs to GHG standards under 40 CFR 86.1819, or under 40 CFR parts 1036 and 1037. Note that existing regulations, see 40 CFR 1037.150(l), allow a comparable dual-testing methodology, which utilizes engine dynamometer certification for demonstration of compliance with criteria pollutant emissions standards while maintaining chassis dynamometer certification for demonstration of compliance with GHG emissions standards under 40 CFR 86.1819.

#### **3.2.5 Feasibility of ICE-Based Vehicle NMOG+NO<sub>x</sub> Standards**

The current light-duty vehicle Tier 3 standards will be fully phased-in by MY 2025 and will result in a fleet average standard for passenger cars and light trucks of 30 mg/mi FTP NMOG+NO<sub>x</sub>. This means on average, the light-duty fleet will be certified to Tier 3 Bin 30 in MY 2025. As discussed in Section III.D.2.iii of the preamble, the declining FTP NMOG+NO<sub>x</sub>

fleet average in this proposal is fully feasible with the introduction of zero emission vehicles such as BEVs. There are many pathways to NMOG+NO<sub>x</sub> compliance with lower levels of BEV penetration that would require some level of ICE aftertreatment improvement (examples provided in Chapter 3.2.5.1 below). Even with BEV penetrations as low as 35 percent (e.g., as projected in our No Additional BEVs sensitivity) and considering many existing ICE vehicles already emit below 30 mg/mile, manufacturers would comply with the NMOG+NO<sub>x</sub> standard with minimal aftertreatment improvements for their remaining ICE vehicles.

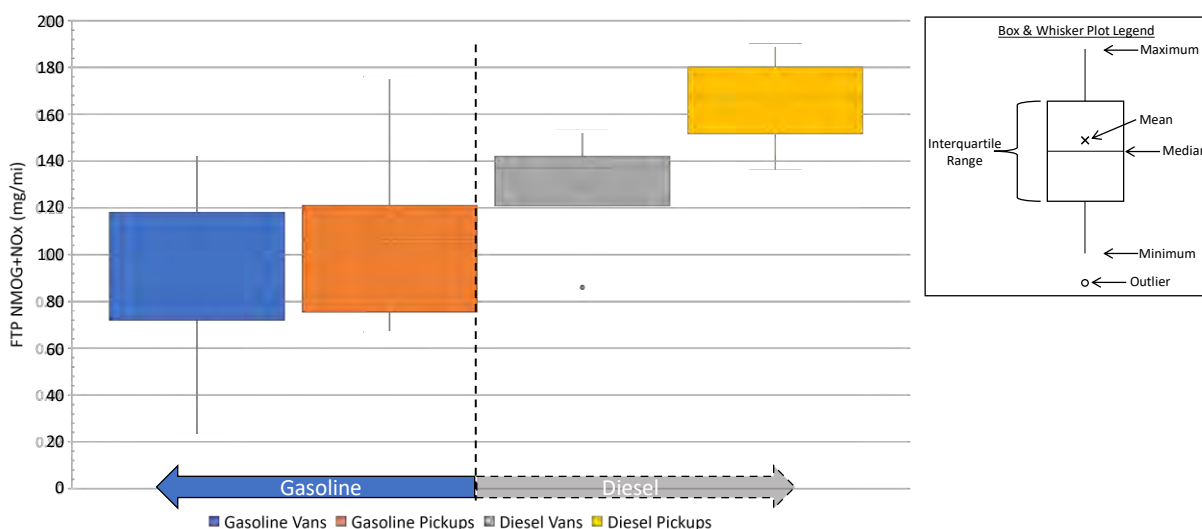
Continued reductions in ICE-based vehicle emissions can provide an alternative pathway to compliance (or, at a minimum, offset the number of BEVs a vehicle manufacturer might choose to produce) to meet the standards. Many ICE vehicles today already meet the MY 2032 NMOG+NO<sub>x</sub> standards over the FTP. EPA reviewed the MY 2023 Annual Certification Data for Vehicles (U.S. EPA 2023) and identified 39 vehicle models with ICE NMOG+NO<sub>x</sub> emissions performance on the FTP below 15 mg/mi, four of which are certified to 10 mg/mi or less (Table 3-19). Beyond the vehicles listed in Table 3-19, an additional 60 models are certified to between 15 mg/mi and 20 mg/mi.

**Table 3-19: Examples of NMOG+NO<sub>x</sub> MY 2023 certification emissions that are less than 15 mg/mi.**

| Manufacturer                                  | Model                   | Certified NMOG+NO <sub>x</sub> (g/mi) |
|---|-------------------------|---------------------------------------|
| <b>Vehicles Certified at 10 mg/mi or less</b> |                         |                                       |
| <b>Mercedes-Benz</b>                          | S 580 e 4MATIC          | 0.006                                 |
| <b>Hyundai</b>                                | Sonata Hybrid           | 0.010                                 |
| <b>Kia</b>                                    | Niro Hybrid             | 0.010                                 |
| <b>Kia</b>                                    | Niro PHEV               | 0.010                                 |
| <b>Vehicles Certified at 15 mg/mi or less</b> |                         |                                       |
| <b>BMW</b>                                    | X5 xDrive45e            | 0.011                                 |
| <b>FOMOCO</b>                                 | Escape PHEV             | 0.011                                 |
| <b>FOMOCO</b>                                 | Corsair AWD PHEV        | 0.011                                 |
| <b>Hyundai</b>                                | Sonata Hybrid           | 0.011                                 |
| <b>Kia</b>                                    | Niro Hybrid             | 0.011                                 |
| <b>Kia</b>                                    | Soul                    | 0.011                                 |
| <b>Kia</b>                                    | Forte 5                 | 0.011                                 |
| <b>Toyota</b>                                 | Prius Prime             | 0.011                                 |
| <b>BMW</b>                                    | X5 xDrive45e            | 0.012                                 |
| <b>FOMOCO</b>                                 | Escape                  | 0.012                                 |
| <b>FOMOCO</b>                                 | Escape AWD HEV          | 0.012                                 |
| <b>FOMOCO</b>                                 | Corsair AWD PHEV        | 0.012                                 |
| <b>Hyundai</b>                                | Kona                    | 0.012                                 |
| <b>Kia</b>                                    | Niro PHEV               | 0.012                                 |
| <b>Kia</b>                                    | Soul                    | 0.012                                 |
| <b>Mercedes-Benz</b>                          | GLC 300 4MATIC          | 0.012                                 |
| <b>Mercedes-Benz</b>                          | S 580 e 4MATIC          | 0.012                                 |
| <b>Toyota</b>                                 | Prius AWD XLE/LTD       | 0.012                                 |
| <b>Volkswagen</b>                             | Q3                      | 0.012                                 |
| <b>BMW</b>                                    | X3 xDrive30i            | 0.013                                 |
| <b>FOMOCO</b>                                 | Escape PHEV             | 0.013                                 |
| <b>Hyundai</b>                                | Santa Fe PHEV           | 0.013                                 |
| <b>Kia</b>                                    | Sportage PHEV           | 0.013                                 |
| <b>Kia</b>                                    | Sorento PHEV            | 0.013                                 |
| <b>Kia</b>                                    | Soul                    | 0.013                                 |
| <b>Kia</b>                                    | Forte 5                 | 0.013                                 |
| <b>Toyota</b>                                 | Corolla Cross AWD       | 0.013                                 |
| <b>Toyota</b>                                 | NX 350 AWD              | 0.013                                 |
| <b>Toyota</b>                                 | Corolla XSE             | 0.013                                 |
| <b>BMW</b>                                    | X5 xDrive45e            | 0.014                                 |
| <b>BMW</b>                                    | John Cooper Works Conv. | 0.014                                 |
| <b>GM</b>                                     | Malibu                  | 0.014                                 |
| <b>Hyundai</b>                                | Elantra                 | 0.014                                 |
| <b>Volkswagen</b>                             | Tiguan AWD              | 0.014                                 |
| <b>Volkswagen</b>                             | Taos                    | 0.014                                 |

The Agency also analyzed emissions certification data of MY 2022 and MY 2023 emissions families for medium-duty vehicles (MDVs). The emissions family certification data are graphically represented in Figure 3-17 for gasoline and diesel MDV vans and pickups using a "box-and-whisker" plot (Frigge, Hoaglin and Iglewicz 1989) (Tukey 1977) (Benjamini 1988). The upper and lower boxes correspond to the first and third quartiles (the 25th and 75th percentiles), respectively, of the NMOG+NO<sub>x</sub> emissions data for each MDV category. The horizontal line between each set of upper and lower boxes represents median emissions and the "x" represents mean emissions. The upper vertical line or "whisker" extends from the median to the highest value that is within 1.5X inner quartile range (IQR) of the median, where IQR is the distance between the first and third quartiles. The lower "whisker" extends from the median to the lowest value within 1.5X IQR of the median. A certification emissions data point was

considered an outlier if it exceeded a distance of 1.5 times the IQR below the 1st quartile or 1.5 times the IQR above the 3rd quartile and is represented as a “dot” in the “box-and-whisker” plot. The analysis found significant compliance headroom for MDVs below the current Tier 3 NMOG+NO<sub>x</sub> emissions standards for Class 2b and Class 3 MDVs<sup>27</sup>, with median NMOG+NO<sub>x</sub> emissions of approximately 100 mg/mi for gasoline pickups, approximately 80 mg/mi for gasoline vans, and approximately 130 mg/mi for diesel vans. Median emissions for diesel pickups were approximately 170 mg/mi. Application of NO<sub>x</sub> control technologies that will be implemented on Class 4 through Class 8 trucks for compliance with 2027 and later emissions standards, such as dual-SCR, active thermal management measures, and passive thermal management design, can also be applied to MDV diesels in order meet new MDV NMOG+NO<sub>x</sub> emissions standards. A thorough discussion of these technologies may be found within the Regulatory Impact Analysis for the 2027 and Later Heavy-Duty Engine and Vehicle Standards Final Rule (U.S. EPA 2022).



**Figure 3-17: MY2022-2023 MDV box and whisker plot showing the interquartile range (boxes) and data within 1.5X of the interquartile range (whiskers) for NMOG+NO<sub>x</sub> certification data.**

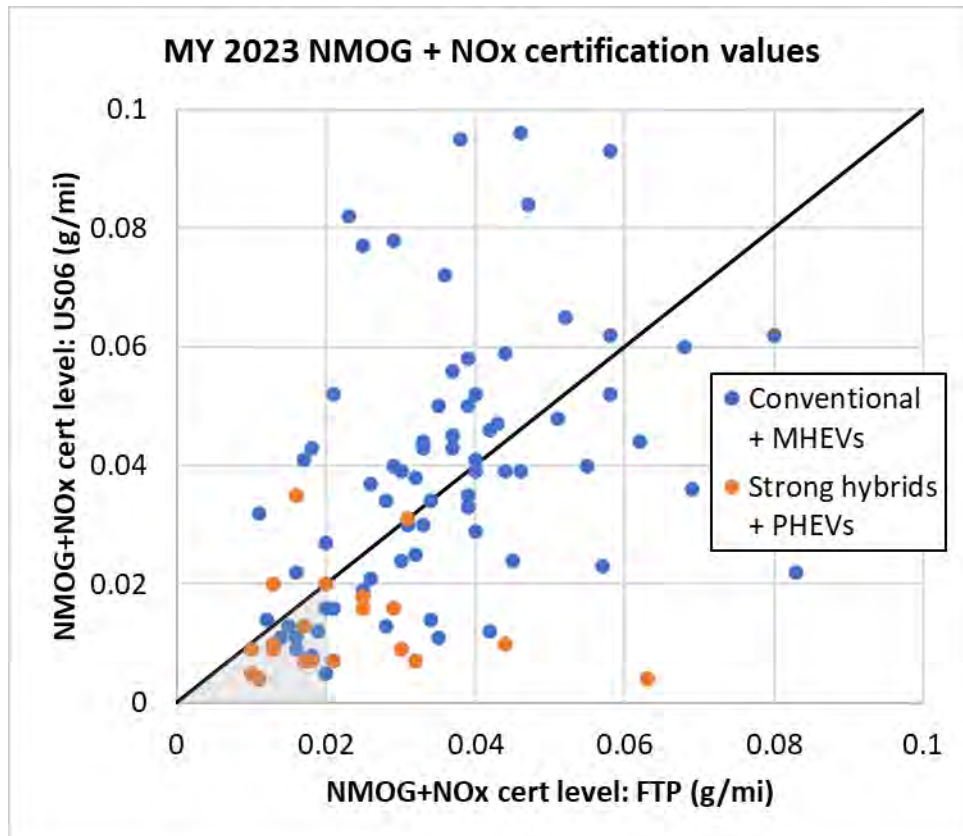
EPA recognizes that compliance headroom is a concern for vehicle manufacturers. Vehicle manufacturing variation, test to test variations, and test location variables all contribute to a manufacturer's desire to have 30 to 40 percent compliance headroom when submitting data and vehicles to EPA for certification. However, given the low emissions demonstrated by current MY 2023 LD vehicles and MY2022 and MY2023 MDVs, EPA believes that manufacturers will be able to utilize the lower bins finalized in this rulemaking and maintain their target compliance headroom. Certification of ICE-based vehicles to the lower bins in combination with the introduction of an increasing number of PEVs into the fleet average provides a feasible compliance pathway to meet the declining FTP NMOG+NO<sub>x</sub> fleet averages for both LD vehicles and MDVs.

<sup>27</sup> Tier 3 FTP NMOG+NO<sub>x</sub> emissions standards are 178 mg/mi for Class 2B and 247 mg/mi for Class 3 MDVs.

### 3.2.5.1 Technologies that can reduce NMOG+NO<sub>x</sub> emissions

Multiple technologies and control strategies are available to reduce tailpipe emissions from ICE. Included below is a survey of possible changes that can be made to aftertreatment systems, engine operation, catalyst heating, and hybrid/PHEV control strategy to reduce NMOG+NO<sub>x</sub> emissions. These technology changes primarily focus on improving three-way catalyst (TWC) performance and/or engine-out emissions in the first 60 to 100 seconds of the FTP. During this time period, the catalyst is still relatively cold; it is estimated that up to 70-plus percent of total tailpipe cycle emissions are created over the first sixty seconds of the FTP (Warkins, Tao and Lyu 2020), while 90 percent are created over bag 1 of the FTP (Moses-DeBusk, Storey, et al. 2023).

However, some of these technologies also serve to reduce NMOG+NO<sub>x</sub> over the remaining bags of the FTP where the catalyst is already warm. Implementing these technologies also serve to reduce NMOG+NO<sub>x</sub> over the other test cycles (such as the US06) that are run completely under warm conditions. Vehicles with certification data over both the FTP and US06 cycles tend to have lower US06 values, averaging 97 percent of the FTP value (see Figure 3-18). In particular, vehicles with the lowest FTP NMOG+NO<sub>x</sub> emissions - below about 20 mg/mi - have US06 certification values that are primarily at the same as or lower than FTP values (as indicated by the shaded triangle in Figure 3-18).



**Figure 3-18: Comparison between FTP and US06 NMOG+NO<sub>x</sub> certification values for MY 2023 vehicles with FTP certification values below 100 mg/mile.**



### **3.2.5.2 Changes in aftertreatment system hardware**

Altering the hardware in the aftertreatment system, particularly the TWC itself, can improve emissions performance.

#### **3.2.5.2.1 Lower mass catalysts**

Reducing the thermal mass of the three-way catalyst reduces the energy required to heat the catalyst, reduces the time required for light-off, and thus reduces the tailpipe emissions associated with the engine cold start. Decreasing total catalyst mass can be accomplished by reducing substrate weight or washcoat amount.

To reduce substrate weight, Corning has introduced high-porosity, low mass catalyst substrates commercially (Corning 2023). Testing on multiple vehicles demonstrated a faster catalyst temperature increase and earlier light-off, culminating in an average 15 percent reduction in both NMHC and NO<sub>x</sub> for vehicles with FTP emissions values ranging from 10 to 40 mg/mi (Warkins, Tao and Lyu 2020). Testing with a similar high porosity substrate on a pickup with a 5.3L gasoline engine showed a 22 percent reduction in NMHC + NO<sub>x</sub>, from 25.3 mg/mile to 19.7 mg/mi (Asako, et al. 2022). Similar results (25 percent NO<sub>x</sub> reduction and 21 percent NMHC over an RDE cycle) were obtained by researchers from NGK and Ford (Nakasumi, et al. 2023).

Alternatively, the mass of the washcoat can be reduced. Researchers from Honda tested a catalyst where the washcoat was reduced by 40 percent, leading to a 25 percent reduction in NMOG+NO<sub>x</sub> over the FTP (Nakanishi, et al. 2019). To maintain the performance of the reduced-washcoat catalyst after aging, improvements were made in the carrier materials and a phosphorus trapping material was added.

#### **3.2.5.2.2 Higher surface area catalysts**

Increasing the cell density in a catalyst increases the geometric surface area, leading to higher conversion efficiency and better emissions performance. Researchers from NGK and Ford have shown that a high cell density in the close-coupled catalyst improves NMHC + NO<sub>x</sub> emissions both during a cold start and during later warm phases, with a 6 percent NO<sub>x</sub> reduction and 14 percent NMHC over an RDE cycle (Nakasumi, et al. 2023). They also tested high-porosity substrates, showing that a combination of higher porosity (and thus reduced heat capacity) with higher cell density (and thus increased surface area) can reduce both cold emissions but also overall cycle emissions.

#### **3.2.5.2.3 Advanced washcoat and PGM technology**

Higher platinum group metal (PGM) loading in the washcoat can increase catalyst efficiency, particularly in the light-off phase between 150 °C and 350 °C. For example, Maurer reports that with higher PGM loading compared to a state-of-the-art catalyst, a NO<sub>x</sub> conversion rate of 99 percent can be reached at a 50 °C cooler catalyst temperature (Maurer, Yadla, et al. 2020).

Researchers from Johnson Matthey report that increasing the amount of rhodium loading on a TWC has a relatively large effect for a small increase in rhodium, with the temperature of 50 percent conversion (T50) decreasing by 20 °C for both HC and NO<sub>x</sub> with a small increase in Rh (Cooper and Beecham 2013). Similarly, Alikin and Vedygin found that increasing rhodium percentage in the TWC can potentially reduce the T50 by 60 °C for both HC and NO<sub>x</sub> (Alikin

and Vedyagin 2016). Researchers at Ford and Johnson Matthey looked at multiple formulations of a catalyst, finding that the use of rhodium supported on alumina, along with an overlayer of either titanium or zirconium, substantially reduced the T90 temperature (C. Lambert 2018) (Theis, Getsoian and Lambert 2018). In their experimentation, they found that a rhodium loading of a titanium overlayer of 0.5 percent produced optimum results. Compared to a commercial catalyst, T90 was reduced by 90 °C for HC and over 100 °C for NO.

#### **3.2.5.2.4 HC traps, NO<sub>x</sub> adsorbers, and catalyzed filters**

Another concept for aftertreatment hardware is the addition of an HC trap. HC traps specifically target the emissions produced at engine start, before the TWC lights off. To investigate this, researchers looked at placing an HC trap in the exhaust upstream of the TWC (Maurer, Yadla, et al. 2020). This showed that the trap adsorption efficiency was 75 percent, and nearly 85 percent immediately after the initial cold start. Another concept looked at adding a HC trap downstream of the TWC, along with a GPF (Moses-DeBusk 2021). Experiments were done on pickup trucks with 2.7L turbo V6 and 5.3L naturally aspirated V8 engines. An HC trap alone was found to reduce total HCs by 65 percent over the first bag of FTP, while the addition of a GPF to the exhaust reduced total HCs by 77 percent over the first bag of FTP.

Another study looked at adding an HC and NO<sub>x</sub> adsorber to the catalyst (Gao, et al. 2012). Simulations with hybrid vehicles over a cold-start UDDS showed a two- to three-fold reduction in tailpipe HC over the cycle and a 30 to almost 50 percent reduction in NO<sub>x</sub>.

A somewhat unconventional application of a HC trap was performed with a VW vehicle (Moser, et al. 2021). The original vehicle had two TWCs, one close-coupled to the turbocharger, and the other downstream under the floor. Replacing the underfloor TWC with a HC trap reduced the NMHC over the FTP from 8 mg/mi to about 5.5 mg/mi. Replacing the close-coupled TWC with a HC trap instead reduced the NMHC to 5 mg/mi. The same study optimized the usage and placement of the catalyst materials in the remaining under-floor TWC. The combination of the close-coupled HC trap and optimized under-floor TWC resulted in a reduction in NMHC + NO<sub>x</sub> over the FTP from 29.4 mg/mi NMHC + NO<sub>x</sub> to 13.7 mg/mi. With the same configuration, NMHC + NO<sub>x</sub> over the US06 cycle was maintained below 10 mg/mi.

The addition of a catalyzed gasoline particulate filter can also decrease tailpipe emissions. Researchers installed a catalyzed, passive regenerating, wall-flow GPF in a Ford Focus downstream of the TWC (Chan, et al. 2016). Over the FTP, this configuration reduced NO<sub>x</sub> by 34 percent (from 17.6 mg/mi to 11.5 mg/mi) and THC by 38 percent (from 11.8 mg/mi to 7.3 mg/mi). Because of the placement, these reductions were smaller over the cold start because the catalysts on the GPF did not reach the light-off temperature early enough. However, over the US06, the same configuration reduced NO<sub>x</sub> by 88 percent (from 47.2 mg/mi to 5.7 mg/mi) and THC by 54 percent (from 25.9 mg/mi to 12.0 mg/mi). Similar results are seen when installing a second stage catalyst in the same location, with NMOG reductions of 86 percent and NO<sub>x</sub> reduction of 20% over the US06 (Roy, et al. 2018).

#### **3.2.5.3 Changes in engine operation**

Below is a survey of possible changes when made to engine operation have the potential to reduce NMOG+NO<sub>x</sub> emissions.

### 3.2.5.3.1 Changing valve timing for initial engine start

Changing valve timing during a cold engine start can reduce the amount of pollutants which are emitted by the engine. Researchers from MIT studied the effects of negative valve overlap (NVO), combining late intake valve opening (IVO) combined with early exhaust valve closing (EVC) (Rodriguez and Cheng 2016). They found that delayed IVO created lower in-cylinder pressures and thus improved spray flash boiling due to the lower in-cylinder pressures, while improving mixing and potentially reducing wall wetting. The early EVC traps more high temperature residuals, improving spray vaporization. The combination reduced engine-out HC from the cold start by 30 percent (and PM by 28 percent). The same strategy reduces engine-out NO<sub>x</sub> from the cold start by 59 percent due to reduced effective compression ratio and thus lower peak temperature during the first 2 engine cycles, and the increased residual gas fraction after the 2nd cycle (Rodriguez and Cheng 2017). Other researchers found similar results, where increasing NVO to 138 degrees reduces NO<sub>x</sub> by up to 95 percent and HC by 20 percent (Zhu, et al. 2013).

Similarly, changing both opening and closing timing of the exhaust valve can also reduce cold-start engine-out emissions. Early exhaust valve opening (EVO) increases exhaust gas temperature, while the early EVC enhances fuel vaporization and air/fuel mixing. The combination can reduce start-up hydrocarbon emissions by 27 percent (Bohac and Assanis 2004).

Other researchers looked at the effects of injection, spark, and valve timing, combined with the higher cranking speeds made possible with hybrid powertrains. Over the first few cycles, a 1600 rpm cranking speed combined with late intake first injection, highly retarded spark timing, and high valve overlap conditions reduced the engine-out HC emissions by 94 percent compared to the baseline conditions (Khameneian, et al. 2022).

Another potential strategy for reducing tailpipe emissions is cylinder deactivation. Cylinder deactivation is typically used to reduce fuel consumption and GHG, but it can also be an enabler for early catalyst heating. For example, rolling cylinder deactivation using Tula's Dynamic Skip Fire (DSF) improves the combustion stability due to higher cylinder load, thus allowing more spark retard and higher exhaust temperatures. A study was done on the potential for DSF to increase exhaust gas temperature during a cold start (Luo, et al. 2020). Combustion phasing was retarded by 20 degrees with no degradation of combustion stability, resulting in an increase in catalyst temperature of 100 °C in the first 17.5 seconds. Depending on the DSF pattern chosen, cold start THC can be reduced by 9 percent to 19 percent, and cold start NO<sub>x</sub> by up to 50 percent.

### 3.2.5.3.2 Engine Speed

A typical 12V starter motor will accelerate the engine to only about 300 rpm before the first injection and ignition event. The low speed causes some issues with combustion, such as bad evaporation and homogenization and fuel enrichment (Menne, et al. 2022). Increasing the engine speed at the first ignition event avoids these problematic factors and reduces emissions from the first few engine cycles. This would require more powerful starter motors, operating at 48V or higher, such as those seen in mild and strong hybrid vehicles. These 48V systems could be implemented for engine start in conventional vehicles, with the advantage of the GHG reduction opportunities afforded by a mild hybrid system.

### **3.2.5.4 Addition of active catalyst heating**

Active catalyst heating involves the installation of additional hardware in the aftertreatment system that is used to preheat the catalyst before and immediately after engine start. The heater can be either electrically powered or can be a fuel burner. Below is a summary of possible active catalyst heating changes that can more quickly heat the catalyst to operating temperature and reduce NMOG+NO<sub>x</sub> emissions.

#### **3.2.5.4.1 Electrically heated catalysts**

Electrically heated catalysts (EHC) increase the temperature of the catalyst before and/or just after engine ignition, causing the catalyst to reach light-off temperature more quickly than it would otherwise. These systems often include an air pump to transfer heat from the heating element to the catalyst without requiring air flow from the engine (Maurer, Kossioris, et al. 2023). Although EHCs can be powered using the 12V electrical system, the low voltage limits the power that can be applied to the heater and thus limits the rate of temperature rise. Therefore, EHCs are more effective with 48V or higher electrical systems (Jean and Goncalves 2023) (Laurell, et al. 2019). EHCs are already commercially available from suppliers such as Vitesco (Bargman, et al. 2021) (Continental 2015) and Faurecia (Jean and Goncalves 2023) (Faurecia 2023).

Researchers from Corning tested a 48V electrical heater integrated as closely as possible to the first TWC, then used the EHC to pre-heat it before running over the WLTC (Kunath, et al. 2022). Pre-heating initiated approximately 15 seconds before engine ignition resulted in an earlier temperature increase in and light-off of the catalyst, reducing both THC and NO<sub>x</sub> in the first bag by 30-40 percent. The system was also tested with a supplemental air supply system to accelerate the heat-up of the TWC. With the supplemental air injection, the TWC was heated more quickly, resulting in a 70-75 percent reduction in THC and an 80 percent reduction NO<sub>x</sub>. Researchers from Volvo and Continental found similar results with a system containing a 48V electrical heater without a supplemental air supply. Here, pre-heat began approximately 12 seconds before engine ignition, which reduced both HC and NO<sub>x</sub> by 50 percent during the initial 30 seconds of engine run time.

#### **3.2.5.4.2 Electrically Heated catalysts in HEVs and PHEVs**

Electrically heated catalysts can work particularly well with HEVs or PHEVs for two reasons: first, the higher voltage batteries provide a ready source of power for the EHC, allowing higher power and quicker temperature rise than achievable with 12V systems. High voltage HEVs may require a DC/DC converter to step the voltage down to an appropriate value, but these converters are already commercially available (Green Car Congress 2021). The second reason is that a hybrid vehicle can be driven exclusively with the electric motor at the beginning of the cycle, allowing additional time for the catalyst to heat up before the initial engine start. The additional time can be very beneficial to emissions reduction; for example, Maurer showed that while a 15 second preheating time significantly reduces tailpipe NO<sub>x</sub>, increasing the preheat time to 30 seconds nearly eliminates the NO<sub>x</sub> (Maurer, Kossioris, et al. 2023).

In one experimental demonstration, installation of an electric heater on a Mitsubishi Outlander PHEV showed that total NMHC + NO<sub>x</sub> over the FTP could be reduced from 22 mg/mi to 12 mg/mi (Jean and Goncalves 2023). The authors note that this level of performance requires either

a higher voltage power source to the heater (for example a 48V source rather than 12V) to provide adequate heating power during a cold start, or the additional time afforded by the delayed engine start in a HEV.

In another demonstration, Toyota showed that the application of an electrically heated catalyst to a Prius Prime PHEV along with a motored engine start sequence (where the engine is brought up to idle speed by the electric motor and motored for several seconds prior to ignition) and a catalyst control to avoid over-heating resulted in FTP NMOG+NO<sub>x</sub> emissions of less than 3 mg/mi (Kawaguchi, et al. 2019).

#### **3.2.5.4.3 Exhaust burners**

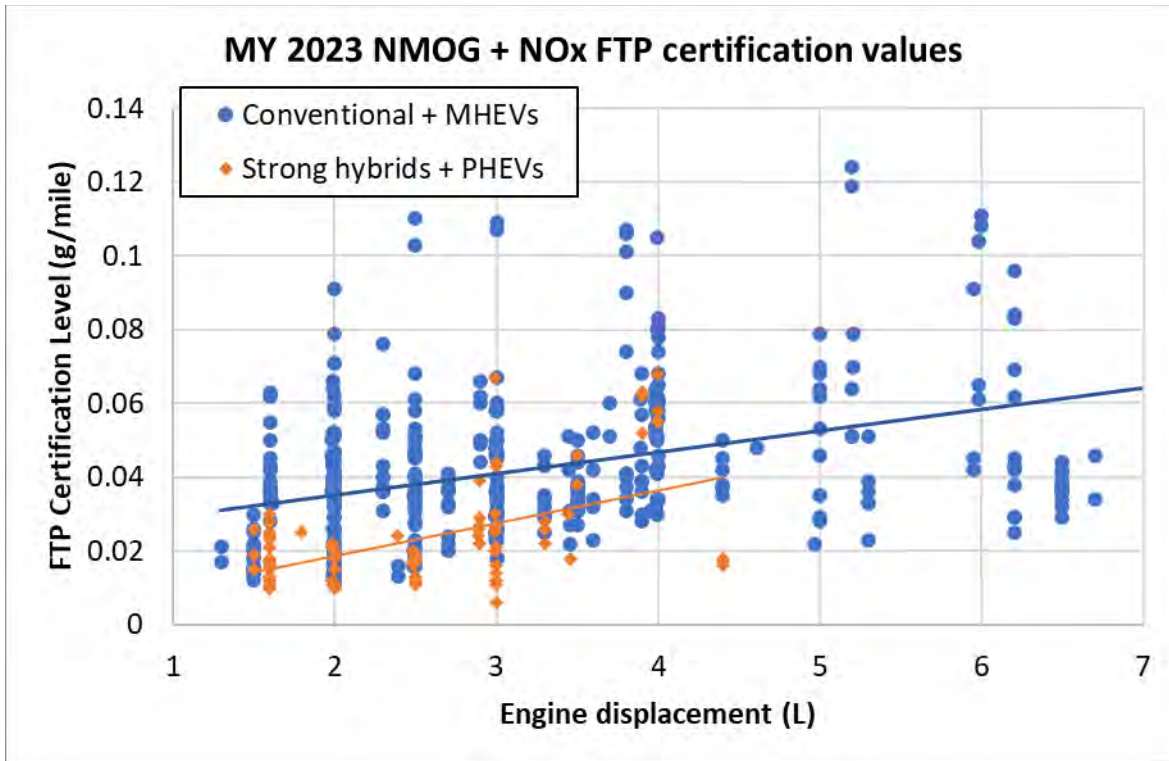
Like electric heaters, exhaust burners are used to heat the catalyst before engine ignition. Burners have the advantage of not requiring higher voltage sources to supply sufficient heat, and thus may be more adaptable to non-hybrid applications. The burner itself also produces small amounts of pollutants, on the order of 4.5 mg of HC and 7.1 mg NO<sub>x</sub> over 15 seconds of burner operation (Maurer, Kossioris, et al. 2023). However, the addition of a small carbon canister for HC desorption from the burner exhaust may ameliorate this (Maurer, Yadla, et al. 2020).

One experimental investigation into a burner with a pre-catalyst showed a significant increase in temperature of the catalyst before engine start (Clenci, et al. 2022). This investigation incorporated a substantial pre-heating time (approximately 100 seconds), but catalyst temperatures were above light-off well before the end of the pre-heat time.

#### **3.2.5.5 Solutions for Hybrids and PHEVs**

The incorporation of hybrids and PHEVs into the fleet can present challenges to emissions reduction due to extended engine off operation eventually requiring engine restarts. In particular, high-power cold starts seen in PHEVs may yield higher NMOG+NO<sub>x</sub> exhaust gas emissions (Pham and Jetic 2018). However, as noted above in Chapter 3.2.5.1.2.2, the availability of the electric drive motor can enable engine start and re-start strategies that reduce cold-start emissions. In fact, the majority of the low NMOG+NO<sub>x</sub> emission vehicles listed in Table 3-19 are strong hybrid or plug-in hybrid vehicles. Higher voltage batteries used by hybrids and PHEVs may also enable electrically heated catalysts, as discussed in Chapter 3.2.5.1.3.1.

A further examination of all MY 2023 certification values (U.S. EPA 2023), seen in Figure 3-19 as a function of engine displacement, shows that HEV and PHEV emissions for NMOG+NO<sub>x</sub> tend to be lower than corresponding conventional and mild hybrid vehicles (MHEV). This suggests that, rather than allowing the high-power cold starts to inflate vehicle emissions, manufacturers are taking advantage of the emissions reduction possibilities available when the electric drive motor is used in conjunction with the engine. Additionally, Figure 3-18 shows that HEVs and PHEVs tend to have even lower NMOG+NO<sub>x</sub> emissions over the US06 cycle than over the FTP.



**Figure 3-19: Model Year 2023 NMOG+NO<sub>x</sub> FTP certification values as a function of engine displacement, MY 2023 fleet.**

As an example of creative electric motor usage in hybrid vehicles, Toyota demonstrated the effectiveness of a motored engine start to control emissions (Kawaguchi, et al. 2019). During the FTP cold start, using the electric motor to motor the engine for a few seconds before ignition generates heat in the cylinder and reduces intake manifold pressure, allowing low load combustion which can reduce the mass of exhaust gas emissions. Additionally, engine ignition at idle speed rather than lower speeds avoids unbeneficial factors seen over the first few firing cycles, such as poor in-cylinder evaporation, poor homogenization, and fuel enrichment (Menne, et al. 2022). Both the motoring start and idle speed ignition reduce emissions from the cold catalyst. The Toyota demonstration showed that a motoring start can reduce the NO<sub>x</sub> and HC emitted over the first hill (130 seconds) of the FTP by 23 percent (Kawaguchi, et al. 2019).

Moreover, usage of electric-only drive at the beginning of the FTP delays the engine start and allows more time for an active catalyst heater to bring the catalyst up to light-off temperature. Toyota implemented a preheat cycle lasting over 50 seconds at the beginning of the FTP before the engine started, resulting in a substantial reduction in NMOG+NO<sub>x</sub> over the FTP, lowering it to under 3 mg/mi (Kawaguchi, et al. 2019). Researchers from Vitesco showed that a 150 second pre-heat time before the initial engine start was able to eliminate 65 percent of the NO<sub>x</sub> and 90 percent of the THC emitted during an aggressive RDE cycle (Brück and Konieczny 2022).

### **3.2.5.6 Combinations of NMOG+NO<sub>x</sub> emissions reduction technologies**

Multiple strategies to reduce NMOG+NO<sub>x</sub> emissions from conventional and hybrid powertrains have been outlined. Individual strategies have been demonstrated and implemented in some applications, but it should be noted that optimum emissions reduction benefits may be

obtained by combining more than one strategy. Moreover, multiple strategies can react synergistically to produce greater benefits.

For example, researchers from Hyundai suggest that “almost zero” emissions over the FTP are possible by applying multiple aftertreatment solutions to selectively reduce emissions (Kim, et al. 2018). They identified three areas that contribute the vast majority of NMOG+NO<sub>x</sub> emissions: cold-start NO<sub>x</sub>, cold-start HC, and fuel-cut NO<sub>x</sub> emissions that occur later in the cycle when the engine cuts fuel and delivers fresh air into the aftertreatment system. To combat the first, the researchers used a cold-NO<sub>x</sub> TWC to act as a NO<sub>x</sub> adsorber during the first 15 seconds of engine operation to substantially reduce cold-start NO<sub>x</sub>. They combined this with a fuel-cut NO<sub>x</sub> TWC that was able to eliminate 74 percent of the NO<sub>x</sub> emissions over bag 2 of the FTP, and then added an underfloor HC trap and EHC which was able to reduce cold start HC emissions by 40 percent, this addressing all of the primary causes of high NMOG+NO<sub>x</sub>.

In a similar way, Toyota combined a heated catalyst in a Toyota Prius Prime with the electric operation of the PHEV at startup and a motored engine start. This reduced emissions on the FTP to less than 2 mg/mi NMOG and less than 1 mg/mi NO<sub>x</sub> and reduced emissions on the WLTC to less than 10 mg/mi NMHC and around 1 mg/mi NO<sub>x</sub> (Kawaguchi, et al. 2019). Similarly, FEV combined an engine timing change to reduce NO<sub>x</sub> with a heated catalyst and a NO<sub>x</sub> trap in an HEV. This reduced emissions to 4 mg/mi HC and well under 1 mg/mi NO<sub>x</sub> on the WLTC, and 5 mg/mi HC and well under 1 mg/mi NO<sub>x</sub> on a "worst case" dynamic RDE cycle (Maurer, Yadla, et al. 2020).

These results of these experimental investigations show that NMOG+NO<sub>x</sub> values well under 15 mg/mi are achievable.

### 3.2.5.6.1 Current ICE Emissions at -7°C FTP

As described in preamble Section III.D.2.iii, EPA is replacing the existing -7°C FTP NMHC fleet average standard of 300 mg/mi for LDV and LDT1, and 500 mg/mi fleet average standard for LDT2-4 and MDPV, with a single NMOG+NO<sub>x</sub> fleet average standard of 300 mg/mi for LDV, LDT1-4 and MDPV for the -7°C FTP cycle. NMOG should be determined as explained in 40 CFR 1066.635.

-7°C FTP NMOG+NO<sub>x</sub> emissions were measured from several current vehicles and results are shown in Table 3-20. The LDV and LDT4 vehicles were significantly under the 300 mg/mi standard being finalized and the MDV exceeded it. Electrification and the technologies described in RIA Chapter 3.5.1 are readily available for further reductions in fleet average -7°C FTP NMOG+NO<sub>x</sub> emissions.

**Table 3-20: -7°C FTP NMOG+NO<sub>x</sub> emissions measurements at EPA.**

| Vehicle                       | NMOG+NO <sub>x</sub> (mg/mi) |
|-------------------------------|------------------------------|
| 2021 Corolla 2.0L             | 138 ± 12                     |
| 2019 F150 5.0L                | 220 ± 4                      |
| 2021 F150 3.5L Powerboost HEV | 184 ± 16                     |
| 2022 F250 7.3L                | 311 ± 62                     |

### 3.2.5.6.2 Feasibility of a Single Numerical Standard for FTP, HFET, SC03 and US06

Table 3-21 below provides a comparison of FTP, HWFE, SC03 and US06 test results for several MY 2023 light-duty vehicles that represent a broad spectrum of vehicle types and conventional powertrain technologies. For most of the vehicles identified the FTP results are higher than the HWFE, SC03 and US06 test results showing that a single standard is feasible and already being met by some manufacturers. There are several examples where SC03 or US06 results are higher than the FTP results. The data shows that the FTP and the US06 are the most stringent standards because the of the FTP cold start and the US06 because of higher power requirements and potential enrichment. The HWFE and SC03 cycles are less stringent due to the lack of cold start and lower power demands.

**Table 3-21: Comparison of FTP, HFET, SC03, US06 cert test results for MY 2023 LD vehicles.**

| Manufacturer | Vehicle        | Manufacturer Reported NMOG+NO <sub>x</sub> Values |             |             |             |
|--------------|----------------|---|-------------|-------------|-------------|
|              |                | FTP (g/mi)  | HWFE (g/mi) | SC03 (g/mi) | US06 (g/mi) |
| BMW          | X4 xDrive 30i  | 0.020   | 0.008       | 0.008       | 0.014       |
| BMW          | I3s REX        | 0.014   | 0.020       | 0.012       | 0.011       |
| BMW          | 540i xDrive    | 0.036   | 0.020       | 0.031       | 0.029       |
| Ford         | Corsair        | 0.035   | 0.009       | 0.09        | 0.030       |
| Ford         | Ranger         | 0.052   | 0.033       | 0.05        | 0.090       |
| Ford         | Explorer       | 0.038   | 0.025       | 0.03        | 0.030       |
| Ford         | F150           | 0.026   | 0.014       | 0.017       | 0.041       |
| GM           | Terrain        | 0.013   | 0.001       | 0.011       | 0.005       |
| GM/Cadillac  | XT6            | 0.026   | 0.002       | 0.008       | 0.005       |
| GMC          | K10 Sierra 4WD | 0.026   | 0.005       | 0.014       | 0.008       |
| Hyundai      | Genesis        | 0.038   | 0.014       | 0.013       | 0.056       |
| Hyundai      | Elantra        | 0.037   | 0.015       | 0.028       | 0.072       |
| Kia          | Sportage       | 0.036   | 0.017       | 0.036       | 0.024       |
| Kia          | Sorento        | 0.032   | 0.016       | 0.03        | 0.039       |
| Nissan       | Altima         | 0.015   | 0.006       | 0.019       | 0.017       |
| Porsche      | Cayenne Turbo  | 0.072   | 0.034       | 0.050       | 0.050       |
| Volkswagen   | Audi Q3        | 0.008   | 0.002       | 0.009       | 0.012       |
| Volkswagen   | Tiguan AWD     | 0.017   | 0.002       | 0.009       | 0.008       |
| Volkswagen   | Jetta GLI      | 0.017   | 0.003       | 0.016       | 0.009       |
| Average      |                | 0.029   | 0.013       | 0.025       | 0.030       |

As the result of this change, EPA expects light-duty vehicles to have lower emissions over a broader area of vehicle operation. Present-day engine, transmission, auxiliary and aftertreatment control technologies allow closed-loop A/F control and good emissions conversion throughout the HWFE, US06 and SC03 cycles; as a result, higher emissions standards over these cycles are no longer justified. Overall, approximately 60 percent of the of test group / vehicle model certifications from MY 2021 have higher NMOG+NO<sub>x</sub> emissions in the FTP as compared to the US06, supporting the conclusion that a single standard is feasible and appropriate.



### **3.2.6 Particulate Matter Emissions Control**

The final PM standard and its phase-in are presented in Section III.D.3 of the preamble. An overview of GPF technology is provided in RIA Chapter 3.2.6.1. GPF benefits and the feasibility and readiness of GPF technology and measurement procedure readiness are demonstrated in RIA Chapter 3.2.6.2. The importance of the PM test cycles is described in Chapter 3.2.6.3. GPF cost is discussed in RIA Chapter 3.2.6.4. The impact of GPF on CO<sub>2</sub> emissions (energy) is presented in RIA Chapter 3.2.6.5.

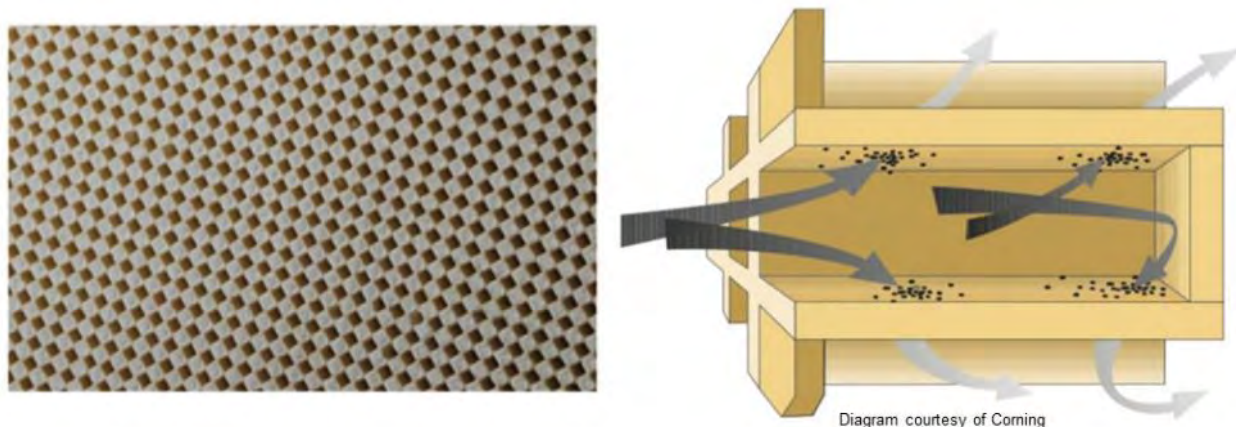
#### **3.2.6.1 Overview of GPF Technology**

Gasoline particulate filter (GPF) technology is not new. It has been used in series production on all new pure GDI type approvals (new vehicle models) in Europe since 2017 (WLTC and RDE test cycles) and on all new pure GDI vehicles in Europe since 2019 (WLTC and RDE test cycles) to meet a  $6 \times 10^{11}$  #/km solid particle number (PN) standard. All new gasoline vehicles in China have had to meet the same  $6 \times 10^{11}$  #/km solid PN limit over the WLTC test since 2020, and in the WLTC and RDE starting in 2023. In India, BS6 stage 2 requires all new pure GDI vehicles to also meet the  $6 \times 10^{11}$  #/km solid PN limit in the MIDC (Indian version of NEDC) and RDE since April 2023. U.S., European, and Asian manufacturers and suppliers have extensive experience with applying GPF technology to series production vehicles and at least six manufacturers are assembling at least ten vehicle models with GPFs in the U.S. for export to other markets. There have been approximately 100 million gasoline particulate filters (GPFs) installed in light-duty vehicles worldwide.

GPFs require that manufacturers design for safe interaction between hot GPF surfaces and other vehicle components, systems, and the environment, like the integration of turbochargers, catalysts, and exhaust components into a vehicle. There are no known safety incidents associated with the millions of GPFs that have been in use in Europe, China, and India, and the same is expected in the U.S. market.

GPFs being used in Europe and Asia, and those expected to be used in the U.S. to meet the 0.5 mg/mi PM standard, use a ceramic honeycomb structure with alternating channels plugged at their inlet and outlet ends (Figure 3-20). GPFs use Cordierite for its low coefficient of thermal expansion and thermal shock tolerance. GPF substrates typically have 45-65 percent porosity, 10-25  $\mu\text{m}$  median pore size, 6-12 mil (1 mil = 1/1000 inch) wall thickness, and 200-300 cpsi (cells per square inch) cell density. GPF substrates can be manufactured in various diameters, lengths, and shapes (e.g., round or oval).

Wall flow filters allow exhaust gas to flow through porous filter walls while particulates are captured in or on the wall (Figure 3-20). Gasoline engine-out particulates (typically from <10 to 300 nm) are smaller than GPF mean pore size (typically 10-25  $\mu\text{m}$ ) but particles are captured at high filtration efficiencies across their size range by Brownian diffusion (effective for small particles, <30 nm), interception (intermediate particles), and inertial impaction (large particles).



**Figure 3-20: Wall-flow GPF design.**

A clean GPF initially captures particulates within its pore structure (depth filtration mode); then at high levels of soot loading, additional particulates form a soot layer (soot cake) on the top of the wall (soot cake or surface filtration mode). Filtration efficiency improves rapidly with initial soot and ash loading (Lambert, et al. 2017), then levels off at high filtration efficiency at high soot loading. GPF backpressure increases with soot and ash loading. Operation at low levels of soot loading is more challenging for high PM filtration because the GPF cannot rely on stored soot to assist with filtration, but newer designs, e.g., MY2022 GPFs, use a different pore structure at the surface of the wall than beneath it to achieve high filtration efficiency with low flow resistance even without soot or ash loading.

Both bare and catalyzed GPFs are used extensively in series production. Catalyzed GPFs typically use a washcoat containing Pd and Rh for TWC-type activity. Catalyzed GPFs reduce the temperature needed to oxidize stored soot and convert gaseous criteria emissions like a TWC does. A catalyzed GPF can replace one of the TWCs on a vehicle, potentially reducing system cost. Optimizing filtration, backpressure, and gaseous emissions light-off, however, can be more challenging with a catalyzed GPF as compared to a bare GPF.

Accumulated soot in a GPF is oxidized to  $\text{CO}_2$  and  $\text{H}_2\text{O}$  in the presence of sufficient temperature and oxidants (mostly  $\text{O}_2$  in gasoline engines). Significant rates of GPF regeneration are observed above  $600^\circ\text{C}$  for a bare GPFs (Borger, et al. 2018) and above  $500^\circ\text{C}$  for a catalyzed GPFs (Saito, et al. 2011). In most applications, normal vehicle operation results in sufficiently high temperature, and deceleration fuel cut-off (DFCO) supplies the GPF with sufficient  $\text{O}_2$ , resulting in passive regeneration. If a vehicle is only operated at very low load conditions or is not allowed to warm up, a differential pressure sensor on the GPF can sense imminent GPF overloading and initiate an active regeneration in which engine settings are adjusted to increase GPF temperature and supply it with sufficient  $\text{O}_2$ . Active GPF regeneration strategies are discussed in (van Nieuwstadt, et al. 2019).

GPFs are sometimes installed close to the engine in a "close-coupled" position, immediately following the TWC, to promote passive regeneration and fast light-off of a catalyzed GPF. Other times GPFs are installed farther from the engine, in an "underfloor" location, for packaging

reasons. The lower exhaust gas temperature in underfloor GPFs also reduces backpressure for a given GPF size and geometry because cooler exhaust has higher density.

GPF size, design, and installation relative to the engine must be considered for the GPF to have sufficient PM filtration efficiency, sufficiently low backpressure, sufficient ash loading capacity, fast light-off if the GPF washcoat is relied upon for gaseous criteria emissions conversion, and good regeneration characteristics. Unlike soot that is oxidized after being captured by the GPF, ash accumulates on the GPF, typically for the life of the vehicle. Thus, ash capacity is one factor that determines GPF size for a given application.

GPFs are like diesel particulate filters (DPF) in certain respects. Both GPFs and DPFs are wall-flow filters that use a ceramic honeycomb substrate with alternating channels plugged at their inlet and outlet ends to filter particulates. But GPFs operate at higher exhaust gas temperatures, lower soot loadings, lower exhaust gas O<sub>2</sub> and NO<sub>2</sub> concentrations, and only see elevated exhaust gas O<sub>2</sub> concentrations during DFCO events. High exhaust gas temperature tends to keep GPFs at lower soot loading through frequent passive regeneration, making high filtration efficiency harder to achieve in GPFs, especially in applications that frequently operate at high load. Newer GPF designs that use different pore structure on the surface have largely addressed low filtration efficiency at low soot and ash loading. Low soot loading of GPFs results in lower backpressure than DPFs. GPFs require low heat capacity to make use of relatively short bursts of elevated O<sub>2</sub> during DFCO events, so Cordierite has become the dominant GPF substrate material. DPFs benefit from higher heat capacity to accommodate larger and less frequent regeneration events involving larger amounts of soot and high flow rates of exhaust O<sub>2</sub> making silicon-carbon a popular DPF substrate material.

GPFs have a strong record with respect to robust operation and durability since their introduction into mass production in Europe and China. The first GPFs introduced into series production have not experienced the failures that troubled early DPFs introduced into series production, in part because the higher exhaust gas temperatures seen by GPFs promote frequent passive regeneration, avoiding larger, less frequent regeneration events seen by DPFs that store larger amounts of soot and have high exhaust O<sub>2</sub> flow.

GPF technology has been studied extensively for more than a decade and there exists extensive literature on GPF. GPF technology review articles include (Saito, et al. 2011), (Joshi and Johnson 2018), (Boger and Cutler 2019).

### **3.2.6.2 GPF Benefits and Feasibility of the Standard**

This section quantifies the emissions benefits of GPF technology and provides additional detail, relative to Section III.D.3.iii of the preamble, on the feasibility of using existing GPF technology and existing PM test procedures in meeting the final PM standard. The section begins by describing test vehicles, GPFs, laboratory procedures, and PM sampling. Reductions in PM mass, elemental carbon (EC), and polycyclic aromatic hydrocarbon (PAH) over a composite drive cycle are then presented. After that, cycle-specific reductions in PM mass emissions from three GPF-equipped vehicles are shown. Finally, laboratory to laboratory PM measurement reproducibility is discussed.

### **3.2.6.2.1 Setup and Test Procedures**

Testing was performed using five chassis dynamometer test cells at three organizations (EPA, ECCC, FEV) and five test vehicles in stock and GPF configurations. Test vehicles included light-duty vehicles and MDV powered by naturally aspirated and turbocharged PFDI (port and direct fuel injection), DI (direct injection), and PFI (port fuel injection) gasoline engines. GPF-equipped vehicles used series-production GPFs from MY 2019 and MY 2022 GPF. GPFs used catalyzed and bare substrates, and they were installed in close-coupled and underfloor configurations.

The five chassis dynamometer test cells used in the demonstration included three test cells at EPA National Vehicle and Fuel Emissions Laboratory (NVFEL) in Ann Arbor, one test cell at ECCC in Ottawa, and one test cell at FEV in Auburn Hills. -7°C FTP tests were performed at EPA (one test cell), ECCC, and FEV. 25°C FTP and US06 tests were performed at EPA (three test cells), ECCC, and FEV. Two test vehicles were tested at all organizations, while three vehicles were only tested at EPA.

All five test cells used in the demonstration were designed to be compliant with 40 CFR parts 1065 and 1066. In each test cell, vehicle exhaust gas is diluted in a constant volume sampler (CVS) full-flow dilution tunnel system. Heated particulate filter samplers draw dilute exhaust through a coarse particle separator (~2.5 µm cut at sampling conditions) and 47 mm PTFE membrane filters [e.g., Measurement Technology Laboratories (MTL) PT47DMCAN].

PM filters were conditioned at 22±1°C, 9.5±1°C dew point for a minimum of 1 hour before being weighed, before and after being loaded with PM. Filters were weighed using a microbalance (e.g., Mettler-Toledo XPU2) while being surrounded by strips of Po<sup>210</sup> (e.g., 6 strips of 500 µCi placed on top of and around the filter on the microbalance) for static charge removal. EPA used an MTL A250 robotic autohandler for filter weighing; ECCC and FEV labs used manual filter weighing.

To increase sample filter loading and increase signal to noise ratio for GPF-equipped tests, test cell sampling settings were adjusted relative to test settings typically used to measure Tier 3 levels of PM emissions. For GPF-equipped tests, 1) Dilution factor (DF) was set to the lower or middle part of the CFR-allowable range of 7-20. 2) 25°C FTP and -7°C FTP tests were mostly run using a single filter, as allowed by 40 CFR 1066.815(b)(5). 3) In many tests, filter flow was increased from a typical setting of ~58 slpm to ~65.25 slpm in phases 1 & 2 and ~87 slpm in phases 3 & 4 to increase filter loading and maintain proper phase weighting using flow weighting, while staying below the maximum allowable filter face velocity (FFV) of 140 cm/s as specified by 40 CFR 1066.110(b)(2)(iii)(C). 4) Many of the 25°C FTP and -7°C FTP tests were run as 4-phase FTP tests as opposed to 3-phase FTP tests, although in hindsight, phase 4 didn't add much PM mass to the sampling filter and may not be worth the extra test time. Additionally, to further increase PM filter loading, some of the GPF-equipped tests used double sampled US06 tests, which is not specified in the CFR. In retrospect, a standard single sampled US06 would have been sufficient for demonstrating compliance with the 0.5 mg/mi standard.

Tier 3 certification fuel was used for 25°C FTP and US06 testing, and Tier 3 winter certification fuel was used for -7°C FTP testing at all three organizations. Engine oil was conditioned in each vehicle for a minimum of 600 miles prior to emissions sampling to stabilize the oil (Christianson, Bardasz and Nahumck 2010).

The newest of the five test vehicles was an MDV Tier 3 bin 200 MY 2022 Ford F250 with a naturally aspirated 7.3L V8 PFI engine. It was tested at an ETW of 8000 lb. The F250 was tested in stock and GPF configurations. Vehicle mileage at the start of testing was 2700 miles. For GPF testing, series-production MY 2022 GPFs, one for each bank, were installed downstream of the stock TWCs where the resonator is normally mounted. The GPF used bare substrates of  $\phi 6.443'' \times 6''$  (3.21 L each), 200 cpsi, 8 mil wall thickness. GPFs were aged through 1500 miles of road driving prior to emissions sampling. GPF pressure drop and temperatures were logged.

The second newest test vehicle was a LDT4 Tier 3 bin 70 MY 2021 Ford F150 HEV with a turbocharged (PowerBoost) 3.5L V6 PFDI engine. It was tested at an ETW of 6000 lb. The F150 HEV was only tested in GPF configuration. Vehicle mileage at the start of testing was 5000 miles. A series-production MY 2022 GPF was installed after the Y-pipe in place of the resonator. The GPF used a bare substrate of  $\phi 6.443'' \times 6''$  (3.21 L), 200 cpsi, 8 mil wall thickness. The GPF was aged through 1500 miles of road driving prior to emissions sampling. GPF pressure drop and temperatures were logged.

The third newest test vehicle was an LDV Tier 3 bin 30 MY 2021 Toyota Corolla with a naturally aspirated 2.0L I4 PFDI engine. It was tested at an ETW of 3375 lb. The Corolla was only tested in stock (no GPF) configuration. Vehicle mileage at the start of testing was 5800 miles.

The fourth newest test vehicle was an LDT4 Tier 3 bin 125 MY 2019 Ford F150 with a naturally aspirated 5.0L V8 PFDI engine. It was tested at an ETW of 5000 lb. The 2019 F150 was tested in stock and GPF configurations. Vehicle mileage at the start of testing was 6700 miles. For GPF testing, a series-production aftertreatment system from a MY 2019 European Ford Mustang 5.0L replaced the stock aftertreatment system on the F150. The Mustang aftertreatment system uses a cc1 (close-coupled, position 1) TWC and a cc2 catalyzed GPF for each bank of the engine. The stock aftertreatment system uses a cc1 TWC and a cc2 TWC for each bank. The Mustang GPFs are  $\phi 5.2'' \times 3.3''$  (1.15 L each), 300 cpsi, 12 mil wall thickness. The Mustang aftertreatment system was aged through 1500 miles of road driving prior to emissions sampling. GPF pressure drop and temperatures were logged.

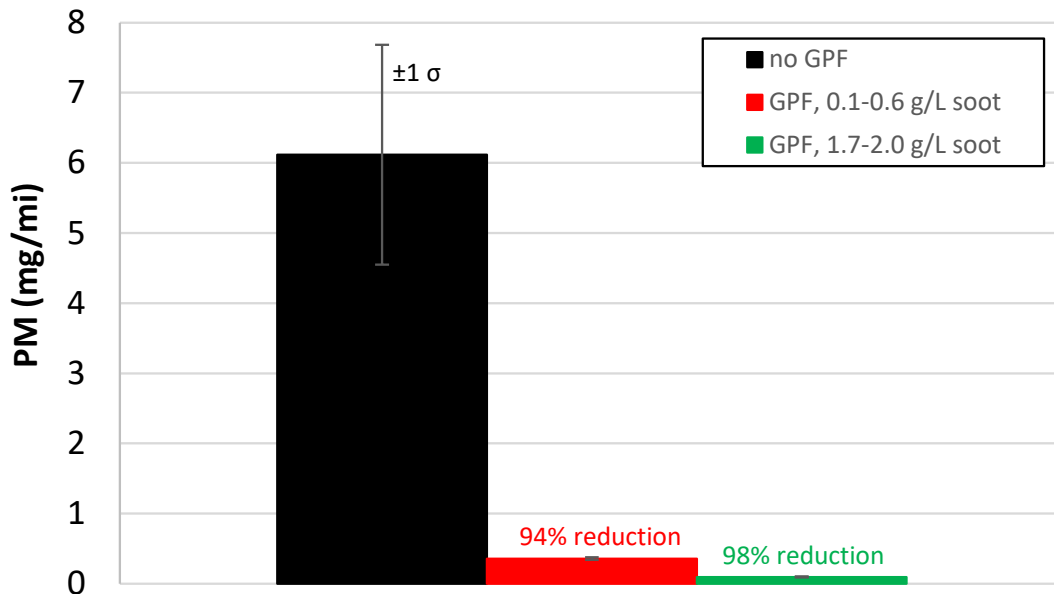
The oldest test vehicle was an LDT4 Tier 2 bin 4 MY 2011 Ford F150 with a turbocharged (Powerboost) 3.5L V6 DI engine. It was tested at an ETW of 5500 lb. The 2011 F150 was tested in stock and GPF configurations. Vehicle mileage at the start of testing was 21,100 miles. For GPF testing, a series-production MY2019 GPF was installed after the Y-pipe in place of the resonator. The GPF used a catalyzed substrate of  $\phi 5.66'' \times 4''$  (1.65 L), 300 cpsi, 12 mil wall thickness. The GPF was aged through 600 miles of dynamometer driving prior to emissions sampling. GPF pressure drop and temperatures were logged.

GPF operation was characterized over a range of soot loadings, but because GPFs are required to comply with the PM standard in any state of soot loading, only results from low-soot-loading tests (which are worst case with respect to tailpipe PM) are included in the following demonstration of meeting the PM standard. GPFs were regenerated before each set of tests by using a sawtooth regeneration cycle. The sawtooth cycle used a series of vehicle accelerations to raise the GPF to high temperature, each followed by a DFCO to provide the GPF with oxygen for regenerating stored PM.

### 3.2.6.2.2 PM Mass, BC, and PAH Emissions Reductions over a Composite Drive Cycle

Results shown in this section are from a MY 2011 F150 that was retrofit with an underfloor catalyzed MY 2019 GPF. Additional details of the vehicle, GPF, and test setup are described in Chapter 3.2.6.2.1 and in (Bohac and Ludlam, Characterization of a Lightly Loaded Underfloor Catalyzed Gasoline Particulate Filter in a Turbocharged Light Duty Truck 2023). Emissions were quantified over a composite test cycle, comprised of vehicle operation at 60 mph cruise control, 25°C FTP, HFET, and US06. Results are shown in total emissions mass per total distance of the test cycle. Tailpipe emissions were quantified a) without a GPF, b) with the GPF in a lightly loaded state with the GPF predominantly in the depth filtration mode (Konstandopoulos 2008) with 0.1-0.6 g/L, (grams soot per liter of GPF substrate volume), and c) with the GPF predominantly in the soot-cake or surface filtration mode (Konstandopoulos 2008) with 1.7-2.0 g/L.

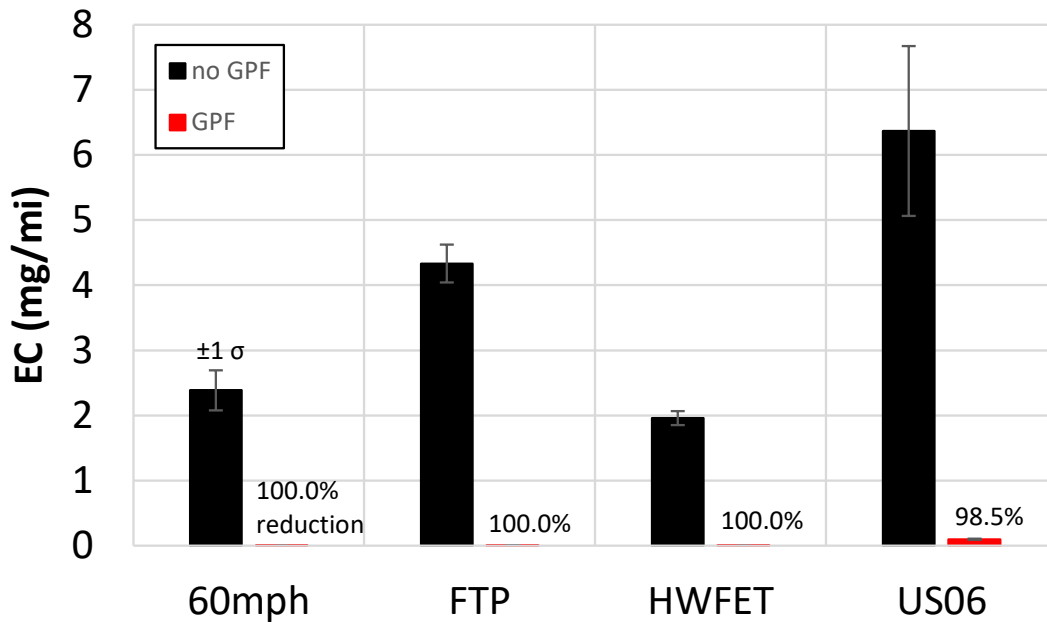
Composite cycle PM emissions are shown in Figure 3-21. PM was reduced by 94 percent with the GPF in a lightly loaded state and 98 percent with the GPF in a heavily loaded state. Additional results and discussion, including cycle-specific PM reductions, can be found in (Bohac, Ludlam and Martin, et al. 2022).



**Figure 3-21: Composite cycle PM reduction at low and high GPF soot loading.**

Elemental carbon (EC) emissions without a GPF and with the GPF in a lightly loaded state (0.1-0.6 g/L soot loading) are shown in Figure 3-22. EC was reduced by 100.0 percent in the 60 mph, 25°C FTP, and HFET cycles, and by 98.5 percent in the US06 cycle. EC measurements were performed using 47 mm quartz fiber filters (Pall Tissuquartz 7202) and a Sunset Laboratory model 5L OCEC Analyzer running National Institute for Occupational Safety and Health (NIOSH) method 870.

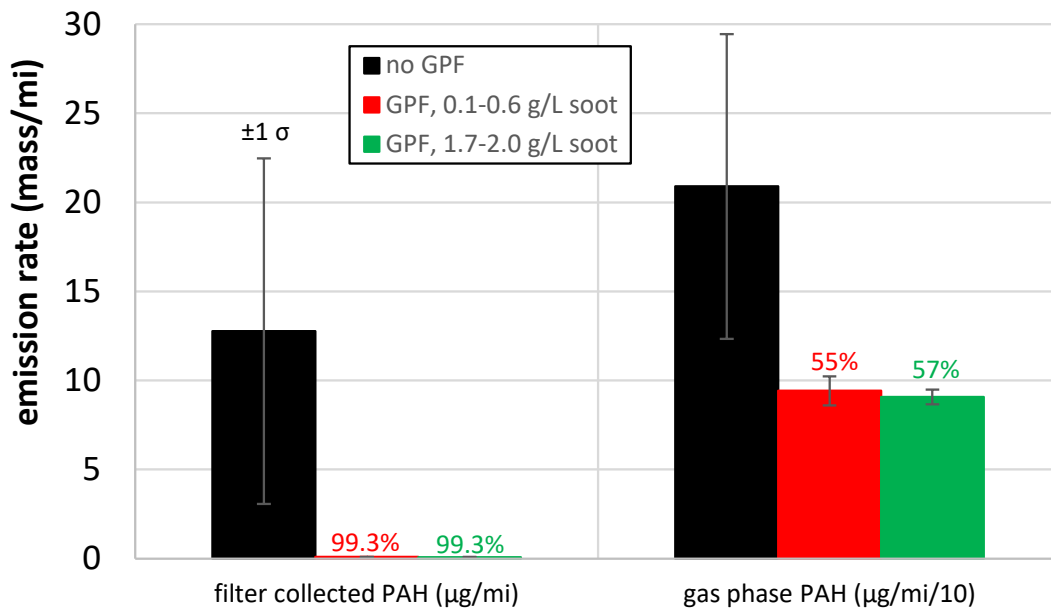
EC emissions quantified in this study and airborne black carbon (BC) studied by climate scientists have different operationally defined definitions, but they are closely related and often used as surrogates (Bond, Doherty and Fahey 2013).



**Figure 3-22: Cycle-specific EC reduction.**

Another significant benefit of GPF technology is the reduction of PAH emissions. To quantify PAH emissions reductions, filter-collected PAH were sampled onto 47 mm quartz fiber filters (Pall Tissuquartz 7202) and gas-phase PAH were sampled using sorbent tubes (Carbotrap C+F). PAHs on filter punches and sorbent tubes were thermally desorbed, cryofocused, and speciated (Agilent 6890/5973 GCMS operated in selected ion mode). 26 PAHs ranging from naphthalene to coronene were quantified. Additional sampling and analysis details can be found in (Bohac, Ludlam and Martin, et al. 2022).

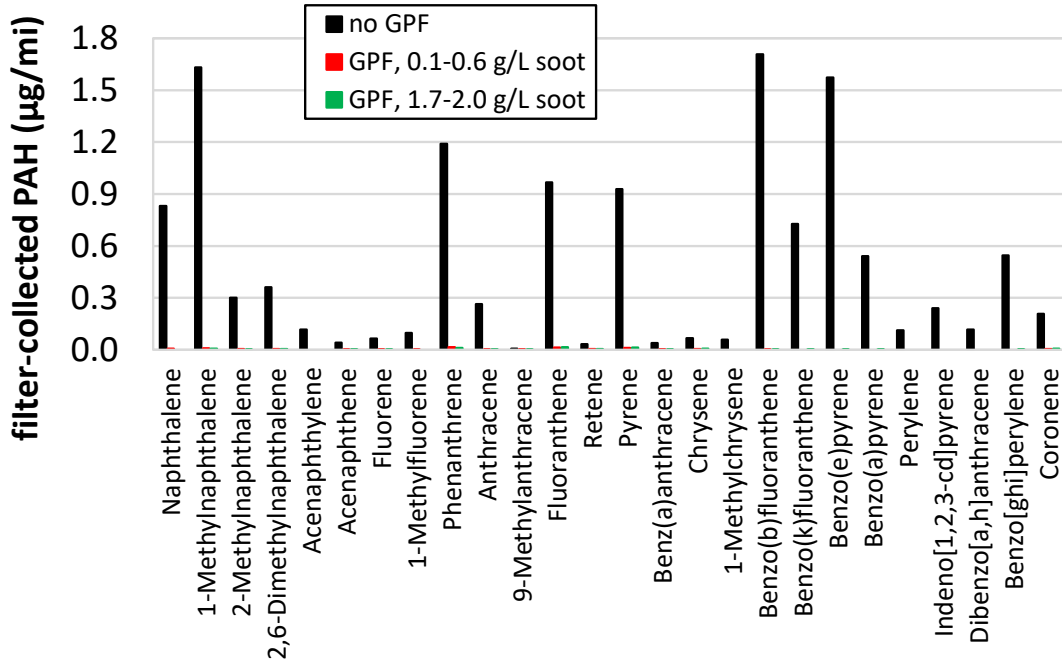
PAH emissions reductions are shown in Figure 3-23. Measurements were performed with the GPF in lightly loaded state (0.1-0.6 g/L soot loading) and in a heavily loaded state (1.7-2.0 g/L soot loading). Filter-collected PAH emissions (those collected by the PM sampling filter) were reduced by over 99 percent and gas-phase PAH emissions (those passing through the PM sampling filter) were reduced by about 55 percent. The percentage reduction in gas-phase PAH emissions may be less for bare GPFs.



**Figure 3-23: Composite cycle PAH reduction at low and high GPF soot loading. Sum of 26 filter collected PAHs shown on the left and sum of 26 gas phase PAHs shown on the right.**

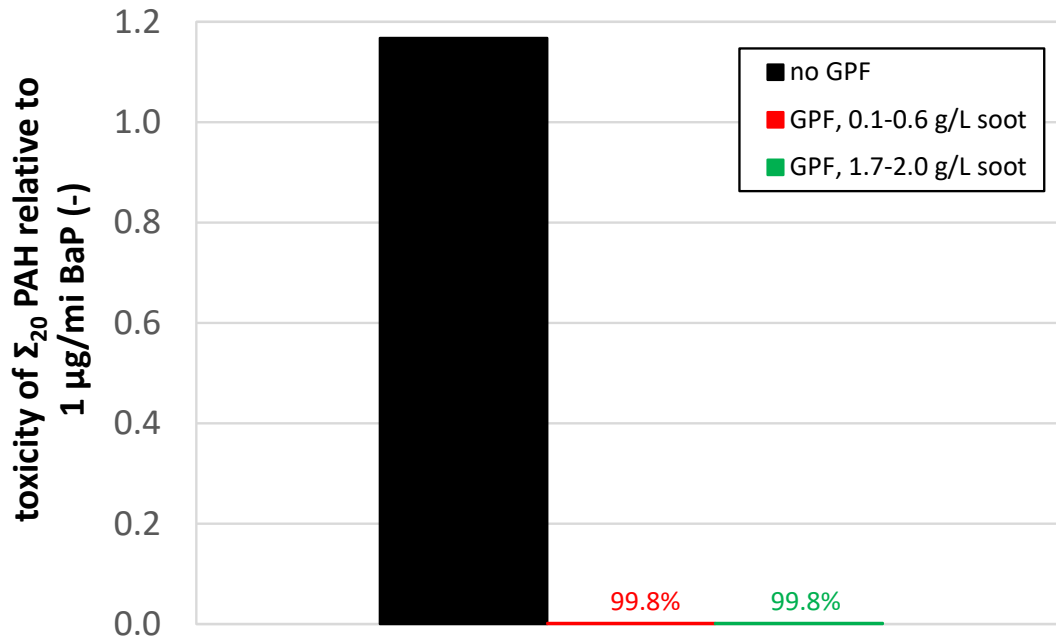
As shown in Figure 3-24, speciated filter-collected PAHs ranged from 2-ring naphthalene to 7-ring coronene for no GPF and GPF test cases. High rates of PAH reduction were seen across all 26 PAHs.





**Figure 3-24: Filter-collected PAH emissions rates with no GPF, lightly loaded GPF, and heavily loaded GPF.**

Composite cycle cancer potency weighted toxicity of 20 filter-collected PAHs for which cancer toxicities are quantified by the EPA 2014 National Toxics Assessment (U.S. EPA 2018) was reduced by 99.8 percent (Figure 3-25).

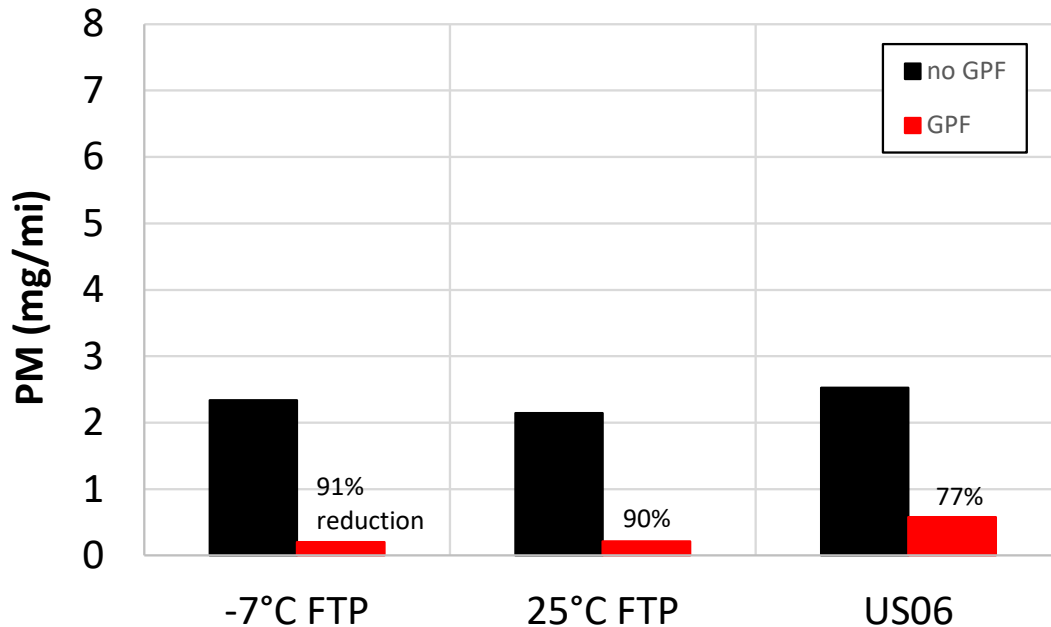


**Figure 3-25: Cancer potency weighted toxicity of 20 filter-collected PAHs with no GPF, lightly loaded GPF, and heavily loaded GPF.**

### **3.2.6.2.3 Cycle-Specific Reduction in PM Mass Emissions from GPF Application to Three Vehicles**

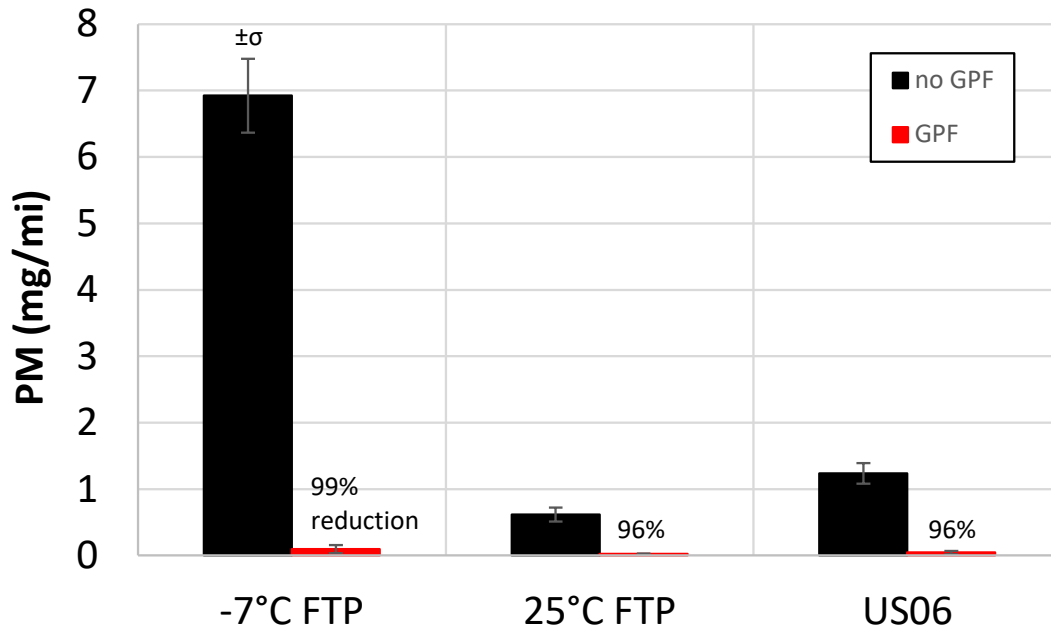
Reductions in cycle-specific PM mass emissions resulting from the adoption of GPF technology is discussed in this subsection. Three vehicle examples are presented: a MY 2019 F150 5.0L, a MY 2021 F150 HEV 3.5L Powerboost, and MY 2022 F250 7.3L.

The first test vehicle is a MY 2019 F150 5.0L that was tested stock and with a MY 2019 European Ford Mustang 5.0L aftertreatment system. PM emissions are shown in Figure 3-26. This GPF system reduced PM emissions by 91 percent, 90 percent, and 77 percent in the  $-7^{\circ}\text{C}$  FTP,  $25^{\circ}\text{C}$  FTP, and US06 cycles, respectively. The testing was conducted with the GPFs in a lightly loaded state. The lightly loaded state was achieved by running a sawtooth GPF regeneration cycle after several tests were completed. The sawtooth cycle used a series of vehicle accelerations to raise the GPF to high temperature, each followed by a DFCO to provide the GPF with oxygen for oxidizing stored PM. Older technology GPFs like the one used in on this test have lower filtration efficiency at low soot loading than newer GPFs used on the other two test vehicles subsequently described in this subsection. Figure 3-26 shows that filtration efficiency was lowest in the US06, which was caused by the passive regeneration that occurs in this cycle. Additional details of the vehicle and GPFs are provided in Chapter 3.2.6.2.1.



**Figure 3-26: PM emissions from a MY 2019 F150, with and without a MY 2019 GPF.**

The second test vehicle is a MY 2021 F150 HEV Powerboost that was tested with and without a MY 2022 bare underfloor GPF. PM emissions are shown in Figure 3-27. The MY 2022 GPF reduced PM emissions by 99 percent, 96 percent, and 96 percent in the -7°C FTP, 25°C FTP, and US06 cycles, respectively. The GPF was fully regenerated immediately before each day of testing using a sawtooth GPF regeneration cycle. The GPF results shown here are worst case with respect to PM filtration because testing was preceded by a full GPF regeneration, so the GPF was evaluated with almost no soot. Filtration efficiency of the MY 2022 GPF was significantly higher than what was achieved with the MY 2019 GPF shown in Figure 3-26, especially in the US06. Additional details of the vehicle and GPFs are provided in Chapter 3.2.6.2.1.

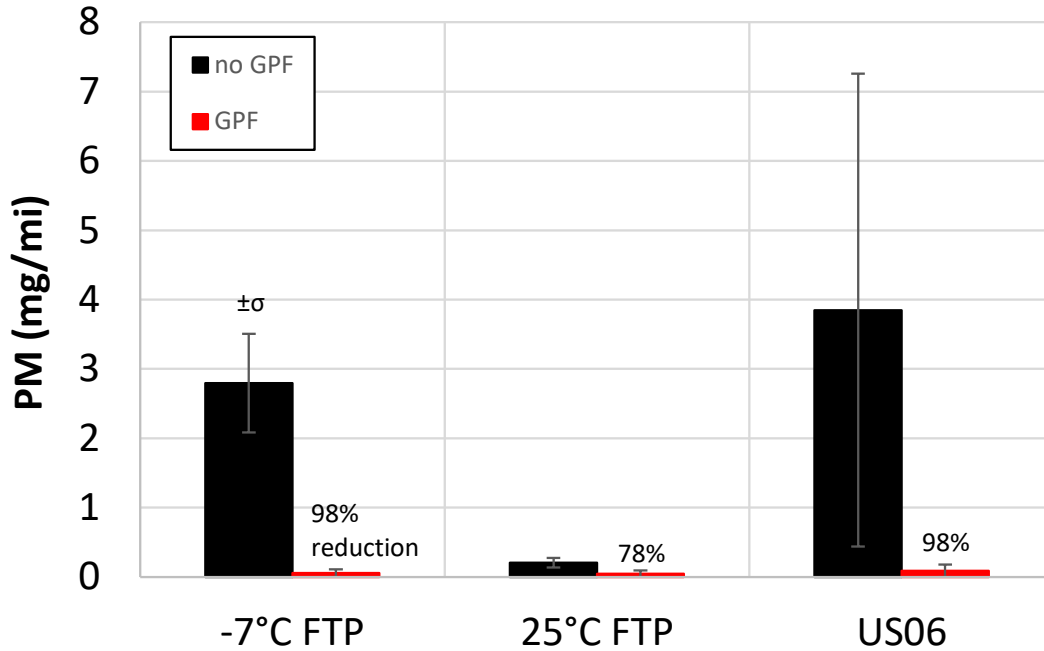


**Figure 3-27: PM emissions from a MY 2021 F150 HEV, with and without a MY 2022 GPF.**

The third test vehicle is a MY 2022 F250 7.3L that was retrofit with two MY 2022 GPFs, one for each engine bank. PM emissions are shown in Figure 3-28. The MY 2022 GPFs reduced PM emissions by 98 percent, 78 percent, and 98 percent in the -7°C FTP, 25°C FTP, and US06 cycles, respectively. The GPF was fully regenerated immediately before each day of testing using a sawtooth GPF regeneration cycle. The GPF results shown are worst case with respect to PM filtration because testing was preceded by a full GPF regeneration, so the GPF was tested with almost no soot.

Filtration efficiency of the MY 2022 GPFs on the MY 2022 F250 was nearly identical to the filtration efficiency of the MY 2022 GPF on the MY 2021 F150 HEV in the -7°C FTP and US06 cycles. Filtration efficiency in the 25°C FTP test was higher on the MY 2021 F150 HEV than on the MY 2022 F250, but the extremely low GPF-equipped levels of PM, around 0.04 to 0.06 mg/mi makes precise PM mass measurements more challenging.

Tailpipe PM was significantly lower with the MY 2022 GPFs as compared to the MY 2019 GPF, especially in the US06 cycle where passive GPF regeneration occurs. Additional details of the vehicle and GPFs are provided in Chapter 3.2.6.2.1.



**Figure 3-28: PM emissions from a MY 2022 F250, with and without MY 2022 GPFs.**

#### **3.2.6.2.4 Laboratory Round Robin Reproducibility**

Two test vehicles were tested by all three organizations in a round robin test program. The MY 2021 Ford F150 HEV was tested with a MY 2022 GPF and the MY 2021 Toyota Corolla 2.0L was tested stock without a GPF. Vehicle and GPF details are described in Chapter 3.2.6.2.1. Laboratory-specific PM measurements are shown for the 2021 F150 HEV with GPF in Figure 3-29 and for the 2021 Corolla without GPF in Figure 3-30, for three test cycles (-7°C FTP, 25°C FTP, US06).

The 2021 F150 HEV with GPF easily meets the 0.5 mg/mi standard across all three test cycles at all three organizations with a significant compliance margin, even though the results are not background corrected although that is allowed by the CFR, and GPF tests were performed with little or no soot on the GPF by running a sawtooth prep cycle as described in Chapter 3.2.6.2.1. Test-to-test and lab-to-lab variability is evident, but the PM averages and variations are sufficiently low relative to the final 0.5 mg/mi standard to allow robust compliance of the 2021 F150 HEV with 2022 GPF in any of the labs and across all three test cycles.

The 2021 Corolla without GPF meets the 0.5 mg/mi standard in most but not all of the 25°C FTP and US06 testing and fails the standard in the -7°C FTP in every test and every lab. The PFDI engine achieves low PM in most of the two warm tests but the cold temperature of the -7°C FTP results in dramatically elevated PM. The next section (Chapter 3.2.6.3) discusses elevated PM from the -7°C FTP test.

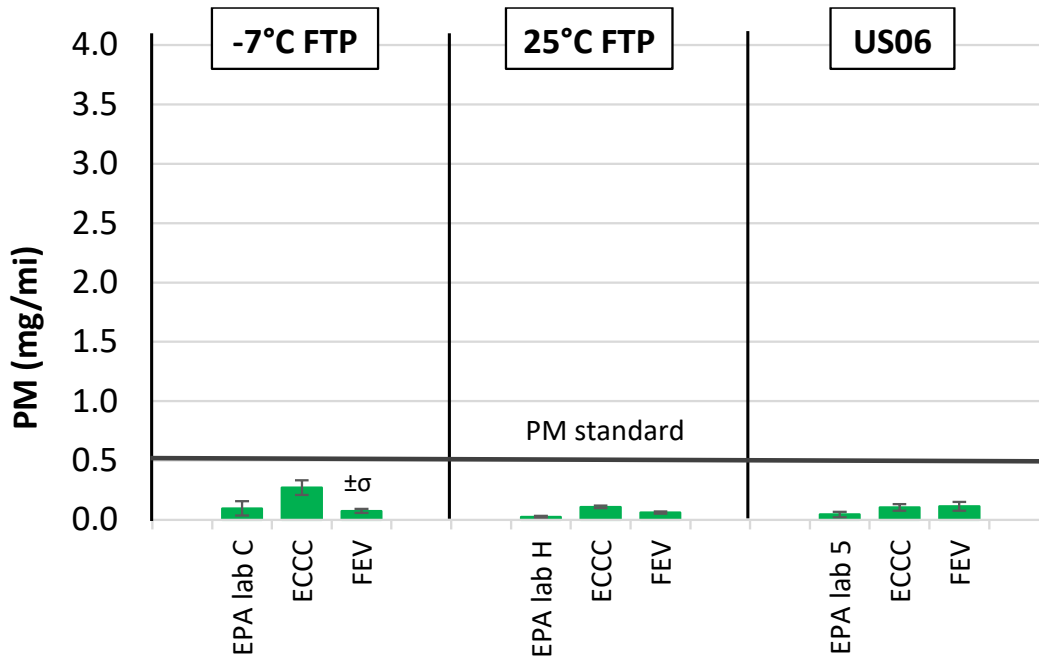


Figure 3-29: Test-to-test and lab-to-lab variability for 2021 F150 HEV with 2022 GPF.

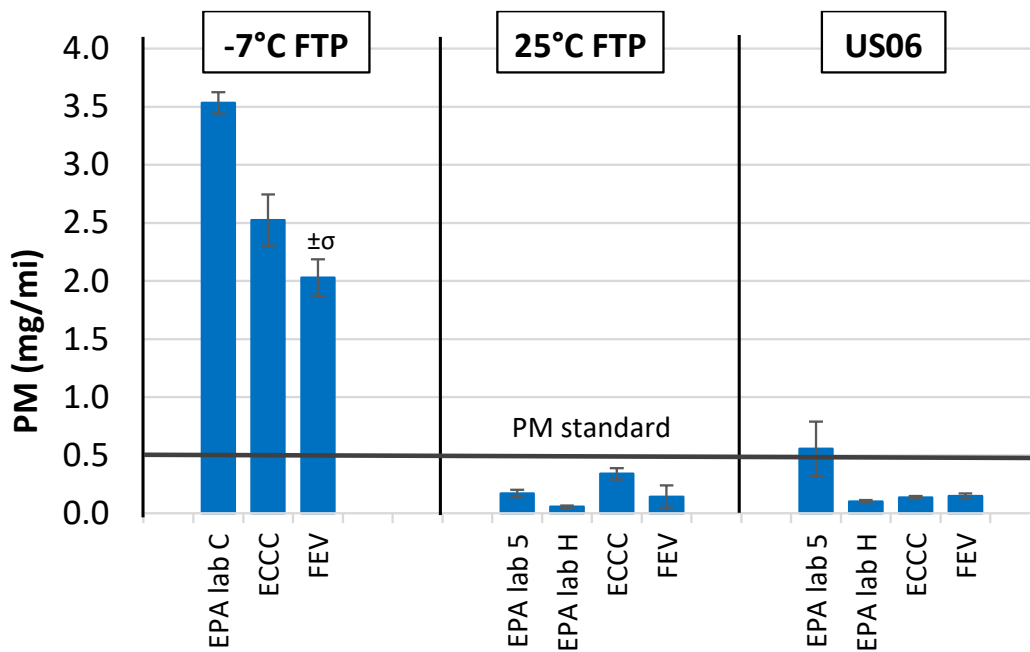


Figure 3-30: Test-to-test and lab-to-lab variability for 2021 Corolla.

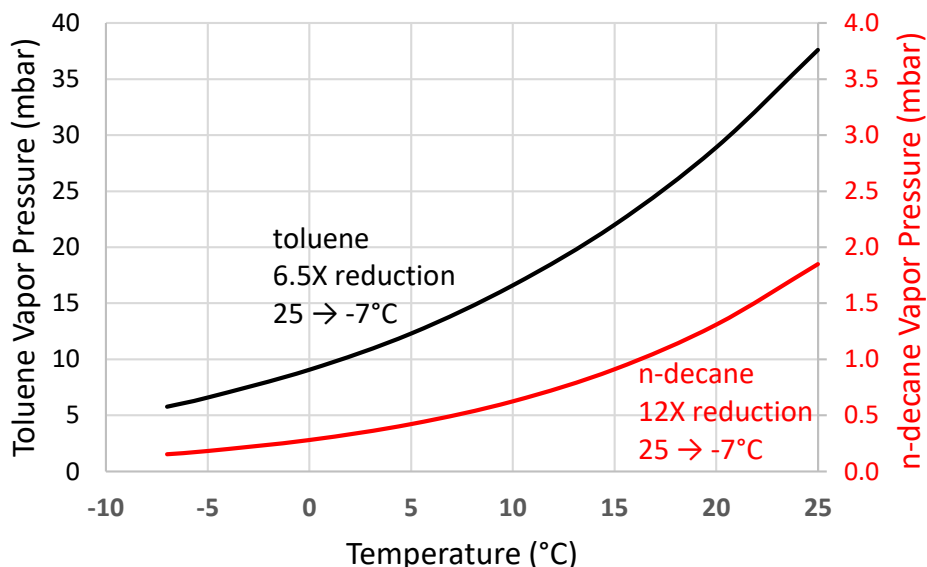
### 3.2.6.3 Importance of Test Cycles

The -7°C FTP test is crucial to the PM standard because it addresses uncontrolled cold PM emissions in Tier 3 and -7°C is an important real-world temperature common through much of the United States during winter months. Also, absent the -7°C FTP test, vehicles would not

achieve PM reductions commensurate with what GPF technology offers across a wide range of operating conditions. Without the -7°C FTP test cycle, vehicles would not have low PM under all operating conditions.

Based on EPA testing, PM emissions in the -7°C FTP are significantly higher than those demonstrated during a 25°C FTP test (e.g., Figure 3-26, Figure 3-27, Figure 3-28, and the first two figures in Section III.D.3 of the preamble). In addition to controlling cold weather PM emissions that were uncontrolled in Tier 3, the -7°C FTP test differentiates Tier 3 levels of PM from GPF-level PM.

PM is elevated in the -7°C FTP test because heavy species in gasoline have very low vapor pressure at cold temperatures, making them difficult to vaporize on cold engine surfaces. For example, as shown in Figure 3-31, the vapor pressure of toluene and n-decane, two representative heavy species of gasoline, are reduced by 6.5X and 12X, respectively, as temperature decreases from 25° to -7°C. Early examples of peer-reviewed literature showing cold ambient temperature (including -7°C) increases PM mass and solid PN from a GPF-equipped vehicle include (T. W. Chan 2013) and (T. W. Chan 2014).



**Figure 3-31: Vapor pressure of toluene and n-decane as a function of temperature.**

The 25°C FTP test is retained from prior standards because it ensures that vehicles are designed and calibrated to operate clean over a range of ambient temperatures. The US06 test is important because 1) it represents higher load real-world driving, and 2) it ensures low tailpipe PM during and after a GPF regeneration, when GPF soot loading is low and makes PM filtration more challenging. The relatively poor filtration of earlier GPF designs during and immediately after regeneration, e.g., in a US06 cycle, has been discussed in the literature, e.g., (T. W. Chan 2016).

In sum, requiring 0.5 mg/mi or lower PM in the -7°C FTP, 25°C FTP, and US06 test cycles ensures that a vehicle has good PM control over the broadest area of vehicle operation and environmental conditions.

In Tier 3, most Class 2b vehicles used the US06 cycle in the HD-SFTP, while low power to weight Class 2b vehicles and Class 3 vehicles used the LA92 cycle in the HD-SFTP. The final PM standard requires all light-duty vehicles and MDV to certify using the same cycles: -7°C FTP, 25°C FTP, and US06. Requiring the US06 for all Class 2b and 3 vehicles ensures that some GPF regeneration occurs during the test cycle and ensures high GPF filtration under all operating conditions, even during and after a GPF regeneration. Without the US06 test, GPF regeneration may not occur during certification test cycles, allowing high PM emissions during high load operation such as trailer towing. If a Class 2b/3 vehicle is unable to follow the US06 trace, it must be driven at maximum effort.

#### **3.2.6.4 GPF Cost**

An updated GPF cost model was developed for the FRM to estimate direct manufacturing cost (DMC) of a bare GPF and associated hardware in the exhaust system of a gasoline-powered light-duty vehicle or MDV where the GPF is installed downstream of the TWCs in its own aftertreatment enclosure (can). The FRM GPF cost model has been incorporated in the OMEGA model.

A bare GPF installed downstream of the TWCs may have higher DMC than a catalyzed GPF that replaces a TWC because the bare downstream GPF requires an additional substrate, substrate matting, and can. However, some or all of the additional DMC of a bare downstream GPF may be offset by enabling a reduction in total precious metal content because the precious metal content can all be used on the lower heat capacity walls of the TWCs that warm up faster after an engine start. Overall, it is believed that the FRM GPF cost model estimates a DMC that is either slightly higher or similar to the DMC of a catalyzed GPF that replaces a TWC.

Indirect costs (IC), including R&D and markup, are separately calculated by OMEGA. OMEGA estimates the IC of a bare downstream GPF in the same way as it does for other emissions control components, so these ICs are not included in the FRM GPF DMC model discussed below.

The FRM GPF DMC model is based on an ICCT GPF cost analysis for a bare "stand-alone" GPF (Minjares and Sanchez 2011) and includes several updates and changes. The DMC model considers costs for the GPF substrate, housing, accessories, pressure sensor, labor and overhead, machinery, and warranty. The GPF DMC model uses a GPF swept volume ratio (GPF volume to engine volume) of 0.80 as compared to a 0.55 swept volume ratio used in the NPRM GPF DMC model and in the 2011 ICCT GPF cost analysis. The larger swept volume ratio is based on an updated EPA GPF/vehicle database, input from a GPF supplier, and an ICCT PM/GPF fact sheet (Isenstadt 2023). The swept volume ratio of 0.80 is representative and falls between that of a European 2019 Ford Mustang (0.46) and a European 2023 VW T-Roc (0.93).

Substrate and housing costs scale with GPF volume. The substrate cost in the 2011 ICCT analysis is reduced by 30 percent (from 30 \$/literGPF to 21 \$/literGPF) based on information from substrate suppliers and reflects manufacturing learning. Accessories, pressure sensor, labor and 40 percent overhead, and machinery costs are a fixed dollar amount per vehicle (\$39.58 in 2011 dollars). Warranty costs are 3 percent of all the above-mentioned costs. A production volume discount of 20 percent is then applied, and finally, total cost is converted from 2011 to 2022 dollars (multiplier of 1.296).



Results from the FRM GPF DMC model are shown in Figure 3-32 for engines ranging from 1.0 to 7.0 using GPFs with swept volume ratios of 0.80 (representative ratio used in FRM OMEGA analysis), 0.46 (a low swept volume ratio used by the 2019 Mustang), and 0.93 (a high swept volume used by the 2023 T-Roc).

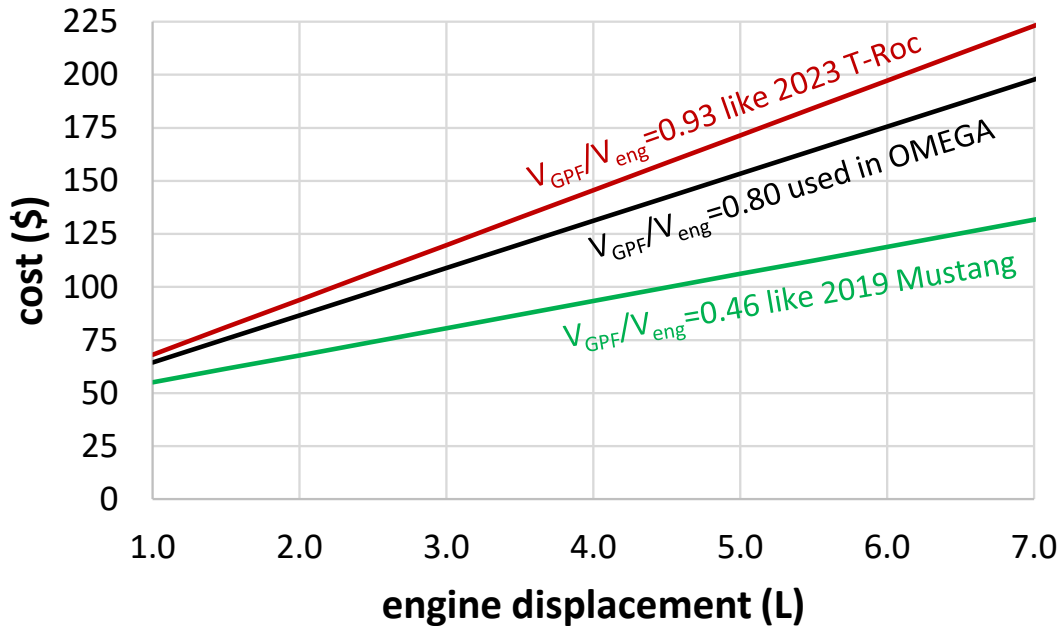


Figure 3-32: GPF direct manufacturing cost estimates.

### 3.2.6.5 GPF Impact on CO<sub>2</sub> Emissions

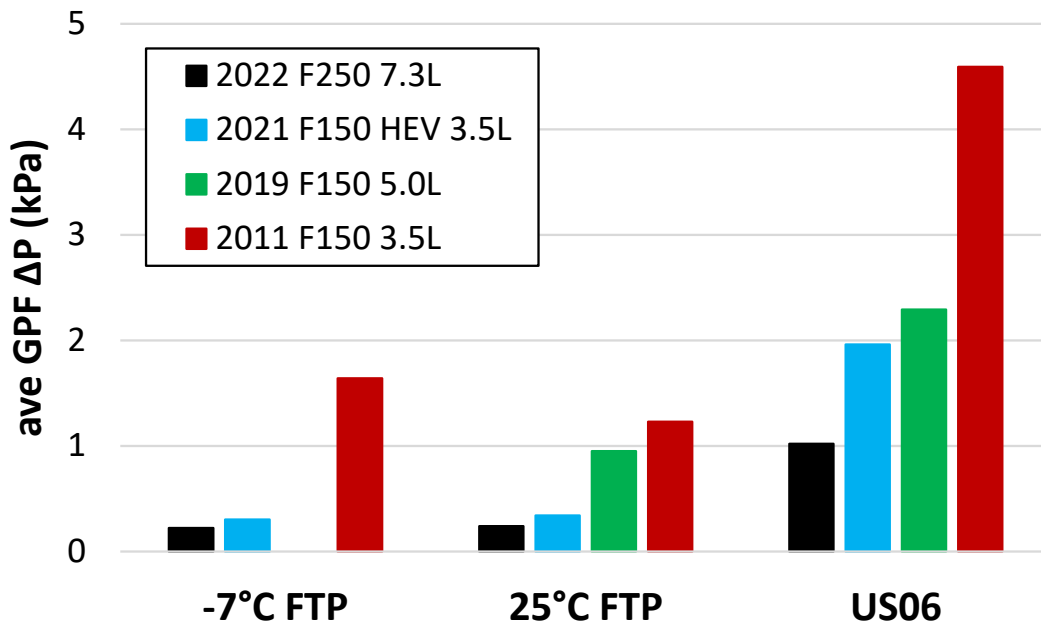
Integrating GPF technology into vehicle aftertreatment systems has the potential to increase CO<sub>2</sub> emissions (energy use) in two ways: during active GPF regeneration, and from increased backpressure. Active regeneration can increase CO<sub>2</sub> emissions while the engine burns more fuel to add heat to the exhaust gas. However, based on discussions with vehicle manufacturers and GPF suppliers, and supported by testing conducted by EPA, most production vehicles will rarely or never need to use active GPF regeneration because systems with close-coupled GPFs or underfloor GPFs with insulated exhaust pipes (e.g., double wall) naturally cause sufficiently high GPF temperature for passive GPF regeneration. Increased CO<sub>2</sub> due to active regeneration is therefore considered negligible in this analysis. The following discusses the effect of GPF backpressure on CO<sub>2</sub> emissions.

GPF pressure drop (i.e., backpressure) and CO<sub>2</sub> increase were measured on four test vehicles across three test cycles (-7°C FTP, 25°C FTP, US06) presents a summary of key vehicle and GPF specifications. Additional vehicle details are provided in Chapter 3.2.6.2.1.

**Table 3-22: Vehicle and GPF specifications.**

|                                      | MY2022<br>F250 7.3L  | MY2021 F150 3.5L<br>Powerboost HEV | MY2019<br>F150 5.0L     | MY2011<br>3.5L Ecoboost |
|--------------------------------------|----------------------|------------------------------------|-------------------------|-------------------------|
| GPF model year                       | 2022                 | 2022                               | 2019                    | 2019                    |
| GPF type and location                | bare underfloor      | bare underfloor                    | catalyzed close-coupled | catalyzed underfloor    |
| GPF size (L)                         | 6.42 (total for two) | 3.21                               | 2.30 (total for two)    | 1.65                    |
| GPF volume / engine displacement (-) | 0.88                 | 0.92                               | 0.46                    | 0.47                    |
| GPF volume / ave US06 power (L/kW)   | 0.199                | 0.115                              | 0.107                   | 0.065                   |
| GPF $\phi$ x L (in)                  | 6.443 x 6 (each)     | 6.443 x 6                          | 5.2 x 3.3 (each)        | 5.66 x 4                |
| GPF cell density (cpsi)              | 200                  | 200                                | 300                     | 300                     |
| GPF wall thickness (mil)             | 8                    | 8                                  | 12                      | 12                      |

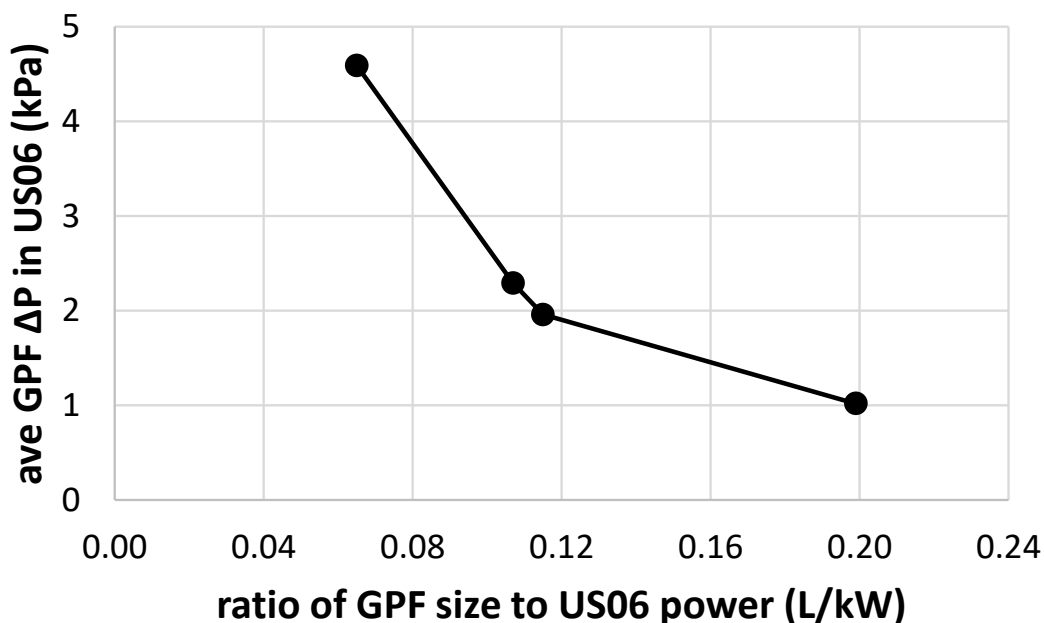
Average GPF pressure drop for each test cycle and vehicle is shown in Figure 3-33. Average GPF pressure drop is highest in the US06 because this cycle demands the highest average power and has the highest average exhaust flow rate. Average GPF pressure drop is similar for the -7°C FTP and 25°C FTP because these cycles use the same drive trace. The 2011 F150 showed slightly higher GPF pressure drop in the -7°C FTP as compared to the 25°C FTP, presumably because powertrain friction increases at cold temperatures before the powertrain warms up. Figure 3-33 does not show GPF pressure drop for the 2019 F150 because the GPF differential pressure sensor was installed on this vehicle after -7°C FTP testing was conducted.



**Figure 3-33: Cycle-average GPF pressure drop as a function of test cycle.**

Figure 3-34 shows GPF pressure drop in the US06 decreases asymptotically as the ratio of GPF volume to average US06 power increases. Larger GPF volume provides more GPF wall area for exhaust flow, and lower average US06 power results in reduced exhaust flow volume (due to reduced exhaust mass flow and lower exhaust temperature).

The results shown in Figure 3-33 and GPF volume to average US06 power tabulated in Table 3-22 demonstrate how for each test cycle (-7°C FTP, 25°C FTP, US06), average GPF pressure drop increases with decreasing ratio of GPF volume to average power in the US06. Based on a review of several European GPF-equipped production vehicles and discussions with GPF suppliers, GPF volumes of the 2022 F250 and the 2021 F150 HEV are within typical production ranges for these vehicles, while GPF volumes of the 2019 F150 and 2011 F150 are relatively small for these vehicles, despite the GPF system on the 2019 F150 test vehicle coming from a European 2019 series production Mustang that uses the same engine displacement as the 2019 F150 test vehicle.



**Figure 3-34: Cycle-average GPF pressure drop as a function of the ratio of GPF size to average power required to drive US06 cycle.**

Higher GPF pressure drop increases the work that an engine must do to expel exhaust gas through the exhaust system. To maintain commanded power to follow a drive trace, the throttle is opened more, and this reduces intake pumping loss, partially offsetting the increased exhaust pumping work. The net effect is expected to be a slight reduction in brake thermal efficiency and a slight increase in CO<sub>2</sub> emissions. A more detailed discussion of intake pumping loss partially offsetting exhaust pumping work can be found in (Bohac and Ludlam, Characterization of a Lightly Loaded Underfloor Catalyzed Gasoline Particulate Filter in a Turbocharged Light Duty Truck 2023).

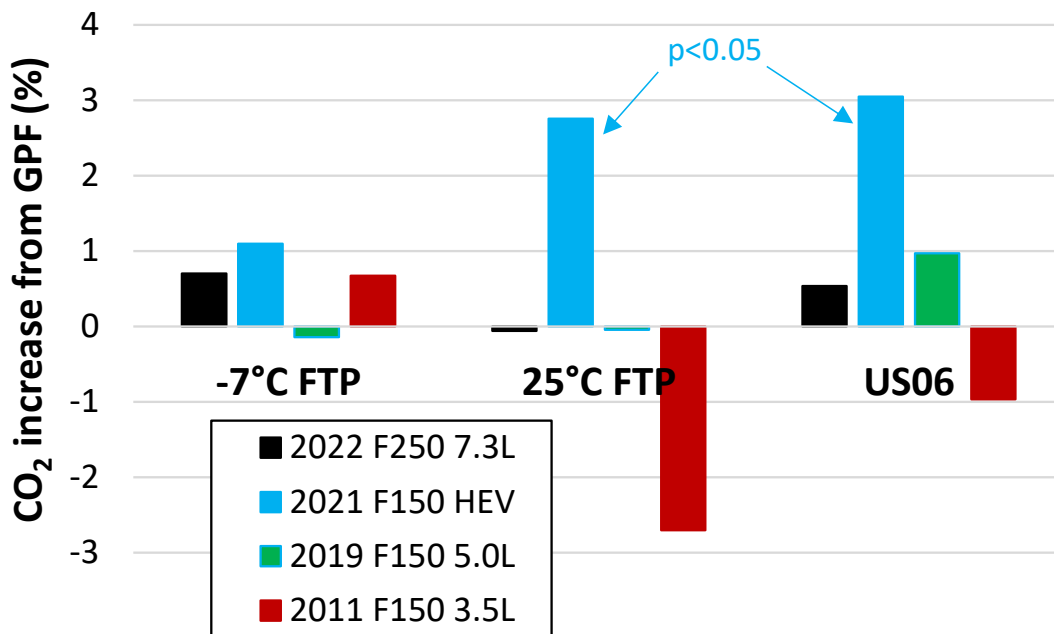
Table 3-23 shows the change in measured CO<sub>2</sub> emissions for each test cycle when GPFs were added, when results are averaged across the four test vehicles. Averaging across four test

vehicles results in CO<sub>2</sub> increases between 0.0 percent for the 25°C FTP and 0.9 percent for the US06. Since two of the test vehicles were equipped with relatively undersized GPFs, these average CO<sub>2</sub> increases are likely higher than on production vehicles with typical GPF volumes.

Figure 3-35 breaks down the increase in CO<sub>2</sub> emissions that was averaged across the four test vehicles, on a vehicle and test cycle basis. Doing so results in more data scatter, resulting in only the two light blue bars indicated being statistically significant to 95% confidence.

**Table 3-23: Change in measured CO<sub>2</sub> emissions for each test cycle when GPFs are added, averaged across four test vehicles (2022 F250, 2021 F150 HEV, 2019 F150, 2011 F150).**

| Test Cycle | CO <sub>2</sub> Increase (%) |
|------------|------------------------------|
| -7°C FTP   | 0.6                          |
| 25°C FTP   | 0.0                          |
| US06       | 0.9                          |



**Figure 3-35: CO<sub>2</sub> increase caused by added GPF. Only the two light blue bars indicated are statistically significant to 95% confidence (p<0.05).**

Considering the analyses summarized in Table 3-23 and Figure 3-35, it is estimated that integrating GPFs into vehicle aftertreatment systems causes less than 1 percent increase in CO<sub>2</sub> emissions in the -7°C FTP, 25°C FTP and US06 cycles.

### **3.2.7 Refueling Standards for Incomplete Spark-Ignition Vehicles**

The agency is adopting a requirement for incomplete medium-duty vehicles to meet the same on-board refueling vapor recovery (ORVR) standards that currently apply for complete vehicles. Incomplete vehicles have not been required to comply with the ORVR requirements because of the potential complexity of their fuel systems, primarily the filler neck and fuel tank. Unlike complete vehicles, which have permanent fuel system designs that are fully integrated into the

vehicle structure at time of original construction by manufacturers, it was believed that incomplete vehicles may need to change or modify some fuel system components during final assembly by secondary manufacturers. For this reason, it was determined that ORVR might introduce a complexity for the upfitters that is unnecessarily burdensome.

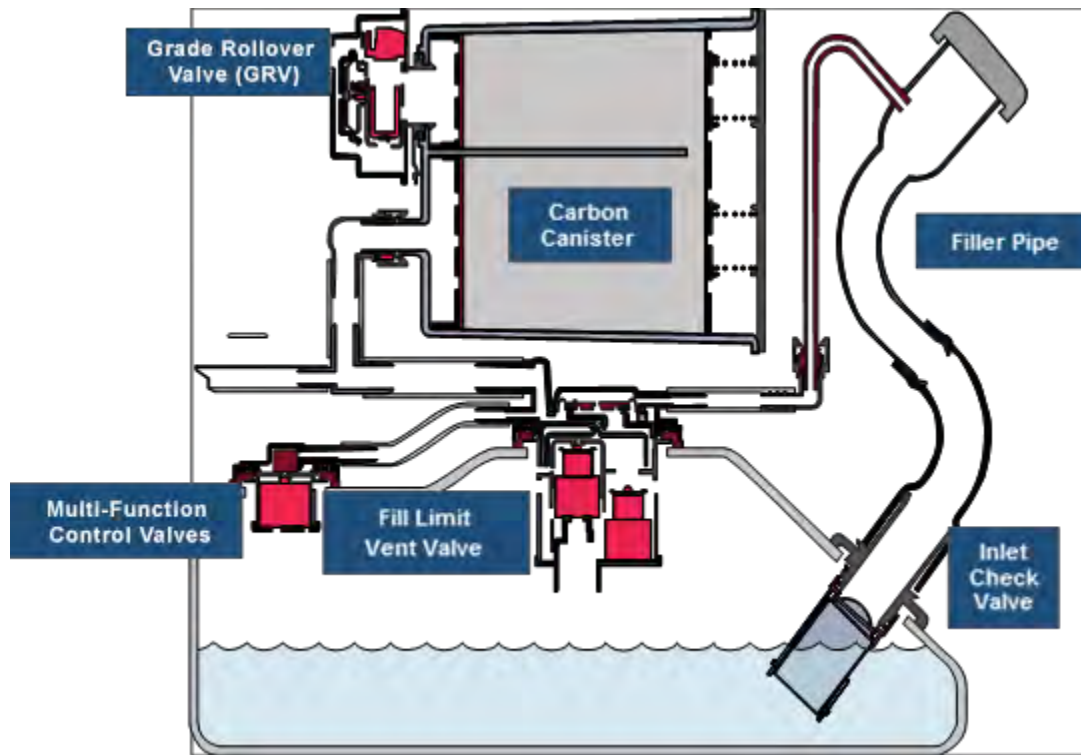
In observations by the agency of current ORVR-equipped vehicles and their incomplete versions, the agency believes that the fuel system designs are almost identical with only the ORVR components removed for the incomplete version. The complete and incomplete vehicles appear to share the same fuel tanks, lines, and filler tubes. Extensive differences between the original manufacturer's designs and the upfitter modifications to the fuel system, while expected, have not been observed. This supports the conclusion that almost all incomplete vehicles can comply with the same ORVR standards as complete vehicles, with the addition of the same ORVR components that are already installed on counterpart complete vehicles.

In current practice, manufacturers of the original incomplete vehicles identify certain modifications of the fuel system that are not allowed by the upfitter. This is because the incomplete vehicle manufacturer is responsible for all current evaporative requirements (2-day, 3-day, running loss, etc.) and almost any modification to the fuel system could compromise compliance with those program standards. There is also an aspect of compliance with crash and safety requirements that prevent upfitters from making changes to the fuel system components. For these reasons, with rare exception, the fuel system design and installation are completed by the original vehicle manufacturer. The exception that the agency observed is that some incomplete vehicles do not have the filler tube permanently mounted to a body structure until the upfitter adds the finishing body hardware (i.e.; flatbed, box). In these cases, the upfitter is limited to only attaching the filler tube to the added structure, but they must maintain the original manufacturer design specifications that are part of the certified configuration for meeting EPA evaporative emission standards.

### **3.2.7.1 Technologies to Address Evaporative and Refueling Emissions**

As exhaust emissions from gasoline engines continue to decrease, evaporative emissions become an increasingly significant contribution to overall HC emissions from gasoline-fueled vehicles. Opportunity exists to extend the usage of the refueling evaporative emission control technologies already implemented in complete medium-duty gasoline vehicles to the counterpart incomplete gasoline vehicles. The primary technology we are considering is the addition of ORVR, which was first introduced to the chassis-certified light-duty and medium-duty applications beginning in MY 2000. See 65 FR 6698 (Feb. 10, 2000). An ORVR system includes a carbon canister, which is an effective technology designed to capture HC emissions during refueling events when liquid gasoline displaces HC vapors present in the vehicle's fuel tank during refueling. Instead of releasing the HC vapors into the ambient air, ORVR systems recover these HC vapors and store them for later use as fuel to operate the engine.

The fuel systems on incomplete medium-duty gasoline vehicles are very similar to those on complete medium-duty vehicles that are already required to incorporate ORVR. Fuel tanks on these incomplete vehicles are almost always identical to the fuel tanks on counterpart complete vehicles. There may be occasional optional larger fuel tanks requiring a greater ORVR system storage capacity, and possibly some unique accommodations for dual tanks (e.g., separate fuel filler locations), but we expect they will maintain a similar design. Figure 3-36 presents a schematic of a standard ORVR system.



**Figure 3-36: Schematic of an ORVR system<sup>28</sup>.**

### 3.2.7.2 Filler Pipe and Seal

In an ORVR system, the design of the filler pipe connecting the nozzle entry to the fuel tank is integral to how fuel vapors displaced during a fuel fill will be handled. The filler pipe is typically sized to handle the maximum allowable fill rate of liquid fuel while also integrating either a mechanical or liquid seal to prevent fuel vapors from exiting through the filler pipe to the atmosphere. A dual fuel tank chassis configuration may require a separate filler pipe and seal for each fuel tank.

The mechanical seal is typically located at the top of the filler neck where the fuel nozzle is inserted. The hardware piece forms a seal against the fuel nozzle by using some form of a flexible material, usually plastic, that makes direct contact with the fuel nozzle to prevent fuel vapors from exiting the filler pipe as liquid fuel is pumped into the fuel tank. In the case of capless systems, this seal may be integrated into the spring-loaded seal door that opens when the nozzle is inserted. There are concerns with a mechanical seal's durability due to wear over time, and its ability to maintain a proper seal with unknown nozzle integrity and variations outside of design tolerances.

Liquid seals depend on the shape of the filler pipe to be continuously full across the full diameter of the filler pipe, either inside the fuel tank or close to the fuel tank entry. The liquid

<sup>28</sup> Stant ORVR System <http://stant.com/orvr/orvr-systems/>

seal prevents fuel vapors from escaping up and out through the filler pipe. By creating a column of liquid fuel in the filler pipe, the liquid seal does not require a mechanical contact point with the fill nozzle to prevent escape of vapors. The liquid seal has been the predominant sealing method implemented in the regulated fleet in response to the ORVR requirements.

### **3.2.7.3 ORVR Flow Control Valve**

As described above, the sealing of the filler pipe prevents the fuel vapors from escaping into the ambient air; however, the fuel vapors that are displaced by the incoming liquid fuel need to be routed to the canister. To properly manage the large volume of vapors during refueling, most ORVR systems have implemented a flow control valve that senses when the fuel tank is getting filled with fuel and triggers a low-restriction flow path to the canister. This flow path is specifically used only during the refueling operation and is unique in that it provides the ability to quickly move larger volumes of fuel vapors into the tank than is normally required when not refueling. The flow control valve will allow this larger flow volume while refueling, but then return to a more restrictive vapor flow path while driving, while parked for overnight diurnals, and at other times.

The flow control valve is generally a fully mechanical valve system that utilizes connections to the fuel tank and filler pipe to open and close vapor pathways with check valves and check balls and pressure switches via diaphragms. The valve may be integrated into the fuel tank and incorporate other aspects of the fuel handling system ("multi-function control valve" in Figure 3-36) including roll-over valve, fuel and vapor separators to prevent liquid fuel from reaching the canister, and other fuel tank vapor control hardware. Depending on the design, the filler pipe may also be integrated with the flow control valve to provide the necessary pressure signals. A dual fuel tank chassis configuration may require a separate flow control valve for each fuel tank.

### **3.2.7.4 Canister**

The proven technology to capture and store fuel vapors is activated carbon. This technology has been used in vehicles for over 50 years to reduce evaporative emissions from sources such as fuel tanks and carburetors. When ORVR was originally discussed, existing activated carbon technology was determined to be appropriate to capture and store refueling related fuel vapors. This continues to be the case today, as all known ORVR-equipped vehicles utilize some type of activated carbon.

The activated carbon is contained in a canister made from a durable material that can withstand the fuel vapor pressures, vibration, and other durability concerns. For vehicles without ORVR systems, canisters are sized to handle evaporative emissions for the three-day diurnal test with the canister volume based on the fuel tank capacity. A dual fuel tank chassis configuration may require a separate canister for each fuel tank.

### **3.2.7.5 Purge Valve**

The purge valve is the electro-mechanical device used to remove fuel vapors from the fuel tank and canister by routing the vapors to the running engine where they are burned in the combustion chamber. This process displaces some amount of the liquid fuel required from the fuel tank to operate the engine and results in a small fuel savings. The purge valve is controlled by the engine's emission control electronics with the goal of removing the necessary amount of captured fuel vapors from the canister to prepare it for subsequent fuel vapor handling needs of

either the next refueling event or vapors generated from a diurnal event. All on-road vehicles equipped with a canister for evaporative emission control utilize a purge valve. Depending on the design, a dual fuel tank chassis configuration may require a separate purge valve for each fuel tank.

### **3.2.7.6 Design considerations for Unique Fuel Tanks**

Commercial gasoline trucks may incorporate several fuel tank options that require unique ORVR design considerations. While most commercial vehicle fuel tanks are similar to the already ORVR-compliant complete medium-duty vehicles, some commercial vehicles include larger tank sizes (up to 50 gallons) or may have a dual tank option. As described above, the canister sizing will be a function of the required amount of fuel vapor handling during refueling. Larger fuel tanks will require larger canisters with more activated carbon than historically found in other gasoline vehicles. Some design challenges will likely exist in designing the canister system to handle the large vapor volumes while balancing the restriction to flow through the larger canisters.

Dual fuel tank systems, which have very limited availability, may also require some unique design considerations. Typically, the canister is located close to the fuel tank to properly and efficiently manage the refueling fuel vapors. Dual fuel tanks may require duplicate ORVR systems to have the necessary flexibility to manage the refueling vapors, particularly since the fuel tanks are filled independently through separate filler pipe assemblies.

### **3.2.7.7 Onboard Refueling Vapor Recovery Anticipated Costs**

Incomplete medium-duty vehicles are not currently required to meet ORVR. There are four main equipment components and strategies incomplete medium-duty vehicles need to update to implement ORVR: Increased working capacity of the carbon canister to handle additional vapors volumes during refueling, flow control valves to manage vapor flow pathway during refueling, filler pipe and seal to prevent vapors from escaping, and the purge system and management of the additional stored fuel vapors. The associated direct manufacturing costs for these updates are summarized below. No labor cost was identified so the direct manufacturing cost is equal to the piece cost plus tooling cost (per piece). ORVR requirements apply starting in model year 2030 for incomplete medium-duty gasoline vehicles. For our cost analysis, we assumed all gasoline medium-duty vehicles identified as incomplete light heavy-duty trucks in MOVES will have an average fuel tank capacity of 35 gallons.

Capturing the increased vapor volume from the vapor displaced during a refueling event will require canisters to increase working vapor capacity approximately 15 to 40 percent, depending on the fuel tank size and other specifications for individual vehicle systems. Manufacturers can achieve greater working capacity by increasing the canister volume using conventional carbon. A typical evaporative canister has approximately 2.6 liters of conventional carbon to capture overnight diurnal evaporative emissions for a 35-gallon fuel tank. An increase in required capacity to allow for capturing refueling vapors results in the need for an additional 1 liter of conventional carbon. A change in canister volume to accommodate additional carbon includes increased costs for retooling and additional canister plastic material, as well as design considerations to fit the larger canister on the vehicle. However, because these medium-duty vehicles almost always have a complete version already required to comply with refueling



standards, the necessary larger canister sizes are already produced and available, which likely avoids the need for new tooling.

An alternative to retooling for a larger single canister would be to add a second canister for the extra canister volume. Several smaller-volume canisters are available on the market today. Another approach, based on discussions with canister and carbon manufacturers, can be achieved by using a higher adsorption carbon along with modifications to compartmentalization within the existing canister plastic shell that will increase the canister working capacity without requiring a larger canister size.

There are also two primary technologies used to prevent vapors from escaping into the atmosphere through the filler neck and around the fuel nozzle area when the vehicle is refueling that can affect the canister vapor capacity design requirements: A mechanical seal that makes direct physical contact with the refueling nozzle to create a nozzle-to-filler neck seal; or a liquid seal further down in the filler pipe that uses the liquid fuel mass flowing down the filler pipe and entering the tank to hydraulically prevent vapors from migrating back up the fill pipe. There is approximately a 20 percent reduction in activated carbon required for a mechanical seal. While mechanical seals are not currently the preferred technology, manufacturers facing the design options for accommodating larger fuel volumes and the need for a larger matching evaporative canister may opt for a mechanical seal design. We share our assumptions and cost estimates for both seal options in Table 3-24 and Table 3-25. A dual tank may require two seals if dual filler necks are used instead of a single filler neck and transfer pump to move fuel between the two tanks.

The second required equipment update would be to install flow control valves, which may be integrated into existing roll-over/vapor lines. The flow control valves are needed to manage the vapors during the refueling event by providing a low restriction pathway for vapors to enter the canister for adsorption and storage on the carbon materials. We anticipate that vehicles would require on average one valve per vehicle, which would be approximately \$6.50 per valve. A dual tank system may require a flow control valve system per tank depending on the design approach.

Thirdly, as mentioned above, a filler pipe and seal system would be needed for each filler neck to keep the vapors contained during refueling. Manufacturers have the option of a mechanical seal that costs approximately \$10.00 per seal and a liquid seal. The liquid seal is a design feature of the filler neck, which means that it has no direct cost, but it may require hardware modifications to provide enough back pressure to stop the fuel flow when the tank is full. In some cases, incomplete vehicles share the same filler tube design with the refueling requirements compliant complete version, in which case there would again be no cost for upgrading the system to manage automatic shutoff.

Lastly, manufacturers may need to address the engine control of the canister purge rates. This update would include calibration improvements and potentially additional hardware to ensure adequate purge volumes to maintain an appropriate canister state to prepare for further vapor loading from diurnal and subsequent refueling events. However, if the incomplete version shares engines and fuel systems with the complete vehicle, the development of calibrations for the required purge volumes has likely already been completed, eliminating any need for further changes or development work. If required for a dual tank system, an extra purge valve may be needed if the two-tank system maintains independent canisters instead of a single common canister as observed in dual-tank, single canister light-duty applications. Table 3-24 shows our

calculations estimating the amount of extra canister size for conventional carbon for a 35-gallon tank, using Tier 3 core evaporative requirements (i.e., 2-day and 3-day SHED) as a baseline. Currently under Tier 3 requirements the canister and purge strategy are sized for the 3-day diurnal test and designed to meet the Bleed Emission Test Procedure (BETP) requirements. During the diurnal test, the canister is loaded with hydrocarbons over two or three days, allowing the hydrocarbons to load a conventional carbon canister (1500 GWC, gasoline working capacity) at a 70 g/L effectiveness. During a refueling event, which takes place over a few minutes, the vapor from the gas tank is quickly loaded onto the carbon in the canister with an ORVR system, causing the efficiency of the canister loading to drop to 50 g/L effectiveness. Typically, a design safety margin includes an additional 10 percent carbon to ensure adequate performance over the life of the system. Therefore, even though there is typically less fuel vapor mass generated and managed during a refueling event than is generated over a three-day diurnal, the amount of carbon that is necessary to contain the vapor is higher for a refueling event.

**Table 3-24: ORVR Specifications and Assumptions used in the Cost Analysis for Incomplete Medium-Duty Vehicles.**

|  | Tier 3<br>Baseline | ORVR Filler Neck Options |             |
|--|--------------------|--------------------------|-------------|
|  |                    | Mechanical Seal          | Liquid Seal |
|  | Diurnal            | ORVR                     |             |
| Diurnal Heat Build   | 72-96°F            | 80°F                     |             |
| RVP  |                    | 9 psi                    |             |
| Nominal Tank Volume  |                    | 35 gallons               |             |
| Fill Volume  | 40%                | 10% to 100%              |             |
| Air Ingestion Rate   |                    | 0%                       | 13.50%      |
| Mass Vented per heat build, g/d                            | 60                 |                          |             |
| Mass Vented per refueling event                            |                    | 128                      | 158         |
| Hot Soak Vapor Load  | 2.5                |                          |             |
| Mass vented over 48-hour test                              | 114                |                          |             |
| Mass vented over 72-hour test                              | 162                |                          |             |
| 1500 GWC, g/L <sup>a</sup>                                 | 70                 | 50                       | 50          |
| Excess Capacity  | 10%                | 10%                      | 10%         |
| Estimated Canister Volume Requirement, liters <sup>b</sup> |                    |                          |             |
| 48-hour Evaporative only                                   | 1.8                |                          |             |
| 72-hour Evaporative only                                   | 2.5                |                          |             |
| Total of 72-hour + ORVR <sup>c</sup>                       |                    | 2.8                      | 3.5         |

a Efficiency of conventional carbon.  
b Canister Volume = 1.1(mass vented)/ 1500 GWC (Efficiency).  
c ORVR adds .3 liters and 1 liter for Mechanical Seal and Liquid Seal respectively.

**Table 3-25: Estimated Direct Manufacturing Costs for ORVR Over Tier 3 as Baseline.**

|                                       | Liquid Seal  | Mechanical Seal |
|---------------------------------------|--------------|-----------------|
|                                       | New Canister | New Canister    |
| <b>Additional Canister Costs</b>      | \$10         | \$4             |
| <b>Additional Tooling<sup>a</sup></b> | \$0.50       | \$0.50          |
| <b>Flow Control Valves</b>            | \$6.50       | \$6.50          |
| <b>Seal</b>                           | \$0          | \$10            |
| <b>Total<sup>b</sup></b>              | \$17         | \$21            |

a Assumes the retooling costs will be spread over a five-year period.

b Possible additional hardware for spitback requirements. Note that these manufacturing costs do not include a markup representative of Retail Price Equivalent values.

### 3.3 On-board Diagnostics

EPA regulations state that onboard diagnostics (OBD) systems must generally detect malfunctions in the emission control system, store trouble codes corresponding to detected malfunctions, and alert operators appropriately. EPA adopted (as a requirement for an EPA certificate) the 2013 California Air Resources Board (CARB) OBD regulation, with certain additional provisions, clarifications, and exceptions, in the Tier 3 Motor Vehicle Emission and Fuel Standards final rulemaking. 40 CFR 86.1806-17; 79 FR 23414 (Apr. 28, 2014). Since that time, CARB has made several updates to their OBD regulations and continues to consider changes periodically. In this rule, EPA is updating to the latest version of the CARB OBD regulation; California's 2022 OBD-II requirements are part of (Title 13 § 1968.2 California Code of Regulations 2022). This is accomplished by adding a new 40 CFR 86.1806-27 for vehicles built after 2027 model year and only adding requirements to that section that are not in the new CARB regulation.

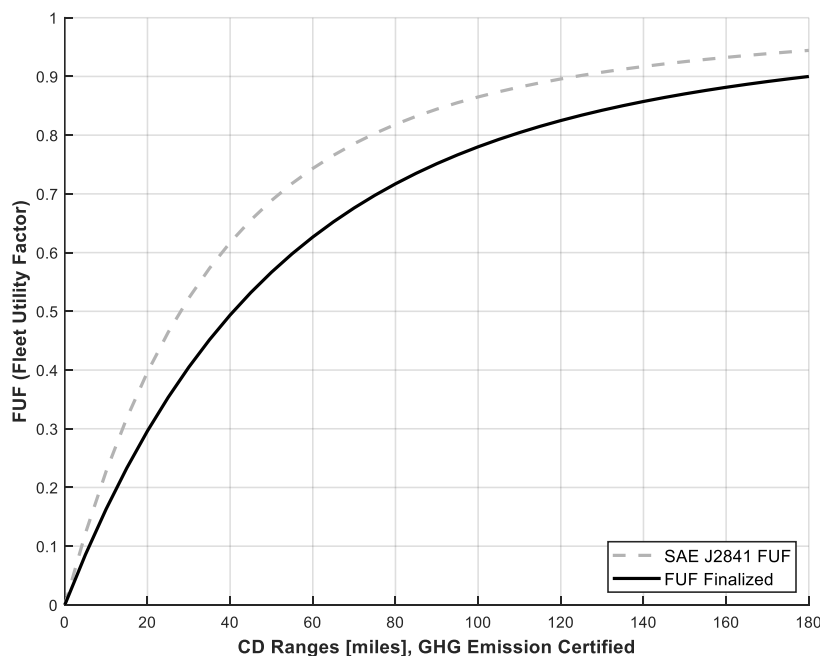
### 3.4 PHEV Accounting

#### 3.4.1 Final Approach for the Revised PHEV Utility Factor

EPA is finalizing its proposed change to the light-duty vehicle PHEV Fleet Utility Factor (FUF) curve used in CO<sub>2</sub> compliance calculations for PHEVs. To address concerns about adequacy of lead time for the early years of the program, we are delaying the application of the revised FUF until MY 2031, as further discussed below in this section.

A fleet utility factor provides a means of accounting for a PHEV's operation using electricity, known as the Charge Depleting Mode with respect to the total mileage that a PHEV travels. The Charge Depleting mode is dependent on two significant factors. The first factor is the size or capacity of the battery. Typically, a PHEV with a larger battery will have more all-electric range, all other vehicle attributes being equal. The second factor is an owner's propensity to charge the battery. SAE J2841 states explicitly that the UF represented in SAE standard assumes that a PHEV is fully charged at least once per day. Recent literature (Aaron Isenstadt, Zifei Yang, Stephanie Searle, John German 2022), (Seshadri Srinivasa Raghavan & Gil Tal 2022) and data (California Air Resource Board [OBD data records] 2023, California Air Resource Board [OBD data records] 2022) have identified that the current utility factor curves overestimate the fraction of driving that occurs in charge depleting operation. Other literature (Aaron Isenstadt, Zifei

Yang, Stephanie Searle, John German 2022), (Seshadri Srinivasa Raghavan & Gil Tal 2022) also concludes that vehicles with lower charge depleting ranges have even greater discrepancy in CO<sub>2</sub> emissions. The current SAE J2841 FUF curve and the finalized FUF curve are shown in Figure 3-37. The finalized FUF curve represents a modest change of about 11 percent from SAE J2841 FUF curve while the averages of FUF values by the SAE J2841 FUF curve are approximately 55 percent higher than those by the "BAR Regression Fit" curve between 0 and 180-mile 2-cycle combined GHG emission-certified CD ranges using November 2023 CARB dataset. In contrast, the labeled ranges are already reduced by 30 percent from 2-cycle combined GHG emission-certified CD ranges for CAFE (Corporate Average Fuel Economy) standards compliance and labeling the all-electric ranges and CD ranges of PHEV vehicle stickers.



**Figure 3-37: SAE J2841 FUF and finalized FUF for PHEV compliance.**

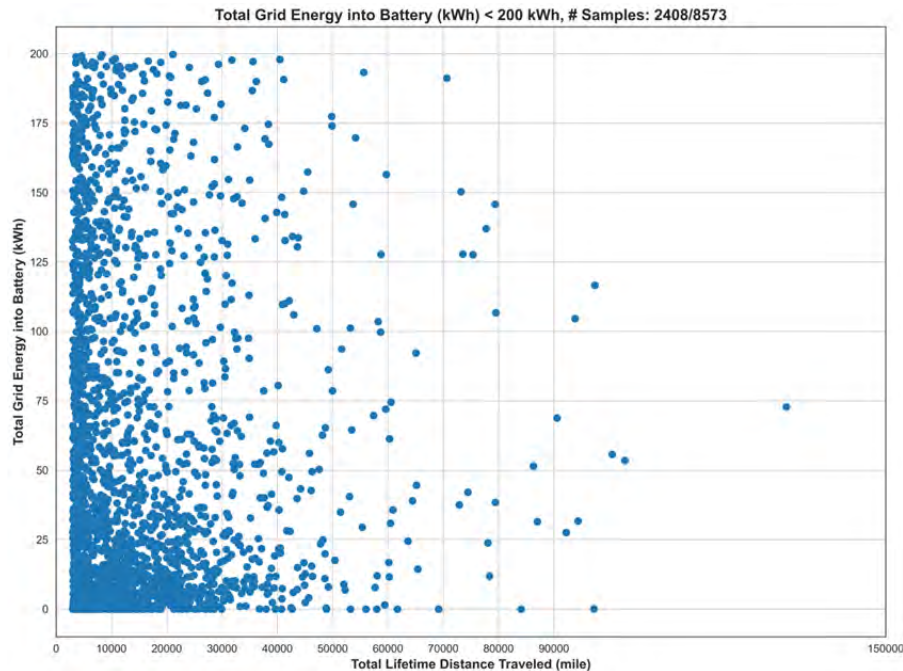
### **3.4.2 Overview of BAR dataset**

The November 2023 CARB BAR OBD PHEV dataset for the finalized FUF curve has approximately 8,800 PHEV vehicles, from 43 PHEV models with 90 PHEV model variants, and over 169.4 million vehicle miles traveled. About 79 percent of PHEV vehicles, representing approximately 140.4 million miles traveled, are from in-state ownership transfers. The remaining 21 percent of PHEV vehicles, representing around 23.1 million miles traveled, are from out-of-state vehicle registrations. The filtered dataset has 42 PHEV models and 89 model variants, and approximately 8,600 individual vehicles that travelled approximately 163.2 million miles. The 42 PHEV models and about 8,600 filtered data points are approximately 98 percent of the 43 PHEV models and about 8,800 vehicles in the unfiltered data.

### 3.4.2.1 Descriptions of Data Source and Filtering Method

For the FRM data analysis, we used a data set from BAR (California Air Resource Board [OBD data records] 2023) that has been updated from the data used for the NPRM. This November 2023 dataset contains an additional year of PHEV activity on top of the NPRM's October 2022 dataset. CARB filtered the updated data to include only PHEV vehicles, and to exclude vehicles with less than 3,000 miles of total lifetime distance traveled. Also, vehicles that CARB identified as having incorrectly logged data in the lifetime distance OBD data fields used for this analysis were excluded. EPA filtered out a few additional vehicles where data necessary for determining whether the vehicle was being imported from out of state were missing.

The odometer reading data field was not used for filtering the updated data set. EPA concluded that a mismatch between the technician-recorded odometer reading and the OBD data was not indicative of any issue with our use of the OBD lifetime distance traveled data fields for calculating FUF. Similarly, the 20 percent window filtering between the total grid energy into the battery pack and total grid energy consumption during CD operation was not used in filtering the November 2023 CARB dataset. After further inspection of the data, EPA identified underlying reasons for why a difference of more than 20 percent would not be indicative of OBD data issues. For example, a number of vehicles in the BAR data set do not have any EV distances at engine off charge depleting operation, even when total grid energy consumption (from wall-charging) is reported, due to use cases such as portable electric energy storages and other outdoor activity power supply.



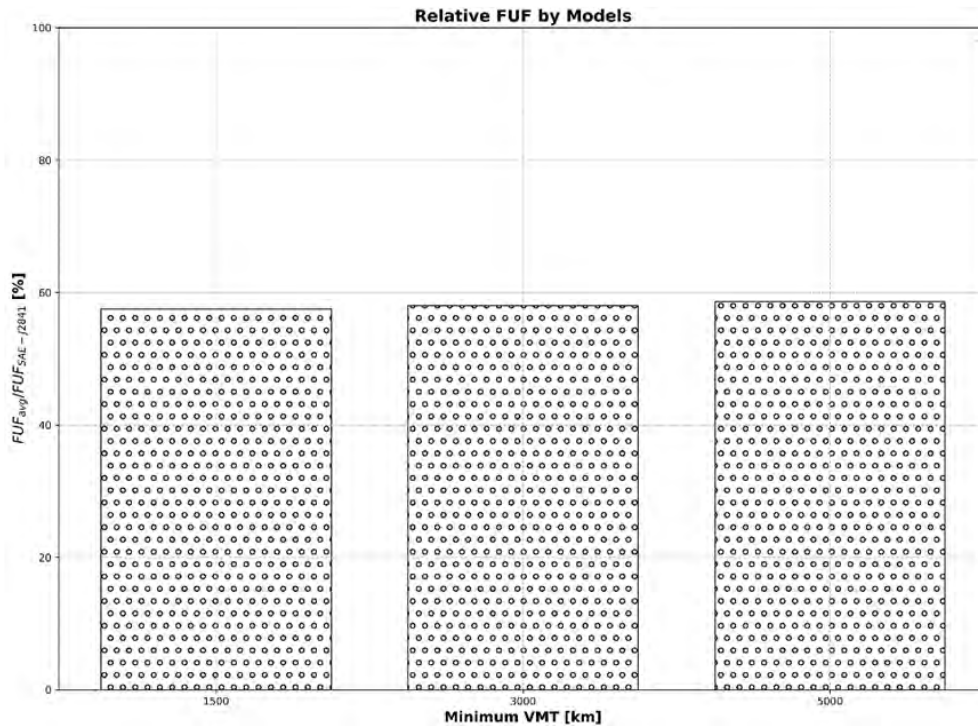
**Figure 3-38: Lifetime Total Grid Energy into Battery (less than 200-kWh)**

Figure 3-38 shows PHEV vehicles with over 3000 miles travelled that were charged less than 200-kWh total grid energy over their lifetime. The 200-kWh total grid energy charging to the battery packs can be achieved less than a month when charging a small 8.8-kWh PHEV battery pack daily. Of these vehicles, about 28 percent were filtered out when the 20 percent window

filtering between the total grid energy into the battery pack and total grid energy consumption during CD operation was applied. Therefore, this filter was not used for calculating various real-world usages and new applications of the PHEV vehicles and battery packs.

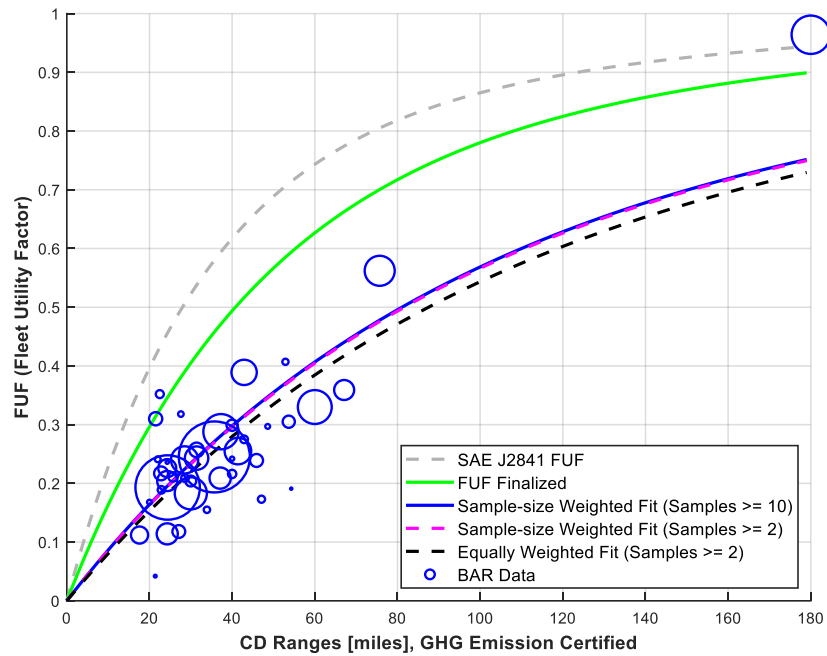
### 3.4.2.2 Minimum VMT and Sample-Size Sensitivities

To investigate data sampling sensitivities, we used various minimum VMT values for filtering data using the October 2022 BAR OBD data (California Air Resource Board [OBD data records] 2022). As shown in Figure 3-39, the relative FUFs over the SAE J2841 FUFs are not significantly different at various minimum VMT filtering.



**Figure 3-39: FUFs with various data filtering sensitivities.**

As shown in Figure 3-40, the “Sample-size Weighted Fit” curve using sample sizes greater than or equal to 2, lies on top of the “Sample-size Weighted Fit” curve using sample sizes greater than or equal to 10. Both of the “Sample-Weighted Fit” curves lie a little higher than the “Equally Weighted Fit” curve when using sample sizes greater than or equal to 2. Therefore, the sample-size weighted fitting (Aaron Isenstadt, Zifei Yang, Stephanie Searle, John German 2022) with sample sizes greater than or equal to 2 are used for fitting FUF data with 6-coefficient non-linear regression and a 399.9-mile normalized distance (SAE J2841 2010).



**Figure 3-40: BAR Regression FUF Curve fits with Sample-size Weighted.**

### **3.4.3 Analyses of FUF based on BAR Dataset**

While EPA used BAR data from October 2022 (California Air Resource Board [OBD data records] 2022) for the NPRM, an additional year of data was available to inform this FRM. In November 2023 OBD datasets (California Air Resource Board [OBD data records] 2023) were made available for EPA to analyze. EPA found that the expanded data set confirms that, on average, there are more charge-sustaining miles traveled and more gasoline miles traveled than are predicted by the current SAE J2841 FUF (Fleet Utility Factor) curves. The BAR OBD data enables the evaluation of real-world PHEV distances travelled in various operational modes; these include charge-depleting engine-off distance, charge-depleting engine-on distance, charge-sustaining engine-on distance, total distance traveled, odometer readings, total fuel consumed, and total grid energy inputs and outputs of the battery pack. These fields of data allow us to use the BAR OBD data to filter the data and calculate real-world driving FUFs (ratios of charge depleting distance to total distance) and to then compare to the existing SAE J2841 FUFs as calculated and applied in EPA’s GHG emissions certification using the 2-cycle charge-depleting range values.<sup>29</sup> Although we have reached a similar conclusion to other studies that have been conducted to evaluate PHEV utility, the BAR data has allowed EPA to analyze PHEV utility specifically on distance traveled in each mode as recorded by the vehicle itself. Other studies (Patrick Plötz 2023) regarding PHEV utility have attempted to calculate distance traveled in each mode using energy and fuel consumption or the labeled values. Because energy and fuel

---

<sup>29</sup> The existing regulatory FUFs are separate city and highway curves, and the charge depleting ranges that are used with the city and highway FUF curves are 2-cycle range.

consumption can vary greatly based on operating and environmental conditions, and distance calculations can also vary, EPA did not rely on these types of analyses to inform this rulemaking.

#### **3.4.3.1 Basis for EPA's Final Utility Factor**

A fleet utility factor provides a means of accounting for a PHEV's operation using electricity, known as the Charge Depleting Mode with respect to the total mileage that a PHEV travels. The Charge Depleting mode is dependent on two significant factors. The first is the size or capacity of the battery. Typically, a PHEV with a larger battery will have more all-electric range, all other vehicle attributes equal. The second factor is an owner's propensity to charge the battery. SAE J2841 states explicitly that the UF represented in SAE standard assumes that a PHEV is fully charged at least once per day. Recent literature (Aaron Isenstadt, Zifei Yang, Stephanie Searle, John German 2022) and data (California Air Resource Board [OBD data records] 2023) have identified that the current utility factor curves overestimate the fraction of driving that occurs in charge depleting operation. This literature (Seshadri Srinivasa Raghavan & Gil Tal 2022) also concludes that vehicles with lower charge depleting ranges have even greater discrepancy in CO<sub>2</sub> emissions.

The results of EPA's data analysis on 2-cycle combined GHG emission-certified CD ranges are shown in Figure 3-50. The FUF applied in the current GHG regulations is labeled as "SAE J2841 FUF" and EPA's data analysis of the November 2023 BAR OBD data is labeled as "BAR Regression Fit".

The finalized FUF curve represents a modest change of about 11 percent from SAE J2841 FUF curve while the averages of the SAE J2841 FUF curve are approximately 55 percent higher than those calculated using the "BAR Regression Fit" curve between 0 and 180-mile 2-cycle combined GHG emission-certified CD ranges using November 2023 CARB dataset.

EPA is finalizing a revised light-duty vehicle PHEV Fleet Utility Factor curve for use in the CO<sub>2</sub> compliance calculation for PHEVs, beginning in MY 2031. The agency believes the current LD vehicle PHEV compliance methodology significantly underestimates PHEV CO<sub>2</sub> emissions. The mechanism that is used to apportion the benefit of a PHEV's electric operation for purposes of determining the PHEVs contribution towards the fleet average GHG requirements is the fleet utility factor (FUF), further explained below.

The finalized FUF curve was developed using the best available public real-world PHEV dataset, which consists of about 8,800 PHEV vehicles, 43 PHEV models and 90 PHEV model variants in the November 2023 BAR dataset (California Air Resource Board [OBD data records] 2023). The current SAE J2841 FUF curve and the finalized FUF curve are shown in Figure 3-37, shown above. The grey-dashed FUF curve labeled as "SAE J2841 FUF" in Figure 3-37 was developed in SAE 2841 (SAE J2841 2010) and are used to estimate the percentage of operation that is expected to be in charge depleting mode (vehicle operation that occurs while the battery charge is being depleted, sometimes referred to as electric range). The measurement of the charge depleting (CD) range is performed over the EPA city and highway test cycles, also called the 2-cycle tests. The tested cycle specific charge depleting range is used as an input to the FUF curves (or lookup tables, as shown in Tables 1 and 2 in 40 CFR 600.116-12) to determine the specific city and highway FUFs. The resulting FUFs are used to calculate a composite CO<sub>2</sub> value for the city and highway CO<sub>2</sub> results, by weighting the charge depleting CO<sub>2</sub> by the FUF and weighting the charge sustaining (CS) CO<sub>2</sub> by one minus the FUF.



The FUFs developed in SAE J2841 rely on a few important assumptions and underlying data: (1) trip data from the 2001 National Household Travel Survey,<sup>30</sup> used to establish daily driving distance assumptions, and (2) the assumption that the vehicle is fully charged before each day's operation. These assumptions are important because they affect the shape of the utility factor curves, and therefore affect the weighting of CD (primarily electric operation)<sup>31</sup> CO<sub>2</sub> and CS (primarily internal combustion engine operation)<sup>32</sup> CO<sub>2</sub> in the compliance value calculation. SAE J2841 was developed more than ten years ago during the early introduction of light-duty PHEVs and at the time was a reasonable approach for weighting the CD and CS vehicle performance for a vehicle manufacturer's compliance calculation given the available information. The PHEV market has since grown, and there is significantly more real-world data available to EPA on which to design an appropriate compliance program for PHEVs. The agency believes that the use of an FUF is still an appropriate and reasonable means of calculating the contribution of PHEVs to GHG emissions and compliance, but the real-world data available today no longer supports the FUF established in SAE J2841 more than a decade ago.

Because the tailpipe CO<sub>2</sub> produced from PHEVs varies significantly between CD and CS operation, both the charge depleting range and the utility factor curves play an important role in determining the magnitude of CO<sub>2</sub> that is calculated for compliance. In charge depleting mode EPA is proposing to maintain a zero gram per mile contribution when the internal combustion engine is not running. The significant difference noted above is the difference between, potentially, zero grams per mile in CD mode versus CO<sub>2</sub> grams per mile that are likely to be similar to a hybrid (non-plug-in) vehicle. The charge depleting range for a PHEV is determined by performing single cycle city and highway charge depleting tests according to SAE Standard J1711 (SAE J1711 2023), Recommended Practice for Measuring the Exhaust Emissions and Fuel Economy of Hybrid-Electric Vehicles, Including Plug-In Hybrid Vehicles. The charge depleting range is determined by arithmetically averaging the city and highway range values weighted 55-percent and 45-percent, respectively, as noted in 40 CFR 600.311-12(j)(4)(i) (40 CFR 600.311-12 2021).

### 3.4.3.2 FUF Comparisons with Real World Data

Recent literature (Aaron Isenstadt, Zifei Yang, Stephanie Searle, John German 2022), (Seshadri Srinivasa Raghavan & Gil Tal 2022) and data (California Air Resource Board [OBD data records] 2023) have identified that the SAE J2841 utility factor curves may overestimate the fraction of driving that occurs in charge depleting operation. This literature (Seshadri Srinivasa

---

<sup>30</sup> We used the latest NHTS data (2017) and executed the utility factor code that is in SAE J2841, Appendix C, and found that the latest NHTS data did not significantly change the utility factor curves. NHTS data can be found at U.S. Department of Transportation, Federal Highway Administration, 2017 National Household Travel Survey. URL: <https://nhts.ornl.gov/>

<sup>31</sup> The complexity of PHEV designs is such that not all PHEVs operate solely on the electric portion of the propulsion system even when the battery has energy available. Engine operation during these scenarios may be required because of such design aspects as blended operation when both the electric power and the engine are being utilized, or during conditions such as when heat or air conditioning is needed for the cabin and can only be obtained with engine operation.

<sup>32</sup> Because most CD operation occurs without engine operation, the CO<sub>2</sub> value for CD operation is often 0 or near 0 g/mi. This means that a high utility factor results in a CO<sub>2</sub> compliance value that is heavily weighted with 0 or near 0 g/mi.

Raghavan & Gil Tal 2022) also concludes that vehicles with lower charge depleting ranges have even greater discrepancy in CO<sub>2</sub> emissions.

EPA (Aaron Isenstadt, Zifei Yang, Stephanie Searle, John German 2022) has evaluated recently available California Bureau of Automotive Repair (BAR) OBD data, (California Air Resource Board [OBD data records] 2022) that has been collected through the California Bureau of Automotive Repair and found that the data shows that, on average, there is more charge sustaining operation and more gasoline operation than is predicted by the SAE J2841 fleet utility factor curves. The BAR OBD data enable the evaluation of real-world PHEV distances travelled in various operational modes; these include charge-depleting engine-off distance, charge-sustaining engine-on distance, total distance traveled, odometer readings, total fuel consumed, and total grid energy inputs and outputs of the battery pack. These fields of data allow us to use the BAR OBD data to filter the data and calculate 2-cycle combined GHG emission-certified CD ranges and 5-cycle comparable real-world driving ratios of charge depleting distance to total distance and to then compare to the existing FUFs on 2-cycle combined GHG emission-certified CD ranges.<sup>33</sup>

There are some limitations to the PHEV data collected through the BAR OBD data. Data collection occurs through the California Bureau of Automotive Repair and is limited to vehicles with ownership changes, vehicles entering the state, or vehicles that are at least 8-years old (California Air Resource Board [OBD data records] 2023). In addition, the PHEV BAR OBD data requirements are recent; they began in model year 2019 and were not fully phased in until model year 2021 (California Air Resource Board [OBD data records] 2023). The dataset also contains some reporting errors and some very low mileage data.

The results of EPA's data analysis of the BAR OBD data on 2-cycle combined GHG emission-certified CD ranges are shown below in Figure 3-50. The combined city and highway FUF in SAE J2841 (corresponding to the 55-percent city/45-percent highway weighting of the city and highway FUFs) in the current regulations is labeled as "SAE J2841 FUF" and EPA's data analysis of the CARB OBD data is labeled as "BAR Regression Fit".

#### **3.4.3.2.1 Influence of Geographic Origin**

About 79 percent of PHEV vehicles that traveled approximately 140.4 million miles are from in-state ownership transfers, and around 21 percent of PHEV vehicles that traveled around 23.1 million miles are from out-of-state vehicle registrations. The "BAR Regression Fit" curve is more influenced by about a factor of six by in-state ownership transfer PHEV vehicles since the FUF values are calculated by a distance-weighted basis. Additionally, there is no reason to expect one-time long-distance moving miles to make up more than a small portion of the 23.1 million miles from out-of-state vehicle registration vehicles.

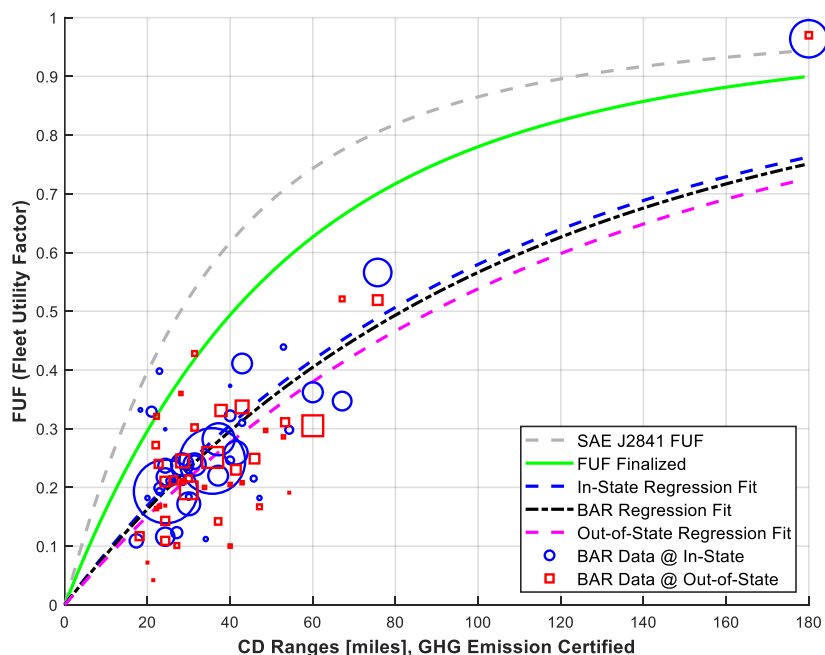
The averaged FUF values calculated by the regression fit curves of the in-state ownership transfers and out-of-state registrations are within about 2.3 percent and -4.8 percent of the averaged FUF values represented by the "BAR Regression Fit" curve when using a minimum

---

<sup>33</sup> Because the data collected is real-world data, we used the combined city and highway 5-cycle label range as an input to the FUF curve described in SAE J2841, to create an apples-to-apples comparison. The existing regulatory FUFs are separate city and highway curves, and the charge depleting ranges that are used with the city and highway FUF curves are 2-cycle range.

sample size of 2. When using larger sample sizes greater than or equal to 10, the averaged FUF values of in-state ownership transfers and out-of-state PHEV vehicle registrations in the filtered model data are within 1.5 percent.

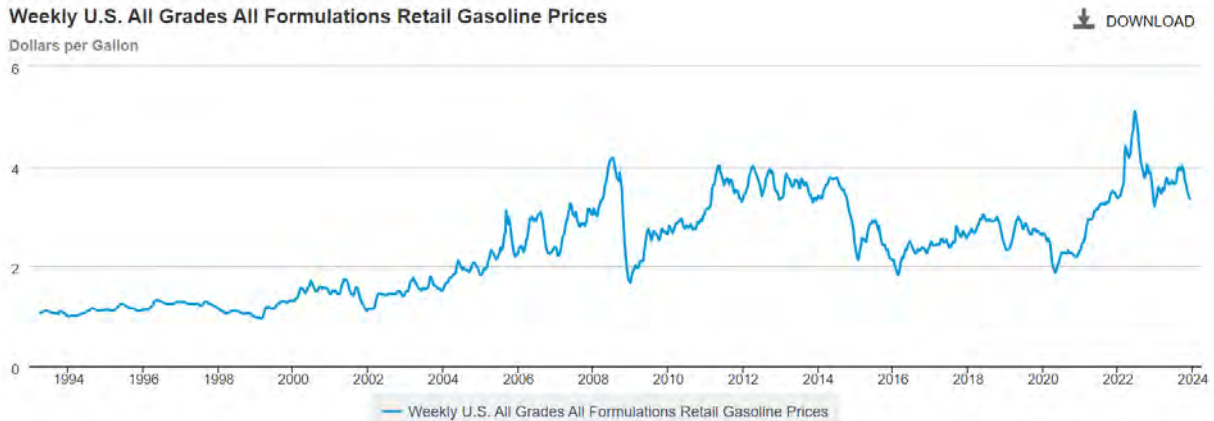
As shown in Figure 3-41, the FUF differences between the blue-dashed FUF fit curve of 79 percent In-State ownership transfers and the magenta-dashed FUF fit curve of 21 percent Out-of-State registrations are not significant. The FUF values by predicted by the “SAE J2841 FUF” curve are still approximately 51 percent higher than those calculated by the best-case, blue-dashed regression fit curve of In-State ownership transfers.



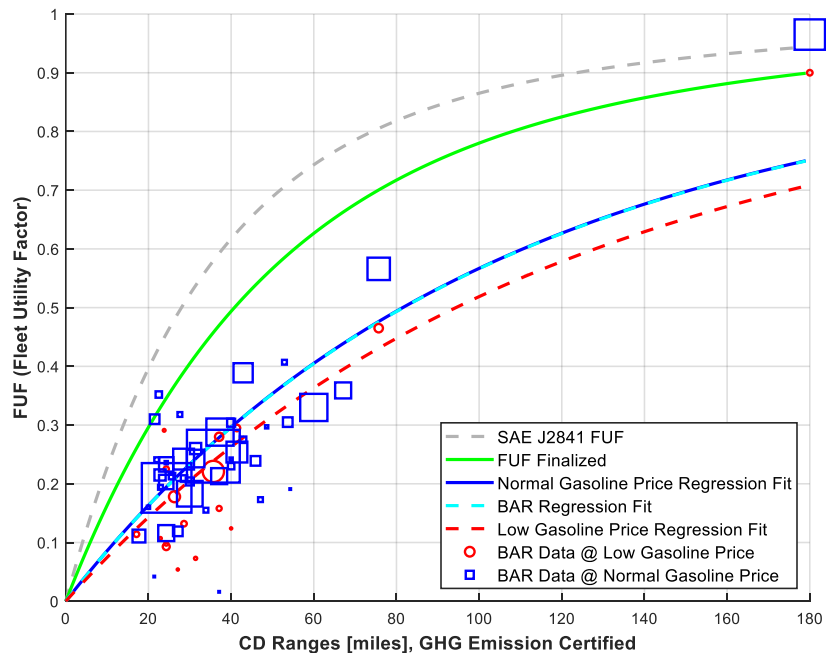
**Figure 3-41: In-State and Out-of-State FUF Comparisons.**

### 3.4.3.2.2 Influence of Gasoline Price

About 4.7 percent of PHEV vehicles that traveled approximately 5.6 million miles are from a period of low gasoline prices (the pandemic period from March 1, 2020, to March 30, 2021), and around 95.3 percent of PHEV vehicles that traveled around 157.6 million miles are from the normal gasoline price period (mostly pre- and post-pandemic, as shown in Figure 3-42 (U.S. EIA 2023)). The distance weighted "BAR Regression Fit" curve fitting, as shown in Figure 3-43, is more influenced by about a factor of 28 by the higher total distance travelled when gasoline prices were normal. Furthermore, the averaged FUF values calculated by the regression fit curves of the normal gasoline price period and the low gasoline price period are within 0.1 percent and -8.1 percent of the averaged FUF values represented by the “BAR Regression Fit” curve when using a minimum sample size of 2. When using larger sample sizes greater than or equal to 10, the averaged FUF values of the normal gasoline prices and the low gasoline prices in the filtered model data are within 1.6 percent.



**Figure 3-42: U.S. Retail Gasoline Prices.**



**Figure 3-43: FUF Finalized, SAE FUF, and BAR Regression Fits at low gasoline prices.**

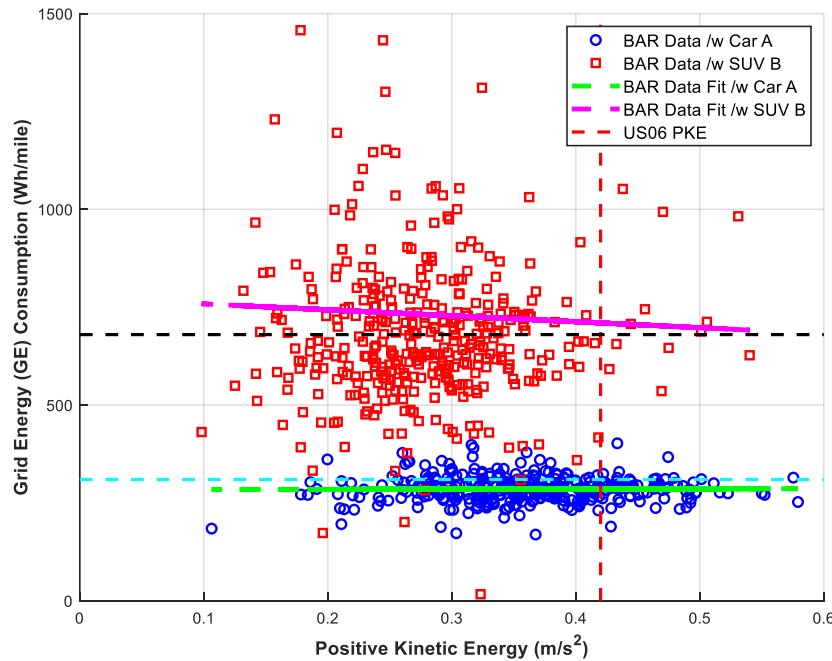
As shown in Figure 3-43, the effects of the red-dashed FUF fit curve of 5.6 million miles traveled at low gasoline prices are minimal compared to the blue-solid FUF fit curve of 157.6-million miles traveled distance at normal gasoline prices since FUF are calculated by a travelled distance weighted of fleet vehicles. The FUF values by the grey-dashed "SAE J2841 FUF" Fit curve are still approximately 55 percent higher than those by the best-case, blue-solid FUF fit curve at normal gasoline prices.

### 3.4.3.2.3 Influence of Aggressive Driving Behaviors

The high-volume sales "Car A" and the "SUV B" PHEV datasets were used to investigate Grid Energy (GE) Consumptions at various driving behaviors. The Positive Kinetic Energy (PKE) data field (California Air Resource Board [OBD data records] 2023) was used to characterize aggressive driving behaviors. The PKE is calculated by using Equation 3-1 (Edwards 2022).

$$\text{Equation 3-1. } PKE = \frac{\sum_{\text{acceleration} > 0} (V_f^2 - V_i^2)}{\text{distance}}$$

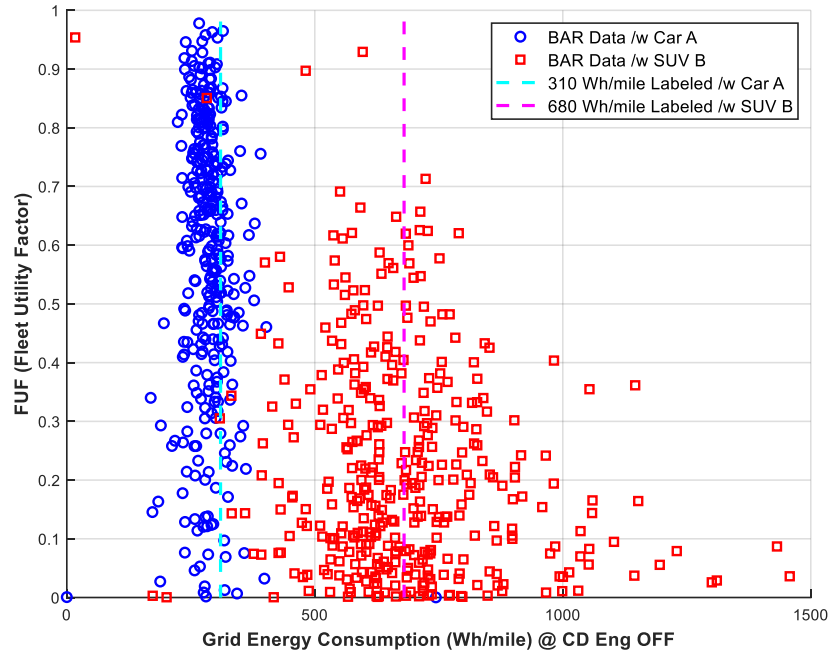
where  $V_f$  and  $V_i$  are the final and initial vehicle speeds, respectively.



**Figure 3-44. Grid Energy Consumptions during CDO vs PKE**

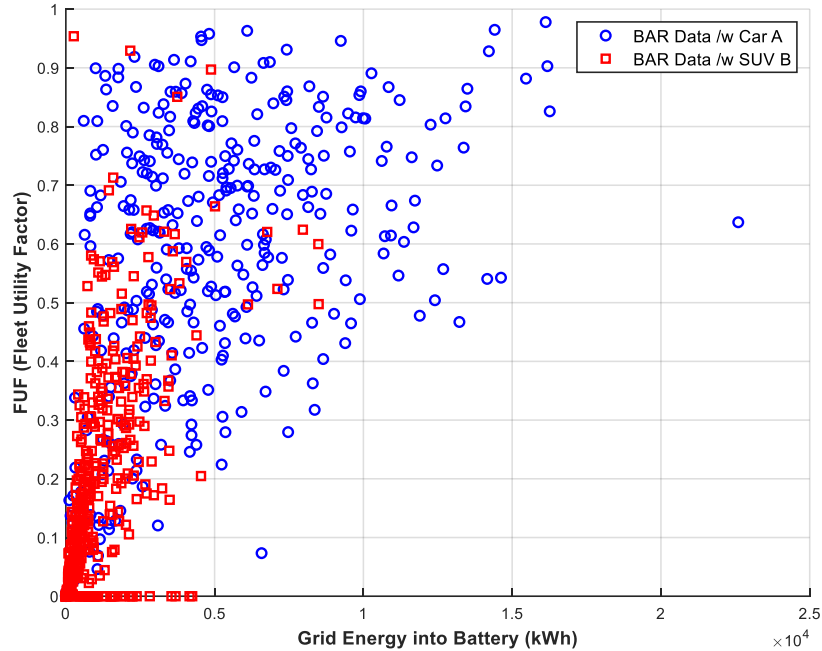
PKE values of about 0.14, 0.35 and 0.42 m/s<sup>2</sup> were calculated over Highway, UDDS, and US06 dynamometer test cycle vehicle speed profiles. The "Car A" PHEV has 1.5-liter four-cylinder gasoline engine, a 17.5-kWh lithium-ion battery, an 87-kW electric motor and about 3500 pounds vehicle weight. The "SUV B" PHEV has a 2.0L inline 4-cylinder engine, a 17.3 kWh lithium-ion battery pack, a 100-kW electric traction motor and about 5,200-pound vehicle weight. Most of the "Car A" PHEVs were operated at below the label value electric energy consumption rate (cyan dashed line). As shown in the green-solid regression data fit curve in Figure 3-44, the grid energy consumptions over the entire PKE range are almost flat. The heavier "SUV B" PHEV requires higher grid energy consumptions to propel about 5200-pound vehicle, and the "SUV B" grid energy data points are more scattered. The magenta-colored regression curve fitted using the "SUV B" PHEV data points has a slightly negative slope; however, the slope of the "SUV B" PHEV is also nearly flat over the entire PKE range.

The motor peak power to vehicle weight ratio of the "Car A" PHEV is about 29 percent higher than that of the much heavier "SUV B" PHEV. Therefore, the "SUV B" PHEV engine is more frequently started when driving aggressively since the battery capacity to vehicle weight ratios of the "SUV B" PHEV are about 33 percent less than those of the "Car A" PHEV while the vehicle weights of the "SUV B" PHEV are about 49 percent heavier than those of the "Car A" PHEV. Overall, the grid energy consumptions are flat over the entire PKE ranges, and therefore the driving behaviors are not a major factor for grid energy consumptions and deteriorating the FUF values compared to battery charging frequencies.

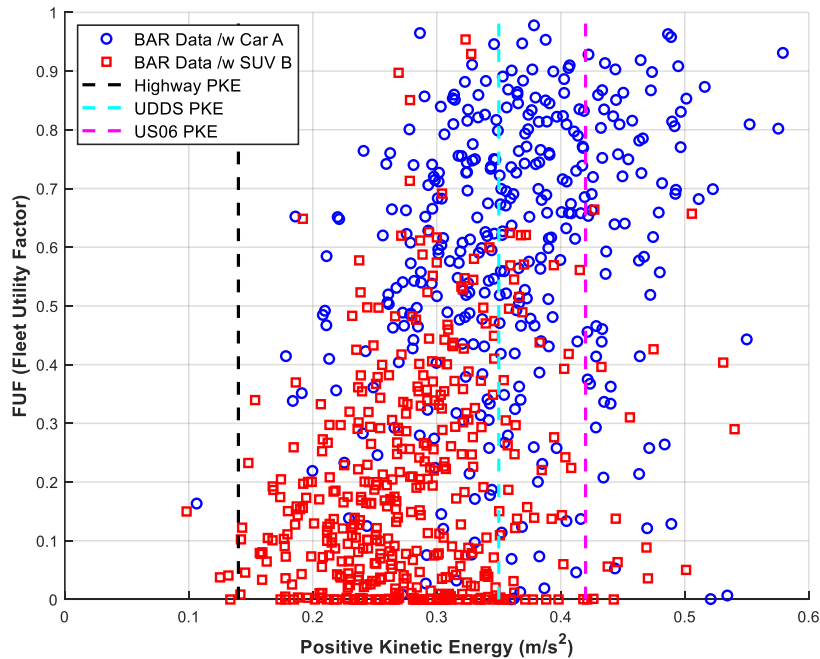


**Figure 3-45. FUF vs Grid Energy Consumption at CD Engine Off**

Figure 3-45 shows that grid energy of the "Car A" PHEV are mostly consumed at or below the label value electric energy consumption rate while that of the "SUV B" PHEV are consumed within reasonable percentages of its label value electric energy consumption rate. The label value electric energy consumption rates are calculated by dividing the 2-cycle city and highway combined grid energy consumptions by a 0.7 5-cycle adjustment factor.



**Figure 3-46. FUF vs Grid Energy into Battery (kWh)**



**Figure 3-47. FUF vs. Positive Kinetic Energy**

Figure 3-46 shows that lower FUF values are directly related to the amount of Grid Energy charging to battery packs as shown in the poorly charged data points at below 0.2 FUF values.

As shown in Figure 3-47, there are a lot of higher BAR data points at about 0.42 m/s<sup>2</sup> PKE line, and therefore higher FUFs at the aggressive driving behaviors can be achieved as long as fully charging the battery packs daily. Figure 3-47 shows that the driving behaviors are not the most dominant factor for higher grid energy consumptions and deteriorating the FUF values.

### 3.4.3.2.4 Influence of Data Filtering

EPA created an aggressively filtered data set, similar to the ICCT data filtering, by filtering out vehicles with greater than 20 percent difference between odometer readings and total lifetime traveled distance, and vehicles with greater than 20 percent difference between the total grid energy into the battery pack and total grid energy consumption during CD operation.

The aggressively filtered dataset, the "FUF /w ICCT filter", has 36 PHEV models and 71 model variants, and approximately 4,000 individual vehicles that travelled approximately 94.9 million miles. The aggressively filtered dataset excluded about 3 percent of the PHEV data which were charged less than 1-kWh and about 24.5 percent of the PHEV data which were charged less than 200-kWh.

As shown in Figure 3-48, small FUF differences between the "BAR Regression Fit" curve and the aggressively filtered "BAR Regression Fit /w ICCT filter" curve are not significant compared to the FUF values represented by the grey-dashed "SAE J2841 FUF" Fit curve. The FUF values by the grey-dashed "SAE J2841 FUF" Fit curve are still approximately 46 percent higher than those by the best-case, red-dashed aggressively filtered "BAR Regression Fit /w ICCT filter" curve. Therefore, the data filtering criteria are not a dominant factor since FUF values are mostly determined by battery charging frequencies.

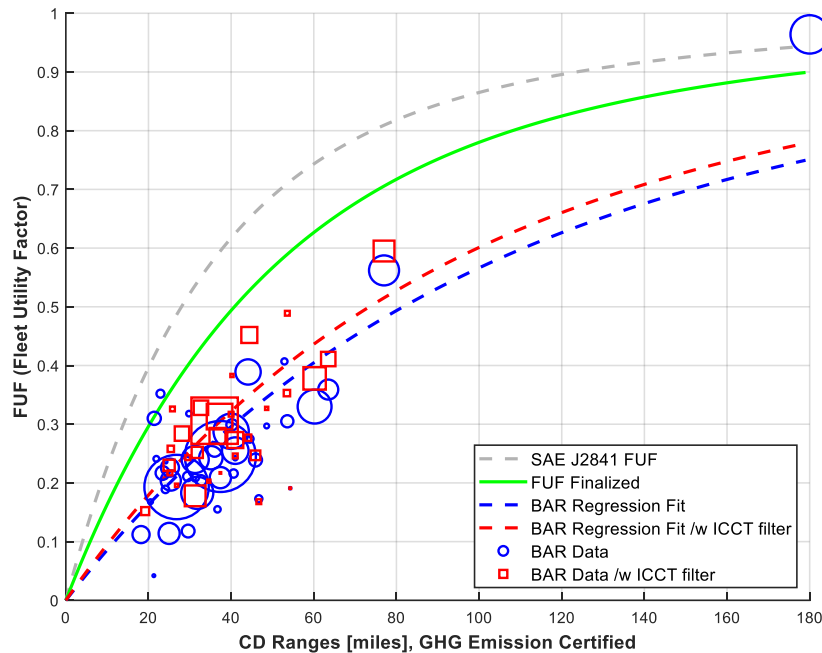


Figure 3-48. FUF Regression Fits with Different Filtering Criteria

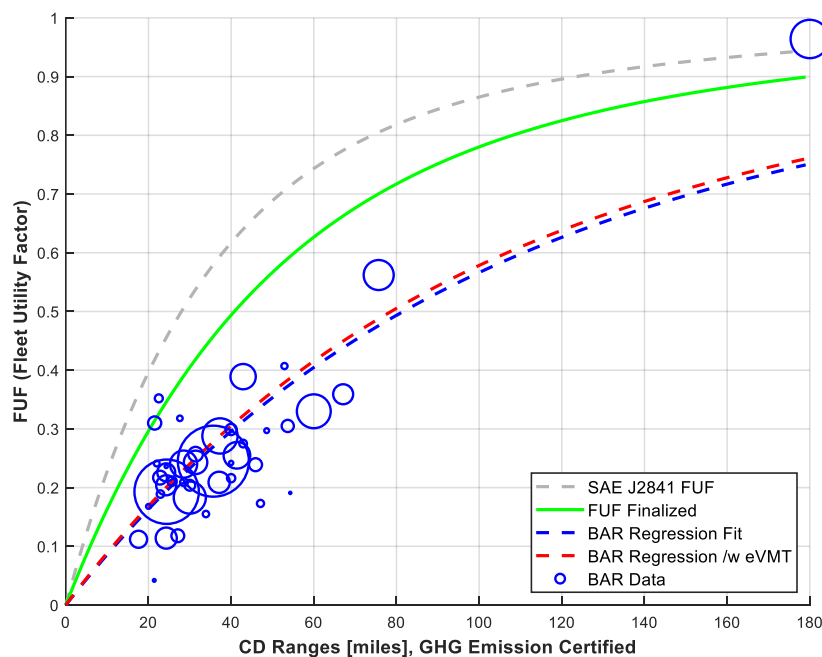
### 3.4.3.2.5 Influence of CD Blended Vehicle Miles Traveled on Electricity (eVMT)

The CD engine-on blended mode eVMT distance is calculated by multiplying the traveled VMT during CD engine-on blended operations by the ratio of displaced gasoline to total gasoline consumed (displaced + CD engine on blended mode gasoline consumed). The total eVMT distance is the sum of all electric range (AER) in EV mode and CD engine-on blended mode eVMT distance. The displaced gasoline volumes and the CD engine-on blended mode eVMT



distance are calculated using equation 5 in reference (Seshadri Srinivasa Raghavan & Gil Tal 2022).

As shown in Figure 3-49, there is about 2 percent difference between averaged FUF values calculated using the "BAR Regression Fit" curve and the "BAR Regression /w eVMT" fit curve, which is not significant compared to the FUF values represented by the green-solid "FUF Finalized" curve. Therefore, the eVMT distance during CD engine on blended mode operations is insignificant when using highly efficient electric drivetrains and high-capacity battery packs.



**Figure 3-49. FUF Regression Fits with CD engine-on blended mode eVMT distance**

### 3.4.3.2.6 FUF Curves on different CD Ranges

The “BAR Regression Fit” shown in Figure 3-50, is constructed using about 8,600 valid PHEV data points, with 2-cycle (UDDS and Highway) combined GHG emission-certified CD ranges from 10-miles to 180-miles, contained in the November 2023 BAR OBD dataset. This regression fit line lies substantially lower than the SAE J2841 FUF curve. The finalized FUF curve was adjusted modestly to be about 11% from the SAE J2841 FUF curve and approximately 38 percent higher than the curve calculated using the “BAR Regression Fit” curve.

The label values for CD ranges are reduced by 30 percent from 2-cycle combined CD ranges for CAFE standards compliance and labelling the all-electric ranges and CD ranges of PHEV vehicle stickers. The differences between the labeled CD ranges and 2-cycle GHG emission-certified CD ranges are more than 30 percent when including the voluntary adjustments. For example, the approximately 47-mile 2-cycle GHG emission-certified CD ranges of the 2022 Audi A7E PHEV were significantly reduced to the 26-mile labeled CD ranges by including a 20 percent voluntary adjustment. Similarly, the 47-mile 2-cycle combined GHG emission-certified

CD range for a 2022 Audi A7E PHEV was reduced a total of about 45 percent by the inclusion of a voluntary adjustment.

The BAR OBD data is a recent and relatively large dataset that includes the charge depleting distance (or electric operating distance) and total distance, which makes it a reasonable source for evaluating the real-world utility factors for recent PHEV usage. However, we recognize that the curve developed from this data is a departure from the SAE J2841 FUF curves, that the BAR OBD data has some limitations (described above), and that the original SAE J2841 FUF methodology was also a reasonable approach at the time it was adopted. While the BAR data suggests that a lower curve than we are finalizing might more appropriately reflect current real-world usage, EPA recognizes that PHEV technology has the potential to provide significant GHG reductions when operating in charge depleting mode and charged regularly. In addition, anticipated longer all-electric range and greater all-electric performance, partially driven by CARB’s ACC II program, as well as increased consumer technology familiarity and available infrastructure could encourage greater charge depleting operation than is evident today. EPA will continue to monitor real-world data as it becomes available.

**Table 3-26: Curve Fitting Coefficients in the FUF Finalized and BAR Regression Fit.**

| Curve Fitting Label                               | Norm Distance (mile) | Curve Fitting Coefficients |        |        |        |        |        |
|---|----------------------|----------------------------|--------|--------|--------|--------|--------|
|   |                      | C1                         | C2     | C3     | C4     | C5     | C6     |
| SAE J2841 FUF                                     | 399.9                | 10.52                      | -7.282 | -26.37 | 79.08  | -77.36 | 26.07  |
| FUF Finalized (FRM)                               | 583.0                | 10.52                      | -7.282 | -26.37 | 79.08  | -77.36 | 26.07  |
| Illustrative Final, using SAE Normalized Distance | 399.9                | 7.216                      | -3.426 | -8.511 | 17.506 | 11.747 | 2.715  |
| BAR Regression Fit                                | 399.9                | 3.605                      | -0.855 | -1.061 | 1.090  | -0.366 | 0.042  |
| ICCT-2 cycle range                                | 399.9                | 6.674                      | -4.857 | 0.726  | 0.418  | 0.350  | -2.049 |

The Finalized curve (see Figure 3-37 and Figure 3-50, "FUF Finalized") is based on Equation 3-2, (40 CFR 600.116-12 2022) using a normalized distance (ND) and 6-coefficients shown in the "FUF Finalized (FRM)" of Table 3-26. Other UF curves shown include the current SAE J2841 FUF, which uses the combined city/highway FUF coefficients, and a ND of 399.9 miles. The "ICCT-2 cycle range" curve in Table 3-26 was translated from the "ICCT-Labeled range" curve using the "0.7" 5-cycle adjustment factor.

The FUF and the curve fitting coefficients ( $C_j$ ) of the "FUF Finalized", "FUF Illustrative Final", "BAR Regression Fit", and "ICCT-2 cycle range" curves are listed in Table 3-26. The SAE J2841 FUF normalized distance and 6-curve fitting coefficients are listed in Table 2 of the SAE J2841 standard (SAE J2841 2010). The "ICCT-2 cycle range" fit curve was translated from the blue dash-dotted "ICCT-Labeled range" curve on 2-cycle combined GHG emission-certified CD ranges by using the same "SAE J2841 FUF" normalized distance and 6-new curve fitting coefficients in the Table 3-26.

**Equation 3-2: Utility Factor (UF) Exponential Equation Fits**

$$UF = 1 - \left[ \exp \left( - \sum_{j=1}^k \left( \frac{CD}{ND} \right)^j C_j \right) \right]$$

where:

*CD* = charge depleting range in miles

*ND* = normalized distance

*C<sub>j</sub>* = the weighting coefficient for term *j*

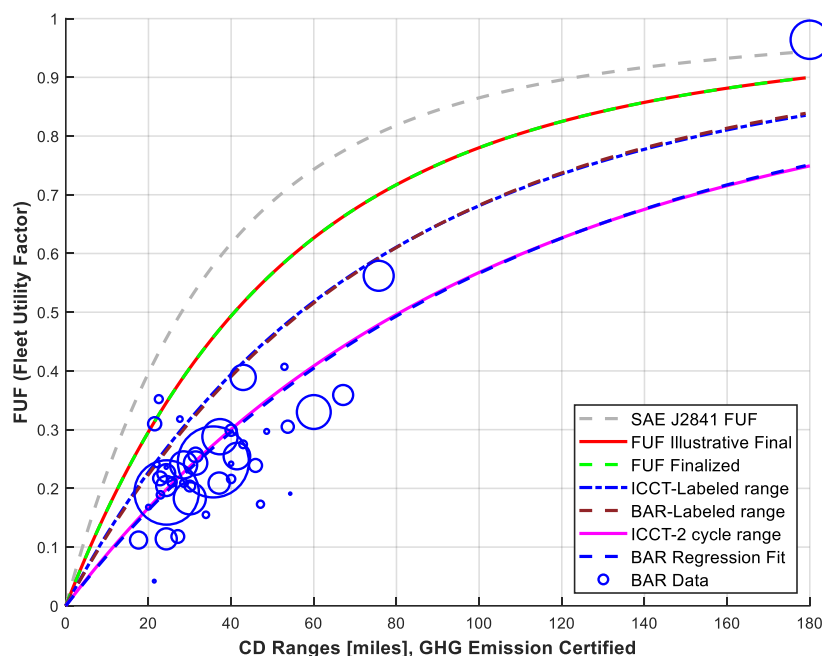
*k* = number of coefficients (6 for the FUF Fit and 10 for the MDIUF Fit)

The five hundred eighty-three (583)-mile normalized distance in the "FUF Finalized (FRM)" of Table 3-26 was calculated by minimizing the sum of the squared residual norm in Equation 3-2 when using SAE J2841 FUF fitting coefficients. The red solid "FUF Illustrative Final" fit curve, which is created using 6-new curve fitting coefficients and 399.9-mile normalized distances in the "FUF Illustrative Final, using SAE Normalized Distance" of Table 3-26, lies on top of the green-dashed "FUF Finalized" curve in Figure 3-50.

ICCT developed the "ICCT-Labeled range" curve for the BAR OBD, which uses the MDIUF<sup>34</sup> coefficients, and a ND of nine hundred eighty-five (985) miles (Aaron Isenstadt, Zifei Yang, Stephanie Searle, John German 2022) by adjusting the normalized distances in the UF Equation 3-2 for the BAR OBD data and using sample-size weighted nonlinear least squares regression. As shown in Figure 3-50, the FUF values calculated using the blue-dashed "BAR Regression Fit" curve are substantially lower than those by the blue dash-dotted ICCT-Labeled range curve, which was fitted using the labeled CD ranges. The averaged FUF values for the ICCT-Labeled range fitted curve are about 20 percent higher than those calculated by the "BAR Regression Fit" curve from 0 to 180-mile CD ranges.

---

<sup>34</sup> The SAE J2841, the FUF is recommended for fleet vehicle fuel consumption calculations, and the MDIUF is recommended to estimate of an individual vehicle's fuel economy. EPA has incorporated the FUF for compliance calculations, and the MDIUF for fuel economy labeling calculations. Among other differences, the MDIUF is a vehicle-weighted calculation, and the FUFs are VMT distance-weighted calculations.



**Figure 3-50: The Finalized FUF, SAE FUF, and ICCT Curves on 2-cycle combined GHG emission-certified CD range**

The "BAR Regression Fit" curve shown in Figure 3-50 lies substantially lower than the "SAE J2841 FUF" fit curve. The "BAR Regression Fit" curve also lies on top of the "ICCT-2 cycle range" curve which is translated from the "ICCT-Labeled range" by dividing the label CD range by the "0.7" 5-cycle adjustment factor. The finalized FUF curve represents a modest change of about 11 percent from SAE J2841 FUF curve while the averages of the SAE J2841 FUF curve are approximately 55 percent higher than those calculated using the "BAR Regression Fit" curve between 0 and 180-mile 2-cycle combined GHG emission-certified CD ranges using November 2023 CARB dataset.

As noted above, while the BAR data suggests that an even lower curve than we are finalizing might more appropriately reflect current real-world usage, EPA recognizes that PHEV technology has the potential to provide significant GHG reductions when operating in charge depleting mode and charged regularly. In addition, anticipated longer all-electric range and greater all-electric performance, partially driven by CARB's ACC II program, as well as increased consumer technology familiarity and available infrastructure could encourage greater charge depleting operation than is evident today. EPA will continue to monitor real-world data as a new BAR OBD dataset, or an OEM dataset becomes available.

Table 3-27 shows PHEV vehicles that had sample sizes from 27 to 1968 in the CARB OBD dataset (California Air Resource Board [OBD data records] 2023) and also includes several additional high-volume PHEVs. The compliance CO<sub>2</sub> results range from a 19.5% to 47.8% (median = 31%) increase in CO<sub>2</sub> g/mi, for the example vehicles below, when using the finalized FUF compared to the existing SAE J2841 FUF.

**Table 3-27: CO<sub>2</sub> Emissions [g/mi] Calculated using Existing FUF and Finalized FUF.**

| Model Year | Manufacturer  | PHEV Model   | Existing:<br>Compliance CO <sub>2</sub><br>using Existing FUF | Finalized:<br>Estimated Compliance<br>CO <sub>2</sub> using Finalized FUF |
|------------|---------------|--------------|---|---|
| 2022       | AUDI          | Q5 E         | 116.3   | 165.7   |
| 2022       | BMW           | 330E         | 100.2   | 132.5   |
| 2021       | BMW           | 530E         | 114.4   | 147.1   |
| 2020       | BMW           | I8           | 126.7   | 156.8   |
| 2021       | BMW           | X3 xDrive    | 136.6   | 168.5   |
| 2022       | BMW           | X5           | 108.5   | 154.3   |
| 2019       | CHEVROLET     | VOLT         | 29.9  | 44.2  |
| 2022       | FORD          | ESCAPE       | 47.9  | 63.8  |
| 2021       | HONDA         | CLARITY      | 33.4  | 47.9  |
| 2022       | HYUNDAI       | IONIQ        | 47.3  | 62.0  |
| 2019       | HYUNDAI       | SONATA PHEV  | 63.7  | 86.0  |
| 2021       | JEEP          | WRANGLER 4XE | 161.0   | 202.7   |
| 2022       | KIA           | NIRO         | 59.4  | 75.9  |
| 2020       | KIA           | OPTIMA PHEV  | 59.8  | 80.1  |
| 2022       | KIA           | SORENTO SX   | 68.7  | 90.5  |
| 2020       | MERCEDES-BENZ | GLC 350E     | 122.5   | 160.4   |
| 2022       | MINI          | COOPER       | 116.7   | 142.3   |
| 2022       | SUBARU        | CROSSTREK    | 99.0  | 118.3   |
| 2022       | TOYOTA        | PRIUS PRIME  | 57.5  | 70.6  |
| 2022       | TOYOTA        | RAV4 PRIME   | 55.1  | 71.7  |

We believe that it is important for PHEV compliance utility factors to accurately reflect the apportionment of charge depleting operation, for weighting the 2-cycle CO<sub>2</sub> test results; therefore, we are updating the city and highway fleet utility factor curves with a new, single curve that is shown in Figure 3-37 above. We are using a single curve to better reflect real world performance where the underlying real-world data is not parsed into city and highway data. Since the fleet average calculations are based on a combined city and highway CO<sub>2</sub> value, a single FUF curve can be used for these calculations.

### 3.4.3.3 Statistical Evaluation of FUF based on Real-World Data.

In making comments on the proposal, several stakeholders raised issues relating to statistical aspects of the analyses described in 3.4.3.2 above. Specific questions include:

- The minimum number of tests necessary to adequately represent a defined group of interest, such as a vehicle model,
- whether the estimates of utility factor based on the real-world data appear significantly lower than the SAE J2841 UF trend.
- whether the price of gasoline could exert an influence on driver behavior strong enough to influence the utility factor, and
- whether tests primarily represented routine commuting behavior as opposed to long-distance travel and whether this difference could influence the utility factor.

### 3.4.3.3.1 Definitions of Utility Factor

In analyses designed to target these questions, we calculated the utility factor based on the charge-depleting operation, with engine off and on, but with the engine-on value adjusted by "displaced fuel" to give an estimate of the mean 'blended' distance (Seshadri Srinivasa Raghavan & Gil Tal 2022):

#### Equation 3-3:

$$UF_{\text{Blended}} = \frac{\bar{d}_{\text{CDO,Off}} + \bar{d}_{\text{Blended}}}{\bar{d}_{\text{Total}}}$$

where the "blended distance" is calculated as

#### Equation 3-4:

$$\bar{d}_{\text{Blended}} = \bar{d}_{\text{CDO,Run}} \left( \frac{\bar{f}_{\text{Displ}}}{\bar{f}_{\text{Displ}} + \bar{f}_{\text{CDO}}} \right)$$

where :

$\bar{f}_{\text{Displ}}$  = mean "displaced" fuel (gal),

$\bar{f}_{\text{CDO}}$  = mean fuel consumed during charge-depleting operation, and

and where:

#### Equation 3-5:

$$\bar{f}_{\text{Displ}} = \bar{E}_{\text{CDO,Run}} \left( \frac{\bar{FE}_{\text{gas}}}{\bar{FE}_{\text{electric}}} \right)$$

where :

$\bar{E}_{\text{CDO,Run}}$  Mean Total Grid Energy consumed during engine-running charge-depleting operation, and

$\bar{FE}_{\text{gas}}$  = mean fuel economy over 100 mi (mpg), and

$\bar{FE}_{\text{electric}}$  = mean equivalent 'electric' fuel economy over 100 mi (mpg).

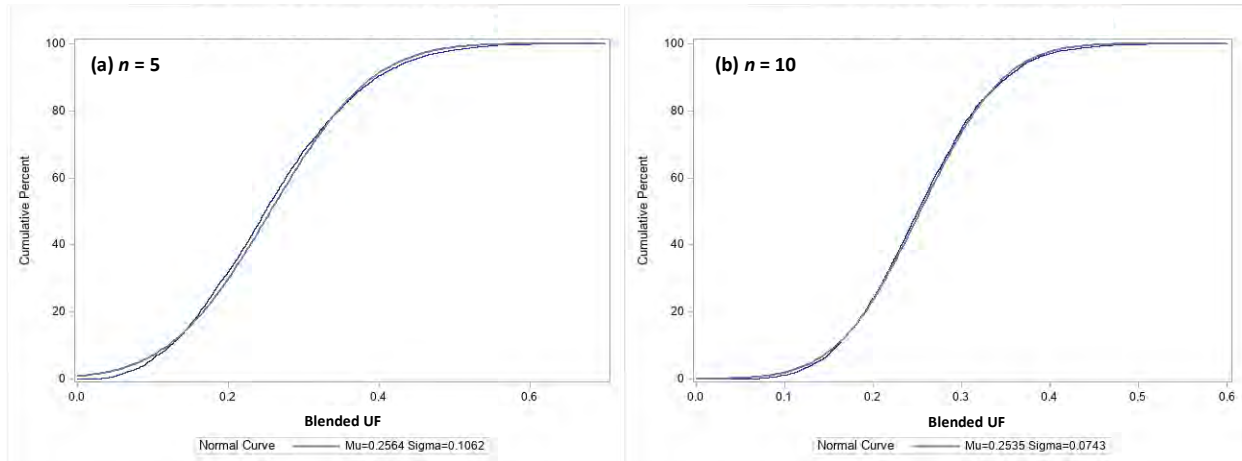
The mean values in the equations were calculated by groups, where group is defined as a model.

### 3.4.3.3.2 Estimation of Standard Error for the UF

To develop a basis for evaluation of statistical questions, the first task is to estimate the variance and standard deviation for the UF ( $s^2_{\text{UF}}$ ,  $s_{\text{UF}}$ ).

We elected to estimate the variance by bootstrap simulation. Through this approach we could avoid the need to propagate the uncertainties for the various parameters used in calculating the blended UF. As the UF is calculated as a ratio of means, we simulated the sampling distributions of the UF through repeated sampling of subsets of the dataset for selected models represented by large numbers of vehicles.

For the selected groups, we performed sampling with replacement (unrestricted random sampling) for sample sizes ranging from 5 to 275 vehicles and with 5,000 replicate samples for each sample size. For each replicate sample, we calculated the blended UF, as described above. After compiling the sets of replicate samples, we estimated the variance of the UF as the variance of the set of 5,000 replicate UFs. Figure 3-51 shows the sampling distributions for the Toyota Prius for the two smallest sample sizes. The figures show that the sampling distributions begin to approximate normal distributions for sample sizes as low as five vehicles but more clearly for samples of 10 vehicles or more.



**Figure 3-51: Toyota Prius: Sampling Distributions for the Blended UF for two Sample Sizes (5,000 replicates).**

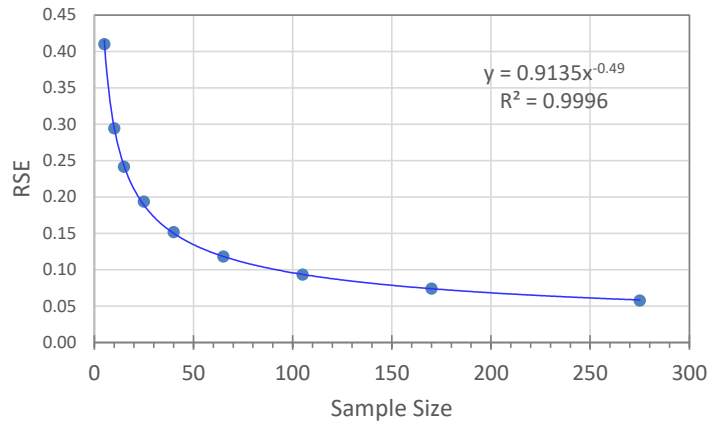
Table 3-28 shows summary results for the simulations for two vehicle models, the BMW 530E and the Toyota Prius. The table shows means and standard deviations for the engine-off and blended UFs for nine sample sizes ranging from  $n=5$  to  $n=275$ . As the UF as defined above, represents a mean (or ratios of means), we refer to its standard deviation as a ‘standard error.’ In addition, the tables show the standard error as a fraction of the mean, commonly known as the ‘relative standard error’ (RSE). For each sample size, the mean UF values remain stable, but as expected, the standard errors and RSE decline as  $n$  increases.

**Table 3-28: Mean Utility Factors, Standard Errors and Relative Standard Errors for Bootstrap Sampling with selected Sample Sizes for two Models (5,000 replicates drawn for each sample size).**

|              | <i>n</i> | Mean    | Standard Error | RSE     |
|--------------|----------|---------|----------------|---------|
| BMW 530E     | 5        | 0.20597 | 0.08291        | 0.40254 |
|              | 10       | 0.20604 | 0.05960        | 0.28927 |
|              | 15       | 0.20640 | 0.04895        | 0.23716 |
|              | 25       | 0.20515 | 0.03901        | 0.19018 |
|              | 40       | 0.20562 | 0.03062        | 0.14893 |
|              | 65       | 0.20536 | 0.02378        | 0.11580 |
|              | 105      | 0.20484 | 0.01871        | 0.09134 |
|              | 170      | 0.20471 | 0.01490        | 0.07277 |
|              | 275      | 0.20501 | 0.01158        | 0.05649 |
| Toyota Prius | 5        | 0.25637 | 0.10624        | 0.41440 |
|              | 10       | 0.25350 | 0.07428        | 0.29302 |
|              | 15       | 0.25328 | 0.06071        | 0.23970 |
|              | 25       | 0.25120 | 0.04770        | 0.18988 |
|              | 40       | 0.24977 | 0.03790        | 0.15174 |
|              | 65       | 0.24970 | 0.02943        | 0.11786 |
|              | 105      | 0.25041 | 0.02302        | 0.09192 |
|              | 170      | 0.24944 | 0.01827        | 0.07324 |
|              | 275      | 0.24980 | 0.01446        | 0.05787 |

The decline in the RSE with increasing sample size is shown in Figure 3-52 for one model. The plots show that the RSE follows a power-law relationship with sample size of the form.

$$RSE = \frac{b}{\sqrt{n}}$$



**Figure 3-52: BMW 530E: Relative Standard Error vs. Sample Size for the Utility Factor based on Bootstrap Sampling.**

Developing an approach to the estimation of standard errors enabled the calculation of confidence intervals.

The confidence intervals were calculated to give an overall “family”  $\alpha$  level of 0.05 (95% confidence) for the entire dataset (i.e., all variants as an aggregate). The comparisons for



individual groups (i.e., models) were thus treated as analogous to multiple post-hoc comparisons of means following an ANOVA. For this purpose, we concluded that a one-sided Dunnett procedure would be most appropriate.

The lower and upper limits of the confidence interval (LCL, UCL) for the UF for a group were calculated as:

**Equation 3-6:**

$$LCL = UF \left( 1 - q_{1-\alpha,n,c} \left( \frac{b}{\sqrt{n}} \right) \right), \quad UCL = UF \left( 1 + q_{1-\alpha,n,c} \left( \frac{b}{\sqrt{n}} \right) \right)$$

where:

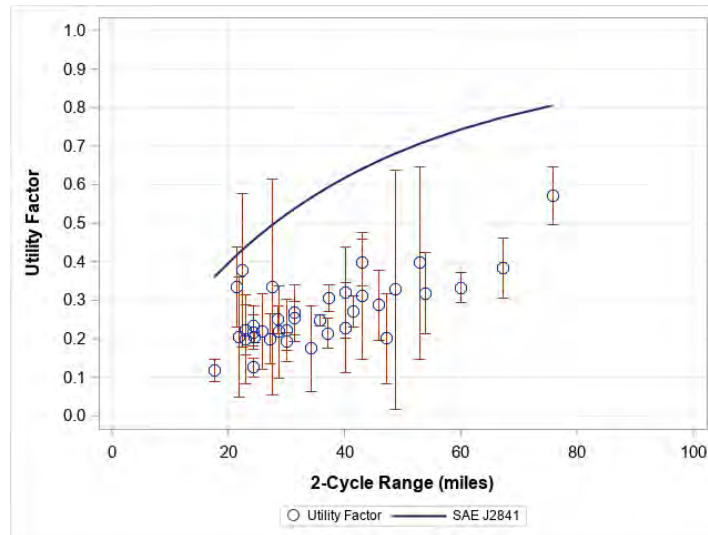
UF = the utility factor for a model, based on one of the three definitions given above,

$q_{1-\alpha,n,c}$  = the  $q$  statistic for a one-sided Dunnett procedure for an overall  $\alpha$  level of 0.05, a group sample size of  $n$  vehicles, for  $c$  comparisons,

$b/\sqrt{n}$  = the RSE for a sample size of  $n$ , as defined above.

**3.4.3.3.3 Comparison to the SAE J2841 Trend**

Figure 3-53 shows the blended utility factors plotted against the mean CD range for each model. The confidence intervals represent one-sided Dunnett comparisons, as described above, to represent a set of one-sided comparisons against the SAE J2841 UF trend. For this set of comparisons, models were dropped if the lower end of the confidence interval spanned 0.0 (LCL < 0). This result occurs for small samples where the RSE is greater than 0.40. This requirement effectively excludes sample sizes of fewer than about 10 vehicles for a model.



**Figure 3-53: Blended Utility Factor (UF) vs CD range, by model, with one-sided Dunnett confidence intervals.**

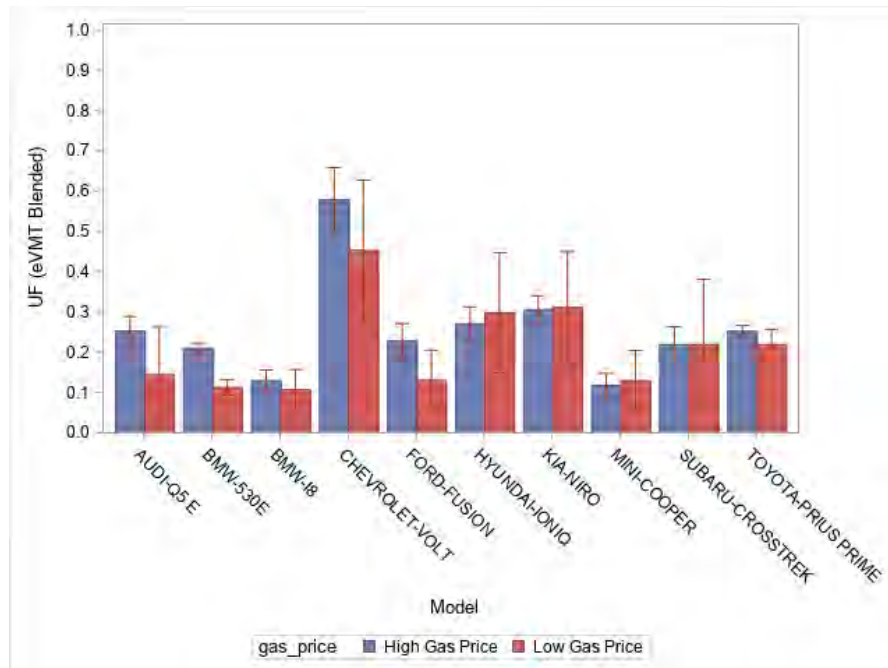
The confidence intervals for the vast majority of models do not span the SAE J2841 UF trend, suggesting that the measured UFs are lower than the trend. Results vary by method. For the blended UFs, confidence intervals for three models span the SAE trend. For an overall alpha level of 0.05, we would expect about two models ( $0.05 \times 40$ ) to appear significant based on

random chance. For a sample of about 40 models, though, up to 4 models could appear significant by chance. Based merely on several examples, it would not be appropriate to reject a conclusion that, on the whole, UF is significantly lower than the SAE trend.

### 3.4.3.3.4 Influence of Gasoline Price

One or more commenters noted that much of the driving reflected in the dataset under consideration took place during the pandemic, and that gasoline prices were lower during this period than after the pandemic ended. The question is whether reduced gasoline prices could have influenced driver behavior during this period, ostensibly by reducing the frequency of charging. To examine this question, we partitioned the dataset to distinguish tests occurring during periods of ‘low’ and ‘high’ gasoline prices. Specifically, we distinguished data collection points occurring before and after April 1, 2021, with times before and after this date taken as "low" and "high" gasoline-price conditions, respectively.

This comparison is restricted to a set of 10 models for which the samples sizes were adequate for both price levels. Accordingly, we calculated two-sided Dunnett confidence intervals for an overall alpha level of 0.05 and 10 comparisons. Confidence intervals are consistently narrower for the ‘high price’ condition, indicating that most trips took place after the reference date. For model years 2022 and 2023, all driving would have taken place after the reference date.

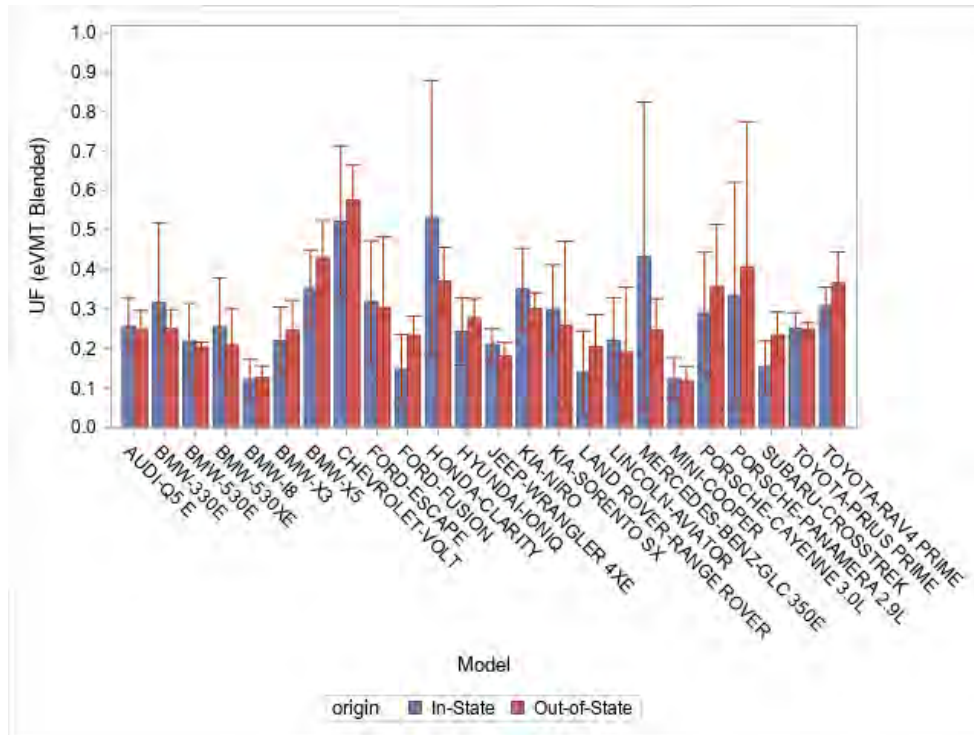


**Figure 3-54: Blended Utility Factor by Gasoline-price Level for Selected Models.**

Figure 3-54 shows the comparisons for the blended UF. Directionally, the UF is higher for the ‘high’ price for six of the 11 models. For most models, the comparison does not appear significant. However, for several models, it does look significant. For two models in particular, the BMW 530E and the Ford Fusion, the comparison looks significant and in the same direction, with the UF lower for the ‘low’ price condition. For an overall alpha level of 0.05 we might expect a maximum of about two comparisons to appear significant out of a sample of 10. Comparisons for the UF for the other two definitions showed similar results.

### 3.4.3.3.5 Influence of Geographic Origin

The fact that tests in the dataset are non-routine tests for vehicles within the exemption period raised an additional question. Given that non-negligible fractions of these vehicles represent vehicle owners moving into California from out of state, they may have potentially driven the vehicles over long distances, perhaps hundreds to thousands of miles, to get to California. A stakeholder suggested that driving behavior could differ on long trips, with vehicle owners experiencing less need to plug in than in routine commuting behavior, and that reduced charging frequency could effectively reduce UF.



**Figure 3-55: Blended Utility Factor by Origin for Selected Models.**

Based on information received from CARB, we were able to distinguish in-state and out-of-state vehicles. To approach the question, we calculated UF separately for in- and out-of-state groups. Out of the total, 24 models have adequate sub-samples for both groups to allow comparisons. As with gas price, we calculated two-sided Dunnett confidence intervals, for an overall alpha level of 0.05 for a family of 24 comparisons.

Figure 3-55 shows the comparisons in the UF by origin. The difference is not large for most models. The in-state UF is higher for nine models and lower or very close for the remainder. Examinations suggest that none of the individual comparisons look significant. Overall, it appears that this factor is not a major or consistent influence in the UF for PHEVs.

### 3.4.4 Other studies of FUF

We have analyzed available data and compiled literature (Aaron Isenstadt, Zifei Yang, Stephanie Searle, John German 2022), (Krajinska, Poliscanova, Mathieu, & Ambel, Transport & Environment 2020), (Plötz, P., Moll, C., Bieker, G., Mock, P., Li, Y. 2020), (Seshadri Srinivasa

Raghavan & Gil Tal 2022) showing that the SAE J2841 utility factors at the labeled CD ranges are overestimating the operation of PHEVs on electricity, and therefore would underestimate the CO<sub>2</sub> g/mile compliance result. European PHEV data were not used since the mean UF values for German company-owned PHEV vehicles were significantly lower than those for German privately owned PHEV vehicles (Plötz, P., Moll, C., Bieker, G., Mock, P., Li, Y. 2020). All the observed UF values (Seshadri Srinivasa Raghavan & Gil Tal 2022), except those driven by early adopters of the discontinued Chevrolet Volt Gen1 Extended Range Electric Vehicles (EREVs), were lower than the referenced SAE J2841 UFs on the labeled CD ranges when using small volunteer private PHEV data, which consists of 3 PHEV models and four model variants of 153 PHEV owners (out of 19000 recruited owners) in USA.

Much of the literature on PHEV utility factor is presented using label CD range. However, this is not directly comparable to the FUF used for GHG certification purposes, which is based on the 2-cycle combined CD range. The label CD ranges are calculated by multiplying the 2-cycle combined GHG emission-certified CD ranges by the "0.7" 5-cycle adjustment factor. The UF values in the referenced literature were analyzed at the labeled CD ranges, which were reduced by at least 30-percent from 2-cycle combined GHG emission certified CD ranges. The differences between the labeled CD ranges and 2-cycle GHG emission-certified CD ranges are more than 30 percent when including OEM voluntary adjustments. For example, the 47-mile 2-cycle GHG emission-certified CD range of the 2022 Audi A7E PHEV was significantly reduced to the 26-mile label CD range by the inclusion of an additional 20 percent voluntary adjustment after applying the "0.7" 5-cycle adjustment factor. The 47-mile 2-cycle combined GHG emission-certified CD range of the 2022 Audi A7E is about 81 percent higher than the 26-mile labeled CD range. Therefore, those UF values in the literature are significantly lower when translating the same UF values from the labeled CD ranges to the 43 percent higher 2-cycle combined GHG emission-certified CD ranges. In fact, the UF values at the labeled CD ranges, which are called the MDIUF (Multi-Day Individual Utility Factor), are not directly relevant to the FUF Finalized at 2-cycle combined CD ranges for GHG emission certifications. We do not propose to update the MDIUF curve, and the labeled values of the EV/CD ranges and electric energy consumption rates which are already adjusted using the "0.7" 5-cycle adjustment factor used for CAFE standards compliance and labelling the all-electric ranges and CD ranges of PHEV vehicle stickers. When including OEM's voluntary labeled CD range reductions, the FUF values on 2-cycle combined GHG emission-certified CD ranges are not directly related to the MDIUF (Multi-Day Individual Utility Factor) on the labeled CD ranges. Therefore, the UF values on the labeled CD ranges in the literature cannot be directly compared to the FUF values on 2-cycle combined GHG emission-certified CD ranges.

#### **3.4.5 Consideration of CARB ACC II PHEV Provisions**

CARB recently set minimum performance requirements for PHEVs in their ACC II program. These requirements include performance over the US06 test cycle and a minimum range and are meant to set qualifications for PHEV's to be included in a manufacturer's ZEV compliance. EPA received comments that it should adopt ACC II for PHEVs. ACC II is a suite of emissions standards that includes a ZEV mandate and other tools EPA is not using in this rule and it would not be appropriate to take only the PHEV portions of ACC II. EPA is not adopting the range and US06 performance requirements or fleet penetration limits that are included in the CARB ACC II ZEV provisions. EPA agrees that PHEVs meeting the performance provisions required by CARB in ACC II have the potential to provide greater environmental benefits as compared to

other PHEVs that are less capable. However, unlike the ACC II program, the GHG program in this rulemaking is performance-based and not a ZEV mandate. In that regard, EPA believes that it is appropriate to have a robust GHG compliance program for PHEVs that properly accounts for their GHG emissions independent of a PHEV's range or capability over the US06 test cycle. We are addressing the issue of ensuring appropriate GHG compliance values for PHEVs through the revised PHEV fleet utility factor as described in section III.C.8 of the preamble; EPA is not adopting design requirements for PHEVs, that is, we are not adopting minimum range requirements or specifying minimum capability over any prescribed test cycles.

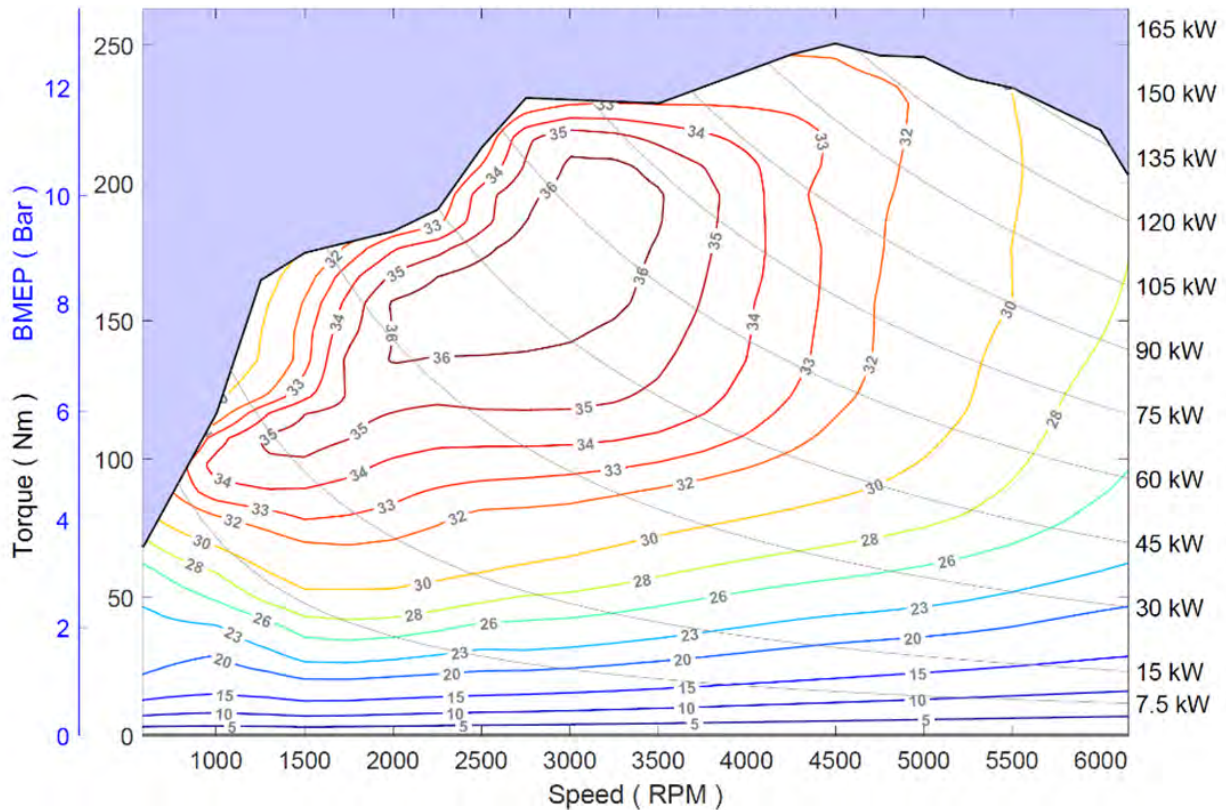
### **3.5 GHG Emissions Control Technologies**

#### **3.5.1 Engine Technologies**

The following is detailed information about the ALPHA inputs for internal combustion engines used to create ALPHA Outputs for Response Surface Equations (RSE's) used by OMEGA. These were first discussed and listed in Table 2-2. Specific details about each engine are contained in the engine's test data package available on EPA's webpage (U.S. EPA 2022b). These engine data packages are combined into a set of complete engine maps suitable for use in vehicle simulation models which are contained in a .zip file identified using the engine name mentioned in the caption of the associated ALPHA efficiency map shown below (U.S. EPA 2023b).

##### **3.5.1.1 2013 Chevrolet 2.5L Ecotec LCV Engine Reg E10 Fuel**

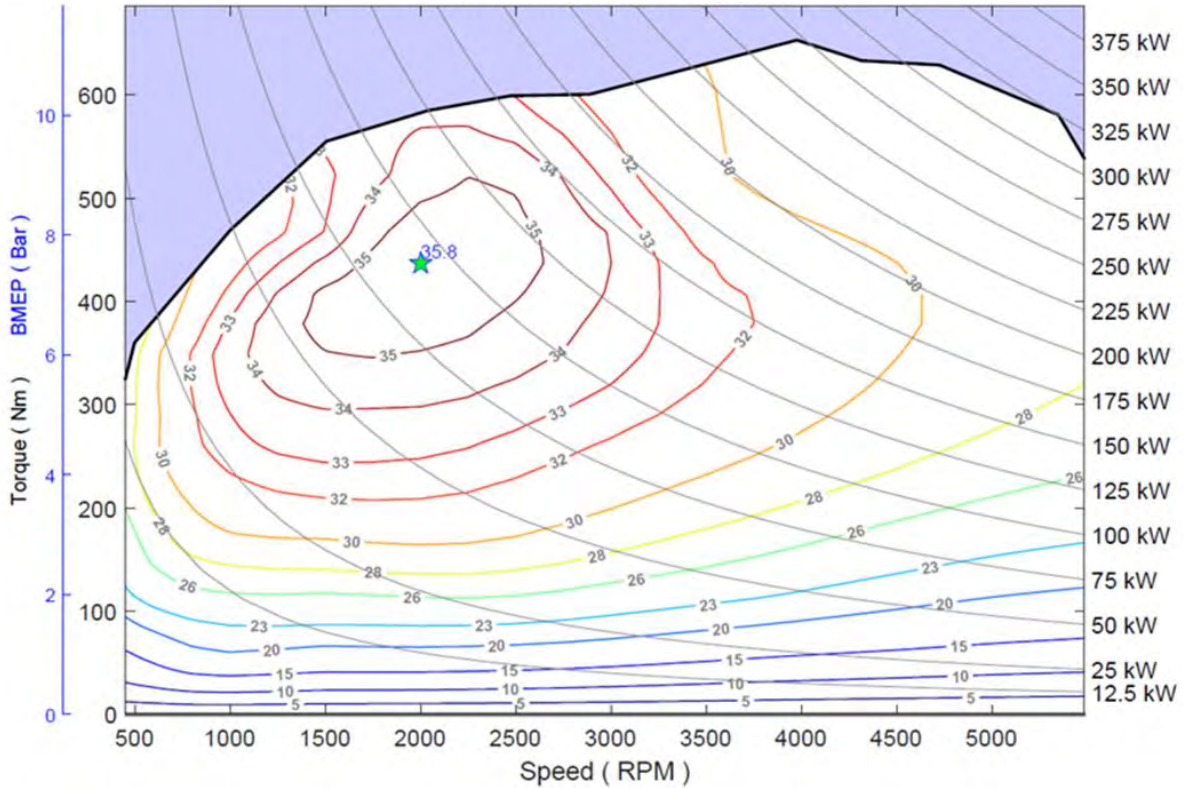
This naturally aspirated engine features continuously variable valve timing, high-pressure direct injection, electronic throttle control, coil-on-plugs and has an 11.3:1 compression ratio. Testing was conducted in a test cell operated by FEV Engine Technologies and purchased to support the Mid Term Evaluation (MTE) Engine Benchmarking project. (Newman, K., Kargul, J., and Barba, D. 2015).



**Figure 3-56: 2013 Chevrolet 2.5L Ecotec LCV Engine Reg E10 Fuel BTE (%) (U.S. EPA 2023b).**

### 3.5.1.2 GT Power Baseline 2020 Ford 7.3L Engine from Argonne Report Tier 3 Fuel

This medium-duty naturally aspirated engine included port fuel injection, a 2-valve head, and a 10.5 compression ratio. The engine was modeled in GT-Power® and then calibrated and validated against test data available at Southwest Research Institute or provided by the Original Equipment Manufacturers (OEMs). (Thomas E. Reinhart 2021) The provided baseline model was configured to simulate wide-open throttle operation with power enrichment and used a Wiebe function for describing combustion. Once the model achieved satisfactory results, the engine performance was mapped over the speed and load range.



**Figure 3-57: GT Power Baseline 2020 Ford 7.3L Engine from Argonne Report Tier 3 Fuel BTE (%) (U.S. EPA 2023b).**

### 3.5.1.3 2013 Ford 1.6L EcoBoost Engine LEV III Fuel

The selected feature of this turbocharged gasoline engine was the inclusion of spray-guided direct-injection. The testing was performed by the EPA at the National Center for Advanced Technology (NCAT) with the engine installed in a dynamometer test cell tethered as though the engine were operating in the vehicle. (Mark Stuhldreher, Charles Schenk, Jessica Brakora, David Hawkins, Andrew Moskalik, and Paul DeKraker 2015)

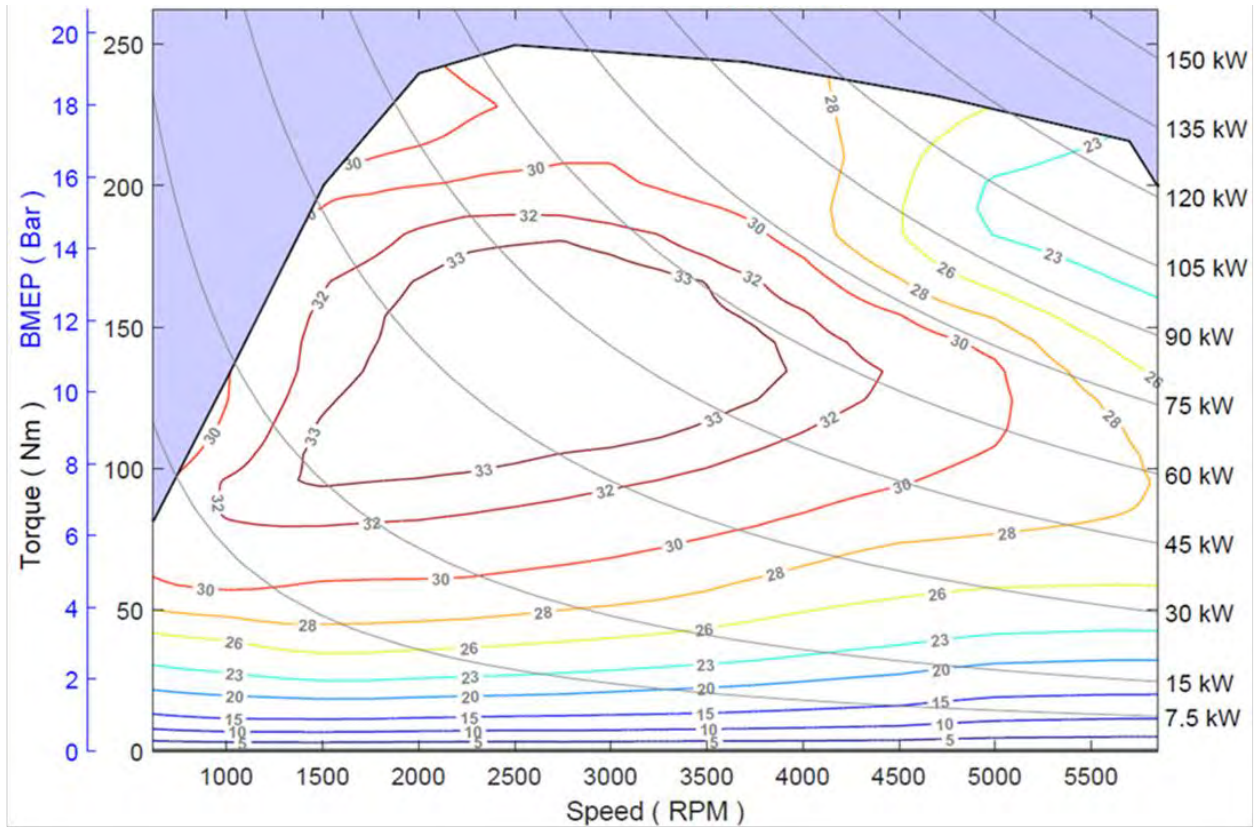


Figure 3-58: 2013 Ford 1.6L EcoBoost Engine LEV III Fuel BTE (%) (U.S. EPA 2023b).



### 3.5.1.4 2015 Ford 2.7L EcoBoost Engine Tier 3 Fuel

This turbocharged engine features intake and exhaust cam phasing, direct injection, and integrated exhaust manifolds. The testing was performed by the EPA at the National Center for Advanced Technology (NCAT) with the engine installed in a dynamometer test cell tethered as though the engine were operating in the vehicle. This testing provided thorough test data for constructing the main operating portion of the engine map. There was also subsequent testing in a heavy-duty test cell to generate additional data for the high speed and high load mapping needed to construct a more complete engine map.

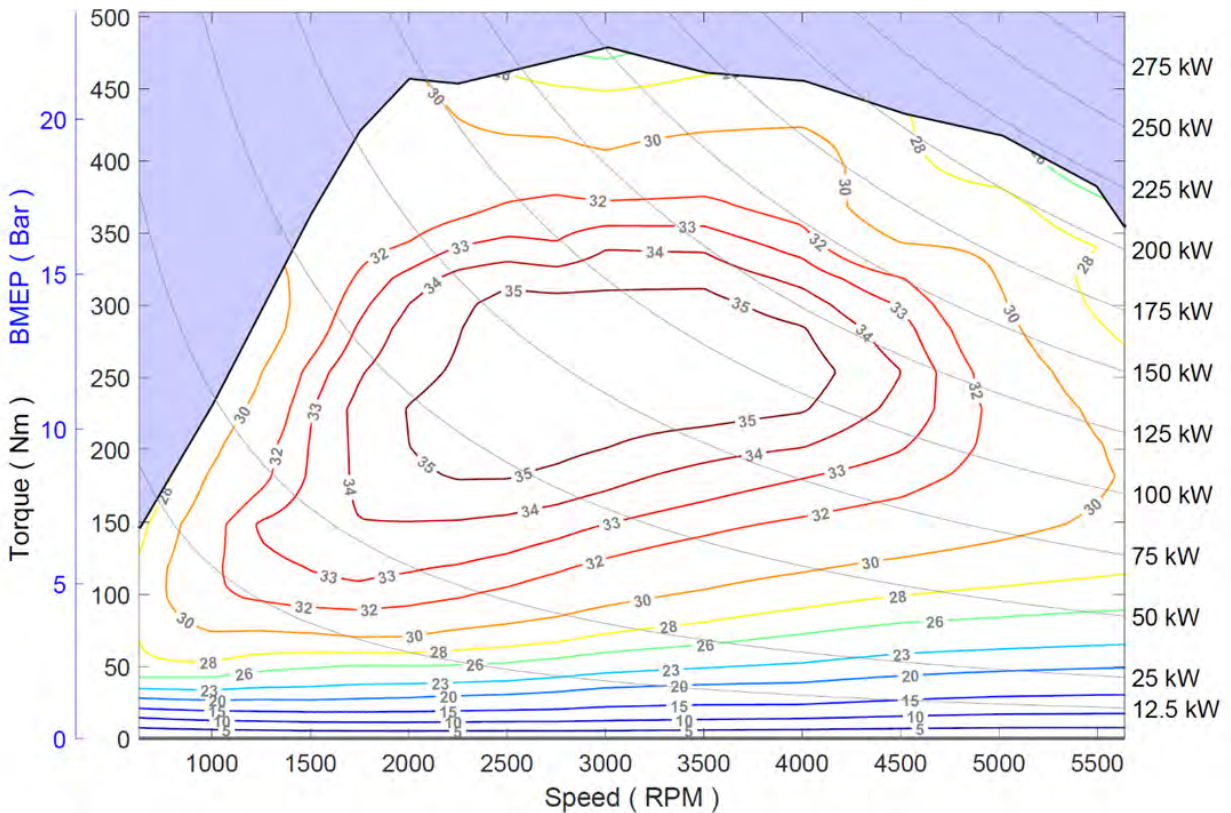


Figure 3-59: 2015 Ford 2.7L EcoBoost V6 Engine Tier 3 Fuel BTE (%) (U.S. EPA 2023b).

### 3.5.1.5 2016 Honda 1.5L L15B7 Engine Tier 3 Fuel

Features of this engine include direct-injection, single-scroll turbocharger, and dual variable valve timing control (VTC). The testing was performed by the EPA at the National Center for Advanced Technology (NCAT) with the engine installed in a dynamometer test cell tethered as though the engine were operating in the vehicle. (Stuhldreher, Mark; Kargul, John; Barba, Daniel; McDonald, Joseph; Bohac, Stanislav; Dekraker, Paul; Moskalik, Andrew 2018) The engine was coupled to the dynamometer using a modified manual transmission and clutch with a torsional spring assembly and rubber isolated driveshaft to allow for stable torque measurements. Both steady-state and transient engine test data were collected during the benchmark testing. Two different test procedures were needed to appropriately replicate steady-state engine operation at low/mid loads and transient engine operation at high loads when the engine is protecting itself.

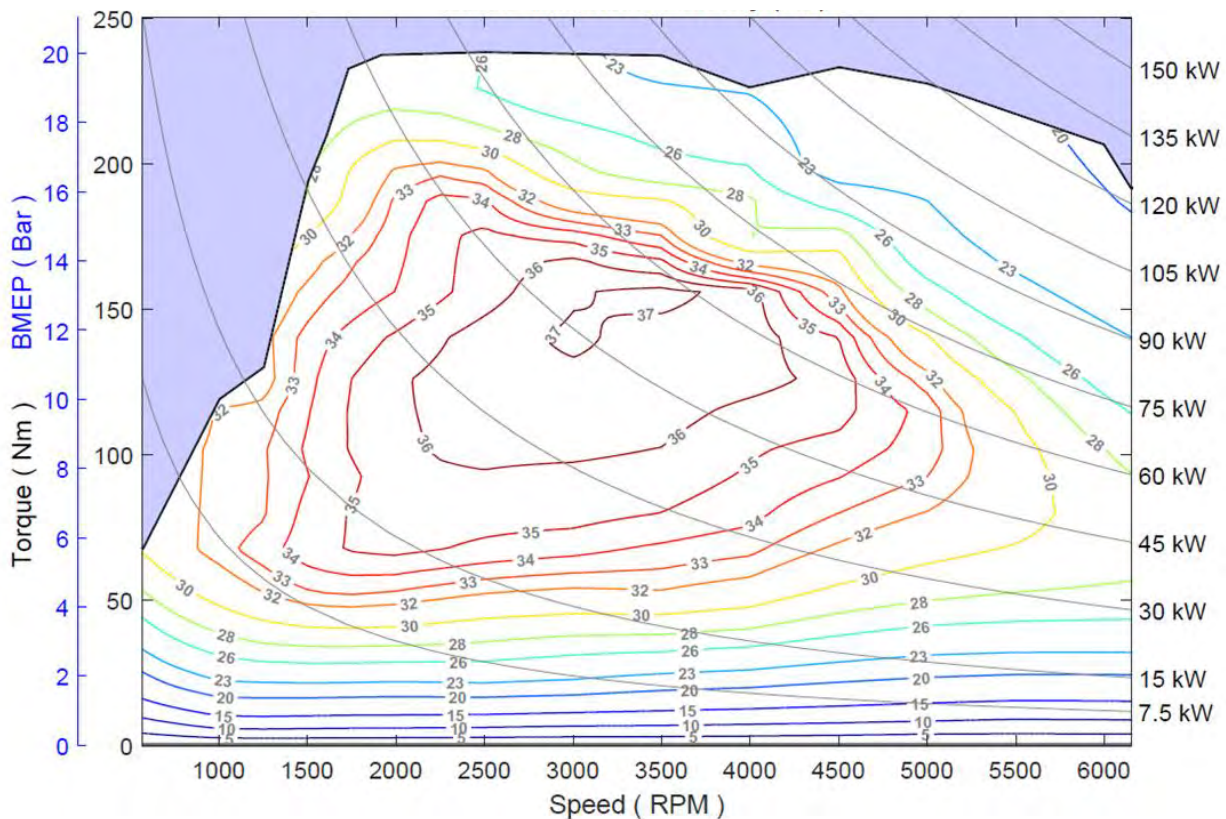


Figure 3-60: 2016 Honda 1.5L L15B7 Engine Tier 3 Fuel BTE (%) (U.S. EPA 2023b).

### 3.5.1.6 Volvo VEP 2.0L LP Gen3 Miller Engine from 2020 Aachen Paper Octane Modified for Tier 3 Fuel

This Miller cycle engine includes an increased compression ratio, a short intake valve opening duration, an integrated exhaust manifold, a new intake port and piston design together with a VGT turbo as described in Dahl et al (2020), "*The New Volvo Mild Hybrid Miller Engine*" presented in Aachen Colloquium Automobile and Engine Technology. (Daniel Dahl, Ayolt Helmantel, Fredrik Wemmert, Mats Morén, Staffan Rengmyr, and Ali Sahraeian 2020). The image provided in this paper was digitized by loading the image into MATLAB and manually tracing the efficiency contours. NCAT used the peak BSFC and BTE values referenced in the paper to calculate the lower heating value for the test fuel having a reported RON of 98 and because the authors did not provide any test data for this engine using Tier 3 fuel, the decision was made to use ALPHA's Octane Modifier to develop an estimated Tier 3 fuel map.

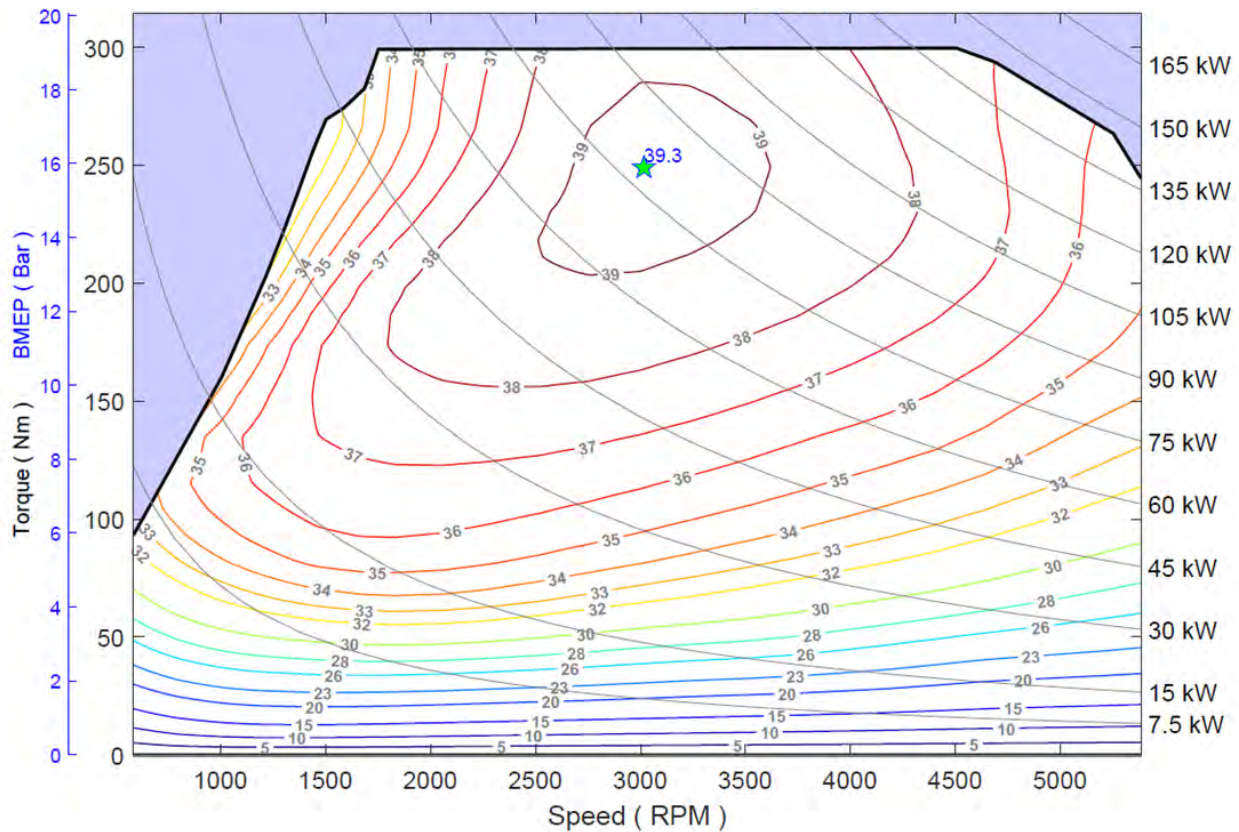
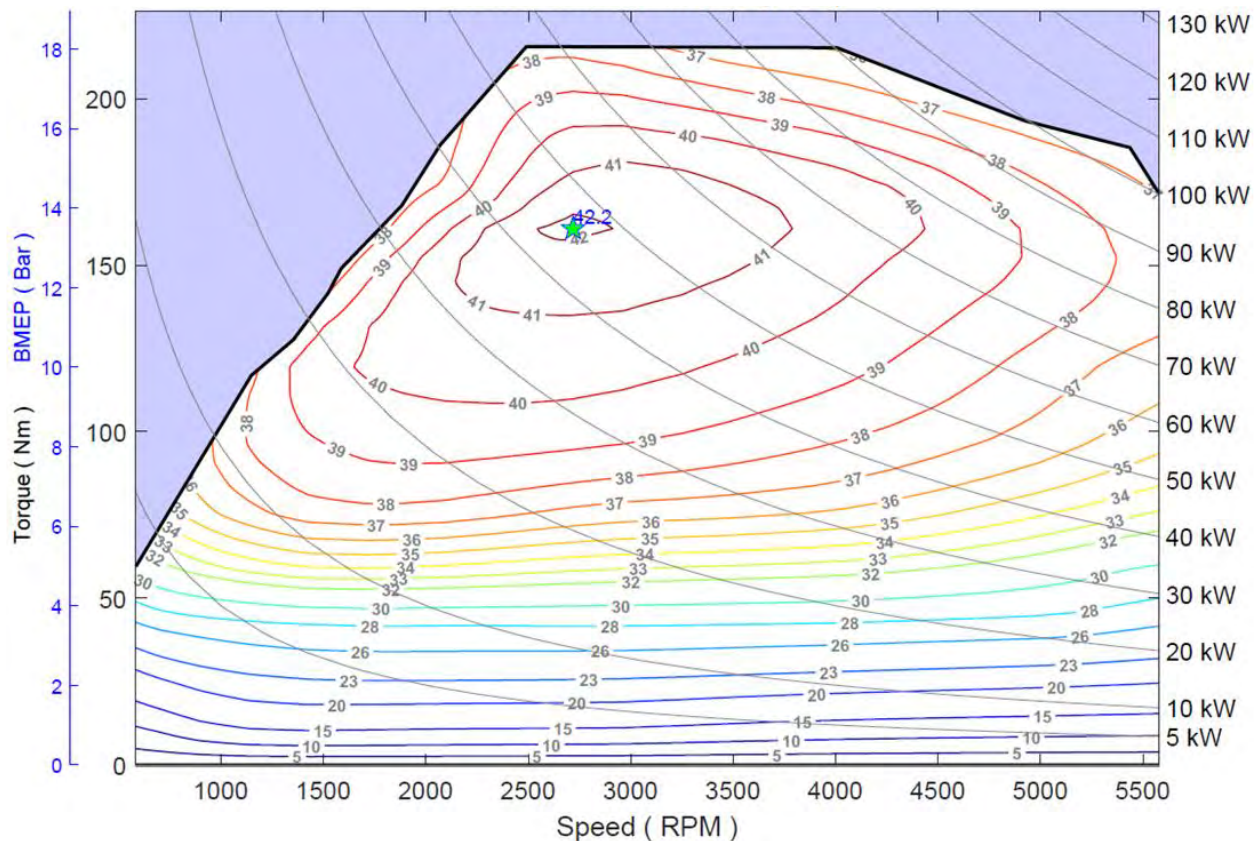


Figure 3-61: Volvo 2.0L VEP LP Gen3 Miller Engine from 2020 Aachen Paper Octane Modified for Tier 3 Fuel BTE (%) (U.S. EPA 2023b).

### 3.5.1.7 Geely 1.5L Miller GHE from 2020 Aachen Paper Octane Modified for Tier 3 Fuel

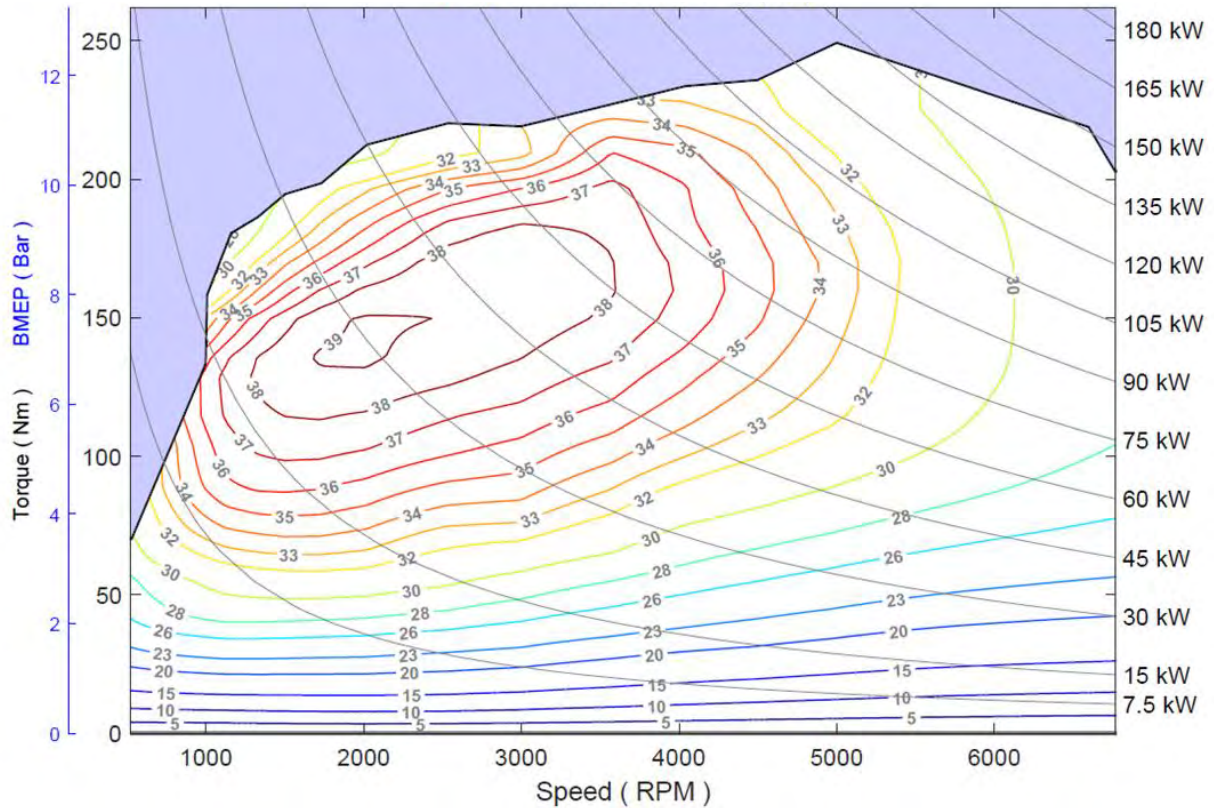
Zhang et al (2020), "Geely Hybrid Engine: World Class Efficiency for Hybrid Vehicles" presented in the 29th Aachen Colloquium (GuiQiang Zhang, Qian Wang, Guang Chen, et al. 2020) reported this engine has a high efficiency Miller-cycle combustion system with high tumble and turbulence kinetic energy, low friction, optimized mixture formation using a new 350 bar fuel injection system and a 13:1 compression ratio. These features are then combined with a fully matched turbocharger with highly cooled low pressure EGR and a water-charge air cooler. The image provided in this paper was digitized by loading the image into MATLAB and manually tracing the efficiency contours. Since the fuel used to map this engine had a relatively high lower heating value there was an assumption of a likely corresponding high RON value of 98 and because the authors did not provide any test data for this engine using Tier 3 fuel, the decision was made to use ALPHA's Octane Modifier to develop an estimated Tier 3 fuel map.



**Figure 3-62: Geely 1.5L Miller GHE from 2020 Aachen Paper Octane Modified for Tier 3 Fuel BTE (%) (U.S. EPA 2023b).**

### 3.5.1.8 2018 Toyota 2.5L A25A-FKS Engine Tier 3 Fuel

This 4-cylinder, naturally aspirated, Atkinson Cycle gasoline engine with cooled-EGR also includes direct & port injection, VVT electric intake & hydraulic exhaust, high induction turbulence/high speed combustion, high energy ignition, friction reduction, a variable capacity oil pump, and an electric water pump. The testing was performed by the EPA at the National Center for Advanced Technology (NCAT) with the engine installed in a dynamometer test cell tethered as though the engine were operating in the vehicle. The engine was coupled to the dynamometer using an automatic transmission and torque converter to allow for an accurate gathering of test data where the torque measurement is very sensitive to the engine's torsional accelerations. (John Kargul, Mark Stuhldreher, Dan Barba, Charles Schenk, Stani Bohac, Joseph McDonald, and Paul Dekraker 2019).



**Figure 3-63: 2018 Toyota 2.5L A25A-FKS Engine Tier3 Fuel BTE (%) (U.S. EPA 2023b).**

### 3.5.1.9 Toyota 2.5L TNGA Prototype Hybrid Engine from 2017 Vienna Paper Octane Modified for Tier 3 Fuel

This inline 4 cylinder 2.5L gasoline naturally aspirated (NA) engine is thoroughly described in Tadashi Toda et al (2017), *"The New Inline 4 Cylinder 2.5L Gasoline Engine with Toyota New Global Architecture Concept"* presented at Internationales Wiener Motorensymposium. (T. Toda, M. Sakai, M. Hakariya, and T. Kato 2017). Features include high energy ignition coil motor-driven VVT for Atkinson cycle, a D-4S system (direct and port injection) with new multi hole injectors, cooled EGR, and a variable oil-pressure pump system. The image provided in this paper was digitized by loading the image into MATLAB and manually tracing the efficiency contours. There was no information presented regarding the fuel used for the map, so the decision was made to assume the data in the paper was based on a Tier 2 fuel and use ALPHA's Octane Modifier to develop an estimated Tier 3 fuel map.

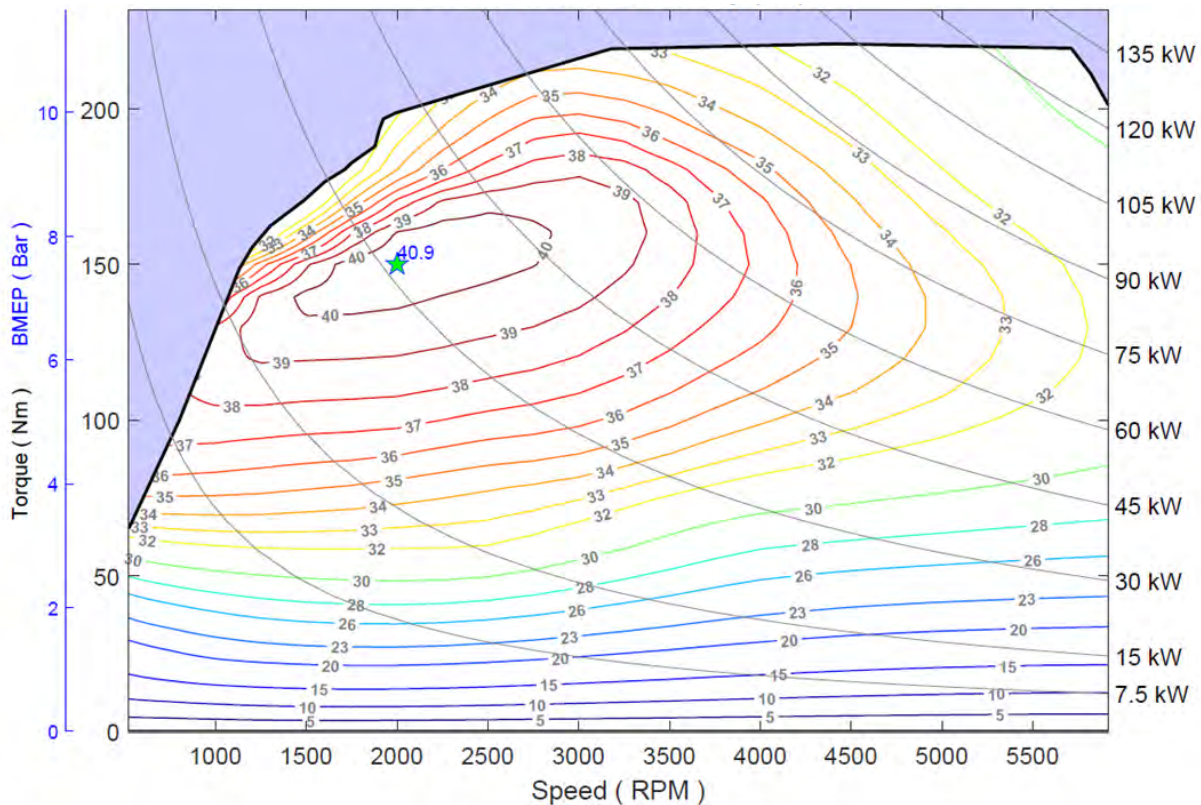


Figure 3-64: Toyota 2.5L TNGA Prototype Hybrid Engine from 2017 Vienna Paper Octane Modified for Tier 3 Fuel BTE (%) (U.S. EPA 2023b).

### 3.5.1.10 GT Power 2020 GM 3.0L Duramax Engine from Argonne Report Diesel Fuel

This in-line six-cylinder four-stroke engine features cooled low-pressure-loop and un-cooled high-pressure-loop EGR systems with a variable geometry turbine, water-to-air charge air cooling that uses a separate low temperature coolant loop, and a variable intake manifold with dual air intake paths. The light duty diesel combines high-pressure loop EGR with low pressure loop EGR to reduce the pumping work required to flow EGR, uses very little EGR at high load and has very low friction for a diesel engine. The engine was modeled in GT-Power® and then calibrated and validated against test data available at Southwest Research Institute or provided by the Original Equipment Manufacturers (OEMs). Once the model achieved satisfactory results, the engine performance was mapped over the speed and load range. The image and any supporting data available were digitized by loading the image into MATLAB and manually tracing the efficiency contours.

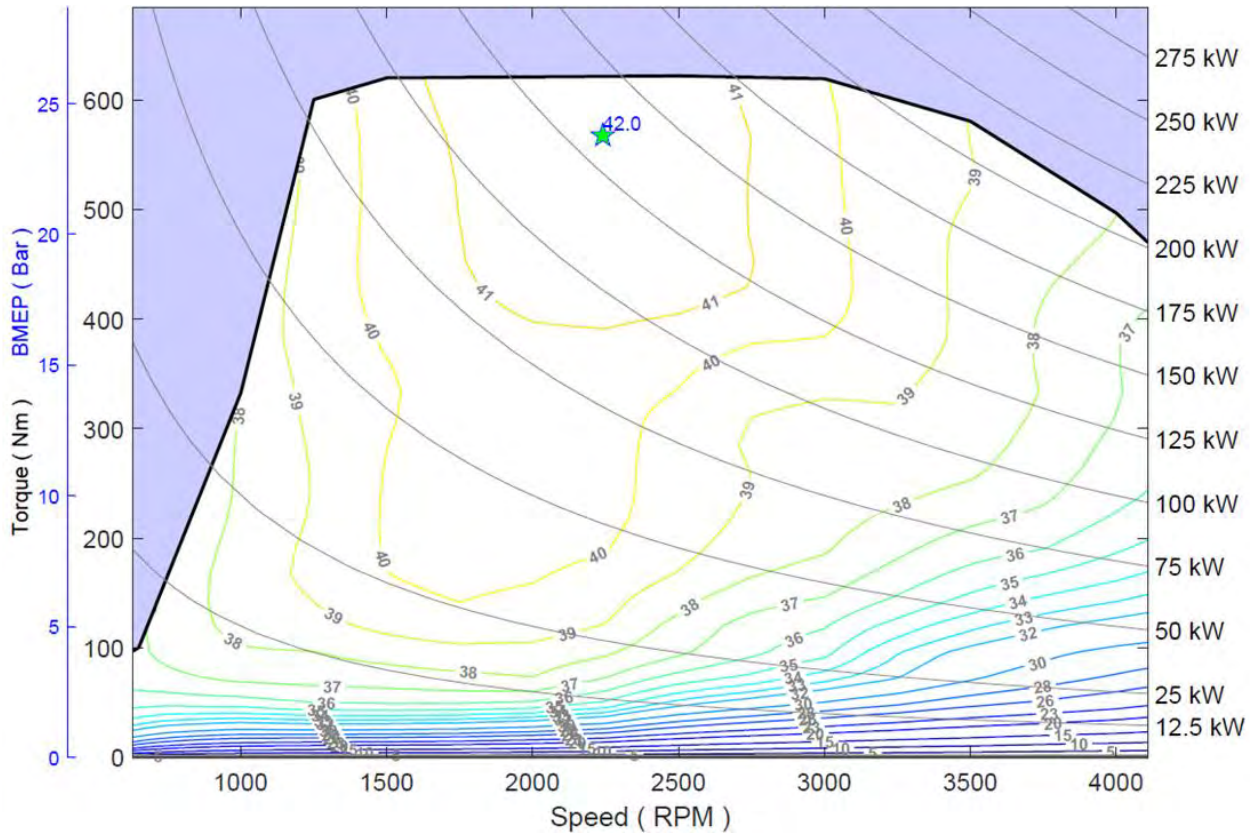
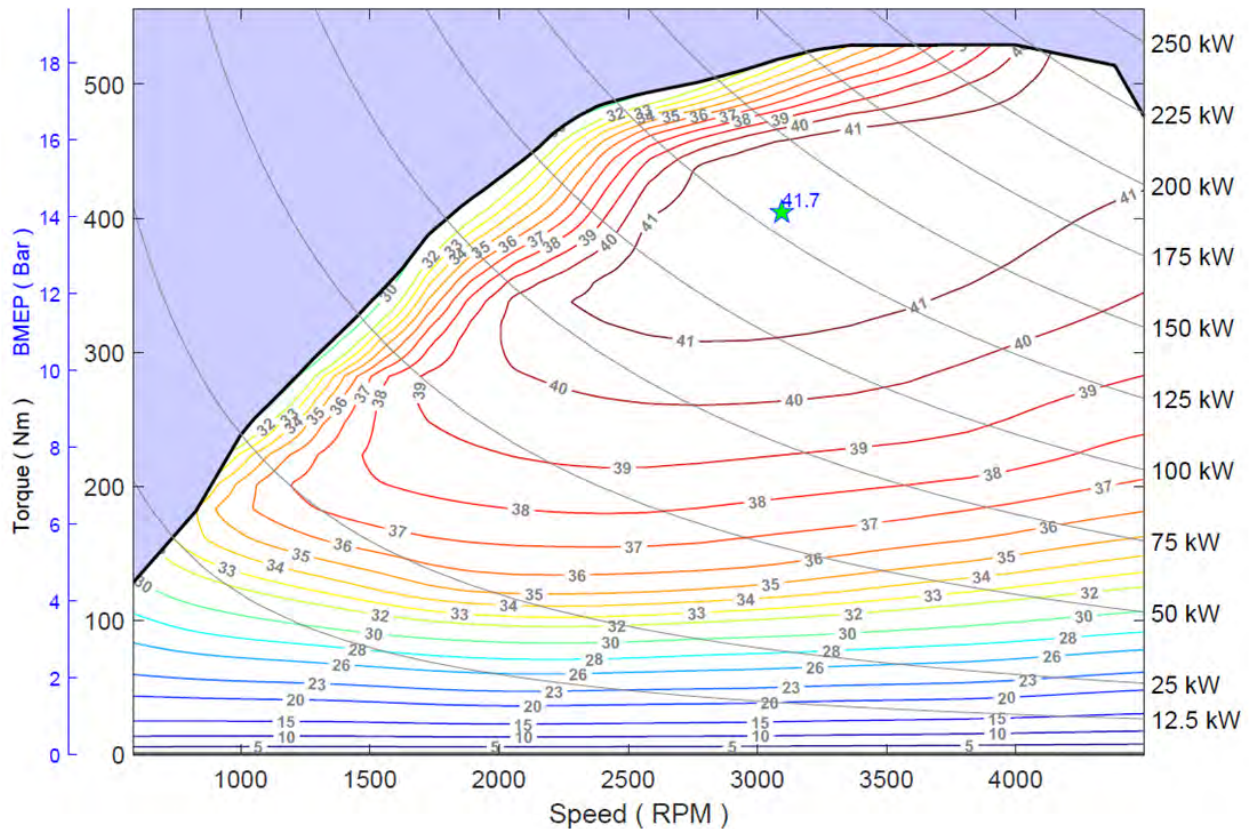


Figure 3-65: GT Power 2020 GM 3.0L Duramax Engine from Argonne Report Diesel Fuel BTE (%) (U.S. EPA 2023b).

### 3.5.1.11 Future 3.6L HLA Hybrid Concept Engine Tier 3 Fuel

Future high load application (HLA) vehicles such as hybrid light and medium duty body-on-frame vehicles with towing capabilities as discussed in the REET report (Bhattacharjya, S., et al. 2023) will likely require dedicated hybrid engines such as the concept for a 3.6L V6 HLA hybrid engine.

ALPHA's "VW 1.5L TSI evo Hybrid Concept 4 Engine from 2019 Aachen Paper Octane Modified for Tier 3 Fuel" (U.S. EPA 2023b) engine map was used to derive an upsized concept for a future V6 3.6L HLA hybrid engine map. There is a likelihood design changes may be necessary to increase the durability of the original light-duty engine to be suitable for a work truck with heavy sustained towing applications. Therefore, when deriving the scaled map using the original 1.5L engine, surface-to-volume heat transfer effects were ignored, and the efficiency of the original engine was maintained. Additionally, adjustments were made to the wide-open throttle (WOT) line to account for tendencies of larger cylinders to knock under heavy loads.



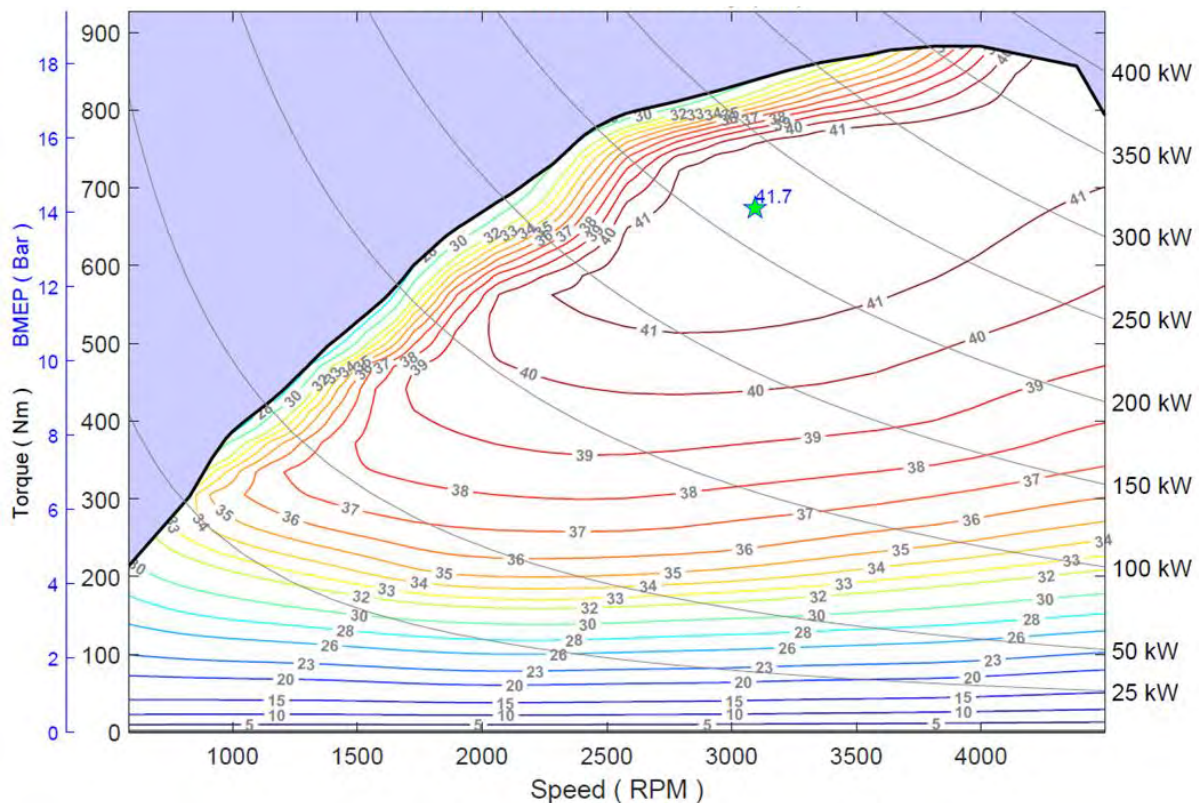
**Figure 3-66: Future 3.6L HLA Hybrid Concept Engine Tier 3 Fuel BTE (%) (adapted from VW 1.5L TSI evo Hybrid Concept 4 engine from 2019 Aachen Paper Octane Modified for Tier 3 Fuel).**



### 3.5.1.12 Future 6.0L HLA Hybrid Concept Engine Tier 3 Fuel

Future HLA vehicles such as hybrid light and medium duty body-on-frame vehicles with towing capabilities as discussed in the REET report (Bhattacharjya, S., et al. 2023) will likely require dedicated hybrid engines such as the concept for a 6.0L V6 HLA hybrid engine.

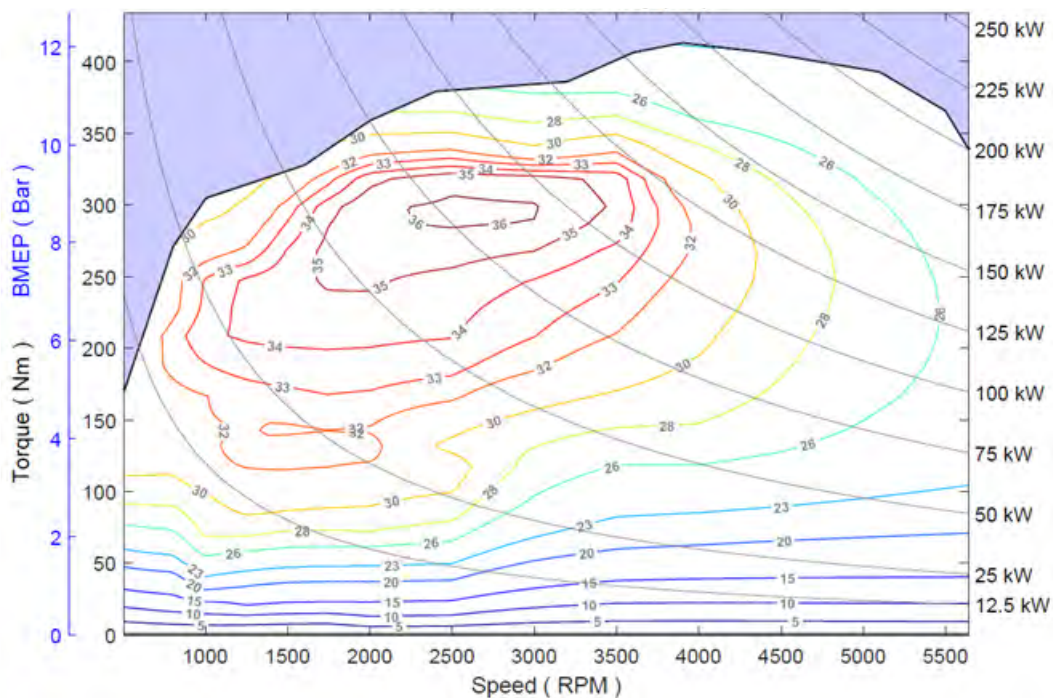
ALPHA's "VW 1.5L TSI evo Hybrid Concept 4 engine from 2019 Aachen Paper Octane Modified for Tier 3 Fuel" (U.S. EPA 2023b) engine map was used to derive an upsized concept for a future V6 6.0L HLA hybrid engine map. There is a likelihood design changes may be necessary to increase the durability of the original light-duty engine to one suitable for a work truck with heavy sustained towing applications. Therefore, when deriving the scaled map using the original 1.5L engine, surface-to-volume heat transfer effects were ignored, and the efficiency of the original engine was maintained. Additionally, adjustments were made to the wide-open throttle (WOT) line to account for tendencies of larger cylinders to knock under heavy loads.



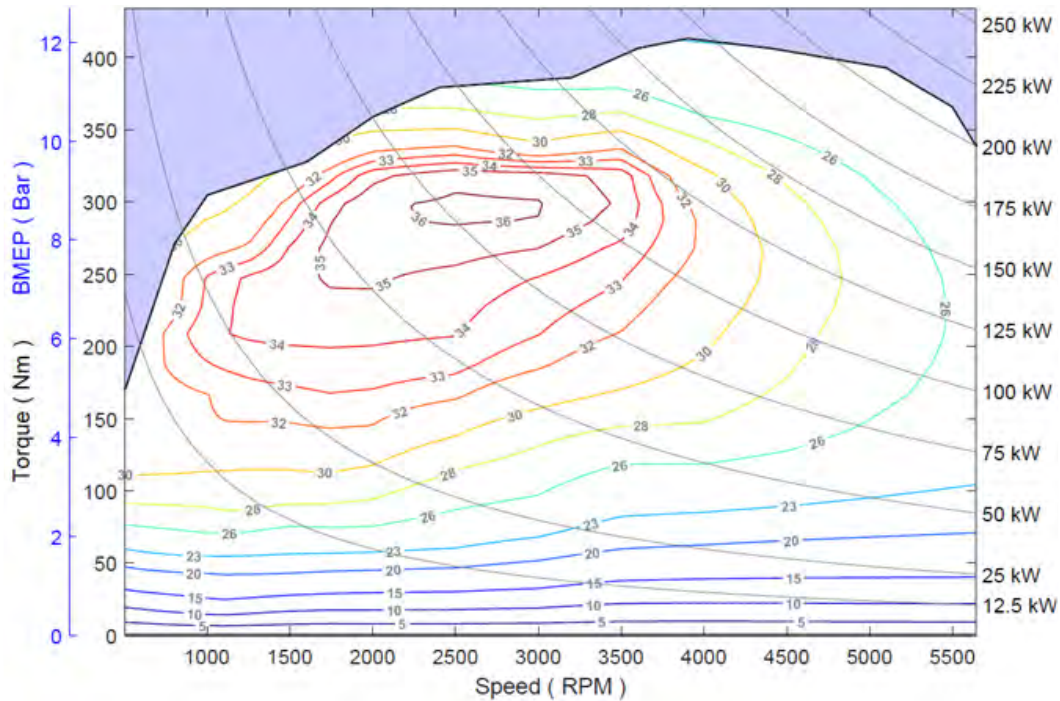
**Figure 3-67: Future 6.0L HLA Hybrid Concept Engine Tier 3 Fuel BTE (%) (adapted from VW 1.5L TSI evo Hybrid Concept 4 engine from 2019 Aachen Paper Octane Modified for Tier 3 Fuel).**

### 3.5.1.13 2014 Chevrolet 4.3L EcoTec3 LV3 Engine LEVIII Fuel

Features of this engine include side mount direct-injection, cylinder deactivation, continuously variable valve timing, pushrod, single cam, and active fuel management. The engine uses cylinder deactivation to improve thermal efficiency by reducing pumping losses during low-load operation. This testing was performed by the EPA at the National Center for Advanced Technology (NCAT) with the engine installed in a dynamometer test cell tethered as though the engine were operating in the vehicle. (Mark Stuhldreher 2016) Two methods of coupling the engine to the dynamometer were needed to gather data where the torque measurement was very sensitive to the engine's torsional accelerations. Direct drive shaft engine to dynamometer coupling worked best to gather most of the data but where needed, the engine was coupled to the dynamometer through its transmission and torque converter.



**Figure 3-68: 2014 Chevrolet 4.3L EcoTec3 LV3 Engine LEVIII Fuel - Cylinder Deac Enabled BTE (%) (U.S. EPA 2023b).**



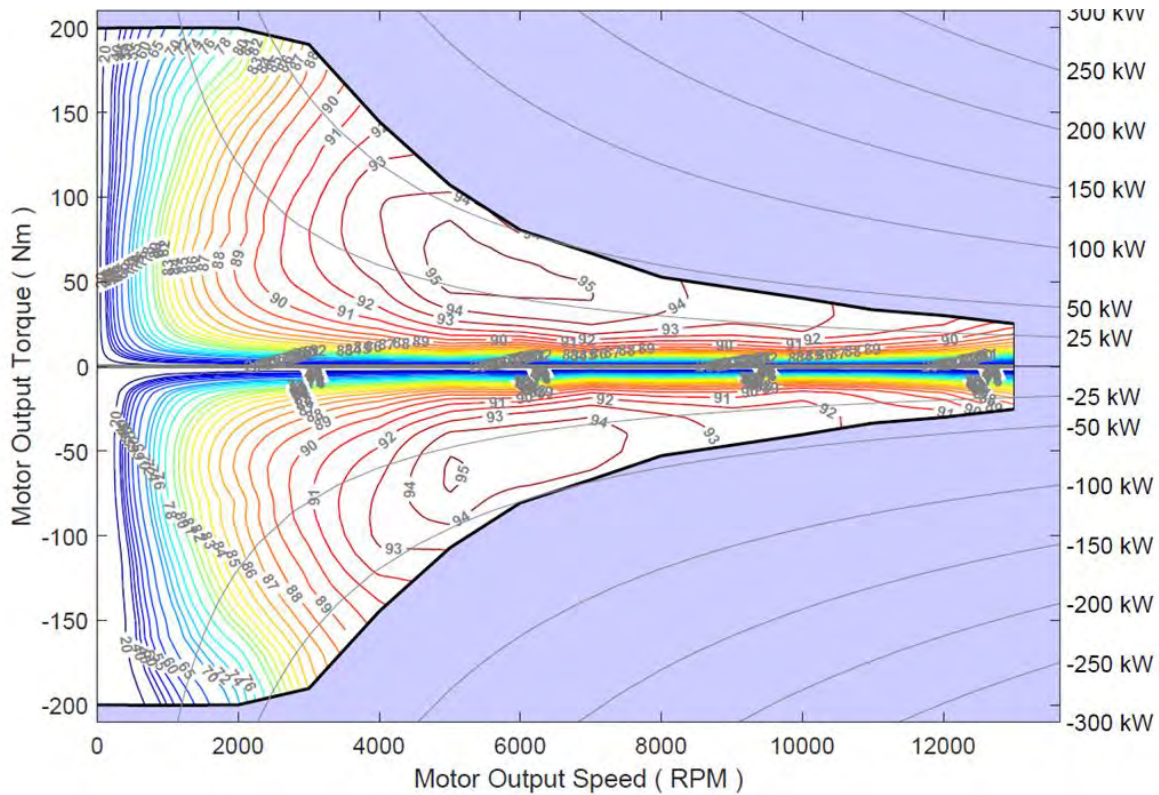
**Figure 3-69: 2014 Chevrolet 4.3L EcoTec3 LV3 Engine LEV VIII Fuel - Cylinder Deactivation BTE (%) (U.S. EPA 2023b).**

### **3.5.2 Electrification Technologies**

The following is detailed information about the ALPHA inputs for electric inverters, motors, and generators used to create ALPHA Outputs for Response Surface Equations (RSE's) used by OMEGA. These were first discussed and listed in Table 2-3. Specific details about each electric motor are contained in its ALPHA test package available on EPA's webpage (U.S. EPA 2023a). Each motor package is contained in a .zip file identified using the electric motor name mentioned in the caption of the associated ALPHA efficiency map shown below.

#### **3.5.2.1 2010 Toyota Prius 60kW 650V MG2 EMOT**

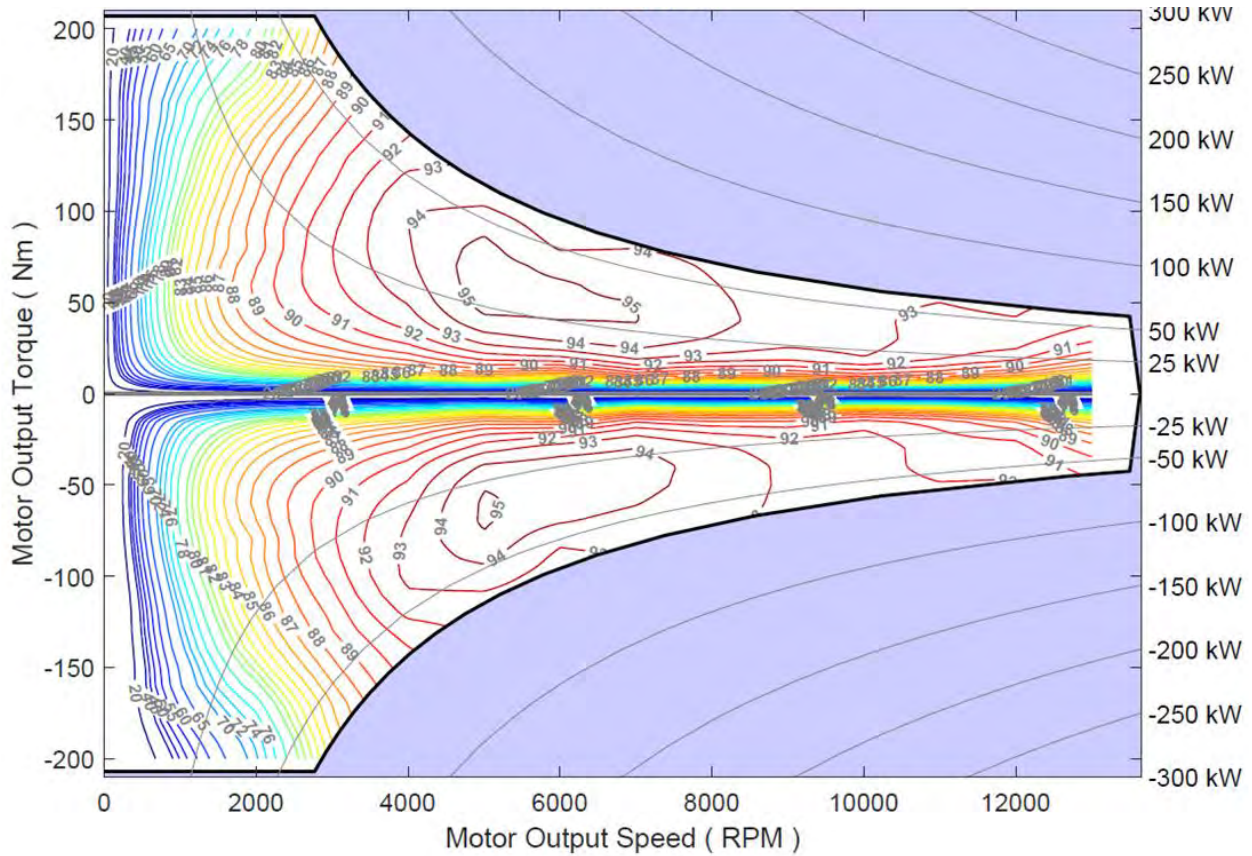
The 60kW 650V MG2 electric motor paired with an inverter and a 36hp (27kW) nickel-metal hydride battery pack was combined with a 1.8L 4-cylinder Atkinson cycle engine. The component benchmarking testing for this program was conducted by Oak Ridge National Laboratory's (ORNL) Power Electronics and Electric Machinery Research Center (PEEMRC), a broad-based research center for power electronics and electric machinery (e-motor) development. (Olszewski, Mitch 2011). The resulting measurements were used to create a combined efficiency map of the main drive e-motor and inverter without including any gearing, categorized together as an EMOT.



**Figure 3-70: 2010 Toyota Prius 60kW 650V MG2 EMOT Efficiency (%) (U.S. EPA 2023a).**

### 3.5.2.2 EST 2010 Toyota Prius 60kW 650V MG1 EMOT

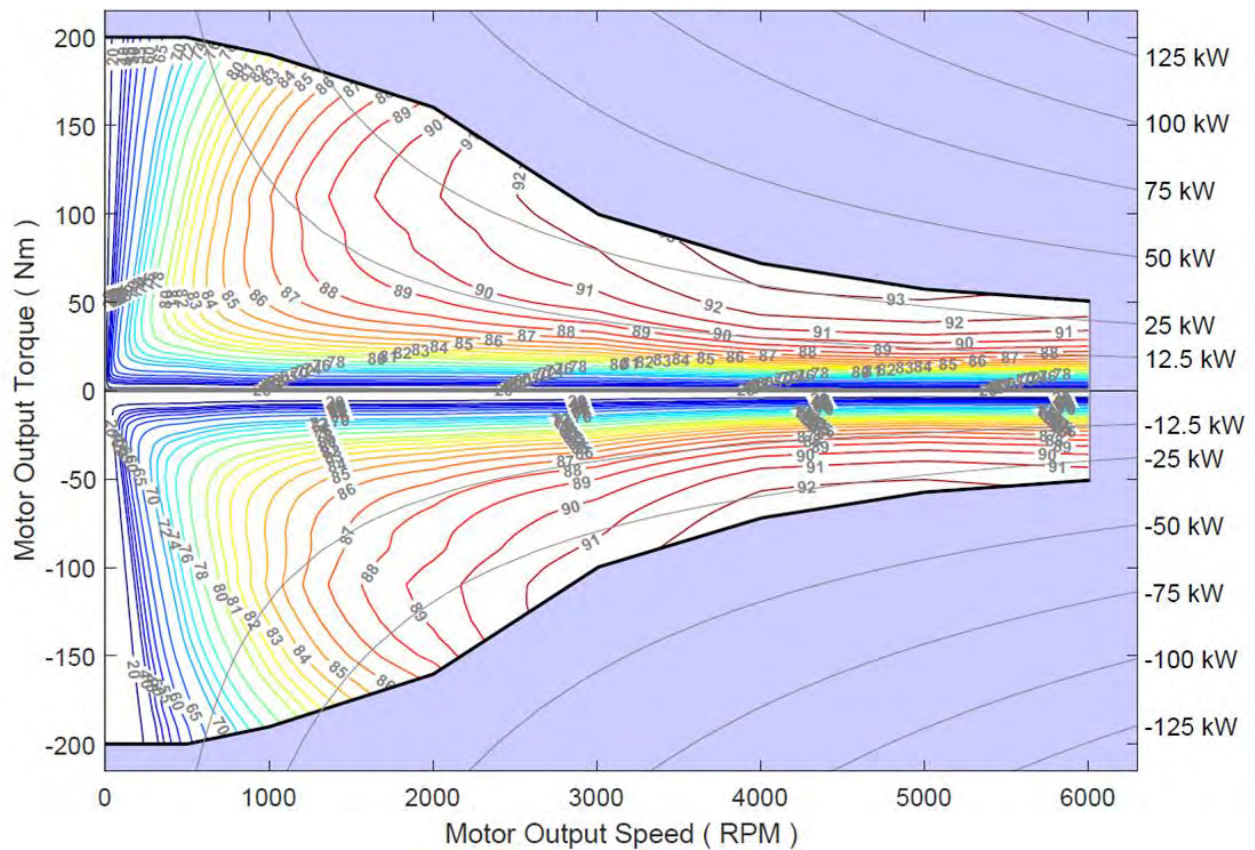
The Toyota Prius uses a secondary electric motor called an MG1, which functions as a generator to transfer power from the ICE to recharge the battery and functions as a motor to start the ICE. Oak Ridge National Laboratory (ORNL) did not specifically benchmark this electric generator motor, presumably because of its similarity to the MG2 electric drive motor discussed in the previous section; MG2 functions as a motor when propelling the vehicle and acts as a generator during regenerative braking function. (Olszewski, Mitch 2011). However, chassis test data provided by Southwest Research Institute (SwRI) indicated the maximum operating power for the MG1 generator motor is different than the MG2 drive motor. The maximum power curve for the MG1 is a constant value rather than variable as MG2's power curve. Consequently, the MG2 ORNL benchmark data was used along with the max power data provided from the SwRI chassis test data to create a constant power version for the MG1. The MG1 efficiency map estimates the combined efficiency of the main generator e-motor and its inverter, categorized together as an EMOT. The "EST" in the front of the e-motor's name indicates this is an estimated map.



**Figure 3-71: Est 2010 Toyota Prius 60kW 650V MG1 EMOT Efficiency (%) (U.S. EPA 2023a).**

### 3.5.2.3 2011 Hyundai Sonata 30kW 270V EMOT

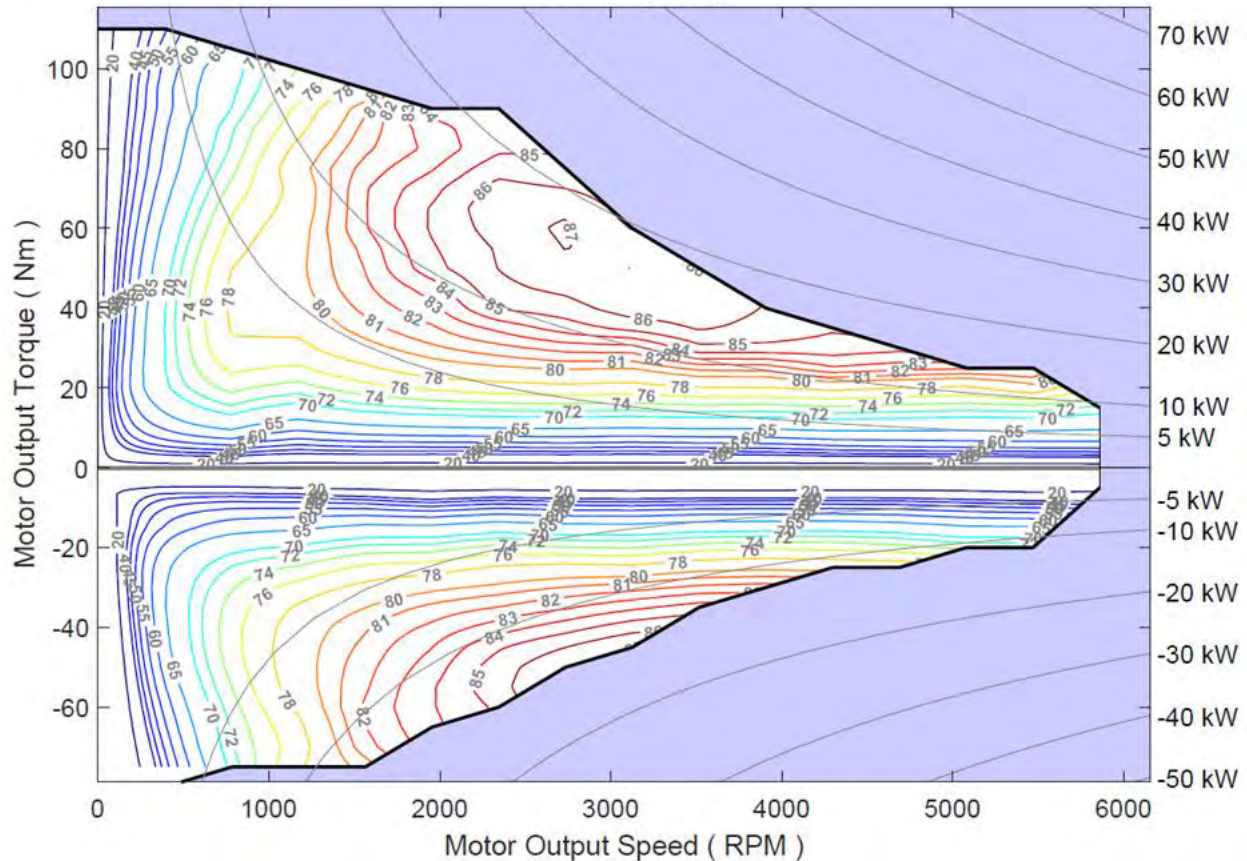
This 30 kW 270V electric motor was paired with an inverter, categorized together as an EMOT, and powered by a 270-volt lithium polymer battery. The map was created using benchmarked data that measured the efficiency of the combination of the main drive e-motor and its inverter without including any gearing. The component testing for this program was conducted by Oak Ridge National Laboratory’s (ORNL) Power Electronics and Electric Machinery Research Center (PEEMRC), a broad-based research center for power electronics and electric machinery (e-motor) development. (Rogers, Susan 2012).



**Figure 3-72: 2011 Hyundai Sonata 30kW 270V EMOT Efficiency (%) (U.S. EPA 2023a).**

### 3.5.2.4 2012 Hyundai Sonata 8.5kW 270V BISG

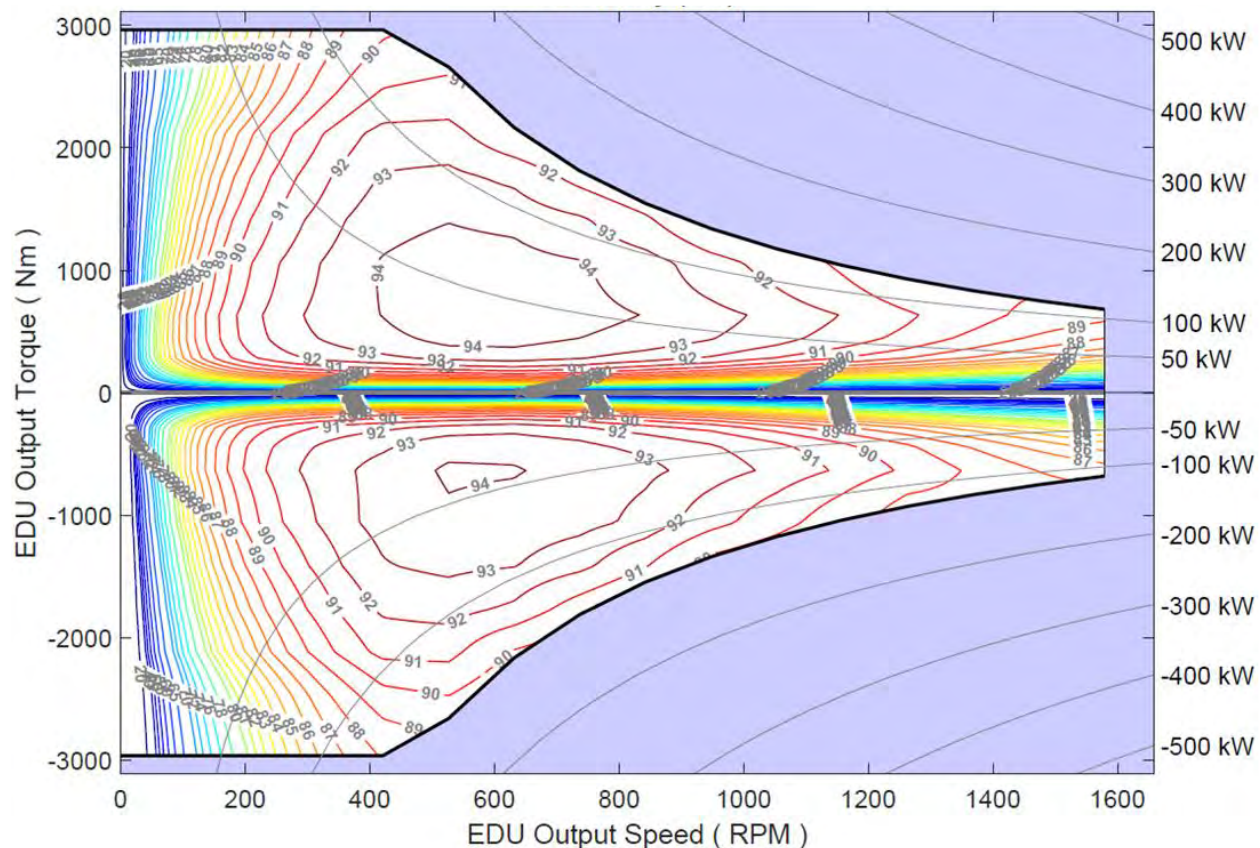
Hyundai’s Hybrid Starter Generator (HSG) electric motor with published specifications listed as 43 Nm, 8.5kW, and 15,750 rpm was paired with an inverter and powered by a 270-volt lithium polymer battery. The application of this type of electric motor is normally found in mild hybrid electric vehicles (MHEV), often called P0 mild hybrids. The goal was to create a map representing the combined efficiency of the starter/generator motor, its inverter, and the drive belt, categorized together as a BISG (belt-inverter-starter/generator). The component testing for this program was conducted by Oak Ridge National Laboratory’s (ORNL) Power Electronics and Electric Machinery Research Center (PEEMRC), a broad-based research center for power electronics and electric machinery (e-motor) development. (Rogers, Susan 2013).



**Figure 3-73: 2012 Hyundai Sonata 8.5kW 270V BISG Efficiency (%) (U.S. EPA 2023a).**

### 3.5.2.5 Generic IPM 150kW 350V EDU

The Generic IPM 150kW 350V Electric Drive Unit (EDU) efficiency map was generated using confidential benchmarking test data from several state-of-the-art internal permanent magnet synchronous reluctance (IPMSRM) e-motors used in current production battery electric vehicles. Transformation functions whose coefficients represent the averaged power consumption data were utilized to blend and transform the confidential test data. The final map was then scaled to 150kW to represent a generic EDU suitable for use in a BEV. The generated efficiency map represents the combined operating boundaries and electrical power consumption of the electric motor, inverter, and gearing, categorized together as an EDU. The gear ratio for this EDU is 9.5:1.



**Figure 3-74: Generic IPM 150kW EDU Efficiency (%) (U.S. EPA 2023a).**

### **3.5.2.6 Three IPM Electric Motor/Inverters (EMOTs) used to Simulate Future LD PHEVs and MD PHEVs with Towing Capability**

ALPHA has input data representing three modern IPM electric motor/inverters (EMOTs) suitable to simulate electric drive systems for future LD and MD PHEVs. EPA received confidential supplier data for these advanced motors and inverters which was evaluated and compared with other data available to EPA from other advanced electric motor and inverter systems. The evaluation determined these EMOTs were suitable to simulate electric drive systems for future light- and medium-duty towing hybrids, which were studied and documented in the REET report. (Bhattacharjya, S., et al. 2023). The input data used to create these ALPHA inputs is confidential, therefore we are unable to include copies of their efficiency maps in this document. For this rulemaking these ALPHA inputs are known as CBI-A, CBI-B, and CBI-C.

### **3.5.3 Vehicle Architectures**

A summary of the vehicle architectures used in ALPHA 3.0 is provided in Section 2.4.4. Figure 2-6 summarizes the seven vehicle models used to simulate vehicle efficiency, including the one conventional (ICE) model used in previous versions of ALPHA, the five new hybrid electric models (including a mild hybrid and four strong hybrids), and the one new battery electric vehicle model added for ALPHA 3.0. Three of the hybrid models were available in the



previous version of ALPHA. The P2-P4 hybrid (REET) and the SP-P4 Hybrid (REET) models are new to ALPHA 3.0. They are described in the next section.

### **3.5.3.1 Heavy-light-duty and Medium-duty Range-extended Electric Truck (REET) Study**

In 2022, EPA conducted a study of LDT4 and MDV pickup trucks under contract with Southwest Research Institute (SwRI) and with assistance from Argonne National Laboratory to determine how plug-in hybrid electric vehicles (PHEVs) with significant all-electric capability, or “range extended electric trucks” (REET), may assist in the transition to electrification of these vehicle classes. (U.S. EPA 2022). Two pickup trucks representing high-volume examples of LDT4 and MDV pickup trucks were selected to serve as baseline vehicles. Simulations were conducted using Gamma Technologies GT-SUITE to model the baseline vehicles and potential REET vehicle designs over regulatory drive cycles and simulation of the SAE J2807 "Performance Requirements for Determining Tow-Vehicle Gross Combination Weight Rating and Trailer Weight Rating" (SAE 2016).

The base LDT4 pickup selected for the study was a MY2021 Ford F150 equipped with a 3.5L turbocharged, direct- and port-injection gasoline engine with a rated power of 298 kW. The F150 was equipped with a "Max Trailer Tow Package" and had a GCWR of approximately 19,500 pounds. The base MDV pickup selected was a MY2021 Stellantis RAM 2500 equipped with a 6.7L Cummins diesel engine with a rated power of 275 kW and a GCWR of approximately 30,000 pounds. Please refer to the final report for this study for further details regarding the design of the study, procedures used, and results. (Bhattacharjya,S., et al. 2023).

#### **3.5.3.1.1 LDT4 Range-extended Electric Truck (REET)**

The following targeted design criteria for the LDT4 REET simulation were established:

- Battery sizing consistent with CARB ACC II Light-duty PHEV Requirements (State of California, Air Resources Board 2022)
- 50-mile electric vehicle label range
- 40-mile all-electric-range on the US06 drive cycle
- 0-60 mph at ETW (6,500 pounds) equivalent to baseline 2021 Ford F150<sup>35</sup>
- 0-60 mph acceleration during towing at approximately 19,500 pounds GCWR of less than 30 seconds as per SAE J2807, 4.3.1 (SAE 2016); and SAE J1491, 4.3.2 and 4.3.3 (SAE 2006).
- 0-30 mph acceleration during towing at approximately 19,500 pounds GCWR of less than 12 seconds as per SAE J2807, 4.3.1; and SAE J1491, 4.3.2 and 4.3.3.

---

<sup>35</sup> Note that the Ford F150 had an ETW of 5,500 pounds. The LDT4 REET configurations was approximately 1,000 pounds heavier due to the battery pack weight, electric drive system weight, and other components and was rounded to the nearest ETW weight increment (6,500 pounds) from 40 CFR 86.129-94 (40 CFR § 86.129-94 2022) .

- 40-60 mph acceleration during towing at approximately 19,500 pounds GCWR of less than 18 seconds as per SAE J2807, 4.3.1; and SAE J1491, 4.3.2 and 4.3.3.
- Launch on 12% grade at approximately 19,500 pounds GCWR as per SAE J2807, 4.3.4.
- Highway gradeability (commonly referred to as the Davis Dam Grade) during towing at approximately 19,500 pounds GCWR that maintained a minimum speed of 45 mph in sections with a 45-mph speed limit and 55 mph in sections with speed limits of 55 mph or 65 mph sections as per SAE J2807, 4.3.5.

**Based on initial vehicle simulations, two REET architectures were selected for further simulation runs and analysis. One was an all-wheel-drive P2-P4 configuration. The other was an all-wheel-drive series-parallel hybrid with two P4 machines and a separate motor-generator. Both configurations were modeled using a dedicated-hybrid 3.6L Miller cycle engine with 240 kW rated power. For a summary of the hybrid drive-system and battery specifications please refer to Table 3-29 and Table 3-30. For more details regarding the drive systems and the dedicated hybrid engine, please refer to the final report. (Bhattacharjya,S., et al. 2023). The electric machines used in both system configurations were internal-permanent-magnet synchronous machines using SiC inverters. CO<sub>2</sub> emissions and fuel economy (FE) simulation results over the UDDS, HWFET, combined cycle results, and US06 are summarized in Table 3-31 and Table 3-32.**

**Table 3-29: Hybrid drive system specifications used for LDT4 REET simulations.**

| Vehicle                  | Location                   | Scaled Max. Power (kW) | Scaled Max. Torque (Nm) | Max. Speed (rpm) | Base Speed (RPM) | Gear Ratio <sup>*, †, ‡</sup> |
|--------------------------|----------------------------|------------------------|-------------------------|------------------|------------------|-------------------------------|
| <b>P2-P4</b>             | P2                         | 120                    | 828                     | 6,000            | 1,500            | 3.73:1                        |
|                          | Front e-axle / P4          | 150                    | 311                     | 18,000           | 4,200            | 17:1                          |
| <b>Series - Parallel</b> | Generator                  | 240                    | 619                     | 13,500           | 3,500            | 0.75:1                        |
|                          | Rear series-parallel drive | 150                    | 276                     | 18,000           | 4,200            | 17:1                          |
|                          | Front e-axle / P4          | 150                    | 276                     | 18,000           | 4,200            | 17:1                          |

\*P2 gear ratio is for the final drive. Note that the P2 also incorporates a 10-speed automatic transmission prior to the final drive.  
†Gear reduction from engine to generator.  
‡P4 and series parallel use a single final-drive gear ratio.

**Table 3-30: Battery specifications used for LDT4 REET simulations.**

|                           | Series-Parallel     | P2-P4               |
|---------------------------|---------------------|---------------------|
| Cathode:                  | NMC811              | NMC811              |
| Anode:                    | 95% graphite, 5% Si | 95% graphite, 5% Si |
| Cells in Series:          | 86                  | 89                  |
| Cells in Parallel:        | 3                   | 3                   |
| Cell Capacity [Ah]:       | 40                  | 40                  |
| Cell Nominal Voltage [V]: | 3.7                 | 3.7                 |
| Pack Capacity [Ah]:       | 120                 | 120                 |
| Pack Nominal Voltage [V]: | 318.2               | 329.3               |
| Pack Energy [kWh]:        | 38.2                | 39.5                |
| Pack Weight [kg]:         | 208.7               | 215.9               |
| Max. SOC [%]:             | 90                  | 90                  |
| Min. SOC [%]:             | 15                  | 15                  |
| Useable Energy [kWh]:     | 28.6                | 29.6                |

**Table 3-31: Modeled Fuel Economy and CO<sub>2</sub> emissions comparison between the LDT4 Series-Parallel REET and 2021 Ford F-150 using Tier 3 regular-grade fuel.**

| Drive Cycle | 2021 Ford F150 (Baseline) Simulation Results* |          |                        | Class 2a REET Series-Parallel Results |                       |                                     |   | Percentage change from baseline** |                                  |  |
|-------------|---|----------|------------------------|---------------------------------------|-----------------------|-------------------------------------|---|-----------------------------------|----------------------------------|--|
|             | ETW [lbs.]                                    | FE [mpg] | CO <sub>2</sub> [g/mi] | ETW [lbs.]                            | FE <sup>†</sup> [mpg] | CO <sub>2</sub> <sup>†</sup> [g/mi] | EPA Compliance CO <sub>2</sub> <sup>††</sup> [g/mi] | FE <sup>†</sup> [%]               | CO <sub>2</sub> <sup>†</sup> [%] | EPA Compliance CO <sub>2</sub> <sup>††</sup> [%] |
| UDDS        | 5,500   | 18.8     | 455                    | 6,500                                 | 34.0                  | 252                                 | n/a   | 81%                               | -45%                             | n/a  |
| HWFET       | 5,500   | 24.8     | 345                    | 6,500                                 | 31.2                  | 274                                 | n/a   | 26%                               | -21%                             | n/a  |
| Combined    | 5,500   | 21.5     | 398                    | 6,500                                 | 32.7                  | 261                                 | 73.3  | 52%                               | -34%                             | -82%   |
| US06        | 5,500   | 15.1     | 566                    | 6,500                                 | 22.4                  | 382                                 | n/a   | 48%                               | -32%                             | n/a  |

\* Baseline simulation results were validated via chassis dynamometer testing. Simulation results are shown to provide a comparable basis of comparison between the baseline configuration and REET configuration. Please refer to the final report for validation results (Bhattacharjya,S., et al. 2023).

\*\* A negative % CO<sub>2</sub> change means less emissions with respect to the baseline 2021 Ford F-150.

† Charge-sustaining operation only.

†† Takes into account a fully-phased-in (2031) fleet utility factor (FUF) 0.719 based on modeled all-electric range.

**Table 3-32: Modeled Fuel Economy and CO<sub>2</sub> emissions comparison between the LDT4 P2-P4 REET and 2021 Ford F-150 using Tier 3 regular-grade fuel.**

| Drive Cycle | 2021 Ford F150 (Baseline) Simulation Results* |          |                        | Class 2a REET P2/P4 Results |                       |                                     |   | Percentage change from baseline** |                                  |  |
|-------------|---|----------|------------------------|-----------------------------|-----------------------|-------------------------------------|---|-----------------------------------|----------------------------------|--|
|             | ETW [lbs.]                                    | FE [mpg] | CO <sub>2</sub> [g/mi] | ETW [lbs.]                  | FE <sup>†</sup> [mpg] | CO <sub>2</sub> <sup>†</sup> [g/mi] | EPA Compliance CO <sub>2</sub> <sup>††</sup> [g/mi] | FE <sup>†</sup> [%]               | CO <sub>2</sub> <sup>†</sup> [%] | EPA Compliance CO <sub>2</sub> <sup>††</sup> [%] |
| UDDS        | 5,500   | 18.8     | 455                    | 6,500                       | 32.3                  | 265                                 | n/a   | 72%                               | -42%                             | n/a  |
| HWFET       | 5,500   | 24.8     | 345                    | 6,500                       | 29.1                  | 294                                 | n/a   | 18%                               | -15%                             | n/a  |
| Combined    | 5,500   | 21.5     | 398                    | 6,500                       | 30.9                  | 277                                 | 84.4  | 44%                               | -30%                             | -79%   |
| US06        | 5,500   | 15.1     | 566                    | 6,500                       | 21.5                  | 399                                 | n/a   | 42%                               | -30%                             | n/a  |

\* Baseline simulation results were validated via chassis dynamometer testing. Simulation results are shown to provide a comparable basis of comparison between the baseline configuration and REET configuration. Please refer to the final report for validation results (Bhattacharjya,S., et al. 2023).

\*\* A negative % CO<sub>2</sub> change means less emissions with respect to the baseline 2021 Ford F-150.

† Charge-sustaining operation only.

†† Takes into account a fully-phased-in (2031) fleet utility factor (FUF) 0.695 based on modeled all-electric range.

Modeling results for the LDT4 REET with a series-parallel architecture during charge sustaining operation showed CO<sub>2</sub> emissions reductions of approximately 45% on the city cycle and 21% on the highway cycle relative to a 2021 Ford F-150 equipped with a 3.5L turbocharged GDI engine. Modeling results for a P2-P4 REET showed CO<sub>2</sub> emissions reductions of approximately 42% on the city cycle and 15% on the highway cycle. Both REET architectures reduced CO<sub>2</sub> emissions by 30% or greater during the high speed, aggressive driving represented by the US06 cycle. When accounting for all-electric driving using the fully-phased-in MY 2031 fleet utility factor (see Section III.C.8.i of the preamble) over combined urban and highway operation, modeling results showed the potential for both REET architectures to reduce CO<sub>2</sub> emissions by approximately 80%. When taking into account the fleet utility factor, CO<sub>2</sub> emissions for the series-parallel REET were approximately 13% lower than that of the P2-P4 REET.

Simulated performance at ETW and during towing at GCWR (approximately 19,500 pounds) are summarized in Table 3-33 and Table 3-34. Modeling of the SAE J2807 towing criteria, which includes towing at GCWR up the Davis Dam grade, indicates that both LDT4 REET versions would complete all of the SAE J2807 tests at approximately 19,500 pounds GCWR provided that the engine is on and under either blended or charge sustaining operation.

**Table 3-33: LDT4 REET 0-60 mph acceleration performance at ETW compared to 2021 Ford F150.**

| Drive cycle                   | F150  | LDT4 REET Series-Parallel | LDT4 REET P2-P4 |
|-------------------------------|-------|---------------------------|-----------------|
| ETW [lbs.]                    | 5,500 | 6,500                     | 6,500           |
| 0-60 mph Charge Sustain [sec] | 5.3   | 4.7                       | 6.7             |
| 0-60 mph All-Electric [sec]   | -     | 5.3                       | 6.7             |
| 0 – 60 mph Blended [sec]      | -     | 4.4                       | 6.7             |
| Top Speed [mph]               | 105   | 100                       | 100             |

**Table 3-34: SAE J2807 modeling results for LDT4 REET at GCWR.**

| Performance Attribute                  | Performance Metric @ GCWR | Minimum J2807 Requirement | LDT4 REET Series-Parallel Vehicle: 6592 lbs. Trailer: 13,000 lbs. Total: 19,592 lbs. |                   | LDT4 REET P2-P4 DHE Engine Vehicle: 6476 lbs. Trailer: 13,000 lbs. Total: 19,476 lbs. |                   |
|--|---------------------------|---------------------------|--|-------------------|---|-------------------|
|  |                           |                           | Blended  | Charge Sustaining | Blended   | Charge Sustaining |
| Level Road Acceleration                | 0 – 60 mph Time (Secs.)   | 30                        | 14.0   | 16.5              | 20.9  | 21.1              |
| Level Road Acceleration                | 0 – 30 mph Time (Secs.)   | 12                        | 5.2  | 5.2               | 5.0   | 5.0               |
| Level Road Acceleration                | 40 – 60 mph Time (Secs.)  | 18                        | 6.4  | 9.1               | 12.6  | 12.6              |
| Launch on Grade                        | 12% Grade, Fwd.           | -                         | Pass   | Pass              | Pass  | Pass              |
| Highway Gradeability (Davis Dam grade) | Speed on grade (mph)*     | 40                        | Pass   | Pass              | Pass  | Pass              |

\* This study adopted highway gradeability requirements exceeding those of the J2807 minimum requirements. Thus, achieving a "pass" rating for highway gradeability indicates maintaining a minimum speed of 45 mph in sections with a 45-mph speed limit and 55 mph in sections with speed limits of 55 mph or 65 mph sections for the Davis Dam grade route.

The results demonstrate that significant CO<sub>2</sub> reductions are possible for vehicles with very high tow capability using REET powertrain architectures. Within this study, the series-parallel architecture had lower CO<sub>2</sub> and improved performance characteristics when compared to the P2/P4 architecture, with modeled GHG compliance of approximately 73 g/mi CO<sub>2</sub> for a LDT4 pickup with towing capability competitive within its weight class. Series-parallel PHEV configurations from this study were thus used to inform component costs and emissions in OMEGA and were scaled for high tow capacity vehicles from the LDT3 through MDPV vehicle categories.

### **3.5.3.1.2 MDV Range-extended Electric Truck REET**

The following targeted design criteria for the MDV REET simulation were established:

- Battery sizing sufficient for a 75-mile UDDS all-electric range consistent with California ACT NZEV PHEV definition (State of California, Air Resources Board 2021)
- 0-60 mph at ETW (6,500 pounds) equivalent to baseline 2021 RAM 2500<sup>36</sup>
- 0-60 mph acceleration during towing at approximately 29,500 pounds GCWR of less than 30 seconds as per SAE J2807, 4.3.1; and SAE J1491, 4.3.2 and 4.3.3.
- 0-30 mph acceleration during towing at approximately 29,500 pounds GCWR of less than 12 seconds as per SAE J2807, 4.3.1; and SAE J1491, 4.3.2 and 4.3.3.
- 40-60 mph acceleration during towing at approximately 29,500 pounds GCWR of less than 18 seconds as per SAE J2807, 4.3.1; and SAE J1491, 4.3.2 and 4.3.3.
- Launch on 12% grade at 29,500 pounds GCWR as per SAE J2807, 4.3.4.
- Highway gradeability (commonly referred to as the Davis Dam Grade) during towing at approximately 29,500 pounds GCWR that maintained a minimum speed of 45 mph in sections with a 45-mph speed limit and 55 mph in sections with speed limits of 55 mph or 65 mph sections as per SAE J2807, 4.3.5.

Only the P2-P4 architecture was considered for MDV application. The other architectures, namely P0, P1, P2, and power-split were ruled out due to sizing constraints and power/torque limitations. The series-parallel architectures (with the exception of power-split) could potentially be used for MDV applications but would require significantly upsized traction motors and generator. At very high loads, e.g., during towing acceleration, the series mode energy conversion would also be less efficient than a conventional vehicle with a high efficiency gearbox, or the P2-P4 architecture considered selected within the study. Simulations were conducted with both gasoline and diesel dedicated hybrid engines. The gasoline version was

---

<sup>36</sup> Note that the 2021 RAM 2500 baseline vehicle had an ALVW of 9,000 pounds. The MDV REET configurations both had ALVW of 9,500 pounds.

modeled using a dedicated-hybrid 6.0L Miller cycle engine with 300 kW rated power. The diesel version was modeled using a 4.0L dedicated hybrid engine with 284 kW rated power.

For a summary of the hybrid drive-system and battery specifications, please refer to Table 3-35 and Table 3-36. For more details regarding the drive systems and the dedicated hybrid engines, please refer to the final report. (Bhattacharjya,S., et al. 2023). The electric machines used in both system configurations were internal-permanent-magnet synchronous machines using SiC inverters. Summaries of CO<sub>2</sub> emissions and fuel economy (FE) simulation results over the UDDS, HWFET, combined cycle results, and US06 are in Table 3-37 and Table 3-38.

**Table 3-35: Hybrid drive system specifications used for MDV REET simulations.**

| Electric Motors   | Max. Power (kW) | Max. Torque (N-m) | Max. Speed (rpm) | Base Speed (rpm) | Gear Ratio*, †, |
|---|-----------------|-------------------|------------------|------------------|-----------------|
| P2  | 150             | 1036              | 6,000            | 1,500            | 3.73:1          |
| Front E-axle / P4   | 195             | 405               | 18,000           | 4,200            | 17:1            |
| *P2 gear ratio is for the final drive. Note that the P2 also incorporates an 8-speed automatic transmission prior to the final drive. |                 |                   |                  |                  |                 |
| †P4 and series parallel use a single final-drive gear ratio.  |                 |                   |                  |                  |                 |

**Table 3-36: Battery specifications used for MDV REET simulations.**

| Parameter                | P2-P4 Gasoline and Diesel versions |
|--------------------------|------------------------------------|
| Cells in Series          | 82                                 |
| Cells in Parallel        | 4                                  |
| Cell Capacity [Ah]       | 40                                 |
| Cell Nominal Voltage [V] | 3.7                                |
| Pack Capacity [Ah]       | 160                                |
| Pack Nominal Voltage [V] | 303.4                              |
| Pack Energy [kWh]        | 48.5                               |
| Pack Weight [kg]         | 265.3                              |
| Max. SOC [%]             | 90                                 |
| Min. SOC [%]             | 15                                 |
| Useable Energy [kWh]     | 36.37                              |

**Table 3-37: Modeled Fuel Economy and CO<sub>2</sub> emissions comparison between the MDV P2-P4 REET with a gasoline DHE and a 2021 RAM 2500 Diesel.**

| Drive Cycle | 2021 RAM 2500 (baseline) Simulation Results |          |                        | Class 2b P2-P4 w/Gasoline DHE Results |          |                        |   | % Change from Baseline* |                     |                                       |
|-------------|---|----------|------------------------|---------------------------------------|----------|------------------------|---|-------------------------|---------------------|---------------------------------------|
|             | ALVW [pounds]                               | FE [mpg] | CO <sub>2</sub> [g/mi] | ALVW [pounds]                         | FE [mpg] | CO <sub>2</sub> [g/mi] | EPA Compliance†<br>CO <sub>2</sub> [g/mi] | FE [%]                  | CO <sub>2</sub> [%] | EPA Compliance<br>CO <sub>2</sub> [%] |
| UDDS        | 9,000                                       | 17.5     | 581                    | 9,500                                 | 25.6     | 334                    | n/a                                       | 46%                     | -42%                | n/a                                   |
| HWFET       | 9,000                                       | 25.9     | 393                    | 9,500                                 | 23.7     | 361                    | n/a                                       | -8.6%                   | -8.1%               | n/a                                   |
| Combined    | 9,000                                       | 21.3     | 478                    | 9,500                                 | 24.7     | 346                    | 107                                       | 16%                     | -28%                | -78%                                  |
| US06        | 9,000                                       | 16.7     | 609                    | 9,500                                 | 17.8     | 480                    | n/a                                       | 7%                      | -21%                | n/a                                   |

\* Baseline simulation results were validated via chassis dynamometer testing. Simulation results are shown to provide a comparable basis of comparison between the baseline configuration and REET configuration. Please refer to the final report for validation results (Bhattacharjya,S., et al. 2023).

\*\* A negative % CO<sub>2</sub> change means less emissions with respect to the baseline 2021 RAM 2500.

† Charge-sustaining operation only.

†† Takes into account a fully-phased-in (2031) fleet utility factor (FUF) 0.691 based on modeled all-electric range.

**Table 3-38: Modeled Fuel Economy and CO<sub>2</sub> emissions comparison between the MDV P2-P4 REET with a diesel DHE and a 2021 RAM 2500 Diesel.**

| Drive Cycle | 2021 RAM 2500 (baseline) Simulation Results |          |                        | Class 2b P2-P4 w/Diesel DHE Results |          |                        |   | % Change from Baseline* |                     |                                       |
|-------------|---|----------|------------------------|-------------------------------------|----------|------------------------|---|-------------------------|---------------------|---------------------------------------|
|             | ALVW [pounds]                               | FE [mpg] | CO <sub>2</sub> [g/mi] | ALVW [pounds]                       | FE [mpg] | CO <sub>2</sub> [g/mi] | EPA Compliance†<br>CO <sub>2</sub> [g/mi] | FE [%]                  | CO <sub>2</sub> [%] | EPA Compliance<br>CO <sub>2</sub> [%] |
| UDDS        | 9,000                                       | 17.5     | 581                    | 9,500                               | 31.2     | 327                    | n/a                                       | 78%                     | -44%                | n/a                                   |
| HWFET       | 9,000                                       | 25.9     | 393                    | 9,500                               | 28.9     | 352                    | n/a                                       | 12%                     | -11%                | n/a                                   |
| Combined    | 9,000                                       | 21.3     | 478                    | 9,500                               | 30.2     | 337                    | 104                                       | 42%                     | -29%                | -78%                                  |
| US06        | 9,000                                       | 16.7     | 609                    | 9,500                               | 21.5     | 473                    | n/a                                       | 29%                     | -22%                | n/a                                   |

\* Baseline simulation results were validated via chassis dynamometer testing. Simulation results are shown to provide a comparable basis of comparison between the baseline configuration and REET configuration. Please refer to the final report for validation results (Bhattacharjya,S., et al. 2023).

\*\* A negative % CO<sub>2</sub> change means less emissions with respect to the baseline 2021 RAM 2500.

† Charge-sustaining operation only.

†† Takes into account a fully-phased-in (2031) fleet utility factor (FUF) 0.691 based on modeled all-electric range.

Both MDV REET versions offered significant potential for CO<sub>2</sub> emissions reduction relative to the baseline 2021 RAM 2500 diesel. Modeling of charge sustaining operation of the MDV REET using the gasoline dedicated hybrid engine showed CO<sub>2</sub> emissions reductions of approximately 42 percent on the city cycle and 7 percent on the highway cycle. Modeling of charge sustaining operation of the MDV REET using the diesel dedicated hybrid engine showed CO<sub>2</sub> emissions reductions of approximately 43 percent on the city cycle and 10 percent on the highway cycle. Both versions reduced CO<sub>2</sub> emissions by approximately 20 percent during charge sustaining operation and aggressive driving represented by the US06 cycle. When accounting for all-electric driving using the fully-phased-in MY 2031 fleet utility factor (see Section III.C.8.i of the preamble) over combined urban and highway operation, modeling results showed the potential for REET with either version of dedicated hybrid engine to reduce CO<sub>2</sub> emissions by approximately 78%.

Simulated performance at ALVW and during towing at GCWR (approximately 29,500 pounds) are summarized in Table 3-39 and Table 3-40. During modeling of SAE J2807 towing conditions, which include towing at GCWR on the Davis Dam grade, results indicate that both MDV REET versions would successfully complete all the J2807 tests at approximately 29,500

pounds GCWR provided the engine is on and under either blended or charge sustaining operation.

**Table 3-39: Modeled 0-60 mph performance results at ALVW for the 2021 RAM 2500 and both Class 2b P2-P4 REET configurations.**

| Drive cycle                      | RAM 2500 Diesel (baseline) | Class 2b REET w/gasoline DHE | Class 2b REET w/diesel DHE |
|----------------------------------|----------------------------|------------------------------|----------------------------|
| ALVW (pounds)                    | 9,000                      | 9,500                        | 9,500                      |
| 0-60 mph Charge Sustaining [sec] | 8*                         | 7.3                          | 7.4                        |
| 0-60 mph All-Electric [sec]      | -                          | 7.2                          | 7.2                        |
| 0-60 mph Blended [sec]           | -                          | 7.3                          | 7.3                        |
| Top Speed [mph]                  | 120*                       | 100                          | 100                        |

\* Simulation results

**Table 3-40: SAE J2807 modeling results for MDV REET.**

| Performance Attribute             | Performance Metric       | J2807 Requirement | Gasoline DHE Engine Vehicle: 9,169 pounds<br>Trailer: 19,980 pounds<br>Total: 29,149 pounds |                   | Diesel DHE Engine Vehicle: 9096 pounds<br>Trailer: 19,980 pounds<br>Total: 29,076 pounds |                   |
|-----------------------------------|--------------------------|-------------------|---|-------------------|--|-------------------|
|                                   |                          |                   | Blended   | Charge Sustaining | Blended  | Charge Sustaining |
| Level Road Acceleration           | 0 – 60 mph Time (Secs.)  | 30                | 22.3  | 22.3              | 22.1   | 22.1              |
| Level Road Acceleration           | 0 – 30 mph Time (Secs.)  | 12                | 5.5   | 5.5               | 5.5  | 5.5               |
| Level Road Acceleration           | 40 – 60 mph Time (Secs.) | 18                | 13  | 13                | 12.2   | 12.3              |
| Launch on Grade                   | 12% Grade                | Yes               | Pass  | Pass              | Pass   | Pass              |
| Highway Gradeability* (Davis Dam) | Maintain 55 mph          | Min. 40 mph       | Pass  | Pass              | Pass   | Pass              |

\* This study used a more stringent criteria of maintaining 55 mph over Davis Dam instead of the SAE J2807 minimum of 40 mph.

The modeling results demonstrate that significant CO<sub>2</sub> reductions are possible for MDV with very high tow capability using REET powertrain architectures. The REET modeled with the gasoline dedicated hybrid engine obtained CO<sub>2</sub> emissions during charge sustaining operation that were within approximately 1.5 to 2.7 percent of that with the diesel dedicated hybrid engine. When accounting for the fleet utility factor, the modeled GHG compliance of the REET with the gasoline dedicated hybrid engine was approximately 107 g/mi and thus comparable to the version with the diesel dedicated hybrid engine. This was due to the higher carbon content of diesel fuel relative to gasoline and the ability of the gasoline dedicated hybrid engine to approach diesel efficiency over the drive cycles when used as part of an electric hybrid drive system. Due to the comparable CO<sub>2</sub> emissions between the diesel and gasoline versions and the lower cost of the gasoline dedicated hybrid engine and its associated exhaust emissions control system compared to the diesel, the gasoline dedicated hybrid engine version was used for informing component costs and emissions in OMEGA and was scaled to represent high tow capacity PHEV MDVs.



### **3.5.4 Other Vehicle Technologies**

Depending on vehicle design, other vehicle technologies such as transmissions, non-hybrid stop-start, electrified power steering, accessories, secondary axle disconnect, low drag brakes, and air conditioning may have been used in the creation of ALPHA outputs for the Response Surface Equations (RSE's) used by OMEGA and described in chapter 2.4.10 of this RIA. These other technologies were first discussed in the previous version of ALPHA used for the *2017 Final Determination* (U.S. EPA 2017) and the modeling has not changed.

### **3.6 Vehicle Air Conditioning System Related Provisions**

EPA has included air conditioning (A/C) system credits in its light-duty GHG program since the initial program adopted in the 2010 rule. Although the use of A/C credits has been voluntary, EPA in past rules has adjusted the level of the CO<sub>2</sub> standards downward, making them more stringent, to reflect the availability of the credits. Manufacturers opting not to use the A/C credits meet the standards through additional CO<sub>2</sub> reductions. EPA is revising the A/C credits program for light-duty vehicles in two ways. First, for A/C system efficiency credits, as proposed, EPA is limiting the eligibility for voluntary credits for tailpipe CO<sub>2</sub> emissions control to ICE vehicles starting in MY 2027 (i.e., BEVs would not earn A/C efficiency credits). Second, for A/C refrigerant leakage control, EPA is phasing down the credit from MYs 2027-2030 and retaining a small credit for MYs 2031 and later. EPA is retaining the refrigerant-related provisions applicable to MDV standards.

#### **3.6.1 A/C Leakage Credit**

The level to which each technology can reduce leakage can be estimated using the September 2023 version of SAE J2727. While this standard was developed for leakage of HFC-134a refrigerant, it is also applicable to the alternative refrigerant HFO-1234yf, and may be applicable to other low-GWP refrigerants as well. To convert J2727 chart emission (leak) rates from HFC-134a to HFO-1234yf leakage rates, the result is multiplied by 1.03. This conversion factor for HFO-1234yf is derived by multiplying the ratio of the molecular weights of the two refrigerants (114 kg/kmol for HFO-1234yf and 102 kg/kmol for HFC-134a) by the inverse ratio of the dynamic viscosities of the two refrigerants ( $11.1 \times 10^{-6}$  Pa·s for HFC-134a and  $12.0 \times 10^{-6}$  Pa·s for HFO-1234yf).

The J2727 standard was developed by SAE and the cooperative industry and government IMAC (Improved Mobile Air Conditioning) program using industry experience, laboratory testing of components and systems, and field data to establish a method for calculating leakage. With refrigerant leakage rates as low as 10 g/yr, it would be exceedingly difficult to measure such low levels in a test chamber (or shed). Since the J2727 method has been correlated to “mini-shed,” or SAE J2763, results (where A/C components are tested for leakage in a small chamber, simulating real-world driving cycles), the EPA considers this method to be an appropriate surrogate for vehicle testing of leakage. (SAE J2727 2023). It is also referenced by the California

Air Resources Board in their Environmental Performance Label regulation and the State of Minnesota in their GHG reporting regulation.<sup>37,38</sup>

### **3.6.2 How Will Leakage Credits Be Calculated?**

For model years 2027 through 2030, the A/C credit available to manufacturers will be calculated based on how much a particular vehicle's annual leakage value is reduced compared to an average MY 2008 vintage vehicle with baseline levels of A/C leakage technology and will be calculated using a method drawn directly from the September 2023 version of SAE J2727 (SAE J2727 2023) approach. By scoring the minimum leakage rate possible on the J2727 components enumerated in the rule (expressed as a measure of annual leakage), a manufacturer can generate the maximum A/C credit (on a gram per mile basis). To avoid backsliding on leakage rates when using low-GWP refrigerants, where manufacturers could choose less costly sealing technologies and/or materials, EPA is finalizing the proposed disincentive credit for "high leak" on alternative refrigerant systems. The maximum value for this high leak disincentive credit (or HiLeakDisincentive) is 1.8 g/mile for cars and 2.1 g/mile for trucks, with lower amounts possible for leakage rates between the minimum leakage score (MinScore) and the average impact (AvgImpact). The terms used for calculating the A/C Leakage Credit as well as the HiLeakDisincentive are discussed later in this section.

The A/C credit available to manufacturers will be calculated based on the reduction to a vehicle's yearly leakage rate, using the following equation for a baseline refrigerant which has a GWP of 150 for MY 2031 and later, or the HFC-134a refrigerant in the previous MY2017-2025 rule and earlier:

#### **Equation 3-7: Credit Equation for a Baseline Refrigerant**

$$\text{A/C Leakage Credit} = (\text{MaxCredit}) * [ 1 - (\$86.166-12 \text{ Score} / \text{AvgImpact}^{39}) * (\text{GWPrefrigerant} / 1430)]$$

and the following equation for low-GWP, alternative refrigerants:

#### **Equation 3-8: Credit Equation for Alternative Refrigerants**

$$\text{A/C Leakage Credit} = (\text{MaxCredit}) * [ 1 - (\$86.166-12 \text{ Score} / \text{AvgImpact}^{39}) * (\text{GWPrefrigerant} / 1430)] - \text{HiLeakDisincentive}$$

where the HiLeakDisincentive is determined in accordance with one of the following three conditions, depending on the refrigerant capacity (RefrigCapacity), or charge level, of the A/C system:

For A/C systems with a refrigerant capacity  $\leq 733\text{g}$ :

$$\text{HileakDis} = 0.0, \text{ if Score} \leq 11.0 \text{ g/yr}$$

---

<sup>37</sup> State of California, Manufacturers Advisory Correspondence MAC #2009-01, "Implementation of the New Environmental Performance Label," This document is available in Docket EPA-HQ-OAR-2009-0175.

<sup>38</sup> State of Minnesota, "Reporting Leakage Rates of HFC-134a from Mobile Air Conditioners," This document is available in Docket EPA-HQ-OAR-2009-0472-0178.

<sup>39</sup> Section 86.166-12 sets out the individual component leakage values based on the SAE value

$$\begin{aligned} \text{HileakDis} &= \text{Max HiLeakDisincentive} * [( \text{Score} - 11 ) / 3.3] , \text{ if } 11.0 < \text{Score} \leq 14.3, \\ \text{HileakDis} &= \text{Max HiLeakDisincentive}, \text{ if } \text{Score} > 14.3 \end{aligned}$$

For A/C systems with a refrigerant capacity > 733g:

$$\begin{aligned} \text{HileakDis} &= 0.0, \text{ if } \text{Score} \leq \text{RefrigCapacity} * 0.015 \\ \text{HileakDis} &= \text{Max HiLeakDisincentive} * (\text{Score} - (\text{RefrigCapacity} * 0.015) / 3.3), \text{ if } \text{RefrigCapacity} * 0.015 \\ &< \text{Score} \leq \text{RefrigCapacity} * 0.015 + 3.3 \end{aligned}$$

$$\text{HileakDis} = \text{Max HiLeakDisincentive}, \text{ if } \text{Score} > \text{RefrigCapacity} * 0.015 + 3.3$$

For MY 2026 and later, Equation 3-9 is used to calculate A/C leakage credits of an alternative refrigerant with GWP (GWPrefrigerant) at or below 150. The MaxCredit for MY 2031 and later in Equation 3-9 is 1.6 g/mile cars and 2.0 g/mile trucks shown in Table 3-41.

### Equation 3-9: Leakage Credit Equation for an Alternative Refrigerant

$$\text{A/C Leakage Credit} = (\text{MaxCredit}^{40}) * (1 - \text{GWPrefrigerant} / 150) - \text{HileakDis}$$

There are four significant terms to the credit equation. Each is briefly summarized below and is then explained more thoroughly in the following sections. Please note that the values of any of these terms change depending on whether a 150-GWP refrigerant or an alternative refrigerant is used. The values are shown in Table 3-42, and are documented in the following sections.

- “MaxCredit” is a term for the maximum amount of credit entered into the equation before constraints are applied to terms. The maximum credits that could be generated by a manufacturer is limited by the choice of refrigerant and by assumptions regarding maximum achievable leakage reductions.
- “Score” is the leakage score (LeakScore) of the A/C system as measured and calculated according to the 40 CFR 86.166-12 calculation in units of g/year, where the minimum score which is deemed feasible is fixed.
- “AvgImpact” is a term which represents the annual average impact of A/C leakage.
- “MinScore” is the lowest leak score that EPA projects is possible, when starting from a baseline, or AvgImpact, system. The MinScore represents a 50% reduction in leakage from the baseline levels based on the feasibility analysis detailed below.
- “GWPrefrigerant” is the global warming potential for direct radiative forcing of the refrigerant as defined by EPA (or IPCC). The GWP values of a legally usable refrigerant by the AIM act must be less than 150.
- “HiLeakDisincentive” is a “HiLeakDis” term for the disincentive credit deducted for low-GWP alternative refrigerant systems which have a leakage rate greater than the

---

<sup>40</sup> A/C MaxCredits of model year 2026 and later in Equation 3-9 are shown in Table 3-41.

minimum leakage score of 11.0 g/year for cars and trucks. The maximum Disincentive (Max HiLeakDisincentive) is 1.8 g/mile for cars and 2.1 g/mile for trucks.

- Detailed descriptions of Max Credit Term, § 86.166-12 implementing the J2727 Score Term, AvgImpact Term, and GWPRRefrigerant Term are presented in MY2017-2025 final rulemaking. (U.S. EPA 2012).

**Table 3-41: A/C maximum leakage credits (MaxCredit) available to manufacturers, final program (CO<sub>2</sub> g/mile).**

| MY             | Car  | Truck |
|----------------|------|-------|
| 2026           | 13.8 | 17.2  |
| 2027           | 11.0 | 13.8  |
| 2028           | 8.3  | 10.3  |
| 2029           | 5.5  | 6.9   |
| 2030           | 2.8  | 3.4   |
| 2031           | 1.6  | 2.0   |
| 2032 and later | 1.6  | 2.0   |

**Table 3-42: A/C Component Credits /w SAE J2727-2023 default parameter settings.**

|  | Baseline Refrigerant (GWP = 150) |        | Lowest-GWP Refrigerant (GWP=1) |        |
|--|----------------------------------|--------|--------------------------------|--------|
|  | Cars                             | Trucks | Cars                           | Trucks |
| MaxCredit equation input (grams/mile CO <sub>2</sub> EQ)         | 12.6                             | 15.6   | 13.8                           | 17.2   |
| A/C credit maximum (grams/mile CO <sub>2</sub> EQ) <sup>41</sup> | 11.9                             | 14.8   | 13.8                           | 17.2   |
| §86.166-12 MinScore (grams HFC/year) <sup>42</sup>               | 8.3                              | 10.4   | 8.3                            | 10.4   |
| Avg Impact (grams HFC/year)                                      | 16.6                             | 20.7   | 16.6                           | 20.7   |

A small A/C leakage credit for MY 2031 and later is described in detail below. The standard default parameter settings in the “Examples & Instructions” worksheet of the September 2023 version of SAE J2727 standard were used to calculate the “§86.166-12 Score” for the lowest-GWP HFO-1234yf alternative refrigerant. The 10.4 g/year of the “§86.166-12” Score was calculated using the “HFO-1234yf Belt Driven Compressor” worksheet in the September 2023 version of SAE J2727.

As shown in Table 3-42, 14.8 g/mile of trucks A/C credit maximum for the 150-GWP baseline refrigerant are calculated by plugging 15.6 g/mile MaxCredit, the calculated 10.4 g/year “§86.166-12” Scores, 20.7 g/year AvgImpact, and 150 GWPRRefrigerant values into Equation 3-7. The 11.9 g/mile cars A/C credit maximum are multiplied the 14.8 g/mile trucks A/C credit maximum by the cars/trucks AvgImpact ratios.

<sup>41</sup> With a hermetically-sealed electric compressor, value increases to 12.4 and 15.4 for cars and trucks, respectively.

<sup>42</sup> With a hermetically-sealed electric compressor, threshold value decreases to 2.4 and 3.1 for cars and trucks, respectively.

The “HiLeakDisincentive” values by the 10.4 g/year “§86.166-12” Scores become zero since the calculated “§86.166-12” Scores are less than 11 g/year of the “HiLeakDisincentive” threshold values.

The 17.2 g/mile MaxCredit, the calculated 10.4 g/year “§86.166-12” Scores, 20.7 g/year AvgImpact, and 1 GWPrefrigerant values were plugged into Equation 3-8 for calculating the trucks A/C credit maximum of the lowest-GWP HFO-1234yf refrigerant. 17.2 g/mile trucks A/C credit maximum of a lowest-GWP HFO-1234yf alternative refrigerant are calculated using either a belt-driven or an electric compressor since the “1/1430” term values are so small.

A/C leakage credit incentives of the baseline 150-GWP refrigerant are reset to the “0” since the GWP values less than 150 are required by the AIM Act. As shown in Table 3-43, 2.4 g/mile truck leakage credits of the lowest-GWP HFO-1234yf refrigerant are the trucks A/C credit maximum relative differences between 17.2 g/mile of the lowest-GWP HFO-1234yf refrigerant and 14.8 g/mile of the baseline 150-GWP refrigerant. The 1.9 g/mile cars leakage credits of the lowest-GWP HFO-1234yf refrigerant are multiplied the 2.4 g/mile trucks leakage credits by the “16.6/20.7” cars/trucks AvgImpact ratios. The A/C component credit calculation details, SAE J2727 standard default parameter settings, the “HFO-1234yf Belt Driven Compressor”, and the “HFO-1234yf Electric Compressor” worksheet screenshots are presented (SAE J2727 Worksheet Screenshots 2023).

Similarly, 1.4 g/year cars and 1.8 g/year trucks leakage credits for the lowest-GWP HFO-1234yf refrigerant electric compressor are calculated using the “R-1234yf Electric Compressor” worksheet in the September 2023 version of SAE J2727 standard.

About 1.4 g/mile cars and 1.8 g/mile trucks leakage credits of the lowest-GWP HFO-1234yf refrigerant are calculated by simply scaling 13.8 g/mile cars and 17.2 g/mile trucks leakage credits multiplied by the “150/1430” GWP ratios since the GWP values of the baseline refrigerant were decreased from 1430 to 150.

**Table 3-43: A/C Leakage Credits (MaxCredit) of the lowest-GWP refrigerant.**

|                                       | Baseline Refrigerant (GWP = 150), Highest GWP limit |        | Lowest-GWP Refrigerant (GWP=1) |        |
|---------------------------------------|---|--------|--------------------------------|--------|
|                                       | Cars  | Trucks | Cars                           | Trucks |
| A Simple Scaling                      | 0   | 0      | 1.4                            | 1.8    |
| SAE J2727 /w an electric compressor   | 0   | 0      | 1.4                            | 1.8    |
| SAE J2727 /w a belt-driven compressor | 0   | 0      | 1.9                            | 2.4    |
| Averaged A/C Leakage Credits          | 0   | 0      | 1.6                            | 2.0    |

The 1.6 g/mile cars and 2.0 g/mile trucks leakage credits are also calculated by averaging the lowest-GWP HFO-1234yf refrigerant A/C leakage credit values in the simple scaling, the electric-compressor, and the belt-driven compressor cells in Table 3-43. Hermetically-sealed electric compressors (Denso 2022) are widely used in the vehicle A/C systems of electrified vehicles like various HEVs, PHEVs, and BEVs.

The HFC-152a refrigerant is the only currently available alternative refrigerant with 124-GWP values, closer to the maximum lawful GWP limit of 150. But the flammable HFC-152a refrigerant requires about 12 pounds of additional system components (chiller, pump, reservoir, and plumbing for secondary loop), a new challenging packaging design, and engineering cost. As

of MY2023, the lowest-GWP HFO-1234yf refrigerant already used in 97 percent of light-duty vehicles (U.S. EPA 2023) is likely prevalent even without extra leakage credit incentives.

Therefore, 1.6 g/mile cars and 2.0 g/mile trucks leakage credits are appropriate since about 149 GWP value differences are insignificant compared to 1429 GWP differences by the HFC-134a refrigerant, and the MaxCredit values of the baseline 150-GWP refrigerant are likely increased above 15.6 g/mile, which were used for the HFC-134a refrigerant in the previous MY2012-2016 and MY2017-2025 rules.

### **3.7 Fuel Economy Test Procedure Adjustments for Tier 3 Test Fuel**

In order to respond to the need for test procedure adjustments due to the change to Tier 3 certification test fuel, EPA conducted a test program at EPA's National Vehicle and Fuel Emissions Laboratory to quantify the differences in GHG emissions and fuel economy between Tier 2 and Tier 3 certification test fuels. The peer-reviewed Technical Report titled "Tier 3 Certification Fuel Impacts Program" (U.S. EPA 2018) contains the details of the study design, how we conducted the testing, and our analysis of the results, and is available in the docket for this rule.

This section will first summarize the study design and data analysis, then the determination of the adjusted R-factor and revised fuel economy equation.

#### **3.7.1 Summary of EPA Test Program and Results**

EPA designed the study to test vehicles that incorporated a variety of advanced powertrain technologies that already have a significant and increasing presence in the market today and are expected to be among the primary technologies applied by manufacturers to meet future GHG and fuel economy standards. Our selection of vehicles for the test program was designed to address the narrow purpose of this rule: quantifying appropriate CO<sub>2</sub> and CAFE adjustments that on average would prevent the change in the stringency of those standards that would otherwise occur as the certification test fuel changed. We note that because it was necessary in this case for EPA to estimate test fuel effects into future years, we were not able to base our vehicle selection solely on the vehicle fleet as it currently exists. In other words, it was critical that the agency select vehicles equipped with technologies that represent how the fleet will look in the future (rather than how the fleet looks today).

To capture the emission and fuel economy effects with the technologies that are becoming widespread in the fleet, we concluded that it was important to cover a wide range of engine configurations and cylinder displacements, and related technologies. We intentionally focused on specific technologies that we expect manufacturers to widely use in future vehicles, instead of on specific vehicles, for two reasons: 1) Fuel effects on GHG emissions and fuel economy relate primarily to combustion characteristics of the engine, rather than to vehicle characteristics (e.g., mass and aerodynamics); and 2) while we are reasonably certain that the technologies we selected and tested will dominate the light-duty fleet in coming years, the distribution of specific vehicles in which they will be used over the 2025 and later time period is much more difficult to anticipate. EPA believes that the appropriateness of focusing our test vehicle selection on key engine and powertrain technologies is further reinforced by the long-standing practice by most manufacturers of using a single engine type in several different models of passenger cars, crossovers, SUVs, minivans, and/or pick-up trucks.

Table 3-45 below lists the powertrain technologies that EPA selected, after a series of technical consultation meetings with the Alliance and Global Automakers.<sup>43</sup> The selected vehicles cover 4-, 6-, and 8-cylinder engines, and a wide range of displacements per cylinder (ranging from 0.375 to 0.75 liters of displacement per cylinder). In addition, EPA's selected engines included both naturally aspirated and turbocharged engines and both direct-injection and port-injection fuel delivery systems.<sup>44</sup> Because these engine characteristics largely determine the dynamics of fuel combustion, they are closely related to emissions and efficiency when test fuel changes. We also included newer transmission technologies to reveal any potential effects beyond the engine. Several of these engine and transmission technologies are in widespread use today, and we expect the others to become more prevalent as future GHG, CAFE, and Tier 3 standards take effect.

As illustrated in the 2018 EPA Automotive Trends Report, the use of the key technologies incorporated in the EPA test program is growing in a wide range of vehicle applications across the industry, at the same time that earlier competing technologies are generally declining (U.S. EPA 2023).<sup>45</sup>

We chose eleven vehicles that incorporated one or more of these relevant technologies, including the following: gasoline direct injection (GDI) (which enables higher compression ratios for improved fuel efficiency and emissions reductions); engine turbocharging (generally in conjunction with smaller, more efficient engines, another growing approach to improved fuel efficiency and reduced emissions); naturally aspirated high compression engines (featuring a high degree of valve timing authority to allow operation as Atkinson-Cycle engines when required); cylinder deactivation technology (to allow one or more cylinders to be deactivated while the vehicle is cruising, reducing fuel consumption and emissions); and automatic transmissions with higher numbers of gears, as well as Continuously Variable Transmissions (CVTs), to allow engines to stay in the most efficient engine speed range as much as possible, improving fuel use and emissions. The test program also included a large pickup truck, a Class 2b MDV, to assess whether larger gasoline trucks with engine technology that is common today and is likely to continue into the future show similar effects to LDVs and LDTs.<sup>46</sup>

The use of these technologies has been growing, and we expect them to continue to grow. For example, between 2008 and 2018, in the new model year fleet:

Gasoline direct injection (GDI) penetration has grown from 2% to 51%.

---

<sup>43</sup> See EPA Memorandum to Docket EPA-HQ-OAR-2016-0604: "Listing of Technical Consultation Meetings between EPA Staff and Automobile Industry Technical Representatives Supporting the Vehicle Test Procedure Adjustments for Tier 3 Certification Test Fuel," NPRM. Among other topics, these meetings included detailed discussions of vehicle selection and test methodology issues for the EPA vehicle test program underway at the time.

<sup>44</sup> EPA did not include electric hybrid powertrains in the test program because the additional test variability caused by differences in battery state of charge and engine on/off operation would likely confound the small fuel effects.

<sup>45</sup> The 2018 EPA Automotive Trends Report describes in detail the most recent trends among powertrain technologies, beginning at P. 37: <https://www.epa.gov/automotive-trends/download-automotive-trends-report#Full%20Report>

<sup>46</sup> As discussed above, EPA regulates Class 2b (and Class 3) heavy-duty vehicles, which have gross vehicle weight ratings greater than 14,000 pounds, separately from light-duty vehicles, but the 2014 Tier 3 certification test fuel changes applied to testing for both of these vehicle categories.

Gasoline engine turbocharging has grown from 3% to 31%.

Cylinder deactivation has grown from 7% to 12%.

8-speed transmissions have grown from 0.2% to 19%.

Continuously Variable Transmissions (CVTs) have grown from 6% to 20%.

The vehicles we selected for the test program were production vehicles that had emission levels that were compliant or nearly compliant with the Tier 3 emission standards. All of the vehicles we tested for this program were certified by the manufacturers to operate appropriately on regular grade fuel to avoid any potential octane effects from the test fuel change (i.e., from higher-octane Tier 2 test fuel to lower-octane Tier 3 test fuel).

Some stakeholders have asked EPA to consider using the manufacturer-generated test data that they submit to the EPA vehicle certification database as an alternative data source for estimating the impact of the change in CO<sub>2</sub> and fuel economy performance due to the test fuel change, rather than the data from the separate EPA vehicle test program.<sup>47</sup> In fact, early in the development of this adjustment, EPA considered the potential value of using available manufacturer certification data for this purpose of quantifying the impact of the test fuel change. However, EPA concluded that the manufacturer certification data submitted to EPA could not be used for the purpose of the technical analysis needed for this rule. As shown in Table 3-44 below, EPA recognizes that there are many sources of vehicle test-to-test variability, and we have developed methodologies to control for these sources of variability for this test program. EPA's testing methodologies were informed by our experience with the challenges of measuring fuel effects on vehicle emission performance. EPA concluded that it is not possible to use manufacturer certification data, as submitted to EPA, to quantify the effects of the Tier 3 fuel change on CO<sub>2</sub> and fuel economy. This is why EPA instead designed a targeted, controlled test program for the particular purposes of this rule.

In performing the testing of the selected vehicles, we took additional steps beyond those specified in the existing compliance testing regulations in order to reduce test-to-test variability to very low levels. This was necessary because we were working to discern very small changes in emissions and fuel economy between tests on the two fuels, requiring lower test-to-test variability than has been historically accepted for such testing, including compliance testing.<sup>48</sup> We accomplished this goal in several ways, in general by reducing or eliminating potential sources of variability. These steps included completing testing of one vehicle on one fuel in a single work week; maintaining the same test site and vehicle driver throughout the program across all fuels and vehicles; thorough removal of the previous test fuel from the fuel system, with enough driving to allow for the engine to adapt to the new fuel properties; maintaining the same number and type of test, and the same sequence, during each day of testing; and ensuring a fully-charged battery by using a trickle-charger overnight, over weekends, and over extended

---

<sup>47</sup> See briefing document provided by the Alliance of Automobile Manufacturers for E.O. 12866 meeting May 28, 2019, EPA Docket EPA-HQ-OAR-2016-0604.

<sup>48</sup> For example, EPA historically allows up to a three percent difference in fuel economy from test to test when performing engineering evaluations. Guidance document VPCD-97-01 for testing vehicles with knock sensors highlights this existing variability allowance.



periods between tests. By taking these kinds of actions, we were able to reduce test-to-test variability significantly as compared to most routine testing on these test cycles.

Table 3-44 lists several of the key features of vehicle testing that affect the variability of test results and that we specifically incorporated into the EPA vehicle test program. As shown, these methodological features are typically not present during manufacturer certification testing (nor are necessary for the accuracy required for that purpose).

**Table 3-44: Test Variables Requiring Control for Accurate Fuel Effects Measurement.**

| Methodological Features   | EPA Test Program | Available Manufacturer Certification Data |
|---|------------------|---|
| Identical test fuels across all test vehicles   | Yes              | No  |
| Appropriate methods for measuring Tier 3 (oxygenated) test fuel properties  | Yes              | Rarely                                    |
| Multiple measurements of test fuel properties across several labs/samples   | Yes              | No  |
| Comparative testing done in same test cell (to minimize impacts from vehicle loading and coast-down simulation, etc.) | Yes              | Rarely                                    |
| Testing using same driver   | Yes              | No  |
| Testing using exact same test vehicle for all testing of a vehicle model  | Yes              | Rarely                                    |
| Careful control of vehicle preparation to reduce variability (beyond CFR requirements)                                | Yes              | No  |
| Statistical assessment of number of test replicates needed  | Yes              | No  |
| Monitoring driver performance metrics for consistency with comparative tests  | Yes              | No  |
| Highly controlled sequencing of test types (FTP, HFET, US06)  | Yes              | No  |
| Fuel sequence order switched to avoid vehicle “learning bias”   | Yes              | No  |
| Repeat of test sequences when necessary for statistical confidence  | Yes              | No  |

Table 3-45 lists the test vehicles EPA used in this test program and the key technologies they incorporated. We note that the EPA test program and the associated Technical Report only evaluated the change in carbon-balance fuel economy between the two test fuels, not changes in CAFE calculations. However, these data serve as a basis for developing the CAFE fuel economy adjustment factor described below.

**Table 3-45: Test Program Vehicles.**

| Model Year | Vehicle Make/Model            | Engine      | Technologies  |
|------------|-------------------------------|-------------|---|
| 2014       | Ram 1500                      | 3.6L V6 PFI | 8 speed automatic transmission, start-stop disabled |
| 2016       | Acura ILX                     | 2.4L I4 GDI | 8 speed DCT with a torque converter                 |
| 2013       | Nissan Altima                 | 2.5L I4 PFI | CVT   |
| 2016       | Honda Civic                   | 1.5L I4 GDI | CVT, downsized turbocharged engine                  |
| 2015       | Ford F150 Eco-Boost           | 2.7L V6 GDI | Downsized turbocharged engine, start-stop disabled  |
| 2013       | Chevrolet Malibu (“Malibu 1”) | 2.4L I4 GDI | Gasoline direct injection engine                    |
| 2016       | Chevrolet Malibu (“Malibu 2”) | 1.5L I4 GDI | Downsized turbocharged engine                       |
| 2014       | Mazda 3                       | 2.0L I4 GDI | High compression ratio engine                       |
| 2014       | Chevrolet Silverado 1500      | 4.3L V6 GDI | Cylinder deactivation                               |
| 2015       | Volvo S60 T5                  | 2.0L I4 GDI | Downsized turbocharged engine                       |
| 2016       | Chevrolet Silverado 2500      | 6.0L V8 PFI | Class 2b truck                                      |

**3.7.1.1 Discussion of Results**

The EPA test program described above generated a set of high-quality vehicle emissions data, which then also served as inputs to the carbon-balance fuel-economy equation, on each of the two fuels of interest. The associated Technical Report referenced above includes a comprehensive summary and comparison of these data. We refer stakeholders interested in a fuller presentation of the entire program to the Technical Report.

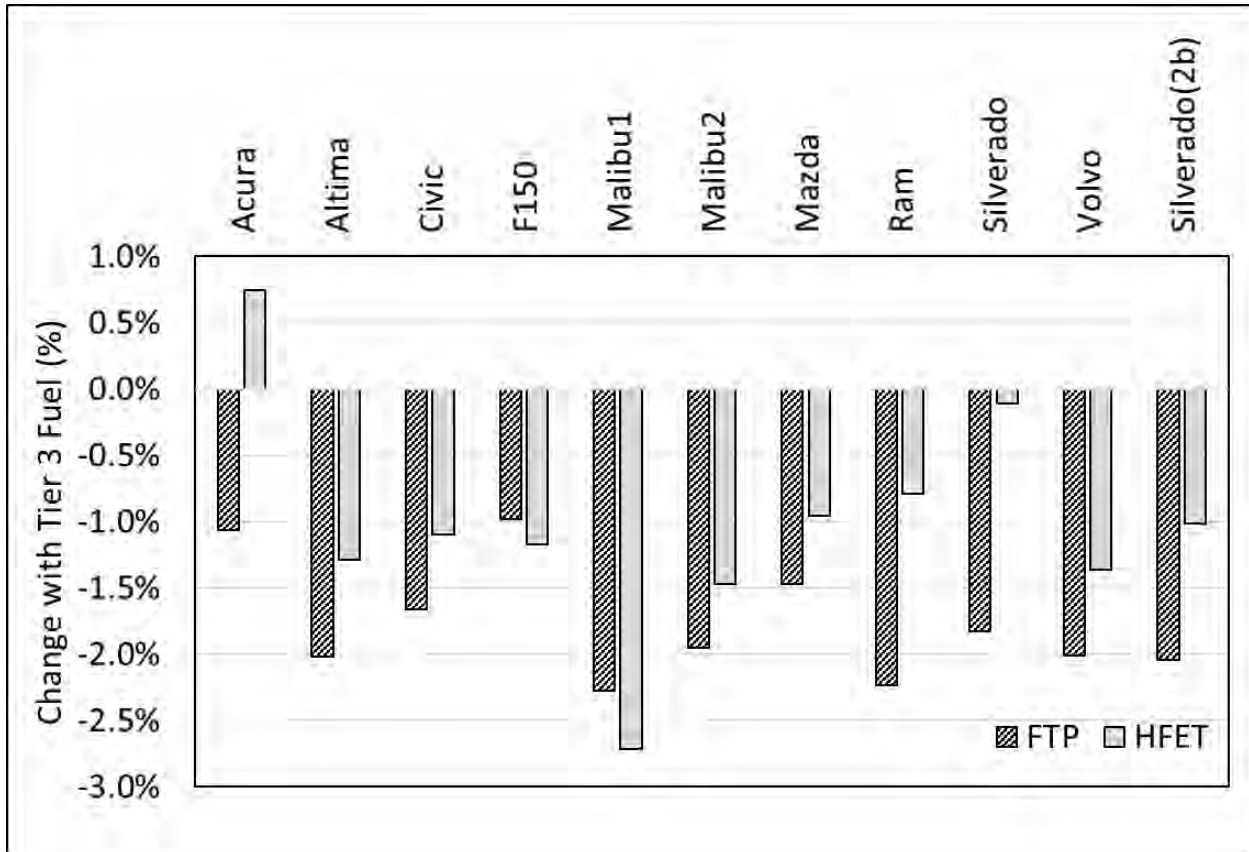
The Technical Report, as a comprehensive presentation of EPA test program and its results, is independent of this rule and will likely be valuable in other contexts. Much of the data collected in the test program and presented in the Technical Report is relevant to the development of the adjustment factors, as described below. However, the report does not present the resulting adjustment factors or the analyses leading to them.

In summary, Figure 3-75 shows the average percent change in CO<sub>2</sub> emissions by vehicle, calculated with respect to the Tier 2 fuel (or mathematically: % difference =  $(T3 - T2)/T2 \times 100$ ). The results indicate that for the Federal Test Procedure (FTP) and the Highway Fuel Economy Test (HFET) cycles, going from Tier 2 fuel to Tier 3 fuel results in a reduction in CO<sub>2</sub> per mile of 1.78 and 1.02 percent, respectively, corresponding to absolute CO<sub>2</sub> emissions decreases of 6.37 and 2.16 g/mi, respectively.<sup>49</sup> Vehicles which emitted comparatively large amounts of CO<sub>2</sub> on Tier 2 fuel generally showed larger reductions in absolute CO<sub>2</sub> emissions when moving from Tier 2 fuel to Tier 3 fuel. However, these vehicles produced similar reductions to the other vehicles in the test program when expressed as a percent reduction, indicating a consistent effect proportional to the base vehicle performance of the test vehicle. In our view, stringency under GHG and CAFE standards relates to this base performance, rather than absolute CO<sub>2</sub> emissions levels. As market representative test fuel mixes become more efficient, it becomes comparatively easier for comparatively inefficient vehicles to comply with these standards. Under this view of stringency, then, it is necessary to realign test results to maintain efficiency controls at the vehicle manufacturer level.

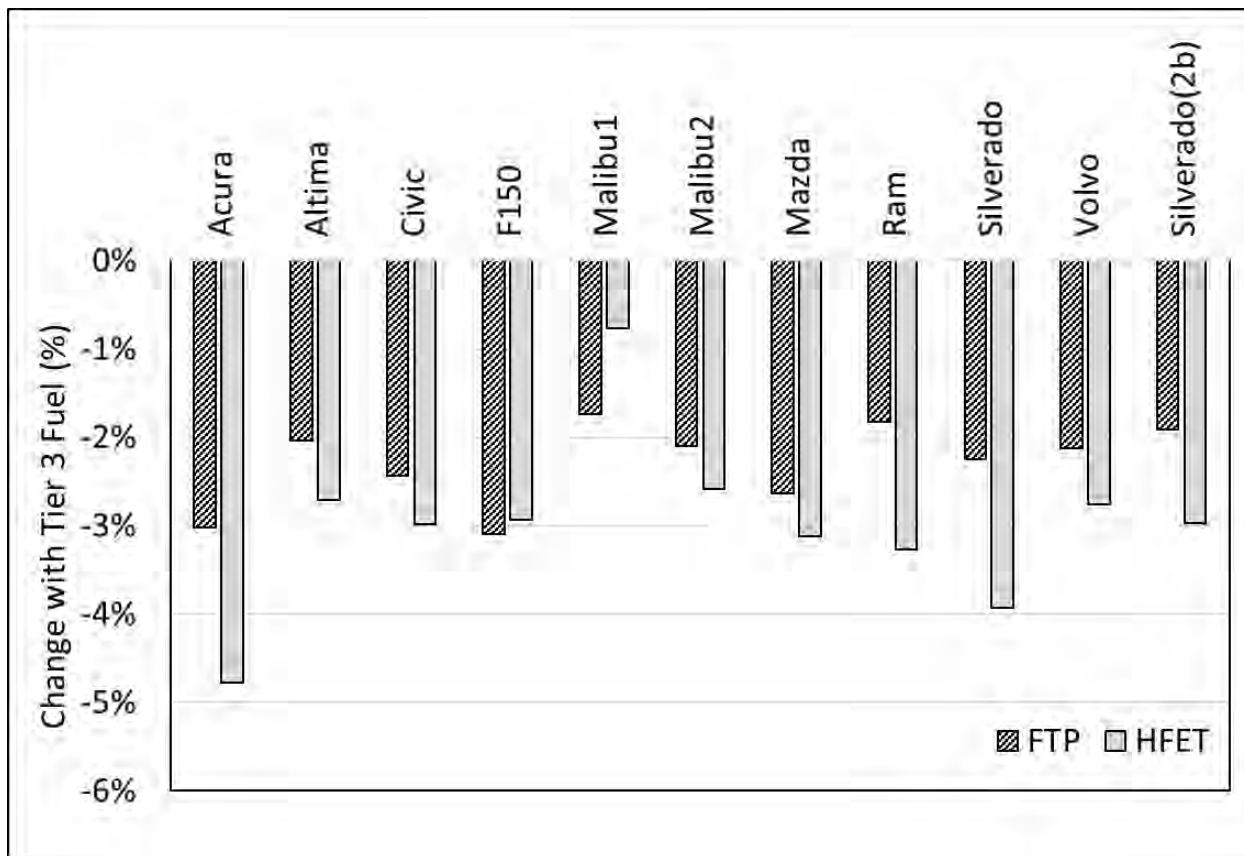
---

<sup>49</sup> The FTP and HFET are EPA’s standard dynamometer driving cycles, simulating city and highway driving, respectively.

Similarly, Figure 3-76 shows the average percent change in carbon-balance fuel economy when moving from Tier 2 to Tier 3 fuels, calculated in the same way as the CO<sub>2</sub> differences. We used the fuel-economy values on each fuel calculated from measured CO<sub>2</sub> and other carbon-containing emissions to generate the actual carbon-balance fuel economy, before the final conversion to CAFE compliance values. The results indicate that for the FTP and the HFET cycles, the average reduction in fuel economy when moving from Tier 2 fuel to Tier 3 fuel are 2.29 percent and 2.98 percent, respectively, corresponding to average reductions in fuel economy of 0.66 and 1.34 miles per gallon.



**Figure 3-75: Percent Change in CO<sub>2</sub> Emissions from Tier 2 to Tier 3 Test Fuel (%).**



**Figure 3-76: Percent Change in Carbon-Balance Fuel Economy from Tier 2 to Tier 3 Test Fuel (%).**

The Acura showed a noticeably larger fuel economy difference than other vehicles on the highway cycle (HFET). To investigate this behavior, we performed a limited number of additional tests of this vehicle on both regular grade Tier 3 fuel and premium grade (higher octane) Tier 3 fuel. The results showed an unexpected level of fuel economy sensitivity to the test fuel’s octane rating.<sup>50</sup> Although we present the results for this vehicle here and in the Technical Report, we have excluded it from the analysis we used to determine the test procedure adjustments. Because this vehicle is not labeled by the manufacturer as requiring premium fuel,

<sup>50</sup> Emission certification fuel, including Tier 2 test fuel, has historically been high-octane grade as a matter of convenience to avoid having to maintain separate octane levels of test fuels for different vehicle requirements. Later, with the implementation of electronic ignition and knock sensors in the 1990s, it became possible for the engine controls to optimize combustion for a number of factors including the fuel octane level, with varying effects on emissions and fuel economy. Thus, EPA issued guidance to manufacturers in 1997 (VPCD-97-01) clarifying that, in order to ensure representativeness of FE test results to real-world driving, any difference in emissions or FE between high octane and regular octane market fuel must be declared if it exceeds a 3% allowance for normal test-to-test variability. This requirement did not apply if the vehicle was marketed as requiring higher octane fuel. Note that under the Tier 3 program, the default test fuel is now regular octane, which obviates the situation of undeclared octane impacts between certification tests and in-use driving on market gasoline.

this behavior was unexpected on the recommended (lower octane) fuel. We thus did not want these results to inappropriately affect the adjustments to CO<sub>2</sub> and fuel economy.

### **3.7.2 Development of Adjustment Factors**

In this section, we describe how we used relevant data from the EPA test program summarized in the previous section to develop the test fuel related adjustment factors. We present below the separate analyses we conducted to determine these adjustment factors for CO<sub>2</sub> and for CAFE fuel economy.

We note that the EPA test program results described in the Technical Report and summarized above differ in perspective from our development of the adjustment factors discussed in this section. The Technical Report described the change in emissions and fuel economy with the transition from the current Tier 2 fuel to Tier 3 fuel, so those comparisons were formed as Tier 3 relative to Tier 2 fuel. In contrast, this section describes how we used the test program results to determine adjustment factors that would maintain the stringency of the existing standards when testing is performed on Tier 3 test fuel. Thus, the comparison in this section is formed as Tier 2 relative to Tier 3 fuel. Another difference is the ASTM method<sup>51</sup> used to determine the carbon mass fraction of the test fuel for calculation of fuel economy. In the Technical Report we used the average D5291 result from five laboratories, whereas here we use the D3343 method modified for ethanol as appropriate, consistent with the adjusted regulatory CAFE equation.<sup>52</sup>

Most individual vehicle and powertrain combinations will react slightly differently to a change in test fuel. As a result, an approach to test-fuel-related adjustment that attempts to recognize the unique responses of every vehicle would be very complicated and, we believe, difficult to implement in a practical manner for manufacturer testing. Therefore we derive the adjustments based on average values. Such an averaging approach is not new. Historically, when EPA has corrected new test results back to the results on a previous test fuel, EPA required that differing vehicle responses be accounted for on average. We believe this approach continues to be sufficient and appropriate for compliance with fleet-average requirements for fuel economy and CO<sub>2</sub>.

We developed the CO<sub>2</sub> and CAFE adjustment factors based on the Federal Test Procedure (FTP) and Highway Fuel Economy Test (HFET) results from the EPA test program, as described below for each of the two adjustment factors. For consistency with the historical FTP/HFET weighting of 55 percent and 45 percent, respectively, which is used in the current regulations for compliance and other testing, we believe that this same 55 percent/45 percent weighting for FTP and HFET test results is appropriate for the adjustment factors described in this action.<sup>53</sup>

#### **3.7.2.1 CO<sub>2</sub> Adjustment Factor**

We analyzed the data from the EPA test program (excluding the data from the Acura because of the octane sensitivity issue discussed above). Table 3-46 presents our calculation process. The

---

<sup>51</sup> ASTM International (previously known as American Society for Testing and Materials).

<sup>52</sup> See 40 CFR 600.113-12 as amended in this rule and memo “Distillation adjustment for ethanol blending in Tier 3 and LEV III test fuels” submitted by Aron Butler to docket EPA-HQ-OAR-2016-0604.

<sup>53</sup> The test procedure adjustments would apply to testing on all federal Tier 3 gasoline certification fuels, including premium certification fuel and LEV III fuels.

data show that the impact of the fuel change varies slightly among the vehicles, but it is consistently in the same direction and in the range of 1-2.5 percent, with a mean value of 1.66 percent.

**Table 3-46: CO<sub>2</sub>: Results of the EPA Test Program for the FTP and HFET Cycles, With Weighted Values for the Two Cycles, and Corresponding Percent Differences.**

| Vehicle   | FTP              |                  | HFET             |                  | Weighted1        |                  | Difference2 |      |      |
|---|------------------|------------------|------------------|------------------|------------------|------------------|-------------|------|------|
|   | Tier 3<br>(g/mi) | Tier 2<br>(g/mi) | Tier 3<br>(g/mi) | Tier 2<br>(g/mi) | Tier 3<br>(g/mi) | Tier 2<br>(g/mi) | (g/mi)      | %    |      |
| Altima  | 270.60           | 276.19           | 163.37           | 165.49           | 222.35           | 226.38           | 4.03        | 1.81 |      |
| Civic   | 213.37           | 216.98           | 143.16           | 144.75           | 181.77           | 184.47           | 2.70        | 1.49 |      |
| F150  | 376.87           | 380.61           | 241.92           | 244.79           | 316.14           | 319.49           | 3.35        | 1.06 |      |
| Malibu 1  | 307.37           | 314.53           | 184.01           | 189.15           | 251.86           | 258.11           | 6.25        | 2.48 |      |
| Malibu 2  | 268.64           | 274.00           | 163.58           | 166.02           | 221.36           | 225.41           | 4.05        | 1.83 |      |
| Mazda   | 238.57           | 242.12           | 160.32           | 161.87           | 203.36           | 206.01           | 2.65        | 1.30 |      |
| Ram   | 414.49           | 423.94           | 260.67           | 262.76           | 345.27           | 351.41           | 6.14        | 1.78 |      |
| Silverado   | 419.88           | 427.69           | 281.05           | 281.37           | 357.41           | 361.84           | 4.44        | 1.24 |      |
| Volvo   | 299.83           | 305.98           | 173.22           | 175.61           | 242.86           | 247.31           | 4.46        | 1.84 |      |
| Silverado (2b)  | 706.83           | 721.57           | 443.11           | 447.66           | 588.16           | 598.31           | 10.15       | 1.73 |      |
| Mean  |                  |                  |                  |                  |                  |                  |             |      | 1.66 |
| 1As 0.55FTP + 0.45HFET.<br>2As T2 - T3, and as 100(T2 - T3)/T3. |                  |                  |                  |                  |                  |                  |             |      |      |

The formula for combining and weighting CO<sub>2</sub> test results is straightforward:

$$CO_2 = 0.55 \times CO_{2city} + 0.45 \times CO_{2highway}$$

Where: CO<sub>2</sub> = weighted CO<sub>2</sub> in grams per mile

CO<sub>2city</sub> = CO<sub>2</sub> as measured on the FTP test cycle

CO<sub>2highway</sub> = CO<sub>2</sub> as measured on the HFET test cycle

Based on the results of the analysis of test data in Table 3-46, measured CO<sub>2</sub> from FTP and HFET testing on Tier 3 test fuel, weighted as discussed above (55/45 percent), is adjusted by multiplying by a factor of 1.0166 to produce the expected CO<sub>2</sub> performance had the vehicle been tested over the same test cycles while operating on Tier 2 fuel. In other words, the CO<sub>2</sub> emissions test results from a vehicle being tested for GHG compliance using Tier 3 test fuel would be multiplied by this factor to arrive at the CO<sub>2</sub> value used for compliance.<sup>54</sup> For example, the compliance CO<sub>2</sub> value would be computed as 1.0166 x (0.55 x CO<sub>2,FTP</sub> + 0.45 x CO<sub>2,HFET</sub>).

<sup>54</sup> Compliance for the LD GHG standards is based on all carbon-related exhaust emissions (CREE). The adjustment factor applies only to the CO<sub>2</sub> emission aspect of the CREE equation. For discussion of CREE impacts in the EPA test program, see memo “Carbon-related Exhaust Emissions (CREE) Measured on Current and Proposed Certification Gasolines,” submitted by Jim Warila to docket EPA-HQ-OAR-2016-0604.

### 3.7.2.2 Analysis of Fuel Economy Data and Development of Adjusted Equation

As we did with the CO<sub>2</sub> test data above, we used the EPA test program results (again, excluding the Acura) to determine an adjustment factor that would be applied to the FTP and HFET results for test vehicles operating on Tier 3 test fuel to produce CAFE fuel economy results equivalent to those from testing on Tier 2 test fuel. Tier 2 test fuel is the result of EPA's 1986 test fuel changes and the associated adjustment, designed to produce results that represent the CAFE fuel economy that would have been observed under 1975 test conditions (as required by the statutes governing the CAFE program). The CAFE fuel economy adjustment described here would align Tier 3 test fuel testing with Tier 2 test fuel results, and, by extension, with results that would have been observed using 1975 test fuel.

Note that the adjustment factor would also be used for all other test cycles required for fuel economy labeling. This current section summarizes EPA's analysis and the resulting value for the CAFE fuel economy adjustment factor. As discussed above, a vehicle's CAFE fuel economy is based primarily on the same measured CO<sub>2</sub> emissions that determine its compliance with the GHG standards. For the reasons discussed in that section, the CAFE calculation is necessarily more complex than the direct CO<sub>2</sub> emissions measurement, and adjusting the calculation carries these complexities.

To provide NHTSA with the fuel economy data it uses for CAFE compliance, EPA uses calculations that account for the difference in volumetric energy density (VED, e.g., Btu/gal) of the test fuel relative to the baseline test fuel on which NHTSA based the original CAFE standards in 1975. In the mid-1980s, when EPA last made such a test-fuel related adjustment, empirical data available to the Agency suggested that there was not a direct, 1-to-1 response of fuel economy to changes in test fuel VED. Because of this, EPA proposed and took final action to insert an additional factor, called the "R-factor," into the equation. EPA defined this R-factor, established in the regulations with a value of 0.6, as the percent change in fuel economy per percent change in test fuel VED. For example, for  $R = 0.6$ , a 10 percent decrease in test fuel VED would only produce a 6 percent decrease in fuel economy.

Table 3-47 shows this  $R=0.6$  adjusted fuel economy value alongside the carbon-balance fuel economy for both test fuels. The VED of the Tier 2 fuel was higher than the 1975 CAFE reference fuel, so the R-factor adjustment reduces the fuel economy result slightly relative to the carbon-balance value. For Tier 3 test fuel, which has lower VED, the R-factor adjustment increases the fuel economy result slightly. If the adjustment were functioning optimally (i.e., if  $R = 0.6$  were exactly the right adjustment for both fuels), we'd expect the corrected value in the  $R = 0.6$  columns in the table to be the same value for both test fuels. However, there is still a directionally consistent offset, with the Tier 3 test fuel values slightly lower than the Tier 2 values for all but one vehicle, suggesting that an R-factor of 0.6 is not optimal and should be higher for this test fleet operating on Tier 3 fuel. A higher value is also supported by analyses of other recent datasets.<sup>55</sup>

---

<sup>55</sup> Sluder, C., West, B., Butler, A., Mitcham, A. et al., "Determination of the R Factor for Fuel Economy Calculations Using Ethanol-Blended Fuels over Two Test Cycles," SAE Int. J. Fuels Lubr. 7(2):551-562, 2014.

**Table 3-47: Carbon-Balance and R-Adjusted Fuel Economy Results by Vehicle and Fuel (City/Highway-Weighted Values, mpg).**

|                | Tier 2 test fuela  |                | Tier 3 test fuelb  |                |
|----------------|--------------------|----------------|--------------------|----------------|
|                | C-balance equation | R=0.6 equation | C-balance equation | R=0.6 equation |
| Altima         | 39.40              | 39.26          | 38.51              | 39.10          |
| Civic          | 48.43              | 48.26          | 47.16              | 47.88          |
| F150           | 27.97              | 27.87          | 27.12              | 27.53          |
| Malibu 1       | 34.49              | 34.37          | 34.00              | 34.52          |
| Malibu 2       | 39.61              | 39.48          | 38.72              | 39.31          |
| Mazda          | 43.38              | 43.23          | 42.16              | 42.81          |
| Ram            | 25.42              | 25.34          | 24.83              | 25.22          |
| Silverado      | 24.66              | 24.58          | 23.96              | 24.32          |
| Volvo          | 36.08              | 35.95          | 35.24              | 35.78          |
| Silverado (2b) | 14.90              | 14.85          | 14.56              | 14.79          |

a For the Tier 2 fuel, we calculated the adjusted fuel economy using ASTM methods D3343 and D3338, and lumped THC emission term, consistent with how fuel economy is calculated and reported under the current requirements.

b For the Tier 3 fuel, we used modified methods D3343 and D3338, and separate NMOG and CH4 emission terms. The reason for the change in emission terms is explain in more detail below.

Because of the remaining offset seen above, we are adopting an updated fuel economy equation for use with Tier 3 test fuel where the R-factor is replaced by a new factor (Ra), determined empirically so as to make the fleet-average fuel economy result using Tier 3 test fuel numerically equivalent to the fleet-average result using Tier 2 test fuel and R=0.6. The goal is to have no change in stringency for compliance with fuel economy standards with the new test fuel. Note that this new factor not only updates the sensitivity of fuel economy to VED (the main purpose of the original R-factor) but also accommodates other changes to the calculation discussed in more detail below. For reference, we show the current equation for Tier 2 test fuel (which we described above) here:<sup>56</sup>

$$FE_{CAFE} = \left[ \frac{CMF_{T.fuel} \cdot SG_{T.fuel} \cdot \rho_{water}}{CMF_{exh} \cdot THC + 0.429 \cdot CO + 0.273 \cdot CO_2} \right] \cdot \left[ \frac{NHC_{B.fuel} \cdot SG_{B.fuel}}{(R \cdot NHC_{T.fuel} \cdot SG_{T.fuel}) + ((1-R) \cdot NHC_{B.fuel} \cdot SG_{B.fuel})} \right]$$

One of these changes to the equation is an update from using THC emissions in the Tier 2 carbon-balance denominator to using NMOG and CH<sub>4</sub> with Tier 3 test fuel, where NMOG is determined as specified in 40 CFR 1066.635. The inclusion of NMOG better accounts for the oxygenated emission products resulting from ethanol in the test fuel, and is consistent with the

<sup>56</sup> We present the equations below in a form that highlights the changes between the existing and proposed CAFE equations. These equations are functionally equivalent to those in the regulatory language associated with this notice (40 CFR 600.113-12), with the latter equations structured in form conventionally used for CAFE compliance purposes. This regulatory language also defines each of the terms in these CAFE equations.



use of NMOG in the Tier 3 emission standards. With the very low emission levels of Tier 3 vehicles, we expect the difference between THC and the sum of NMOG + CH<sub>4</sub> to be negligible.

$$FE_{CAFE} = \left[ \frac{CMF_{T.fuel} \cdot SG_{T.fuel} \cdot \rho_{water}}{CMF_{exh} \cdot NMOG + 0.749 \cdot CH_4 + 0.429 \cdot CO + 0.273 \cdot CO_2} \right] \cdot \left[ \frac{NHC_{B.fuel} \cdot SG_{B.fuel}}{(R_a \cdot NHC_{T.fuel} \cdot SG_{T.fuel}) + ((1 - R_a) \cdot NHC_{B.fuel} \cdot SG_{B.fuel})} \right]$$

A second change to the fuel economy calculation is to update the test methods used in determining specific gravity (SG), carbon mass fraction (CMF), and net heat of combustion (NHC). As indicated earlier, EPA designed the existing CAFE equation around the use of E0 test fuel, and specified that these fuel parameters be determined using ASTM methods D1298, D3343, and D3338, respectively. The latter two methods determine the unknown fuel property by mathematical correlation to other known properties, and these correlations are not suitable for ethanol blends as published. Therefore, we are adopting additional calculations to be used with D3343 and D3338 to determine CMF and NHC of E10 test fuel. These modified methods have been previously described in EPA guidance and other technical literature, and are specified in detail in the regulations included as part of this action.<sup>57</sup> We are also adopting method D4052 as equivalent to D1298 for determining SG.

In deriving the appropriate value for Ra, i.e., the value that produces the equivalent fuel economy with Tier 3 E10 test fuel, we used the current Tier 2 methods and R=0.6 when calculating the fuel economy using Tier 2 test fuel, and the updated methods when using Tier 3 test fuel. Because of the changes to the measurement methods discussed in the previous paragraph and the new Ra factor being specific to Tier 3 test fuel, this new equation would not be valid for reporting fuel economy when testing using Tier 2 fuel. We are incorporating the small impacts of these calculation formula changes within the single new Ra factor.

As with the CO<sub>2</sub> adjustment factor, for the CAFE adjustment factor we weighted the results from city (FTP) and highway (HFET) testing in the EPA test program as follows:

$$MPG = \frac{1}{\frac{0.55}{MPG_{city}} + \frac{0.45}{MPG_{highway}}}$$

Our analysis of the study data as described shows that a value of Ra=0.81 produces a fleet average fuel economy difference very close to zero between the two test fuels. Table 3-48 compares the adjusted city/highway weighted fuel economy for each study vehicle as it is currently calculated with Tier 2 fuel to the adjusted fuel economy on Tier 3 fuel using the updated calculations and an Ra value of 0.81. At the right-hand side of the table is the percent difference by vehicle, with the fleet average difference of near zero shown at the bottom.

---

<sup>57</sup> EPA Guidance Letter CD-95-09 and SAE technical paper 930138 describe adjustment of ASTM D3338 and D3343 results for oxygenates. More detail on accommodation of ethanol's volatility impact in the ASTM methods can be found in the memo "Distillation adjustment for ethanol blending in Tier 3 and LEVIII test fuels," May 2, 2018, submitted by Aron Butler to docket EPA-HQ-OAR-2016-0604.

**Table 3-48: Adjusted Fuel Economy Results by Vehicle and Fuel Showing Impact of Ra Factor (City/Highway-Weighted Values).**

|                    | Tier 2 test fuel | Tier 3 test fuel |                   |
|--------------------|------------------|------------------|-------------------|
|                    | R=0.6            | Ra=0.81          | Tier 3 vs. Tier 2 |
| Altima             | 39.26            | 39.32            | 0.16%             |
| Civic              | 48.26            | 48.15            | -0.23%            |
| F150               | 27.87            | 27.69            | -0.65%            |
| Malibu 1           | 34.37            | 34.72            | 1.02%             |
| Malibu 2           | 39.48            | 39.54            | 0.15%             |
| Mazda              | 43.23            | 43.05            | -0.41%            |
| Ram                | 25.34            | 25.36            | 0.09%             |
| Silverado          | 24.58            | 24.46            | -0.46%            |
| Volvo              | 35.95            | 35.98            | 0.08%             |
| Silverado (2b)     | 14.85            | 14.87            | 0.14%             |
| Average difference |                  |                  | -0.01%            |

Figure 3-77 shows the percent change in city/highway weighted fuel economy when moving from Tier 2 to Tier 3 test fuel using three computation methods. The bottom series (with square markers) shows the difference using the carbon-balance calculation, which makes no adjustment for VED and therefore is the best estimate of the actual, real-world effect. The middle series (with round markers) shows the difference calculated using the appropriate CAFE formula and fuel property measurements for each test fuel and R=0.6 for both (from Table 3-47). Finally, the top series (dashed with triangular markers) shows the effect of adjusting the R-factor in the Tier 3 equation to a value of 0.81. The difference of approximately 0.6 percent between the top and middle lines is the fuel economy reduction due to the test fuel change that would be mitigated by the R-factor update. The top line in this figure corresponds to the right-hand column in the previous table.

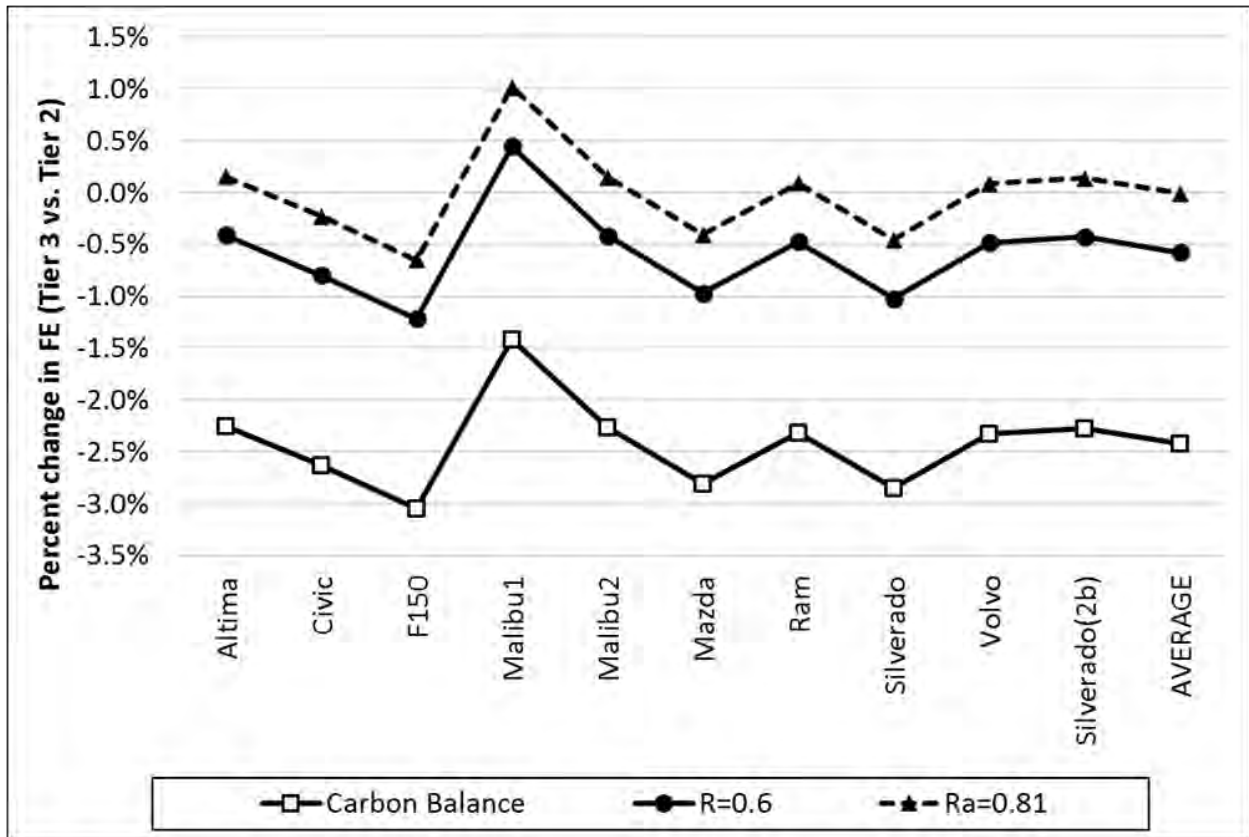


Figure 3-77: City/Highway Weighted Fuel Economy Difference Between Test Fuels for Different Calculation Methods, Shown by Vehicle (Fleet Average at Right).

## Chapter 3 References

40 CFR 600.116-12. 2022. <https://www.ecfr.gov/current/title-40/chapter-I/subchapter-Q/part-600/subpart-B/section-600.116-12>.

40 CFR 600.311–12. 2021. <https://www.ecfr.gov/current/title-40/chapter-I/subchapter-C/part-86/subpart-N/section-86.1360>.

40 CFR 86.1803-01. 2023.

77 FR 62624. 2012. (October 15). <https://www.govinfo.gov/content/pkg/FR-2012-10-15/pdf/2012-21972.pdf>.

86 FR 74434. 2021. (December 30). <https://www.federalregister.gov/documents/2021/12/30/2021-27854/revised-2023-and-later-model-year-light-duty-vehicle-greenhouse-gas-emissions-standards>.

Aaron Isenstadt, Zifei Yang, Stephanie Searle, John German. 2022. Real world usage of plug-in hybrid vehicles in the United States,. <https://theicct.org/publication/real-world-phev-us-dec22/>, ICCT.

Alikin, Evgeny, and Aleksey Vedyagin. 2016. "High Temperature Interaction of Rhodium with Oxygen Storage Component in Three-Way Catalysts." *Topics in Catalysis* 59: 1033-1038. doi:10.1007/s11244-016-0585-z.

ANL. 2022. "Assessment of Light-Duty Plug-in Electric Vehicles in the United States, 2010-2021." November.

ANL. 2024a. Quantification of Commercially Planned Battery Component Supply in North America through 2035. Argonne National Laboratory.

ANL. 2024b. Securing Critical Materials for the U.S. Electric Vehicle Industry. Argonne National Laboratory.

Asako, Tsuyoshi, Daiki Saito, Tetsuhiro Hirao, Emily Popp, Mitsuyoshi Okada, Atsushi Kaneda, Akifumi Kawakami, Etsuji Ohara, and Kentaro Sugimoto. 2022. "Achieving SULEV30 Regulation Requirement with Three-Way Catalyst on High Porosity Substrate while Reducing Platinum Group Metal Loading." SAE Technical Paper 2022-01-0543. SAE. doi:10.4271/2022-01-0543.

Bargman, Ben, SooHyun Jang, Jan Kramer, Ihab Soliman, and Abhid Akram Abubeckar Mohamed Sahul. 2021. "Effects of Electrically Preheating Catalysts on Reducing High-Power Cold-Start Emissions." SAE Technical Paper 2021-01-0572. SAE. doi:10.4271/2021-01-0572.

Battery Design. 2022. GM Ultium. June 8. <https://www.batterydesign.net/gm-ultium/>.

Benjamini, Yoav. 1988. "Opening the box of a boxplot." *The American Statistician* 42 (4): 257-262.

Bhattacharjya,S., et al. 2023. Heavy-light-duty and Medium-duty Range-extended Electric Truck Study. Ann Arbor, Michigan: US EPA.

- Boger, T., and W. Cutler. 2019. Reducing Particulate Emissions in Gasoline Engines. Warrendale, PA: SAE International.
- Bohac, S. V., and S. Ludlam. 2023. "Characterization of a Lightly Loaded Underfloor Catalyzed Gasoline Particulate Filter in a Turbocharged Light Duty Truck." *Journal of Engineering for Gas Turbines and Power* 145(2): 021024. doi:10.1115/1.4056047.
- Bohac, S. V., S. Ludlam, J. Martin, W. T. Preston, and M. D. Hays. 2022. "PAH Emissions from a GPF-Equipped Light Duty Truck during Soot Accumulation and Regeneration." 31st CRC Real World Emissions Workshop, San Diego, CA, March 14-16, 2022.
- Bohac, Stanislav, and Dennis Assanis. 2004. "Effect of Exhaust Valve Timing on Gasoline Engine Performance and Hydrocarbon Emissions." SAE Technical Paper No. 2004-01-3058. doi:10.4271/2004-01-3058.
- Bond, T.C., S. J. Doherty, and D. W., et al. Fahey. 2013. "Bounding the Role of Black Carbon in the Climate System, A Scientific Assessment." *J. Geophys. Res. Atmos.* 118, pp. 5380-5552.
- Borger, T., D. Rose, P. Nicolin, B. Coulet, and A. Bachurina. 2018. "Severe Soot Oxidations in Gasoline Particulate Filter Applications." SAE Paper 2018-01-1699.
- BrightDrop. 2022. "2024 BrightDrop Zevo 400 and Zevo 600 Order Guide." November 4. [https://www.gobrightdrop.com/ca/\\_assets/files/2024-brightdrop-en-ca-zevo-400-and-zevo-600-order-guide-12-23-22.pdf](https://www.gobrightdrop.com/ca/_assets/files/2024-brightdrop-en-ca-zevo-400-and-zevo-600-order-guide-12-23-22.pdf).
- . 2023. BrightDrop - Moving things forward. Accessed December 18, 2023. <https://www.gobrightdrop.com/>.
- Brück, R, and K Konieczny. 2022. "Innovative Catalyst System to Achieve EU7 Legislation." Proceedings of the 43rd International Vienna Motor Symposium, Vienna, Austria.
- California Air Resource Board [OBD data records] . 2022. October. <https://www.bar.ca.gov/records-requests>.
- California Air Resource Board [OBD data records]. 2023. November. <https://www.bar.ca.gov/records-requests>.
- California Environmental Protection Agency, Air Resources Board. 2022. "art 1, Section I.4. California Provisions: Certification and In-Use testing requirements for chassis certified Medium-Duty Vehicles (MDV) with a Gross Combination Weight Rating (GCWR) greater than 14,000 pounds, using the Moving Average Window (MAW)." Final California 2026 and Subsequent Model Year Criteria Pollutant Exhaust Emission Standards and Test Procedures for Passenger Cars, Light Duty Trucks, and Medium-Duty Vehicles. August 25.
- Chan, T. W., Meloche, E., Brezny, R. 2014. "Black Carbon Emissions in Gasoline Exhaust and a Reduction Alternative with a Gasoline Particulate Filter." *Environ. Sci. and Technol.* 48 (10): 6027-6034. doi:10.1021/es501791b.
- Chan, T. W., Meloche, E., Kubsch, J., Brezny, R., Rosenblatt, D., Rideout, G. 2013. "Impact of Ambient Temperature on Gaseous and Particle Emissions from a Direct Injection Gasoline Vehicle and its Implications on Particle Filtration." SAE Paper 2013-01-0527. doi:10.4271/2013-01-0527.

- Chan, T. W., Saffaripour, M., Liu, F., Hendren, J., Thomson, K. A., Kubsh, J., Brezny, R., Rideout, G. 2016. "Characterization of Real-Time Particle Emissions from a Gasoline Direct Injection Vehicle Equipped with a Catalyzed Gasoline Particulate Filter During Filter Regeneration." *Emiss. Control Sci. Technol.* 2 (2): 75-88. doi:10.1007/s40825-016-0033-3.
- Chan, Tak, Meghdad Saffaripour, Fengshan Lui, Jill Hendren, Kevin Thomson, Joseph Kubsh, Rasto Brezny, and Greg Rideout. 2016. "Characterization of Real-Time Particle Emissions from a Gasoline Direct Injection Vehicle Equipped with a Catalyzed Gasoline Particulate Filter During Filter Regeneration." *Emission Control Science and Technology* 2: 75-88. doi:10.1007/s40825-016-0033-3.
- Christianson, M. G., E. Bardasz, and W. Nahumck. 2010. "Impact of Lubricating Oil Condition on Exhaust Particulate Matter Emissions from Light Duty Vehicles." *SAE International Journal of Fuels and Lubricants* Vol. 3, No. 2, pp. 476-488.
- Clenci, Adrian, Julien Berquez, Robert Stoica, Rodica Niculescu, Bogdan Cioc, Căţalin Zaharia, and Victor Iorga-Simăan. 2022. "Experimental investigation of the effect of an afterburner on the light-off performance of an exhaust after-treatment system." *Energy Reports* 8: 406-418. doi:10.1016/j.egy.2022.07.025.
- Continental. 2015. Continental Electrically Heated Catalyst Supports Low-CO<sub>2</sub> 48 Volt Hybrid Strategies. 9 10. Accessed 12 7, 2023. <https://www.continental.com/en/press/press-releases/2015-08-20-volt-e-kat/>.
- Cooper, Jonathan, and Joel Beecham. 2013. "A Study of Platinum Group Metals in Three-Way Autocatalysts." *Platinum Metals Review* 57 (4): 281-288. doi:10.1595/147106713X671457.
- Corning. 2023. Corning® FLORA® Substrates. Accessed 12 15, 2023. <https://www.corning.com/worldwide/en/products/environmental-technologies/products/ceramic-substrates/corning-flora-substrates.html>.
- Daniel Dahl, Ayolt Helmantel, Fredrik Wemmert, Mats Morén, Staffan Rengmyr, and Ali Sahraeian. 2020. "The New Volvo Mild Hybrid Miller Engine." 29th Aachen Colloquium Sustainable Mobility. Aachen.
- Denso. 2022. How do the compressors differ in hybrid and electric vehicles? June 22. Accessed January 4, 2024. <https://www.denso-am.eu/news/how-do-the-compressors-differ-in-hybrid-and-electric-vehicles>.
- Edwards, Adam Jacob. 2022. "Aggressive-dynamics metrics for drive-cycle characterization." *Transportation Research Interdisciplinary Perspectives*, March 30: <https://doi.org/10.1016/j.trip.2022.100592>.
- Faurecia. 2023. Ultra-low emissions solutions. Accessed 12 7, 2023. <https://www.faurecia.com/en/technologies/solutions-sustainable-mobility/Aftertreatment-technologies>.
- Fortune Business Insights. 2022. Automotive E-commerce Market Size, Share & COVID-19 Impact Analysis. July. Accessed December 13, 2022. <https://www.fortunebusinessinsights.com/automotive-e-commerce-market-105728>.

Frigge, Michael, David C. Hoaglin, and Boris Iglewicz. 1989. "Some implementations of the boxplot." *The American Statistician* 43 (1): 50-54.

Gao, Mi-Young Kim, Jae-Soon Choi, C Stuart Daw, James E Parks, and David E Smith. 2012. "Cold-start emissions control in hybrid vehicles equipped with a passive adsorber for hydrocarbons and nitrogen oxides." *Proceedings of the Institution of Mechanical Engineers Part D: Journal of Automobile Engineering* (1396–1407) 226 (10). doi:10.1177/0954407012443764.

Green Car Congress. 2021. Vitesco Technologies reduces emissions in high-voltage hybrid vehicles with electrical catalyst heating; new DC/DC converter. 2 24. Accessed 12 7, 2023. <https://www.greencarcongress.com/2021/02/20210224-vitesco.html>.

GuiQiang Zhang, Qian Wang, Guang Chen, et al. 2020. "Geely Hybrid Engine: World Class Efficiency for Hybrid Vehicles." 29th Aachen Colloquium Sustainable Mobility. Aachen: 29th Aachen Colloquium Sustainable Mobility.

IEA. 2022. "The Role of Critical Minerals in Clean Energy Transitions, World Energy Outlook Special Report, Revised version." International Energy Agency, March.

Isenstadt, A. 2023. "What EPA's New Multi-Pollutant Emissions Proposal Means for PM Emissions and GPFs." ICCT Fact Sheet. [www.theicct.org](http://www.theicct.org).

Jean, Emmanuel, and Maxime Goncalves. 2023. "Electrically Heated Catalyst: A Powerful Tool for Aftertreatment Optimization." *SAE Technical Paper* 2023-01-0351. SAE. doi:10.4271/2023-01-0351.

John Kargul, Mark Stuhldreher, Dan Barba, Charles Schenk, Stani Bohac, Joseph McDonald, and Paul Dekraker. 2019. "Benchmarking a 2018 Toyota Camry 2.5-liter Atkinson cycle engine with cooled-EGR." *SAE International Journal of Advances and Current Practices in Mobility* 1 (2): 601-638. doi:10.4271/2019-01-0249.

Joshi, A., and T. V. Johnson. 2018. "Gasoline Particulate Filters - a Review." *Emission Control Science and Technology* (4)219-239. doi:10.1007/s40825-018-0101-y.

Kawaguchi, Bungo, Kazuhiro Umemoto, Seitaro Misawa, Shigemasa Hirooka, and Takashi Kawai. 2019. "ICE Vehicle Challenge toward Zero Emissions: Future Technology Harmonization in Electrified Powertrain System." *SAE Technical Paper* No. 2019-01-2217. SAE. doi:10.4271/2019-01-2217.

Khameneian, Amir, Paul Dice, Joel Duncan, Jeffrey D. Naber, Mahdi Shahbakhti, Chad Archer, Peter Moilanen, Chris Glugla, and Garlan Huberts. 2022. "Dynamic individual-cylinder analysis of a Gasoline Direct Injection engine emissions for cold crank-start at elevated cranking speed conditions of a Hybrid Electric Vehicle." *Control Engineering Practice* 129: 105349. doi:10.1016/j.conengprac.2022.105349.

Kim, Chang Hwan, Hyokyoung Lee, Chun Yong Kang, and Jin Woo Chung. 2018. "For a New Paradigm in Aftertreatment: The." 27th Aachen Colloquium Automobile and Engine Technology. 1013-1030.

Konstandopoulos, A. G., and Papaionnou, E. 2008. "Update on the Science and Technology of Diesel Particulate Filters." *KONA Power Part J*, 26(0), pp. 36-65.

Krajinska, Poliscanova, Mathieu, & Ambel, Transport & Environment. 2020. "A new Dieselgate in the making." November: <https://www.transportenvironment.org/discover/plug-hybrids-europe-heading-new-dieselgate/>.

Kunath, Florian, Dominik Rose, Bertrand Coulet, Per Nicolin, Thorsten Boger, Thomas Collins, James Grochocinski, and Mrinmoy Dam. 2022. "Technology options to reduce cold start emissions - electric catalyst heaters." 31st Aachen Colloquium Sustainable Mobility. Aachen. Paper No. 58.

Lambert, C., T. Chanko, D. Dobson, X. Liu, and J. Pakko. 2017. "Gasoline Particle Filter Development." *Emiss. Control Sci. Technol.* 3:105-111. doi:10.1007/s40825-016-0055-x.

Lambert, Christine. 2018. "Next Generation Three-Way Catalysts for Future, Highly Efficient Gasoline Engines." U.S. Department of Energy Award DE-EE0006845.

Laurell, Mats, Lorenzo Pace, Fredrik Ekström, and Katrin Konieczny. 2019. "Strive for Zero Emissions Impact from Hybrids." SAE Technical Paper 2019-24-0146. SAE. doi:10.4271/2019-24-0146.

Luo, Xi, Sam Hashemi, Ram Subramanian, Anastasios Arvanitis, and Matthew Younkins. 2020. "Fast Catalyst Light-Off with Dynamic Skip Fire." *SAE Int. J. Advances & Curr. Prac. in Mobility* 2 (4): 1849-1861. doi:10.4271/2020-01-0313.

Mark Stuhldreher . 2016. "Fuel efficiency mapping of a 2014 6-cylinder GM EcoTec 4.3 L engine with cylinder deactivation." SAE Technical Paper. No. 2016-01-0662.

Mark Stuhldreher, Charles Schenk, Jessica Brakora, David Hawkins, Andrew Moskalik, and Paul DeKraker. 2015. "Downsized Boosted Engine Benchmarking and Results." SAE Technical paper no. 2015-01-1266. doi:10.4271/2015-01-1266.

Maurer, Robert, Surya Kiran Yadla, Andreas Balazs, Matthias Thewes, Vitali Walter, and Tolga Uhlmann. 2020. "Designing Zero Impact Emission Vehicle Concepts." *Experten-Forum Powertrain: Ladungswechsel und Emissionierung 2020.* 75-116.

Maurer, Robert, Theodoros Kossioris, Stefan Sterlepper, Marco Günther, and Stefan Pischinger. 2023. "Achieving Zero-Impact Emissions with a Gasoline Passenger Car." *Atmosphere* 14: 313. doi:10.3390/atmos14020313.

Menne, Christoph, Patrick Recker, Andreas Balazs, Joschka Schaub, Markus Ehrly, Thomas Wilkes, Oliver Simons, et al. 2022. "Advanced Hardware, Controls and Calibration Solutions to Meet the Upcoming EURO 7 Legislation." 31st Aachen Colloquium Sustainable Mobility. Aachen. 1-23.

Minjares, R. J., and F. P. Sanchez. 2011. "Estimated Cost of Gasoline Particulate Filters." ICCT Working Paper 2011-8.

Moser, David, Sanket Nipunage, John Nunan, Ryan Day, and Chad Alltizer. 2021. "An Unconventional Application of a HC Trap to Meet SULEV20." SAE Technical Paper 2021-01-0574., SAE. doi:10.4271/2021-01-0574.



Moses-DeBusk, Melanie. 2021. "Chemistry of Cold-Start Emissions and Impact of Emissions Control." DOE Annual Merit Review, ace153. <https://www.energy.gov/eere/vehicles/2021-vehicle-technologies-office-amr-presentations-program>.

Moses-DeBusk, Melanie, John M. E. Storey, Samuel A. Lewis, R. Maggie Connatser, Shannon M. Mahurin, Shean Huff, Cyril V. Thompson, and Yensil Park. 2023. "Detailed hydrocarbon speciation and particulate matter emissions during cold-start from turbocharged and naturally aspirated trucks." *Fuel* 350: 128804. doi:10.1016/j.fuel.2023.128804.

Nakanishi, Yui, Yukio Suehiro, Masanori Hashimoto, Takeshi Narishige, Ryo Takeuchi, Yasuhiro Shimamoto, Shogo Sano, and Hironori Iwakura. 2019. "Development of Low Temperature Active Three Way Catalyst." SAE Technical Paper 2019-01-1293. SAE. doi:10.4271/2019-01-1293.

Nakasumi, Hayaki, Akifumi Kawakami, Etsuji Ohara, Kentaro Sugimoto, Noriyuki Hibi, Tsuyoshi Asako, Kyohei Kato, et al. 2023. "High Cell Density Flow Through Substrate for New Regulations." SAE Technical Paper 2023-01-0359. SAE. doi:10.4271/2023-01-0359.

Newman, K., Kargul, J., and Barba, D. 2015. "Benchmarking and Modeling of a Conventional Mid-Size Car Using ALPHA." SAE Technical Paper 2015-01-1140. doi:10.4271/2015-01-1140.

North American Council for Freight Efficiency. 2021. "Vans & Step Vans: Market Segment & Fleet Profile Fact Sheet." Accessed December 13, 2022. <https://nacfe.org/wp-content/uploads/2022/01/Vans-Step-Vans-RoL-E-Fact-Sheet.pdf>.

Olszewski, Mitch. 2011. EVALUATION OF THE 2010 TOYOTA PRIUS HYBRID SYNERGY DRIVE SYSTEM. Oak Ridge National Laboratory (ORNL).

Patrick Plötz, Cornelius Moll, Georg Bieker and Peter Mock. 2023. "From lab-to-road: real-world fuel consumption and CO<sub>2</sub> emissions of plug-in hybrid electric vehicles (2021 Environ. Res. Lett.16054078)." *Environ. Res. Lett.* 18 099502.

Pham, A, and M Jeftic. 2018. "Characterization of Gaseous Emissions from Blended Plug-In Hybrid Electric Vehicles during High-Power Cold-Starts." SAE Technical Paper 2018-01-0428. SAE. doi:10.4271/2018-01-0428.

Plötz, P., Moll, C., Bieker, G., Mock, P., Li, Y. 2020. "Real-world usage of plug-in hybrid electric vehicles: fuel consumption, electric driving, and CO<sub>2</sub> emissions. ICCT, September 2020." [https://theicct.org/publication/real-world-usage-of-plug-in-hybrid-electric-vehicles-fuel-consumption-electric-driving-and-CO<sub>2</sub>-emissions/](https://theicct.org/publication/real-world-usage-of-plug-in-hybrid-electric-vehicles-fuel-consumption-electric-driving-and-CO2-emissions/).

—. 2020. "real-world-usage-of-plug-in-hybrid-electric-vehicles-fuel-consumption-electric-driving-and-CO<sub>2</sub>-emissions." ICCT. September. [https://theicct.org/publication/real-world-usage-of-plug-in-hybrid-electric-vehicles-fuel-consumption-electric-driving-and-CO<sub>2</sub>-emissions/](https://theicct.org/publication/real-world-usage-of-plug-in-hybrid-electric-vehicles-fuel-consumption-electric-driving-and-CO2-emissions/).

Public Law 117-169. 2022. "The Inflation Reduction Act of 2022." August 16. <https://www.govinfo.gov/content/pkg/PLAW-117publ169/pdf/PLAW-117publ169.pdf>.

Reuters. 2023. "China's graphite curbs will accelerate plans around alternatives." October 23. <https://www.reuters.com/business/autos-transportation/chinas-graphite-curbs-will-accelerate-plans-around-alternatives-2023-10-20/>.

Rivian. 2023. Rivian Fleet - A commercial van that gets work done. Accessed December 18, 2023. <https://rivian.com/fleet>.

Rodriguez, J. Felipe, and Wai K. Cheng. 2017. "Analysis of NO<sub>x</sub> Emissions during Crank-Start and Cold Fast-Idle in a GDI Engine." *SAE International Journal of Engines* 10 (2): 646–655. doi:10.4271/2017-01-0796.

Rodriguez, J. Felipe, and Wai K. Cheng. 2016. "Reduction of Cold-Start Emissions through Valve Timing in a GDI Engine." *SAE International Journal of Engines* 9 (2): 1220-1229. doi:10.4271/2016-01-0827.

Rogers, Susan. 2012. "FY2012 Annual Progress Report - Advanced Power Electronics and Electric Motors Program."

Rogers, Susan. 2013. FY2013 Annual Progress Report for the Advanced Power Electronics and Electric Motors Program. Oak Ridge National Laboratory (ORNL).

Roy, Jean, Ahmed Ghoniem, Robert Panora, and Joseph Gehret. 2018. "NO<sub>x</sub> Reduction Using a Dual-Stage Catalyst System with Intercooling in Vehicle Gasoline Engines under Real Driving Conditions." *SAE International Journal of Engines* 11 (6): 893-901. doi:10.4271/2018-01-0335.

S&P Global. 2022b. "Growth of Li-ion battery manufacturing capacity in key EV markets." May 20. Accessed November 22, 2022. <https://www.spglobal.com/mobility/en/research-analysis/growth-of-liion-battery-manufacturing-capacity.html>.

—. 2022a. "US ready for a battery factory boom, but now it needs to hold the charge." October 3. Accessed November 22, 2022. <https://www.spglobal.com/marketintelligence/en/news-insights/latest-news-headlines/us-ready-for-a-battery-factory-boom-but-now-it-needs-to-hold-the-charge-72262329>.

SAE . 2006. "Vehicle Acceleration Measurement J1491\_200607."

SAE J1711. 2023. "Recommended Practice for Measuring the Exhaust Emissions and Fuel Economy of Hybrid-Electric Vehicles, Including Plug-in Hybrid Vehicles." Issued 1999-03, Revised 2010-06, Revised 2023-02, February.

SAE J2727. 2023. "Mobile Air Conditioning System Refrigerant Emissions Estimate for Mobile Air Conditioning Refrigerants." Issued in 2005-06, Revised in 2023-09, September 6.

SAE J2727 Worksheet Screenshots. 2023. This document is available in Docket EPA-HQ-OAR-2023-xxx-xxx. (December).

SAE J2841. 2010. "Utility Factor Definitions for Plug-In Hybrid Electric Vehicles Using Travel Survey Data." Issued 2009-03, Revised 2010-09, September.

SAE. 2016. "Performance Requirements for Determining Tow-Vehicle Gross Combination Weight Rating and Trailer Weight Rating J2807\_201602." [https://www.sae.org/standards/content/j2807\\_201602/](https://www.sae.org/standards/content/j2807_201602/).

Saito, C., T. Nakatani, Y. Miyairi, and et al. 2011. "New Particulate Filter Concept to Reduce Particle Number Emissions." *SAE Paper* 2011-01-0814. doi:10.4271/2011-01-0814.

Seabaugh, Christian. 2022. "Take a Look Inside Amazon's New Rivian Delivery Van." *Motor Trend*, November 24. Accessed March 9, 2023. <https://www.motortrend.com/news/checking-in-on-the-rivian-amazon-edv-electric-van/>.

Seshadri Srinivasa Raghavan & Gil Tal. 2022. "Plug-in hybrid electric vehicle observed utility factor: Why the observed electrification performance differ from expectation." *International Journal of Sustainable Transportation*, 16:2 105-136. doi:1748-9326/abef8c.

State Department. 2023. "The Minerals Security Partnership Continues to Expand with Norway, Italy, and India, Media Note." September 16.

State of California, Air Resources Board. 2022. "Advanced Clean Cars II Proposed Amendments to the Low Emission, Zero Emission, and Associated Vehicle Regulations - Standardized Regulatory Impact Assessment."

—. 2021. "Advanced Clean Trucks Regulation, Final Approval / OAL Action, Final Regulation Order." March 15. <https://ww2.arb.ca.gov/sites/default/files/barcu/regact/2019/act2019/fro2.pdf>.

Stellantis. 2023. All-new 2025 Ram 1500 Ramcharger Unveiled With Class-shattering Unlimited Battery-electric Range. November 7. Accessed December 13, 2023. <https://media.stellantisnorthamerica.com/newsrelease.do?id=25436>.

Stuhldreher, Mark; Kargul, John; Barba, Daniel; McDonald, Joseph; Bohac, Stanislav; Dekraker, Paul; Moskalik, Andrew. 2018. "Benchmarking a 2016 Honda Civic 1.5-liter L15B7 Turbocharged Engine and Evaluating the Future Efficiency Potential of Turbocharged Engines." *SAE International Journal of Engines* 116: 1273-1305. doi:10.4271/2018-01-0319.

Sun, Zin, Mingguo Ouyang, and Han Hao. 2022. "Surging lithium price will not impede the electric vehicle boom." *Joule* 6 (8): 1738-1742. <https://doi.org/10.1016/j.joule.2022.06.028>.

T. Toda, M. Sakai, M. Hakariya, and T. Kato. 2017. "The New Inline 4 Cylinder 2.5L Gasoline Engine with Toyota New Global Architecture Concept." *Internationales Wiener Motorensymposium*. Vienna.

The White House. 2021. "Building Resilient Supply Chains, Revitalizing American Manufacturing, and Fostering Broad-Based Growth, 100-Day Reviews under Executive Order 14017, p. 121." June.

Theis, Joseph, Andrew (Bean) Getsoian, and Christine K. Lambert. 2018. "The Development of Low Temperature Three-Way Catalysts for High Efficiency Gasoline Engines of the Future: Part II." *SAE Technical Paper* 2018-01-0939. doi:10.4271/2018-01-0939.

Thomas E. Reinhart. 2021. *Engine Efficiency Technology Study: Final Report*, SwRI Project No. 03.26457. San Antonio: Southwest Research Institute.

Title 13 § 1968.2 California Code of Regulations. 2022. (November 22).

Tukey, J. W. 1977. *Exploratory data analysis*. Vol. 2. Addison-Wesley.

U.S. Census Bureau. 2022. February 18. Accessed December 13, 2022. <https://www.census.gov/retail/index.html>.

U.S. EPA. 2023. Annual Certification Data for Vehicles, Engines, and Equipment. August 30. Accessed November 15, 2023. <https://www.epa.gov/compliance-and-fuel-economy-data/annual-certification-data-vehicles-engines-and-equipment>.

—. 2023b. Combining Data into Complete Engine ALPHA Maps. Accessed February 2, 2023. <https://www.epa.gov/vehicle-and-fuel-emissions-testing/combining-data-complete-engine-alpha-maps>.

—. 2023a. Complete Electric Motor ALPHA Maps. <https://www.epa.gov/vehicle-and-fuel-emissions-testing/combining-data-complete-emotor-alpha-maps>.

—. 2022. "Contract No. 68HERC20D0014, Order No. 68HERC21F0317. Powertrain and Vehicle Modeling, Simulation, and Validation."

U.S. EPA. 2022. "Control of Air Pollution from New Motor Vehicles: Heavy-Duty Engine and Vehicle Standards - Regulatory Impact Analysis, EPA-420-R-22-035." <https://nepis.epa.gov/Exe/ZyPDF.cgi?Dockey=P1016A9N.pdf>.

U.S. EPA. 2017. "Final Determination on the Appropriateness of the Model Year 2022-2025 Light-Duty Vehicle Greenhouse Gas Emissions Standards under the Midterm Evaluation, EPA-420-R-17-001." <https://nepis.epa.gov/Exe/ZyPDF.cgi?Dockey=P100QQ91.pdf>.

—. 2012. "Final Rulemaking for 2017-2025 Light-Duty Vehicle Greenhouse Gas Emission Standards and Corporate Average Fuel Economy Standards." August: <https://www.regulations.gov/document/EPA-HQ-OAR-2021-0208-0100>. <https://www.regulations.gov/document/EPA-HQ-OAR-2021-0208-0100>.

U.S. EPA. 2018. "Office of Air Quality Planning and Standards 2014 National Air Toxics Assessment (NATA) Technical Support Document (TSD)." [https://www.epa.gov/sites/default/files/2018-09/documents/2014\\_nata\\_technical\\_support\\_document.pdf](https://www.epa.gov/sites/default/files/2018-09/documents/2014_nata_technical_support_document.pdf).

U.S. EPA. 2016. "Proposed Determination on the Appropriateness of the Model Year 2022-2025 Light-duty Vehicle Greenhouse Gas Emissions Standards under the Midterm Evaluation, EPA-420-R-16-020." <https://nepis.epa.gov/Exe/ZyPDF.cgi?Dockey=P100Q3DO.pdf>.

—. 2022b. Technical Publications and Presentations Concerning Benchmarking. Accessed 11 17, 2022. <https://www.epa.gov/vehicle-and-fuel-emissions-testing/benchmarking-advanced-low-emission-light-duty-vehicle-technology>.

—. 2023. The 2023 EPA Automotive Trends Report: Greenhouse Gas Emissions, Fuel Economy, and Technology since 1975, EPA-420-R-23-033. Accessed January 16, 2024. <https://www.epa.gov/system/files/documents/2023-12/420r23033.pdf>.

U.S. EPA. 2018. "Tier 3 Certification Fuel Impacts Test Program, EPA-420-R-18-004." <https://www.epa.gov/moves/tier-3-certification-fuel-impacts-test-program>.

U.S. EPA, CARB, U.S. DOT NHTSA. 2016. "Draft Technical Assessment Report: Midterm Evaluation of Light-Duty Vehicle Greenhouse Gas Emission Standards and Corporate Average Fuel Economy Standards for Model Years 2022-2025, Report No. EPA-420-D-16-900." <https://nepis.epa.gov/Exe/ZyPDF.cgi/P100OXEO.PDF?Dockey=P100OXEO.PDF>.

- USGS. 2020. "Cobalt Deposits in the United States." U.S. Geological Survey, June 1.
- . 2022. "USGS Updates Mineral Database with Graphite Deposits in the United States." U.S. Geological Survey, February 28.
- van Nieuwstadt, M., A. Shah, E. Serban, and D. Martin. 2019. "Regeneration Strategies for Gasoline Particulate Filters." SAE Paper 2019-01-0969. doi:10.4271/2019-01-0969.
- Warkins, Jason, Tinghong Tao, and Song Lyu. 2020. "Application of Low-Mass Corning® FLORA® Substrates for Cold-Start Emissions Reduction to Meet Upcoming LEV III SULEV30 Regulation Requirement." SAE Technical Paper 2020-01-0652. SAE. doi:10.4271/2020-01-0652.
- Wood Mackenzie. 2022. Battery & raw materials - investment horizon outlook to 2032. Wood Mackenzie.
- . 2023. "How will China's graphite export controls impact electric vehicle supply chain?, subscriber material presentation." November 2.
- Zhu, Shengrong, Jeffrey Hollowell, Kyoung-Pyo Ha , Nicholas Fantin, and Mark Shirley. 2013. "A Method to Reduce Cold Start Emissions while Shortening Fast Idle Catalyst Light-off Time." SAE Technical Paper 2023-01-0247. SAE. doi:10.4271/2023-01-0247.

## **Chapter 4: Consumer Impacts and Related Economic Considerations**

This chapter discusses the impacts of the rule on consumers and related economic considerations. Regarding consumer impacts, we examine the implications of the Final Standards on consumers from three frames of reference, namely the purchase decision, the ownership experience, and social benefits and costs. These three perspectives overlap but also differ in important ways, which we discuss in this chapter. In addition, these three frames of reference relate to EPA OMEGA modeling (see RIA Chapters 2, 3 and 8) and inform EPA's analysis of costs and benefits (see RIA Chapter 9). Furthermore, the impacts of this rule on consumers affect projections of vehicle sales and consequently inform EPA's employment analysis, which we also discuss in this chapter.

In our representation of the purchase decision, we include costs that consumers incorporate into their purchase decision; how consumers respond to costs; and how consumer perceptions of technologies change or do not change over time. In the discussion of the ownership experience, we focus on vehicle use and on consumer savings and expenses for BEVs, PHEVs, and ICE vehicles across three body styles. Specifically, we present projected savings and expenses for average MY 2032 vehicles at the time of purchase and averaged over the first eight years of vehicle life. In the discussion of consumer-related costs and benefits, we include components of social costs and benefits that are included in the benefit-cost analysis and that have direct consumer impacts. In the discussion of vehicle sales, we explain how sales impacts are modeled, as well as show how total vehicle sales are expected to change. We conclude with a discussion of employment impacts in which we discuss potential impacts of the growing prevalence of electric vehicles, present a quantitative discussion of partial employment impacts on sectors directly impacted by this rule, and discuss potential employment impacts on other related sectors.

### **4.1 Modeling the Vehicle Choice within the Purchase Decision**

In this section, we focus our discussion on our modeling of the consumer choice within the purchase decision. We address the decision to buy or not buy in RIA Chapter 4.4. The LD vehicle purchase decision is a complex process (Jackman, et al. 2023, 12-14) (Taylor and Fujita 2018). Consumers consider and value a wide array of vehicle attributes and features as they develop and seek to satisfy their purchase criteria (Fujita, et al. 2022). Body style is a particularly important consumer criterion. Individuals tend to consider vehicles within a body style (Fujita, et al. 2022). Thus, we model vehicle choice within body style, namely sedan and wagons, CUVs and SUVs, and pickups and across other vehicle attributes. The relative shares of body styles over time are taken from the Annual Energy Outlook 2023 as described in RIA Chapter 8.1. Value, as in "value for the money," is also among the most compelling vehicle attributes that consumers consider (Fujita, et al. 2022, 748 & 754) (Jackman, et al. 2023). "Value" is a multi-factor consideration; it includes factors such as purchase, fueling, maintenance, and repair costs, wholly or in part. Thus, these costs play an important role in consumers' decision processes as does consumer sensitivity to those costs, which we capture and quantify in our analyses. Also important to the vehicle purchase decision, but harder to capture and quantify, are consumers' diverse perceptions of other vehicle attributes. These more subjective assessments pertain to vehicle attributes such as comfort, design, image, and performance (Fujita, et al. 2022, 748) as well as to technology (e.g., ICE vehicle, PEV) where decision rules (e.g., compensatory, non-compensatory), attitudes (e.g., technological affinity), and psychological biases (e.g., risk and uncertainty aversion, loss aversion) may be at play (Taylor and Fujita 2018, 37).

In the following discussion of consumers' decision processes, we narrow our focus and modeling to the following key elements: costs that consumers incorporate into their purchase decisions (i.e., purchase, fueling, maintenance, repair, and depreciation); how consumers respond to costs (i.e., logit parameters); and how consumer perceptions of technologies change or do not change over time (i.e., share weight parameters). In addition, as enablers of consumer acceptance of PEVs mature and expand rapidly, we expect that electrification of the light-duty vehicle market will also accelerate dramatically. Thus, we specifically attend to the choice consumers will increasingly make among BEVs, PHEVs, and ICE vehicles by estimating the proportions of new vehicle sales expected to be BEVs, PHEVs, and ICE vehicles. In our modeling, methods are the same for all body styles and powertrains, though the inputs may differ.

During the LD vehicle purchase decision process, consumers reference a wide variety of information during the stages of vehicle purchase. This includes what consumers believe they already know and what they learn from other parties (e.g., friends, family) and external sources (e.g., vehicle labels, websites). From one consumer to the next and from one purchase to another, this information varies in type, quality, and precision. However, there are always both cost and non-cost elements to the vehicle purchase decision. We center our representation of the purchase decision around those two categories.

#### **4.1.1 Cost Elements of the Purchase Decision**

Regarding cost elements, in addition to initial expenses associated with purchase (e.g., purchase price, incentives), consumers incorporate into their purchase decisions reasonably good estimates of the number of miles they expect to drive per year, fueling and charging expenses, and other ownership costs. In our modeling of the consumer's purchase decision, we distill consumer costs into cost per mile, which we also refer to as consumer generalized cost. We discuss non-cost components of the purchase decision in section 4.1.2.

Generalized cost consists of purchase price, purchase incentive, fueling expenses, and non-fueling ownership costs spread over time (i.e., annualized) and over miles traveled. Total cost per mile allows consumers, as represented in the model, to compare vehicles. It is important to note that consumer generalized cost reflects the perception and expectations of consumers (See Consumer Module in RIA Chapter 2.2.2), not producers' expectations of consumers (See Producer Module in RIA Chapter 2.2.2 and RIA Chapter 4.4). In our modeling and as in the real world, consumers and producers make decisions with different information. Consumer generalized cost also is not meant to align with costs calculated within the effects module of OMEGA (See Effects Module in RIA Chapter 2.2.2) and therefore is not reflective of the values used in our benefit cost analysis (See RIA Chapter 4.3 and RIA Chapter 9).

To calculate the consumer generalized cost used in modeling the consumer's purchase decision, we annualize purchase price over 7 years using a 10% discount rate (Zabritski 2023) (Martin 2023).<sup>58</sup> See RIA Chapter 2.5 for the derivation of vehicle purchase price. In addition, we assume that consumers roughly approximate that annual VMT is 15,000 miles, which is consistent with current measures of annual VMT. In our modeling, consumers apply "rules of thumb" when incorporating annual non-fuel ownership costs into their purchase decision. Annual

---

<sup>58</sup> As points of reference, many new vehicle buyers finance their purchase with terms typically range from 24 to 84 months and average 68 months (Zabritski 2023) (Martin 2023).

non-fueling ownership costs for BEVs are \$1,600, annual non-fuel ownership costs for PHEVs are \$1,800, and annual non-fuel ownership costs for ICE vehicles are \$2,000. These amounts are consistent with information consumers will see on the fuel economy and environment label, and they are consistent with OMEGA estimates of these non-fueling ownership costs. Furthermore, via the fuel economy and environment label, consumers also have implicit information regarding the recharging and refueling efficiency of BEVs, PHEVs, and ICE vehicles, which we capture in our modeling of the consumer purchase decision.<sup>59</sup> Recharging efficiency is 0.9, and refueling efficiency for liquid fuels is 1. See Table 4-1 for a summary of operating cost inputs to consumer generalized cost.

To determine fuel cost component of generalized cost, we note that BEV drivers consume only off-board grid electricity as they accumulate miles; ICE vehicle drivers consume only liquid fuels as they accumulate miles; and PHEVs drivers consume off-board grid electric and liquid fuels as they accumulate miles. Individual PHEV drivers consume off-board grid electricity and liquid fuels in proportions based on their own driving, fueling, and charging behaviors. The fraction of distance that a PHEV operates in charge depleting mode (i.e., using predominantly electricity) is called the PHEV utility factor. In our modeling and as discussed in Chapter 3, the mechanism that is used to apportion the benefit of a PHEV's electric operation for purposes of determining the PHEV's contribution toward the fleet average GHG requirements is the fleet utility factor (FUF). We use the finalized FUF curve as part of the consumer purchase decision as well. Here, we use the FUF to model the PHEV fueling costs that consumers incorporate into their purchase decisions. FUF also appears in Table 4-1.

**Table 4-1: Operating cost inputs to consumer generalized cost.**

| Powertrain | Annualization Period (years) | Annualization Rate (%) | Annual VMT (miles) | Annual Non-Fuel Ownership Costs | Refueling Efficiency | Recharging Efficiency | Fleet Utility Factor |
|------------|------------------------------|------------------------|--------------------|---------------------------------|----------------------|-----------------------|----------------------|
| BEV        | 7                            | 10                     | 15,000             | \$1,600                         | NA                   | 0.9                   | 1                    |
| PHEV       | 7                            | 10                     | 15,000             | \$1,800                         | 1                    | 0.9                   | See Chapter 3        |
| ICE        | 7                            | 10                     | 15,000             | \$2,000                         | 1                    | NA                    | 0                    |

Applying the information in Table 4-1, we calculate total cost per mile (aka consumer generalized cost) with a series of related equations. We begin the series of related equations with total cost per mile, which is separated into fuel costs per mile and non-fueling costs per mile, as in the equation below.

$$\text{Total cost per mile} = \text{fuel costs per mile} + \text{nonfueling costs per mile}$$

Fueling cost per mile depends on fuel cost, fuel economy, refueling efficiency, recharging efficiency, and utility factor. Calculating fuel costs per mile, though similar, clearly differs across BEVs, PHEVs, and ICE vehicles due to the relevant energy sources (i.e., electricity and

---

<sup>59</sup> The fuel economy and environment label is affixed to every new light-duty vehicle sold in the United States. The test procedures used to determine MPGe and kWh per 100 miles for BEVs take into account charging inefficiencies.



liquid fuel), units (i.e., kilowatt hours and gallons), refueling and recharging efficiency, and utility factor.<sup>60</sup>

In general, fuel costs per mile are given by the following:

$$\begin{aligned} \text{fuel costs per mile} &= (\text{fleet utility factor}) * (\text{cost per kWh} * \text{kWh per mile}) \\ &\div \text{recharging efficiency} + (1 - \text{fleet utility factor}) \\ &* (\text{cost per gallon} * \text{gallons per mile}) \div \text{refueling efficiency} \end{aligned}$$

where fleet utility factor, refueling efficiency, and recharging efficiency are populated according to Table 4-1, specific to each powertrain. Because the FUF is effectively 1 for BEVs and 0 for ICE vehicles, fuel costs per mile for BEV and ICE vehicles simplify to

$$\text{fuel costs per mile}_{BEV} = (\text{cost per kWh} * \text{kWh per mile}) \div \text{recharging efficiency}$$

and

$$\begin{aligned} \text{fuel costs per mile}_{ICEV} &= (\text{cost per gallon} * \text{gallons per mile}) \div \text{refueling efficiency}_{ICEV} \end{aligned}$$

respectively.

Note that because recharging efficiency is 0.9, which is less than 1, dividing by recharging efficiency increases electricity cost per mile. For liquid fuels, refueling efficiency is 1 and has no effect on liquid fuel cost per mile.<sup>61</sup>

Non-fueling ownership costs per mile include annualized up-front capital costs and annual non-fueling costs like maintenance and repair. Up-front capital costs include the vehicle purchase price and purchase incentives and are generated in OMEGA (See RIA Chapter 2.6 for a full description of purchase price and purchase incentives). To annualize capital costs over a 7-year time period, we first calculate the annualization factor using a 10% discount rate.

$$\text{annualization factor} = \text{rate} * \left( 1 + \frac{1}{(1 + \text{rate})^{\text{time period} - 1}} \right)$$

Then, we multiply the annualization factor and capital costs to determine annualized capital costs.

$$\text{annualized capital costs} = \text{annualization factor} * \text{capital costs}$$

The remaining non-fueling ownership costs are given as annual values in Table 4-1. Thus, total annualized non-fueling costs are the sum of annualized capital costs and annual non-fueling ownership costs. We then calculate non-fueling costs per mile by dividing total annualized non-

---

<sup>60</sup> Note that throughout the equations in the chapter, we will be abbreviating ICE vehicle to ICEV.

<sup>61</sup> To estimate gallons per mile in OMEGA, we divide estimated onroad grams of CO<sub>2</sub> per mile by the estimate fuel carbon intensity.

fueling costs by estimated annual vehicle miles.<sup>62</sup> The following equation shows these calculations.

$$\begin{aligned} & \text{nonfueling costs per mile} \\ &= \frac{\text{annualized capital costs} + \text{annual nonfueling ownership costs}}{\text{annual VMT}} \end{aligned}$$

With the above equation, we have the fueling and non-fueling costs per mile used to determine total cost per mile given by the first equation in this section. We reiterate that total cost per mile is the cost component of the consumer decision process, which we also refer to as consumer generalized cost. It reflects the perception and expectations of consumers during the purchase process, not producers, and is not meant to be perfectly consistent with values used in our benefit cost analysis.

#### **4.1.2 Estimating Market Shares**

##### **4.1.2.1 Consumer Choice**

Total sales are determined as described in Chapter 4.4.<sup>63</sup> Here we focus on how we model consumer choice. We model the choice of vehicle technologies (ICE, PHEV, or BEV) within body style - namely sedan and wagons, CUVs and SUVs, and pickups - and across other vehicle attributes. The relative shares of body styles over time are taken from the Annual Energy Outlook 2023 as described in RIA Chapter 8.1. Most vehicle attributes are implicit in the generalized cost, but we make the choice among vehicle technologies (i.e., BEVs, PHEVs, and ICE vehicles) explicit. Our modeling attends to powertrain (i.e., BEVs, PHEVs, and ICE vehicles) for several reasons, foremost among them are the "consumer facing" nature of PEV technology and the rapid growth in PEV acceptance observed and expected (See Chapter 4.2.2.2).<sup>64</sup> By "consumer facing," we mean that the vehicle technology (i.e., BEVs, PHEVs, and ICE vehicles) is clearly apparent to consumers in addition to the vehicle attributes associated with the technology (e.g., noise, acceleration, convenience).

Based on the distinct differences in refueling procedures that are readily apparent, we assume that consumers view BEV, PHEVs, and ICE vehicles as three distinct choices. In other words, PHEVs are not any more like a BEV than they are like an ICE vehicle.<sup>65</sup> Thus, we calculate the

---

<sup>62</sup> OMEGA also includes a dollar adjustment factor where needed to ensure that costs estimated in OMEGA are in a consistent dollar year. Specifically, in the calculation of nonfueling costs per mile, the sum of annualized capital costs and annual nonfueling ownership costs is also divided by a dollar adjustment factor. This ensures that costs are estimated in 2022 dollars. The dollar adjustment factor is estimated using the GDP Implicit Price Deflator published by the U.S. Bureau of Economic Analysis (see Chapter 2.6.7 of this RIA).

<sup>63</sup> EPA's OMEGA model estimates total vehicle production and sales separately from BEV, PHEV, and ICE vehicle market shares. In short, sales are based on EIA sales projections with limited revisions related specifically to this rule. See Chapter 2 and Chapter 4.4.

<sup>64</sup> We note that expanding the representation of choice beyond powertrain and generalized costs introduces orders of magnitude more complexity than available data does not support.

<sup>65</sup> Commenters Jeremy Michalek et al. from Carnegie Mellon and Yale Universities cautioned us regarding the Independence of Irrelevant Alternatives (IIA) Property in which the introduction of a new choice draws proportionally from existing alternatives [EPA-HQ-OAR-2022-0829-0705, p. 11]. We have revised OMEGA since these comments were made in several ways, including the introduction of PHEVs into the choice structure. We have also re-calibrated the model and tested its internal consistency and external validity.

proportions of BEVs, PHEVs, and ICE vehicles as one calculates weighted averages, and proportions of BEVs, PHEVs, and ICE vehicles are given by the market share equations below.

$$\begin{aligned} \text{market share}_{BEV} &= \frac{\text{weight}_{BEV}}{\text{weight}_{BEV} + \text{weight}_{PHEV} + \text{weight}_{ICEV}} \\ \text{market share}_{PHEV} &= \frac{\text{weight}_{PHEV}}{\text{weight}_{BEV} + \text{weight}_{PHEV} + \text{weight}_{ICEV}} \\ \text{market share}_{ICEV} &= \frac{\text{weight}_{ICEV}}{\text{weight}_{BEV} + \text{weight}_{PHEV} + \text{weight}_{ICEV}} \end{aligned}$$

The representation of choice appears in the weight components of the above equations, which we explain in the weight equations below. Consumer choice includes costs and non-cost elements, represented separately as consumer generalized costs (i.e., total costs per mile) and consumer heterogeneous response to costs (i.e., logit parameter) and consumer perceptions of technology over time (i.e., shareweight parameters).

We first describe consumer choice conceptually. Consumers match vehicle attributes to purchase criteria in their purchase decision (Fujita, et al. 2022). In our modeling, the vehicle attributes we incorporate into consumer choice are represented by an estimate of generalized consumer cost, as derived in Chapter 4.1.1. Generalized consumer cost creates a comparable metric across all vehicles; this monetization of purchase price and ownership costs implicitly includes consumer valuation of vehicle attributes. Thus, generalized consumer cost effectively provides an ordering of vehicle alternatives within body styles.

When presented with identical products, a hypothetical consumer will select the lower priced item. In reality, vehicle attributes and features differ, as do consumers and their purchase criteria. Consumers purchase comparable vehicles over a range of prices. The logit parameter is specified to allow for market penetration of lower and higher vehicle costs. We discuss the logit parameter in more detail in Chapter 4.1.2.2. Consumers also change over time, and so do their perceptions of vehicle technologies. Shareweight parameters represent the remaining non-cost elements of the consumer purchase decision, in aggregate (i.e., on average for all consumers over all non-costs elements) and over time for each technology (i.e., BEV, PHEV, and ICE vehicle). In other words, shareweight parameters are the numerical representation of consumer acceptance discussed in Preamble Section IV.C.6. We discuss the shareweight parameters in more detail and present shareweight parameter values in Chapter 4.1.2.2.

Mathematically, we use a conventional logit formulation to model vehicle technology weights resulting from the consumer decision process. This formulation employs one variable - total cost per mile and two types of parameters - the logit and shareweights.

$$\begin{aligned} \text{weight}_{BEV} &= \text{shareweight}_{BEV} * (\text{total cost per mile}_{BEV})^{\text{logit}} \\ \text{weight}_{PHEV} &= \text{shareweight}_{PHEV} * (\text{total cost per mile}_{PHEV})^{\text{logit}} \\ \text{weight}_{ICEV} &= \text{shareweight}_{ICEV} * (\text{total cost per mile}_{ICEV})^{\text{logit}} \end{aligned}$$

To determine market shares, the shareweight is multiplied by the exponential term in the weight equations above. Effectively, the shareweight mediates the effect of total cost per mile term on the distribution of consumer purchase decisions.<sup>66</sup> For example, a shareweight of 1 has no mediating effect whereas shareweights greater or less than one do. Shareweights complete the weight calculations for BEVs, PHEVs, and ICE vehicles (i.e., the second set of equations in this section), and therefore, the calculation of BEV, PHEV, and ICE vehicle market shares (i.e., the first pair of equations in this section). Market shares are multiplied by total vehicle sales, per Chapter 4.4, to arrive at the OMEGA's estimate of BEV, PHEV, and ICE vehicle sales.

Before closing out this section, we note that the logit formulation that we use here reflects well-established methods in the transportation, policy, and vehicle choice scientific literatures. The Global Change Analysis Model (GCAM) also uses the logit formulation to represent economic choice (JGCRI n.d.) and is among leading approaches to modeling the future of electric vehicles (Taylor 2023). EPA has adopted the GCAM terminology of "shareweight" to represent relative consumer acceptance of different technologies choices (JGCRI n.d.) However, terminology varies. The logit formulation we utilize in OMEGA is also an example of random utility discrete choice models in which shareweights are called alternative specific constants. Commenters Jeremy Michalek et al. reviewed "over 200 automotive demand model studies in the scientific literature and government reports [and] found random utility discrete choice models to be the dominant paradigm for modeling automotive demand, with the logit model and its variants most commonly used. Thus, EPA's demand model follows the dominant paradigm and inherits the properties of random utility discrete choice models."<sup>67</sup>

#### **4.1.2.2 Consumer Response to Costs and Acceptance of Technology**

As stated above, there are always cost and non-cost elements to the vehicle purchase decision. We center our representation of the purchase decision around those two categories. The cost component is given by consumer generalized costs (i.e., total costs per mile) and is discussed in Chapter 4.1.1. The non-costs components are given by the logit and shareweight parameters, applied in the equations above and discussed in more detail below.

##### **4.1.2.2.1 Response to Costs: More on the logit parameter**

Because consumers are diverse, consumers purchase comparable vehicles over a range of prices. The logit is specified to represent market penetration of lower and higher cost vehicle technologies. In other words, some consumers will purchase a lower-cost vehicle technology and others will purchase a higher-cost vehicle technology. The distributions of purchases of higher- and lower-cost technologies overlap. Specifically, we apply a logit exponent of -8 to total cost per mile to achieve this effect. This value is based on logit values utilized in other choice models and consistent with the shareweight parameters we discuss below. The negative sign of the logit parameter reflects that alternatives are represented with costs (i.e., lower cost items are generally preferred) and the magnitude of the logit parameter regulates the degree to which relative costs affect choice among BEVs, PHEVs, and ICE vehicle technologies.

---

<sup>66</sup> For example, a shareweight of 1 has no mediating effect whereas a shareweight greater or less than one does. Note, however, shareweight values are meaningful only relative to each other since they appear in the numerator and denominator of the market share calculation by way of the technology weight equations.

<sup>67</sup> [EPA-HQ-OAR-2022-0829-0705, p. 10]

#### **4.1.2.2.2 Acceptance of Technology: Background and Shareweight Estimates**

We capture the evolution of consumer acceptance of vehicle technologies using parameters called shareweights. Shareweights are the numerical representation of consumer acceptance discussed in Section IV.C.6 of the preamble. More precisely, shareweights represent the non-cost elements of the consumer purchase decision in aggregate (i.e., on average for all consumers over all non-costs elements) and over time for each technology (i.e., BEV, PHEV, and ICE vehicle). These non-cost elements include internal and external characteristics of individuals and households (e.g., attitudes, demographics), vehicle attributes not included in generalized cost, and conditions of the physical, social, economic, and governmental systems (e.g., charging stations, neighborhood effects).

In the following, we first motivate our quantitative and technology-based representation of consumer acceptance (i.e., shareweight values). Then we present the shareweight values used in our analysis.

##### **4.1.2.2.2.1 Research on Consumer Acceptance of Light-Duty PEVs**

Our modeling separately attends to powertrain (i.e., BEVs, PHEVs, and ICE vehicles). PEV technology is "consumer facing," meaning that the technology is clearly apparent to consumers. EPA in coordination with the Lawrence Berkeley National Laboratory (LBNL), conducted a comprehensive review of the scientific literature regarding consumer acceptance of PEVs. That effort culminated in a peer-reviewed report on PEV acceptance in which EPA and LBNL organize and summarize the enablers and obstacles of PEV acceptance evident from the scientific literature (Jackman, et al. 2023). The review concluded that "there is no evidence to suggest anything immutable within consumers or inherent to PEVs that irremediably obstructs acceptance." More simply put, the enablers of PEV acceptance are external to the person. With the evolution of the environment in which people make decisions (e.g., infrastructure, advertising, access) and advancements in technology and vehicle attributes (e.g., range, body style, price), widespread acceptance of PEVs is very likely to follow.

Since the conclusion of that review EPA has stayed abreast of even more recent research regarding PEV acceptance. Foremost among those studies are the recent third-party projections of PEV market shares. EPA reviewed several recent reports and studies containing PEV projections, all of which include the impact of the IRA; none consider the impact of this rule. Altogether, these studies project PEV market share in a range from 42 to 68 percent of new vehicle sales in 2030. The mid-range projections of PEV sales from these studies, to which we compare our No Action case, range from 48 to 58 percent in 2030. We discuss third-party estimates in more detail in Chapter 4.1.2.2.2.5 and Figure 4-2: Moderate third party PEV market shares with IRA. Figure 4-2.

In addition, C. Forsythe et al. (2023b), found that when consumers' basic demands for vehicle attributes are met, they accept or prefer BEVs to combustion vehicles. They conclude that "BEVs could constitute the majority or near-majority of cars and SUVs by 2030, given widespread BEV availability and technology trends" and "with the assumed technological innovations, even if all purchase incentives were entirely phased out, BEVs could still have a market share of about 50% relative to combustion vehicles by 2030, based on consumer choice

alone.” Via public comments, Jeremy Michalek et al.<sup>68</sup> describes a working paper in which they conducted a discrete choice experiment of representative sample of 52 pickup truck owners across the U.S. They found that 78% pickup truck owners are open to purchasing electric pickup trucks if the technology provides sufficient performance attributes. For 43% of respondents, vehicle choice is driven primarily by what the vehicle can do, rather than its powertrain type (C. Forsythe, K. Gillingham, et al., Will pickup truck owners go electric? 2023a).

In a recent report, LBNL used current, publicly available data to demonstrate that a substantial number of non-BEV owners already exhibit some of the key enabling characteristics of current BEV adopters. They primarily examined the enablers of the “access” component of acceptance, including characteristics of individuals and households. For example, 47 percent of U.S. households own a single-family home with reasonable charging capabilities, making the convenience and savings associated with residential charging feasible for nearly half of U.S. households. Furthermore, in another recent report, LBNL challenges emergent rules of thumb regarding PEV acceptance (e.g., wealthy, urban, male). (Taylor, Fujita and Campbell 2024 ) Their work suggests that there is untapped demand among mainstream vehicle buyers that the conventional wisdom regarding who buys and who doesn’t buy PEVs does not serve. For example, they note that early PEVs were not well-positioned to appeal to a large segment of the population. Specifically, most early EVs were hatchbacks in a market where hatchbacks represent a small portion of sales generally. In addition, vehicle buyers tend to consider and purchase vehicles with the same body style (e.g., many buyers only consider SUVs) and certain body styles are more or less common in different locations (e.g., pickups tend to be more common in rural areas).

#### **4.1.2.2.2 Market Observations**

In vehicle markets, PEV market shares have historically been in the single digits. However, PEV sales have grown rapidly and are expected to continue to grow rapidly and robustly in response to substantial progress in key market enablers of PEV adoption (Jackman, et al. 2023), namely increased PEV sales, increased PEV choice, expanding infrastructure, declining PEV prices, and production and purchase incentives. For example, annual sales of light-duty PEVs in the U.S. have grown robustly and are expected to continue to grow. PEVs reached 9.8% of monthly sales in January 2024 and were 9.3% of all light-duty vehicle sales in 2023, up from 6.8% in 2022. (Argonne National Laboratory 2024) This robust growth combined with vehicle manufacturers’ plans to expand PEV production strongly suggests that PEV market share will continue to grow rapidly. Also, the number of PEV models available to consumers is increasing, meeting consumers demand for a variety of body styles and price points. Specifically, the number of BEV and PHEV models available for sale in the U.S. has increased from about 24 in MY 2015 to about 60 in MY 2021 and to over 180 in MY 2023, with offerings in a growing range of vehicle segments.<sup>69</sup> Data from JD Power and Associates shows that MY 2023 BEVs and PHEVs are now available as sedans, sport utility vehicles, and pickup trucks. In addition, the greatest offering of PEVs is in the popular crossover/SUV segment (Taylor, Fujita and Campbell 2024 ). In addition, the expansion of charging infrastructure has been keeping up with PEV adoption as discussed in Section IV.C.4 of the preamble and RIA Chapter 5. This trend is widely

---

<sup>68</sup> [EPA-HQ-OAR-2022-0829-0705, p. 8]

<sup>69</sup> Fueleconomy.gov, 2015 Fuel Economy Guide, 2021 Fuel Economy Guide, and 2023 Fuel Economy Guide.

expected to continue, particularly in light of very large public and private investments. Furthermore, while the initial purchase price of BEVs is currently higher than for most ICE vehicles, the price difference is likely to narrow or become insignificant as the cost of batteries fall and PEV production rises in the coming years.<sup>70</sup> (Slowik, Isenstadt, et al. 2022) Among the many studies that address cost parity, an emerging consensus suggests that purchase price parity is likely to be achievable by the mid-2020s for some vehicle segments and models.<sup>71</sup> (Slowik, Isenstadt, et al. 2022) (ERM 2022) Specifically, the International Council on Clean Transportation (ICCT) projects that price parity with ICE vehicles will "occur between 2024 and 2026 for 150- to 200-mile range BEVs, between 2027 and 2029 for 250- to 300-mile range BEVs, and between 2029 and 2033 for 350- to 400-mile range BEVs." The Environmental Defense Fund notes that "most industry experts believe wide-spread price parity will happen around 2025." Finally, the Inflation Reduction Act provides a purchase incentive of up to \$7,500 for eligible light-duty vehicles and buyers, which is expected to increase consumer uptake of zero emissions vehicle technology. (Slowik, Searle, et al. 2023)

#### **4.1.2.2.2.3 EPA Analyses: Cross References and Robustness**

In addition to scientific research related to consumer acceptance of PEVs, the observed and expected acceleration of PEV adoption and key enablers in vehicle markets is further substantiated by EPA's analysis of key enablers of PEV acceptance. These include increased PEV production (e.g., as seen in the EPA Trends Report (U.S. EPA 2023)); increasing and expanding private and public charging infrastructure (See RIA Chapter 5); emerging industry standards (e.g., standardization of charging ports); advances in PEV technology (see RIA Chapter 3), maturation of supply chains (See RIA Chapter 3.1.4 on critical minerals etc.), reductions in battery cost (See RIA Chapter 2.5) and PEV manufacturing cost and purchase price (see RIA Chapters and 4.2.2.1), and PEV production and purchase incentives (See RIA Chapter 2.6 on IRA). Among these interacting systems, we observe several positive feedback mechanisms that indicate that this system of enablers is robust; in their comments, Consumer Report called it a "virtuous cycle" in which consumer demand will continue to grow. For example, more PEV production leads to economies of scale, maturing supply chains, and intensified competition, which feeds cost declines resulting in more demand, looping back to more production. More PEV options (e.g., models, body styles) and advances in PEV technology lead to more sales among consumers whose purchase criteria can be met by PEVs. More PEV sales leads to more experience with PEVs and more exposure, which leads to more demand and more sales. More PEV sales leads to demand for infrastructure and charging services that, when present, lead to more PEV demand and sales.

---

<sup>70</sup> "This analysis does not consider the effect of any available state, local, or federal subsidies and tax incentives for electric vehicles and their charging infrastructure" (page 30).

<sup>71</sup> (ERM 2022) notes the Inflation Reduction Act (IRA), but estimates do not take into account effects of the IRA.

#### 4.1.2.2.2.4 Diffusion of Innovation

This robust network of PEV enabling systems aligns well with several well-established models of innovation diffusion and the adoption of new technologies.<sup>72</sup> Rogers' (2003) Diffusion of Innovation Theory is especially well-known and characterizes well the pattern of adoption of innovations observed through history. (Rogers 2003) Typically, sales of a new technology are low and increase slowly and unpredictably in what is called the innovator and early adopter stage, when consumers of the new technology are likely to share an affinity for new technology as well as other characteristics that support trying something new. However, after the early adopter stage, adoption increases very quickly, with rapidly accelerating demand as the technology becomes mainstream. Mainstream adopters are often described as the early and late majority, and as LBNL's most recent work on PEV acceptance suggests, we are seeing evidence of the mainstream, early majority consumers entering the market or exhibiting traits consistent with PEV adopters (Taylor, Fujita and Campbell 2024 ) (Fujita, Campbell and Taylor 2024). As commenters from Environmental and Public Health Organizations describe, "this S-shaped pace of technology adoption has been observed for numerous emerging technologies since the early 1900s, including the telephone, the automobile, electricity, refrigeration, clothes washers and dryers, air conditioning, microwaves, computers, cellphones, and the internet."<sup>73</sup>

Consistent with this diffusion of innovation framework, we expect PEV adoption to follow the S-shaped behavior so often observed in the diffusion of innovation and well established via Diffusion of Innovation Theory. The first question is what does this S-shaped curve actually look like? Specifically, how steep is the curve; how fast is PEV market share growing? How high is the curve; what is the highest expected market share? When does growth in market accelerate and slow down? The second question is what point on the curve represents the current market? Are we in the early stages of slow and unpredictable growth? Or are we on the cusp of dramatic growth? With OMEGA, we demonstrate multiple plausible compliance pathways for MY 2027 to MY 2032 vehicles that reflect a segment of an S-shaped adoption curve (See RIA Chapter 12.1). The Central case, which gives our estimate of the most likely future PEV market share under the standards, shows that we are nearing the end of the early adopter phase, and by 2030, the early majority (first wave of mainstream new vehicle consumers) will have purchased PEVs.

---

<sup>72</sup> Among the most well-known are Diffusion of Innovation Theory, Theory of Planned Behavior, Theory of Reasoned Action, and the Technology Acceptance Model. Lee et al. (2019) characterizes them well in the following: "Diffusion of innovations theory (Rogers 2003) outlines why people adopt innovations, who adopts them, and adoption rates over time... [including] information about the socio-demographic profile of early adopters. [Other] consumer innovation adoption models, for example the theory of planned behaviour (Ajzen 1991), theory of reasoned action (Fishbein and Ajzen 2009), or the technology acceptance model (Venkatesh and Davis 2000) ... focus on motivational factors or behavioural issues."

<sup>73</sup> Honda comments on well-established pattern on technology diffusion as well. They note, however, that these historical transitions have typically been longer than what they perceived as roughly a decade-long transition to roughly two-thirds of new vehicle sales being PEVs in EPA's proposal. We respond to these comments in RTC Chapter 13. Here we note that EPA's projections are of new vehicle sales only. We also note that plug-in electric vehicle technology has been around for decades; it became available commercially as a passenger vehicle in 2013 with the Nissan Leaf; rapid advancements in the technology and exponential growth in PEV adoption have already been observed in the market; and the pace of technological innovation and diffusion in general in the 21st century is much faster than in the 20th.



In other words, according to our best assessment of current and future vehicle market, PEV adoption is on the cusp of/has entered a period of very rapid and accelerating growth.

Consistent with the diffusion of innovation framework, we expect aggregate measures of PEV acceptance to have been low and unpredictable in the early years, then grow and accelerate rapidly until some level of saturation is reached (e.g., everyone who is ever going to accept or prefer a PEV actually approves of PEVs, even if they do not own one). We capture the evolution of consumer acceptance of vehicle technologies using parameters called shareweights. In the language of models, relative acceptance of vehicle technologies is an input given by the shareweight parameters, and projected market shares of vehicle technologies is the output that is based on non-cost elements of the consumer's purchase decision (i.e., shareweight and logit parameters) as well as on the consumer's estimates of the cost elements of their purchase decision (i.e., consumer generalized costs).

#### 4.1.2.2.5 Shareweights

Below we discuss the shareweights, used in the No Action case, Final Standards, and Alternatives. Shareweights are the quantitative representation of consumer acceptance. In aggregate, shareweights quantitatively represent the non-cost components of vehicle technology choice over time. As evident above, the shareweights we present here reflect the current state of the art in terms of the scientific literature on consumer acceptance of PEVs (e.g., (Jackman, et al. 2023) (C. Forsythe, K. Gillingham, et al., Will pickup truck owners go electric? 2023a) (C. R. Forsythe, K. T. Gillingham, et al., Technology advancement is driving electric vehicle adoption 2023b) (Gillingham, et al. 2023)), existing policy-relevant models and modeling paradigms (e.g., (Taylor 2023)), and third party estimates (e.g., (Cole, et al. 2023) (IEA 2023) (C. R. Forsythe, K. T. Gillingham, et al., Technology advancement is driving electric vehicle adoption 2023b) (Bloomberg NEF 2023) (U.S. DOE 2023) (Slowik, Searle, et al. 2023)) as well as Congressional investments (e.g., BIL, IRA).

Shareweights are the numerical representation of consumer acceptance discussed in Preamble Section IV.C.6. More precisely, shareweights represent the remaining non-cost elements of the consumer purchase decision, in aggregate (i.e., on average for all consumers over all non-costs elements) and over time for each technology (i.e., BEV, PHEV, and ICE vehicle).<sup>74</sup> These non-cost elements include internal and external characteristics of individuals and households (e.g., attitudes, demographics), vehicle attributes not included in generalized cost, and conditions of the physical, social, economic and governmental systems (e.g., charging stations, neighborhood effects). As with the concept of consumer acceptance, shareweights are meaningful only relative to other shareweights. Therefore, shareweights should be interpreted only in comparison to the shareweights of other vehicle technology choices. To facilitate this, we treat ICE vehicle shareweights as the reference technology and set ICE vehicle shareweights to 1 in all years, in every scenario. By normalizing the shareweight of ICE vehicles to 1, we can compare all other shareweights to ICE vehicle shareweights.

Based on the motivating information provided throughout Chapter 4.1.2.2.2, we expect consumer acceptance of PEVs initially to be lower than for ICE vehicles, meaning that all else equal, consumers on average tend to prefer ICE vehicles to PEVs. Thus, PEV shareweights are

---

<sup>74</sup> The logit parameter, discussed in Chapter 4.1.2.2.1, also represents non-cost elements of the purchase decision.

less than 1. However, in 2027 we expect that PEV acceptance will already be in a period of rapid and accelerating growth, meaning that consumer utility of PEVs, due to factors other than generalized costs, is improving over time (e.g., PEV awareness and access, charging infrastructure, model variety). BEV and ICE vehicle acceptance will likely converge for sedans, wagons, CUVs, and SUVs by 2030, signifying when consumers will be indifferent, on average between BEV and ICE vehicles of the same generalized cost. In quantitative terms, BEV shareweights increase to 1 for sedans, wagons, CUVs, and SUVs around 2030. In other words, BEV and ICE vehicle acceptance converge for sedans, wagons, CUVs, and SUVs, signifying when consumers will be indifferent, on average between BEV and ICE vehicles of the same generalized cost. All else equal, as in C.R. Forsythe et al. (2023b), BEV could comprise 50% of new vehicle sales by 2030 for "cars and SUVs."

Our modeling also reflects conditions in the new vehicle market specific to pickups and PHEVs. While wagons, sedans, CUVs, and SUVs are largely, though not exclusively, used to transport passengers and their stuff (i.e., cargo), pickups more often fulfill needs such as hauling and towing. Though research indicates that hauling and towing in an EV reduces mileage by about the same rate as in ICE pickup, the impact of towing and hauling is often mentioned as a reason consumers might not want to purchase an EV pickup.<sup>75</sup> As a result, there may be a subset of pickup consumers who perceive BEVs as not acceptable. To capture this, BEV pickup shareweights increase over time, though not as rapidly as for other body styles, and do not converge with ICE vehicle shareweights; BEV pickup shareweights are always less than 1. In other words, on average, BEV pickups will be chosen less often than ICE pickups with the same cost to consumers. PHEV acceptance is expected to be notably lower overall than for BEV and ICE vehicles. Based on observed market uptake of PHEVs, the complexity of PHEV technology, the possible perception of PHEVs as stopgap or transitory technology, and the greater tendency of PHEV buyers to convert to BEVs in subsequent purchases than BEVs to PHEVs (Lee, et al. 2023), average acceptance of PHEVs is modeled with shareweights that rise over time but are much lower than for BEV and ICE vehicles. Under these expectations, PHEVs are expected to be less preferred on average relative to BEV and ICE vehicles. We represent this numerically with shareweights that increase less quickly than BEV shareweights reaching a maximum of .5, half that of BEV and ICE vehicles.

Importantly, in this analysis, we treat shareweight parameters as exogenous to the standards. We recognize, as some commenters also noted, that the standards themselves are likely to motivate faster relative acceptance of PEVs by way of the multiple positive feedback mechanisms associated with increased production of PEVs (e.g., increased exposure, economies of scale, reduced costs and prices, expanding infrastructure, rising familiarity). However, while we expect that increased production of PEVs will most likely be a part of automakers compliance strategies, we have also demonstrated several compliance pathways with different levels of PEV market share (See Preamble Section IV and RIA Chapter 12). Therefore, we apply the same shareweight values for the No Action case, the Final Standards, and Alternative cases. Similarly, with the exception of the Acceptance sensitivity cases (e.g., RIA Chapter 4.1.3) and Manufacturer Compliance Pathway sensitivity cases (pathways 'B' and 'C' in preamble I.B.1, IV.F, and IV.G), we use the same shareweight values for all remaining Sensitivity case analyses.

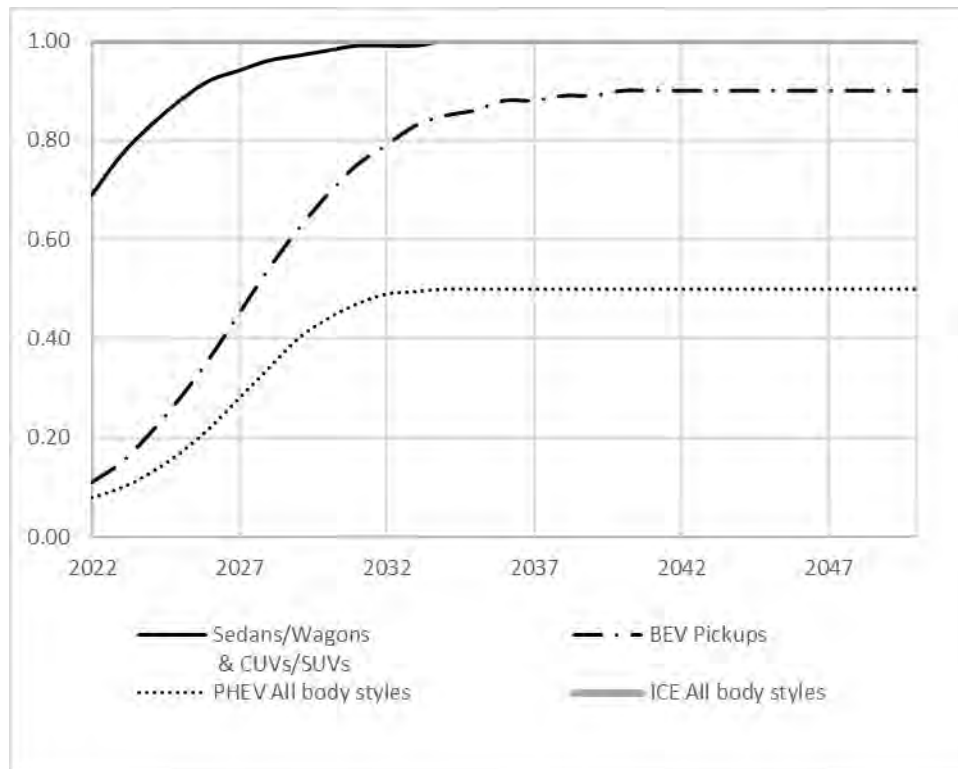
---

<sup>75</sup> For example, see (Georgiou 2022).

Table 4-2 shows shareweight values by body style for BEVs, PHEVs, and ICE vehicles. BEV shareweights differ by body style whereas shareweights for PHEVs and ICE vehicles do not. Figure 4-1 illustrates the shareweight values for light-duty vehicles.

**Table 4-2: Central case shareweight values for light-duty vehicles.**

| Calendar Year | BEV           |         |         | PHEV            | ICE             |
|---------------|---------------|---------|---------|-----------------|-----------------|
|               | Sedans/Wagons | CUV/SUV | Pickups | All body styles | All body styles |
| 2022          | 0.69          | 0.69    | 0.11    | 0.08            | 1.00            |
| 2023          | 0.77          | 0.77    | 0.15    | 0.10            | 1.00            |
| 2024          | 0.83          | 0.83    | 0.21    | 0.13            | 1.00            |
| 2025          | 0.88          | 0.88    | 0.28    | 0.17            | 1.00            |
| 2026          | 0.92          | 0.92    | 0.36    | 0.22            | 1.00            |
| 2027          | 0.94          | 0.94    | 0.45    | 0.28            | 1.00            |
| 2028          | 0.96          | 0.96    | 0.54    | 0.34            | 1.00            |
| 2029          | 0.97          | 0.97    | 0.62    | 0.40            | 1.00            |
| 2030          | 0.98          | 0.98    | 0.69    | 0.44            | 1.00            |
| 2031          | 0.99          | 0.99    | 0.75    | 0.47            | 1.00            |
| 2032          | 0.99          | 0.99    | 0.79    | 0.49            | 1.00            |
| 2033          | 0.99          | 0.99    | 0.83    | 0.49            | 1.00            |
| 2034          | 1.00          | 1.00    | 0.85    | 0.50            | 1.00            |
| 2035          | 1.00          | 1.00    | 0.86    | 0.50            | 1.00            |
| 2036          | 1.00          | 1.00    | 0.88    | 0.50            | 1.00            |
| 2037          | 1.00          | 1.00    | 0.88    | 0.50            | 1.00            |
| 2038          | 1.00          | 1.00    | 0.89    | 0.50            | 1.00            |
| 2039          | 1.00          | 1.00    | 0.89    | 0.50            | 1.00            |
| 2040          | 1.00          | 1.00    | 0.90    | 0.50            | 1.00            |
| 2041          | 1.00          | 1.00    | 0.90    | 0.50            | 1.00            |
| 2042          | 1.00          | 1.00    | 0.90    | 0.50            | 1.00            |
| 2043          | 1.00          | 1.00    | 0.90    | 0.50            | 1.00            |
| 2044          | 1.00          | 1.00    | 0.90    | 0.50            | 1.00            |
| 2045          | 1.00          | 1.00    | 0.90    | 0.50            | 1.00            |
| 2046          | 1.00          | 1.00    | 0.90    | 0.50            | 1.00            |
| 2047          | 1.00          | 1.00    | 0.90    | 0.50            | 1.00            |
| 2048          | 1.00          | 1.00    | 0.90    | 0.50            | 1.00            |
| 2049          | 1.00          | 1.00    | 0.90    | 0.50            | 1.00            |
| 2050          | 1.00          | 1.00    | 0.90    | 0.50            | 1.00            |



**Figure 4-1: Central case shareweight values for light-duty vehicles.**

The BEV and PHEV shareweights shown in Figure 4-1 were developed by EPA as calibrated values using the generalized logistic form.<sup>76</sup> By calibrating shareweight values specifically for this analysis rather than, for example, using values directly from GCAM or other choice models, we are ensuring consistency with EPA's other modeling assumptions such as the projected state of ICE and PEV technologies, production constraints, consumer acceptance, charging infrastructure, etc. Our approach to calibration involved determining the appropriate relative position of shareweights by body style and technology, determining appropriate value bounds, and finally, appropriate shareweight values.

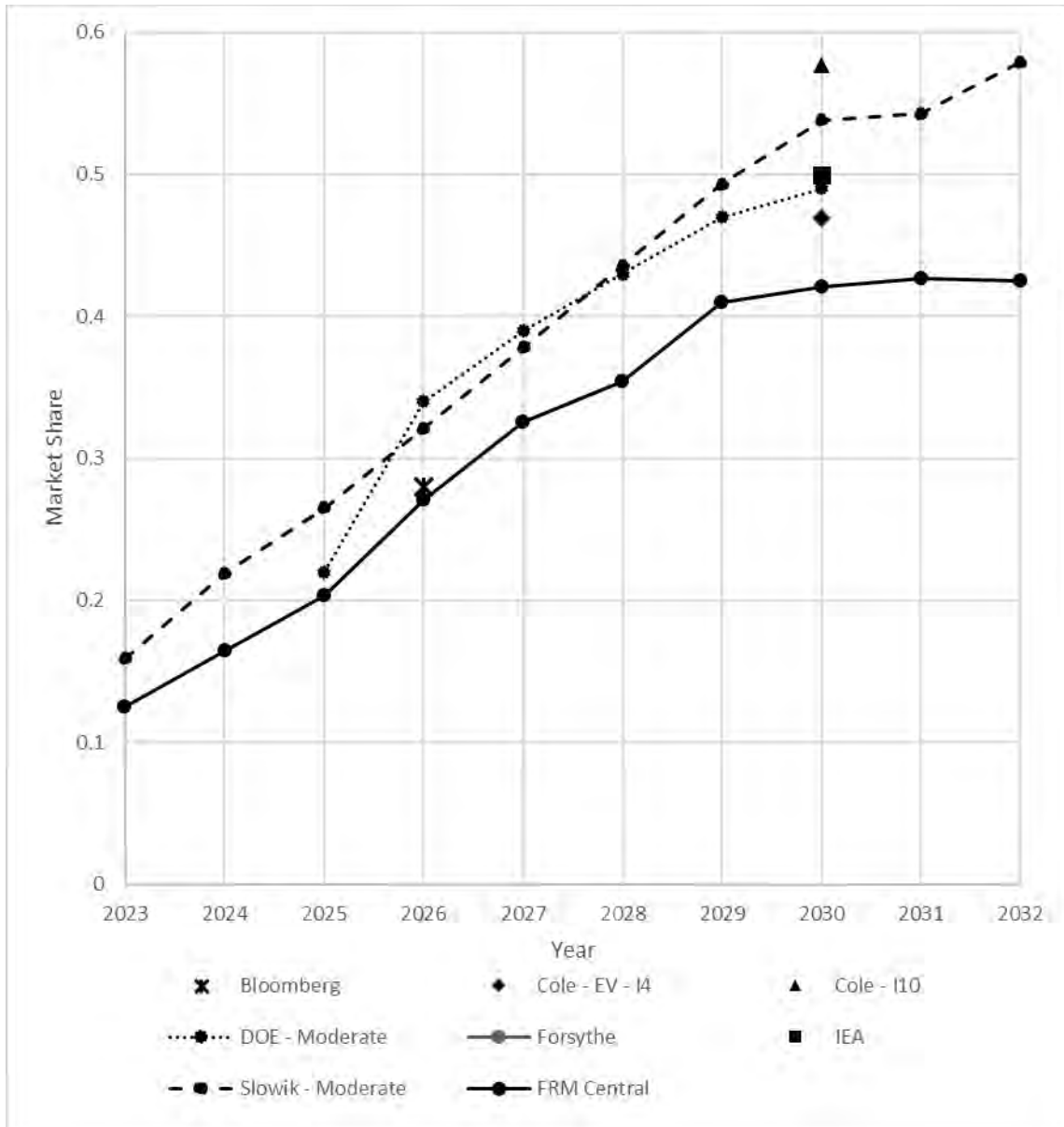
For the final standards, we have revised BEV shareweights from the values used in the Proposal. A recent study (C. R. Forsythe, K. T. Gillingham, et al., Technology advancement is driving electric vehicle adoption 2023b) and recent BEV SUV sales following the introduction of SUV BEV models demonstrates that acceptance of BEV CUVs, and SUVs is similar to BEV sedans and wagons. Another recent study projects stronger consumer acceptance of BEV pickups than estimated for the NPRM while simultaneously acknowledging the possibility that for some locations and use cases, BEV pickups may not become acceptable (C. Forsythe, K. Gillingham, et al., Will pickup truck owners go electric? 2023a). Thus, BEV acceptance for pickups is now represented with larger shareweights in the near term than in the NPRM but also with maximum

---

<sup>76</sup> We use the generalized logistic form in the calibration of shareweights. Specifically,  $Y(t) = \frac{K-A}{(C+Qe^{-Bt})^{1/\nu}}$ , where  $t$  is time and  $Y(t)$  is shareweight at time  $t$ .

shareweight values below 1. PHEV and therefore PHEV shareweights were added to our analysis. As stated above, PHEV acceptance is expected to be notably lower overall than for BEV and ICE vehicles. Thus, average acceptance of PHEVs is modeled with shareweights that rise over time but are much lower than for BEV and ICE vehicles. In addition, and in the absence of evidence to the contrary, shareweights for PHEVs are the same across body styles. We examine PHEV shareweights further via alternative pathways. See preamble sections I.B.1, IV.F, and IV.G and RIA Chapter 12.1.

In addition, for this final rulemaking analysis, consistent with the approach used for the proposal, we calibrated shareweight values for the FRM so that the overall BEV, PHEV, and ICE vehicle market shares produced by the OMEGA model in the No Action case are consistent with third party estimates. EPA reviewed several recent studies to support this calibration. Unlike the proposal, all of the third-party projections reviewed for the calibration of shareweights include effects of the IRA. Among these third-party estimates, there is a range of assumptions that vary across these studies such as consumer adoption, state level policies, financial incentives, manufacturing capacity and vehicle price. We took care to account for the differing assumptions underlying third party estimates. Altogether, these studies project PEV sales spanning a range from 42 to 68 percent of new vehicle sales in 2030 (Cole, et al. 2023) (Wood, et al. 2023). The mid-range third party estimates of PEV market shares range from 48 to 58 percent in 2030 (Cole, et al. 2023) (IEA 2023) (C. R. Forsythe, K. T. Gillingham, et al., Technology advancement is driving electric vehicle adoption 2023b) (Bloomberg NEF 2023) (U.S. Department of Energy, Office of Policy 2023) (Slowik, Searle, et al. 2023). We show the mid-range estimates in Figure 4-2.



**Figure 4-2: Moderate third party PEV market shares with IRA.**

As already noted, the shareweights used in the No Action case, Final Standards, and Alternatives reflect the current state of the art in terms of the scientific literature on consumer acceptance of PEVs, existing policy-relevant models and modeling paradigms, and calibration to third party estimates as well as Congressional investments (e.g., BIL, IRA). We refer to shareweights discussed above and given in Table 4-2 and Figure 4-1 as the Central case. Below we examine other representations of BEV acceptance via the "faster BEV acceptance" and "slower BEV acceptance" cases presented below in Chapter 4.1.3.

### **4.1.3 BEV Acceptance Sensitivities**

Though the Central case shareweights quantitatively estimate the most likely path of PEV acceptance based on the research and analyses documented in RIA Chapter 4.1.2.2.2, we

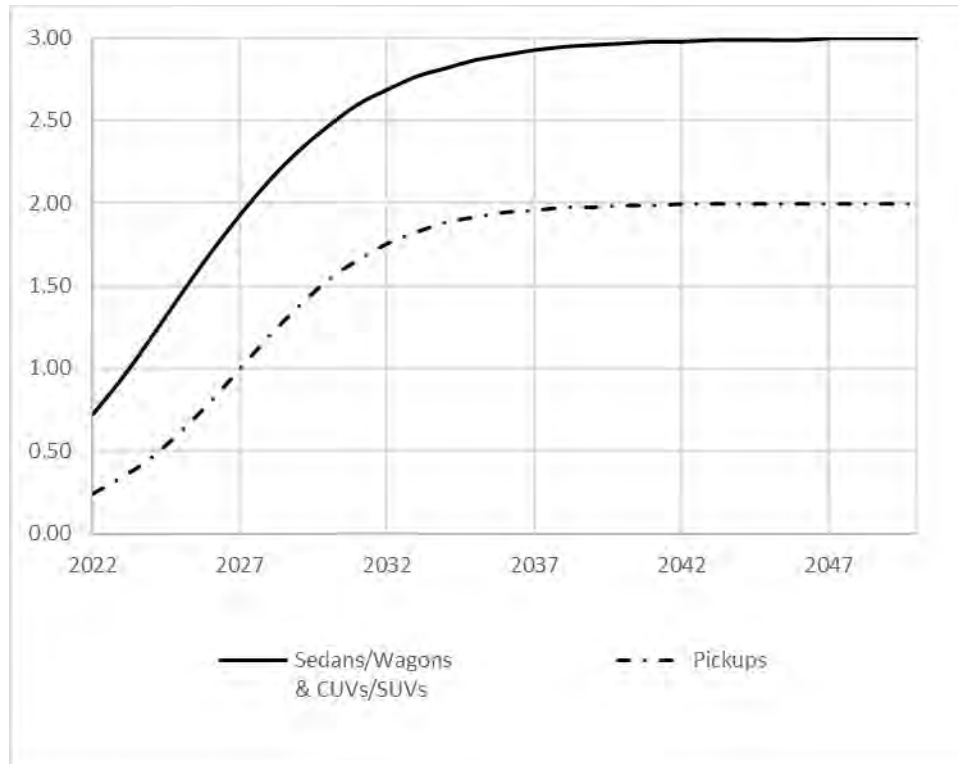
acknowledge that the pace of PEV acceptance could be faster or slower than the assumed in our Central case analysis. Therefore, we also evaluated sensitivity scenarios to explore the impact of other shareweight assumptions. We conducted sensitivities of both faster and slower consumer acceptance of BEVs. In a Faster BEV Acceptance case, BEV acceptance could rise very quickly and exceed acceptance of ICE vehicles by orders of magnitude. For sedans, wagons, CUVs, and SUVs this could mean that, within just a few years, BEV acceptance will match and then surpass that of ICE vehicles. In other words a consumer is just as willing or more likely to choose a BEV than an ICE vehicle, all else equal. In fact, recent evidence suggests that BEVs may already be preferred, all else equal (Gillingham, et al. 2023). Specifically, Gillingham et al. (2023) examined all new LD vehicles sold in the U.S. between 2014 and 2020 and compared existing electric vehicles to their most similar ICE vehicle counterpart. They found that BEVs are preferred to the ICE counterpart in some segments. In addition, a survey from Consumer Reports in 2022 indicates that more than 70 percent of survey respondents felt that BEVs are as good or better than ICE vehicles, up from about 46 percent in 2017 (Bartlett 2022).

Thus, under our Faster BEV Acceptance case, we assume that BEV acceptance rises dramatically and exceeds ICE vehicle acceptance for all body styles by 2027. Table 4-3 and Figure 4-3 show shareweight values for faster BEV acceptance by body style. In this sensitivity, the value of shareweights for BEVs are larger for all body styles. Values for PHEV and ICE vehicle shareweights remain unchanged from the Central case, meaning that relative level of acceptance for and vehicles is lower in the "faster BEV acceptance" case.

**Table 4-3: Faster BEV acceptance shareweight values by body style for light-duty.**

| Calendar Year | BEV           |         |         |
|---------------|---------------|---------|---------|
|               | Sedans/Wagons | CUV/SUV | Pickups |
| 2022          | 0.72          | 0.72    | 0.24    |
| 2023          | 0.94          | 0.94    | 0.34    |
| 2024          | 1.19          | 1.19    | 0.46    |
| 2025          | 1.45          | 1.45    | 0.62    |
| 2026          | 1.70          | 1.70    | 0.80    |
| 2027          | 1.93          | 1.93    | 1.00    |
| 2028          | 2.14          | 2.14    | 1.20    |
| 2029          | 2.32          | 2.32    | 1.38    |
| 2030          | 2.47          | 2.47    | 1.54    |
| 2031          | 2.60          | 2.60    | 1.66    |
| 2032          | 2.69          | 2.69    | 1.76    |
| 2033          | 2.77          | 2.77    | 1.83    |
| 2034          | 2.82          | 2.82    | 1.89    |
| 2035          | 2.87          | 2.87    | 1.92    |
| 2036          | 2.90          | 2.90    | 1.95    |
| 2037          | 2.93          | 2.93    | 1.96    |
| 2038          | 2.95          | 2.95    | 1.98    |
| 2039          | 2.96          | 2.96    | 1.98    |
| 2040          | 2.97          | 2.97    | 1.99    |
| 2041          | 2.98          | 2.98    | 1.99    |
| 2042          | 2.98          | 2.98    | 2.00    |
| 2043          | 2.99          | 2.99    | 2.00    |
| 2044          | 2.99          | 2.99    | 2.00    |
| 2045          | 2.99          | 2.99    | 2.00    |
| 2046          | 2.99          | 2.99    | 2.00    |
| 2047          | 3.00          | 3.00    | 2.00    |
| 2048          | 3.00          | 3.00    | 2.00    |
| 2049          | 3.00          | 3.00    | 2.00    |
| 2050          | 3.00          | 3.00    | 2.00    |





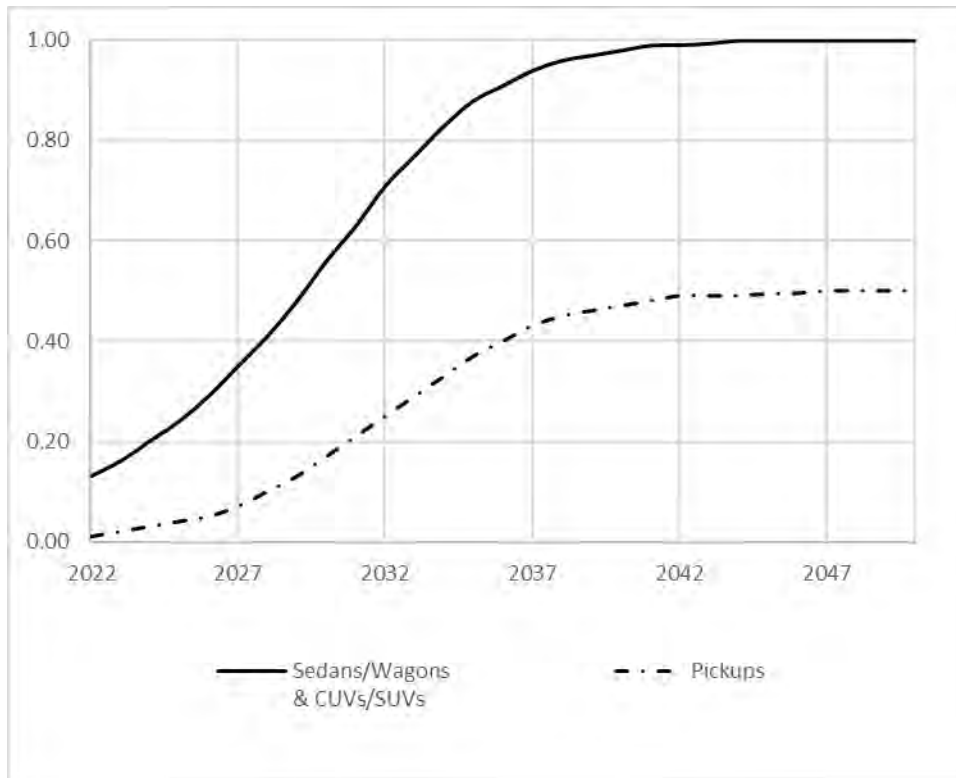
**Figure 4-3: Faster BEV acceptance shareweight values by body style for LD vehicles.**

Though it appears to be very unlikely given the evidence for BEV acceptance, we acknowledge that BEV acceptance may be slower than in the Central case as suggested by some commenters. Jackman et al. (2023) discusses some of the issues new vehicle buyers might encounter, such as lack of familiarity with PEVs and uncertainty about charging infrastructure. As we discuss in Chapter 5.3.1, large investments in charging infrastructure from the private sector and the U.S. government via the BIL and IRA are intended to address these uncertainties over time. Nevertheless, in characterizing "slower" acceptance, we assume that ICE vehicles will be preferred to BEVs until much later than in the Central case, all else equal. Thus, shareweights for all body styles are less than 1 until 2044, and shareweights for pickups do not exceed 0.5. We also assume that BEV acceptance for all body styles grows less rapidly in the early to mid-2030's, roughly coincident with the expiration of IRA producer and consumer incentives.

Table 4-4 and Figure 4-4 show slower BEV acceptance shareweight values by body style for light-duty vehicles. Note that the absolute value of PHEV and ICE vehicle shareweights remain unchanged, but their relative level of acceptance compared to BEVs is higher in the "slower BEV acceptance" case than in the Central case.

**Table 4-4: Slower BEV acceptance shareweight values by body style for light-duty.**

| Calendar Year | BEV           |         |         |
|---------------|---------------|---------|---------|
|               | Sedans/Wagons | CUV/SUV | Pickups |
| 2022          | 0.13          | 0.13    | 0.01    |
| 2023          | 0.16          | 0.16    | 0.02    |
| 2024          | 0.20          | 0.20    | 0.03    |
| 2025          | 0.24          | 0.24    | 0.04    |
| 2026          | 0.29          | 0.29    | 0.05    |
| 2027          | 0.35          | 0.35    | 0.07    |
| 2028          | 0.41          | 0.41    | 0.10    |
| 2029          | 0.48          | 0.48    | 0.13    |
| 2030          | 0.56          | 0.56    | 0.17    |
| 2031          | 0.63          | 0.63    | 0.21    |
| 2032          | 0.71          | 0.71    | 0.25    |
| 2033          | 0.77          | 0.77    | 0.29    |
| 2034          | 0.83          | 0.83    | 0.33    |
| 2035          | 0.88          | 0.88    | 0.37    |
| 2036          | 0.91          | 0.91    | 0.40    |
| 2037          | 0.94          | 0.94    | 0.43    |
| 2038          | 0.96          | 0.96    | 0.45    |
| 2039          | 0.97          | 0.97    | 0.46    |
| 2040          | 0.98          | 0.98    | 0.47    |
| 2041          | 0.99          | 0.99    | 0.48    |
| 2042          | 0.99          | 0.99    | 0.49    |
| 2043          | 0.99          | 0.99    | 0.49    |
| 2044          | 1.00          | 1.00    | 0.49    |
| 2045          | 1.00          | 1.00    | 0.49    |
| 2046          | 1.00          | 1.00    | 0.50    |
| 2047          | 1.00          | 1.00    | 0.50    |
| 2048          | 1.00          | 1.00    | 0.50    |
| 2049          | 1.00          | 1.00    | 0.50    |
| 2050          | 1.00          | 1.00    | 0.50    |



**Figure 4-4: Slower BEV acceptance shareweight values by body style for light-duty.**

## 4.2 Ownership Experience

Having described how we model the consumer purchase decision in Chapter 4.1, we turn to the estimated effects of the final standards on individual consumers. In this section, we focus specifically on the ownership experience of vehicle consumers, including vehicle miles traveled and rebound effect, consumer savings and expenses, and other ownership considerations. A discussion of some aspects of consumer-related social benefits and costs appears in Chapter 4.3.

### 4.2.1 Vehicle Miles Traveled and Rebound Effect

Critical to estimating the impacts of emissions standards is the number of vehicle miles traveled (VMT). In the proposed rule, we acknowledged that individual vehicle miles vary. (U.S. EPA 2021) In our analyses, aggregate vehicle miles are determined exogenously (see RIA Chapter 8 for details). While measures and estimates of VMT for ICE vehicles is well-established in previous EPA LD rules, and described in RIA Chapter 8, how much consumers drive their PEVs has been changing as the technology evolves and PEVs become more common. Thus, in the following discussion, we give particular attention to electric vehicle miles traveled (eVMT).<sup>77</sup>

The rebound effect is the means by which aggregate VMT is influenced by the policy alternatives. The rebound effect generally refers to the additional energy consumption that may

<sup>77</sup> Raghavan and Tal (2021) define eVMT “as the miles driven by off-board grid electricity”; we define eVMT as the miles produced with electricity drawn from a source external to the vehicle.

arise from the introduction of a more efficient, lower cost energy service. In this and previous rules, the rebound effect was defined as additional miles traveled in response to a lower cost of driving. Previous rules estimated the rebound effect based on changes in fuel cost per mile, without distinguishing between vehicles with different fuel sources. With a growing number of PEVs, we acknowledge the importance of possible differences in rebound across vehicle technologies and depending on the energy source or sources used to produce miles. PHEVs, for example, produce both miles from liquid fuel and electricity in proportions that depend on consumers' charging and use behaviors. BEVs produce only electric miles, and ICE vehicles produce only combustion miles.

Importantly, the rebound effect offsets the energy savings benefits of efficiency improvements to some degree. Because rebound driving consumes fuel and generates emissions, the magnitude of the rebound effect influences actual fuel savings and emission reductions that will result from the standards. Furthermore, rebound driving provides value to the consumer if they choose to drive more. We discuss these costs and benefits in Chapter 4.3, and in Section VIII of the Preamble. In this chapter, we address miles driven and rebound.

#### **4.2.1.1 Basis for Vehicle Miles Traveled for Battery Electric Vehicles**

The eVMT literature consists of a handful of studies, including the very recent studies listed in Table 4-5. Two of the listed studies are based on California data collected by UC Davis researchers, and both find that annual VMT for PEVs is similar to annual VMT for ICE vehicles (Chakraborty et al. 2022; Raghavan and Tal 2021). The four other studies, using New York, California, and national data, find that annual VMT for PEVs is less than annual VMT for ICE vehicles (Zhao, et al. 2023) (Nehiba 2024) (Burlig, et al. 2021) (Davis 2019). These studies offer a similar summary of the pre-existing data and research related to annual PEV miles in the U.S. Namely, though lower cost per mile has historically been associated with more driving, this has not been observed for PEVs, for which the cost of driving per miles is lower than for ICE vehicles.<sup>78</sup> Instead, average annual VMT for PEVs has historically been lower than for ICE vehicles. This observation has been attributed to the shorter range of first generation PEVs, typically less than 100 miles just five or six years ago, as well as to substitution across vehicles for multiple vehicle households, and to the typical type of households who bought an electric vehicle in the time frame of the data (Zhao, et al. 2023) (Chakraborty, Hardman and Tal 2022) (Davis 2022) (Raghavan and Tal 2021) (Davis 2019), that is, households with characteristics correlated with lower VMT regardless of vehicle technology (Chakraborty, Hardman and Tal 2022). This area of research continues to face several challenges including the relatively low market penetration and uneven distribution of PEVs; the rapid evolution of PEV technology and the PEV market; and the relative difficulty in obtaining comprehensive and up-to-date data on how PEVs are driven (Burlig, et al. 2021) (Chakraborty, Hardman and Tal 2022) (Nehiba 2024) (Jackman, et al. 2023). As a result, the data that are available for empirical analyses are not likely to be representative of the current and future general population of car buyers and their driving behavior.

---

<sup>78</sup> See Chapter 11.2.3 of this RIA, which compares fueling costs for PEVs and ICE vehicles within its discussion of energy security.

**Table 4-5: Recent scientific studies of eVMT.**

| Study                               | Average Annual Electric VMT Results   | Data Description   |
|-------------------------------------|---|--|
| (Chakraborty, Hardman and Tal 2022) | “Overall, we observe that factors influencing PEV VMT are like those observed for conventional gasoline vehicles. We find that PEVs drive a similar amount as conventional vehicles, not less ... as some have suggested.”  | Location: California<br>Years: 2015-2019<br>Sources: Two surveys with reported odometer readings and on-board recorders<br>Number of PEVs: 16,736 (survey) and 369 (on board recorders)  |
| (Raghavan and Tal 2021)             | Average annual eVMT by vehicle model ranged from 10,841 for the Nissan Leaf to 17,236 for the Tesla Model S with 80kWh battery capacity.  | Location: California<br>Years: 2015 (survey and logger), 2017 (survey only), 2019 (logger only)<br>Sources: GPS loggers on vehicles in two-car households and online survey<br><br>Number of households: 73  |
| (Zhao, et al. 2023)                 | "BEVs have accumulated fewer annual miles than conventional gasoline vehicles ... BEVs with larger ranges were driven more, but increasing range has diminishing returns in terms of higher annual mileage...BEV sensitivity to operating costs was also less than other powertrains."  | Location: United States<br>Years: 2016-2022 (model years 2016 to 2020)<br>Source: Odometer readings from 12.5 million used cars and 11.4 million used SUVs listed between 2016 and 2022.<br>Vehicle Ages: 2 to 9 years<br>Number of PEVs: 304,954 cars and 13,245 SUVs |
| (Nehiba 2024)                       | “The average BEV in New York is driven 9,060 miles/year, substantially less than the 10,910 miles/year average for all passenger cars and light trucks in New York in 2019 ... However BEV mileage increased rapidly across vehicle model years, converging toward ICEV mileage...This convergence could be explained by technological improvements...Particularly, rapid increases in battery ranges appear to play an important role, but the relationship between range and mileage flattens for higher range.”    | Location: New York<br>Years: January 2017 – January 2021<br>Sources: Annual vehicle safety inspection odometer readings; residential and residential electricity prices matched by zip code  |
| (Burlig, et al. 2021)               | “ ... our estimates [of overall household electricity load around EV registration events] indicate that EV load in California is surprisingly low. ... Given the fleet of EVs in our sample, and correcting for the share of out-of-home charging, our estimates translate to approximately 1,700 electric vehicle miles traveled (eVMT) per year for plug-in hybrid EVs (PHEVs) and 6,700 eVMT per year for battery EVs (BEVs). These eVMT values are substantially less than internal combustion engine (ICE) VMT.” | Location: California<br>Year: 2014-2017<br>Sources: 10 percent of residential electricity meters in the Pacific Gas and Electric (PG&E) utility territory (362,945 households) merged with EV registration records (63,765 vehicles)<br>Number of PEVs: 57,290         |
| (Davis 2019)                        | “These data show that electric vehicles are driven considerably less on average than gasoline- and diesel-powered vehicles. In the complete sample, electric vehicles are driven an average of 7,000 miles per year, compared to 10,200 for gasoline and diesel-powered vehicles. The difference is highly statistically significant and holds for both all-electric and plug-in hybrid vehicles, for both single- and multiple-vehicle households, and both inside and outside California.”                          | Name: 2017 National Household Travel Survey<br>Location: United States<br>Year: 2017<br>Source: Survey with reported annual vehicle miles<br>Number of PEVs: 862   |

Based on these study results and the transparency with which they communicate data limitations, there is no evidence that PEVs have been driven more than ICE vehicles, and study results conflict regarding whether annual eVMT has been less for PEVs. None of these studies accurately estimate current and future VMT for PEVs. EPA concludes that the existing empirical evidence does not support the conclusion that current or future average annual eVMT differs or will differ from annual VMT for ICE vehicles. Therefore, EPA uses the same annual VMT for PEVs and ICE vehicles throughout our analyses.

#### **4.2.1.2 Basis for the Rebound Effect for Internal Combustion Engines and PHEVs**

In the 2021 rule, EPA provided a summary of the historical and recent literature on the light-duty (LD) vehicle rebound effect, the ways it is defined (e.g., direct, indirect, economy-wide, short- to medium-run, long-run), how it is estimated, and the basis for the rebound effect used for internal combustion engine vehicles (ICE vehicles). Based on that review and assessment of studies of the LD rebound effect, EPA used a single point estimate of 10 percent for the direct, short- to medium-run rebound effect for ICE vehicles in the 2021 rule. In this current rule, EPA is again using a value of 10 percent as an input to the agency's analyses for the direct, short- to medium-run rebound effect for ICE vehicles. Similarly, EPA is using the point estimate of 10 percent for the direct, short- to medium-run rebound effect for PHEVs. We refer the reader to the 2021 rule RIA Chapters 3.1 and 8.3.3 and Preamble Section 1 for the full discussions of the rebound effect and the point estimate used. (U.S. EPA 2021). See RIA Chapter 4.2.1.3 regarding the rebound effect for BEVs.

#### **4.2.1.3 Basis for Rebound Effect for Battery Electric Vehicles**

As described briefly above, the rebound effect for BEVs is the additional miles traveled in response to a lower cost of driving. First, we do not model increasing energy efficiency for BEVs over time. EPA has identified three current studies that estimate a rebound effect for BEVs in the U.S., which we list in Table 4-6. Results of the three studies are mixed. Using odometer readings from millions of used cars and SUVs, Zhao, Ottinger, Yip, and Helveston (2023) found that "BEV sensitivity to operating costs was less ... than other powertrains." Using data gathered from California PEV drivers, Chakraborty, Hardman, and Tal (2022) find no evidence of an eVMT rebound effect. Nehiba (2024) finds a rebound effect of 10 percent in an analysis of the "entire BEV population in New York." Nehiba (2024) also finds that the responsiveness of eVMT to electricity prices "falls as public charging stations – where prices are often decoupled from electricity costs – become available."

**Table 4-6: Recent scientific studies of eVMT rebound.**

| Study                               | Electric Rebound Results   | Data   |
|-------------------------------------|--|--|
| (Zhao, et al. 2023)                 | " ...BEV sensitivity to operating costs was also less than other powertrains."   | Location: United States<br>Years: 2016-2022 (model years 2055 to 2020)<br>Source: Odometer readings from 12.5 million used cars and 11.4 million used SUVs listed between 2016 and 2022.<br>Vehicle Ages: 2 to 9 years<br>Number of PEVs: 304,954 cars and 13,245 SUVs |
| (Chakraborty, Hardman and Tal 2022) | "Moreover, while lower electricity price at home may lead to a higher share of PEV VMT in total household VMT, we do not identify the presence of 'rebound effect'."                                   | Location: California<br>Years: 2015-2019<br>Sources: Two surveys with reported odometer readings and on-board recorders<br>Number of PEVs: 16,736 (survey) and 369 (on board recorders)  |
| (Nehiba 2024)                       | "A 10% increase in per mile [residential] electricity costs reduces mileage by 1%," but "BEV drivers become less responsive to residential prices when public charging stations ... become available." | Location: New York<br>Years: January 2017 – January 2021<br>Sources: Annual vehicle safety inspection odometer readings; residential and residential electricity prices matched by zip code  |

Given the mixed results of these studies and the historical evidence that BEVs are not driven more than ICE vehicles, EPA assumes no eVMT rebound in our analyses. In other words, we assume no additional electric vehicle miles in response to factors such as lower electricity prices, higher BEV efficiency, or higher liquid fuel prices. See RIA Chapter 4.2.1.2 regarding the rebound effect for ICE vehicles and PHEVs.

**4.2.2 Consumer Savings and Expenses**

Though manufacturers' production costs are projected to increase to meet the light-duty standards (See Preamble Section IV.C and RIA Chapter 12), the standards are projected to save individual consumers thousands of dollars. EPA estimates that the standards will save an average consumer more than \$6,000 over the lifetime of a light-duty vehicle, as compared to a vehicle meeting the MY 2026 standards.<sup>79</sup> These savings emerge as a result of modest advancements in ICE-based vehicle technology as well as substantial increases in PEV market share. See RIA Chapter 4.1.2.2.2.2 regarding market observations of PEV market share and PEV enablers.

In the following, we first present summaries of projected consumer savings and expenses associated with the standards for sales-weighted average model year 2032 vehicles over a vehicle lifetime of 24 years. Then we present consumer savings and expenses for sales-weighted average model year 2032 PEVs and ICE vehicles over the first 8 years of vehicle life, which is the

---

<sup>79</sup> This estimate excludes vehicle taxes and any investment in home charging installation.

current average amount of time the first owner has possession of the vehicle (Blackley n.d.) (Autolist 2022).<sup>80,81</sup> For both 24-year (i.e., full vehicle lifetime) and 8-year (i.e., average duration of first ownership) summaries, we show average consumer savings and expenses for three body styles - sedans and wagons, CUVs and SUVs, and pickups. Specifically, we provide OMEGA estimated national, sales-weighted average expenses associated with new model year 2032 vehicles. Consistent with OMEGA and EPA's benefit cost analysis, the EPA estimated dollar amounts are given in 2022 dollars (2022\$) with no discounting. Other dollar amounts are consistent with original sources and noted. In addition, we group expenses based on whether they occur with vehicle purchase (i.e., upfront), reoccur (i.e., average annual), or represent an optional, one-time household investment (i.e., one-time optional). For upfront purchase-related items and one-time household investments, we present the full amounts. For recurring expenses, we present sales-weighted average annual, undiscounted amounts.

Importantly, these expenses and savings represent a subset of ownership savings, expenses, incentives, and investments that meet the following criteria: the savings and expenses can reasonably be expected to be experienced by buyers of MY 2032 vehicles; data and generally accepted conventions exist to estimate reasonably precise quantities; and bounds on uncertainty can be established. These criteria imply the exclusion of savings and expenses that vary substantially across individuals and/or locations and can be calculated for a specific person or place based on information in the table and other readily available information.

Furthermore, this discussion should not be interpreted as a “total cost of ownership” analysis but as a summary of average MY2032 vehicle expenses and savings that fit the above criteria, across body styles and powertrains, and under the final standards.<sup>82</sup> Lastly, these consumer ownership savings and expenses should not be confused with the societal costs and benefits that appear in RIA Chapter 4.3 and RIA Chapter 9. That is, the presentation here is not meant to reflect the incremental costs of the standards, nor is it meant to reflect the Benefit Cost Analysis or net benefits of the standards. Instead, it is meant to inform the public of the average out-of-

---

<sup>80</sup> The average vehicle ages at which original owners sell their cars, SUVs, and pickup trucks were 8.4, 8.3, and 8.7 years, respectively, according to a study conducted by iSeeCars.com. “iSeeCars.com analyzed more than 5 million 5-year-old or older used cars sold by their original owners between Jan. 1, 2014 and Dec. 31, 2018. Models which were owned for less than 5 years were excluded from the analysis, to eliminate the effect of short lease terms on the data. Models that were in production for less than 9 of the 10 most recent model years (2010 to 2019), heavy-duty trucks and vans, and models no longer in production as of the 2019 or 2020 model years were also removed from further analysis. The average age of each vehicle, defined as nameplate + bodystyle, was mathematically modeled using the ages of cars when they were first listed for sale” (Blackley n.d.). In contrast, Argonne National Laboratories (Burnham, et al. 2021, 116) state that the typical period of initial ownership is “approximately 5 years” without citation.

<sup>81</sup> According to S&P Global, the average age of vehicles on U.S. roadways is approximately 12 years (S&P Global Mobility 2022). Argonne National Laboratory “analyzed survivability rates from data published by the National Highway Traffic Safety Administration (NHTSA) of the U.S. Department of Transportation (Lu 2006) and by the EPA (EPA 2016), finding the average lifetime of a vehicle in the United States was approximately 14 years in 2006 and just under 16 years in 2016” (Burnham, et al. 2021, 24).

<sup>82</sup> Argonne National Laboratory provides a comprehensive and recent summary of total cost of ownership (TCO) of vehicles, which includes a review of other TCO studies (Burnham, et al. 2021). Total costs of ownership analyses typically aim to provide a full accounting of ownership costs rather than fitting the criteria specified here.



pocket expenses that might occur for future vehicle buyers considering a new vehicle purchase under the final standards.

The expenses and savings included in the subsequent tables are listed below:

- Purchase Price – EPA OMEGA modeled average retail price. OMEGA first estimates the cost to the manufacturer to produce a given vehicle. Then, the model performs an iterative search where the Producer offers different combinations of ICEV and BEV shares and levels of cross-subsidization between BEV and ICE vehicles until the Consumer and Producer are in agreement for vehicle shares and price. The resulting prices are defined by the sum of the marked-up vehicle production costs and any internal cross-subsidies applied by the model. This resulting price, representing a retail price, is used to compute the sales-weighted average that appears in the table. See RIA Chapter 2.5 for our cost methodology and RIA 2.6 for a description of producer incentives. Regarding costs and producer incentives, we discuss the relationship between incentives, cross subsidies, and purchase price in RIA 2.6.4.5.<sup>83</sup>
- Average Sales Tax - EPA OMEGA estimated national average sales tax of 5 percent (Rearick 2023).

Federal Purchase Incentive – The maximum potential consumer purchase incentive provided via the Inflation Reduction Act is \$7,500. The actual purchase incentive any given consumer might receive is based on several eligibility requirements for the consumer and the actual vehicle. We included estimates of the average consumer purchase incentives as well, consistent with the values applied within OMEGA as presented in RIA Chapter 2.6.8. As with producer incentives, we assume consumers receive the full purchase incentive for which they are eligible. Note that the purchase incentive is a savings for consumers and appears as a negative value in Table 4-7 and Table 4-9 and serves to reduce consumer costs relative to the purchase price discussed above.<sup>84</sup>

- Vehicle Miles – EPA OMEGA estimated national average annual per vehicle miles traveled. See RIA Chapter 4.2.1 and 8.3.
- Retail Fuel – EPA OMEGA estimated national average annual per vehicle fuel expense. See RIA Chapters 2.6.6, 4.3.3, and 8.5.

---

<sup>83</sup> Though partial pass through of costs and producer subsidies is possible, the net result of assuming partial pass-through and the net result of assuming full pass-through could be quite similar. Thus, in the absence of clear consensus in the scientific literature quantifying individual and net effects of partial pass through, the assumption of full pass-through for technology costs and for savings associated with producer subsidies to be reasonable.

<sup>84</sup> For new LD vehicles, the maximum potential Federal purchase incentive of \$7,500 is available on cars priced up to \$55,000 and on vans, SUVs, and pickups up to \$80,000 depending on the buyer's income. For used vehicles, the maximum potential Federal purchase incentive of \$4,000 is available on vehicles priced up to \$25,000 depending on the buyer's income.

- Refueling Time – EPA OMEGA estimated and monetized national average annual per vehicle refueling time. See Chapter 4.3.5 below for procedure for estimating and monetizing refueling time.
- Maintenance – EPA OMEGA estimated national average annual maintenance expenses. See RIA Chapter 4.3.7.
- Repair – EPA OMEGA estimated national average annual repair expenses. See RIA Chapter 4.3.7.
- Registration – National average annual vehicle registration fee according to Burnham, Gohkle, et al. (2021) is \$68 for ICE vehicles. The national average fee is \$141 for PEVs, which includes the additional fee (e.g., excise) charged in some locations for PEVs.
- Insurance - EPA OMEGA estimated national average annual insurance expenses. See RIA Chapter 4.3.6.
- Residential Charging Equipment & Installation – National estimated range of expenses associated with home charging equipment and installation. In Chapter 5.3 of the RIA, we provide a description and summary of charging infrastructure investments, including home charging.

Before we proceed, we note several updates to our analysis of consumer savings and expenses completed for the FRM, in consideration of public comments and based on the best available information in the record. Specifically, EPA has added a summary of the 24-year lifetime expenses and savings for sales-weighted average MY 2032 vehicles, under the final standards compared to MY 2026 standards, by body style. Table 4-7 and Table 4-8 summarize projected average consumer expenses and savings associated with the final standards. This information is in addition to Table 4-9 and Table 4-10, which compare savings and expenses under the standards, across vehicle technologies, and by body style for the first eight years of vehicle life (the average span of ownership for a new vehicle). These later two tables appeared in the NPRM and have been updated for the FRM.

EPA has revised estimates of each line item as a result of updates to our modeling, in consideration of public comments and based on the best available data in the public record. Specifically, EPA added PHEVs, revised manufacturing costs and purchase price (See RIA Chapter 2.5), revised estimates of refueling time (See RIA Chapter 4.3.5), and revised estimates of rebound driving (See RIA Chapter 8.3.3). In addition, EPA added estimated average sales taxes at a national average of 5 percent (Rearick 2023) and insurance estimates (See Chapter 4.3.6). EPA shows both the average estimated purchase incentive (See RIA Chapter 2.5.2.1.4 and RIA Chapter 2.6.8) along with stating the maximum purchase incentive. Furthermore, EPA updated the range of optional costs associated with the installation of home charging (See RIA Chapter 5). Finally, EPA updated dollar values to 2022 dollars. We also note that the savings and expenses summaries show registration expenses that include additional fees for PEVs (e.g., excise taxes).

Relatedly, we emphasize that EPA assumes full pass through of manufacturing costs and of production tax credits. Manufacturers may choose to cross-subsidize vehicles. However, because our modeling maintains manufacturing costs across all vehicles within a policy scenario, we effectively assume full cost pass through when averaged over all vehicles. We arrive at the assumption of full pass through by not assuming partial pass through at any point in our modeling. Vehicle prices are defined by the sum of the marked-up vehicle production costs and internal cross-subsidies applied by the model (See RIA Chapter 2.5 and below in RIA Chapter 4.2.2). The 45X Advanced Manufacturing Production Tax Credit is treated within the modeling as a reduction in direct manufacturing costs, which in turn is assumed to result in a reduction in purchase price for the consumer after the application of the Retail Price Equivalent (RPE) factor (See RIA Chapter 2.5.2.1.4 and RIA Chapter 2.6.8). We have conceptualized the purchase incentive as a combination of 30D and 45W Clean Vehicle Credits. The resulting purchase incentive is assumed to be realized entirely by the consumer and does not impact the producer generalized cost value or the manufacturing cost (See RIA Chapter 2.6.8) or the purchase price.

#### **4.2.2.1 Vehicle Lifetime Savings and Expenses Under the Standards Compared to the MY2026 Standard**

We now compare consumer savings and expenses under the no action case and under final standards for the 24-year lifetime of sales-weighted average model year 2032 vehicles below. In Table 4-7 expenses are positive values and savings are negative (i.e., in parentheses). Note also that the maximum potential Federal Purchase incentive of \$7,500 is not shown. The sales-weighted average purchase incentive for all vehicles (PEV and ICE vehicles) is given instead (consistent with the values applied in the OMEGA model as presented in RIA Chapter 2.6.8) and is higher under the final standards than under to the MY 2026 standards due to the greater number of PEVs purchased under the final standards in the central case.

**Table 4-7: National per vehicle ownership (savings) and expenses for new model year 2032 light-duty vehicles under the No Action case and the Final Standards (2022 dollars)**

|  | Sedan/Wagon |            | CUV/SUV    |            | Pickup     |            | All Body Styles |            |
|--|-------------|------------|------------|------------|------------|------------|-----------------|------------|
|  | No Action   | Final      | No Action  | Final      | No Action  | Final      | No Action       | Final      |
| <b>Upfront Purchase Related Expenses</b>                               |             |            |            |            |            |            |                 |            |
| Purchase Price <sup>a</sup><br>(2022\$)                                | 38,100      | 38,900     | 44,400     | 46,900     | 54,000     | 55,600     | 44,900          | 47,000     |
| Average Sales Tax <sup>a</sup><br>(2022\$)                             | 1,900       | 2,000      | 2,200      | 2,400      | 2,700      | 2,800      | 2,300           | 2,400      |
| Average Federal Purchase Incentive <sup>a</sup><br>(2022\$)            | (3,300)     | (4,500)    | (2,700)    | (4,000)    | (2,700)    | (4,000)    | (2,800)         | (4,100)    |
| Net Purchase Price<br>(2022\$)   | 36,700      | 36,400     | 43,900     | 45,300     | 54,000     | 54,400     | 44,400          | 45,300     |
| <b>Twenty-four Year Average Annual Expenses</b>                        |             |            |            |            |            |            |                 |            |
| Vehicle Miles <sup>a</sup><br>(miles/year)                             | 13,500      | 13,700     | 14,000     | 14,200     | 14,500     | 14,700     | 14,000          | 14,200     |
| Retail Fuel <sup>a</sup><br>(2022\$/year)                              | 810         | 660        | 1,250      | 1,010      | 1,580      | 1,330      | 1,230           | 1,010      |
| Refueling Time <sup>a</sup><br>(2022\$/year)                           | 40          | 40         | 60         | 60         | 60         | 50         | 60              | 50         |
| Maintenance <sup>a</sup><br>(2022\$/year)                              | 1,120       | 1,050      | 1,280      | 1,210      | 1,390      | 1,310      | 1,270           | 1,200      |
| Repair <sup>a</sup><br>(2022\$/year)                                   | 640         | 620        | 740        | 730        | 690        | 670        | 710             | 700        |
| Registration <sup>b</sup><br>(2022\$/year)                             | 120         | 140        | 110        | 130        | 110        | 130        | 120             | 130        |
| Insurance <sup>a</sup><br>(2022\$/year)                                | 490         | 500        | 450        | 460        | 460        | 470        | 460             | 470        |
| Total Average Annual Expenses<br>(2022\$/year)                         | 3,220       | 3,010      | 3,890      | 3,600      | 4,290      | 3,960      | 3,850           | 3,560      |
| <b>Optional One-Time Investment</b>                                    |             |            |            |            |            |            |                 |            |
| Residential Charging Equipment & Installation <sup>c</sup><br>(2022\$) | 0 to 5,620  | 0 to 5,620 | 0 to 5,620 | 0 to 5,620 | 0 to 5,620 | 0 to 5,620 | 0 to 5,620      | 0 to 5,620 |

a Per OMEGA.

b Per Burnham, Gohlke, et al. (2021) adjusted from 2019\$ to 2022\$.

c See RIA Chapter 5

We summarize estimated savings associated with the final standards for the 24-year lifetime of sales-weighted average model year 2032 vehicles in Table 4-8. We do not include vehicle taxes due to the relatively small differences. In Table 4-8, savings are positive; costs are negative (i.e., in parentheses). Note that under the final standards, more PEVs are purchased, so the average Federal Purchase Incentive received by consumers is larger across all vehicles.

**Table 4-8: Summary of estimated average savings over the 24-year lifetime of light-duty vehicles under the Final Standards compared to vehicles meeting the MY 2026 standards (2022 dollars)**

|  | <b>Sedan/<br/>Wagon</b> | <b>CUV/SUV</b> | <b>Pickup</b> | <b>All Body<br/>Styles</b> |
|--|-------------------------|----------------|---------------|----------------------------|
| Additional Purchase Price Expense  | (900)                   | (2,600)        | (1,700)       | (2,100)                    |
| Twenty-four Year Operating Savings   | 5,300                   | 7,000          | 7,800         | 6,800                      |
| Additional Average Federal Purchase Incentive  | 1,100                   | 1,300          | 1,300         | 1,300                      |
| Maximum Residential Charging Expense   | (5,600)                 | (5,600)        | (5,600)       | (5,600)                    |
| Total Savings with No Purchase Incentive and No Residential Charging Expense   | 4,400                   | 4,400          | 6,100         | 4,700                      |
| Total Savings with Average Federal Purchase Incentive and No Residential Charging Expense                            | 5,500                   | 5,700          | 7,400         | 6,000                      |
| Total Savings with Maximum Federal Purchase Incentive and No Residential Charging Expense                            | 11,900                  | 11,900         | 13,600        | 12,200                     |
| Total Savings or Additional Expense with No Purchase Incentive and with Maximum Residential Charging Expense         | (1,200)                 | (1,200)        | 500           | (900)                      |
| Total Savings or Additional Expense with Maximum Federal Purchase Incentive and Maximum Residential Charging Expense | (100)                   | 100            | 1,800         | 400                        |
| Total Savings with Average Federal Purchase Incentive and Maximum Residential Charging Expense                       | 6,300                   | 6,300          | 8,000         | 6,600                      |

In Table 4-8, we observe that estimated savings over the lifetime of the vehicle are substantial regardless of the size of purchase incentives. Excluding purchase incentives and optional residential charging expenses, the standards will save an average consumer \$4,700 over the lifetime of a light-duty vehicle, as compared to a vehicle meeting the MY 2026 standards. Taking into account the estimated fleet-wide average purchase incentives, the final standards yield average savings of \$6,000 over the lifetime of the vehicle and compared to the MY 2026 standards.

#### **4.2.2.2 Eight Year Savings and Expenses Under the Final Standards for PEVs and ICE Vehicles**

Given the projected increase in PEV market share, we narrow our focus to projected expenses and savings associated with PEVs. Table 4-9 provides a summary of estimated consumer expenses and savings experienced by individual new vehicle owners of BEVs, PHEVs and ICEVs for three body styles – sedans and wagons, CUVs and SUVs, and pickups. Expenses are positive values and savings are negative (i.e., in parentheses). Note also that the maximum potential Federal Purchase incentive of \$7,500 is not shown. As above, we provide OMEGA estimated national, sales-weighted average expenses associated with new model year 2032 vehicles. For recurring expenses, we present sales-weighted average annual, undiscounted amounts. EPA estimated dollar amounts are given in 2022 dollars (2022\$) with no discounting. Other dollar amounts are consistent with original sources and noted.

**Table 4-9: National per vehicle ownership expenses for new model year 2032 light-duty vehicles under the Final Standards (2022 dollars).**

|  | Sedan/Wagon       |                             |                    | CUV/SUV           |                             |                    | Pickup            |                             |                    |
|--|-------------------|-----------------------------|--------------------|-------------------|-----------------------------|--------------------|-------------------|-----------------------------|--------------------|
|  | BEV<br>(Electric) | PHEV<br>(Plug-in<br>Hybrid) | ICEV<br>(Gasoline) | BEV<br>(Electric) | PHEV<br>(Plug-in<br>Hybrid) | ICEV<br>(Gasoline) | BEV<br>(Electric) | PHEV<br>(Plug-in<br>Hybrid) | ICEV<br>(Gasoline) |
| <b>Upfront Purchase Related Expenses and (Savings)</b>                 |                   |                             |                    |                   |                             |                    |                   |                             |                    |
| Purchase Price <sup>a</sup><br>(2022\$)                                | 40,300            | 44,700                      | 33,400             | 50,300            | 49,900                      | 40,400             | 58,300            | 59,000                      | 49,800             |
| Average Sales Tax <sup>a</sup><br>(2022\$)                             | 2,000             | 2,200                       | 1,700              | 2,500             | 2,500                       | 2,000              | 2,900             | 3,000                       | 2,500              |
| Average Federal Purchase Incentive <sup>a</sup><br>(2022\$)            | (6,000)           | (6,000)                     | -                  | (6,000)           | (6,000)                     | -                  | (6,000)           | (6,000)                     | -                  |
| Net Purchase Price<br>(2022\$)   | 36,300            | 40,900                      | 35,100             | 46,800            | 46,400                      | 42,400             | 55,200            | 56,000                      | 52,300             |
| <b>Eight Year Average Annual Expenses</b>                              |                   |                             |                    |                   |                             |                    |                   |                             |                    |
| Vehicle Miles <sup>a</sup><br>(miles/year)                             | 15,400            | 15,600                      | 15,400             | 16,000            | 16,400                      | 16,000             | 17,400            | 17,600                      | 17,400             |
| Retail Fuel <sup>a</sup><br>(2022\$/year)                              | 450               | 1,230                       | 1,340              | 600               | 1,470                       | 1,860              | 840               | 2,200                       | 2,530              |
| Refueling Time <sup>a</sup><br>(2022\$/year)                           | 40                | 20                          | 60                 | 60                | 30                          | 80                 | 50                | 40                          | 80                 |
| Maintenance <sup>a</sup><br>(2022\$/year)                              | 530               | 770                         | 820                | 570               | 850                         | 880                | 670               | 990                         | 1,050              |
| Repair <sup>a</sup><br>(2022\$/year)                                   | 280               | 370                         | 360                | 340               | 420                         | 390                | 320               | 390                         | 360                |
| Registration <sup>b</sup><br>(2022\$/year)                             | 160               | 160                         | 80                 | 160               | 160                         | 80                 | 160               | 160                         | 80                 |
| Insurance <sup>a</sup><br>(2022\$/year)                                | 620               | 650                         | 560                | 550               | 540                         | 500                | 590               | 600                         | 550                |
| Total Average Annual Expenses<br>(2022\$/year)                         | 2,080             | 3,200                       | 3,220              | 2,280             | 3,470                       | 3,790              | 2,630             | 4,380                       | 4,650              |
| <b>Optional One-Time Investment</b>                                    |                   |                             |                    |                   |                             |                    |                   |                             |                    |
| Residential Charging Equipment & Installation <sup>c</sup><br>(2022\$) | 0 to 5,620        | 0 to 5,620                  | NA                 | 0 to 5,620        | 0 to 5,620                  | NA                 | 0 to 5,620        | 0 to 5,620                  | NA                 |

a Per OMEGA.

b Per Burnham, Gohlke, et al. (2021) adjusted from 2019\$ to 2022\$.

c Per RIA Chapter 5

In the above table, when comparing new BEVs, PHEVs, and ICE vehicles within body style, we make three general observations. First, on average, BEV owners spend less than half of what PHEV and ICE vehicle owners spend on fuel, even after accounting for refueling time. Second, BEV owners also save on maintenance and repair. For all operating expenses, BEV owners, when compared to PHEV and ICE vehicle owners, save \$1,100 per year for sedans and wagons, \$1,200 to \$1,500 per year for CUVs and SUVs, and \$1,700 to \$2,000 per year for pickups. In the above table we also show a range of investments into residential charging equipment and installation. Importantly, home charging is not required for PEV ownership, and charging at home is feasible via a standard 120 volt outlet (aka Level 1 which delivers 2 to 5 miles of range per hour) or 240 volt outlet (Level 2 which delivers 10 to 20 or more miles of range per hour) (Borlaug, et al. 2020) citing (U.S. Department of Energy (DOE) 2020)). In some cases,

additional equipment or upgrades for vehicle charging may not be needed.<sup>85</sup> Charging at home does deliver convenience. It very likely reduces time spent actively charging, as well as the time-associated expense, since charging occurs when the vehicle is parked. In fact, Level 2 charging at home has been shown to be associated with PEV continuance, that is, purchasing a PEV after relinquishing a previous PEV (Hardman and Tal 2021). When electrical upgrades are desired, home charging equipment and installation costs differ from one household to the next based primarily on housing type (e.g., detached, attached, apartment) and type of upgrade required (e.g., none, outlet upgrade, charger upgrade). Thus, the table provides a range as described in Chapter 5 of this RIA.

Focusing on PEVs compared to ICE vehicles, we summarize the savings that consumers who purchase a new MY 2032 LD BEV or PHEV instead of an ICE vehicle can experience over the first 8 years of vehicle life. See

Table 4-10. On average, PEV consumers can save more than \$9,000 in the first 8 years of PEV ownership compared to an ICE vehicle.<sup>86</sup> Those are substantial savings and would be experienced by a PEV owner whether or not they considered those savings at the time of purchase.

**Table 4-10: Summary of estimated average savings over the first 8 years of light-duty vehicle life when MY 2032 PEV purchased instead of ICE vehicle (2022 dollars).**

|  | Sedan/<br>Wagon | CUV/SUV | Pickup  | All<br>Bodystyles |
|--|-----------------|---------|---------|-------------------|
| Additional Purchase Price Expense  | (7,400)         | (9,900) | (8,700) | (8,700)           |
| Eight Year Operating Savings   | 8,100           | 10,200  | 13,300  | 10,600            |
| Additional Average Estimated Federal Purchase Incentive Savings                                | 6,000           | 6,000   | 6,000   | 6,000             |
| Maximum Residential Charging Expense   | (5,600)         | (5,600) | (5,600) | (5,600)           |
| Total Savings No Purchase Incentive and No Residential Charging Expense                        | 700             | 300     | 4,600   | 1,900             |
| Total Savings with Average Federal Purchase Incentive and No Residential Charging Expense      | 6,700           | 6,300   | 10,600  | 7,900             |
| Total Savings with Maximum Federal Purchase Incentive and No Residential Charging Expense      | 8,200           | 7,800   | 12,100  | 9,400             |
| Total Savings No Purchase Incentive and with Maximum Residential Charging Expense              | (4,900)         | (5,300) | (1,000) | (3,700)           |
| Total Savings Average Federal Purchase Incentive and with Maximum Residential Charging Expense | 1,100           | 700     | 5,000   | 2,300             |
| Total Savings with Maximum Federal Purchase Incentive and Maximum Residential Charging Expense | 2,600           | 2,200   | 6,500   | 3,800             |

<sup>85</sup> The ability to charge at home with at most behavior modification (i.e., electrical access with [at most] behavior modification) varies among individual households with patterns emerging among housing types and between owners and renters. The National Renewable Energy Laboratory (NREL) estimates home charging is currently feasible without any upgrades (i.e., no cost) for 28 to 72% of single dwelling structures (i.e., attached and detached single family and mobile homes) and for 11 – 40% of multiple dwelling structures (i.e., apartments) (Ge, et al. 2021).

<sup>86</sup> This estimate includes the maximum PEV purchase incentive and excludes optional investments in residential charging.

In concluding this summary of consumer savings and expenses for new MY2032, we again note that this is not a total costs of ownership analysis. It also is not meant to reflect the incremental costs of the standards, nor is it meant to reflect the Benefit Cost Analysis or net benefits of the rule. According to the criteria that we specified above, we have excluded expenses that consumers customarily incur that may be included in some total cost of ownership analysis. For example, we acknowledge but exclude costs associated with financing. While many buyers finance, loan principle, interest rate, and loan period differ substantially across individuals. We also exclude regional-, state- and local-level monetary purchase incentives as well as other regional-, state- and local-level monetary and non-monetary, “perks”/policies associated with PEV ownership. Regional-, state-, and local-level incentives and policies take many forms across the U.S., differing in source (e.g., governments, utilities), amount, and eligibility (Wakefield 2023) (Bui, Slowik and Lutsey 2020) (Greschak, Kreider and Legault 2022), and some may not persist into the timeframe represented in the above.

### **4.2.3 Other Ownership Considerations**

In addition to ownership savings and expenses experienced under the final standards, provided above in Chapter 4.2.2, and impacts of the final standards on consumers quantified in benefit-cost analysis, shown below in Chapter 4.3 and in Chapter 9, we also consider the effects of the final standards on low-income households and on consumers of low-priced new vehicles and used vehicles. These effects depend, in large part, on countervailing elements of vehicle ownership experience under the standards, namely a) higher up front, net purchase prices,<sup>87</sup> b) net fuel savings,<sup>88</sup> and c) maintenance and repair. The net effect varies across households and as demonstrated above across vehicle types. However, net fuel savings may be especially relevant for low-income households and consumers in the used and low-priced new vehicle markets. First, fuel, maintenance, and repair expenditures are a larger portion of expenses for low-income households compared to higher income households (Hardman, Fleming, et al. 2021).<sup>89</sup> Second, lower-priced new vehicles have historically been more fuel efficient. Third, fuel economy, and therefore fuel savings, do not decline as vehicles age even though the price paid for vehicles typically declines as vehicles age and are resold. Fourth, low-income households are more likely to purchase lower-priced new vehicles and used vehicles (Hutchens, et al. 2021).

Additionally, PEV purchase incentives are available for new and used vehicles. For new vehicles, the maximum Federal purchase incentive of \$7,500 is available on cars priced up to \$55,000 and on vans, SUVs, and pickups up to \$80,000 depending on the buyer’s income. For used vehicles, the maximum Federal purchase incentive of \$4,000 is available on PEVs priced up to \$25,000 depending on buyer’s income. Lower priced new vehicles and many used vehicles meet the criteria for the maximum incentive and low-income buyers are more likely, by definition, to qualify for maximum incentives. Furthermore, we discussed in Chapter 4.2.2 above and demonstrate in Chapter 4.3 below (See also RIA Chapter 10.2.3.1), BEV maintenance and

---

<sup>87</sup> Per vehicle compliance costs are \$1,400 including IRA producer incentives (See Chapter 12).

<sup>88</sup> By net fuel savings, we are referring to fuel costs and time spent refueling.

<sup>89</sup> In the U.S., according to (Hardman, Fleming, et al. 2021), the lowest income households spend 11.2 percent of their annual income on fuel, maintenance, and repairs of vehicles compared to all other households that spend 4.5 percent of their annual income on these expenses.



repair costs are lower. For lower income buyers, lower priced vehicle buyers, and used vehicle buyers, BEVs' lower maintenance and repair costs may be especially compelling.

Furthermore, most vehicle consumers finance, making access to credit for vehicle purchases essential. The ability to finance may be of particular concern for low-income households. As above, the effects of the standards on access to credit is influenced by the potentially countervailing forces of vehicle purchase and other ownership costs. However, the degree of influence and the net effect is not clear (See Chapter 8.4 of the 2021 rule). Increased purchase price and presumably higher loan principal may, in some cases, discourage lending, while reduced fuel costs may, in some cases, improve lenders' perceptions of borrowers' repayment reliability.

Finally, while access to conventional fuels can be assumed for the most part, the number and density of charging stations varies considerably (U.S. Department of Energy 2022). The expansion of public and private charging infrastructure has been keeping up with PEV adoption and is generally expected to continue to grow, particularly in light of very large public and private investments (See RIA Chapter 5) and local level priorities (Bui, Slowik and Lutsey 2020) (Greschak, Kreider and Legault 2022). This includes home charging events, which are likely to continue to grow with PEV adoption but are also expected to represent a declining proportion of charging events as PEV share increases (Ge, et al. 2021). Thus, publicly accessible charging is an important consideration, especially among renters and residents of multi-family dwellings and others who charge away from home (Consumer Reports 2022). Households without access to charging at home or the workplace will likely incur additional charging costs. Thus, among consumers who rely upon public charging, the higher price of public charging is especially important. See Chapter 5 of this RIA for a more detailed discussion of public and private investments in charging infrastructure, and our assessment of infrastructure needs and costs under this rule. See also Chapter 4.2.2 for information on home charging equipment and installation costs as well as Chapter 10.2.3.1 for a discussion of charging and home charging installation for low-income households.

Commenters asserted that PEVs will not satisfy every consumer and urged EPA to “consider the needs of consumers in all demographics and income levels.”<sup>90</sup> More specifically, commenters often note the challenges associated with PEV adoption for specific use cases (e.g., towing, hauling, long distance driving, and cold weather driving) and certain groups of consumers (e.g., rural households, low-income populations, and used vehicle consumers). First, EPA agrees that consumers are heterogeneous, PEV acceptance will occur at different rates for different consumers, and consumers will choose to satisfy their needs and preferences with PEVs and ICE vehicles. These differences among consumers are reflected in our modeling. Based on the evidence, we capture consumer heterogeneity in our modeling in aggregate and on average via logit and shareweight parameters. We also note that we demonstrate several compliance pathways. Second, PEV ownership is feasible and acceptable to some consumers for towing, hauling, long distance driving, and cold weather driving (e.g., (C. Forsythe, K. Gillingham, et al., Will pickup truck owners go electric? 2023a)). Many consumer groups, including lower income buyers and non-white consumers, purchase PEVs and indicate interest in PEVs.<sup>91</sup> Third, we

---

<sup>90</sup> Consumer Reports comment, EPA-HQ-OAR-2022-0829-0728, pp. 10-14.

<sup>91</sup> Consumer Reports comment, EPA-HQ-OAR-2022-0829-0728, pp. 10-14.

expect that PEVs will generate large savings for consumers over the lifetime of the vehicle, whether purchased new or used. We also see a significant trend toward decreasing consumer upfront costs for purchasing PEVs as we discuss elsewhere (e.g., See Preamble Sections IV.C.1 and IV.C.6). Lastly, our assessment projects that there will be variation in the types of technologies that automakers adopt to meet the standards, providing consumers increased fuel economy and associated fuel savings via PEV and ICE vehicle technologies in the new vehicle market and eventually also in the used vehicle market. We expect that automakers recognize the diversity of their consumers and will leverage the flexibilities built into the standards to provide consumers with PEV and ICE vehicle choices over a wide range of utility and price points.

### 4.3 Consumer-Related Benefits and Costs

#### 4.3.1 Vehicle Technology Cost Impacts

Table 4-11 shows the estimated annual vehicle technology costs of the final standards and each alternative, estimated in OMEGA, for the indicated calendar years (CY). The table also shows the present-values (PV) of those costs and the equivalent annualized values (AV) for the calendar years 2027–2055 using 2, 3 and 7 percent discount rates.<sup>92</sup>

**Table 4-11: Vehicle technology costs (billions of 2022 dollars)\*.**

| Calendar Year  | Final | Alternative A | Alternative B |
|--|-------|---------------|---------------|
| 2027   | \$2.6 | \$16          | \$2.3         |
| 2028   | \$7.3 | \$25          | \$5.9         |
| 2029   | \$16  | \$32          | \$15          |
| 2030   | \$23  | \$36          | \$21          |
| 2031   | \$29  | \$35          | \$24          |
| 2032   | \$30  | \$33          | \$27          |
| 2035   | \$55  | \$54          | \$42          |
| 2040   | \$50  | \$49          | \$40          |
| 2045   | \$46  | \$45          | \$39          |
| 2050   | \$42  | \$43          | \$35          |
| 2055   | \$38  | \$39          | \$30          |
| PV2  | \$870 | \$940         | \$710         |
| PV3  | \$760 | \$820         | \$610         |
| PV7  | \$450 | \$510         | \$360         |
| AV2  | \$40  | \$43          | \$32          |
| AV3  | \$39  | \$43          | \$32          |
| AV7  | \$37  | \$41          | \$30          |
| * Costs exclude consideration of IRA battery tax credits (IRS 45X) and IRA purchase tax credits (IRS 30D and 45W). |       |               |               |

---

<sup>92</sup> For the estimation of the stream of costs and benefits, we assume that after implementation of the MY 2027 and later standards, the MY 2032 standards apply to each year thereafter.

We expect the technology costs of the program will result in a rise in the average purchase prices for consumers, for both new and used vehicles. While we expect that vehicle manufacturers will strategically price vehicles (e.g., subsidizing a lower price for some vehicles with a higher price for others), we assume in our modeling that increased vehicle technology costs will be fully reflected in higher average purchase prices paid by consumers. Note that these technology cost increases are offset by fuel, maintenance, and repair costs, discussed in Chapter 4.3.4 and Chapter 4.3.7.

### **4.3.2 Value of Rebound Driving**

We present the estimated rebound miles driven in Chapter 8.3.4 of this RIA. Here we discuss the benefits associated with that rebound driving. Those benefits associated with the final standards and each alternative are shown in Table 4-12

Table 4-12.

**Table 4-12 Drive value benefits of rebound driving  
(billions of 2022 dollars) \***

| Calendar Year | Final   | Alternative A | Alternative B |
|---------------|---------|---------------|---------------|
| 2027          | \$0.002 | \$0.0052      | \$0.0024      |
| 2028          | \$0.042 | \$0.11        | \$0.043       |
| 2029          | \$0.081 | \$0.21        | \$0.082       |
| 2030          | \$0.12  | \$0.32        | \$0.14        |
| 2031          | \$0.16  | \$0.42        | \$0.19        |
| 2032          | \$0.2   | \$0.5         | \$0.22        |
| 2035          | \$1     | \$1.3         | \$0.87        |
| 2040          | \$2.3   | \$2.5         | \$2           |
| 2045          | \$3.3   | \$3.4         | \$3           |
| 2050          | \$4.2   | \$4.2         | \$3.8         |
| 2055          | \$4.7   | \$4.7         | \$4.3         |
| PV2           | \$46    | \$49          | \$41          |
| PV3           | \$38    | \$41          | \$34          |
| PV7           | \$18    | \$20          | \$17          |
| AV2           | \$2.1   | \$2.2         | \$1.9         |
| AV3           | \$2     | \$2.1         | \$1.8         |
| AV7           | \$1.5   | \$1.7         | \$1.3         |

\* Positive values reflect benefits; negative values reflect disbenefits.

As discussed above, the assumed rebound effect might occur when an increase in vehicle fuel efficiency leads people to choose to drive more because of the lower cost per mile of driving. When we estimate fuel expenditures, we multiply the number of miles driven on a given fuel by its price per unit, i.e., dollars per gallon for liquid fuels and dollars per kWh for electricity. Therefore, any reductions in fuel expenditures (fuel savings) associated with a policy include additional fuel expenditures associated with rebound driving. If we ignored those rebound miles, the fuel savings would be calculated using the same number of miles in both the policy and no-action cases but with a lower fuel cost per mile in the policy case.

However, drivers would drive those additional rebound miles only if they find value in them. The increase in travel associated with the rebound effect produces additional benefits to vehicle drivers, which reflect the value of the added social and economic opportunities that become accessible with additional travel. This analysis estimates the economic benefits from increased rebound-effect driving as the sum of the fuel costs paid to drive those miles and the drive surplus, which is the additional value that drivers derive from those miles.

The value of the rebound miles driven is simply the number of rebound miles multiplied by the cost per mile of driving them.

$$\text{Value of Rebound VMT} = VMT_{\text{rebound}} \times \left( \frac{\$}{\text{mile}} \right)_{\text{action}}$$

The economic value of the increased owner/operator surplus provided by added driving, the drive surplus, is estimated as one half of the product of the decline in vehicle operating costs per vehicle-mile and the resulting increase in the annual number of miles driven.

$$\text{DriveSurplus} = \frac{VMT_{\text{rebound}} \times \left[ \left( \frac{\$}{\text{mile}} \right)_{\text{NoAction}} - \left( \frac{\$}{\text{mile}} \right)_{\text{Action}} \right]}{2}$$

Thus, the economic benefits from increased rebound driving, called Drive Value, is then calculated as below.

$$\text{DriveValue} = \text{Value of Rebound VMT} + \text{DriveSurplus}$$

Drive value depends on the extent of improvement in fuel consumption and fuel prices, which depend upon vehicle model year, the calendar year, and the standards being analyzed. Thus, the value of benefits from increased vehicle use also depends upon model year and calendar year, and it varies among alternative standards.

### **4.3.3 Fuel Consumption**

Overall, the Final Standards are projected to reduce liquid fuel consumption while simultaneously increasing electricity consumption as shown in Table 4-13 and

Table 4-14, respectively. These values are generated in OMEGA and used in the benefit cost analysis described in RIA Chapter 9.

**Table 4-13: Liquid-fuel consumption impacts (billion gallons)**

| Calendar Year | Liquid-Fuel Impacts, Final | Liquid-Fuel Impacts, Alternative A | Liquid-Fuel Impacts, Alternative B |
|---------------|----------------------------|------------------------------------|------------------------------------|
| 2027          | -0.07                      | -0.78                              | -0.052                             |
| 2028          | -0.48                      | -2.1                               | -0.4                               |
| 2029          | -1.5                       | -3.9                               | -1.4                               |
| 2030          | -3.                        | -6.                                | -2.8                               |
| 2031          | -5.                        | -8.3                               | -4.5                               |
| 2032          | -7.2                       | -11                                | -6.6                               |
| 2035          | -17                        | -20                                | -15                                |
| 2040          | -30                        | -32                                | -25                                |
| 2045          | -39                        | -40                                | -32                                |
| 2050          | -43                        | -43                                | -36                                |
| 2055          | -43                        | -44                                | -36                                |
| sum           | -780                       | -830                               | -660                               |

**Table 4-14 Electricity consumption impacts (terawatt hours)**

| Calendar Year | Electricity Impacts, Final | Electricity Impacts, Alternative A | Electricity Impacts, Alternative B |
|---------------|----------------------------|------------------------------------|------------------------------------|
| 2027          | 0.94                       | 6.9                                | 0.79                               |
| 2028          | 4.1                        | 18                                 | 3.1                                |
| 2029          | 13                         | 34                                 | 11                                 |
| 2030          | 27                         | 52                                 | 23                                 |
| 2031          | 47                         | 72                                 | 39                                 |
| 2032          | 67                         | 92                                 | 58                                 |
| 2035          | 150                        | 170                                | 130                                |
| 2040          | 260                        | 270                                | 200                                |
| 2045          | 330                        | 330                                | 250                                |
| 2050          | 350                        | 360                                | 270                                |
| 2055          | 360                        | 360                                | 270                                |
| sum           | 6,700                      | 7,000                              | 5,200                              |

#### **4.3.4 Monetized Fuel Savings**

Table 4-15 shows the undiscounted annual monetized fuel savings associated with the final rule and each alternative as well as the present value (PV) of those costs and equivalent annualized value (AV) for the calendar years 2027–2055 using 2, 3, and 7 percent discount rates. In Chapter 9, we present pretax fuel savings which are used in the benefit cost analysis. In Chapter 9 we also present transfers, or taxes, associated with fuel expenditure changes and battery and vehicle purchase credit incentives.

**Table 4-15: Retail fuel expenditure savings (billions of 2022 dollars)\***

| Calendar Year  | Retail Fuel Savings, Final | Retail Fuel Savings, Alternative A | Retail Fuel Savings, Alternative B |
|--|----------------------------|------------------------------------|------------------------------------|
| 2027   | \$0.21                     | \$1.7                              | \$0.17                             |
| 2028   | \$1.1                      | \$4.5                              | \$1                                |
| 2029   | \$3.2                      | \$8.3                              | \$3.1                              |
| 2030   | \$6.3                      | \$13                               | \$6.1                              |
| 2031   | \$10                       | \$17                               | \$9.5                              |
| 2032   | \$14                       | \$22                               | \$14                               |
| 2035   | \$35                       | \$42                               | \$31                               |
| 2040   | \$66                       | \$71                               | \$56                               |
| 2045   | \$87                       | \$90                               | \$75                               |
| 2050   | \$100                      | \$110                              | \$91                               |
| 2055   | \$110                      | \$110                              | \$96                               |
| PV2  | \$1,200                    | \$1,300                            | \$1,100                            |
| PV3  | \$1,000                    | \$1,100                            | \$890                              |
| PV7  | \$520                      | \$580                              | \$450                              |
| AV2  | \$57                       | \$61                               | \$49                               |
| AV3  | \$54                       | \$58                               | \$46                               |
| AV7  | \$42                       | \$47                               | \$37                               |
| * Positive values indicate savings in fuel expenditures. |                            |                                    |                                    |

#### **4.3.5 Benefits Associated with the Time Spent Refueling**

More stringent GHG standards have traditionally resulted in lower fuel consumption by liquid fueled vehicles. Provided fuel tanks on liquid fueled vehicles retain their capacity (i.e., gas tanks don't change volume), the lower fuel consumption would be expected to reduce the frequency of refueling events. However, if manufacturers choose to maintain traditional range (i.e., miles traveled on a full tank of fuel), then the possibility exists that tank capacities would become smaller and, therefore, the frequency of refueling events would not change, although time spent at the fuel pump may be reduced. There are indications that both outcomes are happening, with some vehicles reducing tank sizes while others are maintaining them.

Of course, electric vehicles are not fueled in the same way. Many refueling events for electric vehicles would be expected to occur either overnight where the vehicle is parked or during the workday using an employer owned charge point, neither of which require extra time from the driver, especially compared to refueling a liquid fueled vehicle. Similarly, drivers may opt to use public charging while shopping or at other places they regularly spend time. However, some charging events will undoubtedly require drivers to take extra time to charge, especially when drivers are in the midst of an extended road trip. These mid-trip charging events are the focus of this analysis. For purposes of this analysis, we have made the simplifying assumption that PHEVs will not make use of mid-trip charging since the vehicle can continue to operate on liquid fuel once the battery is depleted. Table 4-16 presents our estimates of the benefits associated with the time spent refueling.

**Table 4-16: Benefits associated with changes to the time spent refueling (billions of 2022 dollars) \*.**

| Calendar Year | Final    | Alternative A | Alternative B |
|---------------|----------|---------------|---------------|
| 2027          | \$0.0022 | \$0.023       | \$0.0015      |
| 2028          | \$0.026  | \$0.099       | \$0.023       |
| 2029          | -\$0.012 | \$0.11        | -\$0.018      |
| 2030          | -\$0.11  | \$0.039       | -\$0.12       |
| 2031          | -\$0.27  | -\$0.098      | -\$0.29       |
| 2032          | -\$0.47  | -\$0.28       | -\$0.5        |
| 2035          | -\$0.59  | -\$0.43       | -\$0.76       |
| 2040          | -\$0.86  | -\$0.75       | -\$1.2        |
| 2045          | -\$1.1   | -\$1          | -\$1.5        |
| 2050          | -\$1.4   | -\$1.4        | -\$1.8        |
| 2055          | -\$1.7   | -\$1.7        | -\$2.2        |
| PV2           | -\$17    | -\$15         | -\$23         |
| PV3           | -\$15    | -\$13         | -\$19         |
| PV7           | -\$7.5   | -\$6.2        | -\$9.8        |
| AV2           | -\$0.8   | -\$0.7        | -\$1.1        |
| AV3           | -\$0.76  | -\$0.66       | -\$1          |
| AV7           | -\$0.61  | -\$0.5        | -\$0.8        |

\* Negative values reflect disbenefits.

To estimate the refueling costs associated with liquid-fueled vehicles, we have borrowed heavily from the approach used by EPA in the December 2021 GHG final rule (U.S. EPA 2021) (U.S. DOT 2021) with updated inputs used by NHTSA in support of their 2023 CAFE proposed rule (DOT Volpe Center 2023). The refueling costs for liquid-fueled vehicles are calculated on a cost per gallon basis while for BEVs it is calculated on a cost per mile basis. The calculations used are shown in the equation immediately below for liquid-fueled vehicles and in the subsequent equation for BEVs with a discussion following.

$$\frac{Cost}{Gallon} = \frac{1}{Tank\ Size \times Share\ Filled} \times \frac{Fixed\ Time + \frac{Tank\ Size \times Shared\ Filled}{Fill\ Rate}}{60} \times Time\ Value \times 0.6$$

Where,

*Cost/Gallon* = the refueling cost per gallon of fuel consumed,

*Tank Size* = the volume, in gallons, of the liquid fuel tank,

*Share Filled* = the typical share of the tank volume filled during a refill event,

*Fixed Time* = the fixed time, in minutes, between deciding to refill and returning to the trip,

*Fill Rate* = the fuel dispense rate, in gallons per minute, of liquid fuel pumps,

*60* converts minutes to hours

*Time Value* = the value of the time for the occupants of the vehicle,

*0.6* = a scalar value to count only 60 percent of refueling events

We have estimated tank sizes the same way it was done in our 2021 GHG final rule, which was based on a 2016 internal Department of Transportation (DOT) memorandum. (CAFE TSD 2021) (White September 27, 2016) The most recent data reported was for the 2016 model year and showed that the average tank sizes of some of the most popular vehicles in the United States were 15.7, 18.7, and 27.3 for cars, vans and SUVs, and pickup trucks, respectively, all in gallons. We have used those values for all vehicles in each of those categories.

The share filled values are consistent for all vehicles at 0.65, meaning that the typical refill event includes filling 65 percent of the capacity of the tank.

The fixed time value is also consistent for all vehicles at 3.5 minutes per event, while the fill rate is held constant at 7.5 gallons per minute reflecting the legal restriction of 10 gallons per minute and the fact that not all people refill at that maximum rate.

The time value has been extensively analyzed by DOT for use in regulatory analyses. The values, which account for wage rates, miles driven in urban and rural settings, the different uses of vehicles whether it be personal or commercial use, and the typical number of occupants over the age of 5 years for different vehicles. The hourly values (\$/hour) derived and which we use are \$29.36, \$33.14, \$28.85, and \$47.28 for passenger cars, CUVs and SUVs, light-duty pickups, and medium-duty vans and pickups, respectively, all in 2021 dollars (DOT Volpe Center 2023). All of these values have been updated since our proposal.

As described by NHTSA, the 0.6 scaling factor is meant to capture those drivers whose primary reason for the refueling trip was due to a low reading on the gas gauge. Such drivers experience a cost due to added mileage driven to detour to a filling station, as well as added time to refuel and complete the transaction at the filling station. Drivers who refuel on a regular schedule or incidental to stops they make primarily for other reasons (e.g., using restrooms or buying snacks) do not experience the cost associated with detouring to locate a station or paying for the transaction, because the frequency of refueling for these reasons is unlikely to be affected by fuel economy improvements. This restriction was imposed to exclude distortionary effects of those who refuel on a fixed (e.g., weekly) schedule and may be unlikely to alter refueling patterns due to increased driving range (NHTSA 2022).

To estimate the refueling costs associated with BEVs, we calculate cost per mile.

$$\frac{Cost}{Mile} = \left( \frac{Fixed\ Time}{Charge\ Frequency} \times \frac{1}{60} + \frac{Share\ Charged}{Charge\ Rate} \right) \times Time\ Value$$

Where,

*Cost/Mile* = the refueling cost per mile driven

*Fixed Time* = the fixed time, in minutes, between deciding to recharge and returning to the trip,

*Charge Frequency* = the cumulative number of miles driven before a mid-trip charging event is triggered,

*Share Charged* = the share of miles that will be charged mid-trip,

*Charge Rate* = the typical recharge rate, in miles per hour of charging,

*Time Value* = the value of the time for the occupants of the vehicle.



The fixed time value is taken to be equal to that for liquid-fueled vehicles, at 3.5 minutes per event, and the time value is equal to those stated above for liquid-fueled vehicles.

The charge rate reflects the number of miles of driving provided by a one hour charging session. As described in Chapter 5.3, charging equipment is available at a variety of power levels, with higher power equipment generally able to charge a vehicle more quickly. For mid-trip charging, we assume BEV drivers will primarily use DC fast charging equipment (DCFC). Among DCFC deployments, there is a trend toward higher power levels with more than half of the public DCFC ports capable of power output at 250 kW or higher and about two-thirds at 150 kW or higher as of the second quarter of 2023 (Brown, et al. 2023). A combination of private and public funds is expected to continue the buildout of the DCFC network. This includes up to \$5 billion for the National Electric Vehicle Infrastructure (NEVI) Formula Program established by the Bipartisan Infrastructure Law. Initial funding to states under the NEVI program is supporting station buildout along designated highway corridors, with stations required to have at least four DCFC ports, each 150 kW or higher (U.S. DOT 2023). EPA's assessment of charging infrastructure needs and costs under the final rule (described in Chapter 5.3.2) projects a mix of 150 kW, 250 kW, and 350 kW public DCFCs will be needed to support PEVs in future years with the highest share of DCFC charging demand to be met by 350 kW DCFCs.<sup>93</sup> Different BEVs have different limits on how much energy can be delivered to the battery pack, and other factors – ambient conditions, battery state of charge, on-vehicle accessory loads during charging – impact the energy transfer. For this analysis, we use a value of 400 miles of driving added for each hour of charging, selected to represent DC fast charging at 150 kW,<sup>94</sup> and apply that value for all BEVs. If more mid-trip charging occurs at higher-power DCFCs, this value could be considered conservative.<sup>95</sup>

For the charge frequency and share charged parameters, we have used values developed by NHTSA and presented in the CCEMS input files used in support of their August 2023 proposal (U.S. DOT 2023) In their analysis, NHTSA estimated the frequency of mid-trip charging events and the share of miles driven that require mid-trip charging as shown in Table 4-17. As Table 4-17 shows, cars would be expected to require less frequent mid-trip charges and a smaller share of miles driven with mid-trip charge events. Pickups and vans/SUVs have fairly similar measures, with vans and SUVs requiring slightly more mid-trip charging than pickups.

---

<sup>93</sup> The analysis assumed that among DCFCs, the highest power that a vehicle can accept (or "as fast as possible" charging) is preferred. Residential, work, depot, and public L2 charging needs were also estimated, see Chapter 5.3.2.

<sup>94</sup> To estimate a typical charge rate for BEVs in our analysis, we used a sales-weighted average energy consumption rate from OMEGA for select years from 2027 to 2055, which is 0.34 kWh/mi accounting for charging losses. At maximum power, a 150 kW EVSE port could add about 440 miles of range per hour for a vehicle with this energy consumption rate. We rounded down to 400 miles given other factors that can impact charge rate.

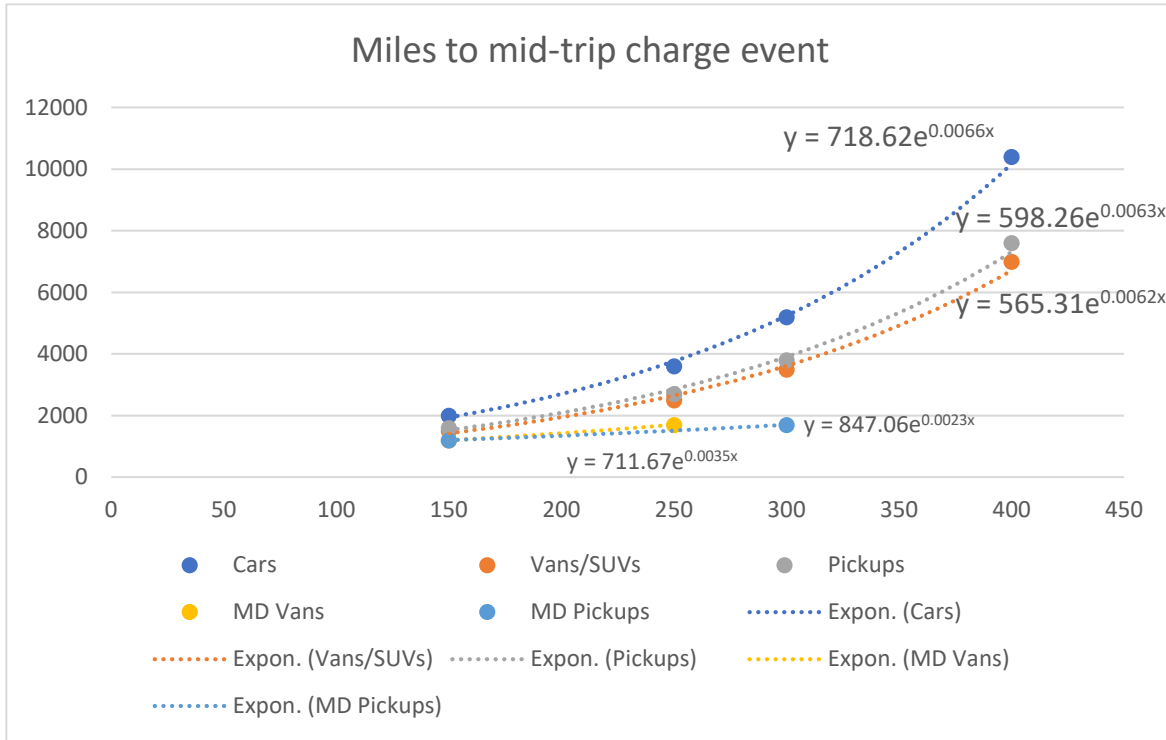
<sup>95</sup> To the extent mid-trip charging occurs at a higher charge rate or a lower charge rate, the resulting cost per mile for time spent charging electric vehicles would be lower or higher, respectively. In the NPRM, we used a value of 100 miles per hour of charging but have updated that value based on our updated analysis.

**Table 4-17: BEV recharging thresholds by body style and range \*.**

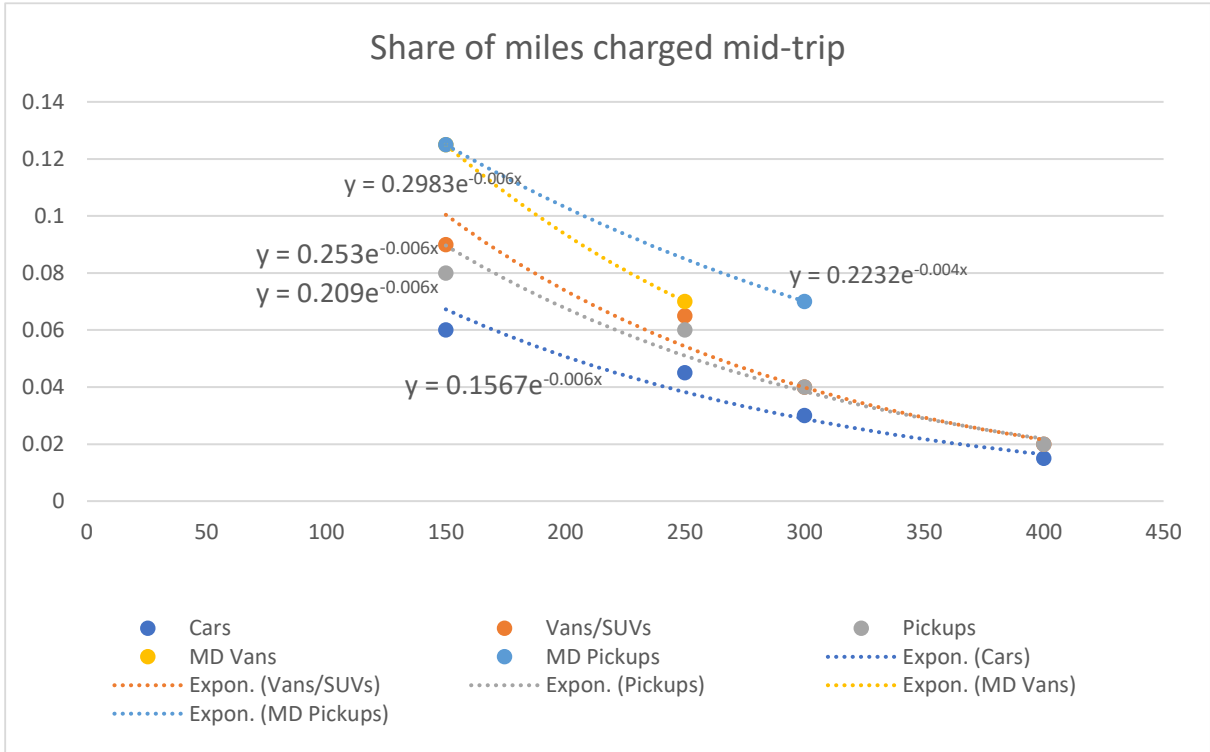
|  | Cars   | Vans & SUVs | Pickups | MD Vans | MD Pickups |
|--|--------|-------------|---------|---------|------------|
| Miles to mid-trip charging event, BEV150 | 2,000  | 1,500       | 1,600   | 1,200   | 1,200      |
| Miles to mid-trip charging event, BEV250 | 3,600  | 2,500       | 2,700   | 1,700   |            |
| Miles to mid-trip charging event, BEV300 | 5,200  | 3,500       | 3,800   |         | 1,700      |
| Miles to mid-trip charging event, BEV400 | 10,400 | 7,000       | 7,600   |         |            |
| Share of miles charged mid-trip, BEV150  | 0.06   | 0.09        | 0.08    | 0.125   | 0.125      |
| Share of miles charged mid-trip, BEV250  | 0.045  | 0.065       | 0.06    | 0.07    |            |
| Share of miles charged mid-trip, BEV300  | 0.03   | 0.04        | 0.04    |         | 0.07       |
| Share of miles charged mid-trip, BEV400  | 0.015  | 0.02        | 0.02    |         |            |

\* BEV150/250/300/400 refer to a BEVs having an expected 150/250/300/400 mile range.

Using the values in Table 4-17, EPA has developed curves for each body style as a function of range. These curves, new for the final rule, are exponential curve fits as a function of BEV range. These curves and their coefficient values are shown in Figure 4-5 and Figure 4-6.



**Figure 4-5: Curve fits for miles driven to a mid-trip charge event.**



**Figure 4-6: Curve fits for the share of miles charged in mid-trip events.**

For clarity, these curve fit equations are shown in Table 4-18.

**Table 4-18 Curve fits used in calculating refueling time for BEVs \***

|            | Miles to Mid-trip Charge Event | Share of Miles Charged Mid-trip |
|------------|--------------------------------|---------------------------------|
| Cars       | $718.62e^{(0.0066x)}$          | $0.1567e^{(-0.006x)}$           |
| Vans/SUVs  | $565.31e^{(0.0062x)}$          | $0.253e^{(-0.006x)}$            |
| Pickups    | $598.26e^{(0.0063x)}$          | $0.209e^{(-0.006x)}$            |
| MD Vans    | $711.67e^{(0.0035x)}$          | $0.2983e^{(-0.006x)}$           |
| MD Pickups | $847.06e^{(0.0023x)}$          | $0.2232e^{(-0.004x)}$           |

\* x is the BEV onroad range in miles.

### 4.3.6 Insurance Costs

Associated with the changing cost of vehicles will be a change in insurance paid by owners and drivers of those vehicles. To estimate insurance costs, we made use of an analysis done by Argonne National Laboratory (ANL) which focused on insurance costs associated with comprehensive and collision coverage. (Burnham, et al. 2021) In that report, ANL presented the data shown in 4-19 which is what we have used in OMEGA to estimate insurance costs.

**Table 4-19 Annual comprehensive and collision premium with \$500 deductible, 2019 dollars \*.**

|   |  |
|---|--|
| Body Style  | ICE, HEV, PHEV, BEV Powertrains        |
| Car   | (Vehicle value * 0.009 + \$220) * 1.19 |
| CUV/SUV   | (Vehicle value * 0.005 + \$240) * 1.19 |
| Pickup  | (Vehicle value * 0.006 + \$210) * 1.19 |
| * Vehicle value is calculated as the depreciated value of the vehicle as it ages. |  |

To estimate the vehicle value as it ages we estimated the deterioration rate using recent data from Black Book and Fitch Ratings which showed that the average annual depreciation rate of two- to six-year-old vehicles fluctuated over the last decade from a high of 17.3 percent to a low of 8.3 percent prior to the pandemic. (Black Book and Fitch Ratings 2021). Note that depreciation largely halted during the pandemic with two- to six-year old vehicles depreciating at only 2 percent in 2020 and projected at only 5 percent in 2021. The pandemic rates are unlikely to be representative of future depreciation rates, so we averaged the annual rates from 2016 – 2019 to construct a more representative average depreciation rate of 14.9 percent. We estimate that future depreciation rates will resemble pre-pandemic trends and the analysis uses the 14.9 percent depreciation rate for all future years.

We did not estimate insurance costs in the NPRM, so these costs are new and represent increased costs relative to the proposal. As discussed, our estimated insurance rates differ slightly by body-style, but not by powertrain type. Note that insurance costs are calculated for all years of a vehicle's lifetime.

#### **4.3.7 Maintenance and Repair Costs**

Maintenance and repair (M&R) are large components of vehicle cost of ownership for any vehicle. According to Edmunds, maintenance costs consist of two types of maintenance: scheduled and unscheduled. Scheduled maintenance is the performance of factory-recommended actions at periodic mileage or calendar intervals, like oil changes. Unscheduled maintenance includes wheel alignment and the replacement of items such as the 12-Volt battery, brakes, headlights, hoses, exhaust system parts, taillight/turn signal bulbs, tires, and wiper blades/inserts (Edmunds 2023). Repairs, in contrast, are done to fix malfunctioning parts that inhibit the use of the vehicle. The differentiation between the items that are included in unscheduled maintenance versus repairs is likely arbitrary, but the items considered repairs seem to follow the systems that are covered in vehicle comprehensive (i.e., “bumper-to-bumper”) warranties offered by automakers, which exclude common “wear” items like tires, brakes, and starter batteries (Muller 2017).

To estimate maintenance and repair costs, we have used the data gathered and summarized by Argonne National Laboratory (ANL) in their look at the total cost of ownership for vehicles of various sizes and powertrains (Burnham, et al. 2021).

##### **4.3.7.1 Maintenance Costs**

Maintenance costs, and differences between ICE vehicles and HEVs versus BEVs and PHEVs, are an important consideration in not only the full accounting of social benefits and costs, but also the consumer decision-making process when comparing ICE/HEV technology versus BEV/PHEV technology. If BEVs and PHEVs are less costly to maintain, a consumer

might find the potentially higher purchase price of the vehicle to be “worth it” given the possibly lower fuel and maintenance costs over time. The reverse is also true – more costly BEV/PHEV maintenance relative to ICE/HEV might make the potentially higher purchase price even less appealing, even if the fueling costs are lower. Table 4-20 presents our estimated maintenance costs for the final standards and each alternative.

**Table 4-20: Maintenance costs associated with the final standards and each alternative (billions of 2022 dollars).**

| Calendar Year | Final    | Alternative A | Alternative B |
|---------------|----------|---------------|---------------|
| 2027          | \$0.042  | \$0.097       | \$0.042       |
| 2028          | \$0.096  | \$0.14        | \$0.083       |
| 2029          | \$0.089  | -\$0.0079     | \$0.09        |
| 2030          | -\$0.027 | -\$0.34       | -\$0.0077     |
| 2031          | -\$0.35  | -\$0.91       | -\$0.29       |
| 2032          | -\$0.9   | -\$1.7        | -\$0.79       |
| 2035          | -\$3.3   | -\$4.9        | -\$3.2        |
| 2040          | -\$13    | -\$15         | -\$11         |
| 2045          | -\$24    | -\$25         | -\$20         |
| 2050          | -\$32    | -\$32         | -\$27         |
| 2055          | -\$35    | -\$35         | -\$30         |
| PV2           | -\$300   | -\$320        | -\$260        |
| PV3           | -\$250   | -\$270        | -\$210        |
| PV7           | -\$110   | -\$130        | -\$98         |
| AV2           | -\$14    | -\$15         | -\$12         |
| AV3           | -\$13    | -\$14         | -\$11         |
| AV7           | -\$9.3   | -\$10         | -\$8          |

\* Negative values reflect lower costs (i.e., savings).

In their study, ANL developed a generic maintenance service schedule for various powertrain types using owner’s manuals from various makes and models including the Toyota Yaris, Camry, Camry HEV, Prius, and Prius Prime; Chevrolet Cruze, Volt, and Bolt; Nissan Sentra, Kicks, and Leaf; Kia Optima, Optima HEV, and Optima PHEV; Kia Soul and Soul EV; Tesla Model 3 and Model S, Ford Focus; Lincoln MKZ; BMW i3; VW Golf and e-Golf; and Fiat 500 and 500e. The analysis assumed that drivers would follow the recommended service intervals. The authors noted that, in practice, not everyone follows the recommended service intervals but also noted that owners likely do so at the expense of either future repair costs or the early scrappage of the vehicle (Burnham, et al. 2021, 81). The authors also noted that estimates were made for certain “wear items” that might not normally be included in a recommended maintenance schedule (e.g., brake pads and rotors) for which they estimated average lifetimes based on guidance from several experts and from automotive websites (Burnham, et al. 2021, 81).

After developing the maintenance schedules, the authors collected national average costs for each of the preventative and unscheduled services. The authors noted that service cost varies by several factors, including the type of mechanic (dealership vs. chain vs. independent), part quality (OEM vs. aftermarket), and make and model cost characteristics (domestic vs. import and mass market vs. luxury). The authors did not assume drivers would perform any of their own maintenance services, stating a lack of data available on how often drivers do so. The authors

noted that “do it yourself” maintenance would reduce costs, though depending on the service would require investment in both tools and skill development (Burnham, et al. 2021, 81).

The authors noted that vehicle type (sedan, SUV, pickup) may influence maintenance costs as some part sizes and fluid capacities can be larger for bigger vehicles (e.g., larger tires needed for a pickup). However, when examining the data at their disposal, the authors found no significant difference over 10 years of ownership. But total maintenance and repair costs of medium-duty diesel vehicles were about 34% higher than that of their gasoline counterparts. The authors attributed that difference to repairs rather than maintenance, since the most obvious maintenance difference between the vehicles is that diesels do not have spark plugs which is a relatively small cost. The authors acknowledge that their dataset had a very limited number of diesel vehicles and there appeared to be no clear trend regarding higher or lower maintenance costs for diesel fueled vehicles.

Specific to tires and tire replacement, an issue often cited with respect to BEVs versus ICE vehicles, the authors noted that their analysis assumed that tire life and replacement costs are the same for all powertrains. Some BEVs are equipped with tires that differ from those on typical ICE vehicles to address tread wear and the instant torque of BEVs. Burnham et al (2021) further note that advanced powertrain vehicles are often equipped with low rolling resistance (LRR) tires, but EPA believes most new vehicles, regardless of powertrain, are equipped and sold with LRR tires. There have also been claims that traditional tires wear 30 percent faster when installed on BEVs (Burnham, et al. 2021, 83). Overall, while there is some evidence that BEVs and ICE vehicles may be equipped with different tires, there is insufficient empirical evidence on the costs of these tires or differential wear to conclude that tire and tire replacement costs vary across powertrains.

Regarding brake-related maintenance, the authors assumed that brake pad, rotor, and caliper replacement intervals could be extended by 33% for HEVs and by 50% for PHEVs and BEVs, relative to ICE vehicles, due to less friction wear that would result from the use of regenerative braking. Further, they assumed that PHEVs and BEVs would have more regenerative braking capabilities than HEVs and, therefore, that their service intervals could be extended longer than HEVs due to their larger battery capacity and electric motor(s) (Burnham, et al. 2021, 84). Table 4-23 shows the maintenance costs used as inputs to OMEGA.

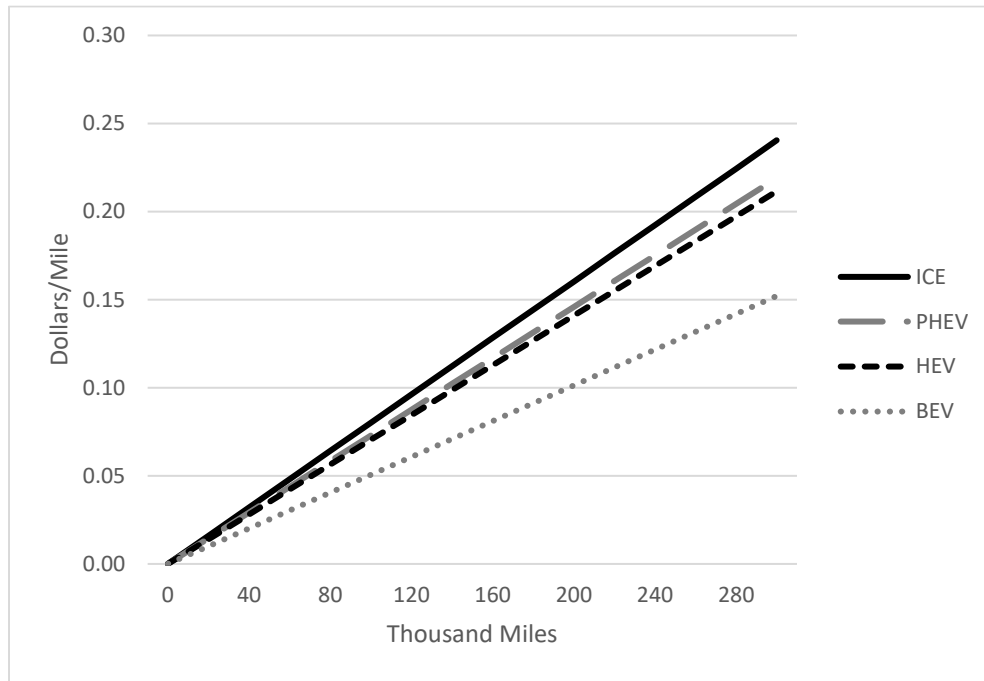
**Table 4-21: Maintenance service schedule by powertrain.**

| Service                | Miles per Event ICE | Miles per Event HEV | Miles per Event PHEV | Miles per Event BEV | Cost per Event (2019 dollars) |
|------------------------|---------------------|---------------------|----------------------|---------------------|-------------------------------|
| Engine Oil             | 7,500               | 7,500               | 9,000                | n/a                 | \$65                          |
| Oil Filter             | 7,500               | 7,500               | 9,000                | n/a                 | \$20                          |
| Tire Rotation          | 7,500               | 7,500               | 7,500                | 7,500               | \$50                          |
| Wiper Blades           | 15,000              | 15,000              | 15,000               | 15,000              | \$45                          |
| Cabin Air Filter       | 20,000              | 20,000              | 20,000               | 20,000              | \$50                          |
| Multi-Point Inspection | 20,000              | 20,000              | 20,000               | 20,000              | \$110                         |
| Engine Air Filter      | 30,000              | 66,667              | 83,333               | n/a                 | \$40                          |
| Brake Fluid            | 37,500              | 37,500              | 37,500               | 37,500              | \$150                         |
| Tires Replaced         | 50,000              | 50,000              | 50,000               | 50,000              | \$525                         |
| Brake Pads             | 50,000              | 66,667              | 75,000               | 75,000              | \$350                         |
| Starter Battery        | 50,000              | 50,000              | 50,000               | 50,000              | \$175                         |
| Spark Plugs            | 60,000              | 120,000             | 120,000              | n/a                 | \$225                         |
| Oxygen Sensor          | 80,000              | 80,000              | 80,000               | n/a                 | \$350                         |
| Headlight Bulbs        | 80,000              | 80,000              | 80,000               | 80,000              | \$90                          |
| Transmission Service   | 90,000              | 110,000             | 110,000              | n/a                 | \$200                         |
| Timing Belt            | 90,000              | 110,000             | 110,000              | n/a                 | \$750                         |
| Accessory Drive Belt   | 90,000              | 110,000             | 110,000              | n/a                 | \$165                         |
| HVAC Service           | 100,000             | 100,000             | 100,000              | 100,000             | \$50                          |
| Brake Rotors           | 100,000             | 125,000             | 150,000              | 150,000             | \$500                         |
| Shocks and Struts      | 100,000             | 100,000             | 100,000              | 100,000             | \$1,000                       |
| Engine Coolant         | 125,000             | 125,000             | 125,000              | n/a                 | \$190                         |
| EV Battery Coolant     | n/a                 | 125,000             | 125,000              | 125,000             | \$210                         |
| Fuel Filter            | 150,000             | 150,000             | 200,000              | n/a                 | \$110                         |
| Brake Calipers         | 150,000             | 187,500             | 225,000              | 225,000             | \$1,000                       |

Using the schedules and costs shown in Table 4-21, OMEGA then calculates the cumulative maintenance costs from mile zero through mile 225,000. For example, the cumulative costs for an ICE vehicle at 15,000 miles would be  $2 \times (\$65 + \$20 + \$50) + \$45$ , or \$315. The cumulative costs can then be divided by the cumulative miles to determine the average maintenance cost per mile at any given odometer reading in a vehicle's life.

However, that average cost, while informative, suggests that the first mile incurs the same cost as the last mile. This does not seem appropriate, especially considering that the cumulative costs for ICE vehicles, \$20,050, divided by 225,000 cumulative miles results in an average cost per mile of \$0.09. If that vehicle had a fuel economy of 35 miles per gallon, assuming \$3 per gallon of gasoline, its fuel costs would also be \$0.09 per mile. Applying the average maintenance cost per mile over 15,000 first year miles, the fuel costs and maintenance costs would both be \$1,350. This method of estimating maintenance costs vastly exceeds the above \$315 estimate of maintenance costs over the first 15,000 miles.

Clearly, while the average maintenance cost per mile of \$0.09 is valid and informative, it is not the best valuation for our purpose. Instead, we have estimated the cost per mile at a constant slope with an intercept set to \$0 per mile such that the cumulative costs after 225,000 miles would equal the \$20,050 (for an ICE vehicle) included in the suggested maintenance schedule. Following this approach, the maintenance cost per mile curves calculated within OMEGA are as shown in Figure 4-7.



**Figure 4-7: Maintenance cost per mile (2019 dollars) at various odometer readings.**

Using these maintenance cost per mile curves, OMEGA then calculates the estimated maintenance costs in any given year of a vehicle’s life based on the miles traveled in that year. Importantly, the cost curves estimate cumulative maintenance costs at any given odometer reading. To estimate the maintenance costs in any given year, the cumulative maintenance costs in the prior year are subtracted from the cumulative maintenance costs in the given year. This way, the maintenance costs in each year, when summed, will equate to the cumulative maintenance costs derived from the input data.

$$MaintenanceCost_t = 0.5 \times MaintenanceCostPerMile_t \times Odometer_t - CumulativeMaintenanceCost_{t-1}$$

Where,

$MaintenanceCost_t$  = maintenance cost for a given vehicle in year t

$MaintenanceCostPerMile_t$  = maintenance cost per mile at the odometer reading reached in year t (see Figure 4-7)

$Odometer_t$  = the odometer reading of the given vehicle in year t



$CumulativeMaintenanceCost_{t-1}$  = the cumulative maintenance cost for the given vehicle through year t-1

OMEGA uses these maintenance costs for light-duty and for medium-duty vehicles. The maintenance costs are included in the benefit and cost analysis. Note that these maintenance costs differ from those presented in Chapter 4.1 and Chapter 4.2. Chapter 4.1 costs are meant to reflect the thought process of a potential new vehicle purchaser. Chapter 4.2 amounts are estimated average expenses per vehicle over the first 8 years of vehicle life. Costs presented here in Chapter 4.3 are meant to estimate the actual effects of the final rule.

### 4.3.7.2 Repair Costs

Table 4-22 presents our estimates of repair costs associated with the final standards and each of the alternatives.

**Table 4-22: Repair costs associated with the final standards and each alternative (billions of 2022 dollars).**

| Calendar Year  | Final   | Alternative A | Alternative B |
|--|---------|---------------|---------------|
| 2027   | \$0.027 | \$0.091       | \$0.026       |
| 2028   | \$0.081 | \$0.23        | \$0.067       |
| 2029   | \$0.16  | \$0.36        | \$0.14        |
| 2030   | \$0.26  | \$0.48        | \$0.24        |
| 2031   | \$0.35  | \$0.55        | \$0.33        |
| 2032   | \$0.38  | \$0.57        | \$0.36        |
| 2035   | \$0.7   | \$0.75        | \$0.35        |
| 2040   | -\$0.81 | -\$0.88       | -\$1.1        |
| 2045   | -\$3.4  | -\$3.4        | -\$3.3        |
| 2050   | -\$5.7  | -\$5.7        | -\$5.3        |
| 2055   | -\$7.1  | -\$7.3        | -\$6.6        |
| PV2  | -\$40   | -\$40         | -\$41         |
| PV3  | -\$32   | -\$31         | -\$32         |
| PV7  | -\$12   | -\$12         | -\$13         |
| AV2  | -\$1.8  | -\$1.8        | -\$1.9        |
| AV3  | -\$1.6  | -\$1.6        | -\$1.7        |
| AV7  | -\$0.99 | -\$0.94       | -\$1.1        |
| * Negative values reflect lower costs (i.e., savings). |         |               |               |

Repairs are done to fix malfunctioning parts that inhibit the use of the vehicle and are generally considered to address problems associated with parts or systems that are covered under typical manufacturer bumper-to-bumper type warranties. In the ANL study, the authors were able to develop a repair cost curve for a gasoline car and a series of scalars that could be applied to that curve to estimate repair costs for other powertrains and vehicle types. The repair cost curve developed in the ANL study is shown in the equation below (Burnham, et al. 2021).

$$Repair_i = vpa_i e^{bx}, i = 1, \dots, 15$$

Where,

$Repair_i$  = the repair cost per mile at age i,

$v$  = the appropriate vehicle type multiplier (see Car/SUV/Truck entries in Table 4-23),

$p$  = the appropriate powertrain type multiplier (see ICE/HEV/PHEV/BEV/FCV entries in Table 4-23),

$a_i$  = gasoline car repair cost coefficient at age  $i$ ,

$b$  = exponential constant of 0.00002,

$x$  = the MSRP of the car when sold as new.

**Table 4-23: Repair cost per mile coefficient values<sup>a</sup>**

| Item                 | Value   |
|----------------------|---------|
| Car multiplier       | 1.0     |
| SUV multiplier       | 0.91    |
| Truck multiplier     | 0.7     |
| MD Van multiplier    | 1.9     |
| MD Pickup multiplier | 1.6     |
| ICE multiplier       | 1.0     |
| HEV multiplier       | 0.91    |
| PHEV multiplier      | 0.86    |
| BEV multiplier       | 0.67    |
| FCV multiplier       | 0.67    |
| $a_0$                | 0       |
| $a_1$                | 0       |
| $a_2$                | 0.00333 |
| $a_3$                | 0.01    |
| $a_4$                | 0.0167  |
| $a_{\text{add-on}}$  | 0.00333 |

<sup>a</sup> These coefficient values come from Burnham, Gohlke, et al. (2021) with the exception of the medium-duty multipliers which were added by EPA to replicate the repair cost share of the maintenance and repair cost curve shown in Figure 3.32 of the ANL study.

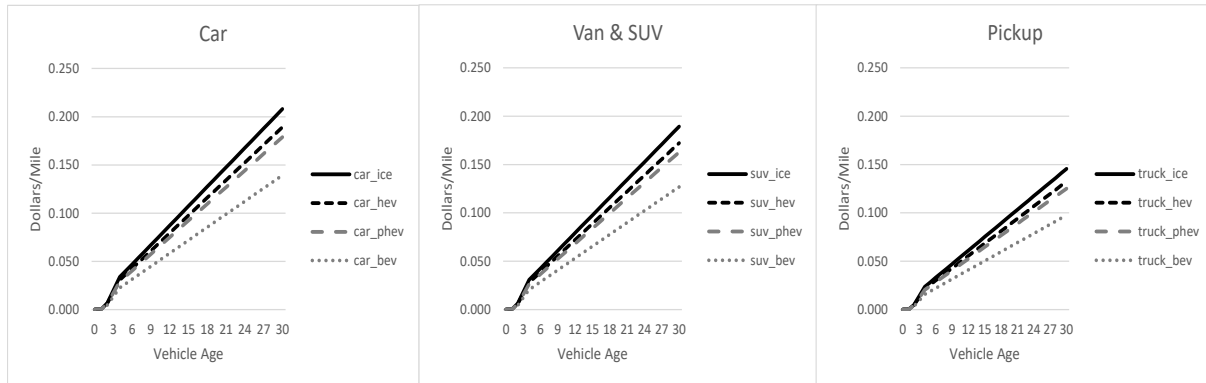
OMEGA makes use of the equation developed in the ANL study along with the coefficient values shown in Table 4-23 to estimate repair costs per mile at any age in a given vehicle's life. In place of the MSRP<sup>96</sup> of the new vehicle, OMEGA uses the estimated cost to manufacture the vehicle excluding applicable tax credits that might reduce the price paid by the purchaser. Further, OMEGA makes use of this equation for all ages of a vehicle's life (OMEGA estimates a 30/40-year lifetime) using the  $a_{\text{add-on}}$  value for every age beyond the first five years. In other words, the  $a_x$  value for age 7 would be  $0.0167 + 3 \times 0.00333 = 0.02669$  (note that, in OMEGA, age=7 is the 8th year of a vehicle's life). The resultant repair cost per mile values at all ages are shown in Figure 4-8. Note that the new vehicle cost (used in place of the MSRP value) is held constant at \$35,000 in Figure 4-8, regardless of vehicle type (car, van/SUV, pickup) and

---

<sup>96</sup> Manufacturer suggested retail price

powertrain (ICE vehicle, HEV or MHEV, PHEV, BEV) which is not likely, but is presented here for illustration only.

OMEGA uses these repair costs for both light-duty and medium-duty. Repair costs are included in the benefit-cost analysis.



**Figure 4-8: Repair cost per mile (2019 dollars) for a \$35,000 Car, Van/SUV and Pickup with various powertrains.**

#### **4.3.8 Costs Associated with Noise and Congestion**

If consumers choose to drive more, they benefit from the utility derived from those additional miles, as described in Chapter 4.3.2. In contrast to the benefits associated with additional driving, there are also costs. Increased vehicle use associated with a positive rebound effect also contributes to increased traffic congestion and highway noise. Depending on how the additional travel is distributed throughout the day and where it takes place, additional vehicle use can contribute to traffic congestion and delays by increasing traffic volumes on facilities that are already heavily traveled during peak periods. These added delays impose higher costs on other road users in the form of increased travel time and operating expenses. Because drivers do not take these external costs into account in deciding when and where to travel, we account for them separately as a cost of additional driving associated with a positive rebound effect.

EPA relies on congestion and noise cost estimates developed by the Federal Highway Administration (FHWA) to estimate the increased external costs caused by added driving due to a positive rebound effect. EPA employed estimates from this source previously in the analysis accompanying the light-duty 2010, 2012, and 2021 final rules. We continue to find them appropriate for this analysis after reviewing the procedures used by FHWA to develop them and considering other available estimates of these values.

FHWA’s congestion cost estimates focus on freeways because non-freeway effects are less serious due to lower traffic volumes and opportunities to re-route around the congestion. EPA has applied the congestion cost to the overall VMT therefore the results of this analysis potentially overestimate the congestion costs associated with increased vehicle use, and thus lead to a conservative estimate of net benefits.

EPA uses FHWA’s “Middle” estimates for marginal congestion and noise costs caused by increased travel from vehicles. This approach is consistent with the methodology used in our prior analyses. The values used are shown in Table 4-24. These congestion costs are consistent with those used in the 2021 final rule. These values are used as inputs to OMEGA and adjusted within the model to the dollar basis used in the benefit and cost analysis. Table 4-25 and Table 4-26 present our estimated congestion and noise costs, respectively, associated with the final standards and each of the alternatives.

**Table 4-24: Costs associated with congestion and noise (2018 dollars per vehicle mile)**

|            | Sedans/Wagons | CUVs/SUVs/Vans | Pickups |
|------------|---------------|----------------|---------|
| Congestion | 0.0634        | 0.0634         | 0.0566  |
| Noise      | 0.0009        | 0.0009         | 0.0009  |

**Table 4-25 Congestion costs associated with the final standards and the alternatives (billions of 2022 dollars)**

| Calendar Year | Final    | Alternative A | Alternative B |
|---------------|----------|---------------|---------------|
| 2027          | \$0.0013 | \$0.0034      | \$0.0016      |
| 2028          | \$0.027  | \$0.066       | \$0.025       |
| 2029          | \$0.05   | \$0.12        | \$0.046       |
| 2030          | \$0.073  | \$0.18        | \$0.078       |
| 2031          | \$0.094  | \$0.24        | \$0.1         |
| 2032          | \$0.11   | \$0.27        | \$0.11        |
| 2035          | \$0.59   | \$0.73        | \$0.47        |
| 2040          | \$1.3    | \$1.4         | \$1.1         |
| 2045          | \$1.9    | \$1.9         | \$1.7         |
| 2050          | \$2.3    | \$2.3         | \$2           |
| 2055          | \$2.4    | \$2.4         | \$2.2         |
| PV2           | \$25     | \$27          | \$22          |
| PV3           | \$21     | \$23          | \$18          |
| PV7           | \$10     | \$11          | \$8.9         |
| AV2           | \$1.2    | \$1.2         | \$1           |
| AV3           | \$1.1    | \$1.2         | \$0.96        |
| AV7           | \$0.83   | \$0.92        | \$0.73        |

\* Positive values reflect increased costs.

**Table 4-26 Noise costs associated with the final standards and the alternatives (billions of 2022 dollars)**

| Calendar Year | Final      | Alternative A | Alternative B |
|---------------|------------|---------------|---------------|
| 2027          | \$0.000015 | \$0.000031    | \$0.000019    |
| 2028          | \$0.00041  | \$0.001       | \$0.00039     |
| 2029          | \$0.00077  | \$0.0019      | \$0.00074     |
| 2030          | \$0.0011   | \$0.0029      | \$0.0012      |
| 2031          | \$0.0015   | \$0.0038      | \$0.0016      |
| 2032          | \$0.0017   | \$0.0043      | \$0.0018      |
| 2035          | \$0.0095   | \$0.012       | \$0.0077      |
| 2040          | \$0.021    | \$0.023       | \$0.018       |
| 2045          | \$0.03     | \$0.032       | \$0.027       |
| 2050          | \$0.037    | \$0.038       | \$0.033       |
| 2055          | \$0.04     | \$0.04        | \$0.036       |
| PV2           | \$0.41     | \$0.44        | \$0.36        |
| PV3           | \$0.34     | \$0.37        | \$0.3         |
| PV7           | \$0.17     | \$0.18        | \$0.15        |
| AV2           | \$0.019    | \$0.02        | \$0.017       |
| AV3           | \$0.018    | \$0.019       | \$0.016       |
| AV7           | \$0.014    | \$0.015       | \$0.012       |

\* Positive values reflect increased costs.

#### 4.4 New Vehicle Sales

The topic of the "energy paradox" or "energy efficiency gap" has been extensively discussed in previous analyses of vehicle GHG standards. The idea of the energy efficiency gap is that existing fuel saving technologies were not widely adopted even though they reduced fuel consumption enough to pay for themselves in a short period of time. Conventional economic principles suggest that because the benefits to vehicle buyers of the new technologies would outweigh the costs to those buyers, automakers would provide them and people would buy them.

As described in previous EPA GHG vehicle rules (most recently in the 2021 rule), engineering analyses identified technologies (such as downsized-turbocharged engines, gasoline direct injection, and improved aerodynamics) where the additional cost of the technology is quickly covered by the fuel savings it provides, but they were not widely adopted until after the issuance of EPA vehicle standards. Research also suggests that the presence of fuel-saving technologies do not lead to adverse effects on other vehicle attributes, such as performance and noise. Instead, research shows that there are technologies that exist that provide improved fuel economy without hindering performance, and in some cases, while also improving performance (Huang, Helfand, et al. 2018) (Watten, Helfand and Anderson 2021). Additionally, research demonstrates that, in response to the standards, automakers have improved fuel economy without adversely affecting other vehicle attributes (Helfand and Dorsey-Palmateer 2015). Lastly, while the availability of more fuel efficient vehicles has increased steadily over time, research has shown that the attitudes of drivers toward those vehicles with improved fuel economy has not been affected negatively (Huang, Helfand, et al. 2018) (Huang, Helfand and Bolon 2018a). Thus, EPA does not model tradeoffs between fuel economy and performance as a path to achieving the standards. This "constant performance" assumption in our modeling is achieved by estimating technology costs and emissions reductions while maintaining the performance of each vehicle from the base year, which obviates the need to estimate potential lost consumer welfare from

foregone attributes. EPA considers the assumption of constant performance to be a conservative one, since our estimated compliance costs are higher than would be the case for manufacturers which offer consumers lower cost vehicles with reduced performance. It appears that in the absence of the standards, markets have not led to the adoption of fuel-efficient technologies with short payback periods and no discernible tradeoffs, suggesting that an energy efficiency gap appears to have existed, especially in the absence of the standards, and may still exist.

A combination of consumer-side and producer-side hypotheses in the literature may best explain why there was limited adoption of cost-effective fuel-saving technologies before the implementation of more stringent standards, though the literature has not settled on a single explanation (National Academies of Science, Engineering, and Medicine 2021).<sup>97</sup>

Consumer-side hypotheses include:

- Consumers might lack information, not have a full understanding of this information when it is presented, not have correct information, not have the ability to process the information, or not trust the presented information.
- Consumers might weigh the present or present circumstances (e.g., current costs) more heavily than future opportunities (e.g., long term savings, changing circumstances) in their purchase decisions due to, for example, uncertainty about the future, a lack of foresight, an aversion to short term losses relative to longer term gains, or a preference for the status quo.
- Consumers might prioritize other vehicle attributes over fuel economy in their vehicle purchase process.
- Consumers might erroneously associate higher fuel economy with lower quality vehicles.

In addition to the research discussed above indicating that fuel-saving technologies are not likely to be associated with adverse effects on other vehicle attributes, EPA has explored evidence on how consumers evaluate fuel economy in their vehicle purchase decisions. Overall, the research has not reached a consensus; results and estimates vary across a range of data types and statistical models. Thus, it is not clear how consumers incorporate fuel economy in their purchase decision, nor how consumer behavior might contribute to the energy efficiency gap.

Part of the uncertainty surrounding the reasons behind the energy efficiency gap is that most of the technology applied to existing ICE vehicles may have been "invisible" to the consumer, both literally and possibly in effect. This is for a few reasons, including that the technology itself was not something the mainstream consumer would know about, or because it was applied to a

---

<sup>97</sup> For simplicity, we present consumer- and producer-side hypotheses for the "energy efficiency gap", consistent with traditional economic theory. Analogously but somewhat differently, we could have presented these hypotheses organized according to individual and institutional characteristics, behaviors, and biases. Under that organization structure, some of the hypotheses we present, such as myopia, uncertainty aversion, loss aversion, asymmetric information, and status quo bias, could apply to both consumer and producers.

vehicle at the same time as multiple other changes, therefore making it unclear to the consumer what changes in vehicle attributes, if any, could be attributed to a specific technology.

Much less research has been conducted to evaluate the producer side of the market, though three interrelated themes arise: market structure, business strategy, and technological innovation. The structure of the automobile industry may inefficiently allocate car attributes, including fuel economy, which may contribute to the existence of an energy efficiency gap. Specifically, vehicle production involves significant fixed costs in which automakers strive to differentiate their products from each other. In that context, fuel economy of a vehicle could be just one factor of many in a company's product differentiation strategy. Product differentiation can lead to an under-supply of fuel economy relative to what is cost-effective to consumers in some segments, and an over-supply of fuel economy in other sectors (Fischer 2005). Automobile manufacturers may adopt a "wait and see" strategy regarding the costs associated with investing in and commercializing new technologies.

In the absence of standards, automakers have seemed willing to invest in small improvements upon existing technologies (Helfand and Dorsey-Palmateer 2015) and more reluctant to invest in major innovations in the absence of standards. This may be a result of first-mover disadvantages to investing in and commercializing new technologies. The "first-mover disadvantage" occurs when the "first-mover" pays a higher proportion of the costs of developing, implementing, or marketing a new technology and loses the long-term advantage when other businesses move into that market. There could also be "dynamic increasing returns" to adopting new technologies, wherein the value of a new technology may depend on how many other companies have adopted the technology. Additionally, there can be research and development synergies when many companies work on the same technologies at the same time, assuming there's a reason to innovate at the same time. Standards can create conditions under which companies invest in major innovations. Because all companies (both auto firms and auto suppliers) have incentives to find better, less expensive ways of meeting the standards, the possibilities for synergistic interactions may increase. Thus, the standards, by focusing all companies on finding more efficient ways of achieving the standards, may lead to better outcomes than if any one company operated on its own.

At the first purchase of a PEV, the energy efficiency technology is clearly apparent to the consumer (i.e., consumer-facing), in which case the above "invisibility" rationale does not apply. However, as PEV technology continues to evolve, and as precedent with ICE vehicle technology suggests, technologies that improve PEV efficiency may again become invisible to the consumer, making the value of those improvements less apparent at the time of purchase, even if operating savings are apparent.

Also, with the growing availability of PEV options, there may be additional risk of information asymmetry between those selling PEVs (including manufacturers and dealerships) and those considering purchasing one, which may be due to inexperience on one or both sides, uncertainty in the technology, or other factors. Other reasons the energy efficiency paradox may persist, regardless of vehicle powertrain, include uncertainty about future fuel and electricity prices, uncertainty about charging infrastructure and availability, or perceptions of comparisons of quality and durability of different powertrains. However, there may be factors that mitigate the effect. Uncertainties will be resolved over time (e.g., growing familiarity with PEVs and EVSE, durability), systems will evolve (e.g., infrastructure growth and expansion, fuel and electricity

prices, supply chains), and the nature and balance of information will change. Another factor that may reduce the magnitude of a possible energy efficiency gap are the incentives provided in the BIL and IRA which provide support for the development, production, and purchase of PEVs and the supporting infrastructure. Constraints on investment, either for manufacturers of the technology or for potential purchasers of the technology, may also lead to slower adoption rates of energy efficiency technology, even if the technology leads to reductions in operating costs. Federal or other incentives to manufacture or purchase energy efficient technology will reduce the impact that constraints on investment have on adoption of that technology. For PEVs, the availability of existing incentives, including the Federal purchaser and battery manufacturing tax credits in the IRA, is expected to lead to lower upfront costs for purchasers of PEVs than would otherwise occur.<sup>98</sup>

There is uncertainty in the historical literature regarding consumer acceptance and adoption of electric vehicles, as described in Chapter 4.1 and Jackman et al. (2023), however recent research suggests that the demand for electric vehicles is robust, and adoption is constrained, at least in part, by limited supply. Gillingham et al. (2023) examine all new LD vehicles sold in the U.S. between 2014 and 2020, focusing on comparisons of existing electric vehicles to their most similar ICE vehicle counterpart, finding that EVs are preferred to the ICE counterpart in some segments (Gillingham, et al. 2023). In the paper, the authors show that, compared to ICE counterparts, EVs have seen relative sales shares of over 30%, which indicates that the share of PEVs in the marketplace is, at least partially, constrained due to the lack of offerings needed to convert existing demand into market share. In addition, a survey from Consumer Reports in early 2022 shows that more than one third of Americans would either seriously consider or definitely buy or lease a BEV today, if they were in the market for a vehicle. (Bartlett 2022). We expect the share of Americans willing to own or lease a PEV will grow over time as exposure to, and familiarity with, PEVs increases, as well as with infrastructure growth (Jackman, et al. 2023).

The rest of this chapter will discuss how sales effects were modeled in OMEGA, as well the total change in sales estimated due to this rule.

#### **4.4.1 How Sales Impacts Were Modeled**

EPA has updated its OMEGA model, in part, to increase the model's useability and transparency. In addition, the model has been updated to allow for interactions in producer and consumer decisions in estimating total sales and the share of ICE vehicles, BEVs, and PHEVs in the market that both meet the standard being analyzed and will be accepted by consumers. More about the updated OMEGA model, including detailed information on the structure and operations, can be found in RIA Chapter 2. As in previous rulemakings, the sales impacts are based on a set of assumptions and inputs, including assumptions about the role of fuel

---

<sup>98</sup> The IRA battery tax credit is also expected to reduce upfront costs for purchasers, although it is a tax credit for battery manufacturers, not purchasers. We expect vehicle manufacturers to reduce the price of their vehicles in accordance with their ability to take advantage of this battery tax credit in order to remain competitive in the market.



consumption in vehicle purchase decisions described in Chapter 4.1, and assumptions on consumers' demand elasticity discussed below.<sup>99</sup>

At a high level, OMEGA estimates the effects of a policy on new vehicle sales volumes as a deviation from the sales that would take place in the absence of the standards.<sup>100</sup> This calculation is based on applying a demand elasticity to the change in new vehicle net price, the price that incorporates the fact that vehicle buyers are expected to take fuel consumption into consideration in the purchase process. The modeled BEV and PHEV shares, as described in Chapter 4.1, are then applied to the estimated total sales volumes to estimate further effects of the rule, including costs, emissions, and benefits.

#### **4.4.1.1 The Role of Fuel Consumption in Vehicle Sales Estimates**

In the 2021 rule, as well as in this rule, EPA assumed that producers account for 2.5 years of fuel consumption in their assessment of the consumer's purchase decision. However, as discussed in detail in the 2021 rule, there is not a consensus around the role of fuel consumption in vehicle purchase decisions. Greene, et al. (2018) estimates a mean willingness to pay for a one cent per mile reduction in fuel costs over the lifetime of an average vehicle to be \$1,880, with a median of \$990 and a very large standard deviation. For comparison, 2.5 years of fuel savings, assuming one cent per mile and 15,000 vehicle miles traveled per year is about \$375. This is within the large standard deviation in Greene, et al. (2018) for the willingness to pay to reduce fuel costs, but it is far lower than both the mean and the median of \$990. On the other hand, the 2021 National Academy of Sciences (NAS) report, citing the 2015 NAS report, observed that automakers “perceive that typical consumers would pay upfront for only one to four years of fuel savings” (pp. 9-10), which is also within the range of values identified in Greene, et al. (2018) for consumer response, but also well below the median or mean. (National Academies of Science, Engineering, and Medicine 2021) Recent research shows that the results in Greene, et al. (2018) are not unique to ICE vehicle fuel costs. Forsythe, et al. (2023) estimate a willingness to pay for a one cent per mile reduction in operating costs for car drivers of about \$1,960, and slightly less for SUV buyers at about \$1,490. (C. R. Forsythe, et al. 2023b) Based on these results, it appears possible that automakers operate under a different perception of consumer willingness to pay for additional fuel economy than how consumers actually behave. Consumer response to fuel savings, and the amount of fuel savings considered in the purchase decision, may be different with electric vehicles and in an era of high PEV sales.

Chapter 4.1 above describes how OMEGA incorporates fuel costs into the vehicle technology choice component of consumer purchase decisions. OMEGA also incorporates fuel cost savings into the consumers decision to buy a vehicle and in the producer assumptions. Specifically, we assume producers account for 2.5 years of consumer fuel consumption. To do this, OMEGA calculates an estimate of the energy consumption (gallons of fuel and/or kWh of electricity) over a user-specified number of years (we assume 2.5), using EIA Annual Energy Outlook projections

---

<sup>99</sup> The demand elasticity is the percent change in quantity associated with a one percent increase in price. For price, we use net price, where net price is the difference in technology costs less an estimate of the change in fuel costs over the number of years we assume fuel costs are taken into account. We also reduce BEV prices in all scenarios, including the No Action case, due to the IRA BEV purchase and battery tax incentives.

<sup>100</sup> We calibrate the sales in OMEGA that would take place in the absence of the standards to data from the U.S. Energy Information Administration.

of fuel and electricity cost, and the expected vehicle miles traveled per year (VMT). The same energy costs and expected VMT are then used to calculate energy consumption in the final rule and alternative scenarios for the same user-specified number of years.

#### 4.4.1.2 Elasticity of Demand

By definition, the new vehicle demand elasticity relates the percent change in new vehicle price to the percent change in new vehicle sales:

$$\eta = \frac{\Delta Q/Q}{\Delta P/P}$$

Where  $\eta$  is the demand elasticity,  $Q$  is the quantity of new vehicles sold in the analysis context,<sup>101</sup>  $P$  is the net price in the analysis, and  $\Delta$  refers to the change in the values between the analysis context and the non-context sessions. Rearranging this equation produces the sales effect:

$$\Delta Q = \eta * Q * \Delta P/P$$

For this rulemaking, the analysis context sales ( $Q$ ) are defined by EIA's AEO projections, which include the effects of the 2021 rule's GHG standards, but not the IRA. Net price, ( $P$ ) is the sum of the average vehicle purchase price plus the fuel costs considered in the consumer's purchase decision. Fuel costs in the price estimate account for 2.5 years of fuel consumption, where "fuel" includes liquid fuels and/or electricity, assuming 15,000 miles of driving per year.<sup>102</sup> The change in net price ( $\Delta P$ ) is the difference between new vehicle net price under the EIA projection (the analysis context) ( $P$ ), and the net price under the non-context scenarios. For this rulemaking all non-context scenarios include the effects the IRA.

For durable goods, such as vehicles, people are generally expected to have more flexibility about when they purchase new vehicles than whether they purchase new vehicles; thus, their behavior is more inflexible (less elastic) in the long run than in the short run. For this reason, estimates for long-term elasticities for durable goods are expected to be smaller (in absolute value) than short-run elasticities. At a market level, short-run responses typically focus entirely on the new-vehicle market; longer time spans allow for adjustments between the new and used vehicle markets, and even adjustments outside those markets, such as with public transit. Because this rule has effects over time and could have effects related to the used vehicle market, long-run elasticities that account for effects in the used vehicle market are more appropriate for estimating the impacts of standards in the new vehicle market than short-run elasticities.

Continuing the approach used in the final 2021 rule, EPA is using a demand elasticity of -0.4 for LD vehicles based on an EPA peer reviewed report (U.S. EPA 2021). However, as noted in EPA's report, -0.4 appears to be the largest estimate (in absolute value) for a long-run new vehicle demand elasticity in recent studies. EPA's report examining the relationship between

---

<sup>101</sup> For more information on the analysis context, see RIA Chapter 8. Information on the AEO projections mentioned in this section is also included in RIA Chapter 8.

<sup>102</sup> We note that 2.5 years of fuel consumption may be a conservative estimate. A higher value would incorporate more fuel savings into the decision process. As a point of comparison, Tesla, use an estimate of 3 years of gas savings in their estimates of financing a leased vehicle: <https://www.tesla.com/model3/design#overview>

new and used vehicle markets shows that, for plausible values reflecting that interaction, the new vehicle demand elasticity varies from -0.15 to -0.4. A smaller elasticity does not change the direction of sales effects, but it does reduce the magnitude of the effects. Using the value of -0.4 is conservative, as the larger estimate yields a larger change in sales.

The literature used to estimate this elasticity measure is focused on light-duty vehicles, which are primarily purchased and used as personal vehicles by individuals and households. The medium-duty vehicle market, in contrast, largely serves commercial applications. The assumptions in our analysis of the LD sales response are specific to that market, and do not necessarily carry over to the MD vehicle market. Though there are not many studies focused on what affects purchase decisions of medium-duty, or commercial, vehicle buyers, especially in the US, there are many articles discussing the importance of fuel efficiency, warranty considerations, maintenance cost, and replacement part availability in choosing which commercial vehicle to buy.<sup>103</sup> In addition, a working paper published by Resources for the Future reports that commercial vehicle buyers are not sensitive to fuel price changes, likely due to specialized vehicle needs. (Leard, McConnell and Zhou 2017) For this rule, we are assuming an elasticity of 0 for the MD vehicle sales impacts estimates and we are not projecting any differences in the number of MD vehicles sold between the No Action and the final standards, or the more and less stringent scenarios. This implicitly assumes that the buyers of MD vehicles are not going to change purchase decisions if the price of the vehicle changes, all else equal. In other words, as long as the characteristics of the vehicle do not change, commercial buyers will still purchase the vehicle that fits their needs. The rest of this chapter focuses on the LD vehicle market.

#### **4.4.2 New LD Vehicle Sales Estimates**

For this rule, EPA is maintaining the previous assumptions of 2.5 years of fuel savings and a new LD vehicle demand elasticity of -0.4 for its modeling. Table 4-27 shows results for total new LD vehicle sales impacts due to the final standards. There is a very small change in total new LD vehicle sales projected in the final standards compared to the No Action case. Sales by between about 0.18 percent in 2027 and 0.92 percent in 2032. These impacts are generally smaller than those estimated for the 2021 rulemaking (U.S. EPA 2021), where sales impacts were estimated to range from a decrease of about 1 percent in MY 2027 to a decrease of 0.9 percent in MY 2032.

---

<sup>103</sup> See, for example: <https://www.fleetmaintenance.com/equipment/chassis-body-and-cab/article/21136479/considerations-for-purchasing-new-and-used-trucks> ; <https://www.automotive-fleet.com/159336/10-factors-driving-commercial-fleet-vehicle-acquisitions> ; <https://www.mwsmag.com/commercial-vehicle-demand-is-rising-and-so-are-prices/> . These webpages are saved to the docket for this rule.

**Table 4-27: LD sales impacts in the final rule.**

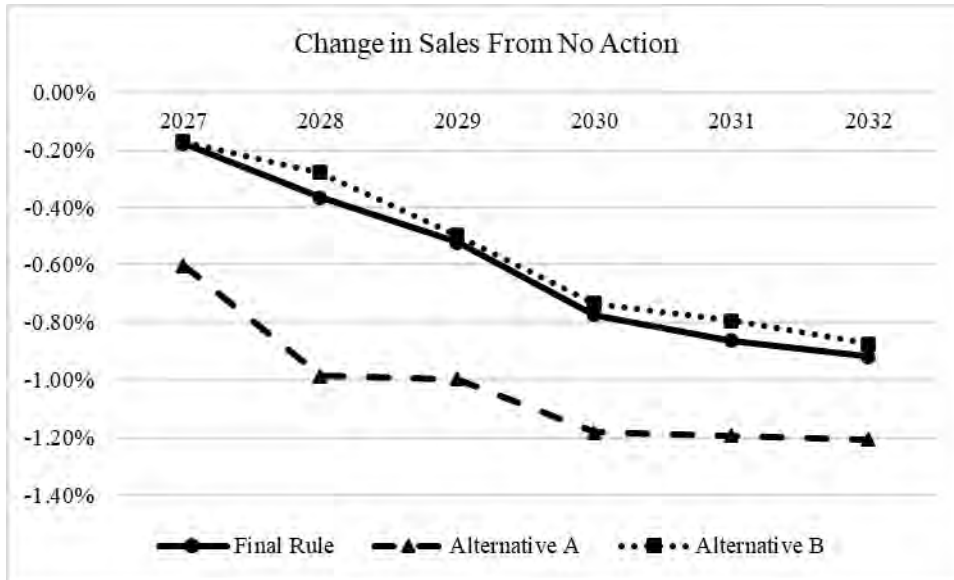
| Year | No Action   | Final Standards |                           |
|------|-------------|-----------------|---------------------------|
|      | Total Sales | Total Sales     | Change from No Action (%) |
| 2027 | 16,046,000  | 16,017,000      | -29,000<br>(-0.18%)       |
| 2028 | 15,848,000  | 15,790,000      | -58,000<br>(-0.37%)       |
| 2029 | 15,923,000  | 15,840,000      | -83,000<br>(-0.52%)       |
| 2030 | 15,792,000  | 15,670,000      | -122,000<br>(-0.78%)      |
| 2031 | 15,669,000  | 15,534,000      | -135,000<br>(-0.86%)      |
| 2032 | 15,585,000  | 15,442,000      | -143,000<br>(-0.92%)      |

Table 4-28 shows results for new LD sales impacts under the more and less stringent options analyzed in support of the final rule, as described in Preamble Section III.F. The results under the more stringent alternative, Alternative A, project decreasing sales in all 6 years compared to the No Action case, with impacts under Alternative A being larger than those estimated for the Final standards, ranging from about -0.6 percent to about -1.2%. The less stringent alternative, Alternative B, shows similar results as the final rule, though they are slightly smaller in all years.

**Table 4-28: LD sales impacts in the alternative scenarios.**

| Year | Alternative A |                           | Alternative B |                           |
|------|---------------|---------------------------|---------------|---------------------------|
|      | Total Sales   | Change from No Action (%) | Total Sales   | Change from No Action (%) |
| 2027 | 15,949,000    | -97,000<br>(-0.60%)       | 16,019,000    | -28,000<br>(-0.17%)       |
| 2028 | 15,692,000    | -156,000<br>(-0.99%)      | 15,804,000    | -44,000<br>(-0.28%)       |
| 2029 | 15,765,000    | -159,000<br>(-1.0%)       | 15,844,000    | -79,000<br>(-0.50%)       |
| 2030 | 15,605,000    | -187,000<br>(-1.2%)       | 15,676,000    | -116,000<br>(-0.73%)      |
| 2031 | 15,482,000    | -187,000<br>(-1.2%)       | 15,544,000    | -125,000<br>(-0.79%)      |
| 2032 | 15,397,000    | -188,000<br>(-1.2%)       | 15,449,000    | -136,000<br>(-0.87%)      |

As an alternative representation of results, Figure 4-9 shows the percent change in total new LD vehicle sales compared to the No Action case for the final standards and the two alternative scenarios.



**Figure 4-9: Total new LD vehicle sales impacts, percent change from the No Action case.**

The results discussed here focus on sales of new LD vehicles, which does affect the total size and make-up of the onroad fleet over time.<sup>104</sup> The analysis for the effects of this rule include the effects of the total onroad fleet. In addition to the new vehicles sold, the onroad fleet may include vehicles from the legacy fleet (vehicles on the road before MY 2023), and re-registered vehicles from the analysis fleet, not including the new vehicles sold in the year being analyzed. The analysis fleet is made up of the vehicles entering the fleet starting in MY 2023, and are a result of OMEGA estimates of the new vehicle sales impacts resulting from the policy in any given scenario. For example, the onroad fleet for MY 2030 will include the reregistered vehicles from the legacy fleet, as well as the reregistered analysis fleet vehicles from MY 2023 through MY 2029, and the new vehicles sold in MY 2030. Re-registered vehicles are used vehicles that remain on the road and are registered for onroad use for that year. This is the flip side to scrappage, which estimates the vehicles that are taken out of the total onroad fleet.<sup>105</sup>

Fleet size is normalized to AEO projections, so our fleet size does not change across scenarios. Reregistered vehicles are aged out according to static estimates based on mileage and vehicle age as presented in Chapter 8.3 of the RIA. As new vehicle sales change, the remaining onroad fleet is adjusted to ensure that the fleet remains at AEO projections. Those reregistered vehicles then accumulate miles according to static estimates based on age. As most of our effects are estimated as a result of VMT, this process is done through normalizing the VMT of the onroad fleet, this means that, with respect to the used vehicle market, OMEGA does not directly model delayed scrappage but does so indirectly through estimated VMT for the reregistered fleet.

<sup>104</sup> The onroad fleet consists of the total count and types of vehicles on the road, and their characteristics including transmission type and age.

<sup>105</sup> Note that we understand that consumers may choose between buying a new vehicle, and, for example, keeping their current vehicle longer, buying a used vehicle or not entering the vehicle market. Our modeling accounts for either purchasing a new vehicle or not, which lumps all other options into one category. For more information on consumer choice, see Section 13 of the RTC.

As the new vehicle sales fall, OMEGA adjusts the VMT of the existing vehicles to normalize the fleet to the AEO projections, which in effect, leads to higher VMT for those existing vehicles. More information on the fleet turnover response can be found in Section 12.1.3 of the RTC.

## **4.5 Employment**

This chapter discusses potential employment impacts due to this rule and presents rough estimates that reflect a portion of those estimates. The rule primarily affects LD and MD vehicles, suggesting that there may be employment effects in the motor vehicle and parts sectors due to expected effects of the standards on sales. Thus, we focus our assessment on the motor vehicle manufacturing and the motor vehicle parts manufacturing sectors, with some assessment of impacts on additional closely related sectors likely to be most affected by the standards.

When the U.S. economy is at full employment, even a large-scale environmental regulation is unlikely to have a noticeable impact on aggregate net employment. Over the long run, environmental regulation is expected to cause a shift of employment among employers rather than affect the general employment level (Arrow et al. 1996; Hafstead and Williams, 2020). The expectation is that labor would be reallocated from one productive use to another, as workers transition away from jobs that are less environmentally protective and toward jobs that are more environmentally protective. Affected sectors may nevertheless experience transitory effects as workers move in and/or out of jobs. Some workers may retrain or relocate in anticipation of new requirements or require time to search for new jobs, while shortages in some sectors or regions could bid up wages to attract workers. These adjustment costs can lead to local labor disruptions. Even if the net change in the national workforce is small, localized reductions in employment may adversely impact individuals and communities just as localized increases may have positive impacts. If the economy is operating at less than full employment, economic theory does not clearly indicate the direction or magnitude of the net impact of environmental regulation on employment; it could cause either a short-run net increase or short-run net decrease as discussed further below.

Chapter 4.5.1 offers a brief, high-level explanation of employment impacts due to environmental regulation and discusses a selection of the peer-reviewed literature on this topic. Chapter 4.5.2 focuses on potential impacts from growing electrification, and Chapter 4.5.3 qualitatively discusses possible employment impacts of this rule on regulated industries. Chapter 4.5.4 presents a quantitative estimate of partial employment impacts that may occur due to this rule. In previous rules, we have quantitatively estimated a cost effect, which should be estimated holding vehicle sales constant. However, the cost estimates come from OMEGA, which estimates the costs of the rule inclusive of the effects of changes in vehicles sold. Therefore, the quantitative partial employment analysis for this rule is a combined cost and demand effect. Chapter 4.5.5 qualitatively discusses potential impacts on related sectors.

### **4.5.1 Background and Literature**

Economic theory of labor demand indicates that employers affected by environmental regulation may change their demand for different types of labor in different ways. They may increase their demand for some types, decrease demand for other types, or maintain demand for still other types. The uncertain direction of labor impacts is due to the different channels by which regulations affect labor demand. A variety of conditions can affect employment impacts of environmental regulation, including baseline labor market conditions, employer and worker

characteristics, industry, and region. In general, the employment effects of environmental regulation are difficult to disentangle from other economic changes (especially the state of the macroeconomy) and business decisions that affect employment, both over time and across regions and industries. In light of these difficulties, we look to economic theory to provide a constructive framework for approaching these assessments and for better understanding the inherent complexities in such assessments.

In this chapter, we describe three ways employment at the firm level might be affected by changes in a firm's production costs due to environmental regulation: a demand effect, caused by higher production costs increasing market prices and decreasing demand; a cost effect, caused by additional environmental protection costs leading regulated firms to increase their use of inputs, including labor, to produce the same level of output; and a factor shift effect, in which post-regulation production technologies may have different labor intensities than their pre-regulation counterparts. These effects are outlined in a paper by Morgenstern et al., which provides the theoretical foundation for EPA's analysis of the impacts of this regulation on labor (Morgenstern, Pizer and Shih 2002). Due to data limitations, EPA is not quantifying the impacts of the final regulation on firm-level employment for affected companies. Instead, we discuss demand, cost, and factor-shift employment effects for the regulated sector at the industry level.

Additional papers approach employment effects through similar frameworks. Berman and Bui model two components that drive changes in firm-level labor demand: output effects and substitution effects (Berman and Bui 2001).<sup>106</sup> Deschênes describes environmental regulations as requiring additional capital equipment for pollution abatement that does not increase labor productivity (Deschenes 2018). For an overview of the neoclassical theory of production and factor demand, see Chapter 9 of Layard and Walters' *Microeconomic Theory* (Layard and Walters 1978). Ehrenberg and Smith describe how at the industry level, labor demand is more likely to be responsive to regulatory costs if: (1) the elasticity of labor demand is high relative to the elasticity of labor supply, and (2) labor costs are a large share of total production costs (Ehrenberg and Smith 2000).

Arrow et al. state that, in the long run, environmental regulation is expected to cause a shift of employment among employers rather than affect the general employment level (Arrow, et al. 1996). Even if they are mitigated by long-run market adjustments to full employment, many regulatory actions have transitional effects in the short run (Smith 2015) (U.S. OMB 2015). These movements of workers in and out of jobs in response to environmental regulation are potentially important distributional impacts of interest to policy makers. Of particular concern are transitional job losses experienced by workers who might not readily find new work. This might include workers who have skills that do not transfer easily to other industries, or who operate in declining industries, exhibit low migration rates, or live in communities or regions where unemployment rates are high.

Workers affected by changes in labor demand due to regulation may experience a variety of impacts including job gains or involuntary job loss and unemployment. Compliance with environmental regulation can result in increased demand for the inputs or factors (including labor) used in the production of environmental protection. However, the regulated sector

---

<sup>106</sup> Berman and Bui (2001) also discuss a third component, the impact of regulation on factor prices, but conclude that this effect is unlikely to be important for large competitive factor markets, such as labor and capital.

generally relies on revenues generated by their other market outputs to cover the costs of supplying increased environmental quality, which can lead to reduced demand for labor and other factors of production used to produce the market output. Workforce adjustments in response to decreases in labor demand can be costly to firms as well as workers, so employers may choose to adjust their workforce over time through natural attrition or reduced hiring, rather than incur costs associated with job separations (see, for instance, Curtis (Curtis 2018) and Hafstead and Williams (Hafstead and Williams III 2018)).

As suggested in this discussion, the overall employment effects of environmental regulation are difficult to estimate. Estimation is difficult due to the multitude of small changes that occur in different sectors related to the regulated industry, both upstream and downstream, or in sectors producing substitute or complimentary products. Consequently, employment impacts are hard to disentangle from other economic changes and business decisions that affect employment, over time and across regions and industries. See Section VIII.I.1 of the preamble for more information and background on employment effects.

#### **4.5.2 Potential Employment Impacts from the Increasing Penetration of Electric Vehicles**

In addition to the employment effects we have discussed in previous rules (for example the 2021 rule), the increasing penetration of electric vehicles in the market is likely to affect both the number and the nature of employment in the auto and parts sectors and related sectors, such as providers of battery charging infrastructure. Over time, as BEVs become a greater portion of the new vehicle fleet, the kinds of jobs in auto manufacturing are expected to change. For instance, there will be no need for engine and exhaust system assembly for BEVs, while many assembly tasks will involve electrical rather than mechanical fitting. In addition, batteries represent a significant portion of the manufacturing content of an electrified vehicle, and some automakers are likely to purchase the cells, if not pre-assembled modules or packs, from suppliers whose employment will thereby be affected. Employment in building and maintaining battery charging infrastructure needed to support the ever-increasing number of BEVs on the road is also expected to affect the nature of employment in automotive and related sectors. For much of these effects, there is considerable uncertainty in the data to quantitatively assess how employment might change as a function of the increased electrification expected to result under the standards. Some suggest that fewer workers will be needed because BEVs have fewer moving parts (Krisher and Seewer 2021), while others estimate that the labor-hours involved in BEVs is almost identical to that for ICE vehicles (Kupper, et al. 2020).

Prior analyses of potential employment effects from electrification in the auto sector conducted outside of EPA have estimated a range of impacts. Results from California's ACC II program analysis seem to suggest that there may be a small decrease, not exceeding 0.3 percent of baseline California employment in any year, in total employment across all industries in CA through 2040 (California Air Resources Board 2022). A report by the Economic Policy Institute suggests that U.S. employment in the auto sector could increase if the share of vehicles, or powertrains, sold in the U.S. that are produced in the U.S. increases. The BlueGreen Alliance also states that though BEVs have fewer parts than their ICE counterparts, there is potential for job growth in electric vehicle component manufacturing, including batteries, electric motors, regenerative braking systems, and semiconductors, and manufacturing those components in the U.S. can lead to an increase in jobs in that sector (BlueGreen Alliance 2021). They go on to state



that if the U.S. does not become a major producer for these components, there is risk of eventual job loss.

The UAW states that re-training programs will be needed to support auto workers in a market with an increasing share of electric vehicles in order to prepare workers that might be displaced by the shift to new technologies (UAW 2020). Volkswagen states that labor requirements for ICE vehicles are about 70% higher than their electric counterparts, but these changes in employment intensities in vehicle manufacturing may be offset by shifting to the production of new components, for example batteries or battery cells (Herrmenn, et al. 2020).<sup>107</sup> As discussed in Section VIII.I.1 of the preamble, investments in the EV sector, including in battery manufacturing and supply chains, is already happening. For example, Volkswagen announced it will start construction of a new electric vehicle battery gigafactory supporting up to 3,000 direct jobs in Canada, as well as supporting a new EV manufacturing plant in South Carolina. (Collins 2023) (Dr. Ernst 2023) Research from the Seattle Jobs Initiative indicates that employment in a collection of sectors related to both BEV and ICE vehicle manufacturing is expected to grow slightly through 2029 (Seattle Jobs Initiative 2020). Climate Nexus also indicates that transitioning to electric vehicles will lead to a net increase in jobs in the automotive and related sectors, a claim that is partially supported by the rising investment in batteries, vehicle manufacturing, and charging stations (Climate Nexus 2022).

This expected investment is also supported by recent Federal actions such as the BIL, the CHIPS Act, and the IRA, all of which will allow for increased investment along the vehicle supply chain, including domestic critical minerals, materials processing, battery manufacturing, charging infrastructure, and vehicle assembly and vehicle component manufacturing. The BIL was signed in November 2021 and provides over \$24 billion in investment in electric vehicle chargers, critical minerals, and battery components needed by domestic manufacturers of EV batteries and for clean transit and school buses. (Infrastructure Investment and Jobs Act 2021).<sup>108</sup> The CHIPS Act, signed in August 2022, invests in expanding America's manufacturing capacity for the semiconductors used in electric vehicles and chargers (CHIPS Act of 2022 2022).<sup>109</sup> The IRA provides incentives for producers to expand domestic manufacturing of BEVs and domestic sourcing of components and critical minerals needed to produce them (117th Cong. 2022). The IRA also provides incentives for consumers to purchase both new and used ZEVs. These laws create domestic employment opportunities along the full automotive sector supply chain, from components and equipment manufacturing and processing to final assembly, as well as incentivize the development of reliable EV battery supply chains, as discussed in Section VI.I.1

---

<sup>107</sup> We also note that, as discussed in Sections VI.I.1 and VI.I.4 of the preamble, and RIA Chapter 4.5.5, skill sets for ICE workers are similar to those in the EV sector and other non-automotive sectors.

<sup>108</sup> The Bipartisan Infrastructure Law is officially titled the Infrastructure Investment and Jobs Act. More information can be found at <https://www.fhwa.dot.gov/bipartisan-infrastructure-law/>

<sup>109</sup> The CHIPS and Science Act was signed by President Biden in August 2022 to boost investment in, and manufacturing of, semiconductors in the U.S. The fact sheet can be found at <https://www.whitehouse.gov/briefing-room/statements-releases/2022/08/09/fact-sheet-chips-and-science-act-will-lower-costs-create-jobs-strengthen-supply-chains-and-counter-china/>

of the preamble.<sup>110</sup> The BlueGreen Alliance and PERI estimate that IRA will create over 9 million jobs over the next decade, with about 400,000 of those jobs being attributed directly to the battery and fuel cell vehicle provisions in the act (Political Economy Research Institute 2022). Additional studies find similar results: the IRA and BIL have the potential to lead to significant job increases in transportation, electricity, and manufacturing, with some estimates of almost 700,000 new jobs through 2030. EDF reports that more than 46,000 jobs in EV manufacturing have already been announced since the passage of the IRA.

The U.S. Bureau of Labor Statistics (BLS) identified three key occupational areas they expect to be affected by growth in the BEV market: the design and development of EV models, the production of batteries, and installation and maintenance of charging infrastructure. The article estimates changes in key occupations employed in those sectors between 2021 and 2031 (Colato and Ice 2023). The authors note that though it is expected that the occupations outlined in the article will be significant in BEV production and deployment, they include estimates of the total employment change for each occupation across all sectors, not just those related to BEV production and deployment. For example, the estimates for the change in employment of construction laborers is the effect from all construction sectors, not just those related to the construction of BEV charging infrastructure. In the report, BLS estimated employment changes related to occupations employed in the design and development of electric vehicles, including software developers, electrical engineers, electronics engineers, and chemical engineers; battery manufacturing, including electrical, electronic and electromechanical assemblers, and miscellaneous assemblers and fabricators; and charging network development and maintenance, including urban and regional planners, electrical, electrical power-line installers and repairers, and construction laborers. With the exception of the sector miscellaneous assemblers and fabricators, BLS forecast an increase in employment in these occupational areas, with the smallest increase, in percentages, being 1.6 percent (electrical engineers), and the largest increase (software developers) being 26 percent.<sup>111</sup> BLS states that though total employment in the miscellaneous assemblers and fabricators sector is projected to fall, they do expect a number of job openings in the sector each year in order to replace workers who transfer to different occupations or exit the work force. Again, it is difficult to separate out the effect that the increase in BEV production will have on these sectors from the macroeconomic effects, or the effects from non-BEV related production activity.

#### **4.5.3 Potential Employment Impacts of the Standards**

Even with expected increases in employment in component production and new domestic jobs related to ZEVs, shifts in production may negatively affect workers currently employed in production of ICE vehicles. We acknowledge the possibility of geographically localized effects, and that there may be job quality impacts associated with this rule, especially in the short term. We note that there are Federal programs to assist workers in the transition to low or zero emitting vehicles, including a DOE funding package which makes \$2 billion in grants, and up to \$10

---

<sup>110</sup> More information on how these acts are expected to aid employment growth and create opportunities for growth along the supply chain can be found in the January 2023 White House publication "Building a Clean Energy Economy: A Guidebook to the Inflation Reduction Act's Investments in Clean Energy and Climate Action." found online at <https://www.whitehouse.gov/wp-content/uploads/2022/12/Inflation-Reduction-Act-Guidebook.pdf>

<sup>111</sup> The urban and regional planners sector is forecast to have the smaller increase in number of employees, with an increase of about 1,600 employees between 2021 and 2031.

billion in loans available to support projects converting existing automotive manufacturing facilities to support electric vehicle production.<sup>112</sup> The funding package is expected to result in retention of high-quality, high-paying jobs in communities that currently host these manufacturing facilities, and along the full supply chain for the automotive sector, from components to assembly. The grants available give priority to refurbishing and retooling manufacturing facilities, especially for those likely to retain collective bargaining agreements and/or an existing higher-quality, high-wage hourly production workforce. (U.S. Department of Energy Office of Manufacturing and Energy 2024) DOE has also announced funding to support clean energy supply chains, with the funding going toward projects to support domestic clean energy manufacturing (including projects supporting battery production) in, or near, nine communities that were formerly tied to coal mining, and are expected to create almost 1,500 jobs. (EnergyTech 2023) We also note that during, and after, the comment period, several major U.S. automakers were negotiating new labor contracts, with an emphasis on workers in facilities that support the production of electrified vehicles, with the results including increased wages and abilities for workers to join the union.

However, there is no data to estimate current or future job quality. Nor are we able to determine the future location of vehicle manufacturing and supporting industries beyond the public announcements made as of the publication of this rule. We note that, compared to the proposal, we are finalizing standards that extend flexibilities and provide a slower increase in the stringency of the standards in the early years of the program. The more gradual shift allows for a more moderate pace in the industry's scale up to the battery supply chain and manufacturing, which in turn should help to reduce any potential impacts in employment across all sectors impacted by this rule. For example, employers may choose to reduce hiring early on to avoid the need to reduce their workforce later. In addition, as illustrated by the alternative pathway analyses shown in Section IV.F and IV.G of the preamble and Chapter 12 of the RIA, there are multiple ways OEMs can choose to meet the standards, including through a wide range of BEV and PHEV technologies, and all of these pathways continue to provide ICE vehicles to the market. In addition, as explained above, in Section VIII.I.1 of the preamble and Section 20 of the RTC, there are many programs and initiatives focused on training, retraining, and community-level impacts; there is a wide range of ICE automotive jobs with similar skill sets to those in EV automotive production and in other industries, and infrastructure work is and will continue to be a nation-wide effort.

Shifts in PEV production associated with the final rule may lead to employment shifts with positive impacts on affected workers. A BLS report (Hamilton 2011)<sup>113</sup> provides detailed descriptions of occupations employed in EV production.

Because of a variety of significant unknowns and challenges, including the state of the macroeconomy when these standards become effective, the changes to auto manufacturing employment due to increased production of electric vehicles, and the difficulties of modeling impacts on employment in a complex national economy, we focus our employment impacts analysis on the direct impacts on labor demand in closely affected sectors. In the next sections,

---

<sup>112</sup> <https://www.energy.gov/articles/biden-harris-administration-announces-155-billion-support-strong-and-just-transition>

<sup>113</sup> See [https://www.bls.gov/green/electric\\_vehicles/electric\\_vehicles.pdf](https://www.bls.gov/green/electric_vehicles/electric_vehicles.pdf)

we discuss potential impacts of the rule on industry-level demand for labor. We qualitatively describe the employment impacts due to the factor shift, demand, and cost effects on labor demand, following the structure of Morgenstern et al., as described above. Then we present a quantitative estimate of partial incremental employment effects of the standards, and conclude with a discussion of possible employment impacts on related sectors.

As discussed in RTC Section 20 and Section VIII.I.1 of the preamble, there are many existing and planned projects focused on training new and existing employees in fields related to green jobs, and specifically green jobs associated with electric vehicle production, maintenance and repair, and the associated charging infrastructure. This includes work by the Joint Office of Energy and Transportation (JOET), created by the BIL, which supports efforts related to deploying infrastructure, chargers and zero emission vehicles.<sup>114</sup> One example of a project from the JOET is the Ride and Drive grant program, which targets investments in EV charging resiliency, community-driven workforce development, and EV charging performance and reliability. Another example is the Battery Workforce Initiative established by the Department of Energy (DOE) in coordination with the Department of Labor (DOL), AFL-CIO, and other organizations with the goal of accelerating the development of high-quality training. DOL has also established the Building Pathways to Infrastructure Jobs Grant Program, which support worker-centered sector strategy training programs. DOL also provides grants to help community colleges provide skilled pathways to good jobs in the transportation and clean energy sectors. DOL is also providing technical assistance to the Southeast EV Collaborative, which is made up of a collection of state workforce agencies in the southeast region of the U.S. focused on identifying opportunities to work together to provide equitable access to good jobs across the region.

#### **4.5.3.1 The Factor Shift Effect**

The factor shift effect reflects employment changes due to changes in labor intensity of production by regulated entities resulting from compliance activities. Holding vehicle sales constant, a factor shift effect of this rule might occur if this regulation affects the labor intensity of production of ICE vehicles, though we do not have data on how the regulation might affect labor intensity of production within ICE vehicle production. It may also occur if PEV production does not have the same labor intensity as ICE vehicle production and, holding vehicle sales constant, the share of PEV and ICE vehicles changes. There is ongoing research on the different labor intensity of production between ICE and BEV production, with inconsistent results. Some research indicates that the labor hours needed to produce a BEV are fewer than those needed to produce an ICE vehicle, while other research indicates there are no real differences.

EPA worked with a research group, FEV, to produce a peer-reviewed tear-down study of a BEV (Volkswagen ID.4) to its comparable ICE vehicle counterpart (Volkswagen Tiguan).<sup>115</sup> Peer reviewed study results were delivered in May 2023. Included in this study are estimates of labor intensity needed to produce each vehicle under three different assumptions of vertical integration of manufacturing scenarios ranging from a scenario where most of the assemblies and components are sourced from outside suppliers to a scenario where most of the assemblies and

---

<sup>114</sup> More information on these programs, and other programs, can be found in the memo Labor/Employment Initiatives in the Battery/Vehicle Electrification Space located in the docket for this rule.

<sup>115</sup> See RIA Chapter 2.5.2.2.3 for more information.

components are assembled in house. Under the low and moderate levels of vertical integration, results indicate that assembly time of the BEV at the plant is reduced compared to assembly time of the ICE vehicle.<sup>116</sup> Under a scenario of high vertical integration, which includes the BEV battery assembly, results show an increase in time needed to assemble the BEV. When powertrain systems are ignored (battery, drive units, transmission, and engine assembly), the BEV requires more time to assemble under all three vertical integration scenarios. The results indicate that the largest difference in assembly comes from the building of the battery pack assembly. When the battery cells are built in-house, the BEV will require more labor hours to build at the assembly plant. These results also indicate that if the labor input to manufacture batteries is included in the estimated labor needs to build a BEV, regardless of the vertical integration decisions to build batteries in-house, BEVs will require more labor to build. For more information on this study, see Chapter 2.5.2.2.3. For information on the early indications of labor differences, including intensity, in ICE and BEV production, see Chapter 4.5.4.

Data on the labor intensity of PHEV production compared to ICE vehicle production is also very sparse. PHEVs share features with both ICE vehicles, including engines and exhaust assemblies, and BEVs, including motors and batteries. If labor is a function of the number of components, PHEVs might have a higher labor intensity of production compared to both BEV and ICE vehicles, and if they are produced in the U.S. may provide labor demand. The labor needs of battery production are also a factor of the total labor needs to build a PHEV.

Given the current lack of data and inconsistency in the existing literature, we are unable to estimate a quantitative factor-shift effect of increasing relative PEV production as a function of this rule. However, we can say, generally, that research indicates that if production of PEVs and their power supplies are done in the U.S. at the same rates as ICE vehicles, we do not expect employment to fall, and it may likely increase. Electric vehicle manufacturing plants and battery plants are being announced and built in the U.S., as discussed in Section IV of the preamble. In addition, as discussed in Section VIII.I.2 of the preamble, states are making efforts to support increasing domestic production of electric vehicles and batteries, including support for the workforce. South Carolina is focused on exploring opportunities related to electric vehicle and automotive manufacturers,<sup>117</sup> Ohio estimates more than 25,000 new jobs in EV manufacturing and maintenance, battery development, and charging station installation and operations in the state by 2030,<sup>118</sup> California is focused on an equitable ZEV industry,<sup>119</sup> Illinois has invested in EV training, R&D, and workforce development and community support,<sup>120</sup> Nevada is focused on workforce and economic development supporting the lithium industry,<sup>121</sup> Kentucky is providing

---

<sup>116</sup> In the FEV report, "assembly time" is the time (in hours) it takes to assemble the vehicle from the component parts.

<sup>117</sup> SCpowersEV: State support - Driving the Future, <https://scpowersev.com/state-support>.

<sup>118</sup> Accelerating Ohio's Auto & Advanced Mobility Workforce, Auto and Advanced Mobility Workforce Strategy, 2023. <https://workforce.ohio.gov/wps/wcm/connect/gov/2e9f6e52-a4bc-4ef6-9080-e6b06f067a1a/Ohio%27s+Electric+Vehicle+Workforce+Strategy.pdf?MOD=AJPERES>.

<sup>119</sup> California Workforce Development Board, 2021. [https://business.ca.gov/wp-content/uploads/2021/03/CWDB\\_ZEV-Plan.pdf](https://business.ca.gov/wp-content/uploads/2021/03/CWDB_ZEV-Plan.pdf)

<sup>120</sup> Illinois Drive Electric: Abundant Workforce, <https://ev.illinois.gov/grow-your-business/abundant-workforce.html>.

<sup>121</sup> Nevada Battery Coalition: <https://nevadabatterycoalition.com/about/>

resources toward upgrading industrial sites throughout the state,<sup>122</sup> Tennessee is co-locating a new Tennessee College of Applied Technology with a new EV manufacturing facility,<sup>123</sup> Michigan is assisting with tuition and other supportive services for advanced automotive mobility and electrification training.<sup>124,125</sup>

#### **4.5.3.2 The Demand Effect**

Demand effects on employment are due to changes in labor that result from changes in total new vehicle sales. Compliance activities may increase the cost of production, raising market prices and decreasing demand for the regulated industry's output and, holding labor intensity constant, decreasing the regulated industry's demand for labor. This final rule may result in a decrease in total new vehicle sales, suggesting that the demand effect would be a decrease in the demand for labor.

In previous EPA LD regulations, like the 2021 rule, we have used the CAFE model to estimate effects of a change in ICE vehicle demand on labor. The model uses a method of estimating a demand effect on employment through the relationship of hours involved in a new vehicle sale (for the effect on automotive dealers) or average labor hours per vehicle at a sample of US assembly plants (for the effect on the final assembly industry) to the change in the number of vehicles sold due to the regulation. This rule, however, uses EPA's OMEGA model. We currently do not have the data to estimate these effects in OMEGA.

In general, if the regulation causes total sales of new vehicles to decrease, fewer workers will be needed to assemble vehicles and manufacture their components. The demand effect may be different for PHEV, BEV, and ICE vehicles, though, if their labor intensity of production is different. If, for example, BEV vehicles have a lower labor intensity of production than PHEV or ICE, and sales for BEV, PHEV, and ICE vehicles fall by the same amount, the demand effect on labor will be smaller for BEVs than PHEVs or ICE vehicles. Due to lack of data, as discussed in Chapter 4.5.3.1, we are unable to estimate a change in employment due to a change in demand. We note, however, that, as explained in Chapter 4.4.2, sales effects due to this rule are small, and therefore associated demand effects are also likely to be small.

#### **4.5.3.3 The Cost Effect**

The cost effects on employment are due to changes in labor associated with changes in costs of production. Compliance activities may cause production costs to increase, and firms to use more of all inputs, including labor, to produce the same level of output. This may be, in part, due to firms producing environmental protection at the same time as industry output. In general, if a regulation leads firms to invest in lower-emitting vehicles, we expect an increase in the labor used to implement those technologies. In this final rule, as in previous LD and heavy-duty (HD)

---

<sup>122</sup> Kentucky: Leading the Charge, [https://ced.ky.gov/Newsroom/Article/20230816\\_Leading\\_th](https://ced.ky.gov/Newsroom/Article/20230816_Leading_th).

<sup>123</sup> Area Development: Tennessee: A growing Capital of Electric Vehicle Production, <https://www.areadevelopment.com/ContributedContent/Q4-2021/tennessee-growing-capital-of-electric-vehicle-production.shtml>

<sup>124</sup> MI Labor and Economic Opportunity: Electric Vehicle Jobs Academy, <https://www.michigan.gov/leo/bureaus-agencies/wd/industry-business/mobility/electric-vehicle-jobs-academy>.

<sup>125</sup> Michigan Engineering News, \$130M Electric Vehicle Center launches at U-Michigan, <https://news.engin.umich.edu/2023/04/130m-electric-vehicle-center-launches-at-u-michigan/>.

rules, we have estimated partial employment effects due to the change in costs of production, where the change in costs of production are assumed to be the change in technology costs associated with the rule. We use the historic share of labor in the cost of production to extrapolate future estimates of impacts on labor due to compliance activities in response to the regulation. Specifically, we multiplied estimates of the average ratio of labor to the value of output in the regulated industry by the change in production costs estimated as an impact of the rule. This provides a sense of the magnitude of potential impacts on employment, though as explained in more detail in the next paragraph, this estimate is incomplete and limited. As explained further in this chapter, the impacts estimated in this rule are a combined cost and demand effect due to how costs are estimated in OMEGA.

The use of the average ratio of labor to value of output to estimate a cost effect on employment has both advantages and limitations. It is often possible to estimate these ratios for detailed sector definitions, for example, the average number of workers in the automobile and light-duty motor vehicle manufacturing sector per \$1 million spent in that sector, rather than using ratios from more aggregated sectors, such as the motor vehicle manufacturing sector. This avoids extrapolating employment ratios from less closely related sectors. On the other hand, these estimates are averages, covering all the activities in these sectors, and may not be representative of the labor effects when expenditures are required for specific activities, or when manufacturing processes change due to compliance activities in such a way that labor intensity changes. For instance, the ratio of workers to production cost for the motor vehicle body and trailer manufacturing sector represents this ratio for all motor vehicle body and trailer manufacturing activities, and not just for production processes related to emission reductions compliance activities. Another limitation is that the ratios are averaged across firms and do not reflect variability across individual producers. In addition, these estimates do not include changes in industries that supply these sectors, such as steel or electronics producers. The effects estimated with this method can be viewed as effects on employment in the sectors included in the analysis due to the changes in expenditure in that sector, rather than as an assessment of all employment changes due to the standards being analyzed. In addition, labor intensity is held constant in the face of increased expenditures; this approach does not take changes in labor intensity due to changes in the nature of production (the factor shift effect) into account, which could either increase or decrease the employment impacts estimated using this method.

BEVs and ICE vehicles require different inputs and have different costs of production, though there are interchangeable, or common, parts as well. We used a recent report from the Seattle Jobs Initiative, which identified sectors most strongly associated with ICE and BEV automotive production, to determine a list of sectors that may be directly affected by our rule (Seattle Jobs Initiative 2020). NAICS Sectors identified by the Seattle Jobs Initiative as mainly associated with BEV production include Electrical equipment manufacturing and Other electrical equipment and component manufacturing. Sectors identified as related to both EV and ICE manufacturing include Motor vehicle manufacturing, Motor vehicle body and trailer manufacturing, and Motor vehicle parts manufacturing. And a sector identified as only

associated with ICE vehicle manufacturing is Motor vehicle gasoline engine and engine parts manufacturing.<sup>126</sup>

The Employment Requirements Matrix (ERM) provided by the U.S. Bureau of Labor Statistics (BLS) provides direct estimates of the number of employees per \$1 million in sales for 202 aggregated sectors, which roughly correspond to the 4-digit NAICS code level, from 1997 through 2022 (Bureau of Labor Statistics 2023). Figure 4-10 shows the estimates of employment per \$1 million of sales for a set of ERM sectors that generally correspond to the NAICS sectors identified above, adjusted to 2022 dollars using the U.S. Bureau of Economic Analysis Gross Domestic Product Implicit Price Deflator.<sup>127</sup>

The historical data show that over time, the amount of labor needed in the motor vehicle industry has changed: automation and improved methods have led to significant productivity increases. In Figure 4-10, we can see that the workers per \$1 million in sales has, generally, decreased over time, with the exception of Electrical equipment manufacturing and Other electrical equipment and component manufacturing. For instance, in 1997 about 1.2 workers in the Motor vehicle manufacturing sector were needed per \$1 million, but only 0.7 workers by 2022 (in 2022\$).<sup>128</sup> Though two sectors mainly associated with BEV manufacturing, Electrical equipment manufacturing, and Other electrical equipment and component manufacturing, show an increase in recent years.

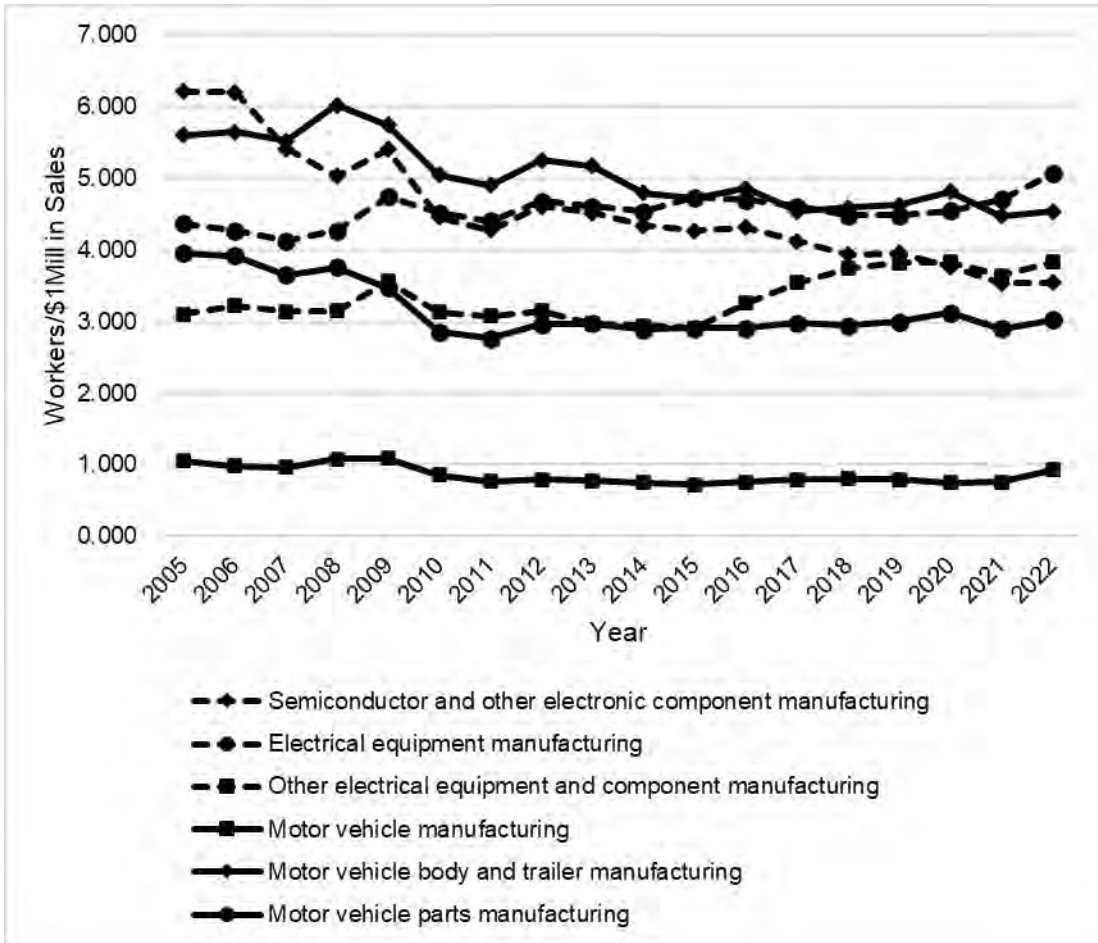
---

<sup>126</sup> The sector Motor vehicle gasoline engine and engine parts manufacturing is a subsector of Motor vehicle parts manufacturing.

<sup>127</sup> The GDP IDP used can be found in the excel file "LMDV\_FRM\_EmploymentImpactsCalculations.xlsx " in the docket.

<sup>128</sup> <https://www.bls.gov/emp/data/emp-requirements.htm>; this analysis used data for the sectors electrical equipment and manufacturing, other electrical equipment and component manufacturing, motor vehicle manufacturing, motor vehicle body and trailer manufacturing, and motor vehicle parts manufacturing from "Chain-weighted (2012 dollars) real domestic employment requirements tables;" see the excel file "LMDV\_FRM\_EmploymentImpactsCalculations.xlsx " in the docket.





**Figure 4-10: Workers per million dollars in sales, adjusted for domestic production.**

**4.5.4 Partial Employment Effects of the Standards**

In previous LD rules, EPA estimated a cost effect on employment holding sales constant, and assuming labor intensity is held constant in the face of increasing expenditures. However, the costs of this rule are estimated in OMEGA, which works iteratively to estimate a vehicle fleet that will meet the regulatory standards, as well as be accepted by consumers. The model estimates this by both changing the number of new vehicles sold, as well as changing the penetration of PHEVs in the market between the No Action and Action cases. Therefore, though the method used, described in Chapter 4.5.3, is the same as that in previous rules, we are unable to estimate a cost employment effect due to this rule while holding sales constant. Therefore, the partial employment analysis presented here is a change in employment due to the change in costs, allowing sales to change as well. In other words, it is a combined cost and demand effect.

We estimate the partial employment effect using the historic share of labor in the cost of production for a set of sectors affected by this rule. We use these historic shares to extrapolate estimates of future shares of labor in the cost of production for each of those sectors. We then multiply the estimated share of labor in the cost of production by the change in production costs estimated as an impact of this rule. This provides a sense of the magnitude of potential impacts

on employment. Some of the advantages and limitations of this method are described above, in Chapter 4.5.3.3.

We rely on three different public sources to estimate a range of employment per \$1 million expenditures: the Economic Census (EC) and the Annual Survey of Manufactures (ASM), both provided by the U.S. Census Bureau, and the Employment Requirements Matrix (ERM) provided by the U.S. Bureau of Labor Statistics (BLS). The EC is conducted every 5 years, most recently in 2022, however because the data is not yet publicly available, we use EC data from 2017.<sup>129</sup> The ASM is an annual subset of the EC and is based on a sample of establishments. The latest set of data from the ASM is from 2021. The EC and ASM have more sectoral detail than the ERM, providing estimates out to the 6-digit North American Industry Classification System (NAICS) code level. They provide separate estimates of the number of employees and the value of shipments, which we convert to a ratio for this employment analysis. The total employment across the NAICS code sectors used in this analysis (see Table 10-6) as reported in the ASM and the EC ranges from about 1,052,500 to about 1,053,800 depending on which data source is used; as noted above the most recent data for ASM and EC are from 2022 and 2017, respectively. The ERM provides direct estimates of employees per \$1 million in expenditures for a total of 202 aggregated sectors that roughly correspond to the 4-digit NAICS code level, and it provides data through 2022.

We estimate cost effects on employment by separating out costs mainly associated with the electrified portions of vehicle production (for example, batteries) and the ICE vehicle portion of production (for example, engines), as well as the costs that are common between them (for example, gliders<sup>130</sup>). We apply the electrified portions of cost changes ("PEV related costs") only to sectors primarily focused on electrified portions of vehicle production, the ICE vehicle portion of costs ("ICE related costs") only to sectors primarily focused on the ICE vehicle portions of production, and the costs common to both the electrified portions and ICE portions of vehicle production ("common costs") to sectors that are common to the electrified and ICE portions of vehicle production.<sup>131</sup> We use the sum of the estimated PEV related costs, ICE related costs, and common costs for both LD and MD vehicles. We used a report from the Seattle Jobs Initiative to identify sectors most strongly associated with the electrified portions of automotive production and the ICE vehicle portions of automotive production, as well as the sectors that are common between them (Seattle Jobs Initiative 2020).

Table 4-29 below shows the sector definitions, NAICS codes, and ERM sector numbers EPA used to estimate employment effects in this analysis. It also provides the estimates of

---

<sup>129</sup> The 2022 Economic Census was conducted starting in January 2023 and initial results will be available starting in March 2024.

<sup>130</sup> In this context, a glider is a vehicle without a powertrain. It includes the body, chassis, interior, and non-propulsion related electrical components.

<sup>131</sup> A report from the Seattle Jobs Initiative examined how electrification in the automotive industry might advance workforce development in Oregon and Washington. As part of that study, the authors identified the sectors classified by the North American Industry Classification System (NAICS) codes most strongly associated with automotive production in general, those exclusive to ICE vehicles, and those primarily associated with electrified portions of vehicle production. The report can be found at:

[https://www.seattle.gov/Documents/Departments/OSE/ClimateDocs/TE/EV%20Field%20in%20OR%20and%20WA\\_February20.pdf](https://www.seattle.gov/Documents/Departments/OSE/ClimateDocs/TE/EV%20Field%20in%20OR%20and%20WA_February20.pdf).

employment per \$1 million of expenditure for each sector for each data source, adjusted to 2022 dollars using the U.S. Bureau of Economic Analysis Gross Domestic Product Implicit Price. The values published in the ERM have been adjusted by BLS to remove the effects of imports. We adjust the values for the ASM and EC to remove effects of imports through the use of a ratio of domestic production to domestic sales of 0.81.<sup>132</sup> While the estimated labor ratios differ across data sources, they are fairly similar, and mainly exhibit a similar pattern across the ICE and common sectors. The ASM and EC exhibit similar orders of most to least intensive across all sectors, though some of the ratios in specific sectors differ across the data sets. However, the order of most labor intensive to least intensive as estimated by the ERM differs. This may be due to the inclusion of additional NAICS sectors within the larger ERM sectors.<sup>133</sup> Within the ASM and EC data, "Other electronic component manufacturing" seems to be the most labor-intensive sector, while ERM indicates "Motor and generator manufacturing" is the most labor-intensive. Automobile and "Light-duty motor vehicle manufacturing" is the least labor-intensive sector across all three data sources.

**Table 4-29: Sectors and associated workers per million dollars in expenditures by source.**

|                               | Sector   | NAICS Code | ERM Sector | Ratio of Workers per \$1 Million Expenditures |                        |            |
|-------------------------------|--|------------|------------|---|------------------------|------------|
|                               |  |            |            | ASM (2018) <sup>a</sup>                       | EC (2017) <sup>a</sup> | ERM (2022) |
| PEV Sectors                   | Other electronic component manufacturing                                 | 334419     | 72         | 3.4   | 4.1                    | 3.5        |
|                               | Motor and generator manufacturing  | 335312     | 77         | 1.9   | 2.8                    | 5.1        |
|                               | Battery manufacturing  | 33591      | 78         | 2.4   | 3.2                    | 3.8        |
|                               | All other miscellaneous electrical equipment and component manufacturing | 335999     | 78         | 2.3   | 3.2                    |            |
| Sectors Common to ICE and BEV | Automobile and light duty motor vehicle manufacturing                    | 33611      | 79         | 0.6   | 0.6                    | 0.9        |
|                               | Motor vehicle body and trailer manufacturing                             | 3362       | 80         | 2.3   | 2.9                    | 4.5        |
|                               | Motor vehicle parts manufacturing (not gasoline engines)                 | 3363*      | 81         | 2.1   | 2.2                    | 3.0        |
|                               | Motor vehicle electrical and electronic equipment manufacturing          | 33632      | 81         | 2.1   | 2.4                    |            |
| ICE Sectors                   | Motor vehicle gasoline engine and engine parts manufacturing             | 33631      | 81         | 1.5   | 1.5                    |            |

<sup>a</sup> Values are adjusted for domestic vs. foreign production.  
\* In our analysis, 3363 excludes estimates for NAICS code 33631. NAICS code 33631 only includes ICE vehicle manufacturing, so we subtract those data out from the main sector, NAICS code 3363, and apply ICE costs to that sub-sector.

Because the ERM is available annually for 1997-2022, we use these data to estimate productivity improvements over time. We estimate a simple regression of the logged ERM values on a year trend for each sector.<sup>134</sup> We use this approach because the resulting coefficient

<sup>132</sup> To estimate the proportion of domestic production affected by the change in sales, we use data from WardsAuto for total car and truck production in the U.S. compared to total car and truck sales in the U.S. Over the period 2012-2022, the proportion averages 84 percent. From 2017-2022, the proportion average is slightly lower, at 81 percent.

<sup>133</sup> ERM sectors are based on the 4-digit level for NAICS code sectors. For example, ERM sector 72, consists of results from manufacturers in NAICS code 3344.

<sup>134</sup> Details and results are found in the file LMDV\_FRM\_EmploymentImpactsCalculations.xlsx, which is in the docket for this rule.

describing the relationship between time and productivity is a direct measure of the average percent change in labor productivity for a given level of output per year. The results shown in Table 4-30 below represent the percent change in the ratio of labor to value of output per year. These productivity changes are all negative, indicating that, for the sectors shown here, fewer workers are needed per \$1 million of output every year. For example, in Motor vehicle parts manufacturing, the ratio falls by 2.5 percent every year. These figures coincide with the historic decline in workers per million dollars in sales as seen in Figure 4-10.

**Table 4-30 Annual change in the ratio of labor to value of output for directly impacted sectors (%).**

| Sector   | ERM Sector Number | Annual % Change |
|--|-------------------|-----------------|
| Other electronic component manufacturing               | 72                | -5.8%           |
| Electrical equipment manufacturing                     | 77                | -0.4%           |
| Other electrical equipment and component manufacturing | 78                | 0.3%            |
| Motor vehicle manufacturing                            | 79                | -2.6%           |
| Motor vehicle body and trailer manufacturing           | 80                | -0.6%           |
| Motor vehicle parts manufacturing                      | 81                | -2.5%           |

We then use those estimated percent improvements in productivity (fall in the ratio of labor to value of output) to project the number of workers per \$1 million of production expenditures through 2032. We emphasize that the estimates provided in Table 4-31 represent an order of magnitude effect, rather than definitive impacts. We calculate separate sets of projections (adjusted to 2022\$) for each set of data (ERM, EC, and ASM) for all sectors described above. The ERM projections are calculated directly from the fitted regression equations used to estimate the projected productivity growth, since the regressions themselves used ERM data. For the ASM and EC projections of the number of workers needed per \$1 million of expenditures (in 2022\$), we apply ERM’s ratio of projected annual productivity growth to the projected production expenditure value in 2021 for the ASM and 2017 for the EC (the base years in our data).<sup>135</sup> In other words, we apply the projected productivity growth estimated using the ERM data to the ASM and EC numbers.

To interpret the results, we compare the projected employment across data sources and report only the maximum and minimum (in absolute value) effects in each year across all sectors.<sup>136</sup> We provide a range rather than a point estimate to emphasize the uncertainty in these estimates. The

---

<sup>135</sup> The ERM data accounts for an adjustment to reflect domestic production. We apply an adjustment factor to the ASM and EC values as described in footnote 132 to remove the effects of imports on the projections from those data sources as well.

<sup>136</sup> To see details, as well as results for all sources, see "LMDV\_FRM\_EmploymentImpactsCalculations.xlsx" in the docket.

reported ranges provide an estimate of the expected magnitude of the effect. The employment effect estimated here includes the costs of this rule for both LD and MD vehicles, as well as the change in new vehicles sales for LD vehicles due to this rule. There are no estimated changes in MD vehicle sales. See Chapter 4.4.2 for more information on the estimates of new vehicle sales effects due to this rule.

For this analysis, we use detailed OMEGA results to get estimates of the costs of manufacturing LD and MD vehicles separated out by costs expected to apply only to the electrified portion of vehicle production, those expected to only apply to the ICE vehicle portion of production, and those expected to apply to all vehicles.<sup>137</sup> These costs (in \$ million) are multiplied by the estimates of workers per \$1 million in costs for each year. Table 4-31 shows the projected estimates of partial employment effects for each year for the three sector groups. The effects are shown in job counts.<sup>138</sup> We show a range of effects, from the smallest to largest (in absolute value) effect for each sector group. Allowing for the estimated change in sales due to the rule, increased technology costs of vehicles and parts is expected to increase employment over the 2027-2032 timeframe for sectors focused on the electrified portion of vehicle production, and the results show a decrease for the ICE focused sectors (except for 2027) and the common sectors.

It should be noted that these results are exclusive of any changes in employment in related sectors, such as charging infrastructure. In addition, while we estimate employment impacts beginning with program implementation, some of these employment gains may occur earlier, for example if vehicle manufacturers and parts suppliers hire staff in anticipation of compliance with the standards, or in anticipation of ramping up PEV production.

**Table 4-31: Estimated partial employment effects for sectors focused on the electrified, ICE and common portions of vehicle production<sup>a</sup>.**

| Year | Common Portions |                | Electrified Portion |                | ICE Portion     |                |
|------|-----------------|----------------|---------------------|----------------|-----------------|----------------|
|      | Smallest Effect | Largest Effect | Smallest Effect     | Largest Effect | Smallest Effect | Largest Effect |
| 2027 | -370            | -3,600         | 3,000               | 6,900          | 2,200           | 2,900          |
| 2028 | -900            | -8,600         | 15,700              | 36,600         | -800            | -1,100         |
| 2029 | -1,300          | -13,000        | 36,800              | 89,100         | -7,600          | -9,800         |
| 2030 | -1,900          | -19,800        | 54,800              | 140,200        | -13,600         | -17,500        |
| 2031 | -2,100          | -22,600        | 67,700              | 182,600        | -18,800         | -24,200        |
| 2032 | -2,600          | -27,700        | 75,100              | 213,900        | -23,200         | -29,900        |

<sup>a</sup> Smallest and largest effects are smallest and largest in absolute value

Table 4-32 shows the maximum combined range for the estimated change in employment across all sectors. This represents the range from the largest employment loss (or smallest employment gain) estimated to the largest employment gain estimated across the combination of

<sup>137</sup> Vehicle technology cost estimates for this rule were developed in OMEGA. Chapter 9 in the RIA provides information on the total and per-vehicle costs estimated.

<sup>138</sup> ERM reports employment as a count of jobs, which are not based on a full-time equivalent basis.

sector groups.<sup>139</sup> The shows an expected increase in employment from 2027 through 2032. Interpreting these results in terms of direction and relative magnitude, this estimate indicates that possible job growth over time in PEV related sectors will be greater than possible job loss in ICE or common sectors.

**Table 4-32: Estimated maximum combined range of estimated partial employment effects across all sectors.**

| Year | Maximum Combined Range |         |
|------|------------------------|---------|
| 2027 | 1,600                  | 9,400   |
| 2028 | 6,000                  | 34,900  |
| 2029 | 14,000                 | 80,200  |
| 2030 | 17,600                 | 124,700 |
| 2031 | 20,800                 | 161,700 |
| 2032 | 17,400                 | 188,100 |

As discussed in Chapter 4.5.3.1, EPA contracted with FEV to perform a detailed tear-down study comparing two similar vehicles, a 2021 Volkswagen ID.4 (BEV) and a 2021 Volkswagen Tiguan (ICE) (see RIA Chapter 2.5.2.2.3 for more details on this study). The results shown here are consistent with the results of the FEV tear-down study and indicate that, even if fewer labor hours are needed at the assembly plant, increased labor hours will be needed elsewhere in the supply chain for the electrified portions of production, for example in building and assembling battery packs.

While some workers may experience transitory negative impacts if they cannot readily move into alternative employment of similar quality, these analyses suggest greater likelihood of overall job growth over the period of these standards. In addition, as noted in Chapters 4.5.2 and 4.5.3, and throughout RTC Section 20, support for domestic employment related to electric vehicle production, from supply chain, to production, to infrastructure, is increasing, including through multiple programs implemented through DOE, as well as through provisions in the BIL, IRA, and CHIPS Act.

#### **4.5.5 Employment Impacts on Related Sectors**

Economy-wide impacts on employment are generally driven by broad macroeconomic effects. However, employment impacts, both positive and negative, in sectors upstream and downstream from the regulated sector, or in sectors producing substitute or complementary products, may also occur as a result of this rule.

For example, as described in RIA Chapter 8.5, we expect the rule to cause a small decline in liquid fuel consumption and a small increase in electricity generation which may have consequences for labor demand in those upstream industries, as well as associated industries

---

<sup>139</sup> This is not a straight sum of the smallest and largest effect from Table 4-31, which are based on absolute value (closest to and furthest from zero) and is not affected by the direction of the effect, but a sum of the minimum and maximum effects, which include direction of the effect.

such as extracting, refining, transporting, and storing of petroleum fuels. The lower per-mile fuel costs could lead to increases in demand for ride-hailing services and cause increases in demand for drivers in those jobs. Increased mobility related to the lower cost per mile of driving, as discussed in Section VIII.D.1 of the preamble, may also benefit owner/operators in MD fleets through the fleet being able to service a greater range of customers, or benefit consumers through increasing their feasible geographic area for employment opportunities. Firms producing substitutes or complements to the goods produced by the regulated industry may also experience changes in demand for labor. For example, the expected decline in gas station visits may lead to reduced demand for labor in that sector. Although gasoline stations will sell less fuel, the fact that many provide other goods, such as food or car washes, moderates possible losses in this sector. Note that, as discussed in Section VIII.I.4 of the preamble, traditional gas stations and liquid fuel providers are already incorporating EV charging into their business strategies. There will also likely be an increase in demand for labor in sectors that build and maintain charging stations. The magnitude of these impacts depends on a variety of factors including the labor intensities of the related sectors as well as the nature of the linkages between them and the regulated firms.

Expected petroleum fuel consumption reductions found in Chapter 8.5 represent fuel savings for purchasers of fuel, however they also represent a potential loss in value of output for the petroleum refining industry, fuel distributors, and gasoline stations. The loss of expenditures could impact sectors throughout the petroleum fuel supply chain, including petroleum refiners, pipeline construction, operations and maintenance, domestic oil production, and gasoline stations, and could result in reduced employment in these sectors. In this final rule, we estimate that the reduction in fuel consumption (see RIA Chapter 10) will be met by increasing net exports by half of the amount of reduced domestic demand for refined product, with the other half being met by reductions in U.S. refinery output. As discussed in RIA Chapter 8.6.4, there have been several closures or conversions of refineries in recent years that are attributed to many factors, including lower fuel demand due to COVID-19 or decisions to pivot away from fossil fuels. Though the reduced domestic output may lead to future closures or conversions of individual refineries, we are unable to estimate the future decisions of refineries to keep operating, shut down or convert away from fossil fuels because they depend on the economics of individual refineries, economic conditions of parent companies, long-term strategies for each company, and on the larger macro-economic conditions of both the U.S. and the global refinery market. Therefore, we are unable to estimate the possible effect this rule will have on employment in the petroleum refining sector. However, because the petroleum refining industry is material intensive and not labor intensive, and we estimate that only part of the reduction in liquid fuel consumption will be met by reduced refinery production in the U.S., we expect that any employment effect due to reduced petroleum demand will be small. It may also be difficult to distinguish these effects from other trends, such as increases in petroleum sector labor productivity that may also lower labor demand. In addition, there is uncertainty about the impact of reduced domestic demand for petroleum fuels on the petroleum fuel supply chain. For instance, refineries might export the volumes of gasoline and diesel fuel that would otherwise have been consumed in light- and medium-duty vehicles, absent this rulemaking. In that scenario there would be no impact on employment at refineries.

As discussed in Chapter 4.5.2, electrification of the vehicle fleet is likely to affect both the number and the nature of employment in the auto and parts sectors and related sectors, such as in

providers of charging infrastructure and utilities supporting grid enhancements, as well as sectors that maintain charging infrastructure. This can happen through many avenues, including greater demand for batteries, and therefore increased employment needs, through greater demand for charging and fueling infrastructure to support more PEVs, leading to more private and public charging facilities being constructed, or through greater use of existing facilities, which can lead to increased maintenance needs for those facilities. As discussed in Section VIII.I.4 of the preamble, charging infrastructure growth in the U.S. is expected to create jobs in sectors related to constructing and maintaining these facilities, including electrical installation, maintenance and repair, charger assembly, general construction, software maintenance and repair, planning and design, and administration and legal. Though we received comments with concerns that there are not enough qualified technicians to support the infrastructure needs estimated as a function of this rule, we expect this to be a gradual increase, with more technicians being trained over time. In addition, as described in Section VIII.I.4 of the preamble, this will also be supported by the investments and programs focused on training for EV sector positions, and many other programs focused on job training for positions related to EV technology, including infrastructure and EV technicians.

In addition, the type and number of jobs related to vehicle maintenance and repair are expected to change, though we expect this to happen over a longer time span due to the nature of fleet turnover. Due to less need for maintenance of BEVs relative to ICE vehicles, demand for such workers could decrease. Though we expect the sale of new PEVs to increase over the time span of this rule, both new and used ICE vehicles will persist in the fleet for many years. As vehicles age, they generally require greater amounts of maintenance, possibly mitigating the expected reduction in the number of ICE vehicles in the onroad fleet over time. Over this same time span, though we estimate less maintenance needs for BEVs compared to ICE vehicles, the total employment related to PEV maintenance is expected to increase due to the increase in number of PEVs in the onroad fleet. Even if the increase in PEV maintenance-related employment is smaller than the decrease in ICE vehicle maintenance-related employment over time, we expect opportunities for workers to retrain to other positions, for example within PEV maintenance, charging station infrastructure, or elsewhere in the economy. Research funded by the Department of Energy (DOE) indicates that a wide range of jobs in the ICE vehicle sector have a relatively high similarity in needed skill sets to jobs in the EV sector, as well as in other sectors.<sup>140</sup> Also, as described in Section VIII.I.1 and VIII.I.4 of the preamble, DOL, DOE, and other groups are involved in existing and planned projects focused on training new and existing employees in green energy jobs, including maintenance and repair.

Effects in the supply chain depend on where goods in the supply chain are developed. Commenters on the proposed rule argued that developing PEVs in the U.S. is critical for domestic employment, and for the global competitiveness of the U.S. in the future auto industry: as other countries are moving rapidly to develop PEVs, the U.S. auto industry risks falling behind. As discussed in Preamble Section I.A.2.iii and RIA 4.5.2, there have been several legislative and administrative efforts, and enacted several acts, since 2021 aimed at improving the domestic supply chain for electric vehicles, including electric vehicle chargers, critical

---

<sup>140</sup> Workforce Analytic Approaches to Find Degrees of Freedom in the EV Transition; [https://papers.ssrn.com/sol3/papers.cfm?abstract\\_id=4699308](https://papers.ssrn.com/sol3/papers.cfm?abstract_id=4699308)



minerals, and components needed by domestic manufacturers of PEV batteries. These actions are also expected to provide opportunities for domestic employment in these associated sectors.

The standards may affect employment for auto dealers through a change in vehicles sold, with increasing (decreasing) sales being associated with an increase (decrease) in labor demand. However, vehicle sales are also affected by macroeconomic effects, and it is difficult to separate out the effects of the standards on sales from effects due to macroeconomic conditions. In addition, auto dealers may be affected by changes in maintenance and service costs. Increases in those costs are likely to increase labor demand in dealerships, and reductions are likely to decrease labor demand. Auto dealers may also be affected by changes in the maintenance needs of the vehicles sold. For example, reduced maintenance needs of BEVs could lead to reduced demand for maintenance labor for dealers that sell BEVs. Another factor that may affect employment for auto dealers is if there is a change in the share of vehicles being sold under a direct-to-consumer sales model. As of 2023, at least eight U.S. states ban the sale of direct-to-consumer sales of vehicles.<sup>141</sup> This would not affect many OEMs that currently sell vehicles through dealerships across the country. However, OEMs who operate under a direct-to-consumer sales model may affect employment levels at dealerships, either through new agreements with existing dealers, new dealerships being built to service their vehicle sales, or increasing alternative methods of sales. This possible effect is very uncertain, however, as it is affected by multiple factors including state regulations, the existence of OEMs operating under direct-to-consumer models, as well as the relative share of vehicles being sold under direct-to-consumer models of operation.

An additional factor to consider for employment impacts across all industries that might be affected by this rule, or by the increase in the share of PEVs in the market, is that though more PEVs are being introduced to the market, regardless of this rule, ICE vehicles will persist in the market for many years. Also, there are multiple pathways to compliance with this rule, and OEMs are able to choose compliance methods that work for them. Though there may be negative impacts on workers currently employed in ICE vehicle production, this gradual shift avoids abrupt changes and will reduce impacts in acceptance, infrastructure availability, employment, supply chain, and more. In addition, support through recent federal investment allows for increased investment along the vehicle supply chain, including domestic battery manufacturing, charging infrastructure, and vehicle manufacturing.

As discussed in Chapter 4.5.2, the BIL, CHIPS Act, and IRA are expected to create incentives for expanding domestic manufacturing along the electric vehicle supply chain, including battery manufacturing and infrastructure. This legislation is expected to, in turn, create incentives opportunities for domestic employment along the full automotive sector and EV battery supply chains, from components to final assembly.<sup>142</sup> Importantly, domestic employment is expected to be positively impacted due to the domestic assembly, production, and manufacturing conditions on eligibility for purchase incentives and battery manufacturing incentives in the IRA, with

---

<sup>141</sup> <https://blog.onlyusedtesla.com/the-states-where-tesla-still-cant-sell-cars-and-why-it-matters-today-577c0f4e4009>

<sup>142</sup> More information on how these Acts are expected to aid employment growth and create opportunities for growth along the supply chain can be found in the January 2023 White House publication "Building a Clean Energy Economy: A Guidebook to the Inflation Reduction Act's Investments in Clean Energy and Climate Action." found online at <https://www.whitehouse.gov/wp-content/uploads/2022/12/Inflation-Reduction-Act-Guidebook.pdf>

estimates from the BlueGreen Alliance and the Political Economy Research Institute stating that the IRA could lead to over 9 million jobs over the next decade, with about 400,000 of them attributed directly to the IRA's battery and fuel cell vehicle provisions. (BlueGreen Alliance 2023)

As a result of these standards, consumers will likely pay higher up-front costs for the vehicles, but they are expected to recover those costs through reduced fuel, maintenance, and repair costs, as well as due to the IRA tax incentives for PEV purchase and battery manufacturing leading to reduced up-front costs for BEVs. As a result, consumers are expected to have additional money to spend on other goods and services, though the timing of access to that additional money depends on aspects including whether the consumer borrows money to buy the vehicle. These increased expenditures could support employment in those sectors where consumers spend their savings. If the economy is at full employment, any change in consumer expenditures would primarily represent a shift in employment among sectors. If, on the other hand, the economy has substantial unemployment, these expenditures would contribute to employment through increased consumer demand.

## Chapter 4 References

- Argonne National Laboratory. 2024. "Light-duty Electric Drive Vehicles Monthly Sales Updates." Energy Systems and Infrastructure Analysis. Accessed February 21, 2024. <https://www.anl.gov/esia/light-duty-electric-drive-vehicles-monthly-sales-updates>.
- Arrow, R.G., M.L. Cropper, G.C. Eads, R.W. Hahn, L.B. Lave, R.G. Noll, P.R. Portney, et al. 1996. "Is There a Role for Benefit-Cost Analysis in Environmental, Health, and Safety Regulation?" *Science* 272 (5259): 221-222.
- Autolist. 2022. How Long Should I Keep My Car. June 24. Accessed February 07, 2023. <https://www.autolist.com/guides/how-long-should-i-keep-my-car>.
- Bartlett, Jeff. 2022. More Americans Would Buy and Electric Vehicle, and Some Consumers Would Use Low-Carbon Fuels, Survey Shows. Consumer Reports. July 7. Accessed March 2, 2023. <https://www.consumerreports.org/hybrids-evs/interest-in-electric-vehicles-and-low-carbon-fuels-survey-a8457332578/>.
- Berman, E., and L.T.M. Bui. 2001. "Environmental Regulation and Labor Demand: Evidence from the South Coast Air Basin." *Journal of Public Economics* 79 (2): 265-295.
- Black Book and Fitch Ratings. 2021. Vehicle Depreciation Report 2021.
- Blackley, Julie. n.d. How Long Do People Keep Their Cars? Accessed 02 07, 2023. <https://www.iseecars.com/how-long-people-keep-cars-study>.
- Bloomberg NEF. 2023. "Electric Vehicle Outlook 2023."
- BlueGreen Alliance. 2023. 9 Million jobs from climate action: the iInflation Reduction Act. Accessed February 2024. <https://www.bluegreenalliance.org/site/9-million-good-jobs-from-climate-action-the-inflation-reduction-act/>.
- BlueGreen Alliance. 2021. "Backgrounder: EVs are Coming. Will They be Made in the USA?" <https://www.bluegreenalliance.org/wp-content/uploads/2021/04/Backgrounder-EVs-Are-Coming.-Will-They-Be-Made-in-the-USA-vFINAL.pdf>.
- Borlaug, Brennan, Shawn Salisbury, Mindy Gerdes, and Matteo Muratori. 2020. "Levelized Cost of Charging Electric Vehicles in the United States." *Joule* 4: 1470-1485. doi:<https://doi.org/10.1016/j.jopule.2020.05.013>.
- Brown, Abby, Jeff Cappellucci, Emily White, Alexia Heinrich, and Emma Cost. 2023. Electric Vehicle Charging Infrastructure Trends from the Alternative Fueling Station Locator: Second Quarter 2023. Golden, CO: National Renewable Energy Laboratory. <https://www.nrel.gov/docs/fy24osti/87033.pdf>.
- Bui, Anh, Peter Slowik, and Nic Lutsey. 2020. Update on electric vehicle adoption across U.S. cities. International Council on Clean Transportation. <https://theicct.org/wp-content/uploads/2021/06/EV-cities-update-aug2020.pdf>.
- Bureau of Labor Statistics. 2023. Real Domestic Employment Requirements. Accessed January 2023. [http://www.bls.gov/emp/ep\\_data\\_emp\\_requirements.htm](http://www.bls.gov/emp/ep_data_emp_requirements.htm).

Burlig, Fiona, James Bushnell, David Rapson, and Catherine Wolfram. 2021. "Low Energy: Estimating Electric Vehicle Electricity Use." *AEA Papers and Proceedings* 111: 430-435.

Burnham, Andrew, David Gohlke, Luke Rush, Thomas Stephens, Yan Zhou, Mark A Delucchi, Alicia Birly, et al. 2021. *Comprehensive Total Cost of Ownership Quantification for Vehicles with Different Size Classes and Powertrains*. ANL/ESD-21/4, Energy Systems Division, Lemont, IL: Argonne National Laboratory. <https://publications.anl.gov/anlpubs/2021/05/167399.pdf>.

2021. "CAFE TSD." Technical Support Document: Proposed Rulemaking for Model Years 2024-2026 Light-Duty Vehicle Corporate Average Fuel Economy Standards. NHTSA, Department of Transportation, August.

California Air Resources Board. 2022. "Public Hearing to Consider the Proposed Advanced Clean Cars II Regulations Staff Report: Initial Statement of Reasons." <https://ww2.arb.ca.gov/sites/default/files/barcu/regact/2022/accii/isor.pdf>.

Chakraborty, Debapriya, Scott Hardman, and Gil Tal. 2022. "Integrating plug-in electric vehicles (PEVs) into household fleet- factors influencing miles traveled by PEV owners in California." *Travel Behavior and Society* 26: 67-83.

CHIPS Act of 2022. 2022. H.R. 4346 (117th Cong. Sess. 2).

Climate Nexus. 2022. "Job Impacts From the Shift to Electric Cars and Trucks." Accessed December 2022. <https://climatenexus.org/climate-issues/energy/ev-job-impacts/>.

Colato, J, and L Ice. 2023. "Charging into the Future: The Transition to Electric Vehicles." *Beyond the Numbers: Employment & Unemployment (U.S. Bureau of Labor Statistics)* 12 (4). <https://www.bls.gov/opub/btn/volume-12/charging-into-the-future-the-transition-to-electric-vehicles.htm>.

Cole, Cassandra, Michael Droste, Christopher Knittel, Shanjun Li, and James H. Stock. 2023. "Policies for Electrifying the Light-Duty Fleet in the United States." *AEA Papers and Proceedings* 113: 316-322. doi:<https://doi.org/10.1257/pandp.20231063>.

Collins, Jeffrey. 2023. South Carolina offers \$1.3B to new Scout electric SUV maker. AP News. <https://apnews.com/article/scout-electric-vehicle-plant-south-carolina-07c565669e13985738db503a86e323b0>.

Consumer Reports. 2022. "Survey Says: Considerable Interest in Electric Vehicles Across Racial, Ethnic Demographics."

Curtis, M.E. 2018. "Who Loses Under Cap-and-Trade Programs? The Labor Market Effects of the NOx Budget Trading Program." *The Review of Economics and Statistics* 100 (1): 151-166.

Davis, Lucas W. 2022. "Electric vehicles in multi-vehicle households." *Applied Economics Letters*. doi:<https://doi.org/10.1080/13504851.2022.2083563>.

Davis, Lucas W. 2019. "How much are electric vehicles driven?" *Applied Economics Letters* 26 (18): 1497-1502. doi:<https://doi.org/10.1080/13504851.2019.1582847>.

Deschenes, O. 2018. "Balancing the Benefits of Environmental Regulations for Everyone and the Costs to Workers and Firms." *IZA World of Labor*. Vol. 22v2.  
<https://wol.iza.org/uploads/articles/458/pdfs/environmental-regulations-and-labor-markets.pdf>.

DOT Volpe Center. 2023. "CCEMS parameters input file." parameters\_ref.xlsx, Economic Values worksheet. August 17.

Dr. Ernst, Stefan. 2023. Volkswagen-backed PowerCo SE reaches significant milestone in St. Thomas gigafactory project. Press Release, Volkswagen Group. Accessed February 2024.  
<https://www.volkswagen-group.com/en/press-releases/volkswagen-backed-powerco-se-reaches-significant-milestone-in-st-thomas-gigafactory-project-17962>.

Edmunds. 2023. Cost of Car Ownership. Accessed January 6, 2023. [Edmunds.com/tco.html](https://www.edmunds.com/tco.html).

Ehrenberg, R.G., and R.S. Smith. 2000. *Modern Labor Economics: Theory and Public Policy*. Addison Wesley Longman, Inc.

EnergyTech. 2023. DOE Announces \$275M for 7 Projects to Strengthen Clean Energy Supply Chains and Manufacturing in Former Coal Communities. EnergyTech.  
<https://www.energytech.com/energy-efficiency/article/21278185/doe-announces-275m-for-7-projects-to-strengthen-clean-energy-supply-chains-and-manufacturing-in-former-coal-communities>.

ERM. 2022. "Electric Vehicle Market Update: Manufacturer Commitments and Public Policy Initiatives Supporting Electric Mobility in the U.S. and Worldwide. Contract Report to the Environmental Defense Fund." Accessed 12 16, 2022.  
[https://blogs.edf.org/climate411/files/2022/04/electric\\_vehicle\\_market\\_report\\_v6\\_april2022.pdf](https://blogs.edf.org/climate411/files/2022/04/electric_vehicle_market_report_v6_april2022.pdf).

Fischer, Carolyn. 2005. "On the Importance of the Supply Side in Demand-Side Management." *Energy Economics* 17: 165-180.

Forsythe, C., K. Gillingham, J. J. Michalek, and K. Whitefoot. 2023a. "Will pickup truck owners go electric?" Carnegie Mellon University and Yale University.  
<https://www.cmu.edu/cit/veg/publications.html>.

Forsythe, Connor R, Kenneth T Gillingham, Jeremy J Michalek, and Kate S Whitefoot. 2023b. "Technology Advancement is Driving Electric Vehicle Adoption." *Sustainability Science* (PNAS). Accessed February 2024. <https://www.pnas.org/doi/epdf/10.1073/pnas.2219396120>.

Forsythe, Connor R., Kenneth T. Gillingham, Jeremy J. Michalek, and Kate S. Whitefoot. 2023b. "Technology advancement is driving electric vehicle adoption." *PNAS* 120 (23).  
doi:<https://doi.org/10.1073/pnas.2219396120>.

Fujita, K Sydney, Hung-Chia Yang, Margaret Taylor, and Dana Jackman. 2022. "The Green Light on Buying a Car: How Consumer Decision Making Interacts with Environmental Attributes in the New Vehicle Purchase Process." *Transportation Research Record* 2676 (7): 743-762.

Fujita, K. Sydney, Nica Campbell, and Margaret Taylor. 2024. EVs for everyone? Identifying the likely early majority of electric vehicle adopters. Lawrence Berkeley National Laboratory, Energy Technologies Area.

Ge, Yanbo, Christina Simeone, Andrew Duvall, and Andrew Wood. 2021. There's No Place Like Home: Residential Parking, Electrical Access, and Implications for the Future of Electric Vehicle Charging Infrastructure. NREL/TP-5400-81065, Golden, CO: National Renewable Energy Laboratory. <https://www.nrel.gov/docs/fy22osti/81065.pdf>.

Gillingham, K, A van Benthem, S Weber, D Saafi, and X He. 2023. "Has Consumer Acceptance of Electric Vehicles Been Increasing? Evidence from Microdata on Every New Vehicle Sale in the United States." American Economics Association: Papers & Proceedings, forthcoming. [https://resources.environment.yale.edu/gillingham/GBWSH\\_ConsumerAcceptanceEVs.pdf](https://resources.environment.yale.edu/gillingham/GBWSH_ConsumerAcceptanceEVs.pdf).

Greschak, Tressa, Matilda Kreider, and Nathan Legault. 2022. "Consumer Adoption of Electric Vehicles: An Evaluation of Local Programs in the United States." School for Environment and Sustainability, University of Michigan, Ann Arbor, MI. <https://deepblue.lib.umich.edu/handle/2027.42/172221>.

Hafstead, M.A.C., and R.C. Williams III. 2018. "Unemployment and Environmental Regulation in General Equilibrium." *Journal of Public Economics* 160: 50-65.

Hardman, Scott, and Gil Tal. 2021. "Understanding Discontinuance among California's Electric Vehicle Owners." *Nature Energy* 6 (5): 538-545. doi:<https://doi.org/10.1038/s41560-021-00814-9>.

Hardman, Scott, Kelly L Fleming, Eesha Khare, and Mahmoud M Ramadan. 2021. "A perspective on equity in the transition to electric vehicles." *MIT Science Policy Review* 2: 46-54. doi:10.38105/spr.e10rdoaup.

Helfand, G, and R Dorsey-Palmateer. 2015. "The Energy Efficiency Gap in EPA's Benefit-Cost Analysis of Vehicle Greenhouse Gas Regulations: A Case Study." *Journal of Benefit-Cost Analysis* 6 (2): 432-454.

Herrmann, F., W. Beinhauer, D. Borrmann, M. Hertwig, J. Mack, T. Potinecke, C-P. Praeg, and P. Rally. 2020. Employment 2030: Effect of Electric Mobility and Digitalization on the Quality and Quantity of Employment at Volkswagen. Fraunhofer Institute for Industrial Engineering IAO. [https://www.volkswagenag.com/presence/stories/2020/12/fraunhofer-studie/6095\\_EMDI\\_VW\\_Summary\\_um.pdf](https://www.volkswagenag.com/presence/stories/2020/12/fraunhofer-studie/6095_EMDI_VW_Summary_um.pdf).

Huang, H, G Helfand, and K Bolon. 2018a. "Consumer Satisfaction with New Vehicles Subject to Greenhouse Gas and Fuel Economy Standards." Society for Benefit-Cost Analysis Annual Conference.

Huang, H, G Helfand, K Bolon, R Beach, M Sha, and A Smith. 2018. "Re-searching for hidden costs: Evidence from the adoption of fuel-saving technologies in light-duty vehicles." *Transportation Research Part D* 65: 194-212.

Hutchens, Andrew, Alecia Cassidy, Geoffrey Burmeister, and Gloria Helfand. 2021. Impacts of Light-Duty Greenhouse Gas Emission Standards on Vehicle Affordability. U.S. Environmental Protection Agency.

IEA. 2023. "Global EV Outlook 2023: Catching up with climate ambitions." International Energy Agency.

Inflation Reduction Act of 2022. 2022. H.R. 5376 (117th Cong., 2nd sess.).

- Infrastructure Investment and Jobs Act. 2021. H.R. 3684 (117th Cong., 1st sess.).
- Jackman, D K, K S Fujita, H C Yang, and M Taylor. 2023. Literature Review of U.S. Consumer Acceptance of New Personally Owned Light Duty Plug-in Electric Vehicles. Washington, D.C.: U.S. Environmental Protection Agency.
- JGCRI . n.d. "GCAM (Global Change Analysis Model) v7 Documentation: Economic Choice in GCAM." Joint Global Change Research Institute. <https://jgcri.github.io/gcam-doc/choice.html>.
- Krisher, T., and J. Seewer. 2021. Autoworkers face uncertain future in an era of electric cars. ABC News. February 11. Accessed March 1, 2023. <https://www.abc27.com/news/us-world/business/autoworkers-face-dimmer-future-in-a-new-era-of-electric-cars/>.
- Kupper, D., K. K. Kuhlmann, A. Tominaga, and J. Schlageter Arora. 2020. Shifting Gears in Auto Manufacturing. September 28. Accessed October 20, 2021. <https://www.bcg.com/publications/2020/transformational-impact-of-electric-vehicles-on-auto-manufacturing>.
- Layard, R., and A. Walters. 1978. "Microeconomic Theory." Chap. 9. London: McGraw-Hill.
- Leard, B., V. McConnell, and Y. C. Zhou. 2017. "The Effect of Fuel Price Changes on Fleet Demand for New Vehicle Fuel Economy." Working Paper (Resources For the Future). <https://media.rff.org/documents/RFF20WP2017-25.pdf> .
- Lee, Hyun Lee, Minyoung Cho, Gil Tal, and Scott Hardman. 2023. "Do plug-in hybrid adopters switch to battery electric vehicles (and vice versa)?" Transportation Research Part D 119 (103752).
- Martin, Allison. 2023. How long should your car loan be? Edited by Helen Wilbers. December 4. Accessed December 15, 2023. <https://www.bankrate.com/loans/auto-loans/how-long-should-your-car-loan-be/>.
- Morgenstern, R.D., W.A. Pizer, and J.-S. Shih. 2002. "Jobs Versus the Environment:" An Industry-Level Perspective." Journal of Environmental Econometrics and Management 43: 412-436.
- Muller, D. 2017. "Warranties Defined: The Truth behind the Promises." Car and Driver, May 29.
- National Academies of Science, Engineering, and Medicine. 2021. Assessment of Technologies for Improving Light-Duty Vehicle Fuel Economy 2025-2035. Washington, DC: The National Academies Press. doi:<https://doi.org/10.17226/26092>.
- Nehiba, Cody. 2024. "Electric vehicle usage, pollution damages, and the electricity price elasticity of driving." Journal of Environmental Economics and Management 124 (102915). doi:<https://www.sciencedirect.com/science/article/pii/S009506962300133X>.
- NHTSA. 2022. Technical Support Document: Final Rulemaking for Model Years 2024-2026 LightDuty Vehicle Corporate Average Fuel Economy Standards. U.S. Department Of Transportation, National Highway Traffic Safety Administration. Accessed March 7, 2023. [https://www.nhtsa.gov/sites/nhtsa.gov/files/2022-04/Final-TSD\\_CAFE-MY-2024-2026.pdf](https://www.nhtsa.gov/sites/nhtsa.gov/files/2022-04/Final-TSD_CAFE-MY-2024-2026.pdf).

Political Economy Research Institute. 2022. Job Creation Estimates Through Proposed Inflation Reduction Act. University of Massachusetts Amherst. <https://www.bluegreenalliance.org/site/9-million-good-jobs-from-climate-action-the-inflation-reduction-act/>.

Raghavan, Seshadri Srinivasa, and Gil Tal. 2021. "Behavioral and technology implications of electromobility on household travel emissions." *Transportation Research Part D* 94 (102792). doi:<https://doi.org/10.1016/j.trd.2021.102792>.

Rogers, E.M. 2003. *Diffusion of Innovations*. New York: Free Press.

Seattle Jobs Initiative. 2020. "Amping Up Electric Vehicle Manufacturing in the PNW: Opportunities for Business, Workforce, and Education." [https://www.seattle.gov/Documents/Departments/OSE/ClimateDocs/TE/EV%20Field%20in%20OR%20and%20WA\\_February20.pdf](https://www.seattle.gov/Documents/Departments/OSE/ClimateDocs/TE/EV%20Field%20in%20OR%20and%20WA_February20.pdf).

Slowik, Peter, Aaron Isenstadt, Logan Pierce, and Stephanie Searle. 2022. *Assessment of Light-Duty Electric Vehicle Costs and Consumer Benefits in the United States in the 2022-2035 Time Frame*. International Council on Clean Transportation. Accessed 12 16, 2022. <https://theicct.org/publication/ev-cost-benefits-2035-oct22/>.

Slowik, Peter, Stephanie Searle, Hussein Basma, Josh Miller, Yuanrong Zhou, Felipe Rodriguez, Claire Buysse, et al. 2023. "Analyzing the Impact of the Inflation Reduction Act on Electric Vehicle Uptake in the United States." International Council on Clean Transportation and Energy Innovation Policy & Technology LLC.

Smith, V.K. 2015. "Should Benefit-Cost Methods Take Account of High Unemployment?" *Review of Environmental Economics and Policy* 9 (2): 165-178.

Taylor, Margaret. 2023. Draft of "Modeling the Future of Electric Vehicles to Support U.S. Public Policy: A Comparison of Leading Approaches". Lawrence Berkeley National Laboratory.

Taylor, Margaret, and K Sydney Fujita. 2018. *Consumer Behavior and the Plug-in Electric Vehicle Purchase Decision Process: A Research Synthesis*. Berkeley, CA: Lawrence Berkeley National Laboratory.

Taylor, Margaret, K. Sydney Fujita, and Nica Campbell. 2024 . *The false dichotomies of plug-in electric vehicle markets*. Lawrence Berkeley National Laboratory.

U.S. Department of Energy (DOE). 2020. *Alternative fuels data center: developing infrastructure to charge plug-in electric vehicles*. Accessed 2020. [https://afdc.energy.gov/fuels/electricity\\_infrastructure.html](https://afdc.energy.gov/fuels/electricity_infrastructure.html).

U.S. Department of Energy. 2022. *Electric Vehicle Charging Station Locations*. Accessed March 8, 2022. [https://afdc.energy.gov/fuels/electricity\\_locations.html](https://afdc.energy.gov/fuels/electricity_locations.html).

U.S. Department of Energy Office of Manufacturing and Energy. 2024. "Supply Chains Inflation Reduction Act Domestic Manufacturing Conversion Grants Funding Opportunity Announcement DE-FOA-0003106\_FOA\_Doc\_Amendment\_000006\_IRA 50143." <https://infrastructure-exchange.energy.gov/Default.aspx#FoaIdf9eb1c8a-9922-46b6-993e-78972d823cb2>.



U.S. Department of Energy, Office of Policy. 2023. "Investing in American Energy: Significant Impacts of the Inflation Reduction Act and Bipartisan Infrastructure Law on the U.S. Energy Economy and Emissions Reductions."

U.S. DOE. 2023. Investing in American Energy: Significant Impacts of the Inflation Reduction Act and Bipartisan Infrastructure Law on the U.S. Energy Economy and Emissions Reductions. U.S. Department of Energy, Office of Policy.

U.S. DOT. 2021. "86 FR 49602." Corporate Average Fuel Economy Standards for Model Years 2024-2026 Passenger Cars and Light Trucks. September 3.

—. 2023. "88 FR 56128." Corporate Average Fuel Economy Standards for Passenger Cars and Light Trucks for Model Years 2027–2032 and Fuel Efficiency Standards for Heavy-Duty Pickup Trucks and Vans for Model Years 2030–2035. August 17.

U.S. DOT, FHWA. 2023. "The National Electric Vehicle Infrastructure (NEVI) Formula Program Guidance (Update)." June 2.

[https://www.fhwa.dot.gov/environment/alternative\\_fuel\\_corridors/nominations/90d\\_nevi\\_formula\\_program\\_guidance.pdf](https://www.fhwa.dot.gov/environment/alternative_fuel_corridors/nominations/90d_nevi_formula_program_guidance.pdf).

U.S. EPA. 2023. "2023 EPA Automotive Trends Report."

<https://www.epa.gov/system/files/documents/2023-12/420r23033.pdf>.

—. 2021. "86 FR 74434." Revised 2023 and Later Model Year Light-Duty Vehicle Greenhouse Gas Emissions Standards. December 30.

U.S. EPA. 2021. The Effects of New-Vehicle Price Changes on New- and Used-Vehicle Markets and Scrappage. EPA-420-R-21-019.

[https://cfpub.epa.gov/si/si\\_public\\_record\\_Report.cfm?dirEntryId=352754&Lab=OTAQ](https://cfpub.epa.gov/si/si_public_record_Report.cfm?dirEntryId=352754&Lab=OTAQ).

U.S. OMB. 2015. "2015 Report to Congress on the Benefits and Costs of Federal Regulations and Agency Compliance with the Unfunded Mandates Reform Act."

[https://obamawhitehouse.archives.gov/sites/default/files/omb/inforeg/2015\\_cb/2015-cost-benefit-repot.pdf/](https://obamawhitehouse.archives.gov/sites/default/files/omb/inforeg/2015_cb/2015-cost-benefit-repot.pdf/).

UAW. 2020. "Taking the High Road: Strategies for a Fair EV Future." <https://uaw.org/wp-content/uploads/2019/07/190416-EV-White-Paper-REVISED-January-2020-Final.pdf>.

Wakefield, Chantel. 2023. Electric Car Rebates and Incentives: What to Know by State. February 02. Accessed February 02, 2023. <https://www.kbb.com/car-advice/electric-vehicle-rebates-by-state/>.

Watten, A, G Helfand, and S Anderson. 2021. "Attribute Production and Technocal Change: Rethinking the Performance adn Fuel Economy Trade-off for Light-duty Vehicles." Working Paper.

White, Vinn. September 27, 2016. "Revised Departmental Guidance on Valuation of Travel Time in Economic Analysis."

Wood, Eric, Brennan Borlaug, Matt Moniot, D-Y Lee, Yanbo Ge, Fan Yang, and Zhaocai Liu. 2023. "The 2030 National Charging Network: Estimating U.S. Light-Duty Demand for Electric

Vehicle Charging Infrastructure." National Renewable Energy Laboratory. Accessed December 18, 2023. <https://www.nrel.gov/docs/fy23osti/85654.pdf>.

Zabritski, Melinda. 2023. State of the Automotive Finance Market - Q3 2023. November. Accessed December 15, 2023. <https://www.experian.com/automotive/automotive-credit-webinar?cmpid=Auto-US-24-122+Q3+2023+Auto+Credit+Trends>.

Zhao, Lujin, Elizabeth R. Ottinger, Arthur Hong Chun Yip, and John Paul Helveston. 2023. "Quantifying electric vehicle mileage in the United States." *Joule* 7: 2537-2551.

## Chapter 5: Electric Power Sector and Infrastructure Impacts

As plug-in electric vehicles<sup>143</sup> (PEVs) are projected to represent a significant share of the future U.S. light- and medium-duty vehicle fleet, EPA has developed new approaches to estimate the power sector<sup>144</sup> emissions of increased PEV charging. EPA combined the use of three analytical tools to incorporate power-sector-related emissions from PEV charging demand within the light- and medium-duty vehicle emissions inventory analysis for the final rule:

- OMEGA manufacturer compliance model
- A suite of electric vehicle infrastructure modeling tools (EVI-X) developed by the National Renewable Energy Laboratory (NREL)
- The Integrated Planning Model (IPM)

EPA's manufacturer compliance model, OMEGA, is described in detail in Chapter 2. Chapter 5.1 below provides a summary of EVI-X and how these tools were used together with OMEGA to estimate charge demand inputs for IPM. The power sector modeling and results are described in 5.2. The power sector emissions results were incorporated into the emissions inventory and cost-benefit analyses described in Chapters 6 through 9. The related retail price modeling results were also incorporated into the analysis of costs and benefits in Chapter 9.

Chapter 5.3 describes our assessment of PEV charging infrastructure. Finally, the potential impacts on pending changes to the power sector on grid resiliency are discussed in Chapter 5.4.

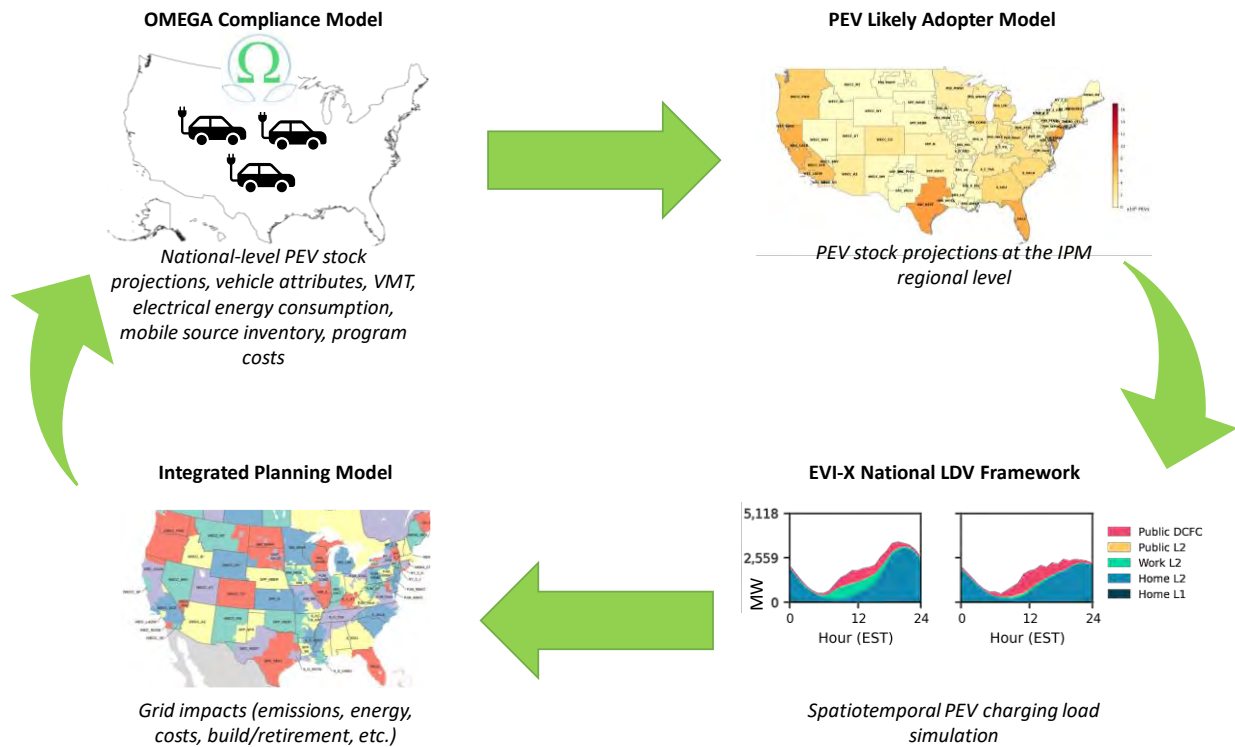
### 5.1 Modeling PEV Charge Demand and Regional Distribution

Under an Interagency Agreement between EPA and the U.S. Department of Energy, NREL has continued its development of a suite of electric vehicle infrastructure modeling tools (EVI-X) and methods for simulating PEV charging infrastructure requirements and associated electricity loads from best available data (U.S. EPA 2022b). EVI-X tools have informed multiple national, state, and local PEV charging infrastructure planning studies (E. Wood, C. Rames, et al. 2017) (E. Wood, C. Rames, et al. 2018) (Alexander, et al. 2021), including a national vehicle charging infrastructure assessment through 2030 (E. Wood, B. Borlaug, et al. 2023). Within the emissions inventory analysis for the final rule, EVI-X models are used to translate scenario-specific forecasts of national light-duty vehicle stock and annual energy consumption from the OMEGA model into spatially disaggregated hourly load profiles required for subsequent power sector modeling using the Integrated Planning Model (IPM) (see Chapter 5.2). The primary components of the process flow from OMEGA outputs to IPM inputs is shown in Figure 5-1. IPM outputs also flow back into inventory analyses in OMEGA as PEV emissions factors (see RIA Chapter 9).

---

<sup>143</sup> Plug-in electric vehicles is defined here as both battery electric vehicles and plug-in hybrid electric vehicles combined.

<sup>144</sup> Power sector is defined here to include electricity generation, transmission, and the distribution system, which typically ends at a service drop at a customer's premises.

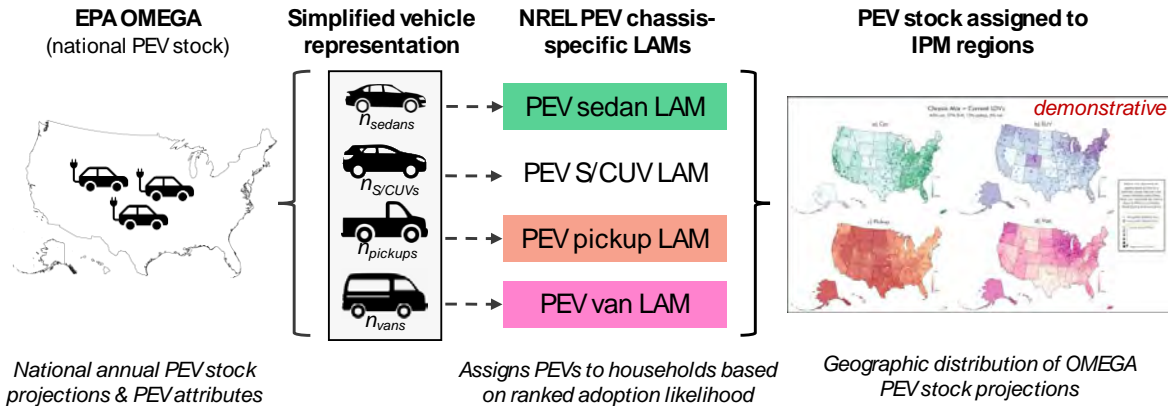


**Figure 5-1: Modeling process flow highlighting the primary components for translating OMEGA’s national PEV stock projections and PEV attributes into hourly load profiles.**

### **5.1.1 PEV Disaggregation and Charging Simulation**

As described in further detail in Chapter 2 of the RIA, the OMEGA model evaluates the cost of compliance for meeting the standards and options analyzed within the final rule. Each OMEGA run produces scenario-specific projections of national vehicle sales, stock, energy consumption, and tailpipe emissions. For PEVs, however, tailpipe emissions are zero in the case of battery electric vehicles (BEVs) and are zero during the charge-depleting operation of plug-in hybrid electric vehicles (PHEVs) with resulting emissions occurring upstream at the electricity generation source. This expands the requisite analytical boundaries of the system with respect to determination of emissions inventory impacts. To produce estimates of the spatiotemporal charging loads needed for power sector emissions modeling, the national PEV stock from OMEGA must first be disaggregated regionally.

The framework developed for PEV disaggregation leverages a likely adopter model (LAM) adapted by NREL (Ge, et al. 2021) to rank vehicles in the private light-duty fleet for their likelihood to be replaced by a PEV based on publicly available demographic data, including housing type, income, tenure (rent or own), state policies (ZEV states), and population density. The model is trained on the revealed preferences of 3,772 survey respondents (228 PEV owners) across the United States as described in (Ge, et al. 2021). Vehicle registration data from June 2022 (Experian Automotive 2022) are used to develop a set of chassis-specific LAMs for disaggregating PEV sedans, S/CUVs, pickups, and vans based on current regional vehicle type preferences. This process is outlined in Figure 5-2.



**Figure 5-2: Procedure for disaggregating OMEGA national PEV stock projections to IPM regions.**

Vehicles modeled within OMEGA are first assigned to a simplified chassis type (i.e., sedan, S/CUV, pickup, van). Next, the total number of vehicles for each chassis type are input into each of the four chassis-specific LAMs to disaggregate PEVs into IPM regions based on regional vehicle type preferences and the likelihood of PEV adoption.

The OMEGA model generates vehicle adoption projections for thousands of unique PEV models over time. Conducting detailed charging simulations for each of these models would be computationally prohibitive and produce results that do not meaningfully differentiate from those generated by a reduced set of representative PEV models. Thus, a clustering approach was used to generate these representative PEV models for simulation from the complete set of OMEGA vehicles. K-means clustering was performed over each PEV's respective battery capacity (kWh) and energy consumption rate (kWh/mi.) parameters as specified by OMEGA. A silhouette analysis was used to determine the appropriate number of clusters ( $k=6$  for BEVs,  $k=2$  for PHEVs) and OMEGA vehicles are assigned to clusters that minimize the Euclidean distance to the centroids of the two normalized (Z-score) parameters. These assignments are retained and used to map OMEGA vehicles to the most similar synthetic representative PEV model. The cluster centroids are used to produce the battery capacity and energy consumption rate parameters for the eight representative PEVs required for subsequent charging simulations. An additional parameter, the max DC charge acceptance, is defined as a PEV's maximum effective charging rate over a typical 20 percent to 80 percent SOC DC fast charging (DCFC) window. This was required to simulate DCFC for BEVs and was not directly specified by the OMEGA model. PHEVs are assumed to be incapable of DCFC. For modeling light-duty BEV DCFC, a simple heuristic was applied such that pre-2030 model years (Gen 1 batteries) would be capable of 1.5C charging on average while model year 2030 and later BEVs would be capable of charging at 3C (Gen 2 batteries).<sup>145</sup> The key parameters for simulating charging for each of the representative PEVs are shown in Table 5-1.

<sup>145</sup> C-rate (or  $C_r$ ) is a measure of the rate at which a battery is charged/discharged relative to its maximum energy storage capacity. It is related to charge/discharge current in amperes (I) and maximum energy storage capacity in amp-hours (E) by the equation  $I = C_r \cdot E$ .

**Table 5-1: Representative PEV examples for charging simulations.**

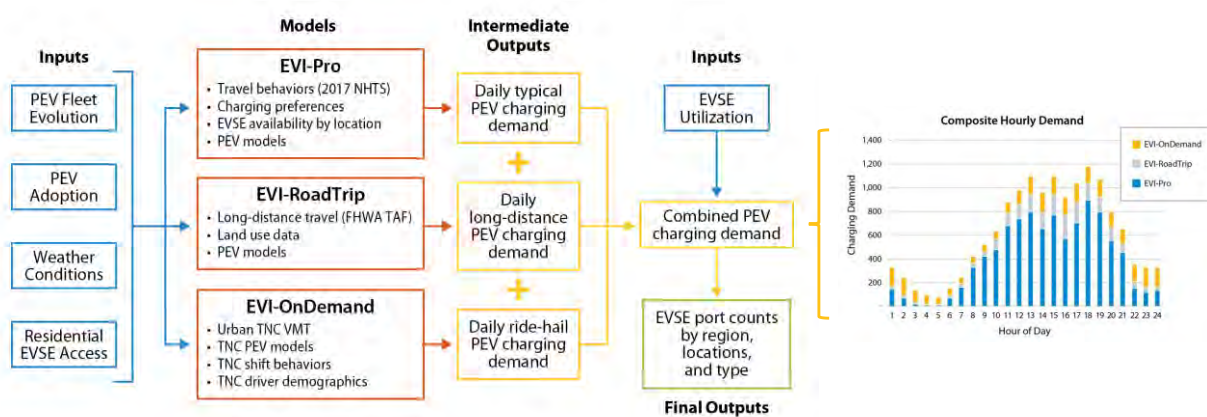
| Sim vehicle | Powertrain + EV Range [mi.] | Energy cons. rate [kWh/mi.] | Max AC accept. [kW] (Gen 1 / Gen 2) | Max DC accept. [kW] (Gen 1 / Gen 2) |
|-------------|-----------------------------|-----------------------------|-------------------------------------|-------------------------------------|
| BEV1        | BEV 300                     | 0.27                        | 9 / 12                              | 134 / 267                           |
| BEV2        | BEV 300                     | 0.31                        | 9 / 12                              | 154 / 308                           |
| BEV3        | BEV 300                     | 0.34                        | 9 / 12                              | 171 / 342                           |
| BEV4        | BEV 300                     | 0.38                        | 9 / 12                              | 191 / 383                           |
| BEV5        | BEV 300                     | 0.42                        | 9 / 12                              | 212 / 424                           |
| BEV6        | BEV 300                     | 0.47                        | 9 / 12                              | 236 / 471                           |
| PHEV1       | PHEV 50                     | 0.29                        | 9 / 12                              | -                                   |
| PHEV2       | PHEV 50                     | 0.38                        | 9 / 12                              | -                                   |
| MD BEV1     | BEV 150                     | 0.54                        | 12                                  | 300                                 |
| MD BEV2     | BEV 300                     | 0.62                        | 12                                  | 300                                 |
| MD PHEV     | PHEV 75                     | 0.7                         | 12                                  |                                     |

Light-duty PEV modeling in this report builds on the foundation of years of research and collaboration at NREL and beyond, most notably the recently published 2030 National Charging Network report (E. Wood, B. Borlaug, et al. 2023). A brief explanation of this modeling approach is provided here; readers are directed to this previous work for more detailed explanations of the modeling approach and assumptions.

The core tools used for modeling LDV charging demands in this study are:

- EVI-Pro: For typical daily charging needs
- EVI-RoadTrip: For fast charging along highways supporting long-distance travel
- EVI-OnDemand: For electrification of transportation network companies.

Each individual LDV model is integrated into a shared simulation pipeline (Figure 5-3). Models are provided with a self-consistent set of exogenous inputs that prescribe the size, composition, and geographic distribution of the national PEV fleet; technology attributes of vehicles and charging infrastructure; assumed levels of residential/overnight charging access; and regional environmental conditions. Each model uses these inputs in bottom-up simulations of charging behavior by superimposing the use of a PEV over travel data from internal combustion engine vehicles. By relying on historical travel data from conventional vehicles, these models implicitly design infrastructure networks capable of making PEVs a one-to-one replacement for internal combustion engine vehicles, effectively minimizing impacts to existing driving behavior and identifying the most convenient network of charging infrastructure capable of meeting driver needs. (E. Wood, B. Borlaug, et al. 2023).



**Figure 5-3: EVI-X National light-duty vehicle framework simulation showing spatiotemporal EV electricity demands for three separate use cases: typical daily travel (EVI-Pro), long-distance travel (EVI-RoadTrip), and ride-hailing (EVI-OnDemand). Adapted from Wood et al. (2023) with permission.**

The independent (but coordinated) simulations produce a set of intermediate outputs estimating daily charging demands for typical PEV use, long-distance travel, and ride-hailing electrification. These intermediate outputs are indexed in time (hourly over a representative 24-hour period) and space (core-based statistical area or county level) such that they can be aggregated into a composite set of charging demands across multiple use cases. Once combined, the peak hour for every combination of charging type (e.g., Level 1 [L1], Level 2 [L2], direct current [DC]), location type (e.g., home, work, retail), and geography (e.g., core-based statistical area) is identified for the purpose of network sizing. Rather than sizing the simulated charging network to precisely meet the peak hourly demand in all situations, the simulation pipeline uses an assumed network-wide utilization rate in the peak hour to “oversize” the network by a margin that accounts for the fact that charging demands tend to vary seasonally and around holidays.

The simulation of MDVs (Class 2b–3, gross vehicle weight rating [GVWR] 8,500–14,000 lbs.) leverages the EVI-X LDV pipeline with some key updates, namely:

- MDVs are disaggregated from the national level to counties in a manner proportional to existing registrations, as observed through data licensed from Experian. This contrasts the LDV approach, which relies on a set chassis-specific LAMs to assign PEVs to households with characteristics shown to correlate with PEV adoption.
- MDV travel patterns are derived from two sources based on chassis type: (1) Vans are simulated based on data from NREL’s FleetDNA database, and (2) pickups are simulated based on data licensed from Wejo. This contrasts the LDV approach, which relies on the 2017 National Household Travel Survey (NHTS).
- Because MDVs are owned by a variety of businesses, both in terms of company size and business type, and are often used for both personal and commercial use, medium-

duty PEVs in this study are assumed to be domiciled during off-shift periods at either a commercial property (e.g., a depot) or a private residential property (e.g., a single-family home). This study assumes that 75% of medium-duty PEVs are domiciled at depots and 25% at single-family homes. Further research into the domicile locations of MDVs is warranted because data on this topic are scarce, especially at the national level.

Following the PEV charging simulations, load profiles were aggregated from counties to IPM regions and converted from local time to Eastern Standard Time (EST) for IPM implementation. A final corrective step was taken to ensure that the annual energy consumption estimates supplied by OMEGA were reflected in the PEV load profiles. For a given OMEGA national PEV stock projection file, the modeling framework produces a typical weekday and weekend 24-hour (EST) load profile for all IPM regions and analysis years (2026, 2028, 2030, 2032, 2035, 2040, 2045, 2050, 2055).<sup>146</sup> Load profiles were analyzed using output from two analytical cases:

- A no-action case that included modeling of electric vehicle provisions from the IRA within the OMEGA compliance model and compliance with 2023 and later GHG standards (86 FR 74434 2021) with the addition of heavy-duty vehicle (Class 4-8) charge demand estimated for the California Advanced Clean Trucks (ACT) Program.
- A final rule policy case based upon Alternative 3 from the proposed rule with the addition of heavy-duty vehicle charge demand based on an interim scenario developed from the Greenhouse Gas Emissions Standards for Heavy-Duty Vehicles – Phase 3 Proposed Rule (HDP3).

Alternative 3 was one of the compliance scenarios modeled using OMEGA, EVI-X, and IPM during the summer and autumn of 2023. Of the scenarios modeled in IPM after the proposal, Alternative 3 is the closest scenario with respect to PEV charging demand to the final rule and represents the final rule within the power sector analysis. Alternative 3 differs from the finalized program by forecasting slightly higher PEV sales in 2027-2031 than finalized, and thus higher PEV charging demand in earlier years and comparable PEV charging demand after 2032. Thus, power sector impacts on emissions and cost within the final rule analysis should be considered conservatively high estimates. Regionalized heavy-duty vehicle charge demand for both the no-action and policy cases were based upon a combination of NREL EVI-X and LBNL HEVI-LOAD simulations developed as part of the Multi-State Transportation Electrification Impact Study (TEIS) (E. Wood, B. Borlaug, et al. 2024).

These analytical cases are described in more detail below. Figure 5-4 provides an example of how specific load profiles may be used to infer annual PEV charging demands for 2030 and 2050 using the final rule policy case. The purple shading in Figure 5-4 represents the relative light- and medium-duty vehicle charging demand in each of the 67 IPM regions. In addition to the total hourly energy demands for PEV charging, energy demands were also broken out by the following charging types – home Level 1 (L1), home Level 2 (L2), depot L2 (applicable to

---

<sup>146</sup> Output from OMEGA and EVI-X was also generated for Hawaii, Alaska, and Puerto Rico, however the IPM analysis only included IPM regions for the contiguous United States along with transmission dispatched across the U.S.-Canada border.

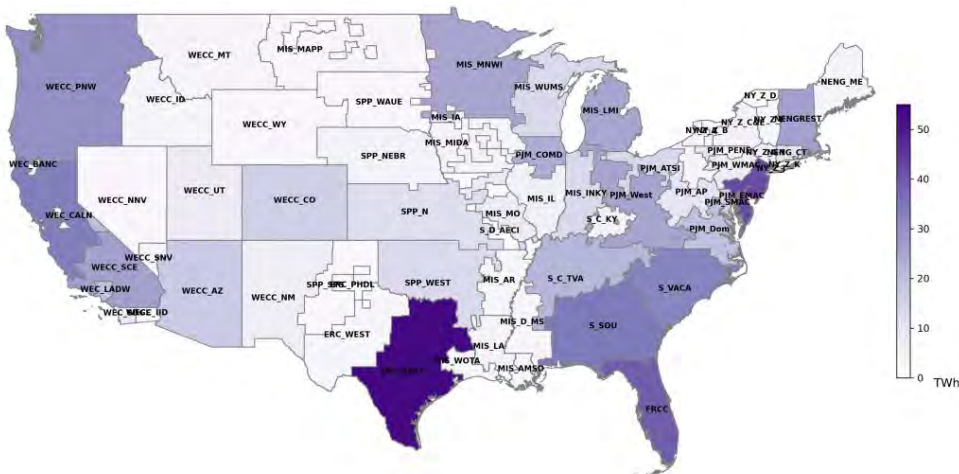


medium-duty PEVs), work L2, public L2, and public DCFC (Figure 5-5). See Chapter 5.3.1.2. for additional discussion. Note that these have been converted to EST and reflect an unmanaged charging scenario where drivers do not prioritize charging at certain times of the day (i.e., charging starts as soon as possible when vehicles are plugged in without consideration of electricity price or other factors) in the no action case and reflects a degree of managed charging within the analysis for the final rule based on load shifting of PEV charging that was developed as part of the TEIS.

a) Annual light- & medium-duty PEV charging demands: 2030



b) Annual light- & medium-duty PEV charging demands: 2050

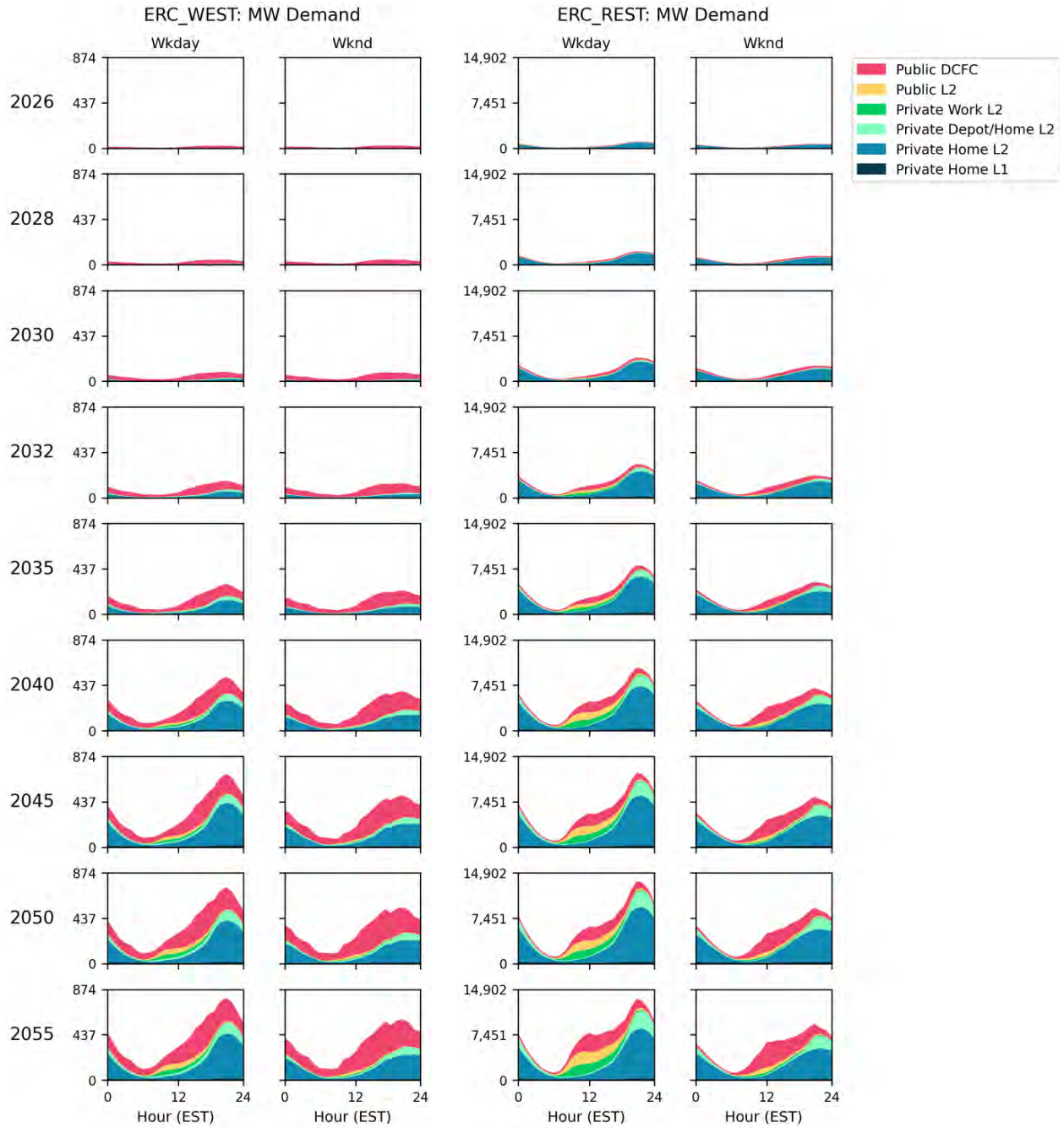


**Figure 5-4: Annual light- and medium-duty vehicle PEV charging loads (2030 and 2050 are shown) for each IPM region in the contiguous United States based on OMEGA charge demand for the final rule in 2030 (a) and 2050 (b).**

In Figure 5-5, there are clear differences in the magnitude, shape, and charger types between the West Texas (left–ERC\_WEST, containing mostly rural areas and small cities such as Midland and Odessa) and East Texas (right–ERC\_REST, including multiple major population

centers such as Houston, San Antonio, Austin, and Dallas-Ft. Worth) regions. The EVI-X modeling framework conducts charging simulations that incorporate regional differences in EV adoption, vehicle type preferences, home ownership, weather conditions, and travel patterns. These demonstrative results reflect how in ERC\_WEST, EV adoption is projected to be low (due to limited population and revealed vehicle preferences) leading to a reduced demand for home-based charging while public DCFC demands for long-distance travel within the region (e.g., road trips) are amplified. This leads to a disproportionate share of public DCFC charging demand along highway corridors within the ERC\_WEST region. Alternatively, simulated charging demands in the ERC\_REST are dominated by home and workplace charging due to the higher EV adoption and urban travel patterns more common to the region.

The OMEGA national PEV outputs and the resulting regionalized light- and medium-duty IPM inputs from EVI-X for both analyzed cases, for each IPM region and all analytical years (2026, 2028, 2030, 2032, 2035, 2040, 2045, 2050, 2055) are summarized within a separate PEV Regionalized Charge Demand Report (McDonald, PEV Regionalized Charge Demand for the FRM - Memo to the Docket 2023).



**Figure 5-5: Yearly hourly (in EST) weekday and weekend load profiles for two IPM regions (ERC\_WEST, west Texas; and ERC\_REST, east Texas) broken out by charger type for an example OMEGA analytical scenario.**

## **5.2 Electric Power Sector Modeling**

The analyses for the final rule used EPA's Power Sector Modeling Platform v6, which utilizes the Integrated Planning Model (IPM). IPM is a multi-regional, dynamic, deterministic linear programming model of the U.S. electric power sector. It provides projections of least-cost capacity expansion, electricity dispatch, and emission control strategies for meeting energy demand and environmental, transmission, dispatch, and reliability constraints. IPM can be used to evaluate the cost and emissions impacts of policies to limit emissions of sulfur dioxide (SO<sub>2</sub>), fine particulate matter (PM<sub>2.5</sub>), nitrogen oxides (NO<sub>x</sub>), carbon dioxide (CO<sub>2</sub>), hydrogen chloride (HCl), and mercury (Hg) from the electric power sector. Post-processing IPM outputs allows for the processing of other emissions, such as volatile organic compounds (VOC) and non-CO<sub>2</sub> GHGs. The power-sector modeling used for the final rule included power-sector-related provisions of both the Bipartisan Infrastructure Law (BIL) and the Inflation Reduction Act (IRA). Additional information regarding power-sector modeling is available via documentation for the Post-IRA 2022 Reference Case - EPA's Power Sector Modeling Platform v6 Using IPM (U.S. EPA 2023a). Changes made for the analysis for the final rule include updating power sector demand using AEO2023 projections through 2055 in place of AEO2021 and substituting electric vehicle demand from AEO with updated output from the OMEGA and EVI-X analyses used for the final rule (see Chapter 5.1). Note that the default PEV charge demand from AEO was replaced with charge demand from OMEGA/EVI-X for light-and medium duty (see Chapter 5.1.1) and charge demand from the TEIS (E. Wood, B. Borlaug, et al., Multi-State Transportation Electrification Impact Study 2024) for heavy-duty charge demand for all IPM analyses, including both no-action and policy analyses. The charge demand used for both the no action and policy analyses for light- and medium-duty vehicles and also an estimate of charge demand from the Heavy-duty Phase 3 GHG program have been separately docketed as part of this rulemaking (McDonald 2024)

### **5.2.1 Estimating Retail Electricity Prices**

The Retail Price Model (RPM) was developed to estimate retail prices of electricity using wholesale electricity prices generated by the IPM. This model was developed by ICF under contract with EPA (ICF 2019). The RPM provides a first-order estimate of average retail electricity prices using information from EPA's Power Sector Modeling Platform.

IPM includes a wholesale electric power market model that projects wholesale prices paid to generators. Electricity consumers - industrial, commercial, and residential customers - face a retail price for electricity that is higher than the wholesale price because it includes the cost of wholesale power and the costs of transmitting and distributing electricity to end-use consumers. The RPM was developed to estimate retail prices of electricity based on IPM results and a range of other assumptions, including the method of regulation and price-setting in each state. Traditionally, cost-of-service (COS) or Rate-of-Return regulation sets rates based on the estimated average costs of providing electricity to customers plus a "fair and equitable return" to the utility's investors. States that impose cost-of-service regulation typically have one or more investor-owned utilities (IOUs), which own and operate their own generation, transmission, and distribution assets. They are also the retail service provider for their franchised service territory in which IOUs operates. Under this regulatory structure, retail power prices are based on average historical costs and are established for each class of service by state regulators during periodic

rate case proceedings. Additional documentation on the RPM can be found at on the EPA website (ICF 2019) (U.S. EPA 2023b). For the final rule, the RPM was updated to incorporate distribution-level costs from the TEIS.

### **5.2.2 IPM emissions post-processing**

Emissions of non-CO<sub>2</sub> GHG (methane, nitrous oxide), PM, VOC, CO, and NH<sub>3</sub> were calculated via post-processing of IPM power sector projections using EPA-defined emissions factors. The EPA GHG Emissions Factors Hub was used to determine fuel-specific emissions factors for methane and nitrous oxide emissions for the electric power sector (U.S. EPA 2022a). Emissions factors used for post-processing of PM, VOC, CO, and NH<sub>3</sub> were documented as part of Post-IRA 2022 Reference Case - EPA's Power Sector Modeling Platform v6 Using IPM (U.S. EPA 2023a).

### **5.2.3 IPM National-level Demand, Generation, Emissions and Costs**

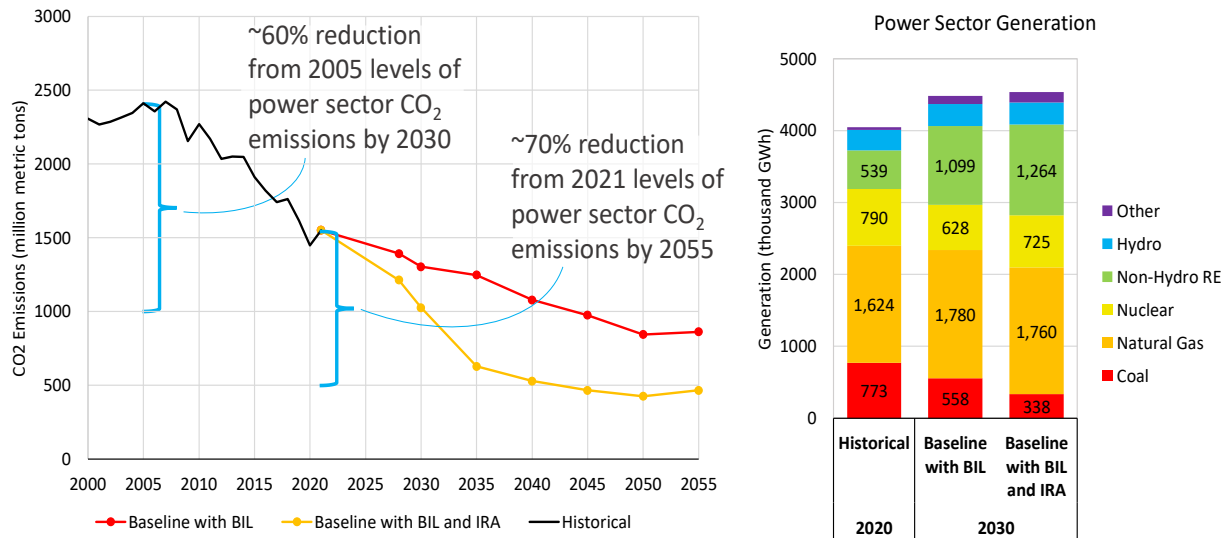
#### **5.2.3.1 Power Sector Impacts of the BIL and IRA**

EPA's Clean Air Markets Division (CAMD) completed an initial power sector modeling analysis of the BIL and IRA in 2022 (U.S. EPA 2023a). The IRA provisions modeled within IPM included:

- Clean Electricity Production and Investment Tax Credits
- Existing Nuclear Production Tax Credit
- Carbon Capture and Storage 45Q Tax Credit

This initial modeling did not include other power sector impacts, such as demand impacts from higher levels of vehicle electrification or IRA energy efficiency provisions, however these are likely to be included in future CAMD power sector analyses.

The initial modeling of the IRA showed a 70 percent reduction of power sector related CO<sub>2</sub> emissions from current levels by 2055, and that the changes in CO<sub>2</sub> emissions would be driven primarily by increases in renewable generation and enabled by increased use of grid battery storage capacity (see Figure 5-6).



**Figure 5-6: Power sector modeling comparing results of the Bipartisan Infrastructure Law (BIL) and the Inflation Reduction Act (IRA).**

### 5.2.3.2 Power Sector Modeling Results for the Final Rule

EPA analyzed two scenarios for the final rule:

- A no-action case that included modeling of electric vehicle provisions from the IRA within the OMEGA compliance model and compliance with 2023 and later GHG standards (86 FR 74434 2021) with the addition of heavy-duty vehicle (Class 4-8) charge demand estimated for the California Advanced Clean Trucks (ACT) Program.
- A final rule policy or "action" case based upon Alternative 3 from the proposed rule with the addition of heavy-duty vehicle charge demand based on an interim scenario developed from the Greenhouse Gas Emissions Standards for Heavy-Duty Vehicles – Phase 3 Proposed Rule (HDP3).

Alternative 3 was one of the compliance scenarios modeled using OMEGA, EVI-X, and IPM during the summer and autumn of 2023. Of the scenarios modeled in IPM after the proposal, Alternative 3 is the closest scenario with respect to PEV charging demand to the final rule and represents the final rule within the power sector analysis. Alternative 3 differs from the finalized program by forecasting slightly higher PEV sales in 2027-2031 than finalized, and thus higher PEV charging demand in earlier years and comparable PEV charging demand after 2032. Thus, power sector impacts on emissions and cost within the final rule analysis should be considered conservatively high estimates. Regionalized heavy-duty vehicle charge demand for both the no-action and policy cases were based upon a combination of NREL EVI-X and LBNL HEVI-LOAD simulations developed as part of the Multi-State Transportation Electrification Impact Study (TEIS) (E. Wood, B. Borlaug, et al., Multi-State Transportation Electrification Impact Study 2024).

One significant difference between the analysis of charge demand for the final rule compared to the analysis for the proposal is the addition to the policy case analysis of an estimate of heavy-

duty vehicle charge demand based on HDP3. The policy case estimates charge demand from this final rule combined together with HDP3. The no-action case analysis (e.g., IRA and ACT) uses similar assumptions to the analysis for the proposal with the exception of updated MDV charge demand inputs and the use of EVI-X and HEVI-LOAD for regionalization of heavy-duty vehicle charge demand. For further information on the development of regionalized light- and medium-duty vehicle charge demand and heavy-duty vehicle charge demand, please refer to Chapter 5.1 and to the TEIS (E. Wood, B. Borlaug, et al., Multi-State Transportation Electrification Impact Study 2024).

Emissions, demand, generation, and costs for the no-action case and for the light- and medium-duty final rule (including heavy-duty demand) are shown in Table 5-2 and Table 5-3, respectively. Note that the total costs presented in both tables represent:

- Capital costs for building new power plants as well as retrofits
- Variable and fixed operation and maintenance costs
- Fuel costs
- Cost of capturing, transporting, and storing CO<sub>2</sub>

**Table 5-2: National electric power sector emissions, demand, generation and cost for the no-action case.**

| <b>Emission</b>   | <b>2028</b> | <b>2030</b> | <b>2035</b> | <b>2040</b> | <b>2045</b> | <b>2050</b> |
|---|-------------|-------------|-------------|-------------|-------------|-------------|
| SO <sub>2</sub> (million metric tons)                         | 0.4928      | 0.2838      | 0.1247      | 0.0828      | 0.0410      | 0.0165      |
| PM <sub>2.5</sub> (million metric tons)                       | 0.07276     | 0.06149     | 0.04410     | 0.03490     | 0.02725     | 0.02363     |
| NO <sub>x</sub> (million metric tons)                         | 0.4950      | 0.3619      | 0.2128      | 0.1544      | 0.1067      | 0.0864      |
| VOC (million metric tons)                                     | 0.03353     | 0.02982     | 0.02404     | 0.01996     | 0.01675     | 0.01548     |
| CO <sub>2</sub> (million metric tons)                         | 1,296       | 1,022       | 638.8       | 479.6       | 406.3       | 347.9       |
| CH <sub>4</sub> (metric tons)                                 | 85,315      | 63,402      | 36,835      | 28,039      | 17,528      | 13,674      |
| N <sub>2</sub> O (metric tons)                                | 11,784      | 8,558       | 4,807       | 3,641       | 2,168       | 1,647       |
| Hg (metric tons)  | 2.538       | 1.997       | 1.469       | 1.320       | 1.072       | 0.9651      |
| HCL (million metric tons)                                     | 2.669       | 1.792       | 0.8476      | 0.6450      | 0.2286      | 0.1037      |
| Total Demand (TWh)  | 4,457       | 4,593       | 4,924       | 5,230       | 5,546       | 5,893       |
| Light- and Medium-duty Vehicle PEV Demand (TWh)               | 98.06       | 157.4       | 265.8       | 326.2       | 362.3       | 384.1       |
| Light- and Medium-duty Vehicle PEV % of Total Demand          | 2.20%       | 3.43%       | 5.40%       | 6.24%       | 6.53%       | 6.52%       |
| Light- and Medium-duty Vehicle PEV % of Transportation Demand | 89.8%       | 87.2%       | 76.8%       | 70.6%       | 67.1%       | 64.8%       |
| Total Generation (TWh)  | 4,548       | 4,739       | 5,183       | 5,593       | 5,982       | 6,465       |
| Total Cost (Billion \$)                                       | 131.2       | 128.1       | 131.9       | 139.7       | 140.8       | 143.0       |

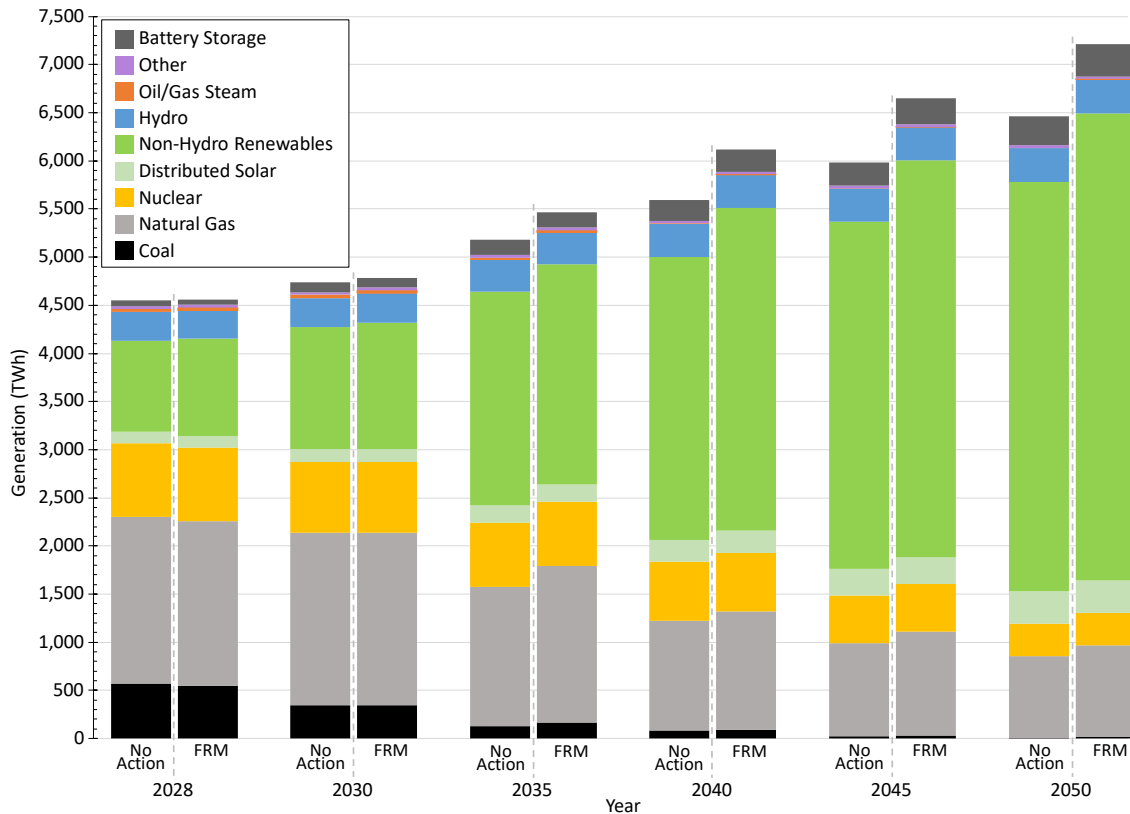
**Table 5-3: National electric power sector emissions, demand, generation and cost for the final rule.**

| <b>Emission</b>   | <b>2028</b> | <b>2030</b> | <b>2035</b> | <b>2040</b> | <b>2045</b> | <b>2050</b> |
|---|-------------|-------------|-------------|-------------|-------------|-------------|
| SO <sub>2</sub> (million metric tons)                         | 0.4792      | 0.2826      | 0.1570      | 0.08755     | 0.04420     | 0.02115     |
| PM <sub>2.5</sub> (million metric tons)                       | 0.07168     | 0.06103     | 0.04861     | 0.03635     | 0.02940     | 0.02541     |
| NO <sub>X</sub> (million metric tons)                         | 0.4856      | 0.3605      | 0.2445      | 0.1593      | 0.1135      | 0.09330     |
| VOC (million metric tons)                                     | 0.03328     | 0.02987     | 0.02568     | 0.02059     | 0.01815     | 0.01592     |
| CO <sub>2</sub> (million metric tons)                         | 1,267       | 1,014       | 737         | 513         | 455         | 394         |
| CH <sub>4</sub> (metric tons)                                 | 82,950      | 63,218      | 42,952      | 30,026      | 19,054      | 15,271      |
| N <sub>2</sub> O (metric tons)                                | 11,439      | 8,530       | 5,642       | 3,908       | 2,360       | 1,846       |
| Hg (metric tons)  | 2.513       | 2.028       | 1.608       | 1.378       | 1.120       | 1.023       |
| HCL (million metric tons)                                     | 2.591       | 1.785       | 1.053       | 0.6930      | 0.2604      | 0.1336      |
| Total Demand (TWh)  | 4,475       | 4,646       | 5,222       | 5,734       | 6,173       | 6,578       |
| Light- and Medium-duty Vehicle PEV Demand (TWh)               | 110.8       | 193.2       | 436.8       | 617.1       | 736.9       | 809.6       |
| Light- and Medium-duty Vehicle PEV % of Total Demand          | 2.48%       | 4.16%       | 8.36%       | 10.8%       | 11.9%       | 12.3%       |
| Light- and Medium-duty Vehicle PEV % of Transportation Demand | 88.5%       | 84.2%       | 70.0%       | 66.3%       | 65.5%       | 65.8%       |
| Total Generation (TWh)  | 4,562       | 4,783       | 5,469       | 6,117       | 6,651       | 7,212       |
| % Change in Generation from No-action                         | 0.293%      | 0.932%      | 5.52%       | 9.38%       | 11.2%       | 11.6%       |
| Total Cost (Billion \$)                                       | 129.8       | 128.5       | 142.4       | 152.3       | 157.0       | 160.4       |
| % Change in Costs from No-action                              | -1.09%      | 0.275%      | 7.97%       | 9.00%       | 11.5%       | 12.2%       |

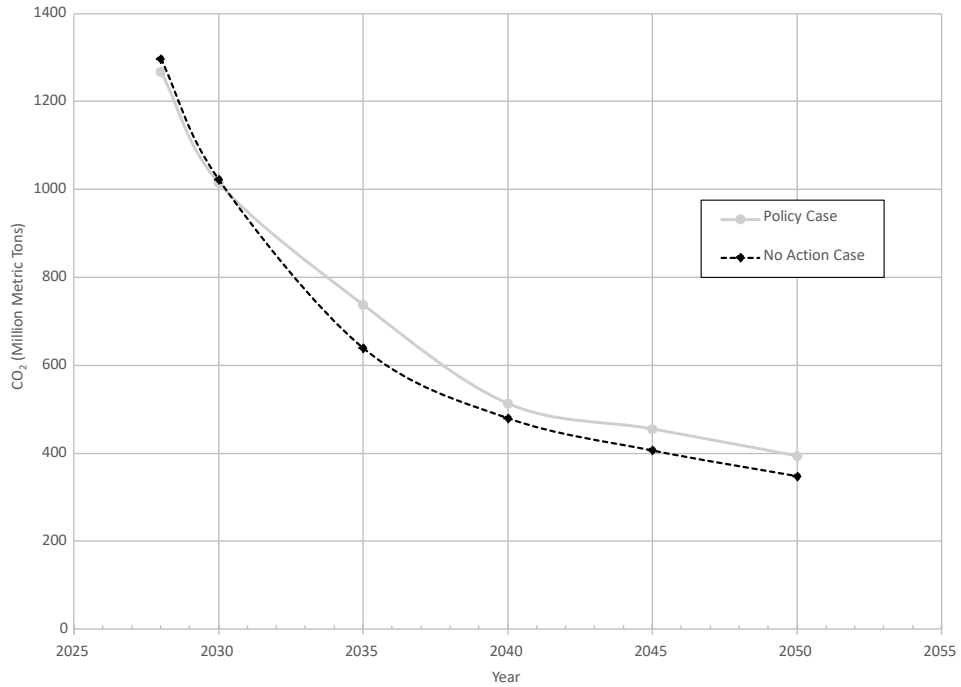
Similar to CAMD's earlier power sector analysis and the previous analysis for the proposal, the power sector analysis for both the final rule and a no-action case show significant year-over-year reductions in CO<sub>2</sub> emissions from 2028 through 2050 despite increased generation. This is primarily due to increased use of renewables for generation as shown in Figure 5-7. The policy case, which estimates the demand due to the light- and medium-duty final rule combined with that of the heavy-duty Phase 3 proposed rule, shows an approximately 11.6 percent increase in generation in 2050 relative to the no-action case. Light- and medium-duty PEV charge demand accounted for approximately 66 percent of total demand for light, medium, and heavy-duty vehicles combined for the policy case, thus we estimate that increased generation at a national level due to the light-and medium-duty final rule alone relative to the no-action case is approximately 7.6 percent in 2050. The policy case has an approximately 13.4 percent increase in CO<sub>2</sub> emissions in 2050 for both the LMDV final rule and HDP3 proposed rule combined (Figure 5-8), of which an increase in CO<sub>2</sub> emissions in 2050 of approximately 8.8 percent is estimated to be due to light- and medium-duty vehicles. It should be noted, however, that the increased EGU emissions are completely offset by net reductions in tailpipe emissions and that there are significant net CO<sub>2</sub> reductions for the final rule (see Chapter 9.6).



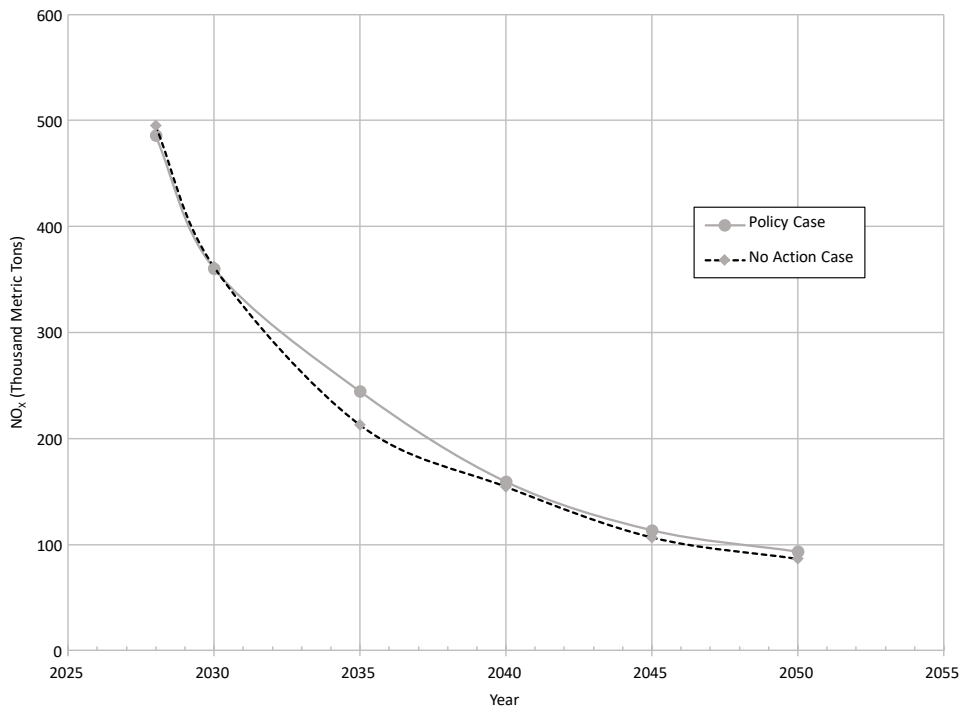
Criteria pollutant emissions (Figure 5-9, Figure 5-10, and Figure 5-11) show similar trends of large year-over-year reductions from 2028 through 2050 due to increased use of renewables for generation, and similar trends of higher EGU emissions for the policy case relative to the no action. As with CO<sub>2</sub> emissions, the increased EGU criteria pollutant emissions are offset by net reductions in tailpipe emissions and petroleum refining (see Chapters 9.5 and 9.6). Also note that EPA is in the process of finalizing updated power sector modeling reflecting additional power sector regulatory actions that will help mitigate such emission changes even further.



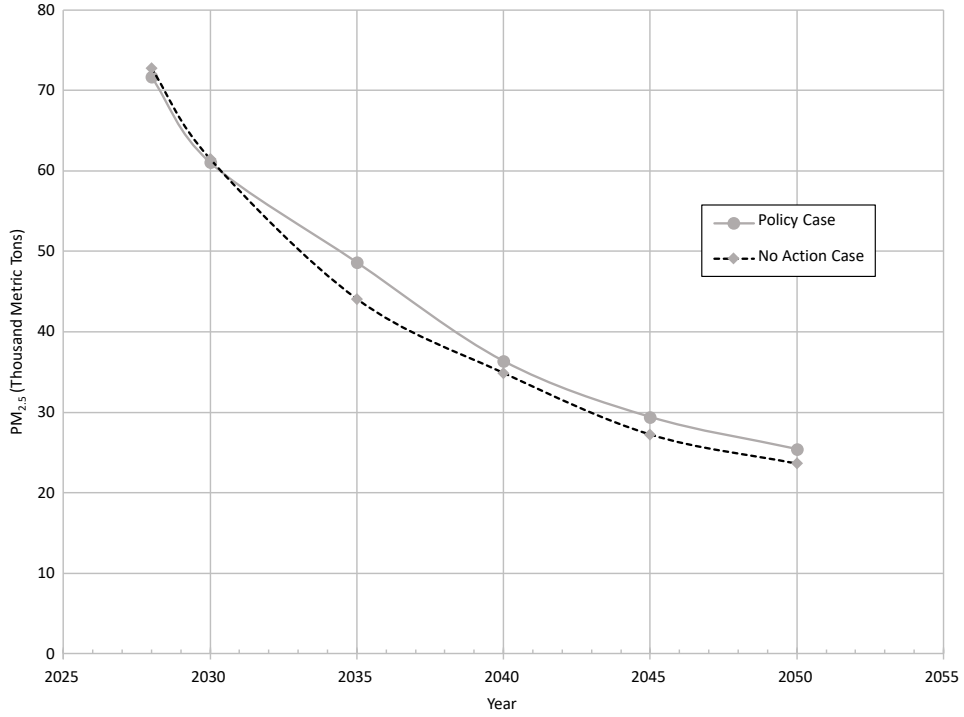
**Figure 5-7: 2028 through 2050 power sector generation and grid mix.**



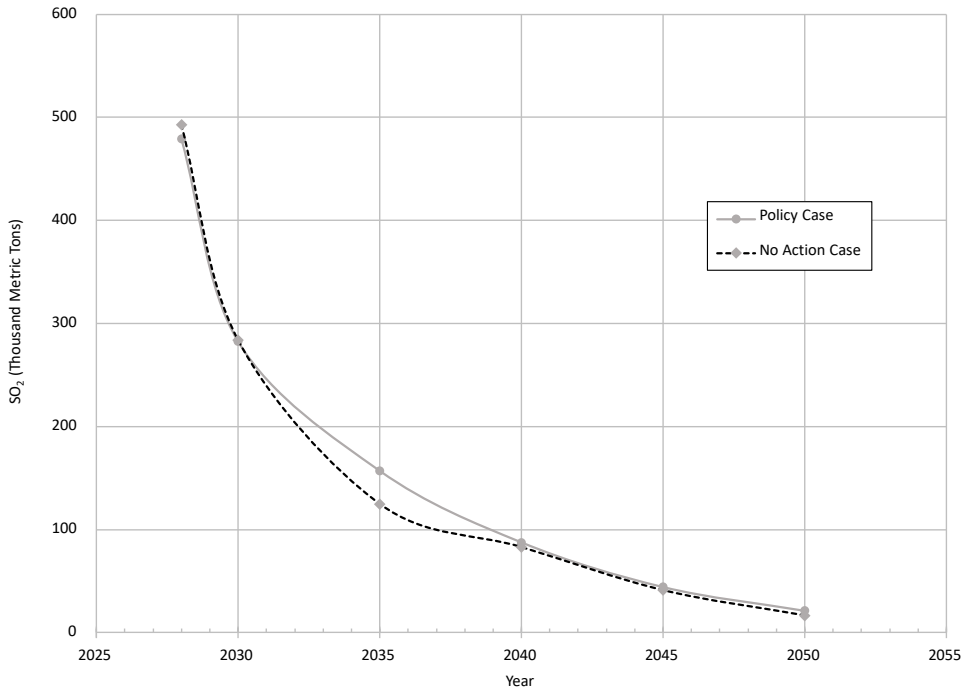
**Figure 5-8: 2028 through 2050 power sector CO<sub>2</sub> emissions for final rule policy case (solid gray line) and no-action case (dashed line).**



**Figure 5-9: 2028 through 2050 power sector NO<sub>x</sub> emissions for final rule policy case (solid gray line) and no-action case (dashed line).**



**Figure 5-10: 2028 through 2050 power sector PM<sub>2.5</sub> emissions for final rule policy case (solid gray line) and no-action case (dashed line).**



**Figure 5-11: 2028 through 2050 power sector SO<sub>2</sub> emissions for final rule policy case (solid gray line) and no-action case (dashed line).**

#### **5.2.4 Retail Price Modeling Results**

EPA estimated the change in the retail price of electricity (2022\$) using the Retail Price Model (RPM) and using the same methodology used in recent EPA power-sector rulemakings (U.S. EPA 2022c). The RPM was developed by ICF for EPA (ICF 2019) and uses the IPM estimates of changes in the cost of generating electricity to estimate the changes in average retail electricity prices. The prices are average prices over consumer classes (i.e., consumer, commercial, and industrial) and regions, weighted by the amount of electricity used by each class and in each region. The RPM combines the IPM annual cost estimates in each of the 67 IPM regions with EIA electricity market data for each of the 25 NERC/ISO<sup>147</sup> electricity supply subregions (Table 5-4 and Figure 5-12) in the electricity market module of the National Energy Modeling System (NEMS) (U.S. Energy Information Administration 2019). The RPM was updated for the final rule to incorporate regional, distribution-level upgrade costs for light-medium- and heavy-duty charging for both the no-action and policy cases based on the TEIS (E. Wood, B. Borlaug, et al., Multi-State Transportation Electrification Impact Study 2024).

Table 5-4 summarizes the projected percentage changes in the retail price of electricity for the final rule versus a no-action case, respectively. National level retail electricity prices from Table 5-4 were used within the analysis of costs and benefits in Chapter 9. Consistent with other projected impacts presented above, average retail electricity price differences at the national level are projected to be between approximately -0.4 percent (i.e., small price decrease) to 2.5 percent in 2030 and 2050, respectively. Regional average retail electricity price differences showed small increases or decreases of approximately -4 percent to 5 percent. There is a general trend of reduced national average retail electricity prices from 2021 through 2050, which is largely due to reduced fuel costs from increased use of renewables for generation.

In the absence of distribution level costs, national-level average retail electricity price differences were projected to be between approximately -0.7 percent and 0.1 percent between 2030 and 2050, reflecting approximately zero change between the no-action and policy cases on retail price of electricity. Comparing these results to the modeling results that included distribution-level upgrade costs, we conclude that most of the estimated 2.5 percent increase in national average retail electricity prices in 2050 can be attributed to distribution-level upgrades.

---

<sup>147</sup> NERC is the National Electricity Reliability Corporation. ISO is an Independent System Operator, sometimes referred to as a Regional Transmission Organization.

**Table 5-4: Average retail electricity price by region for the no-action case and the final rule in 2030 and 2050.**

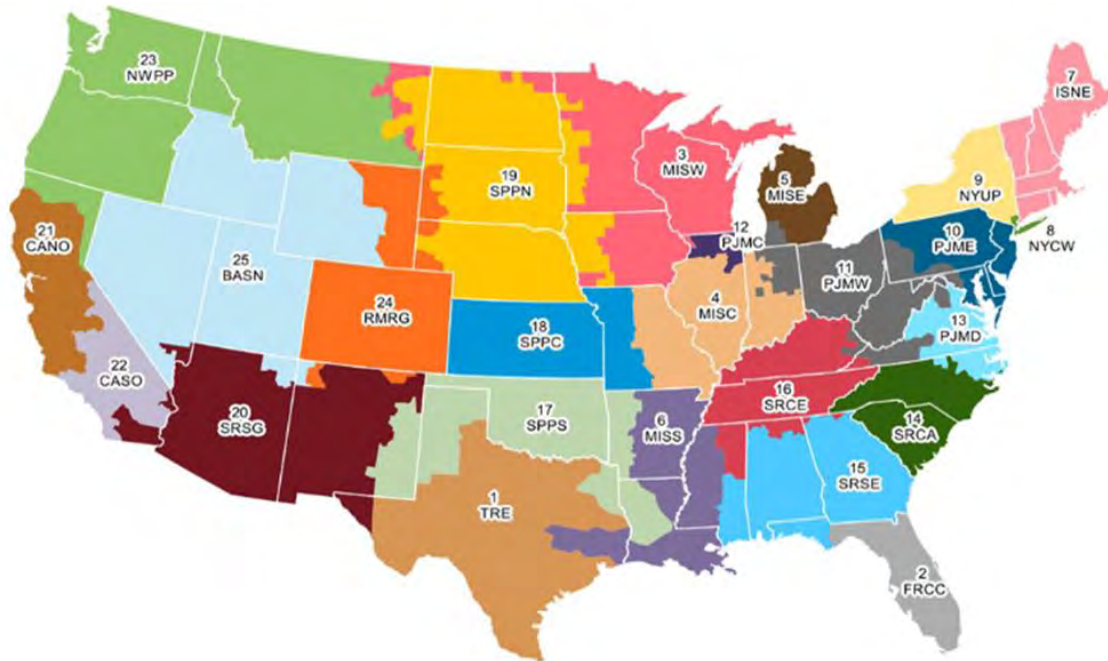
|                             | 2020 <sup>*</sup>           | No-action<br>2030 | Final<br>2030 | No-action<br>2040 | Final<br>2040 | No-action<br>2050 | Final<br>2050 | Percent<br>Change<br>2030 <sup>**</sup> | Percent<br>Change<br>2040 <sup>**</sup> | Percent<br>Change<br>2050 <sup>**</sup> |
|-----------------------------|-----------------------------|-------------------|---------------|-------------------|---------------|-------------------|---------------|---|---|---|
| <b>NERC/ISO<br/>Regions</b> | 2022 mills/kWh <sup>†</sup> |                   |               |                   |               |                   |               |   |   |   |
| TRE                         | 98.7                        | 84.8              | 83.9          | 76.6              | 77.7          | 68.5              | 69.8          | -1.02%                                  | 1.45%                                   | 1.87%                                   |
| FRCC                        | 108.5                       | 102.1             | 102.4         | 100.7             | 103.0         | 90.5              | 93.9          | 0.31%                                   | 2.35%                                   | 3.73%                                   |
| MISW                        | 119.7                       | 93.0              | 92.5          | 104.2             | 105.5         | 100.2             | 101.9         | -0.56%                                  | 1.21%                                   | 1.74%                                   |
| MISC                        | 106.3                       | 102.7             | 101.9         | 78.7              | 80.4          | 82.9              | 85.1          | -0.76%                                  | 2.15%                                   | 2.66%                                   |
| MISE                        | 128.6                       | 115.0             | 110.7         | 104.9             | 107.3         | 97.2              | 100.3         | -3.77%                                  | 2.29%                                   | 3.21%                                   |
| MISS                        | 87.3                        | 102.5             | 102.3         | 90.8              | 91.4          | 81.1              | 82.8          | -0.22%                                  | 0.73%                                   | 2.01%                                   |
| ISNE                        | 197.0                       | 169.2             | 168.6         | 176.1             | 177.1         | 173.8             | 176.2         | -0.41%                                  | 0.59%                                   | 1.36%                                   |
| NYCW                        | 207.1                       | 239.7             | 239.3         | 248.5             | 250.1         | 230.5             | 235.7         | -0.18%                                  | 0.65%                                   | 2.26%                                   |
| NYUP                        | 130.1                       | 148.0             | 147.7         | 151.6             | 152.4         | 135.6             | 137.0         | -0.17%                                  | 0.53%                                   | 1.02%                                   |
| PJME                        | 120.8                       | 129.9             | 125.0         | 129.1             | 131.4         | 119.9             | 123.3         | -3.71%                                  | 1.77%                                   | 2.80%                                   |
| PJMW                        | 114.2                       | 109.2             | 109.2         | 93.7              | 95.3          | 90.1              | 93.2          | -0.06%                                  | 1.69%                                   | 3.47%                                   |
| PJMC                        | 106.0                       | 97.9              | 97.4          | 88.9              | 88.9          | 89.8              | 94.5          | -0.57%                                  | -0.07%                                  | 5.21%                                   |
| PJMD                        | 94.3                        | 82.0              | 82.3          | 84.8              | 86.9          | 80.0              | 82.5          | 0.35%                                   | 2.54%                                   | 3.08%                                   |
| SRCA                        | 113.4                       | 108.1             | 109.0         | 134.7             | 136.7         | 101.2             | 104.4         | 0.78%                                   | 1.54%                                   | 3.18%                                   |
| SRSE                        | 112.2                       | 104.0             | 104.3         | 88.9              | 90.4          | 86.1              | 87.8          | 0.30%                                   | 1.70%                                   | 2.01%                                   |
| SRCE                        | 93.9                        | 119.5             | 119.9         | 94.5              | 96.1          | 81.8              | 84.1          | 0.33%                                   | 1.64%                                   | 2.82%                                   |
| SPPS                        | 87.5                        | 80.3              | 80.6          | 68.2              | 69.9          | 74.4              | 76.5          | 0.37%                                   | 2.44%                                   | 2.76%                                   |
| SPPC                        | 116.0                       | 92.4              | 92.9          | 85.4              | 85.3          | 70.7              | 71.8          | 0.54%                                   | -0.03%                                  | 1.63%                                   |
| SPPN                        | 79.0                        | 69.5              | 69.6          | 81.6              | 82.5          | 67.6              | 69.0          | 0.20%                                   | 1.12%                                   | 2.15%                                   |
| SRSR                        | 109.6                       | 96.5              | 98.6          | 101.5             | 102.5         | 94.5              | 96.1          | 2.15%                                   | 0.98%                                   | 1.70%                                   |
| CANO                        | 166.8                       | 183.2             | 182.3         | 179.8             | 182.4         | 176.7             | 180.1         | -0.49%                                  | 1.45%                                   | 1.90%                                   |
| CASO                        | 198.1                       | 219.2             | 217.0         | 218.7             | 219.7         | 202.3             | 203.8         | -1.04%                                  | 0.43%                                   | 0.75%                                   |
| NWPP                        | 96.2                        | 89.2              | 89.9          | 98.4              | 102.1         | 91.7              | 95.9          | 0.80%                                   | 3.76%                                   | 4.55%                                   |
| RMRG                        | 108.3                       | 98.0              | 97.4          | 93.1              | 94.2          | 88.4              | 89.3          | -0.63%                                  | 1.11%                                   | 1.11%                                   |
| BASN                        | 101.0                       | 100.5             | 101.7         | 99.4              | 99.5          | 87.4              | 89.7          | 1.18%                                   | 0.02%                                   | 2.64%                                   |
| National                    | 116.4                       | 113.4             | 113.0         | 109.8             | 111.4         | 101.5             | 104.0         | -0.37%                                  | 1.47%                                   | 2.46%                                   |

Table Notes:

\* From Post-IRA 2022 Reference Case - EPA's Power Sector Modeling Platform v6 Using IPM (U.S. EPA 2023a)

\*\* Percentage increase in average retail electricity price for the final rule to a no-action case. Negative percentages reflect a decrease in average retail electricity price for the final rule.

† One mill is equal to 1/1,000 U.S. dollar, or 1/10 U.S. cent. 2022 mills per kilowatt-hour (mills/kWh) are also equivalent to 2022 dollars per megawatt-hour (\$/MWh)



**Figure 5-12: Electricity Market Module Regions (U.S. Energy Information Administration 2019).**

### **5.2.5 New Builds, Retrofits and Retirements of EGUs**

The electric power sector emissions modeling undertaken in support of this rulemaking, using IPM (described at the beginning of Chapter 5.2), also projects the anticipated mix of electric power plants required to meet the imposed electricity demand from vehicle electrification, subject to various constraints. These power plants are referred to here collectively as Electric Generating Units (EGU). This definition includes all types of generating facilities (e.g. fossil fuel-fired combustion, nuclear, hydroelectric, solar, wind, other renewables, etc.).

This modeling reveals anticipated EGU retirements, EGU retrofits, and new EGU construction, which are discussed below. EGUs are retired by IPM when announced by their owner and for economic reasons. The IRA and BIL resulted in many EGU retirements. As such, the number and types of EGU retirements associated with the final rule when compared to a no-action case are small in comparison to those retirements that occurred as a result of the IRA and BIL.

New EGU capacity modelled by IPM for the no-action case is summarized in Table 5-5. New EGU capacity modelled by IPM for the final rule is summarized in Table 5-6. EGU retirements modelled by IPM for the no-action and for the final rule are summarized in Table 5-7 and Table 5-8.

For the no-action case, the retirement of coal-fired EGUs account for the vast majority of all EGU retirements through 2050 (see Figure 5-8). For the final rule, the retirement of coal-fired EGUs are very similar to the no-action case (see Table 5-8). New generation for the final rule is similar to the no-action case. For both the no action case and the final rule, cumulative power generation from new solar and new wind EGU builds and battery energy storage are expected to

account for an increasing fraction of all new power generation through 2050 (see Chapter 5.2.3.2 and Figure 5-7). Wind-driven EGUs are expected to become the single largest new source of EGU capacity for 2040 through 2050, and solar-powered EGUs are expected to comprise the second largest new source of EGU capacity for 2040 through 2050.

**Table 5-5: Projected EGU capacity for the no-action case.**

| NEW MODELED CAPACITY (Cumulative GW)               | 2028      | 2030       | 2035       | 2040       | 2045         | 2050         |
|--|-----------|------------|------------|------------|--------------|--------------|
| <b>Hydro</b>                                       | <b>0</b>  | <b>1</b>   | <b>6</b>   | <b>8</b>   | <b>8</b>     | <b>8</b>     |
| <b>Non-Hydro Renewables</b>                        | <b>36</b> | <b>126</b> | <b>405</b> | <b>623</b> | <b>818</b>   | <b>1,030</b> |
| Biomass  | 0         | 0          | 0          | 0          | 0            | 0            |
| Geothermal   | 0         | 0          | 0          | 0          | 0            | 0            |
| Landfill Gas                                       | 1         | 1          | 1          | 1          | 1            | 1            |
| Solar  | 5         | 44         | 155        | 251        | 310          | 414          |
| Wind   | 29        | 81         | 248        | 370        | 506          | 615          |
| <b>Coal</b>  | <b>0</b>  | <b>0</b>   | <b>0</b>   | <b>0</b>   | <b>0</b>     | <b>0</b>     |
| Coal without Carbon Capture & Sequestration (CCS)  | 0         | 0          | 0          | 0          | 0            | 0            |
| Integrated Gasification Combined Cycle without CCS | 0         | 0          | 0          | 0          | 0            | 0            |
| Coal with CCS                                      | 0         | 0          | 0          | 0          | 0            | 0            |
| <b>Energy Storage</b>                              | <b>23</b> | <b>52</b>  | <b>84</b>  | <b>107</b> | <b>118</b>   | <b>142</b>   |
| <b>Nuclear</b>                                     | <b>0</b>  | <b>0</b>   | <b>0</b>   | <b>0</b>   | <b>0</b>     | <b>0</b>     |
| <b>Natural Gas</b>                                 | <b>20</b> | <b>25</b>  | <b>36</b>  | <b>76</b>  | <b>168</b>   | <b>270</b>   |
| Combined Cycle without CCS                         | 13        | 16         | 20         | 21         | 23           | 24           |
| Combined Cycle with CCS                            | 0         | 0          | 0          | 0          | 0            | 0            |
| Combustion Turbine                                 | 7         | 9          | 16         | 55         | 145          | 245          |
| <b>Other</b>                                       | <b>0</b>  | <b>0</b>   | <b>0</b>   | <b>0</b>   | <b>0</b>     | <b>0</b>     |
| <b>Grand Total</b>                                 | <b>80</b> | <b>204</b> | <b>531</b> | <b>814</b> | <b>1,111</b> | <b>1,451</b> |

**Table 5-6: Projected EGU capacity for the final rule.**

| NEW MODELED CAPACITY (Cumulative GW)               | 2028      | 2030       | 2035       | 2040       | 2045         | 2050         |
|--|-----------|------------|------------|------------|--------------|--------------|
| <b>Hydro</b>                                       | <b>0</b>  | <b>2</b>   | <b>6</b>   | <b>9</b>   | <b>9</b>     | <b>9</b>     |
| <b>Non-Hydro Renewables</b>                        | <b>49</b> | <b>140</b> | <b>421</b> | <b>741</b> | <b>974</b>   | <b>1,209</b> |
| Biomass  | 0         | 0          | 0          | 0          | 0            | 0            |
| Geothermal   | 0         | 0          | 0          | 0          | 0            | 0            |
| Landfill Gas                                       | 1         | 1          | 1          | 1          | 1            | 1            |
| Solar  | 6         | 45         | 159        | 282        | 368          | 479          |
| Wind   | 41        | 93         | 260        | 457        | 605          | 729          |
| <b>Coal</b>  | <b>0</b>  | <b>0</b>   | <b>0</b>   | <b>0</b>   | <b>0</b>     | <b>0</b>     |
| Coal without CCS                                   | 0         | 0          | 0          | 0          | 0            | 0            |
| Integrated Gasification Combined Cycle without CCS | 0         | 0          | 0          | 0          | 0            | 0            |
| Coal with CCS                                      | 0         | 0          | 0          | 0          | 0            | 0            |
| <b>Energy Storage</b>                              | <b>20</b> | <b>48</b>  | <b>82</b>  | <b>112</b> | <b>130</b>   | <b>154</b>   |
| <b>Nuclear</b>                                     | <b>0</b>  | <b>0</b>   | <b>0</b>   | <b>0</b>   | <b>0</b>     | <b>0</b>     |
| <b>Natural Gas</b>                                 | <b>19</b> | <b>23</b>  | <b>43</b>  | <b>92</b>  | <b>193</b>   | <b>306</b>   |
| Combined Cycle without CCS                         | 14        | 18         | 31         | 32         | 37           | 42           |
| Combined Cycle with CCS                            | 0         | 0          | 0          | 0          | 0            | 0            |
| Combustion Turbine                                 | 4         | 5          | 12         | 60         | 156          | 264          |
| <b>Other</b>                                       | <b>0</b>  | <b>0</b>   | <b>0</b>   | <b>0</b>   | <b>0</b>     | <b>0</b>     |
| <b>Grand Total</b>                                 | <b>88</b> | <b>212</b> | <b>552</b> | <b>954</b> | <b>1,305</b> | <b>1,678</b> |

**Table 5-7: EGU retirements for the no-action case.**

| RETIREMENTS (GW)                                   | 2028 | 2030 | 2035 | 2040 | 2045 | 2050 |
|--|------|------|------|------|------|------|
| Combined Cycle Retirements                         | 1    | 1    | 2    | 2    | 6    | 15   |
| Coal Retirements                                   | 34   | 79   | 105  | 115  | 126  | 140  |
| Combustion Turbine Retirements                     | 0    | 1    | 2    | 3    | 14   | 19   |
| Nuclear Retirements                                | 0    | 3    | 10   | 15   | 29   | 48   |
| Oil/Gas Steam Retirements                          | 5    | 7    | 13   | 15   | 15   | 17   |
| Integrated Gasification Combined Cycle Retirements | 0    | 0    | 1    | 1    | 1    | 1    |
| Biomass Retirements                                | 3    | 3    | 3    | 3    | 3    | 3    |
| Fuel Cell Retirements                              | 0    | 0    | 0    | 0    | 0    | 0    |
| Fossil-Other Retirements                           | 0    | 0    | 0    | 0    | 0    | 0    |
| Geothermal Retirements                             | 0    | 0    | 0    | 0    | 0    | 0    |
| Hydro Retirements                                  | 0    | 0    | 0    | 0    | 0    | 0    |
| Landfill Gas Retirements                           | 0    | 0    | 0    | 0    | 0    | 0    |
| Non-Fossil, Other Retirements                      | 0    | 0    | 0    | 0    | 0    | 0    |
| Energy Storage Retirements                         | 0    | 0    | 0    | 0    | 0    | 0    |
| Grand Total  | 44   | 93   | 137  | 153  | 194  | 243  |

**Table 5-8: EGU retirements for the final rule.**

| RETIREMENTS (GW)                                   | 2028 | 2030 | 2035 | 2040 | 2045 | 2050 |
|--|------|------|------|------|------|------|
| Combined Cycle Retirements                         | 1    | 1    | 2    | 2    | 6    | 15   |
| Coal Retirements                                   | 37   | 80   | 102  | 112  | 125  | 138  |
| Combustion Turbine Retirements                     | 0    | 1    | 2    | 3    | 14   | 19   |
| Nuclear Retirements                                | 0    | 3    | 10   | 15   | 29   | 48   |
| Oil/Gas Steam Retirements                          | 6    | 8    | 14   | 15   | 15   | 17   |
| Integrated Gasification Combined Cycle Retirements | 0    | 0    | 1    | 1    | 1    | 1    |
| Biomass Retirements                                | 3    | 3    | 3    | 3    | 3    | 3    |
| Fuel Cell Retirements                              | 0    | 0    | 0    | 0    | 0    | 0    |
| Fossil-Other Retirements                           | 0    | 0    | 0    | 0    | 0    | 0    |
| Geothermal Retirements                             | 0    | 0    | 0    | 0    | 0    | 0    |
| Hydro Retirements                                  | 0    | 0    | 0    | 0    | 0    | 0    |
| Landfill Gas Retirements                           | 0    | 0    | 0    | 0    | 0    | 0    |
| Non-Fossil, Other Retirements                      | 0    | 0    | 0    | 0    | 0    | 0    |
| Energy Storage Retirements                         | 0    | 0    | 0    | 0    | 0    | 0    |
| Grand Total  | 48   | 97   | 133  | 150  | 192  | 242  |

### 5.2.6 Interregional Dispatch

IPM results showing international dispatch are summarized for a no-action case and for the final rule in Table 5-9 and Table 5-10, respectively. International dispatch only occurred between Canada and the contiguous United States represented by the IPM regions. Net international dispatch was also very small as a percentage of total U.S. electricity demand, with electricity imports less than 0.6 percent for all years and trending towards a very small net export by 2050 for both the no-action case and final rule.

**Table 5-9: IPM results for net export of electricity into the contiguous United States for the no-action case.\*,†**

|  | 2028   | 2030   | 2035   | 2040  | 2045  | 2050  |
|--|--------|--------|--------|-------|-------|-------|
| Net US Exports (TWh)                               | -26.2  | -22.9  | -7.3   | 7.9   | 12.1  | 14.8  |
| US Electricity Demand (TWh)                        | 4,457  | 4,593  | 4,924  | 5,230 | 5,546 | 5,893 |
| Net US Exports as a Percentage of Total Demand (%) | -0.59% | -0.50% | -0.15% | 0.15% | 0.22% | 0.25% |

Table Notes:

\* Negative net exports represent imports of electricity

† International dispatch to the contiguous United States only occurred over the U.S. - Canada border.



**Table 5-10: IPM results for net export of electricity into the contiguous United States for the final rule.<sup>\*,†</sup>**

|   | 2028   | 2030   | 2035   | 2040  | 2045  | 2050  |
|---|--------|--------|--------|-------|-------|-------|
| Net US Exports (TWh)  | -26.9  | -23.1  | -10.1  | 6.2   | 13.2  | 18.7  |
| US Electricity Demand (TWh)   | 4,475  | 4,646  | 5,222  | 5,734 | 6,173 | 6,578 |
| Net US Exports as a Percentage of Total Demand (%)  | -0.60% | -0.50% | -0.19% | 0.11% | 0.21% | 0.28% |
| Table Notes:  |        |        |        |       |       |       |
| * Negative net exports represent imports of electricity   |        |        |        |       |       |       |
| † International dispatch to the contiguous United States only occurred over the U.S. - Canada border. |        |        |        |       |       |       |

International dispatch only occurred between Canada and the contiguous United States represented by the IPM regions. To estimate interregional dispatch, IPM utilizes Total Transfer Capabilities (TTCs), a metric that represents the capability of the power system to import or export power reliably from one region to another.

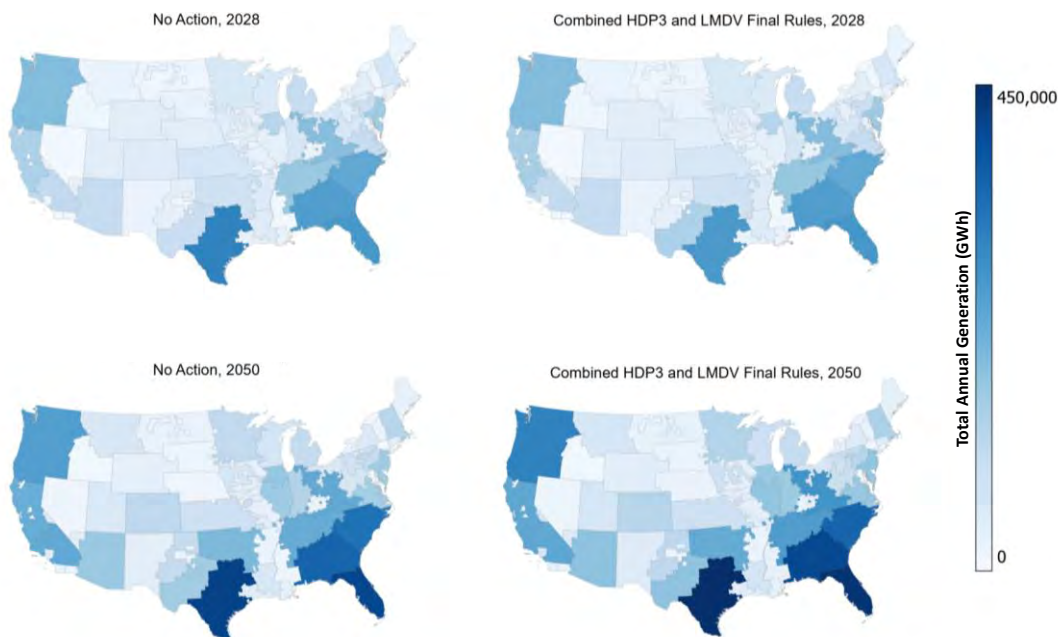
The amount of energy and capacity transferred on a given transmission line between IPM regions is modeled on a seasonal basis for all run years in the EPA Platform v6. All the modeled transmission lines have the same TTCs for all seasons. The maximum values for these metrics were obtained from public sources such as market reports and regional transmission plans, wherever available. Where public sources were not available, the maximum values for TTCs are based on ICF’s expert view. ICF analyzes the operation of the grid under normal and contingency conditions, using industry-standard methods, and calculates the transfer capabilities between regions. To calculate the transfer capabilities, ICF uses standard power flow data developed by the market operators, transmission providers, or utilities, as appropriate. Additional information regarding power-sector modeling is available via a report submitted to the docket (U.S. EPA 2023a).

**5.2.7 Regional Comparison of No Action and Final Rule IPM Emissions and Generation Results**

For the final rule, the total number of electric vehicles in the nationwide fleet is expected to increase after the final effective year of the rule. While reduced production of ICE vehicles will significantly reduce on-road emissions, the burden of charging PEVs is placed on the electrical grid. Power sector emissions vary regionally based on the mix of energy sources and the emissions associated with each source. This section will compare the energy generation and emissions of greenhouse gases, criteria pollutants, and key air toxic emissions between the no action case and the final rule.

On a regional level, generation is roughly proportional to population size (Figure 5-13). From 2028 to 2050, total generation is expected to increase across most regions, and total generation under the final rule will outpace the no action case, as expected given the difference in nationwide total generation between the two cases (see Chapter 5.2.3.2). A handful of regions are expected to see a decrease in power sector generation, including Arkansas, Idaho, Kentucky, Maryland, Nebraska, Wyoming, and parts of Montana and North Dakota. In each of these regions, coal, nuclear, and natural gas facilities are incrementally phased out over the modeled period. This is also the case for most other regions; however, these listed areas experience a net decrease in total generation due to slower introduction of nonhydroelectric renewable capacity. For example, under the final rule in 2028, Wyoming will generate 25.7 TWh from coal, 0.38 TWh from solar, and 19.6 TWh from wind; in 2050, coal, solar, and wind will generate 3.4, 4.3,

and 29.9 TWh, respectively. Wyoming has a long history of coal mining and until recent years has relied almost exclusively on coal-fired power plants for generation within the region. Most of Wyoming's oldest coal-fired EGUs are scheduled to retire by 2038, which will drastically reduce the region's total coal capacity at a rate that new solar and wind facilities are not projected to keep pace with by 2050.



**Figure 5-13: Total Generation by IPM Region in 2028 and 2050 in No Action Case and Final Rule.**

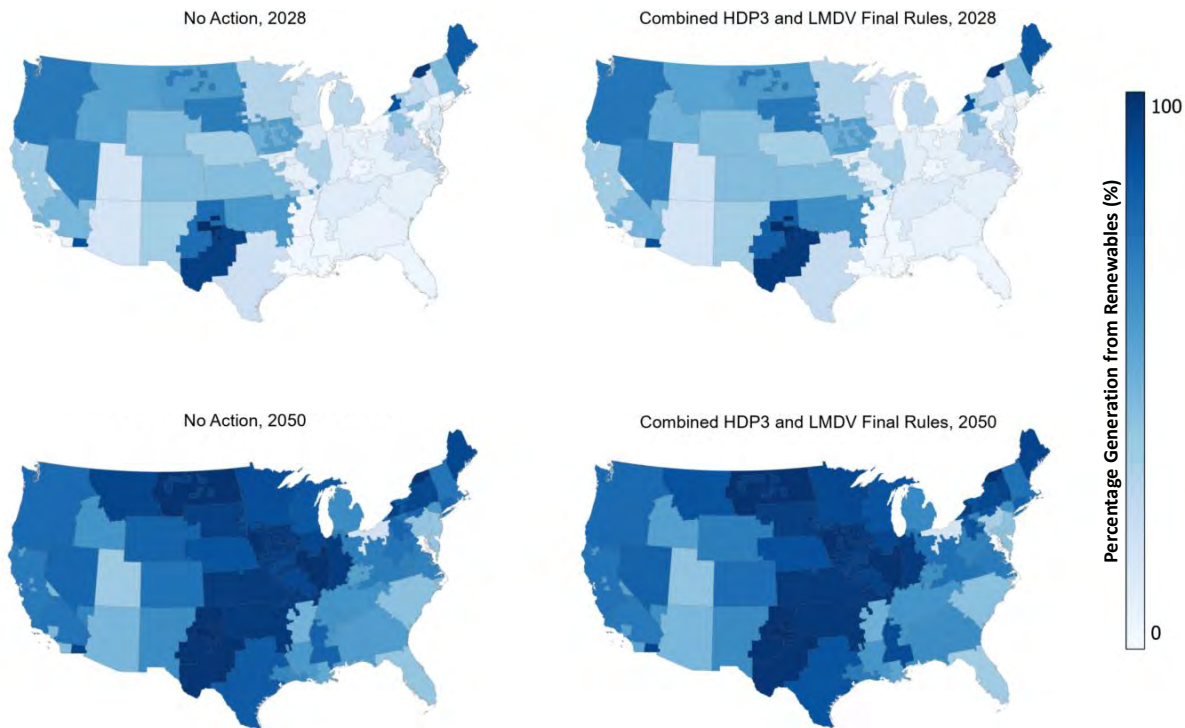
Understanding the sources from which each region receives their energy is also vital to ensuring that the reduced tailpipe emissions are not exceeded by increased regional emissions from EGUs. From 2028 to 2050, the composition of the national energy sector will experience significant shifts toward renewable energy sources, primarily wind and solar. For both the no action case and the final rule, nonhydroelectric renewables account for approximately one-fourth of nationwide generation in 2028 and by 2050 renewables account for approximately three-fourths of generation. These projections are based on planned retirements and expansions of existing facilities as well as plans for new builds of EGUs and transmission lines.

With respect to new transmission, the need for new transmission lines associated with the LMDV and HDP3 rules between now and 2050 is projected to be very small, approximately one-percent or less of transmission. Nearly all of the projected new transmission builds appear to overlap with pre-existing transmission line right of ways (ROW), which makes the permitting process simpler. Approximately 41-percent of the potential new transmission line builds projected by IPM have already been independently publicly proposed by developers. The approximate regional distribution of the potential new transmission line builds are:

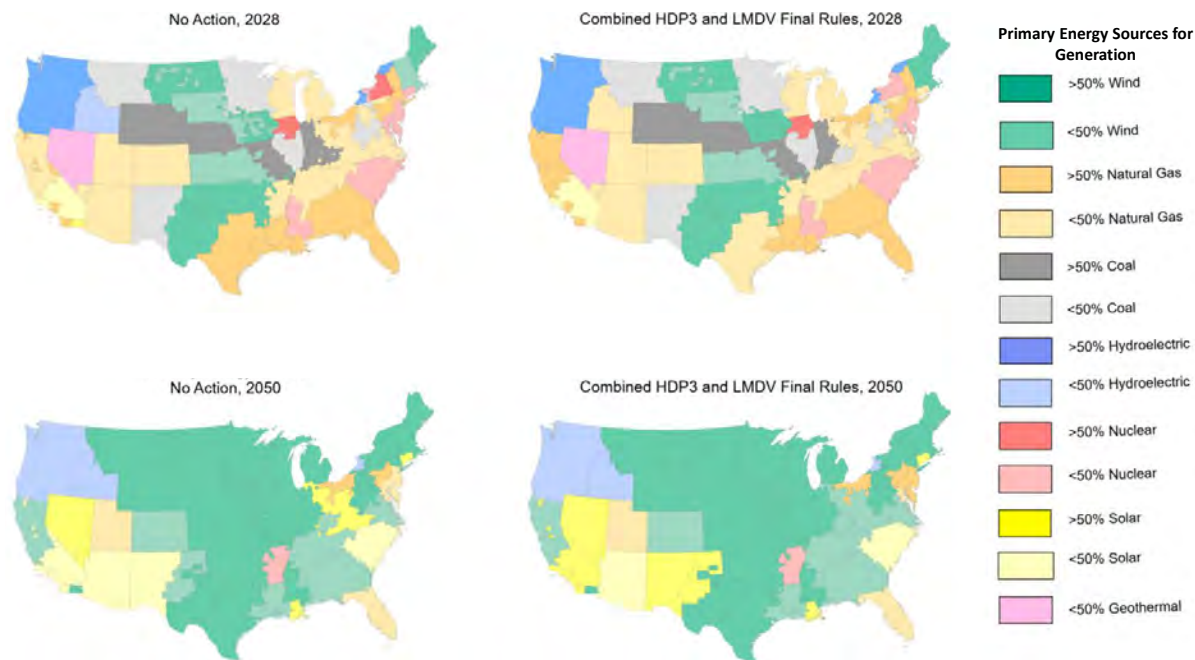
- 24 percent in the West (excluding Southern California), which are largely Federal lands, that are more-easily permittable for new transmission builds;

- 21 percent in the desert Southwest, which are largely Federal lands, that are more-easily permittable for new transmission builds;
- 14 percent in the Midwest;
- 9 percent for each of the Northeast, Mid-Atlantic, and Southeast and Mid-Atlantic regions; and
- 5 percent each for Southern California and New York State/City regions.

In 2028, the primary energy source for electric generation varies considerably by region, with many regions still relying heavily on coal, nuclear, and natural gas. By 2050, nonrenewable energy is the primary energy source in only ten regions, and the vast majority of the country will generate over 50 percent of their total electricity from wind turbines. Renewables, including wind, solar, hydroelectric, and geothermal, will compose approximately three-fourths of nationwide energy generation (see Figure 5-14 and Figure 5-15). There are very few differences between the primary energy sources in the no action case and the final rule by 2050.

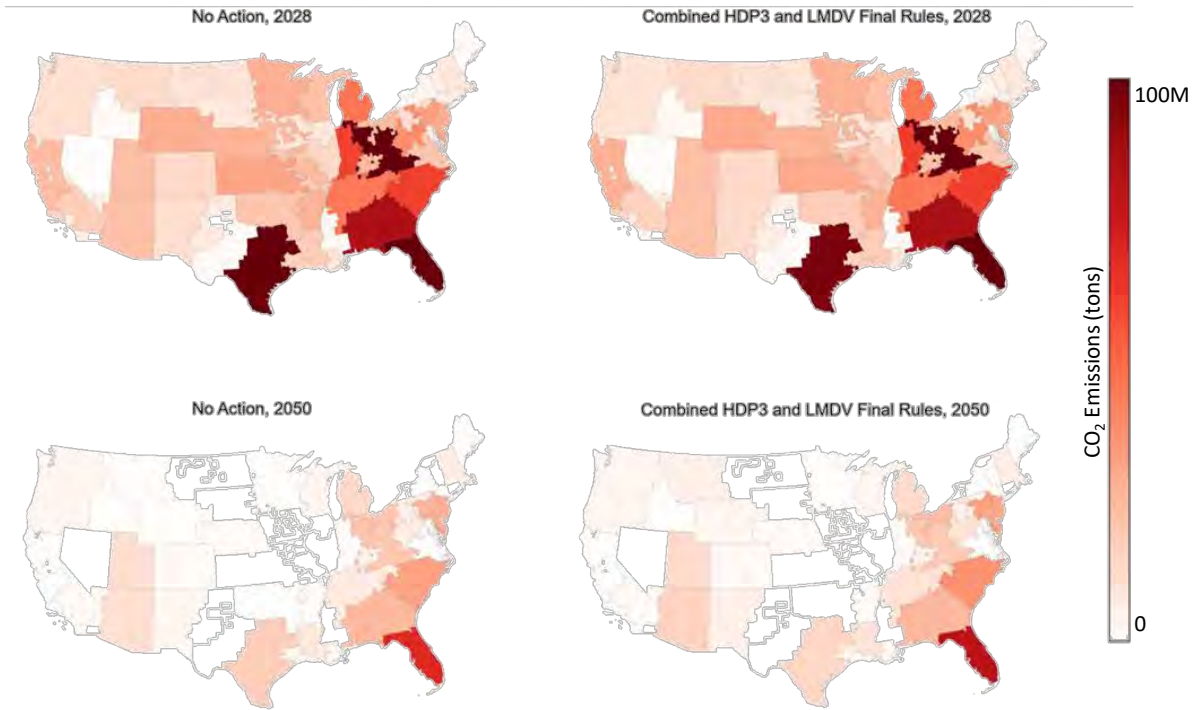


**Figure 5-14: Percentage of Total Generation from Renewable Energy Sources in 2028 and 2050 in No Action Case and Final Rule.**

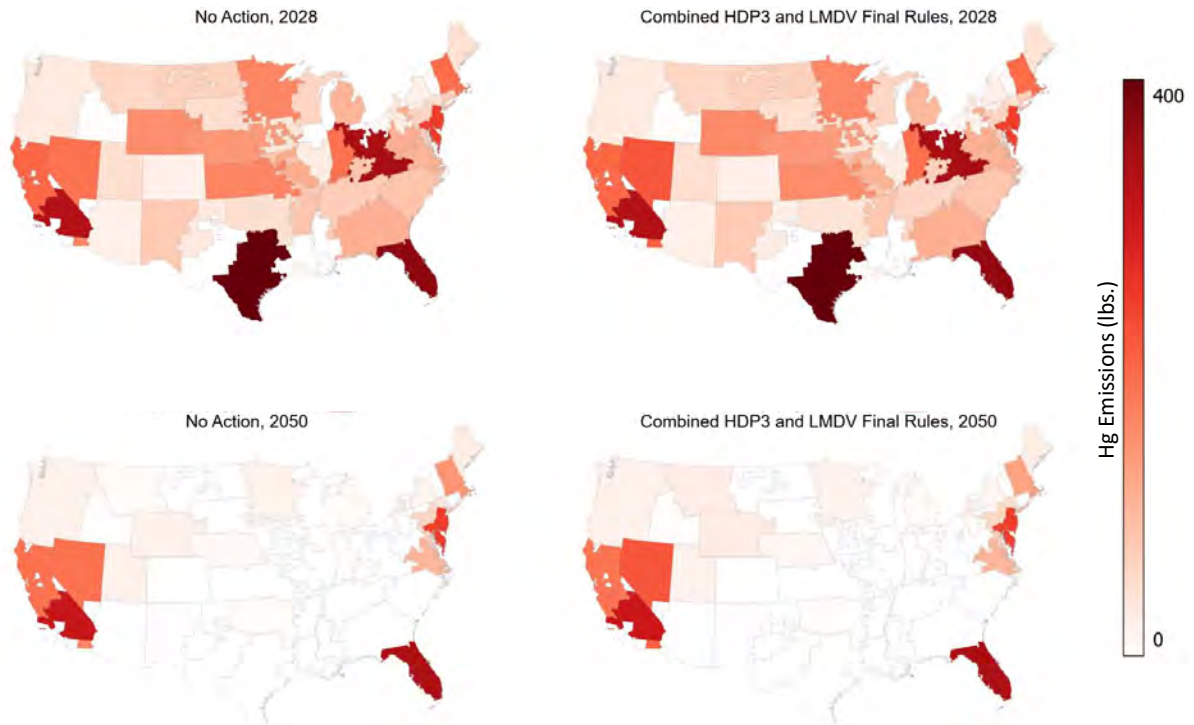


**Figure 5-15: Primary Energy Source by IPM Region in 2028 and 2050 in No Action Case and Final Rule.**

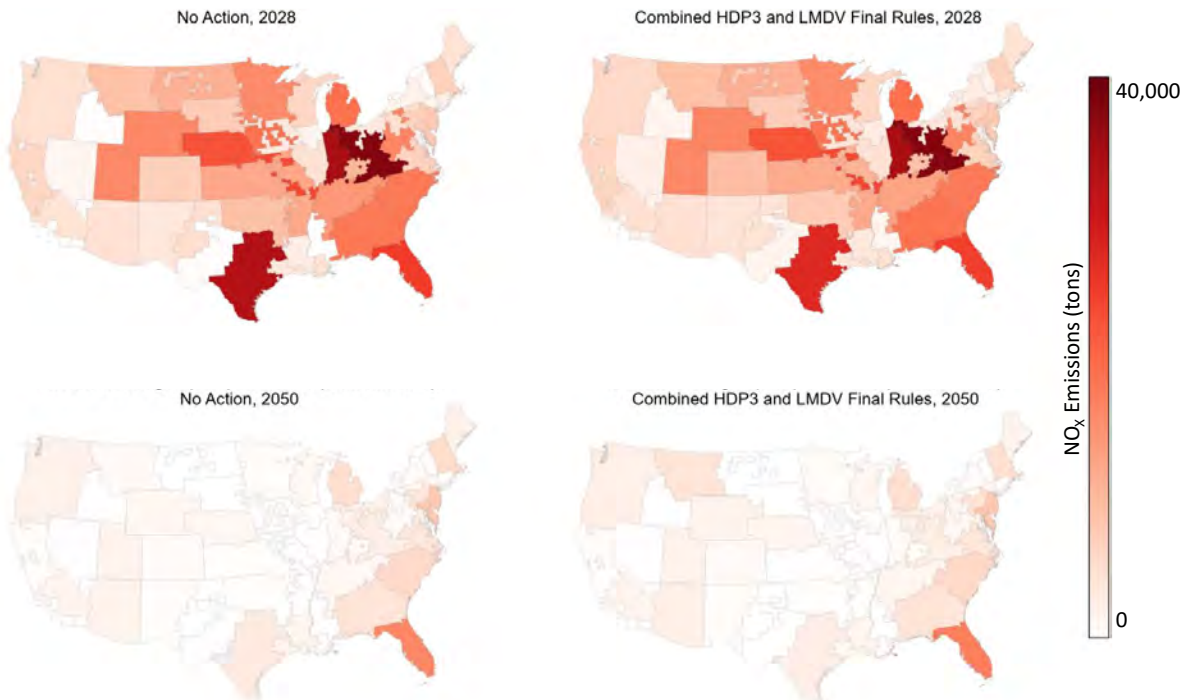
Emissions directly associated with the power sector decrease significantly in both the no action case and the final rule year over year due to increased reliance on renewables for generation, but there are a small number of IPM regions in which emissions increase by less than 0.5 percent, and one case in which SO<sub>2</sub> increases to the same degree in both the no action and final rule within the Midcontinent ISO in Louisiana. Figure 5-16 through Figure 5-20 show the total emissions of CO<sub>2</sub>, NO<sub>x</sub>, PM<sub>2.5</sub>, SO<sub>2</sub>, and mercury, respectively.



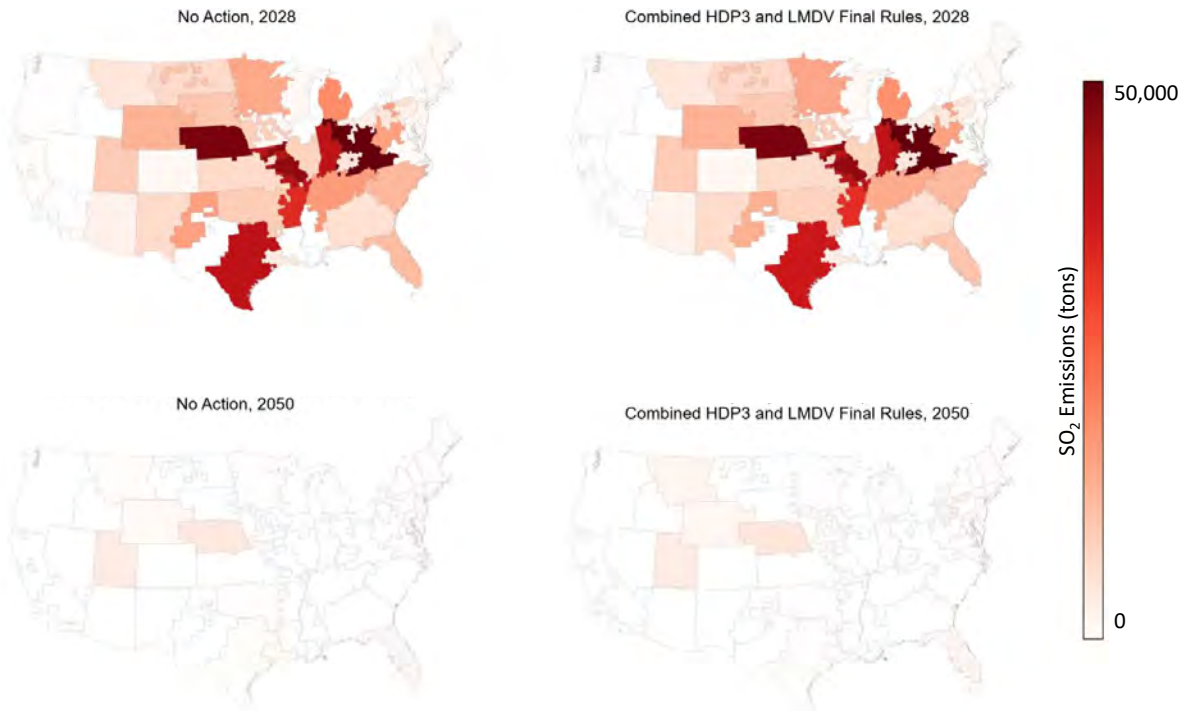
**Figure 5-16: Comparing CO<sub>2</sub> Emissions between the No Action Case and Final Rule in 2028 and 2050.**



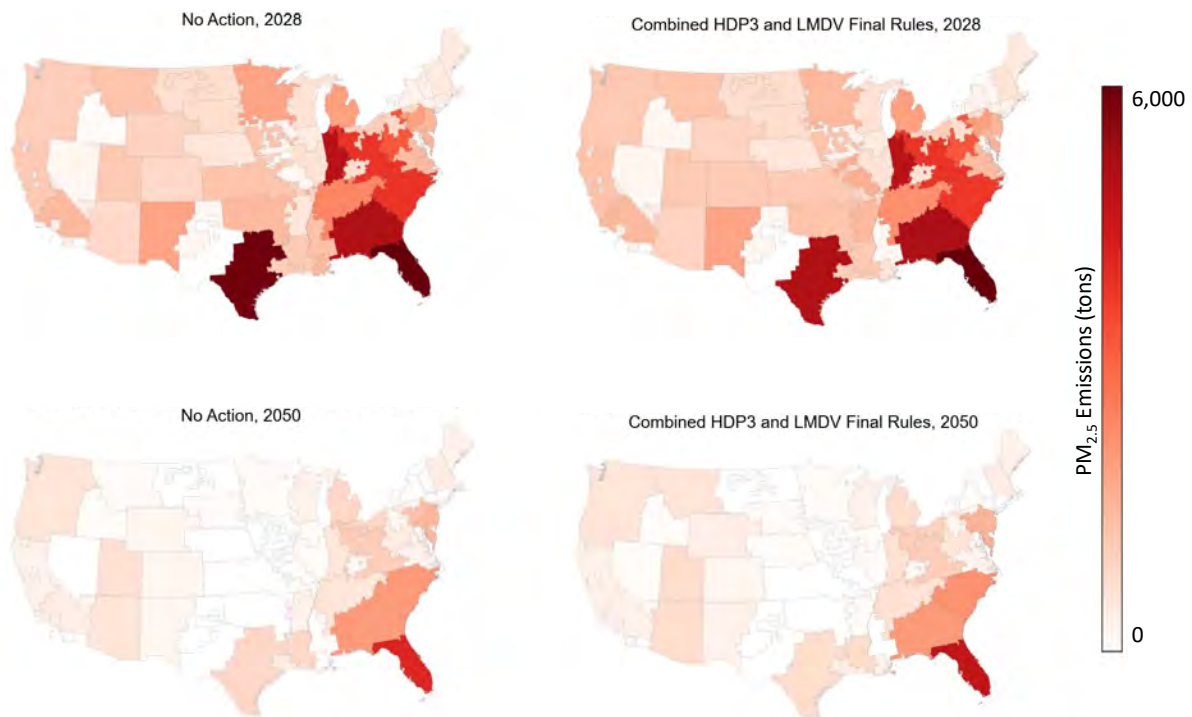
**Figure 5-17: Comparing Mercury (Hg) Emissions between the No Action Case and Final Rule in 2028 and 2050.**



**Figure 5-18: Comparing NO<sub>x</sub> Emissions between the No Action Case and Final Rule in 2028 and 2050.**



**Figure 5-19: Comparing SO<sub>2</sub> Emissions between the No Action Case and Final Rule in 2028 and 2050.**



**Figure 5-20: Comparing PM<sub>2.5</sub> Emissions between the No Action Case and Final Rule in 2028 and 2050.**

Power sector emissions are projected to be slightly higher in the final rule than in the no action case both nationally and regionally due to the higher energy demand for the final rule from PEV charging. Due to this higher demand, some nonrenewable energy facilities, particularly natural gas, are projected to produce more energy in 2050 in the final rule than in the no action case. In the southwest portion of the country, the primary energy source is projected to be natural gas in 2050, and this is reflected by projections of elevated CO<sub>2</sub> emissions. Under the final rule, Arizona is projected to generate approximately 9 TWh more energy from natural gas than the no action case. In the region, 2050 CO<sub>2</sub> emissions are projected to be 16,826 thousand tons under the final rule and 11,981 thousand tons in the no action case. These are both significant reductions from 2028, which have projected CO<sub>2</sub> emissions of 23 million tons in the no action case and 23.3 million tons in the final rule case.

Overall net emissions of criteria air pollutants and GHG due to the final rule (i.e., the net sum of power sector emissions, tailpipe emissions, refinery emissions, etc.) are still significantly reduced both nationally and in nearly all regions of the U.S. For summaries of net emissions, please refer to RIA Chapters 7.4 and 8.6.

### 5.3 Assessment of PEV Charging Infrastructure

As PEV adoption grows, more charging infrastructure will be needed to support the fleet. This section summarizes the status and outlook of U.S. PEV charging infrastructure, how much and what types of charging may be needed to support the level of PEV penetration in the rulemaking, and how we estimated the associated costs.



## **5.3.1 Status and Outlook for PEV Charging Infrastructure**

### **5.3.1.1 Definitions**

Terminology for charging infrastructure varies in the literature with terms like "charger", "plug", "outlet", and "port" sometimes being used interchangeably. Throughout this chapter, we use the following definitions, consistent with DOE's Alternative Fuels Data Center.<sup>148</sup> When referring to public charging, a **station** is the physical location where charging occurs. Each station may have one or more Electric Vehicle Supply Equipment (EVSE) **ports** that provide electricity to a vehicle. The number of vehicles that can simultaneously charge at the station is equal to the number of EVSE ports. Each port may also have multiple connectors or plugs, e.g., to accommodate vehicles that use different connector types, but each port can only charge one vehicle at a time. While it is less common to refer to the place home charging occurs (e.g., garage or driveway) as a station, we use the term ports in the same way for residential and non-residential charging.

We do not include electric power infrastructure—generation, transmission, and distribution systems—in our definition of PEV charging infrastructure.<sup>149</sup> Discussions of electric power infrastructure can be found in Chapters 5.2 and 5.4.

### **5.3.1.2 Charging Types**

Electric Vehicle Supply Equipment (EVSE) ports can be alternating or direct current (AC or DC); they also vary by power level. Common AC charging types include L1 (up to about 2 kW power) and L2 (up to 19.2 kW power) (AFDC 2024a) (Schey, Chu and Smart 2022). DC fast charging (DCFC) is available in a range of power levels today, e.g., 50 kW to 350 kW. A standard for even higher-powered DCFC designed to serve medium- and heavy-duty PEVs, the Megawatt Charging System (MCS), is currently in development (ANL 2023) (CharIN 2022). Generally, the use of higher-power EVSE ports corresponds to faster charging (AFDC 2024a) though the maximum power that vehicles can accept varies by model.<sup>150</sup> Most vehicle models currently use the SAE J1772 standard connector for Level 1 and 2 charging.<sup>151,152</sup> There are multiple connectors for DCFC, including Combined Charging System (CCS), CHAdeMO, and the North American Charging Standard (NACS) connector or J3400 (AFDC 2024a). NACS began as a proprietary connector developed by Tesla and is now undergoing a standardization process by SAE (JOET 2023a) (SAE 2024).

---

<sup>148</sup> Definitions are consistent with those used by the U.S. Department of Energy, Alternative Fuels Data Center (AFDC 2024a). A diagram is available at: [https://afdc.energy.gov/fuels/electricity\\_infrastructure.html](https://afdc.energy.gov/fuels/electricity_infrastructure.html) (last accessed January 9, 2024).

<sup>149</sup> The electric power utility distribution system infrastructure, which includes substations, feeders, and distribution transformers among other components, typically ends at a service drop to a customer's premises.

<sup>150</sup> Table 5-1 shows the maximum DCFC power levels we assumed for BEV models in our infrastructure cost analysis.

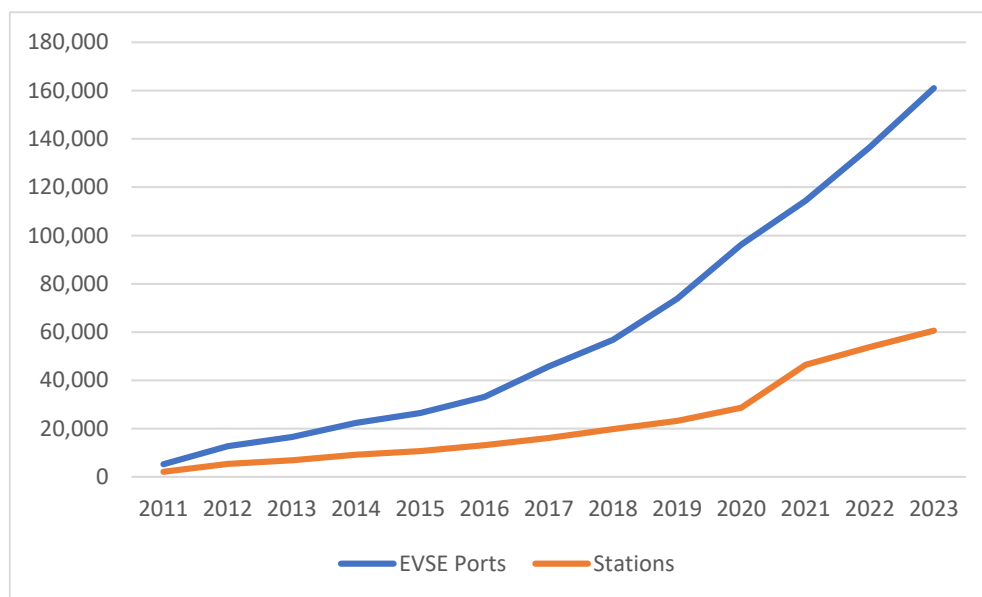
<sup>151</sup> Tesla vehicles use the NACS connector for AC charging though a J1772 adapter is available.

<sup>152</sup> As noted in Chapter 5.3.1.3, many auto manufacturers have announced that they will offer the NACS standard developed by Tesla on future production models (Reuters 2023). The NACS connector is capable of both L2 charging and DCFC (JOET 2023a).

Wireless or inductive charging systems have also been demonstrated and sold as aftermarket add-ons but have not been widely deployed (AFDC 2024a). Due to the uncertainty about the timing and uptake of wireless charging, we consider it outside the scope of this analysis.

### 5.3.1.2.1 PEV Charging Infrastructure Status and Trends

Charging infrastructure has grown rapidly over the last decade (AFDC 2024b). As shown in Figure 5-21 there are about 60,000 public charging stations in the U.S. today with about 160,000 EVSE ports. This is more than double the 74,000 EVSE ports as of the end of 2019 (AFDC 2024b). About three-quarters of public EVSE ports today are L2 (AFDC 2024c), however, DCFC deployments have generally experienced faster growth than L2 in the past few years (Brown, Cappellucci, et al., Electric Vehicle Charging Infrastructure Trends from the Alternative Fueling Station Locator: Third Quarter 2023 2024). Among DCFCs, there is a trend toward higher power levels with more than half of the EVSE ports capable of power output at 250 kW or higher and about two-thirds at 150 kW or higher as of the third quarter of 2023 (Brown, Cappellucci, et al., Electric Vehicle Charging Infrastructure Trends from the Alternative Fueling Station Locator: Third Quarter 2023 2024).



**Figure 5-21: U.S. Public PEV Charging Infrastructure from 2011–2023 (Data Source: U.S. DOE, Alternative Fuels Data Center (AFDC 2024b) (AFDC 2024c)<sup>153</sup>.**

Estimates for future infrastructure needs vary in the literature, reflecting different assumptions about driving and charging behavior, residential charging access, and the mix of EVSE by power levels, among other factors. A recent national assessment by NREL (E. Wood, B. Borlaug, et al. 2023) estimated that to support 33 million PEVs in 2030, about 1.25 million public EVSE ports (including 182,000 DCFC ports) would be needed, along with 26.8 million

<sup>153</sup> EVSE port and station counts are for the end of the calendar year shown. Values shown for 2023 are from the Alternative Fuels Data Center (AFDC) Station Locator as captured on January 10, 2024.

private ports (most at single family homes, but also at multi-family homes and workplaces) (E. Wood, B. Borlaug, et al. 2023). That yields a ratio of about one public EVSE port needed per 26 PEVs.<sup>154</sup> This fits well within a range of other recent studies examining public infrastructure needs. An ICCT report looking across a dozen studies published between 2018 to 2021 found that two-thirds of the estimates (including its own) fell between 20 and 40 PEVs per public EVSE port (Bauer, et al. 2021).<sup>155</sup> A new report conducted by ICF for the Coordinating Research Council, which assessed infrastructure needs for the level of PEV adoption in the proposed rule,<sup>156</sup> found one public EVSE port would be needed for every 34 light-duty PEVs (CRC 2023). There was approximately one public EVSE port for every 26 PEVs on the road as of the third quarter of 2023<sup>157</sup> suggesting public charging infrastructure is generally keeping pace with PEV adoption. See RTC Section 17 for additional discussion of infrastructure availability and recent infrastructure needs assessments.

### 5.3.1.3 PEV Charging Infrastructure Investments

Investments in PEV charging infrastructure have grown rapidly in recent years and are expected to continue to climb. According to BloombergNEF, total cumulative global investment in PEV charging reached almost \$55 billion in 2022 and was estimated to reach nearly \$93 billion in 2023 (BloombergNEF 2023). U.S. infrastructure spending has also grown significantly over the past several years with estimated public charging investments of \$2.7 billion in 2023 alone (BloombergNEF 2023).

The U.S. government is making large investments in infrastructure through the Bipartisan Infrastructure Law (Public Law 117-58 2021) and the Inflation Reduction Act (Public Law 117-169 2022). However, we expect that private investments will also play a critical role in meeting future infrastructure needs. Private charging companies have already attracted billions globally in venture capital and mergers and acquisitions, indicating strong interest in the future of the charging industry. Bain projects that by 2030, the U.S. market for electric vehicle charging will be "large and profitable" with both revenue and profits estimated to grow by a factor of twenty relative to 2021 (Zayer, et al. 2022).<sup>158</sup> Domestic manufacturing capacity is also increasing. About forty companies have announced over \$500 million of investments in U.S. facilities to construct charging equipment, with planned domestic production capacity of more than one million chargers (including 60,000 DCFCs ) annually (U.S. DOE 2024) (U.S. DOE 2023).<sup>159</sup>

---

<sup>154</sup> The number of EVSE ports needed to meet a given level of charging demand will depend on the mix of L2 and DCFC ports (and EVSE power levels of each). A comparison of estimated charging needs in (E. Wood, B. Borlaug, et al. 2023) to available charging infrastructure by EVSE type is discussed in (Brown, et al. 2024).

<sup>155</sup> Note the full range of studies spanned 12 to 129 PEVs per public charger though all but two were between 20 and 56.

<sup>156</sup> The study assessed infrastructure needs associated with ZEV adoption in the proposed rule, the proposed Greenhouse Gas Emissions Standards for Heavy-Duty Vehicles-Phase 3, as well as California policies including Advanced Clean Cars II rule. The EVSE port to PEV ratio discussed is for light-duty vehicles only.

<sup>157</sup> Estimated from approximately 4.16 million EVs and 160,000 public EVSE ports as reported in (Brown, et al. 2024).

<sup>158</sup> Estimates account for hardware and installation as well as operations and other charging services such as vehicle-grid integration.

<sup>159</sup> Note: investment and production capacity totals include only those available in public announcements (as reported by DOE) and may not be comprehensive.

These activities suggest that companies are positioning themselves to meet the growing demand for PEV charging.

The NREL study discussed above (E. Wood, B. Borlaug, et al. 2023) estimated that between \$31 billion and \$55 billion would be needed by 2030 for public infrastructure, noting that \$24 billion in investments from public and private sources had already been announced as of March 2023. The White House estimates that as of January 2024 total investments to expand the U.S. charging network had grown to over \$25 billion (The White House 2024). This includes more than \$10 billion in private sector investments from automakers, charging companies, and retailers, among others (The White House 2024). Considering 2030 is still six years away, and that the standards themselves will spur additional investments, announced charging infrastructure investments in the U.S. (described in the following sections) appear to be putting us on track to support the PEV adoption under the finalized standards. Furthermore, these public and private parties are already responding to the market that is developing for infrastructure, and we see no reason to believe they won't continue to meet infrastructure demand as the PEV market grows.

#### **5.3.1.3.1 Bipartisan Infrastructure Law**

The Bipartisan Infrastructure Law (BIL)<sup>160</sup> (Public Law 117-58 2021) provides up to \$7.5 billion over five years to build out a national network of PEV chargers. Two-thirds of this funding is for the National Electric Vehicle Infrastructure (NEVI) Formula Program (U.S. DOT, FHWA 2022a). The remaining \$2.5 billion is for the Charging and Fueling Infrastructure (CFI) Discretionary Grant Program, which is evenly divided between funds for charging and fueling infrastructure along corridors and in communities where fueling infrastructure can include hydrogen, propane, or natural gas (U.S. DOT, FHWA 2022a). Both programs are administered under the Federal Highway Administration (FHWA) with support from the Joint Office of Energy and Transportation (JOET).

The first phase of NEVI formula funding for states was launched in 2022 and is focused on building out Alternative Fuel Corridors (AFCs) on highways. Charging stations for AFCs are required to have at least four DCFC ports, each 150 kW or higher (88 FR 12724 2023). Per FHWA's guidance to states, stations generally must be located no more than 50 miles apart and one mile from the Interstate (U.S. DOT, FHWA 2022a). Initial plans for all 50 states, DC, and Puerto Rico covering FY22 and FY23 funds were approved in September 2022 (U.S. DOT, FHWA 2022b). Together, the \$1.5 billion in funding will help deploy or expand charging infrastructure on about 75,000 miles of highway (U.S. DOT, FHWA 2022b). Ohio was the first state to open a NEVI-funded station near Columbus in December 2023 (JOET 2023c). New York and Pennsylvania followed with stations in Kingston (JOET 2023d) and Pittston (JOET 2024b), respectively. Another 30 states are soliciting proposals and making awards (JOET 2024e). An additional \$885 million is available for state plans in FY24 (JOET 2023e). In September 2023, JOET announced that up to \$100 million in NEVI funding would be available to increase reliability of the existing charging infrastructure network with funds going to repair or replace EVSE ports (JOET 2023f). This will complement efforts of the National Charging Experience (ChargeX) Consortium. Launched in May 2023 by JOET and led by U.S. DOE labs, the ChargeX Consortium will develop solutions and identify best practices for common problems related to the consumer experience, e.g., payment processing and user interface, vehicle-charger

---

<sup>160</sup> Signed into law as the "Infrastructure Investment and Jobs Act"

communication, and diagnostic data sharing (JOET 2023g). Relatedly, in January 2024, JOET announced \$46.5 million in federal funding to support 30 projects to increase charging access, reliability, resiliency, and workforce development (JOET 2024c). This includes projects to increase the commercial capacity for testing and certification of high-power electric vehicle chargers, which will accelerate the deployment of interoperable, safe, and efficient electric vehicle and charger systems (JOET 2024d). Also in January 2024, over \$600 million in grants under the CFI Program was announced to deploy PEV charging and alternative fueling infrastructure in communities and along corridors in 22 states (JOET 2024a). This first round of CFI grants is expected to fund about 7,500 EVSE ports.

In addition to NEVI and CFI, there are a variety of other Federal programs that could help reduce State or private costs associated with deploying EVSE. For example, constructing and installing charging infrastructure is an eligible activity for other U.S. Department of Transportation formula programs including the Congestion Mitigation & Air Quality Improvement Program, National Highway Performance Program, and Surface Transportation Block Grant Program, which have a total of more than \$40 billion in FY22 funds authorized under the BIL (U.S. DOT, FHWA 2022a).<sup>161</sup> Discretionary grant programs include the Rural Surface Transportation Grant Program, Infrastructure for Rebuilding America Grant Program, and the Discretionary Grant Program for Charging and Refueling Infrastructure (U.S. DOT, FHWA 2022a).

#### **5.3.1.3.2 Inflation Reduction Act**

The Inflation Reduction Act (IRA), signed into law on August 16, 2022 (Public Law 117-169 2022), will also help reduce the cost that consumers and businesses pay toward PEV charging infrastructure. The IRA extends the Internal Revenue Code 30C Alternative Fuel Refueling Property Tax Credit (Section 13404) through Dec 31, 2032, with modifications. Under the new provisions, residents in low-income or non-urban areas, representing around two-thirds of Americans (The White House 2024), are eligible for a 30 percent credit for the cost of installing residential charging equipment up to a \$1,000 cap. Businesses are eligible for up to 30 percent of the costs associated with purchasing and installing charging equipment in these areas (subject to a \$100,000 cap per item) if they meet prevailing wage and apprenticeship requirements.

#### **5.3.1.3.3 Equity Considerations in BIL and IRA**

The infrastructure funding in the BIL and the IRA tax credit discussed above can help to address equity challenges for PEV charging infrastructure. One of the stated goals of the \$7.5 billion in infrastructure funding under the BIL is to support equitable access to charging across the country (U.S. DOT, FHWA 2022a). Accordingly, FHWA instructed states to incorporate public engagement in their planning process for the NEVI Formula program, including reaching out to Tribes, and rural, underserved, and disadvantaged communities among other stakeholders. Both the formula funding and discretionary grant program are subject to the Justice40 Initiative target that 40 percent of the overall benefits of certain covered federal investments go to disadvantaged communities (U.S. DOT, FHWA 2022a). As noted above, the Internal Revenue

---

<sup>161</sup> Only a portion is likely to be used to support PEV charging infrastructure, and limits and restrictions may apply.

Code 30C tax credit will help residents in low-income and non-urban census tracts to install home charging and provide an incentive for businesses to site stations in these areas.

#### **5.3.1.3.4 Other Public and Private Investments**

States, utilities, auto manufacturers, charging network providers, and others are also investing in and supporting PEV charging infrastructure deployment. California announced plans to invest \$1.9 billion in state funds through 2027 for charging and hydrogen refueling infrastructure serving light-, medium-, and heavy-duty vehicles (and related activities), which it estimates could support 40,000 new EVSE ports (California Energy Commission 2024). The New York Power Authority is investing \$250 million to support up to 400 DCFC stations (NYPA 2023). Several states including New Jersey and Utah offer partial rebates for residential, workplace, or public charging while others such as Georgia and D.C. offer tax credits (AFDC 2023c).<sup>162</sup> The NC Clean Energy Technology Center identified more than 200 actions taken across 38 states and D.C. related to providing financial incentives for electric vehicles and or charging infrastructure in 2022, a four-fold increase over the number of actions in 2017 (Apadula, et al. 2023).<sup>163</sup> Other programs will increase charging access at multi-unit dwellings. For example, the municipal utility in Burlington, Vermont, in partnership with EVmatch, offers rebates for EVSE installations at these properties with an additional \$300 incentive provided if owners make charging equipment available for public use during the day to further extend charging access (Oreizi 2022). The Edison Electric Institute estimates that electric companies are investing \$5.2 billion in infrastructure and other transportation electrification efforts in 35 states and the District of Columbia (EEI 2023a).<sup>164</sup> And over 60 electric companies and cooperatives serving customers in 48 states and the District of Columbia have joined together to advance fast charging through the National Electric Highway Coalition (EEI 2023b).

In July 2023, seven automakers—BMW, GM, Honda, Hyundai, Kia, Mercedes-Benz, and Stellantis—announced that they would jointly deploy 30,000 EVSE ports in North America (Domonoske 2023). GM is also partnering with charging provider EVgo to deploy over 2,700 DCFC ports (GM 2021) and charging provider FLO to deploy as many as 40,000 Level 2 ports (with a focus on deployments in rural areas) (Valdes-Dapena 2022). Ford plans to install publicly accessible DCFC ports at many of its dealerships (JOET 2023b). Mercedes-Benz recently announced that it is planning to build 2,500 charging points in North America by 2027 (Reuters 2023). Tesla has its own network with nearly 24,000 DCFC ports and more than 10,000 L2 ports in the United States (AFDC 2024c). Tesla announced that by 2024, 7,500 or more existing and new ports (including 3,500 DCFC) would be open to all PEVs, and that it would double the size of its DCFC network (The White House 2023). Many auto manufacturers have announced that they will offer the NACS standard developed by Tesla on future production models in order to access the Tesla network (Reuters 2023).

Auto manufacturers are also providing support to customers. Volkswagen, Hyundai, and Kia all offer customers complimentary charging at Electrify America's public charging stations (subject to time limits or caps) in conjunction with the purchase of select new electric vehicle

---

<sup>162</sup> Details on eligibility, qualifying expenses, and rebate or tax credit amounts vary by state.

<sup>163</sup> Includes actions by states and investor-owned utilities.

<sup>164</sup> The \$5.2 billion total reflects approved filings for infrastructure deployments and other customer programs to advance transportation electrification.

models (VW 2023) (Hyundai 2023) (Kia 2023). Ford has agreements with several charging providers to make it easier for their customers to charge and pay across different networks (Ford 2019).

Other charging networks are also expanding. Francis Energy, which has fewer than 1000 EVSE ports today (U.S. Department of Energy, Alternative Fuels Data Center 2023d), aims to deploy over 50,000 by the end of the decade (JOET 2023b). Electrify America, a subsidiary of VW that is implementing the \$2 billion investment<sup>165</sup> required as part of a 2016 Clean Air Act settlement (EPA 2023), plans to more than double its network size (U.S. Department of Energy, Alternative Fuels Data Center 2023d) to 10,000 fast charging ports across 1800 U.S. and Canadian stations by 2026. This is supported in part by a \$450 million investment from Siemens and Volkswagen Group (Electrify America 2022). Blink plans to invest over \$60 million to grow its network over the next decade (JOET 2023b). Charging companies are also partnering with major retailers, restaurants, and other businesses to make charging available to customers and the public. For example, EVgo is deploying DCFC at certain Meijer locations, CBL properties, and Wawa. Volta is installing DCFC and L2 ports at select Giant Food, Kroger, and Stop and Shop stores, while ChargePoint and Volvo Cars are partnering with Starbucks to make charging available at select Starbucks locations (JOET 2023b). Walmart recently announced plans to expand their network of DCFCs from fewer than 300 locations to thousands of Walmart and Sam's Club facilities by 2030 (Kapadia 2023). Other efforts will expand charging access along major highways at up to 500 Pilot and Flying J travel centers (through a partnership between Pilot, GM, and EVgo) and 200 TravelCenters of America and Petro locations (through a partnership between TravelCenters of America and Electrify America) (JOET 2023b). BP plans to invest \$1 billion toward charging infrastructure by the end of the decade, including through a partnership to provide charging at various Hertz locations across the country that could support rental and ridesharing vehicles, taxis, and the public (BP 2023). All of these investments indicate that the charging infrastructure market is rapidly expanding with market participants taking the necessary steps to meet demand. As previously noted, we see no reason to believe that this trend will not continue throughout the timeframe of this rulemaking.

### **5.3.2 PEV Charging Infrastructure Cost Analysis**

To assess the infrastructure needs and associated costs for this final rule, we start with estimates of PEV charging demand generated using the methodology described in Chapter 5.1. These demand estimates are then used to project the number and mix of EVSE ports that may be needed each year under the final rule and a no-action case.<sup>166</sup> Finally, we assign costs for each EVSE port type intended to reflect upfront hardware and installation costs based on values in the literature. This section summarizes the methodology and assumptions used for the PEV

---

<sup>165</sup> The \$2 billion investment is for charging or hydrogen refueling infrastructure as well as other activities to advance ZEVs (e.g., education and public outreach).

<sup>166</sup> The final rule and no-action cases used throughout the PEV charging infrastructure cost analysis were based on a preliminary analysis compared to the final compliance modeling. While annual PEV charging demand is generally higher in the compliance scenarios relative to those in the preliminary analysis (with annual differences of between plus and minus five percent), cumulative electricity consumption associated with PEV charging from 2027 to 2055 in the final rule compliance scenario is only four percent higher for the action case (the final standards) and one percent higher in the no action case, compared to the preliminary analysis used to assess PEV charging infrastructure needs and costs. (Note the scenarios used for power sector modeling are described in Chapter 5.2.)

infrastructure cost analysis and presents the resulting EVSE costs under the final rule relative to the no-action case.

### 5.3.2.1 Charging Demand Projections

Regionalized PEV charging demand and EVSE port needs under our final rule and a no-action case were simulated by NREL for select years from 2026–2055 under an Interagency Agreement between EPA and the U.S. Department of Energy (U.S. EPA 2022b). The analysis framework utilized to estimate charging demand (and EVSE port counts described in Chapter 5.3.2.2) was adapted from the framework used in NREL's 2023 study, *The 2030 National Charging Network: Estimating U.S. Light-Duty Vehicle Demand for Electric Vehicle Charging Infrastructure* (E. Wood, B. Borlaug, et al. 2023) though the PEV adoption scenarios are specific to this analysis as described in Chapter 5.1.<sup>167</sup>

NREL's EVI-Pro model was used to simulate charging demand from typical daily travel, EVI-RoadTrip was used to simulate demand from long-distance travel, and EVI-OnDemand to simulate demand from ride-hailing applications (see (E. Wood, B. Borlaug, et al. 2023).) Eight unique charging types and locations were considered: home L1, home L2, depot L2, work L2, public L2, and public DCFC at 150 kW, 250 kW, and 350 kW power levels (DC-150, DC-250, and DC-350). The following assumptions informed the respective charging shares for daily travel modeled with EVI-Pro.

For light-duty PEVs:

- PEV drivers with access to residential charging are assumed to prefer home over either work or public charging when home charging is sufficient to support all travel needs.
- 75 percent of BEVs and 53 percent of PHEVs are assumed to use L2 for home charging with the remaining share using L1.<sup>168</sup>
- Workplace L2 is the next most preferred charging type after home charging.
- Remaining charging needs are met with public charging. DCFC is generally preferred for BEVs, and among DCFC, the highest power that a vehicle can accept (or "as fast as possible" charging) is preferred.
- Public L2 charging is used by PHEVs, which are assumed not to be DCFC-capable. It's also used by BEVs in certain long dwell time location types such as schools or medical facilities where it's assumed that DCFC is not available.

---

<sup>167</sup> Other aspects of the modeling methodology that are specific to this analysis are described in Chapter 5.1 and 5.3.2.

<sup>168</sup> This in part reflects assumptions about the characteristics of PEVs modeled by OMEGA, including a percentage of low mileage PEVs for which L1 meets daily charging needs.



For medium-duty PEVs:<sup>169</sup>

- All medium-duty PEVs (e.g., work van or pickup truck) are assumed to have access to L2 charging at their home base (i.e., the location they are regularly parked when not in use.) For some PEVs, this could be at a dedicated depot for commercial fleets whereas others could be regularly parked overnight and charged at the owner's home. For simplicity, we refer to both options as "depot L2".
- Drivers are assumed to prefer depot L2 charging over public charging when it is sufficient to support all travel needs.
- Remaining charging needs are met with public charging. DCFC is generally preferred for BEVs, and among DCFC, the highest power that a vehicle can accept (or "as fast as possible" charging) is preferred. Public L2 charging is used by medium-duty PHEVs.

For road trips and travel by ride-hailing vehicles modeled in EVI-RoadTrip and EVI-OnDemand,<sup>170</sup> respectively, all public charging is assumed to be met with DCFC for BEVs. Additionally, BEVs able to accept higher-power charging (Gen 2) are assumed to be adopted more quickly for these applications than for daily travel needs modeled in EVI-Pro.<sup>171</sup>

As shown in Figure 5-22, the share of PEV charging demand by location and type is similar between the final rule and no-action case, though depot charging increases more under the final rule due to a higher relative share of medium-duty PEVs. The majority of PEV charging demand across all years is projected to be met at homes (primarily with L2 charging) though under the final rule, the home charging (L1 and L2) share declines from over 70 percent in 2028 to 53 percent in 2055 as the share of depot, workplace, and public charging grow.<sup>172</sup> DCFC has the next highest share of demand after home charging. Due to the modeling assumption that BEVs charge "as fast as possible" when using DCFC, 350 kW charging dominates.<sup>173</sup>

---

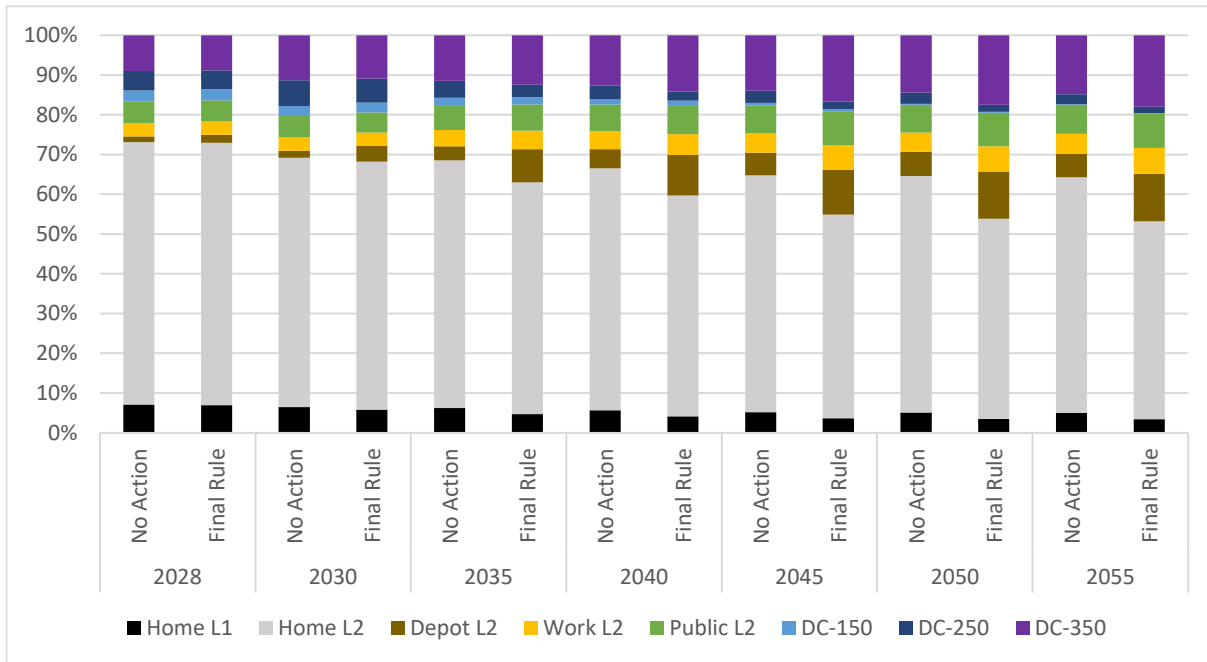
<sup>169</sup> Charging infrastructure needs for medium-duty PEVs were not simulated for the NPRM due to timing constraints, and therefore depot charging and other projected medium-duty PEV demands are new additions for this analysis. We also note that medium-duty PEVs are out of scope for (E. Wood, B. Borlaug, et al. 2023), which assessed charging needs for light-duty vehicles.

<sup>170</sup> Medium-duty PEVs are not modeled within EVI-OnDemand or EVI-RoadTrip. All ride-hailing vehicles are assumed to be light-duty PEVs. Medium-duty PEVs are assumed to be used primarily for commercial applications and therefore less likely to be regularly used for long-distance travel.

<sup>171</sup> For max DC fast charging rates for different vehicle types modeled in this analysis, see Table 5-1.

<sup>172</sup> While public L2 and DC-350 kW charging share grow, lower-powered DCFC options decline between 2028 and 2055.

<sup>173</sup> While the modeling framework allows for 50 kW DCFC, no charging demand at this power level is found in either the final rule or no-action case since simulated BEV models are capable of higher-power charging. Therefore, we do not include 50 kW DCFCs in the discussion or tables presented in this chapter.



**Figure 5-22: Share of charging demand by location and type for the no-action case (left side of each pair of bars) and final rule (right side of each pair of bars) for 2028–2055.<sup>174</sup>**

### 5.3.2.2 Projected EVSE Port Needs

The number of EVSE ports needed to meet the level of PEV charging demand in our final rule and the no-action case was estimated for all charging types described above. Home charging was further delineated into EVSE ports at single family houses (SFHs)—including both detached and attached houses (e.g., townhouses) — and at non-SFHs. Non-single family home ports include those serving multi-family housing (e.g., apartments and condominiums), mobile homes, as well as curbside or other neighborhood ports used by PEV drivers without access to dedicated off-street parking.<sup>175</sup> Several additional assumptions informed this network sizing. For both home and depot charging, it was assumed that as PEV adoption increases, more charging ports would be shared across vehicles. This could reflect SFHs with more than one PEV, residents of multi-unit dwellings sharing L2 ports, or medium-duty PEVs sharing ports at depots or the owner's home. Specifically, we assume that at 1 percent PEV adoption, 1 EVSE port is needed per light-duty PEV with home charging access. This declines to 0.6 EVSE ports per light-duty PEV for SFHs and 0.5 EVSE ports per light-duty PEV for other home types when PEVs make up the entire light-duty fleet. For medium-duty PEVs, we assume that at 1 percent adoption, an EVSE

<sup>174</sup> The demand shares shown and used within the PEV charging infrastructure analysis do not assume any managed charging.

<sup>175</sup> Curbside or neighborhood ports are modeled in this analysis as a home charging option and could be either public or semi-private (restricted access). This differs from (E. Wood, B. Borlaug, et al. 2023), in which these ports are classified as public “neighborhood” ports.

port is needed for each vehicle, declining to 0.5 EVSE ports per PEV when PEVs make up the entire medium-duty fleet.

Network sizing for public and workplace charging is based on the regional charging load profiles described in Chapter 5.1.<sup>176</sup> For each DCFC port type (DC-150, DC-250, and DC-350) the total number of ports needed is scaled such that during the peak hour of usage 20 percent of ports in the region are fully utilized. For work and public L2 charging, 60 percent and 55 percent of ports, respectively, are assumed to be fully utilized during the peak hour. These percentages are modeled after highly utilized stations today (E. Wood, B. Borlaug, et al. 2023).<sup>177</sup> Figure 5-23 and Figure 5-24 show the growing charging network that would be needed to meet PEV charging demand if auto manufacturers comply by using the PEV penetrations under a central case analysis<sup>178</sup> of the final standards and no-action case, respectively.<sup>179</sup> We anticipate that the highest number of ports will be needed at homes, growing from under 16 million in 2027 to over 77 million in 2055 under the final standards.<sup>180</sup> This is followed by public charging, estimated to grow from under 600,000 ports to over 7.8 million total EVSE ports in that timeframe. The majority of these are public L2 ports with about 685,000 DCFCs estimated to be needed by 2055. Depot and workplace<sup>181</sup> charging needs also increase to over 3.7 million and about 5.8 million EVSE ports in 2055, respectively. Notably, while DCFC at 350 kW constitutes a significant fraction of total electricity demand (Figure 5-22), the number of ports needed is relatively small compared to the scale shown. This is because far fewer 350 kW ports are needed to deliver the same amount of electricity as lower-powered options (e.g., public L2 ports). Similar patterns are observed in the no-action case though fewer total ports are needed than under the final standards due to the lower anticipated PEV demand. Table 5-11 summarizes port counts by EVSE type for select years<sup>182</sup> under the final standards and in the no-action case.

---

<sup>176</sup> However, as previously noted, the final rule and no-action cases used in the PEV charging infrastructure analysis differ from those used in the power sector modeling.

<sup>177</sup> The same method and thresholds for sizing the non-residential charging network based on peak hour of usage was applied for all years in this analysis. If we instead assumed the percentage of L2 or DCFC ports that are fully utilized at peak grew as a function of time or PEV penetration, we would expect higher average utilizations per port and fewer total ports needed.

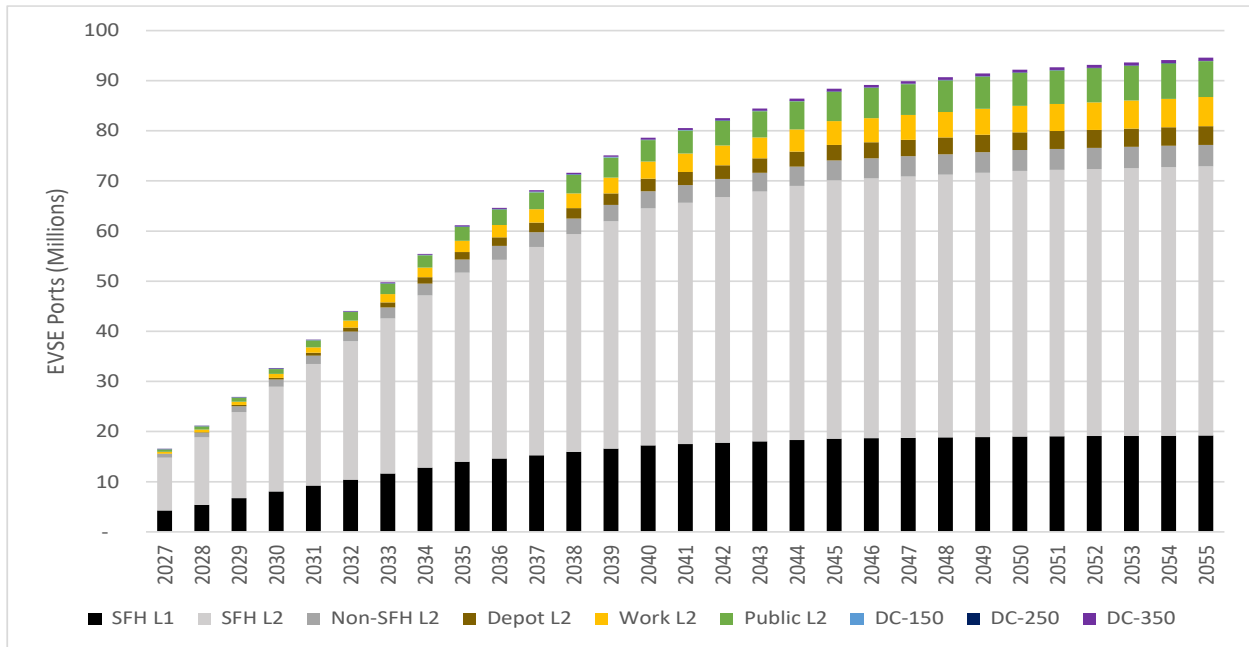
<sup>178</sup> As noted earlier, the PEV charging analysis is based on a preliminary analysis that includes minor differences with the final central case.

<sup>179</sup> Charging simulations were conducted for 2026, 2028, 2030, 2035, 2040, 2045, 2050, and 2055. Linear interpolations were used to estimate the network size in intermediate years.

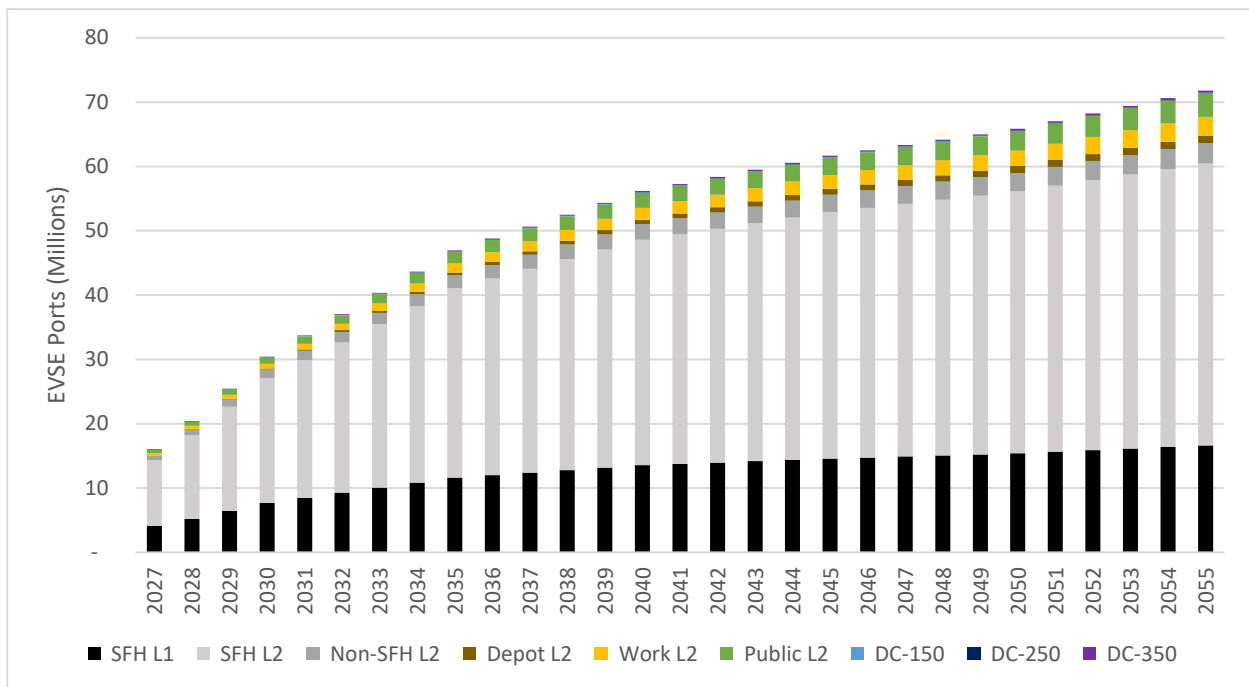
<sup>180</sup> The number of EVSE ports needed to meet a given level of electricity demand will vary based on the mix of charging ports, charging preferences, vehicle characteristics, and other factors. Estimates shown reflect assumptions specific to this analysis, but actual needs could vary.

<sup>181</sup> Compared to the NPRM, the relative shares of work and public L2 EVSE ports has changed with some charging that was previously classified as work shifting to public L2. This is due to a change in the modeling assumptions. Consistent with (E. Wood, B. Borlaug, et al. 2023), the FRM analysis assumes some workplace charging will be done at publicly-accessible ports where employees work. Since work and public L2 are assigned the same cost per EVSE port (as described in Chapter 5.3.2.4), this change has no impact on total costs.

<sup>182</sup> EVSE port counts for all years from 2027–2055, along with data inputs used in this analysis, are available in the docket, see (Burke 2024).



**Figure 5-23: EVSE port counts by charging type for the final standards 2027–2055.**



**Figure 5-24: EVSE port counts by charging type for the no-action case 2027–2055.**

**Table 5-11: EVSE port counts (thousands) for select years under the final rule and no-action case.**

|                      | Final rule |        |        |        | No-action case |        |        |        |
|----------------------|------------|--------|--------|--------|----------------|--------|--------|--------|
|                      | 2027       | 2030   | 2040   | 2055   | 2027           | 2030   | 2040   | 2055   |
| SFH L1               | 4,251      | 8,047  | 17,241 | 19,228 | 4,143          | 7,695  | 13,571 | 16,650 |
| SFH L2               | 10,537     | 20,894 | 47,271 | 53,669 | 10,190         | 19,398 | 35,022 | 43,838 |
| Non-SFH L2           | 727        | 1,424  | 3,447  | 4,300  | 705            | 1,332  | 2,443  | 3,129  |
| Depot L2             | 62         | 357    | 2,472  | 3,737  | 45             | 137    | 702    | 1,157  |
| Work L2              | 385        | 777    | 3,417  | 5,793  | 375            | 754    | 1,839  | 2,948  |
| Public L2            | 492        | 992    | 4,289  | 7,187  | 480            | 964    | 2,343  | 3,740  |
| DC-150               | 37         | 67     | 80     | 11     | 35             | 61     | 54     | 7      |
| DC-250               | 14         | 37     | 44     | 45     | 13             | 36     | 37     | 40     |
| DC-350               | 25         | 68     | 334    | 629    | 25             | 63     | 165    | 301    |
| Total <sup>183</sup> | 16,530     | 32,662 | 78,594 | 94,599 | 16,011         | 30,440 | 56,175 | 71,809 |

### 5.3.2.3 EVSE Cost Approach

In order to estimate the costs incurred each year, we calculate how many EVSE ports of each type would need to be procured and installed to achieve the charging network sizes shown in Figure 5-23 and Figure 5-24.<sup>184</sup> There is limited data on the expected lifespan and maintenance needs of PEV charging infrastructure. We make the simplifying assumption that all EVSE ports have a 15-year equipment lifetime (Borlaug, Salisbury, et al. 2020). After that, we assume they must be replaced at full cost. This assumption likely overestimates costs as some EVSE providers may opt to upgrade existing equipment rather than incur the cost of a full replacement. Some installation costs such as trenching or electrical upgrades may also not be needed for the replacement. We do not attempt to estimate EVSE maintenance costs due to uncertainty but note that maintenance may be able to extend equipment lifetimes. Another simplifying assumption we make is that EVSE ports are operational and able to meet PEV charging demand the same year costs are incurred. The actual time to permit and install can vary widely by port type, power level, region, site conditions, and other factors.

### 5.3.2.4 Hardware & Installation Costs per EVSE Port

We assign costs to each of the above infrastructure types intended to reflect the upfront capital costs associated with procuring and installing the EVSE ports. There are many factors that can impact equipment costs, including whether ports are wall-mounted or on a pedestal as well as

<sup>183</sup> Due to rounding, totals may differ from the sums of port counts shown for a given year.

<sup>184</sup> The EVSE port needs described in Chapter 5.3.2.2 were simulated independently for run years 2026, 2028, 2030, 2035, 2040, 2045, 2050, and 2055 without accounting for the mix of ports in previous years. For select years and EVSE types (e.g., DC-150), this results in lower future port needs as demand shifts to other types (e.g., DC-350). We estimate costs needed to achieve full network sizes in Figure 5-23 and Figure 5-24 even if this results in a slightly 'overbuilt' network for select years.

differences in equipment features and capabilities (Schey, Chu and Smart 2022). For example, an ICCT paper found that costs more than doubled between networked and non-networked L2 hardware (Nicholas 2019). Among networked units with one or two ports per pedestal, about a 10 percent difference in per-port hardware costs was found (Nicholas 2019). The power level of the EVSE is one of the most significant drivers of cost differences. While estimates for charging equipment vary across the literature, higher-power charging equipment is typically more expensive than lower-power units.

Installation costs may include labor, materials (e.g., wire or conduit), permitting, taxes, and upgrades or modifications to the on-site electrical service. These costs—particularly labor and permitting—can vary widely by region (Schey, Chu and Smart 2022). They also vary by site. For example, how much trenching is needed will depend on the distance from where the charging equipment will be located and the electrical panel. A recent study found that average L2 installation costs at condominiums and commercial locations increased by \$16 or \$20 for each extra foot of distance between the EVSE and power source respectively (Schey, Chu and Smart 2022). How many EVSE ports are installed also impacts cost. ICCT estimated that on a per-port basis, installation costs for 150 kW ports were about 2.5 times higher when only one port is installed compared to 6–20 per site (Nicholas 2019). And, as with hardware costs, installation costs may rise with power levels.

To reflect the diversity of hardware and installation costs, we considered a range of costs for each charging type as shown in Table 5-12 and detailed below.

**Table 5-12: Cost (hardware and installation) per EVSE port.<sup>185</sup>**

|      | Home   |         |            | Depot    | Work     | Public   |           |           |           |
|------|--------|---------|------------|----------|----------|----------|-----------|-----------|-----------|
|      | SFH L1 | SFH L2  | non-SFH L2 | L2       | L2       | L2       | DC-150    | DC-250    | DC-350    |
| Low  | \$0    | \$870   | \$3,740    | \$1,690  | \$4,400  | \$4,400  | \$112,200 | \$146,150 | \$180,100 |
| Mid  | \$0    | \$1,280 | \$5,620    | \$6,150  | \$7,500  | \$7,500  | \$154,200 | \$193,450 | \$232,700 |
| High | \$550  | \$1,690 | \$7,500    | \$10,600 | \$10,600 | \$10,600 | \$196,200 | \$240,750 | \$285,300 |

### 5.3.2.4.1 Home Charging

PEVs typically come with a charging cord that can be used for L1 charging by plugging it into a standard 120 VAC<sup>186</sup> outlet, and, in some cases, for L2 charging by plugging into a 240 VAC outlet.<sup>187</sup> We include the cost for this cord as part of the vehicle costs described in Chapter 2, and therefore don't include it here. For our "Low" and "Mid" cases, we make the simplifying assumption that PEV owners opting for L1 home charging already have access to a 120 VAC outlet and therefore do not incur installation costs.<sup>188</sup> To reflect that some PEV drivers opting for

<sup>185</sup> All costs shown above and used within the cost analysis are rounded to the nearest ten and expressed in 2022 dollars.

<sup>186</sup> Volts, alternating current.

<sup>187</sup> Not all charging cords may be capable of Level 2 charging.

<sup>188</sup> (Ge, et al. 2021) found that while residential charging access is expected to decline as PEV adoption grows, the majority of PEVs are projected to have access to an outlet either where they regularly park or at another parking location at their home even if PEVs reach 100% of the light-duty fleet.

L1 charging may need to install an outlet near their preferred parking spot, we assign installation costs for our "High" case, set at the average of the high and low estimates for L1 home installation costs provided in (E. Wood, B. Borlaug, et al. 2023).<sup>189</sup>

For L2 home charging, some PEV owners may opt to simply install or upgrade to a 240 VAC outlet for use with a provided cord while others may choose to purchase or install a wall-mounted or other L2 charging unit, which may have additional features and capabilities. In

Table 5-12, the "Low" cost for single-family homes assumes outlet installations only, the "High" cost assumes the purchase and installation of L2 units, and the "Mid" cost assumes an even split.<sup>190</sup>

For other home types (non-SFHs), which include both ports at multi-family housing as well as curbside or other neighborhood L2 ports, the "Low" cost is also assigned to reflect outlet installations only at apartments whereas the "High" cost reflects costs for a public L2 EVSE port. The "Mid" cost is the average of the two.

Costs vary by housing type with installation costs for SFHs typically lower than those for apartments, condos, or mobile homes (non-SFHs). We use costs by housing type from (Nicholas 2019) for outlet upgrades for all housing types and L2 unit installations for SFHs.<sup>191</sup> Public L2 costs are described in Chapter 5.3.2.4.3 below.

#### **5.3.2.4.2 Depot Charging**

As described in Chapter 5.3.2.1, depot L2 charging may reflect charging at commercial depots, i.e., dedicated locations for a fleet of commercial medium-duty vehicles. Alternately, a medium-duty vehicle (e.g., a work van or pickup truck) could be parked at the PEV owner's home. In this case, residential L2 charging equipment would be used. In Table 5-12, the "Low" cost assumes all medium-duty vehicles are charged at single-family homes using hardwired residential L2 equipment, the "High" cost assumes all medium-duty vehicles charge at commercial depots.<sup>192</sup> The "Mid" cost assumes an even split of residential and commercial L2 charging.

#### **5.3.2.4.3 Work and Public Charging**

Cost estimates for work and public EVSE ports (both L2 and DCFC) are updated for the final rule analysis to align with NREL's 2023 national charging network assessment (E. Wood, B. Borlaug, et al. 2023). This study drew from various data and literature sources, including the studies that were used as sources for work and public L2 (Nicholas 2019) and DCFC costs

---

<sup>189</sup> In the NPRM, we assigned \$0 costs for all L1 home charging.

<sup>190</sup> This is unchanged from the NPRM. We note that NPRM costs were expressed in 2019 dollars. We adjusted these to 2022 dollars (starting from unrounded values).

<sup>191</sup> We use costs from Table 5 of (Nicholas 2019), specifically "Level 2 outlet upgrade" for outlet only installations and "Level 2 charger upgrade" for hardware and installation costs associated with a Level 2 charging unit. For SFHs, we weight the relative share of light-duty vehicles owned by residents of detached versus attached houses, sourced from Figure 12 of (Ge, et al. 2021). Apartment costs are used for non-SFHs.

<sup>192</sup> We assign the high end of our public L2 cost range to reflect that medium-duty PEVs may use higher power charging compared to light-duty PEVs or that depots may incur higher installation costs.

(Borlaug, Muratori, et al. 2021) in the NPRM. We use the sum of the low unit and installation costs in (E. Wood, B. Borlaug, et al. 2023) as the "Low" costs in

Table 5-12,<sup>193</sup> and the sum of the high costs in (E. Wood, B. Borlaug, et al. 2023) as the "High" costs. Our "Mid" costs are the average of "Low" and "High".

### **5.3.2.5 Will Costs Change Over Time?**

The infrastructure costs shown above reflect present day costs (expressed in 2022 dollars). However, both hardware and installation costs could vary over time. For example, hardware costs could decrease due to manufacturing learning and economies of scale. Recent studies by ICCT assumed a 3 percent annual reduction in hardware costs (Nicholas 2019) (Bauer, et al. 2021). By contrast, installation costs could increase due to growth in labor or material costs. As noted above, installation costs also depend on site conditions, including whether sufficient electric capacity exists to add charging infrastructure and how much trenching is required between the EVSE port and electrical panel. If easier and, therefore, lower cost sites are selected first, then over time installation costs could rise as charging stations start to be installed in more challenging locations. (Bauer, et al. 2021) found that these and other countervailing factors could result in the average cost of a 150 kW EVSE port in 2030 being similar (~3 percent lower) to that in 2021.

Due to the uncertainty on how costs may change over time, we have made the simplifying assumption for this analysis to keep combined hardware and installation costs per EVSE port constant.

### **5.3.2.6 PEV Charging Infrastructure Cost Summary**

Table 5-13 shows the estimated annual EVSE costs<sup>194</sup> for the indicated calendar years in the final rule relative to the no-action case using the "Low", "Mid", and "High" per port cost estimates. Annual costs range from \$0.3 billion dollars under the low scenario to \$17 billion under the high scenario. The table also shows the present value (PV) of these costs and the equivalent annualized value (EAV) for the calendar years 2027–2055 using 2 percent, 3 percent, and 7 percent discount rates. The "Mid" costs are included as social costs in the net benefits estimates for this final rule, presented in Chapter 9.2.

---

<sup>193</sup> We apply "L2 commercial" costs in (E. Wood, B. Borlaug, et al. 2023) for both work and public L2. We treat costs in (E. Wood, B. Borlaug, et al. 2023) as 2022 dollars.

<sup>194</sup> As described in Chapter 5.3.2.4 above, EVSE costs include hardware and installation costs for the EVSE. They do not include any costs associated with distribution system upgrades. Those costs are accounted for in our FRM analysis in the electricity price (see Chapter 5.2.4).



**Table 5-13: EVSE costs for the final rule relative to no-action case (billions of 2022 dollars).**

| Calendar Year | Low   | Mid    | High   |
|---------------|-------|--------|--------|
| 2027          | \$0.9 | \$1.3  | \$1.9  |
| 2028          | \$0.3 | \$0.6  | \$0.8  |
| 2029          | \$1.4 | \$2.3  | \$3.2  |
| 2030          | \$1.4 | \$2.3  | \$3.2  |
| 2031          | \$6.7 | \$10.0 | \$14.0 |
| 2032          | \$6.7 | \$10.0 | \$14.0 |
| 2035          | \$6.7 | \$10.0 | \$14.0 |
| 2040          | \$6.0 | \$9.0  | \$12.0 |
| 2045          | \$7.6 | \$12.0 | \$16.0 |
| 2050          | \$8.3 | \$13.0 | \$17.0 |
| 2055          | \$5.7 | \$8.6  | \$12.0 |
| PV2           | \$120 | \$190  | \$260  |
| PV3           | \$110 | \$160  | \$220  |
| PV7           | \$63  | \$96   | \$130  |
| EAV2          | \$5.9 | \$9.0  | \$12.0 |
| EAV3          | \$5.7 | \$8.8  | \$12.0 |
| EAV7          | \$5.2 | \$7.9  | \$11.0 |

**5.4 Grid Reliability**

Electric power system reliability can be determined using a variety of statistical metrics. The generally accepted metrics by which electric utilities across the U.S. measure and report electric power system reliability is set by the Institute of Electrical and Electronics Engineers (IEEE) using the standard IEEE 1366-2022 (IEEE Guide for Electric Power Distribution Reliability Indices). The formulation of overall electric power system reliability metrics includes electric power outages associated with what is known as “loss of supply” events; these are events in which electric power generation and/or electric power transmission is the root cause for a power outage.

Using this approach, we observed that electric power utilities in 48 U.S. Census Division and State regions tracked by the U.S. Energy Information Administration (EIA) had overall trends in distribution grid reliability that were less than the national average for the years 2013 and 2021 (the most-recent years for which data is available) (EIA, 2022). Conversely, 13 U.S. Census Division and State regions had overall trends in distribution grid reliability for the same years that were greater than the national average for the years in question. According to the California Public Utilities Commission, "This data alone does not fully capture the current state of reliability of the U.S. electric power distribution system..." (Enis 2021). Given the massive size of the electric power distribution system – with its multitude of regional, climate, and density variations – interpreting distribution system reliability indices can be challenging. Moreover, such reliability statistics focus on outage duration and customer counts, which may obscure important regional variations. However, as the expected increase in electricity generation associated with the final rule relative to the no action case is relatively small – ranging from 4 percent in 2030 to approximately 12 percent in 2050 – we do not expect the U.S. electric power distribution system to be adversely affected by the projected additional number of charging electric vehicles.

It is not uncommon for the electric power system to have additional, unutilized generation capacity at various times throughout a given day. Grid operators can utilize this previously untapped generation capacity by shifting the charging of electric vehicles to times where excess underutilized generation capacity exists and/or shift electric vehicle charging away from times where generation capacity is less prevalent, without affecting the availability of electric vehicles. Such benefits are also conferred to non-EV loads as well. This allows the grid operators to more effectively use existing electric power system resources, which decreases overall operative costs for all ratepayers. These research efforts (Kintner-Meyer, et. al., 2020; Pless et. al., 2020; Satchwell et. al., 2023; and Lipman et. al., 2021) have capitalized on the mismatch between electric generation capacity and demand by demonstrating the ability to shift up to 20 percent of electric vehicle charging loads from any hour of the day to other times of the day. Conversely, the research efforts also demonstrated the ability to increase electric vehicle charging loads by up to 30 percent in a given hour of the day. The ability to shift and curtail electric power is a feature that can improve grid operations and, therefore, grid reliability. Integration of electric vehicle charging into the power grid, by means of vehicle-to-grid software and systems that allow management of vehicle charging time and rate, has been found to create value for electric vehicle drivers, electric grid operators, and ratepayers (Chhaya et. al., 2022). We anticipate similar strategies could be used to shift PEV charging loads from peak times as needed to reduce grid impacts across different regions. As the expected increase in electric power demand resulting from PEV charging in this final rule will be well under 20 percent, we do not anticipate it to pose grid reliability issues.

How the additional electricity demand from PEVs will impact the grid will depend on many factors, including the time-of-day that charging occurs, the use of battery storage, and vehicle-to-grid (V2G) or other Vehicle-Grid Integration (VGI) technology. For example, PEVs can be scheduled to charge at off-peak hours when the electricity demand is easier to meet. Onsite battery storage, if deployed at charging stations, could also reduce potential grid impacts by shifting when electricity is drawn from the grid while still providing power to vehicles when needed. Stationary battery systems, when combined with DC fast chargers, can also help to reduce the overall impact on the grid by reducing power drawn directly from the distribution system with supplemental power provided by the battery systems. Such stationary battery systems can then recharge when unutilized power is available on the distribution system. Managed charging and battery storage could also enable increasing renewable use if charging load is shifted to times with excess solar or wind that might otherwise be curtailed. V2G technology, which allows electricity to be drawn from vehicles when not in use, could even allow PEVs to enhance grid reliability.

Management of PEV charging can reduce overall costs to utility ratepayers by delaying electric utility customer rate increases associated with equipment upgrades and may allow utilities to use electric vehicle charging as a resource to manage intermittent renewables. When PEVs charge during hours when existing grid infrastructure is underutilized, they can put downward pressure on all customers' electric rates by spreading fixed grid investment costs across greater electricity sales (Satchwell et. al., 2023). The development of new electric utility tariffs, including those for submetering for electric vehicles, will also help to facilitate the management of electric vehicle charging and can help to reduce PEV operating costs. When employed as distributed energy resources (DER), PEVs can help to defer and/or replace the need for specific transmission and distribution system equipment upgrades. Recently, NREL found

that a vehicle-to-grid control strategy which lowered an EV battery's average state of charge when parked – while ensuring it was fully recharged in anticipation of the driver's next need – could extend the life of the battery if continued over time (NREL, 2023). Similarly, a study by Environment and Climate Change Canada, NRC Canada, and Transport Canada also found no significant difference in usable battery energy between a vehicle that was used for bidirectional V2G and one that was not, and identified an improved SOC profile resulting from V2G activity as a possible factor (Lapointe et. al., 2023). Application programming interfaces have been developed by industry in partnership with ANL to manage the exchange of energy services contracts, enabling the dispatch of PEVs and other distributed energy resources into utility planning and operations territory-wide or within a specific section of the distribution grid (Evoke Systems 2023). Further, automakers including BMW, Ford, and Honda developed a joint venture that promises to enable their EV customers to earn financial savings from managed charging and energy-sharing services (Honda 2024). See Section IV.C.5 of the preamble for a discussion of DERs and their potential benefits.

Many stakeholders have been engaged in Vehicle-Grid Integration (VGI) efforts. These include most major automakers (e.g., Ford, GM, FCA, BMW, Audi, Nissan, Toyota, Honda, and others), electric utilities (e.g., SCE, PG&E, SDG&E, etc.), the Electric Power Research Institute, EVSE providers, researchers, and the California Energy Commission (Chhaya, et al. 2019) (Lipman, Harrington and Langton 2021), among others.

The increasing integration of electric vehicle charging into the electric power grid has also been found to increase grid reliability (Chhaya, et al. 2019), as the ability to shift and curtail electric power loads improves grid operations and, therefore, grid reliability. Such integration has been found to create value for electric vehicle drivers, electric grid operators, and ratepayers. Management of PEV charging can reduce overall costs to utility ratepayers by delaying electric utility customer rate increases associated with equipment upgrades and may allow utilities to use electric vehicle charging as a resource to manage intermittent renewables or provide ancillary services.

The Electric Power Research Institute (EPRI)<sup>195</sup> is undertaking a three-year-long research project to better understand the scale of commitment and investment in the electric power grid that is required to meet the anticipated electric power loads. Thus far, the electric power sector and its regulators have focused on incremental EV load growth and charger utilization (Electric Power Research Institute 2022). The work of EPRI focuses on grid impacts and associated lead times required to better prepare the grid (including transmission, substation, feeder, and transformer) for vehicle electrification. These efforts are, in part, based upon grid reliability research conducted by EPRI (Maitra 2013) (Electric Power Research Institute 2012), which identified grid and charging behavior characteristics associated with grid resiliency. We also consulted with FERC staff on distribution system reliability and related issues.

Managed EV charging provides several benefits to vehicle owners, rate payers that do not operate electric vehicles, and the operators of the electric power system, including lower costs and longer lifespans for electric power system assets. Managed electric vehicle charging, when coupled with time-of-use (TOU) electric rates, can help to further reduce already low refueling

---

<sup>195</sup> EPRI is an independent, nonprofit, U.S.-based organization that conducts research and development related to the generation, delivery, and use of electricity [<https://www.epri.com/>].

costs of EVs by allowing vehicle operators to charge when electricity rates are most advantageous. Since low electricity costs coincide with surpluses of electricity, such charging reduces the overall costs of electricity generation and delivery to all electricity rate payers, not just those charging electric vehicles. Researchers at the Lawrence Berkeley National Laboratory (LBNL) identified 136 active or approved EV-specific TOU electric utility rates for U.S. investor-owned utilities in 37 states and the District of Columbia (Cappers et. al., 2021). Of the 136 active or approved EV-specific TOU electric utility rates, 54 rates are for residential customers, 48 rates are for commercial customers, 27 rates are for utility-owned facilities, four rates are for fleet operators, and the remaining three rates are for mixed facilities.

As discussed above, managed charging has demonstrated the ability to shift up to 20 percent of EV charging loads from any hour of the day to other times of the day as well as to increase EV charging loads by up to 30 percent in a given hour of the day (Lipman et. al., 2021). By more-effectively utilizing existing electric power system assets, managed electric vehicle charging can also help to further reduce overall electricity costs by allowing for the deferral of electric power system upgrades, with deferral potential of between 5 and 15 years over the 2021–2050 period (Kintner-Meyer et. al., 2022). While such deferrals reduce immediate capital expenditures for electric power system operators, they also extend the functional lifespan of these assets, provide electric utility planners with additional time to consider cost-effective planning options, and helps to mitigate supply chain shortages for electric power system components.

New technologies and solutions exist and are emerging to connect all these new charging stations to the grid as quickly as possible. Utility hosting capacity maps are one tool available that developers can use to identify faster and lower cost locations to connect new EV chargers. These maps can help charging station developers identify locations where there is excess available grid capacity. Hosting capacity maps provide greater transparency into the ability of the distribution grid to host additional distributed energy resources (DERs) such as BEV charging. In addition, hosting capacity maps can identify where DERs can alleviate or aggravate grid constraints. Hosting capacity is commonly defined as the additional injection or withdrawal of electric power up to the limits where individual grid assets exceed their power ratings or where a voltage violation would occur. Hosting capacity maps, analyzed and created by the utility that owns the distribution system, are usually color-coded lines or surface diagrams overlaid on geographic maps, representing the conditions on the grid at the time when the map is published or updated. The analysis is based on power flow simulations of the distribution circuits given specific customers' load profiles supplied by the electric circuit and the grid asset data as managed by the utility. The hosting capacity is highly location specific. A DOE review found that utilities have published 39 hosting capacity maps in 24 states and the District of Columbia (U.S. DOE 2024).

Hosting capacity maps can help direct new EV charger deployment to less constrained portions of the grid, giving utilities more lead time to make distribution system upgrades. In tandem, new technologies and power control protocols are helping connect new EV loads faster even where there are grid capacity constraints. Southern California Edison, a large electric utility in California, proposed a pilot to allow faster connection of new EV loads in constrained areas by deploying Power Control Systems (PCS). In addition to the anticipated build out of charging infrastructure and electric distribution grids, innovative charging solutions implemented by electric utilities have further reduced lead times to deploying BEVs. One approach is for utilities

to make non-firm capacity available immediately as they construct distribution system upgrades. In California, Southern California Edison (SCE) proposed a two-year Automated Load Control Management Systems (LCMS) Pilot. The program would use third-party owned LCMS equipment approved by SCE to accelerate the connection of new loads, including new EVSE, while “SCE completes necessary upgrades in areas with capacity constraints.” SCE would use the LCMS to require new customers to limit consumption during periods when the system is more constrained, while providing those customers access to the distribution system sooner than would otherwise be possible. Once SCE completes required grid upgrades, the LCMS limits will be removed, and participating customers will gain unrestricted distribution service. SCE hopes to evaluate the extent to which LCMS can be used to “support distribution reliability and safety, reduce grid upgrade costs, and reduce delays to customers obtaining interconnection and utility power service.” SCE states that prior CPUC decisions have expressed clear support for this technology and SCE is commencing the LCMS Pilot immediately (Southern California Edison 2023).

Plans to use LCMS to connect new EV loads faster in constrained sections of the grid, like that employed by SCE, are being bolstered by new standards for load control technologies. UL, an organization that develops standards for the electronics industry, published the UL 3141 Outline of Investigation (OOI) for Power Control Systems (PCS) in January 2024 (UL 2024). Manufacturers can now use this standard for developing devices that utilities can use to limit the energy consumption of BEVs. The OOI identifies five potential functions for PCS. One of these functions is to serve as a Power Import Limit (PIL) or Power Export Limit (PEL). In these use cases, the PCS controls the flow of power between a local electric power system (local EPS, most often the building wiring on a single premises) and a broader area electric power system (area EPS, most often the utility’s system). Critically, the standardized PIL function will enable the interconnection of new BEV charging stations faster by leveraging the flexibility of BEVs to charge in coordination with other loads at the premise. With this standard in place and manufacturer completion of conforming products, utilities will have a clear technological framework available to use in load control programs that accelerates charging infrastructure deployment for their customers.

In addition to the flexible interconnection enabled by PCS, technologies including battery- or generation-backed charging and mobile charging can facilitate rapid charging deployment, even before utility connections can be upgraded. Mobile chargers can be deployed immediately because they do not require an on-site grid connection. They can be used as a temporary solution to bring additional charging infrastructure to locations before a stationary, grid-connected charger can be deployed. Mobile chargers can also help bring charging infrastructure to locations where traditional charger deployments can be more difficult, such as at multi-unit dwellings (Bloomberg 2023).

Additional innovative charging solutions will further accelerate charging deployment by optimizing the use of chargers that have already been installed. Technologies are emerging to make the most of existing charging infrastructure. Other companies are working on facilitating the sharing of chargers between more drivers. One company, EVMatch, developed a software platform for sharing, reserving, and renting EV charging stations, which can allow owners of charging stations to earn additional revenue while making their chargers available to more EV drivers to maximize the benefit of each deployed charger. EVMatch is also rolling out a new product called the EVMatch adapter in partnership with Argonne National Laboratory. The

EVMatch adapter is a smart charging adapter that can turn any Level 1 or 2 EVSE into a smart charger that can remotely monitor and control charging to enable even more efficient utilization of existing chargers (Chenoweth 2023; Harper 2021). Innovative charging models like these can be efficient ways to increase charging access for EVs with a smaller amount of physical infrastructure.

State government plays an important role in vehicle electrification (including aspects of grid resilience), as most electric utilities are regulated by state Public Service Commissions (PSC) and Public Utility Commissioners (PUC) and since Federal funding for vehicle electrification is largely distributed through state agencies. The National Association of Regulatory Utility Commissioners (NARUC), a national association representing the state public service commissioners who regulate essential utility services, including energy, telecommunications, and water, produced a series of documents aimed at providing vehicle electrification-related guidance for state regulators (National Association of Regulatory Utility Commissioners 2022a), facilitating electric vehicle interoperability (National Association of Regulatory Utility Commissioners 2022b), and fostering vehicle electrification equity (National Association of Regulatory Utility Commissioners 2022c). NARUC, in conjunction with the National Association of State Energy Officials (NASEO) and the American Association of State Highway and Transportation Officials (AASHTO), also produced a guide for public utility commissions, state energy offices, and departments of transportation discussing the state-level roles and their interrelations vis-à-vis transportation electrification (National Association of Regulatory Utility Commissioners 2022a).

As discussed in Section IV.C.3 of the preamble and as part of our upstream analysis, we model changes to power generation due to the increased electricity demand anticipated under the final standards. Bulk generation and transmission system impacts are felt on a larger scale, and thus tend to reflect smoother load growth and be more predictable in nature. Further, we project the additional generation needed to meet the projected demand of the light- and medium-duty PEVs under the final standards to be relatively modest compared to the No Action case, ranging from 4 percent in 2030 to approximately 12 percent in 2050. This is roughly equal to the combined latest U.S. annual electricity consumption estimates for data centers (U.S. DOE 2023b) and cryptocurrency mining operations (EIA 2024) or slightly more than the increase in total U.S. electricity end-use consumption between 2021 and 2022 (EIA 2023b). Electric power consumption associated with this final rule is expected to increase by 12 percent during the 26-year period between now and 2050. By comparison, U.S. annual electric power consumption increased by a similar amount over a shorter 20-year period between 2002 and 2022, a period during which the electric power sector reliability remained “relatively consistent” between 2013 and 2019 (EIA 2023c), according to the EIA, when excluding major events. While changes in 2013 to EIA’s electric reliability reporting complicate direct comparisons with electric reliability data prior to that year, researchers at Lawrence Berkeley National Laboratory did not find evidence of a change in electric reliability metrics between 2000 and 2015, when considering the effects of severe weather and utility spending on the long-term reliability of the U.S. power system (Larsen et. al., 2020).

#### **5.4.1 Factors Affecting Distribution Grid Reliability**

The electric power system in the U.S. has historically been a very reliable system (NREL 2024), with utilities, system planners, and reliability coordinators working together to ensure an

efficient and reliable grid with adequate resources for supply to meet demand at all times. The power sector analysis conducted in support of this rule indicates that resource adequacy (EPA 2024a) and grid reliability can be maintained (see Section IV.C.3 of the preamble and RIA Chapter 5). The electric power system is comprised of three subsystems – generation, transmission, and distribution – each of which have their own unique electric reliability attributes. These attributes are discussed below.

Power interruptions caused by extreme weather are the most-commonly reported, naturally-occurring factors affecting grid reliability, with the frequency of these severe weather events increasing significantly over the past twenty-years due to climate change (U.S. DOE 2023c). Conversely, decreasing emissions of greenhouse gases can be expected to reduce future extreme weather events relative to current severe weather events as well as future severe weather events if GHG emissions continue unabated, which would serve to reduce the risks for electric power sector reliability. Extreme weather events include snowstorms, hurricanes, and wildfires. These power interruptions have significant impact on economic activity, with associated costs in the U.S. estimated to be \$44 billion annually (LaCommare et. al., 2018). The effects of extreme weather events on grid reliability can be largely discerned using electric power reliability indices. These indices are reported to EIA with and without inclusion of Major Event Days (MED). MEDs are used to statistically differentiate between electric power reliability associated with normal day-to-day operation and reliability associated with atypical operation, such as extreme weather events. MEDs allow for "major events to be studied separately from reliability performance that occurs during what would be considered normal operation, and, to better reveal trends in normal operation that would be hidden by the large statistical effect of major events." (Warren 2003). Increasingly, MEDs are associated with extreme weather events; climate change has led to an increase in the frequency and intensity of extreme weather events (NASA 2024), which have led to significant, widespread power interruptions (G. U. DOE 2023). For example, six hurricanes were classified as "major" in the 2017 Atlantic hurricane season. The long-term average number of major hurricanes since 1851 is six per decade (NOAA n.d.). The average duration of annual electric power interruptions in the U.S., approximately two hours, decreased slightly from 2013 to 2021, when extreme weather events associated with climate change are excluded from reliability statistics (EIA 2023). When extreme weather events associated with climate change are not excluded from reliability statistics, the national average length of annual electric power interruptions increased to about seven hours (EIA 2022b).

Around 93 percent of all power interruptions in the U.S. occur at the distribution-level, with the remaining fraction of interruptions occurring at the generation- and transmission-levels (J. L. Eto, Distribution system versus bulk power system: identifying the source of electric service interruptions in the US 2019) (Larsen, Severe Weather, Utility Spending, and the Long-term Reliability of the U.S. Power System 2020). As a part of its overall national security and energy emergency management responsibilities, DOE's Office of Cybersecurity, Energy Security, and Emergency Response collects grid reliability information on electric incidents and emergencies via the Electric Emergency Incident and Disturbance Report (Form DOE-417). Summaries of these reports appear annually in Electric Disturbance Events (OE-417) Annual Summaries (DOE, Electric Disturbance Events (OE-417) Annual Summaries 2023). In 2023, about two percent of all power interruptions reported to DOE were attributable to unexpected transmission losses and about two and a half percent of all reported power interruptions reported to DOE were attributable to fuel supply emergencies and large uncontrolled losses of generation capacity

(DOE, Electric Disturbance Events (DOE-417) 2023). Given differences in study methodologies, total power interruption percentages may not sum to one hundred percent. Grid reliability is also tracked by NERC and the EIA. Power interruption reports are submitted with standardized reliability indices that focus upon the frequency and duration of power interruptions. These standardized reliability indices are described by the Institute of Electrical and Electronics Engineers (IEEE) in 1366-2022 IEEE Guide for Electric Power Distribution Reliability Indices (IEEE 2022). A discussion of grid reliability and factors affecting it for each of the three electric power sector subsystems appears below, starting with the distribution system.

#### **5.4.2 Distribution Grid Reliability Continues to Improve**

As discussed above, most power interruptions occur at the distribution system level. Researchers at Lawrence Berkeley National Laboratory (LBNL) found very few publicly available, peer-reviewed studies that evaluate long-term trends in electric reliability over broad geographic areas that also include formal analysis to validate the statistical significance (J. L. Eto, Distribution system versus bulk power system: identifying the source of electric service interruptions in the US 2019) (Larsen, Severe Weather, Utility Spending, and the Long-term Reliability of the U.S. Power System 2020). Earlier studies on grid reliability suggest that power system reliability was decreasing over time. For instance, such studies examined publicly available data from over 155 utilities, representing 50 percent of U.S. electricity sales, and spanning up to 10 years and found a modest, yet statistically significant, decrease in grid reliability at a rate of about two percent annually (J. L. Eto 2012). As of 2007, all power interruptions reported to DOE are also required to be reported to NERC. As such, the DOE and NERC grid reliability datasets would be expected to mirror each other.

However, further analysis by LBNL researchers of previous grid reliability studies and the underlying grid reliability data submitted to DOE and NERC was found to reveal that the apparent decrease in grid reliability reversed when the study timeframe was expanded beyond 10 years and data appropriately screened for errors (J. L. Eto 2012). The LBNL researchers also found that changes in the grid reliability reporting rules, which were made mandatory during the timeframe of some studies, may have resulted in a skewing of the data gathered after the rule change (Fisher 2012).

The LBNL researchers also found that many previous grid reliability studies rely upon data from DOE and NERC which have been found to be incomplete and inconsistent. For example, nine power interruptions reported to DOE were not found in the NERC data, and power interruptions reported to NERC were not reported to DOE, even though they meet the DOE reporting criteria (Larsen, Severe Weather, Utility Spending, and the Long-term Reliability of the U.S. Power System 2020). The researchers also found three events in the NERC grid reliability dataset in which the power to more than 50,000 customers was interrupted, but these were not found in the DOE dataset. As noted earlier, the DOE and NERC grid reliability datasets should have been identical, since as of 2007 all DOE events are required to be reported to NERC as well. NERC grid reliability data were inconsistent with comparable information reported to DOE.

The researchers also found grid reliability studies in which the statistical significance of the accompanying results were not tested yet included in the analyses. Researchers also found as much as a 54 percent difference between power interruption statistics in a given year.



After accounting for study design shortcomings and data inconsistencies observed in other studies, the LBNL researchers concluded, with statistical significance, that the regional and U.S. national-level grid reliability trends are, in fact, improving. Across all utilities, there are, on average, 1.8 percent fewer interruptions for an average customer. The trend ranges from less than a one-percent decrease in New England to more than a four-percent decrease in the Rocky Mountain region. This study considered 16 years of data from 203 U.S. utilities, which represent about 70 percent of electricity sales.

Other studies have found that electric vehicles can provide valuable grid reliability benefits (Tuffner 2021). These researchers, from the Pacific Northwest National Laboratory (PNNL) and Idaho National Laboratory (INL), found that "PEVs can be programmed to act during voltage dips in a way that, both, is friendly to the grid and causes no significant inconvenience to the operation of the vehicles." This research was motivated by concerns as early as the late 1980's that some residential air conditioners could, under certain conditions, inadvertently affect electric power system reliability (Williams 1992) (Kosterev 2009). As a result, a consortium from the private sector, electric utilities, academia, national laboratories, NERC, air conditioning manufacturers, and the DOE, collaborated in a series of three DOE-sponsored national workshops in 2008, 2009, and 2015 to identify the nature of the potential residential air conditioning issues. Through these efforts, methodology and protocols to avert such issues were developed (CERTS 2008) (DOE, U.S. DOE–NERC Workshop on Fault-Induced Delayed Voltage Recovery (FIDVR) 2009). While this research was expanded to include the potential effects of electric vehicle charging, it must be noted that electric vehicles have not been implicated in any such electric power sector disturbances. The potential characteristics of plug-in electric vehicle charging was further discussed by EPRI at the NERC-DOE FIDVR Workshop in 2015 (Halliwell 2015).

In the study from PNNL/INL, which started in 2014, researchers at INL observed the behavior of six different light-duty electric vehicles when charging from 240 V Level 2 chargers. The real-life charging characteristics obtained from the electric vehicles were then used to simulate the charging of various combinations of the six test vehicles. The researchers applied the simulated electric vehicle charging loads to a representative distribution feeder from Phoenix, AZ, which consisted of 1,594 single family residences, 45 percent of which were equipped with standard air conditioning systems. The simulated charging loads for 120 electric vehicles was superimposed upon the residential loads of the 1,594 single-family residences as well as their associated air conditioning loads. As a result of this analysis, researchers identified electric vehicle charging characteristics that could potentially benefit grid reliability, referred to as "grid friendly" charging attributes (J. Eto 2023).

To address concerns about the potential of the distribution system to integrate new PEV charging loads, we commissioned a study under an interagency agreement with DOE to assess both the costs of potential distribution system upgrades as well as the availability of necessary distribution system components that could be associated with the level of PEV charging demand projected for both this final rule and Greenhouse Gas Emissions Standards for Heavy-Duty Vehicles - Phase 3. A discussion of the study is in Section IV.C.5.ii of the preamble.

### **5.4.3 Transportation Electrification Impact Study**

We commissioned a study as part of an interagency agreement with the U.S. Department of Energy entitled the "Transportation Electrification Impact Study" (TEIS) to estimate the

potential costs and benefits associated with electrical distribution system upgrades that may incur as a result of this final rule in addition to those of the Greenhouse Gas Emissions Standards for Heavy-Duty Vehicles – Phase 3 (E. Wood, B. Borlaug, et al., Multi-State Transportation Electrification Impact Study 2024). These costs and benefits include new or replacement substations, underground and overhead distribution feeders, and service transformers, all in rural, suburban, and urban locations, as well as along freight corridors. To do so, our study builds upon the methodology developed by the California Public Utilities Commission (CPUC) for their Electrification Impacts Study Part 1. The Part 1 CPUC study, which is considered preliminary, focuses on costs only – and not benefits – associated with preparing California’s electrical distribution system to accommodate the expected large-scale integration of distributed energy resources (DER).

DERs are a wide variety of resources, such as electric battery storage systems, rooftop solar panels, smart thermostats, energy efficiency measures, thermal energy storage systems, or electric vehicles and their charging equipment that reduce power usage. DERs are considered non-wires alternative (NWA), a non-traditional approach to defer and/or replace the need for specific transmission and distribution system equipment upgrades. The use of DERs can help support diverse electrification technologies while maintaining system reliability and affordability. DERs have been shown to provide significant distribution system benefits, both financially and in terms of their ability to defer necessary distribution system upgrades. Such deferral allows the upgrades to be coordinated more-effectively by electric utilities and provides greater flexibility in accommodating supply chain shortfalls.

The CPUC Part 1 (California Public Utilities Commission 2023) study upon which our study is, in part, modeled is the first of a two-part study series and is referred to as the DER “unmitigated” case. By design, the CPUC Part 1 study captures only distribution system costs associated with DER implementation in California – that is, costs expected by using exclusively traditional distribution investments. As such, the Part 1 study did not consider alternatives or future potential mitigation strategies, such as alternative time-variant rates or dynamic rates and flexible load management strategies. In short, the Part 1 study depicts what would happen if DER deployment in California is disorderly and “measures were not taken to reduce costs and manage load.” As such, the Part 1 study did not consider alternatives or future potential mitigation strategies, such as alternative time-variant rates or dynamic rates.

Currently underway, the second CPUC study (California Public Utilities Commission 2023) (“Part 2”) of the two-part series is referred to as the “mitigated” case. By design, this study captures only the distribution system benefits associated with DER deployment in California – that is, the study is not limited exclusively to traditional distribution investments and therefore considers alternatives or future potential mitigation strategies, such as alternative time-variant rates or dynamic rates and flexible load management strategies. In short, the Part 2 study depicts what would happen if DER deployment in California is orderly and measures were taken to reduce costs and manage load. As such, the Part 2 study considers alternatives or future potential mitigation strategies, such as alternative time-variant rates or dynamic rates.

The Part 2 CPUC benefits-only study is designed to complement the already-completed Part 1 CPUC cost-only study insofar as the Part 2 study captures the financial benefits associated with DER deployment as well as the benefits associated with distribution system upgrade deferral – essential factors not considered in the Part 1 study (again, by design). Only after the benefit

estimates associated with DER deployment (from the Part 2 CPUC study) are combined with the cost estimates of DER deployment (from the Part 1 CPUC study), the CPUC argues, would an accurate portrayal of large-scale DER deployment in California emerge.

However, some commentors to this rule appear to have misunderstood the purpose of the CPUC “unmitigated” Part 1 cost-only study as well as the inherent cost-only limitations associated with the study and, subsequently, cite incorrectly the preliminary and incomplete results of the Part 1 cost-only study.

In our study, aggregate distribution system-level costs (and benefits) were estimated for five states using premise-level load profiles that were summed and applied to known utility infrastructure elements (i.e., substations, distribution feeder lines, service transformers, etc.) and combined with utility-specific cost information. The resulting system-level cost estimates quantified the level of traditional grid investment required to meet the vehicle electrification load requirements associated with the proposed rule.

Time-series data, geospatial and utility network data, socioeconomic data, and advanced metering infrastructure (AMI) data which were collected, ingested, mapped, and analyzed for this analysis. Using a full-scale distribution capacity expansion approach from the bottom (premise-level) up to the substation level, the methodology identifies where and when the distribution grid will need capacity enhancements under certain policy and charging behavior scenarios consistent with this final rule. The estimates are developed using thermal capacity analysis at the substation, distribution feeder, and service transformer levels. Using machine learning, the study estimates each customer’s premise-level electric load over the study period, using actual customer data.

Premise-level load profiles are developed reflecting the expected adoption of DERs, such as photovoltaic systems and electric vehicles. Unlike our power sector analysis for the proposal, the load profiles used for this analysis combine, for the first time, the load profiles for a no-action case and for the final rule for both the Light- and Medium-Duty Multipollutant Standards (LMDV) and the Greenhouse Gas Emissions Standards for Heavy-Duty Vehicles – Phase 3 (HDP3) Standards into a single power sector analysis. The load profiles from light-, medium-, and heavy-duty are distributed into IPM regions using NREL’s EVI-X suite of models for light-duty, MDV, and heavy-duty buses; and using LBNL’s HEVI-LOAD model for all other heavy-duty applications. The resulting premise-level load profiles were aggregated up to electric utility service territories. These profiles included DER-specific adoption and are used to identify the magnitude and location of high electrification and DER adoption. The system-level grid impacts and costs of electricity service were determined based upon the profiles.

This methodology is first applied to five-states, which were selected based on their diversity in urban/rural population, utility distribution grid composition, freight travel demands, and state EV policies. The selected states are California, Oklahoma, Illinois, Pennsylvania, and New York. The results from these five-states are then extrapolated to the 67 IPM regions that we use to represent the remaining 48 contiguous states within our power sector analysis.

#### **5.4.3.1 TEIS Results**

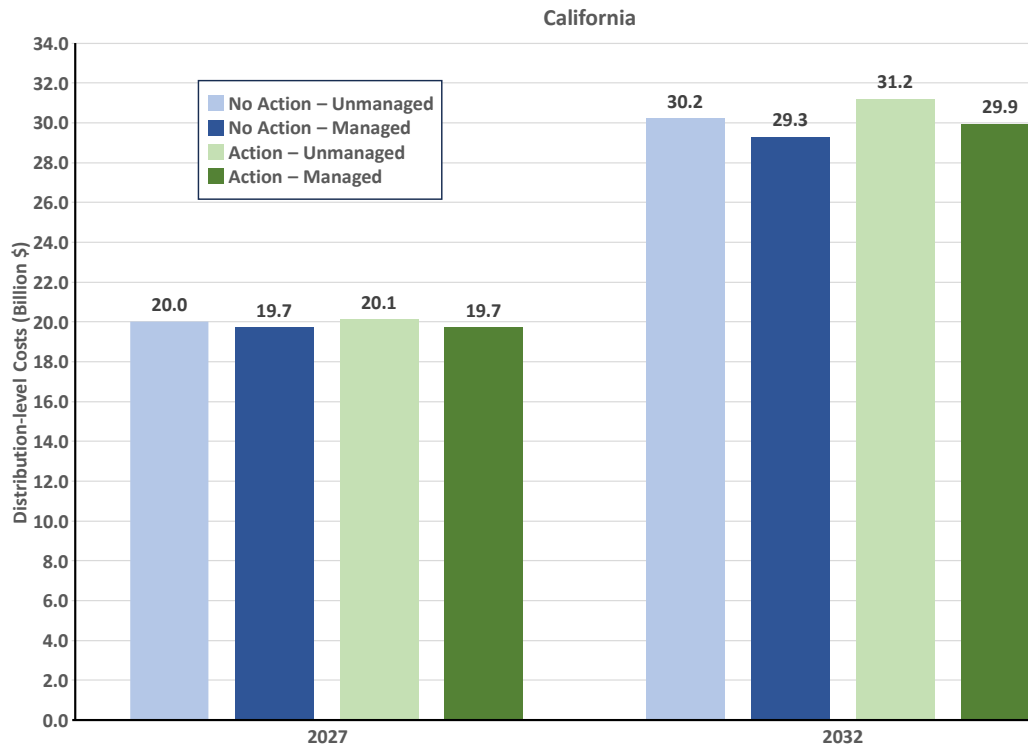
The combined results of the five-state study are summarized in Figure 5-25 through Figure 5-27. Results were also extrapolated nationally and aggregated into the 67 IPM regions and

national level results are shown in Figure 5-28 for the combined LMDV and HDP3 PEV charging demand. The “no action” scenario represents transportation impacts due to existing policies, examples of which include vehicle electrification provisions of the IRA and due to California’s Advanced Clean Trucks (ACT) program. The “action” scenario represents the impacts of the Agency’s LMDV final rule combined with estimated impacts projected due to HDP3 (see Chapter 5.2.3.2).

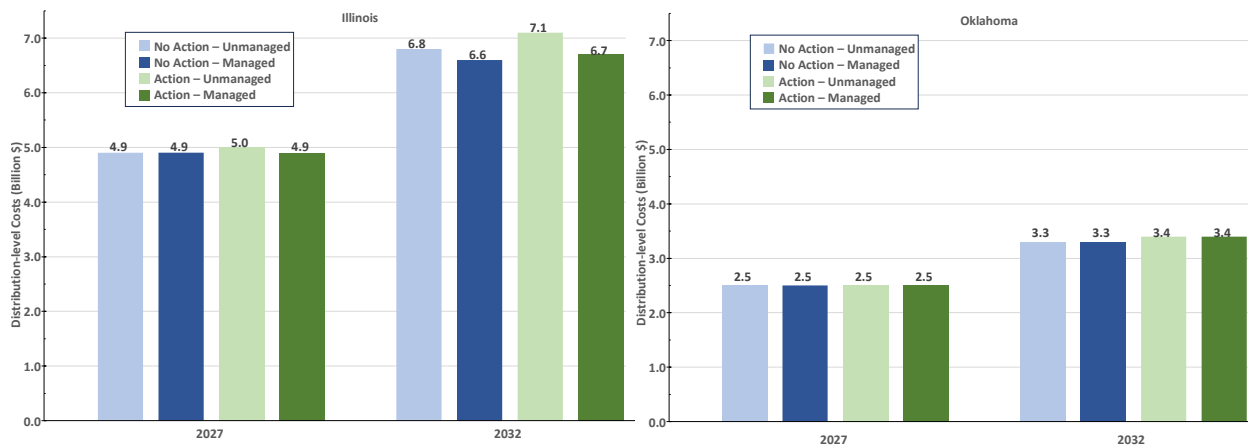
Note that while distribution-level costs increase year-over-year for both the no-action case and for the combined results of the LMDV final rule and projected HDP3 impacts, net costs for generation and transmission combined decrease year-over-year primarily due to the impact of power sector provisions within the IRA. Thus the projected retail price of electricity was relatively insensitive to distribution-level costs. The net impact was a year-over-year decrease in the retail price of electricity for both the no action and for LMDV and HDP3 (Figure 5-28), and a small, incremental (0.35 cents/kWh) increase in the national average retail price of electricity. However, as described in our summary of RPM in Chapter 5.2.4, this small incremental increase did appear to be primarily due to distribution-level costs.

The TEIS also examines the benefits of a simple managed charging approach, wherein the peak charging rate is reduced by spreading charging over the full dwell period. In 95 percent of all cases (Action and No Action), managed charging was less expensive or as expensive as unmanaged charging. In other words, when neglecting the other benefits associated with this final rule, it would cost more to do nothing than (not manage electric vehicle charging) than it would to manage electric vehicle charging in 95 percent of the cases. Managed charging was less expensive than unmanaged charging by about one percent, on average. These values ranged from -0.9 percent in Pennsylvania (the lone exception, where managed charging was more expensive than unmanaged charging) to 6.0 percent in Illinois (where Action Unmanaged was more expensive than Action managed). The benefits of managed charging increases with increasing PEV penetration. For instance, the degree to which managed charging costs were less than unmanaged charging costs were the greatest in California, the state with the highest PEV penetration of the five states considered, in both 2027 and 2032. Conversely, there was no difference between managed charging costs and unmanaged charging costs in Oklahoma, the state with the lowest PEV penetration of the five states considered, in 2027 and 2032. This effect is also apparent over time for states that had the greatest increase in PEV penetration between the years 2027 and 2032. More advanced managed charging that accounts for the load profiles of other end uses would be expected to result in even greater benefits.

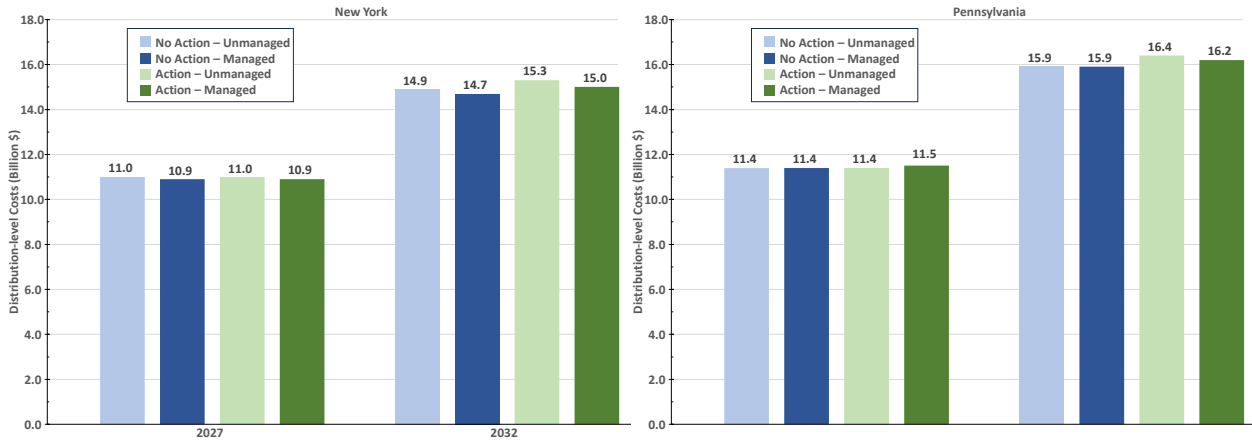
Some other findings associated with the TEIS include: annual charging infrastructure needs could increase by 3 percent across five states; incremental distribution grid investment needs represent approximately 3 percent of current annual utility investments in the distribution system; incremental distribution grid investment needs decrease by 30 percent with basic managed charging techniques; and benefits of vehicle electrification to consumers outweigh the estimated cost of charging infrastructure and grid upgrades.



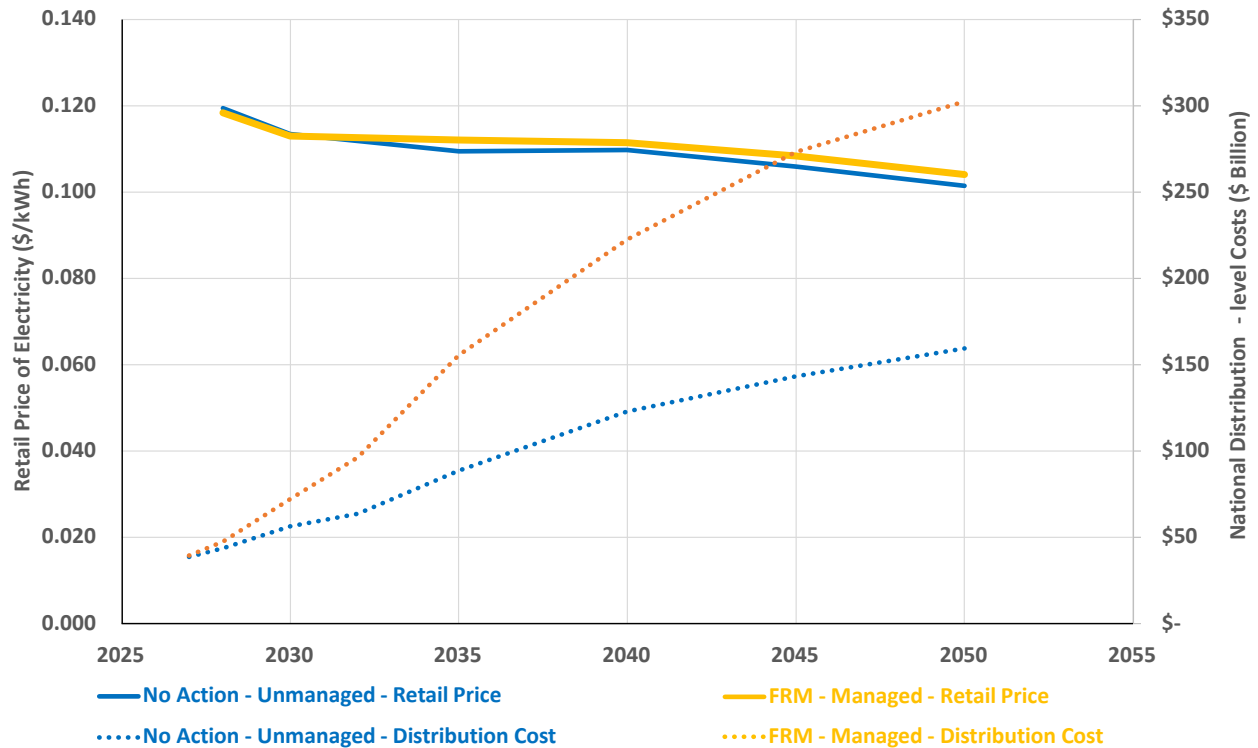
**Figure 5-25: A comparison of the costs needed for distribution level upgrades for the no-action and action scenarios and showing the impacts of managed vs. unmanaged charging in California.**



**Figure 5-26: A comparison of the costs needed for distribution level upgrades for the no-action and action scenarios and showing the impacts of managed vs. unmanaged charging in Illinois (left) and Oklahoma (right).**



**Figure 5-27: A comparison of the costs needed for distribution level upgrades for the no-action and action scenarios and showing the impacts of managed vs. unmanaged charging in New York (left) and Pennsylvania (right).**



**Figure 5-28: National distribution-level cost comparison of the no action case with unmanaged growth to the FRM with managed growth and respective national average retail price of electricity (see also Chapter 5.2.4)**

With managed charging, the final standards provide significant distribution system benefits, both financially and in terms of their ability to defer necessary distribution system upgrades. By more-effectively utilizing existing electric power system assets, managed electric vehicle charging has been shown to help reduce overall electricity costs by allowing for the deferral of electric power system upgrades, with deferral potential of between 5 and 15 years over the 2021–2050 period (Kintner-Meyer et. al., 2022). While such deferrals reduce immediate capital expenditures for electric power system operators, they also extend the functional lifespan of these assets, provide electric utility planners with additional time to more-effectively schedule and coordinate needed distribution system upgrades, consider cost-effective planning options, and help mitigate supply chain shortages for electric power system components.

Relative to the No-Action case, the cost associated with increasing distribution system capacity under the Action case decreases in three of the five modeled states. California, Illinois, and Pennsylvania see decreases of about -0.9 percent in California and Illinois to -1.9 percent in Pennsylvania. New York and Oklahoma see increases in costs of about 0.8 percent to 3.1 percent, respectively. Oklahoma was selected as one of the five modeled states because it is representative of typical long-distance freight corridors. However, the anomalously high costs in the state appear to be attributed to the disproportionately large number of high-power charging located along its freight corridors relative to lower power chargers, which were found to be undercounted.

The final rate-payer impacts associated with the final rule are to be determined using the Retail Price Model (RPM), which provides a first order estimate of average retail electricity price. RPM is a part of the IPM suite of power sector modeling tools.

While additional capacity must be built in any case to meet the increasing electric power demands associated with vehicle electrification, an additional 5 GW (eight percent) of generation capacity must be added under the Action-Unmanaged Charging case, compared to the Action case with managed charging.

The results from the five-state analysis are extrapolated across the U.S. to the remaining 48 contiguous states for 2027 and 2032. These cost estimates are extrapolated at the county-level for each state to yield a total cost for each county by asset type (i.e., substation, distribution line, service transformer, etc.). The net cost of the distribution-level upgrades estimated within TEIS are included within our analysis of costs and benefits for the final rule along with other grid-related costs modeled by IPM. These costs were aggregated into IPM regions, and the rate-payer impacts associated with the final rule are to be determined using the Retail Price Model (RPM), which provides a first-order estimate of average retail electricity price (see Chapter 5.2.1 and 5.2.4).

The estimated cost per kWh for noncoincident peaks occurring during EV charging was determined by using the incremental costs for capital addition for each asset type. Extreme outliers were removed from the dataset when they were found to exceed six standard deviations from the mean by EVSE type, scenario, and asset type.

The weighted-average cost per scenario and EVSE type are applied to the number of ports per county per EVSE and averages were calculated for each EVSE type by asset type for each scenario. These values were summed to obtain 2027 cost estimates. Cost estimates for 2032 are

incremental to 2027 cost estimates. The substation costs per kW are the highest across all component types, while feeder costs are the lowest.

Initial cost estimates suggest that 28 states have less than \$1B impact of total costs of lower 48, or 11 percent of total for the final rule in 2032. Distribution system upgrade costs associated with the final rule are greatest in California, followed by New York, Texas, New Jersey, and Florida. Maryland and Massachusetts have cost commensurate with Pennsylvania and Illinois. These costs are distributed over the electric utility rate base on a per kW basis. Final costs estimates are to be developed using the Retail Price Model as noted.

#### **5.4.4 Transmission Improvements Increase Grid Reliability**

The transmission system is another portion of the electric power system with unique grid reliability attributes. The federal government has limited authority to direct transmission system planning. Delays in the planning, permitting, and construction of transmission power lines are common (Rand, et. al., 2023).

Existing transmission lines are often congested and may not have sufficient capacity to carry new generation loads (DOE, 2023a), while existing generation loads often pay congestion penalties for the right to use the overcrowded transmission lines (Millstein, et. al., 2022; DOE 2023b; Rand, et. al., 2023). While obstacles, such as transmission line delays and transmission line congestion, exist, several innovative solutions have been developed and deployed by DOE, including the Grid Deployment Office (DOE, 2023b). For example, two 230-kV transmission lines used by PPL Electric Utilities, in Pennsylvania, were found to be approaching their maximum transmission capacity in 2020. As a result, the utility paid more than \$60 million in congestion fees in the winters of 2021-2022 and 2022-2023 (Lehmann, et. al., 2023). Rather than rebuilding or reconductoring the two transmission lines, which would have cost tens of millions of dollars, the utility spent under \$300 thousand installing dynamic line rating (DLR) sensors, which helped the utility to rebalance each of the two transmission lines and allowed them to reliably carry an additional 18 percent of power (FERC, 2023a; Lehmann, et. al., 2023).

New solar and wind generation, as well as fossil-fuel-fired generation, depend upon access to transmission lines to deliver power they generate to end-users. New generation awaiting authorization to connect to the transmission system are said to be in “interconnection queues.” The amount of new potential electric generating capacity in these queues is growing significantly, with over 2,000 gigawatts (GW) of total generation and storage capacity now seeking connection to the grid. Approximately 95 percent of this new potential electric generating capacity is from renewable resources, such as solar, wind, and battery storage. Without adequate transmission line capacity, projects in the interconnection queues are often cancelled. Most proposed electric generating projects applying for interconnection are withdrawn, and those that are built take longer on average to complete the required studies and become operational. The typical interconnection wait time from connection request to commercial operation increased from less than two years, for projects built between 2000-2007, to nearly four years for those projects built between 2018-2022 (with a median of 5 years for projects built in 2022).

To alleviate the interconnection queue backlog, DOE recently announced several programs and projects. Examples of such programs and projects include DOE’s Interconnection Innovation e-Xchange (i2X), which aims to increase data access and transparency, improve process and



timing, promote economic efficiency, and maintain grid reliability; FERC Order 2023, which provides generator interconnection procedures and agreements to address interconnection queue backlogs, improve certainty, and prevent undue discrimination for new technologies; and DOE's Grid Resilience and Innovation Partnerships (GRIP) program, with \$10.5 billion in Bipartisan Infrastructure Law funding to develop and deploy Grid Enhancing Technologies (GET), such as Dynamic Line Ratings (DLR) and Advanced Power Flow Controllers (APFC).

Energy storage projects can also be used to help reduce transmission line congestion and are seen as alternatives to transmission line construction. These projects, known as Storage As Transmission Asset (SATA), can help to reduce transmission line congestion, have smaller footprints, have shorter development, permitting, and construction times, and can be added incrementally, as required. Examples of SATA projects include the ERCOT Presidio Project, a 4 MW battery system that improves power quality and reduces momentary outages due to voltage fluctuations; the APS Punkin Center, a 2 MW, 8 MWh battery system deployed in place of upgrading 20 miles of transmission and distribution lines; the National Grid Nantucket Project, a 6 MW, 48 MWh battery system installed on Nantucket Island, MA, as a contingency to undersea electric supply cables; and the Oakland Clean Energy Initiative Projects, a 43.25 MW, 173 MWh energy storage project to replace fossil generation in the Bay area.

Through such efforts, the interconnection queues can be reduced in length, transmission capacity on existing transmission lines can be increased, additional generation assets can be brought online, and electricity generated by existing assets will be curtailed less often. These factors help to improve overall grid reliability.

#### **5.4.5 Electric Generation Will Continue To Be Reliable Under this Final Rule**

Electricity production from coal-fired electric power plants decreased from about fifty-percent of the U.S. generation base in 2004 to about twenty-percent in 2022 (EIA 2023). Some states and regions, such as New England and California, have shifted almost entirely away from coal, and several electric power utilities are already coal-free or have announced their intent to close coal-fired generation capacity.

Given the additional electricity demand stemming from this rule, some commenters raised concerns that the additional demands associated with the rule could impact the reliability of the power grid. As such, we conducted an additional resource adequacy and grid reliability assessment of the impacts of the vehicle rule and how projected outcomes under the rule compare with projected baseline outcomes in the presence of the IRA. We used power sector modeling (IV.C.3) to estimate emissions from electric power plants for loads associated with vehicle electrification as well as to assess generation resource adequacy and grid reliability of the rapidly-transitioning electric grid. The results of the additional resource adequacy assessment appear in the associated Technical Memorandum for Multi-Pollutant Emissions Standards for Model Years 2027 and Later Light-Duty and Medium-Duty Vehicles, and Greenhouse Gas Emissions Standards for Heavy-Duty Vehicles – Phase 3 ("The Report").

The Report uses the same scenario and years of analysis contained in the RIA. The scenarios include a base case and the final rule scenario. For purposes of the resource adequacy and reliability assessment, estimates and projections are taken from those same scenarios and years as shown in the RIA (2030, 2040, and 2050).

The focus of the analysis is on comparing the illustrative final rule scenario from the RIA to a baseline "No Action case" (absent the rule requirements). In this framework, the emphasis is on the incremental changes in the power system that are projected to occur under the presence of the rule in the 2030, 2040, and 2050 model run years. The results presented in the Report further demonstrate, for the specific power sector cases illustrated in Chapter 5 of the RIA, that the implementation of this rule combined with the HD Phase 3 proposal can be achieved without undermining resource adequacy, which is a central element of grid reliability. The Report also evaluates the cumulative impacts of these rules combined several recently proposed Power Sector Rules, and it finds that these cumulative impacts are associated with changes to the electric grid that are well within the range of fleet conditions that respect resource adequacy, as projected by multiple, highly respected peer-reviewed models. Please refer to the docketed Report for more detailed information on the resource adequacy analysis. Electric generation is currently reliable (EIA 2023d) with ample resource adequacy (NERC, 2023), and power sector modeling conducted in support of this rule projects that this rule will not adversely affect resource adequacy.

Several independent studies, with scenarios and assumptions that bracket the electric power loads expected with this rule, also indicate that resource adequacy will not be adversely affected by this rule. EPA's report, Electricity Sector Emissions Impacts of the Inflation Reduction Act, summarized results from fourteen multi-sector and power sector models under the IRA in 2030 and 2035 (EPA, 2023c). Across the models, wind and solar resources provide 22-54 percent of generation (median of 45 percent) in 2030 and 21-80 percent (median of 50 percent) in 2035. The North American Renewable Integration Study showed how the U.S. could accommodate between 70-79 percent of wind and solar generation by 2050 (Brinkman, et. al., 2021). The Solar Futures Study illustrated power systems with upwards of 80 percent of renewable energy by 2050 (DOE, 2021). Finally, a study published in the journal Joule demonstrates a 100 percent renewable power system for the contiguous U.S. (Cole, et. al., 2021).

Power outages in the U.S. are infrequent, occurring about 1.4 times per customer annually and typically lasting between 2-5 hours (EIA 2023). The effect of power outages on electric vehicle owners is expected to be similar to that of non-electric vehicle drivers. Neither driver will be able to "fuel" during power outages, as gasoline pumps are electric powered. However, electric vehicles can provide their owners with residential power for a limited time. Moreover, electric vehicle chargers that are attached to distributed energy resources, such as homes or businesses with solar and/or stationary battery storage, would be unaffected by power outages and, thereby, can continue to provide charge for electric vehicles via its independent capacity. In fact, electric vehicles could be used to power gasoline pumps during electric power outages. Given that the physical extent of typical power outages tends to be relatively small, electric vehicle drivers, as well as conventional vehicle drivers, can be expected to drive out of the outage area and to unaffected charging or refueling stations, should it become necessary.

## Chapter 5 References

- 86 FR 74434. 2021. (December 30).  
<https://www.federalregister.gov/documents/2021/12/30/2021-27854/revise-2023-and-later-model-year-light-duty-vehicle-greenhouse-gas-emissions-standards>.
- 88 FR 12724. 2023. <https://www.federalregister.gov/documents/2023/02/28/2023-03500/national-electric-vehicle-infrastructure-standards-and-requirements>.
- AFDC. 2024c. "Alternative Fuels Data Center, Alternative Fueling Station Locator." January 10. Accessed January 10, 2024.  
<https://afdc.energy.gov/stations/#/analyze?country=US&fuel=ELEC>.
- . 2024a. Developing Infrastructure to Charge Electric Vehicles.  
[https://afdc.energy.gov/fuels/electricity\\_infrastructure.html](https://afdc.energy.gov/fuels/electricity_infrastructure.html).
- . 2023c. "State Laws and Incentives." Accessed 11, 2023. <https://afdc.energy.gov/laws/state>;  
<https://afdc.energy.gov/laws/12832>; <https://afdc.energy.gov/laws/12320>;  
<https://afdc.energy.gov/laws/5182>; <https://afdc.energy.gov/laws/11493>.
- . 2024b. U.S. Public Electric Vehicle Charging Infrastructure.  
<https://afdc.energy.gov/data/10972>.
- Alexander, Matt, Noel Crisostomo, Wendell Krell, Jeffrey Lu, and Raja Ramesh. 2021. Assembly Bill 2127: Electric Vehicle Charging Infrastructure Assessment. California Energy Commission. <https://www.energy.ca.gov/programs-and-topics/programs/electric-vehicle-charging-infrastructure-assessment-ab-2127>.
- ANL. 2023. "Charging for Heavy-Duty Electric Trucks Frequently Asked Questions about the Megawatt Charging System and SAE J3721." Argonne National Laboratory, March.  
[https://www.anl.gov/sites/www/files/2023-03/MCS\\_FAQs\\_Final\\_3-13-23.pdf](https://www.anl.gov/sites/www/files/2023-03/MCS_FAQs_Final_3-13-23.pdf).
- Apadula, Emily, Rebekah de la Mora, Justin Lindemann, Brian Lips, Vincent Potter, Autumn Proudlove, and David Sarkisian. 2023. 50 States of Electric Vehicles Q4 2022 Quarterly Report & 2022 Annual Review Executive Summary. NC Clean Energy Technology Center. Accessed 3 5, 2023. [https://nccleantech.ncsu.edu/wp-content/uploads/2023/02/Q4-22\\_EV\\_execsummary\\_Final.pdf](https://nccleantech.ncsu.edu/wp-content/uploads/2023/02/Q4-22_EV_execsummary_Final.pdf).
- Bauer, Gordon, Chih-Wei Hsu, Mike Nicholas, and Nic Lutsey. 2021. Charging Up America: Assessing the Growing Need for U.S. Charging Infrastructure Through 2030. The International Council on Clean Transportation. Accessed 11, 2023. <https://theicct.org/wp-content/uploads/2021/12/charging-up-america-jul2021.pdf>.
- BloombergNEF. 2023. "Zero-Emission Vehicles Factbook, A BloombergNEF special report prepared for COP28." December. <https://assets.bbhub.io/professional/sites/24/2023-COP28-ZEV-Factbook.pdf>.
- Borlaug, Brennan, Matteo Muratori, Madeline Gilleran, David Woody, William Muston, Thomas Canada, Andrew Ingram, Hal Gresham, and Charlie McQueen. 2021. "Heavy-duty truck

electrification and the impacts of depot charging on electricity distribution systems." *Nature Energy* 6: 673-682. Accessed 1 13, 2023. <https://doi.org/10.1038/s41560-021-00855-0>.

Borlaug, Brennan, Shawn Salisbury, Mindy Gerdes, and Matteo Muratori. 2020. "Levelized Cost of Charging Electric Vehicles in the United States." *Joule* 4 (7): 1470-1485. Accessed 1 11, 2023. doi:<https://doi.org/10.1016/j.joule.2020.05.013>.

BP. 2023. "BP plans to invest \$1 billion in EV charging across US by 2030, helping to meet demand from Hertz's expanding EV rentals." February 15. [https://www.bp.com/en\\_us/united-states/home/news/press-releases/bp-plans-to-invest-1-billion-in-ev-charging-across-us-by-2030-helping-to-meet-demand-from-hertzs-expanding-ev-rentals.html](https://www.bp.com/en_us/united-states/home/news/press-releases/bp-plans-to-invest-1-billion-in-ev-charging-across-us-by-2030-helping-to-meet-demand-from-hertzs-expanding-ev-rentals.html).

Brown, Abby, Jeff Cappellucci, Emily White, Alexia Heinrich, and Emma Cost. 2024. *Electric Vehicle Charging Infrastructure Trends from the Alternative Fueling Station Locator: Third Quarter 2023*. Golden, CO: National Renewable Energy Laboratory. <https://www.nrel.gov/docs/fy24osti/88223.pdf>.

Burke, S. 2024. "Files supporting the PEV Charging Infrastructure Analysis. Memorandum to Docket EPA-HQ-OAR-2022-0829." March.

California Energy Commission. 2024. "CEC Approves \$1.9 Billion Plan to Expand Zero-Emission Transportation Infrastructure." February 14. <https://www.energy.ca.gov/news/2024-02/cec-approves-19-billion-plan-expand-zero-emission-transportation-infrastructure>.

California Public Utilities Commission, Electric Division. 2023. *Electrification Impacts Study Part 1. Proceeding R.21-06-017 (Order Instituting Rulemaking to Modernize the Electric Grid for a High Distributed Energy Resources Future)*, San Francisco: California Public Utilities Commission.

CERTS. 2008. 2008 US DOE Workshop on the Role of Residential AC in Contributing to Fault-Induced Delayed Voltage Recovery (FIDVR). Accessed 2 28, 2024. <https://certs.lbl.gov/publications/2008-us-doe-workshop-role-residential.html>.

CharIN. 2022. "CharIN e.V. officially launches the Megawatt Charging System (MCS) at EVS35 in Oslo, Norway." June 14. Accessed March 8, 2023. [https://www.charin.global/media/pages/news/charin-e-v-officially-launches-the-megawatt-charging-system-mcs-at-evs35-in-oslo-norway/2bca10e315-1655213569/press\\_release\\_mcs\\_charin\\_final.pdf](https://www.charin.global/media/pages/news/charin-e-v-officially-launches-the-megawatt-charging-system-mcs-at-evs35-in-oslo-norway/2bca10e315-1655213569/press_release_mcs_charin_final.pdf).

Chevrolet. 2023. *Installation Made Easy: Home Charging Installation on Us*. Accessed 3 1, 2023. <https://www.chevrolet.com/electric/living-electric/home-charging-installation>.

Chhaya, S., V. Ananth, R. Ravikumar, G. Bellino, R. Scholer, E. Cutter, C. Botsford, et al. 2019. "Distribution System Constrained Vehicle-to-Grid Services for Improved Grid Stability and Reliability; Publication Number: CEC-500-2019-027; Chhaya, Sunil; McCollough, Norman; Ananth, Viswanath; Maitra, Arindam; Ravikumar, Ramakrishnan; Dunckley, et.al." Accessed December 13, 2022. <https://www.energy.ca.gov/sites/default/files/2021-06/CEC-500-2019-027.pdf>.

CRC. 2023. "Assessing the Battery-Recharging and Hydrogen-Refueling Infrastructure Needs, Costs and Timelines Required to Support Regulatory Requirements for Light-, Medium-, and

Heavy-Duty Zero-Emission Vehicles." Accessed December 17, 2023. [https://crcao.org/wp-content/uploads/2023/09/CRC\\_Infrastructure\\_Assessment\\_Report\\_ICF\\_09282023\\_Final-Report.pdf](https://crcao.org/wp-content/uploads/2023/09/CRC_Infrastructure_Assessment_Report_ICF_09282023_Final-Report.pdf).

DOE. 2023. Electric Disturbance Events (DOE-417). Accessed 2 28, 2024. <https://www.oe.netl.doe.gov/oe417.aspx>.

—. 2023. Electric Disturbance Events (OE-417) Annual Summaries. Accessed 2 28, 2024. [https://www.oe.netl.doe.gov/OE417\\_annual\\_summary.aspx](https://www.oe.netl.doe.gov/OE417_annual_summary.aspx).

—. 2009. "U.S. DOE–NERC Workshop on Fault-Induced Delayed Voltage Recovery (FIDVR)." Arlington: U.S. DOE, 9 29.

DOE, GDO U.S. 2023. Keeping the Lights On in Our Neighborhoods During Power Outages. 11 8. Accessed 2 28, 2024. <https://www.energy.gov/gdo/articles/keeping-lights-our-neighborhoods-during-power-outages#:~:text=According%20to%20Climate%20Central%20%2C%20about,by%20almost%2080%25%20since%202011>.

Domonoske, Camila. 2023. "Big carmakers unite to build a charging network and reassure reluctant EV buyers." July. <https://www.npr.org/2023/07/26/1190188838/ev-chargers-network-range-anxiety-bmw-gm-honda-hyundai-kia-mercedes-stellantis>.

EEI. 2023a. "Electric Transportation Biannual State Regulatory Update." December. <https://www.eei.org/-/media/Project/EEI/Documents/Issues-and-Policy/Electric-Transportation/ET-Biannual-State-Regulatory-Update.pdf>.

—. 2023b. "Issues & Policy: National Electric Highway Coalition." Accessed January 11 2023. <https://www.eei.org/issues-and-policy/national-electric-highway-coalition>.

EIA. 2023. Annual Energy Outlook 2023. EIA. <https://www.eia.gov/outlooks/aeo/>.

—. 2023. Average duration of total annual electric power interruptions, United States (2013-2020). 11 10. Accessed 2 28, 2024. <https://www.eia.gov/todayinenergy/detail.php?id=50316#:~:text=U.S.%20electricity%20customers%20experienced%20eight%20hours%20of%20power%20interruptions%20in%202020,-Source%3A%20U.S.%20Energy&text=On%20average%2C%20U.S.%20electricity%20customers,electricit>.

Electric Power Research Institute. 2022. "Supplemental Project Notice: EVs2Scale2030." Accessed December 14, 2022. <https://www.epri.com/research/products/000000003002025622>.

—. 2012. "Understanding the Grid Impacts of Plug-In Electric Vehicles (PEV): Phase 1 Study -- Distribution Impact Case Studies; Maitra, Arindam;1024101." December 31. Accessed December 13, 2022. <https://www.epri.com/research/products/000000000001024101>.

Electrify America. 2022. "Electrify America Raises \$450 Million - Siemens Becomes a Minority Shareholder; Company Intensifies Commitment to Rapid Deployment of Ultra-Fast Charging." June 28. <https://media.electrifyamerica.com/en-us/releases/190>.

Enis, Julian. 2021. "Electric System Reliability (Presentation from the California Public Utilities Commission)." February 17. <https://www.cpuc.ca.gov/-/media/cpuc->

website/transparency/commissioner-committees/emerging-trends/2021/2021-02-17-electric-system-reliability-presentation---final.pdf.

EPA. 2023. "Volkswagen Clean Air Act Civil Settlement."

<https://www.epa.gov/enforcement/volkswagen-clean-air-act-civil-settlement#investment>.

Eto, J., interview by U.S. EPA. 2023. Discussion of FIDVR and Electric Vehicles

Eto, J., LaCommare, K. 2012. "A quantitative assessment of utility reporting practices for reporting electric power distribution events." 2012 IEEE Power & Energy Society General Meeting. San Diego: IEEE.

Eto, J., LaCommare, K., Caswell, H, and Till, D. 2019. Distribution system versus bulk power system: identifying the source of electric service interruptions in the US. Institution of Engineering and Technology.

—. 2019. "Distribution system versus bulk power system: identifying the source of electric service interruptions in the US." IET Gener. Transm. Distrib.

Experian Automotive. 2022. "Vehicle in Operation Market Data & Reports." Data Set. Accessed June 2022. <https://www.experian.com/automotive/vehicles-in-operation-vio-data>.

Fisher, E., Eto, J., and LaCommare, K. 2012. Understanding Bulk Power Reliability: The Importance of Good Data and A Critical Review of Existing Sources. Berkeley : Lawrence Berkeley National Laboratory.

Ford. 2019. "Ford Introduces North America's Largest Electric Vehicle Charging Network, Helping Customers Confidently Switch to an All-Electric Lifestyle." October 17. Accessed January 11, 2023. <https://media.ford.com/content/fordmedia/fna/us/en/news/2019/10/17/ford-introduces-north-americas-largest-electric-vehicle-charting-network.html>.

Ge, Y., C. Simeone, A. Duvall, and E. Wood. 2021. There's No Place Like Home: Residential Parking, Electrical Access, and Implications for the Future of Electric Vehicle Charging Infrastructure. Technical Report No. NREL/TP-5400-81065, National Renewable Energy Laboratory. <https://www.nrel.gov/docs/fy22osti/81065.pdf>.

GM. 2021. "To Put 'Everybody In' an Electric Vehicle, GM introduces Ultium Charge 360." <https://media.gm.com/media/us/en/gm/home.detail.html/content/Pages/news/us/en/2021/apr/0428-ultium-charge-360.html>.

Halliwell, J. 2015. "Plug-in Electric Vehicle Charging Characteristics." NERC-DOE FIDVR Workshop. Washington, D.C.: U.S. DOE, 9 30.

Hyundai. 2023. Stay powered for your drive. Accessed 1 11, 2023. <https://www.hyundaiusa.com/us/en/electrified/charging>.

ICF. 2019. "Documentation of the Retail Price Model." ICF Contract Report to the U.S. EPA. [https://www.epa.gov/sites/default/files/2019-06/documents/rpm\\_documentation\\_june2019.pdf](https://www.epa.gov/sites/default/files/2019-06/documents/rpm_documentation_june2019.pdf).

IEEE. 2022. IEEE Guide for Electric Power Distribution Reliability Indices. 11 12. Accessed 2 28, 2024. <https://standards.ieee.org/ieee/1366/7243/>.

JOET . 2024b. "Pennsylvania Continues Shift Toward Thriving Electric Transportation Sector." January 23. <https://driveelectric.gov/news/new-pennsylvania-nevi-station>.

JOET. 2024e. "2024 Q1 NEVI Progress Update." February 16. <https://driveelectric.gov/news/nevi-update-q1>.

—. 2024a. "Biden-Harris Administration Bolsters Electric Vehicle Future with More than \$600 Million in New Funding." January 11. <https://driveelectric.gov/news/new-cfi-funding>.

—. 2023f. "Biden-Harris Administration to Invest \$100 Million for EV Charger Reliability." September 13. <https://driveelectric.gov/news/ev-reliability-funding-opportunity>.

—. 2023c. "First Public EV Charging Station Funded by NEVI Open in America." December 13. <https://driveelectric.gov/news/first-nevi-funded-stations-open>.

—. 2024d. "FY23 Ride and Drive FOA DE-FOA-0002881." <https://driveelectric.gov/files/ride-and-drive-foa.pdf>.

—. 2023g. "Joint Office Announces National Charging Experience Consortium." May 18. <https://driveelectric.gov/news/chargex-consortium>.

—. 2024c. "New Funding Enhances EV Charging Resiliency, Reliability, Equity, and Workforce Development." January 19. <https://driveelectric.gov/news/workforce-development-ev-projects>.

—. 2023d. "New York Continues NEVI Charging Station Momentum." December 15. <https://driveelectric.gov/news/new-york-NEVI-charging-station-momentum>.

—. 2023b. "Private Sector Continues to Play Key Part in Accelerating Buildout of EV Charging Networks." February 15. <https://driveelectric.gov/news/#private-investment>.

—. 2023a. "SAE J3400 Charging Connector." <https://driveelectric.gov/charging-connector>.

—. 2023e. "State Plans for Electric Vehicle Charging." <https://driveelectric.gov/state-plans/>.

Kapadia, Vishal. 2023. "Leading the Charge: Walmart Announces Plan to Expand Electric Vehicle Charging Network." April 6. <https://corporate.walmart.com/news/2023/04/06/leading-the-charge-walmart-announces-plan-to-expand-electric-vehicle-charging-network>.

Kia. 2023. Enroll Now in the Electrify America Kia Charge Pass Program. Accessed 3 1, 2023. <https://owners.kia.com/content/owners/en/kia-electrify.html>.

Kosterev, D., Undrill, J. 2009. "Load Modeling in WECC." DOE-NERC FIDVR Workshop. U.S. DOE, September.

Larsen, P., Lawson, M., LaCommare, K., and Eto, J. 2020. Severe Weather, Utility Spending, and the Long-term Reliability of the U.S. Power System. Lawrence Berkeley National Laboratory.

Larsen, P., Lawson, M., LaCommare, K., and Eto, J. 2020. Severe Weather, Utility Spending, and the Long-term Reliability of the U.S. Power System. Berkeley : Lawrence Berkeley National Laboratory.

Lipman, Timothy, Alissa Harrington, and Adam Langton. 2021. Total Charge Management of Electric Vehicles, Publication Number: CEC-500-2021- 055. California Energy Commission.

Accessed December 13, 2022. <https://www.energy.ca.gov/sites/default/files/2021-12/CEC-500-2021-055.pdf>.

Maitra, Arindam. 2013. "Analysis of Projected Impact of Plug-in Electric Vehicles on the Distribution Grid." In *Frontiers of Engineering: Reports on Leading-Edge Engineering from the 2012 Symposium*. The National Academies Press. Accessed December 13, 2022. doi:10.17226/18185.

McDonald, J. 2024. "IPM Input Data and Results for the LMDV Final Rule - Submission to Docket No. EPA-HQ-OAR-2022-0829."

—. 2023. "PEV Regionalized Charge Demand for the FRM - Memo to the Docket."

NASA. 2024. *Extreme Weather and Climate Change*. 1 30. Accessed 2 82, 2024. <https://climate.nasa.gov/extreme-weather/>.

National Association of Regulatory Utility Commissioners. 2022b. "Electric Vehicle Interoperability Considerations for Public Utility Regulators - An addendum to the NARUC report, *Electric Vehicles: Key Trends, Issues, and Considerations for State Regulators (2019)*; Villarreal, Christopher;" Accessed December 15, 2022. <https://pubs.naruc.org/pub/D548E5DA-1866-DAAC-99FB-70957246AEBE>.

—. 2022a. "Electric Vehicles: Key Trends, Issues, and Considerations for State Regulators; Harper, Charles; McAndrews, Gregory; Sass Byrnett, Danielle;" Accessed December 15, 2022. <https://pubs.naruc.org/pub/32857459-0005-B8C5-95C6-1920829CABFE>.

—. 2022c. "Models for Incorporating Equity in Transportation Electrification Considerations for Public Utility Regulators - An addendum to the NARUC report, *Electric Vehicles: Key Trends, Issues, and Considerations for State Regulators (2019)*; McAdams, Jasmine;" Accessed December 15, 2022. <https://pubs.naruc.org/pub/D4E4DD39-1866-DAAC-99FB-4CE60044ACA7>.

Nicholas, Michael. 2019. *Estimating electric vehicle charging infrastructure costs across major U.S. metropolitan areas*. The International Council on Clean Transportation. Accessed January 11, 2023. [https://theicct.org/sites/default/files/publications/ICCT\\_EV\\_Charging\\_Cost\\_20190813.pdf](https://theicct.org/sites/default/files/publications/ICCT_EV_Charging_Cost_20190813.pdf).

NOAA. n.d. *U.S. Hurricane Strikes by Decade*. Accessed 2 28, 2024. <https://www.nhc.noaa.gov/pastdec.shtml>.

NYPA. 2023. "EVolve NY's Mission: A Fast Electric Charging Station Near You." <https://evolveny.nypa.gov/about-evolve-new-york>.

Oreizi, Darya. 2022. "Burlington Electric Department Launches New Program with EVmatch to Expand EV Charging at Multi-family Properties." September 30. [https://evmatch.com/blog/burlington-electric-department-launches-new-program-with-evmatch-to-expand-ev-charging-at-multi-family-properties/#:~:text=Burlington%20Electric%20Department%20\(BED\)%20recently,stations%20at%20multi%2Dfamily%20properties](https://evmatch.com/blog/burlington-electric-department-launches-new-program-with-evmatch-to-expand-ev-charging-at-multi-family-properties/#:~:text=Burlington%20Electric%20Department%20(BED)%20recently,stations%20at%20multi%2Dfamily%20properties).

Public Law 117-169. 2022. (August 16). <https://www.congress.gov/117/plaws/publ169/PLAW-117publ169.pdf>.



Public Law 117-58. 2021. (November 15). <https://www.govinfo.gov/content/pkg/PLAW-117publ58/pdf/PLAW-117publ58.pdf>.

Reuters. 2023. "Mercedes to launch vehicle-charging network, starting in North America." January 6. Accessed January 10, 2023. <https://www.reuters.com/business/autos-transportation/mercedes-launch-vehicle-charging-network-starting-north-america-2023-01-05/>.

—. 2023. "More automakers plug into Tesla's EV charging network." November 1. <https://www.reuters.com/business/autos-transportation/more-automakers-plug-into-teslas-ev-charging-network-2023-10-05/>.

SAE. 2024. "WIP 2024-01-24 North American Charging System (NACS) for Electric Vehicles." <https://www.sae.org/standards/content/j3400/>.

Schey, Stephen, Kang-Ching Chu, and John Smart. 2022. Breakdown of Electric Vehicle Supply Equipment Installation Costs. Idaho National Laboratory. [https://inldigitallibrary.inl.gov/sites/sti/sti/Sort\\_63124.pdf](https://inldigitallibrary.inl.gov/sites/sti/sti/Sort_63124.pdf).

The White House. 2024. "FACT SHEET: Biden-Harris Administration Announces New Actions to Cut Electric Vehicle Costs for Americans and Continue Building Out a Convenient, Reliable, Made-in-America EV Charging Network." January 19. <https://www.whitehouse.gov/briefing-room/statements-releases/2024/01/19/fact-sheet-biden-harris-administration-announces-new-actions-to-cut-electric-vehicle-costs-for-americans-and-continue-building-out-a-convenient-reliable-made-in-america-ev-charging-ne>.

—. 2023. "Fact Sheet: Biden-Harris Administration Announces New Standards and Major Progress for a Made-in-America National Network of EV Chargers." February 15. Accessed February 27, 2023. <https://www.whitehouse.gov/briefing-room/statements-releases/2023/02/15/fact-sheet-biden-harris-administration-announces-new-standards-and-major-progress-for-a-made-in-america-national-network-of-electric-vehicle-chargers/>.

Tuffner, F., Undrill, J., Scoffield, D., Eto, J, Kosterev, D., and Quint, D. 2021. Distribution-Level Impacts of Plug-in Electric Vehicle Charging on the Transmission System during Fault Conditions. Richland: Pacific Northwest National Lab.

U.S. Department of Energy, Alternative Fuels Data Center. 2023d. "Electric Vehicle Charging Station Locations." Accessed 2 28, 2023. [https://afdc.energy.gov/fuels/electricity\\_locations.html#/analyze?country=US&fuel=ELEC&ev\\_networks=Tesla&ev\\_networks=Tesla%20Destination&ev\\_levels=dc\\_fast](https://afdc.energy.gov/fuels/electricity_locations.html#/analyze?country=US&fuel=ELEC&ev_networks=Tesla&ev_networks=Tesla%20Destination&ev_levels=dc_fast); [https://afdc.energy.gov/fuels/electricity\\_locations.html#/analyze?country=US&fuel=ELEC&ev\\_networks=](https://afdc.energy.gov/fuels/electricity_locations.html#/analyze?country=US&fuel=ELEC&ev_networks=).

U.S. DOE. 2024. Building America's Clean Energy Future. <https://www.energy.gov/invest>.

—. 2023. "FOTW #1314, October 30, 2023: Manufacturers Have Announced Investments of Over \$500 million in More Than 40 American-Made Electric Vehicle Charger Plants." October 30. <https://www.energy.gov/eere/vehicles/articles/fotw-1314-october-30-2023-manufacturers-have-announced-investments-over-500>.

U.S. DOT, FHWA. 2022b. "Historic Step: All Fifty States Plus D.C. and Puerto Rico Greenlit to Move EV Charging Networks Forward, Covering 75,000 Miles of Highway." September 27.

Accessed January 10, 2023. <https://highways.dot.gov/newsroom/historic-step-all-fifty-states-plus-dc-and-puerto-rico-greenlit-move-ev-charging-networks>.

—. 2022a. "The National Electric Vehicle Infrastructure (NEVI) Formula Program Guidance." February 10. Accessed January 10, 2023.

[https://www.fhwa.dot.gov/environment/alternative\\_fuel\\_corridors/nominations/90d\\_nevi\\_formula\\_program\\_guidance.pdf](https://www.fhwa.dot.gov/environment/alternative_fuel_corridors/nominations/90d_nevi_formula_program_guidance.pdf).

U.S. Energy Information Administration. 2019. "The National Energy Modeling System: An Overview 2018." Independent Statistics and Analysis.

[https://www.eia.gov/outlooks/aeo/nems/overview/pdf/0581\(2018\).pdf](https://www.eia.gov/outlooks/aeo/nems/overview/pdf/0581(2018).pdf).

U.S. EPA. 2022a. "GHG Emissions Factors Hub, Table 1 - Stationary Combustion."

<https://www.epa.gov/climateleadership/ghg-emission-factors-hub>.

—. 2022b. "Interagency Agreement with U.S. DOE. OTAQ Transportation Research Collaboration with NREL. EPA IA Identification No. DW-089-92534101-3."

—. 2023a. "Post-IRA 2022 Reference Case - EPA's Power Sector Modeling Platform v6 Using IPM." <https://www.epa.gov/power-sector-modeling/post-ira-2022-reference-case>.

U.S. EPA. 2022c. "Regulatory Impact Analysis for Proposed Federal Implementation Plan Addressing Regional Ozone Transport for the 2015 Ozone National Ambient Air Quality Standard, EPA Docket No. EPA-HQ-OAR-2021-0668-0151."

<https://www.regulations.gov/document/EPA-HQ-OAR-2021-0668-0151>.

—. 2023b. Retail Price Model. April 12. Accessed November 28, 2023.

<https://www.epa.gov/power-sector-modeling/retail-price-model>.

Valdes-Dapena, Peter. 2022. "GM to put thousands of electric vehicle chargers in rural America." December 7. <https://www.cnn.com/2022/12/07/business/gm-chargers/index.html>.

VW. 2023. ID.4. Accessed 11, 2023. <https://www.vw.com/en/models/id-4.html>.

Warren, C. A., J. D. Bouford, R. D. Christie, D. Kowalewski, J. McDaniel, R. Robinson, D. J. Schepers, J. Viglietta, and C. Williams. 2003. Classification of major event days. 2003 IEEE Power Engineering Society General Meeting (IEEE Cat. No. 03CH37491), vol. 1, pp. 466-471. IEEE, 2003.

Williams, B., Schmus, W., and Dawson, D. 1992. "Transmission voltage recovery delayed by stalled air conditioner compressors." IEEE Transactions on Power Systems.

Wood, E., B. Borlaug, K. McKenna, J. Keen, B. Liu, J. Sun, D. Narang, et al. 2024. Multi-State Transportation Electrification Impact Study. U.S. Department of Energy.

Wood, E., B. Borlaug, K. McKenna, J. Keen, B. Liu, N. Narang, L. Kiboma, et al. 2024. Multi-State Transportation Electrification Impact Study. U.S. Department of Energy.

Wood, E., C. Rames, M. Muratori, and S. and Young, S. Raghavan. 2018. Charging Electric Vehicles in Smart Cities: An EVI-Pro Analysis of Columbus, Ohio. Golden, CO: National Renewable Energy Laboratory. <https://www.nrel.gov/docs/fy18osti/70367.pdf>.

Wood, Eric, Brennan Borlaug, Matt Moniot, Dong-Yeon Lee, Yanbo Ge, Fan Yang, and Zhaocai Liu. 2023. The 2030 National Charging Network: Estimating U.S. Light-Duty Demand for Electric Vehicle Charging Infrastructure. Golden, CO USA: National Renewable Energy Laboratory. <https://www.nrel.gov/docs/fy23osti/85654.pdf>.

Wood, Eric, Clement Rames, Matteo. Muratori, Sessa. Raghavan, and Marc Melaina. 2017. National Plug-In Electric Vehicle Infrastructure Analysis. U.S. Department of Energy Office of Energy Efficiency & Renewable Energy. Accessed March 8, 2023. <https://www.nrel.gov/docs/fy17osti/69031.pdf>.

Zayer, Eric, Lucas Martin, Trent Murphey, Mary Stroncek, and Ingo Stein. 2022. EV Charging Shifts into High Gear. Bain & Company. Accessed March 5, 2023. <https://www.bain.com/insights/electric-vehicle-charging-shifts-into-high-gear/>.

## **Chapter 6: Health and Welfare Impacts**

This rule will impact emissions of GHGs, criteria pollutants, and air toxic pollutants. There are health and welfare impacts associated with ambient concentrations of GHGs, criteria pollutants, and air toxics which are described in this chapter.

### **6.1 Climate Change Impacts from GHG Emissions**

Elevated concentrations of greenhouse gases (GHGs) have been warming the planet, leading to changes in the Earth's climate that are occurring at a pace and in a way that threatens human health, society, and the natural environment. While EPA is not making any new scientific or factual findings with regard to the well-documented impact of GHG emissions on public health and welfare in support of this rule, EPA is providing in this section a brief scientific background on climate change to offer additional context for this rulemaking and to help the public understand the environmental impacts of GHGs.

Extensive information on climate change is available in the scientific assessments and the EPA documents that are briefly described in this section, as well as in the technical and scientific information supporting them. One of those documents is EPA's 2009 Endangerment and Cause or Contribute Findings for Greenhouse Gases Under section 202(a) of the CAA (74 FR 66496, December 15, 2009). In the 2009 Endangerment Finding, the Administrator found under section 202(a) of the CAA that elevated atmospheric concentrations of six key well-mixed GHGs – CO<sub>2</sub>, methane (CH<sub>4</sub>), nitrous oxide (N<sub>2</sub>O), HFCs, perfluorocarbons (PFCs), and sulfur hexafluoride (SF<sub>6</sub>) – “may reasonably be anticipated to endanger the public health and welfare of current and future generations” (74 FR at 66523). The 2009 Endangerment Finding, together with the extensive scientific and technical evidence in the supporting record, documented that climate change caused by human emissions of GHGs threatens the public health of the U.S. population. It explained that by raising average temperatures, climate change increases the likelihood of heat waves, which are associated with increased deaths and illnesses (74 FR 66497). While climate change also increases the likelihood of reductions in cold-related mortality, evidence indicates that the increases in heat mortality will be larger than the decreases in cold mortality in the U.S. (74 FR 66525). The 2009 Endangerment Finding further explained that compared with a future without climate change, climate change is expected to increase tropospheric ozone pollution over broad areas of the U.S., including in the largest metropolitan areas with the worst tropospheric ozone problems, and thereby increase the risk of adverse effects on public health (74 FR 66525). Climate change is also expected to cause more intense hurricanes and more frequent and intense storms of other types and heavy precipitation, with impacts on other areas of public health, such as the potential for increased deaths, injuries, infectious and waterborne diseases, and stress-related disorders (74 FR 66525). Children, the elderly, and the poor are among the most vulnerable to these climate-related health effects (74 FR 66498).

The 2009 Endangerment Finding also documented, together with the extensive scientific and technical evidence in the supporting record, that climate change touches nearly every aspect of

public welfare<sup>196</sup> in the U.S., including: Changes in water supply and quality due to changes in drought and extreme rainfall events; increased risk of storm surge and flooding in coastal areas and land loss due to inundation; increases in peak electricity demand and risks to electricity infrastructure; and the potential for significant agricultural disruptions and crop failures (though offset to some extent by carbon fertilization). These impacts are also global and may exacerbate problems outside the U.S. that raise humanitarian, trade, and national security issues for the U.S. (74 FR 66530).

In 2016, the Administrator issued a similar finding for GHG emissions from aircraft under section 231(a)(2)(A) of the CAA. (81 FR 54422 2016) In the 2016 Endangerment Finding, the Administrator found that the body of scientific evidence amassed in the record for the 2009 Endangerment Finding compellingly supported a similar endangerment finding under CAA section 231(a)(2)(A), and also found that the science assessments released between the 2009 and the 2016 Findings “strengthen and further support the judgment that GHGs in the atmosphere may reasonably be anticipated to endanger the public health and welfare of current and future generations” (81 FR 54424).

Since the 2016 Endangerment Finding, the climate has continued to change, with new observational records being set for several climate indicators such as global average surface temperatures, GHG concentrations, and sea level rise. Additionally, major scientific assessments continue to be released that further advance our understanding of the climate system and the impacts that GHGs have on public health and welfare both for current and future generations. These updated observations and projections document the rapid rate of current and future climate change both globally and in the U.S. (USGCRP 2017, USGCRP 2016, USGCRP 2018, IPCC 2018, IPCC 2019, IPCC 2019, IPCC 2013, NASEM 2016, NASEM 2017, NASEM 2019) (Blunden and Boyer 2022, US EPA 2021, USGCRP 2023)

The most recent information demonstrates that the climate is continuing to change in response to the human-induced buildup of GHGs in the atmosphere. These recent assessments show that atmospheric concentrations of GHGs have risen to a level that has no precedent in human history and that they continue to climb, primarily because of both historical and current anthropogenic emissions, and that these elevated concentrations endanger our health by affecting our food and water sources, the air we breathe, the weather we experience, and our interactions with the natural and built environments. For example, atmospheric concentrations of one of these GHGs, CO<sub>2</sub>, measured at Mauna Loa in Hawaii and at other sites around the world reached 419 parts per million (ppm) in 2022 (nearly 50 percent higher than preindustrial levels)<sup>197</sup> and have continued to rise at a rapid rate. Global average temperature has increased by about 1.1 °C (2.0 °F) in the 2011–2020 decade relative to 1850–1900. (IPCC 2021) The years 2015–2021 were the warmest 7 years in the 1880–2021 record, contributing to the warmest decade on record with a decadal temperature of 0.82 °C (1.48 °F) above the 20th century. (Blunden and Boyer 2022, NOAA

---

<sup>196</sup> The CAA states in section 302(h) that “[a]ll language referring to effects on welfare includes, but is not limited to, effects on soils, water, crops, vegetation, manmade materials, animals, wildlife, weather, visibility, and climate, damage to and deterioration of property, and hazards to transportation, as well as effects on economic values and on personal comfort and well-being, whether caused by transformation, conversion, or combination with other air pollutants.” 42 U.S.C. 7602(h).

<sup>197</sup> [https://gml.noaa.gov/webdata/ccgg/trends/CO2/CO2\\_anmean\\_mlo.txt](https://gml.noaa.gov/webdata/ccgg/trends/CO2/CO2_anmean_mlo.txt).

2022) The IPCC determined (with medium confidence) that this past decade was warmer than any multi-century period in at least the past 100,000 years. (IPCC 2021) Global average sea level has risen by about 8 inches (about 21 centimeters (cm)) from 1901 to 2018, with the rate from 2006 to 2018 (0.15 inches/year or 3.7 millimeters (mm)/year) almost twice the rate over the 1971 to 2006 period, and three times the rate of the 1901 to 2018 period. (IPCC 2021) The rate of sea level rise over the 20th century was higher than in any other century in at least the last 2,800 years. (USGCRP 2018) Higher CO<sub>2</sub> concentrations have led to acidification of the surface ocean in recent decades to an extent unusual in the past 65 million years, with negative impacts on marine organisms that use calcium carbonate to build shells or skeletons. (IPCC 2018) Arctic sea ice extent continues to decline in all months of the year; the most rapid reductions occur in September (very likely almost a 13 percent decrease per decade between 1979 and 2018) and are unprecedented in at least 1,000 years. (IPCC 2021) Human-induced climate change has led to heatwaves and heavy precipitation becoming more frequent and more intense, along with increases in agricultural and ecological droughts<sup>198</sup> in many regions. (IPCC 2021)

The assessment literature demonstrates that modest additional amounts of warming may lead to a climate different from anything humans have ever experienced. The 2022 CO<sub>2</sub> concentration of 419 ppm is already higher than at any time in the last 2 million years.<sup>199</sup> If concentrations exceed 450 ppm, they would likely be higher than any time in the past 23 million years: (IPCC 2013) at the current rate of increase of more than 2 ppm a year, this would occur in about 15 years. While GHGs are not the only factor that controls climate, it is illustrative that 3 million years ago (the last time CO<sub>2</sub> concentrations were above 400 ppm) Greenland was not yet completely covered by ice and still supported forests, while 23 million years ago (the last time concentrations were above 450 ppm) the West Antarctic ice sheet was not yet developed, indicating the possibility that high GHG concentrations could lead to a world that looks very different from today and from the conditions in which human civilization has developed. If the Greenland and Antarctic ice sheets were to melt substantially, sea levels would rise dramatically—the IPCC estimated that over the next 2,000 years, sea levels will rise by 7 to 10 feet even if warming is limited to 1.5 °C (2.7 °F), from 7 to 20 feet if limited to 2 °C (3.6 °F), and by 60 to 70 feet if warming is allowed to reach 5 °C (9 °F) above preindustrial levels. (IPCC 2021) For context, almost all of the city of Miami is less than 25 feet above sea level, and the 4th National Climate Assessment (NCA4) stated that 13 million Americans would be at risk of migration due to 6 feet of sea level rise.

The NCA4 found that it is very likely (greater than 90 percent likelihood) that by mid-century, the Arctic Ocean will be almost entirely free of sea ice by late summer for the first time in about 2 million years. (USGCRP 2018) Coral reefs will be at risk for almost complete (99 percent) losses with 1°C (1.8°F) of additional warming from today (2 °C or 3.6 °F since preindustrial). At this temperature, between 8 and 18 percent of animal, plant, and insect species could lose over half of the geographic area with suitable climate for their survival, and 7 to 10 percent of rangeland livestock would be projected to be lost. (IPCC 2018) The IPCC similarly

---

<sup>198</sup> These are drought measures based on soil moisture.

<sup>199</sup> Annual Mauna Loa CO<sub>2</sub> concentration data from

[https://gml.noaa.gov/webdata/ccgg/trends/CO2/CO2\\_annmean\\_mlo.txt](https://gml.noaa.gov/webdata/ccgg/trends/CO2/CO2_annmean_mlo.txt), accessed September 9, 2023.

found that climate change has caused substantial damages and increasingly irreversible losses in terrestrial, freshwater, and coastal and open ocean marine ecosystems.

Every additional increment of temperature comes with consequences. For example, the half degree of warming from 1.5 to 2 °C (0.9 °F of warming from 2.7 °F to 3.6 °F) above preindustrial temperatures is projected on a global scale to expose 420 million more people to frequent extreme heatwaves, and 62 million more people to frequent exceptional heatwaves (where heatwaves are defined based on a heat wave magnitude index which takes into account duration and intensity—using this index, the 2003 French heat wave that led to almost 15,000 deaths would be classified as an “extreme heatwave” and the 2010 Russian heatwave which led to thousands of deaths and extensive wildfires would be classified as “exceptional”). It would increase the frequency of sea-ice-free Arctic summers from once in 100 years to once in a decade. It could lead to 4 inches of additional sea level rise by the end of the century, exposing an additional 10 million people to risks of inundation as well as increasing the probability of triggering instabilities in either the Greenland or Antarctic ice sheets. Between half a million and a million additional square miles of permafrost would thaw over several centuries. Risks to food security would increase from medium to high for several lower-income regions in the Sahel, southern Africa, the Mediterranean, central Europe, and the Amazon. In addition to food security issues, this temperature increase would have implications for human health in terms of increasing ozone concentrations, heatwaves, and vector-borne diseases (for example, expanding the range of the mosquitoes which carry dengue fever, chikungunya, yellow fever, and the Zika virus, or the ticks which carry Lyme, babesiosis, or Rocky Mountain Spotted Fever). (IPCC 2018) Moreover, every additional increment in warming leads to larger changes in extremes, including the potential for events unprecedented in the observational record. Every additional degree will intensify extreme precipitation events by about 7 percent. The peak winds of the most intense tropical cyclones (hurricanes) are projected to increase with warming. In addition to a higher intensity, the IPCC found that precipitation and frequency of rapid intensification of these storms has already increased, the movement speed has decreased, and elevated sea levels have increased coastal flooding, all of which make these tropical cyclones more damaging. (IPCC 2021)

The NCA4 also evaluated a number of impacts specific to the U.S. Severe drought and outbreaks of insects like the mountain pine beetle have killed hundreds of millions of trees in the western U.S. Wildfires have burned more than 3.7 million acres in 14 of the 17 years between 2000 and 2016, and Federal wildfire suppression costs were about a billion dollars annually. (USGCRP 2018) The National Interagency Fire Center has documented U.S. wildfires since 1983, and the 10 years with the largest acreage burned have all occurred since 2004. (NIFC 2021) Wildfire smoke degrades air quality, increasing health risks, and more frequent and severe wildfires due to climate change would further diminish air quality, increase incidences of respiratory illness, impair visibility, and disrupt outdoor activities, sometimes thousands of miles from the location of the fire. Meanwhile, sea level rise has amplified coastal flooding and erosion impacts, requiring the installation of costly pump stations, flooding streets, and increasing storm surge damages. Tens of billions of dollars of U.S. real estate could be below sea level by 2050 under some scenarios. Increased frequency and duration of drought will reduce agricultural productivity in some regions, accelerate depletion of water supplies for irrigation, and expand the distribution and incidence of pests and diseases for crops and livestock. The NCA4 also recognized that climate change can increase risks to national security, both through direct impacts on military infrastructure and by affecting factors such as food and water availability

that can exacerbate conflict outside U.S. borders. Droughts, floods, storm surges, wildfires, and other extreme events stress nations and people through loss of life, displacement of populations, and impacts on livelihoods. (USGCRP 2018)

EPA modeling efforts can further illustrate how these impacts from climate change may be experienced across the U.S. EPA's Framework for Evaluating Damages and Impacts (FrEDI) uses information from over 30 peer-reviewed climate change impact studies to project the physical and economic impacts of climate change to the U.S. resulting from future temperature changes. (Hartin, Advancing the estimation of future climate impacts within the United States 2023, U.S. EPA 2022, U.S. Dept of State and U.S. Executive Office of the President 2021, OMB 2022) These impacts are projected for specific regions within the U.S. and for more than 20 impact categories, which span a large number of sectors of the U.S. economy. (U.S. EPA 2021)<sup>200</sup> Using this framework, the EPA estimates that global emission projections, with no additional mitigation, will result in significant climate-related damages to the U.S.<sup>201</sup> These damages to the U.S. would mainly be from increases in lives lost due to increases in temperatures, as well as impacts to human health from increases in climate-driven changes in air quality, dust and wildfire smoke exposure, and incidence of suicide. Additional major climate-related damages would occur to U.S. infrastructure such as roads and rail, as well as transportation impacts and coastal flooding from sea level rise, increases in property damage from tropical cyclones, and reductions in labor hours worked in outdoor settings and buildings without air conditioning. These impacts are also projected to vary from region to region with the Southeast, for example, projected to see some of the largest damages from sea level rise, the West Coast projected to experience damages from wildfire smoke more than other parts of the country, and the Northern Plains states projected to see a higher proportion of damages to rail and road infrastructure. While information on the distribution of climate impacts helps to better understand the ways in which climate change may impact the U.S., recent analyses are still only a partial assessment of climate impacts relevant to U.S. interests and in addition do not reflect increased damages that occur due to interactions between different sectors impacted by climate change or all the ways in which physical impacts of climate change occurring abroad have spillover effects in different regions of the U.S.

Some GHGs also have impacts beyond those mediated through climate change. For example, elevated concentrations of CO<sub>2</sub> stimulate plant growth (which can be positive in the case of beneficial species, but negative in terms of weeds and invasive species, and can also lead to a reduction in plant micronutrients (Ziska, et al. 2016)) and cause ocean acidification. Nitrous oxide depletes the levels of protective stratospheric ozone. (WMO 2018)

Transportation is the largest U.S. source of GHG emissions, representing 27 percent of total GHG emissions. The GHG emission reductions resulting from compliance with this final rule will significantly reduce the volume of GHG emissions from this sector. Section VI.D.2 of the preamble discusses impacts of GHG emissions on individuals living in socially and economically vulnerable communities. While EPA did not conduct modeling to specifically quantify changes in climate impacts resulting from this rule in terms of avoided temperature change or sea-level

---

<sup>200</sup> Available at <https://www.epa.gov/cira/fredi>. Documentation has been subject to both a public review comment period and an independent expert peer review, following EPA peer-review guidelines.

<sup>201</sup> Compared to a world with no additional warming after the model baseline (1986–2005).



rise, we did quantify climate benefits by monetizing the emission reductions through the application of the social cost of greenhouse gases (SC-GHG), as described in Section VII.A of the preamble.

These scientific assessments, the EPA analyses, and documented observed changes in the climate of the planet and of the U.S. present clear support regarding the current and future dangers of climate change and the importance of GHG emissions mitigation.

## **6.2 Climate Benefits**

The EPA estimates the climate benefits of GHG emissions reductions expected from the final rule using estimates of the social cost of greenhouse gases (SC-GHG) that reflect recent advances in the scientific literature on climate change and its economic impacts and incorporate recommendations made by the National Academies of Science, Engineering, and Medicine. (National Academies 2017) The EPA published and used these estimates in the RIA for the December 2023 Final Oil and Gas NSPS/EG Rulemaking, “Standards of Performance for New, Reconstructed, and Modified Sources and Emissions Guidelines for Existing Sources: Oil and Natural Gas Sector Climate Review.” The EPA solicited public comment on the methodology and use of these estimates in the RIA for the agency’s December 2022 Oil and Gas NSPS/EG Supplemental Proposal and has conducted an external peer review of these estimates, as described further below.

The SC-GHG is the monetary value of the net harm to society associated with a marginal increase in GHG emissions in a given year, or the benefit of avoiding that increase. In principle, SC-GHG includes the value of all climate change impacts (both negative and positive), including (but not limited to) changes in net agricultural productivity, human health effects, property damage from increased flood risk and natural disasters, disruption of energy systems, risk of conflict, environmental migration, and the value of ecosystem services. The SC-GHG, therefore, reflects the societal value of reducing emissions of the gas in question by one metric ton and is the theoretically appropriate value to use in conducting benefit-cost analyses of policies that affect GHG emissions. In practice, data and modeling limitations restrain the ability of SC-GHG estimates to include all physical, ecological, and economic impacts of climate change, implicitly assigning a value of zero to the omitted climate damages. The estimates are, therefore, a partial accounting of climate change impacts and likely underestimate the marginal benefits of abatement.

Since 2008, the EPA has used estimates of the social cost of various greenhouse gases (i.e., SC-CO<sub>2</sub>, SC-CH<sub>4</sub>, and SC-N<sub>2</sub>O), collectively referred to as the “social cost of greenhouse gases” (SC-GHG), in analyses of actions that affect GHG emissions. The values used by the EPA from 2009 to 2016, and since 2021 – including in the proposal for this rulemaking – have been consistent with those developed and recommended by the IWG on the SC-GHG; and the values used from 2017 to 2020 were consistent with those required by E.O. 13783, which disbanded the IWG. During 2015-2017, the National Academies conducted a comprehensive review of the SC-CO<sub>2</sub> and issued a final report in 2017 recommending specific criteria for future updates to the SC-CO<sub>2</sub> estimates, a modeling framework to satisfy the specified criteria, and both near-term updates and longer-term research needs pertaining to various components of the estimation process. (National Academies 2017) The IWG was reconstituted in 2021 and E.O. 13990 directed it to develop a comprehensive update of its SC-GHG estimates, recommendations regarding areas of decision-making to which SC-GHG should be applied, and a standardized

review and updating process to ensure that the recommended estimates continue to be based on the best available economics and science going forward.

The EPA is a member of the IWG and is participating in the IWG's work under E.O. 13990. As noted in previous EPA RIAs, while that process continues, the EPA is continuously reviewing developments in the scientific literature on the SC-GHG, including more robust methodologies for estimating damages from emissions, and looking for opportunities to further improve SC-GHG estimation.<sup>202</sup> As EPA noted in the LMDV NPRM, in the December 2022 Oil and Gas NSPS/EG Supplemental Proposal RIA the Agency included a sensitivity analysis of the climate benefits of the Supplemental Proposal using a new set of SC-GHG estimates that incorporates recent research addressing recommendations of the National Academies (National Academies 2017) in addition to using the interim SC-GHG estimates presented in the Technical Support Document: Social Cost of Carbon, Methane, and Nitrous Oxide Interim Estimates under Executive Order 13990 (IWG 2021) that the IWG recommended for use until updated estimates that address the National Academies' recommendations are available.

The EPA solicited public comment on the sensitivity analysis and the accompanying draft technical report, External Review Draft of Report on the Social Cost of Greenhouse Gases: Estimates Incorporating Recent Scientific Advances, which explains the methodology underlying the new set of estimates, in the December 2022 Supplemental Oil and Gas Proposal. The response to comments document can be found in the docket for that action.

To ensure that the methodological updates adopted in the technical report are consistent with economic theory and reflect the latest science, the EPA also initiated an external peer review panel to conduct a high-quality review of the technical report, completed in May 2023. See 88 FR at 26075/2 noting this peer review process. The peer reviewers commended the agency on its development of the draft update, calling it a much-needed improvement in estimating the SC-GHG and a significant step toward addressing the National Academies' recommendations with defensible modeling choices based on current science. The peer reviewers provided numerous recommendations for refining the presentation and for future modeling improvements, especially with respect to climate change impacts and associated damages that are not currently included in the analysis. Additional discussion of omitted impacts and other updates have been incorporated in the technical report to address peer reviewer recommendations. Complete information about the external peer review, including the peer reviewer selection process, the final report with individual recommendations from peer reviewers, and the EPA's response to each recommendation is available on EPA's website (EPA 2023f).

The remainder of this section provides an overview of the methodological updates incorporated into the SC-GHG estimates used in this final RIA. A more detailed explanation of each input and the modeling process is provided in the final technical report, EPA Report on the Social Cost of Greenhouse Gases: Estimates Incorporating Recent Scientific Advances. Appendix to Chapter 9 shows the benefits of the final rule using the interim SC-GHG (IWG 2021) estimates presented in the proposal.

---

<sup>202</sup> EPA strives to base its analyses on the best available science and economics, consistent with its responsibilities, for example, under the Information Quality Act.

The steps necessary to estimate the SC-GHG with a climate change integrated assessment model (IAM) can generally be grouped into four modules: socioeconomic and emissions, climate, damages, and discounting. The emissions trajectories from the socioeconomic module are used to project future temperatures in the climate module. The damage module then translates the temperature and other climate endpoints (along with the projections of socioeconomic variables) into physical impacts and associated monetized economic damages, where the damages are calculated as the amount of money the individuals experiencing the climate change impacts would be willing to pay to avoid them. To calculate the marginal effect of emissions, i.e., the SC-GHG in year "t," the entire model is run twice – first as a baseline and second with an additional pulse of emissions in year "t." After recalculating the temperature effects and damages expected in all years beyond "t" resulting from the adjusted path of emissions, the losses are discounted to a present value in the discounting module. Many sources of uncertainty in the estimation process are incorporated using Monte Carlo techniques by taking draws from probability distributions that reflect the uncertainty in parameters.

The SC-GHG estimates used by the EPA and many other federal agencies since 2009 have relied on an ensemble of three widely used IAMs: Dynamic Integrated Climate and Economy (DICE) (W. Nordhaus 2010) Climate Framework for Uncertainty, Negotiation, and Distribution (FUND) (Anthoff and Tol 2013); (Anthoff and Tol 2013b) and Policy Analysis of the Greenhouse Gas Effect. (PAGE) (Hope 2013) In 2010, the IWG harmonized key inputs across the IAMs, but all other model features were left unchanged, relying on the model developers' best estimates and judgments. That is, the representation of climate dynamics and damage functions included in the default version of each IAM as used in the published literature was retained.

The SC-GHG estimates in this RIA no longer rely on the three IAMs (i.e., DICE, FUND, and PAGE) used in previous SC-GHG estimates. As explained previously, EPA uses a modular approach to estimate the SC-GHG, consistent with the National Academies' (National Academies 2017) near-term recommendations. That is, the methodology underlying each component, or module, of the SC-GHG estimation process is developed by drawing on the latest research and expertise from the scientific disciplines relevant to that component. Under this approach, each step in the SC-GHG estimation improves consistency with the current state of scientific knowledge, enhances transparency, and allows for more explicit representation of uncertainty.

The socioeconomic and emissions module relies on a new set of probabilistic projections for population, income, and GHG emissions developed under the Resources for the Future (RFF) Social Cost of Carbon Initiative (K. P. Rennert 2021) (Rennert, Prest, et al. 2022a). These socioeconomic projections (hereinafter collectively referred to as the RFF-SPs) are an internally consistent set of probabilistic projections of population, GDP, and GHG emissions (CO<sub>2</sub>, CH<sub>4</sub>, and N<sub>2</sub>O) to 2300. Based on a review of available sources of long-run projections necessary for damage calculations, the RFF-SPs stand out as being most consistent with the National Academies' recommendations. Consistent with the National Academies' recommendation, the RFF-SPs were developed using a mix of statistical and expert elicitation techniques to capture uncertainty in a single probabilistic approach, taking into account the likelihood of future emissions mitigation policies and technological developments, and provide the level of disaggregation necessary for damage calculations. Unlike other sources of projections, they provide inputs for estimation out to 2300 without further extrapolation assumptions. Conditional

on the modeling conducted for the SC-GHG estimates, this time horizon is far enough in the future to capture the majority of discounted climate damages. Including damages beyond 2300 would increase the estimates of the SC-GHG. As discussed in U.S. EPA (EPA 2023f) the use of the RFF-SPs allows for capturing economic growth uncertainty within the discounting module.

The climate module relies on the Finite Amplitude Impulse Response (FaIR) model, (Smith, et al. 2018, IPCC, Climate Change 2021 - The Physical Science Basis 2021, Millar, et al. 2017) a widely used Earth system model which captures the relationships between GHG emissions, atmospheric GHG concentrations, and global mean surface temperature. The FaIR model was originally developed by Richard Millar, Zeb Nicholls, and Myles Allen at Oxford University, as a modification of the approach used in IPCC AR5 to assess the GWP and GTP (Global Temperature Potential) of different gases. It is open source, widely used (e.g., (IPCC 2018); (IPCC 2021a) and was highlighted by the National Academies (National Academies 2017) as a model that satisfies their recommendations for a near-term update of the climate module in SC-GHG estimation. Specifically, it translates GHG emissions into mean surface temperature response and represents the current understanding of the climate and GHG cycle systems and associated uncertainties within a probabilistic framework. The SC-GHG estimates used in this RIA rely on FaIR version 1.6.2 as used by the IPCC (IPCC 2021). It provides, with high confidence, an accurate representation of the latest scientific consensus on the relationship between global emissions and global mean surface temperature and offers a code base that is fully transparent and available online. The uncertainty capabilities in FaIR 1.6.2 have been calibrated to the most recent assessment of the IPCC (which importantly narrowed the range of likely climate sensitivities relative to prior assessments). See U.S. EPA (EPA 2023f) for more details.

The socioeconomic projections and outputs of the climate module are inputs into the damage module to estimate monetized future damages from climate change.<sup>203</sup> The National Academies' recommendations for the damage module, scientific literature on climate damages, updates to models that have been developed since 2010, as well as the public comments received on individual EPA rulemakings and the IWG's February 2021 TSD, have all helped to identify available sources of improved damage functions. The IWG (e.g., (IWG 2010) (IWG 2016a) (IWG 2021)), the National Academies (2017), comprehensive studies (e.g., (Rose, et al. 2014)), and public comments have all recognized that the damages functions underlying the IWG SC-GHG estimates used since 2013 (taken from DICE 2010 (W. Nordhaus 2010); FUND 3.8 (Anthoff and Tol 2013b); (Anthoff and Tol 2013); and PAGE 2009 (Hope 2013)) do not include all of the important physical, ecological, and economic impacts of climate change. The climate change literature and the science underlying the economic damage functions have evolved, and DICE 2010, FUND 3.8, and PAGE 2009 now lag behind the most recent research.

---

<sup>203</sup> In addition to temperature change, two of the three damage modules used in the SC-GHG estimation require global mean sea level (GMSL) projections as an input to estimate coastal damages. Those two damage modules use different models for generating estimates of GMSL. Both are based off reduced complexity models that can use the FaIR temperature outputs as inputs to the model and generate projections of GMSL accounting for the contributions of thermal expansion and glacial and ice sheet melting based on recent scientific research. Absent clear evidence on a preferred model, the SC-GHG estimates presented in this RIA retain both methods used by the damage module developers. See (EPA 2023f) for more details.

The challenges involved with updating damage functions have been widely recognized. Functional forms and calibrations are constrained by the available literature and need to extrapolate beyond warming levels or locations studied in that literature. Research and public resources focused on understanding how these physical changes translate into economic impacts have been significantly less than the resources focused on modeling and improving our understanding of climate system dynamics and the physical impacts from climate change (Auffhammer 2018). Even so, there has been a large increase in research on climate impacts and damages in the time since DICE 2010, FUND 3.8, and PAGE 2009 were published. Along with this growth, there continues to be wide variation in methodologies and scope of studies, such that care is required when synthesizing the current understanding of impacts or damages. Based on a review of available studies and approaches to damage function estimation, the EPA uses three separate damage functions to form the damage module: (1) a subnational-scale, sectoral damage function (based on the Data-driven Spatial Climate Impact Model (DSCIM) developed by the Climate Impact Lab (CIL 2023) (Carleton 2022) (Rode, et al. 2021); (2) a country-scale, sectoral damage function (based on the Greenhouse Gas Impact Value Estimator (GIVE) model developed under RFF’s Social Cost of Carbon Initiative (Rennert, Errickson, et al. 2022); (3) and a meta-analysis-based damage function (based on (Howard and Sterner 2017)).

The damage functions in DSCIM and GIVE represent substantial improvements relative to the damage functions underlying the SC-GHG estimates used by the EPA to date and reflect the forefront of scientific understanding about how temperature change and SLR lead to monetized net (market and nonmarket) damages for several categories of climate impacts. The models’ spatially explicit and impact-specific modeling of relevant processes allow for improved understanding and transparency about mechanisms through which climate impacts are occurring and how each damage component contributes to the overall results, consistent with the National Academies’ recommendations. DSCIM addresses common criticisms related to the damage functions underlying current SC-GHG estimates (e.g., (Pindyck 2017)) by developing multi-sector, empirically grounded damage functions. The damage functions in the GIVE model offer a direct implementation of the National Academies’ near-term recommendation to develop updated sectoral damage functions that are based on recently published work and reflective of the current state of knowledge about damages in each sector. Specifically, the National Academies noted that “[t]he literature on agriculture, mortality, coastal damages, and energy demand provide immediate opportunities to update the [models]” (National Academies 2017), which are the four damage categories currently in GIVE. A limitation of both models is that the sectoral coverage is still limited, and even the categories that are represented are incomplete. Neither DSCIM nor GIVE yet accommodate estimation of several categories of temperature driven climate impacts (e.g., morbidity, conflict, migration, biodiversity loss) and only represent a limited subset of damages from changes in precipitation. For example, while precipitation is considered in the agriculture sectors in both DSCIM and GIVE, neither model takes into account impacts of flooding, changes in rainfall from tropical storms, and other precipitation related impacts. As another example, the coastal damage estimates in both models do not fully reflect the consequences of SLR-driven salt-water intrusion and erosion, or SLR damages to coastal tourism and recreation. Other missing elements are damages that result from other physical impacts (e.g., ocean acidification, non-temperature-related mortality such as diarrheal disease and malaria) and the many feedbacks and interactions across sectors and regions that can lead to

additional damages.<sup>204</sup> See U.S. EPA (EPA 2023f) for more discussion of omitted damage categories and other modeling limitations. DSCIM and GIVE do account for the most commonly cited benefits associated with CO<sub>2</sub> emissions and climate change – CO<sub>2</sub> crop fertilization and declines in cold related mortality. As such, while the GIVE- and DSCIM-based results provide state-of-the-science assessments of key climate change impacts, they remain partial estimates of future climate damages resulting from incremental changes in CO<sub>2</sub>, CH<sub>4</sub>, and N<sub>2</sub>O.<sup>205</sup>

Finally, given the still relatively narrow sectoral scope of the recently developed DSCIM and GIVE models, the damage module includes a third damage function that reflects a synthesis of the state of knowledge in other published climate damages literature. Studies that employ meta-analytic techniques<sup>206</sup> offer a tractable and straightforward way to combine the results of multiple studies into a single damage function that represents the body of evidence on climate damages that pre-date CIL and RFF's research initiatives. The first use of meta-analysis to combine multiple climate damage studies was done by (Tol 2009) and included 14 studies. The studies in (Tol 2009) served as the basis for the global damage function in DICE starting in version 2013R (W. Nordhaus 2014). The damage function in the most recent published version of DICE, DICE 2016, is from an updated meta-analysis based on a rereview of existing damage studies and included 26 studies published over 1994-2013. Howard and Sterner provide a more recent published peer-reviewed meta-analysis of existing damage studies (published through 2016) and account for additional features of the underlying studies (Howard and Sterner 2017). This study addresses differences in measurement across studies by adjusting estimates such that the data are relative to the same base period. They also eliminate double counting by removing duplicative estimates. Howard and Sterner's final sample is drawn from 20 studies that were published through 2015. (Howard and Sterner 2017) They present results under several specifications and show that the estimates are somewhat sensitive to defensible alternative modeling choices. As discussed in detail in U.S. EPA (EPA 2023f), the damage module underlying the SC-GHG estimates in this RIA includes the damage function specification (that excludes duplicate studies) from (Howard and Sterner 2017) that leads to the lowest SC-GHG estimates, all else equal.

The discounting module discounts the stream of future net climate damages to its present value in the year when the additional unit of emissions was released. Given the long-time horizon over which the damages are expected to occur, the discount rate has a large influence on the present value of future damages. Consistent with the findings of (National Academies 2017), the economic literature, OMB Circular A-4's guidance for regulatory analysis, and IWG recommendations to date (IWG 2010) (IWG 2013) (IWG 2016a) (IWG 2016b) (IWG 2021), the EPA continues to conclude that the consumption rate of interest is the theoretically appropriate

---

<sup>204</sup> The one exception is that the agricultural damage function in DSCIM and GIVE reflects the ways that trade can help mitigate damages arising from crop yield impacts.

<sup>205</sup> One advantage of the modular approach used by these models is that future research on new or alternative damage functions can be incorporated in a relatively straightforward way. DSCIM and GIVE developers have work underway on other impact categories that may be ready for consideration in future updates (e.g., morbidity and biodiversity loss).

<sup>206</sup> Meta-analysis is a statistical method of pooling data and/or results from a set of comparable studies of a problem. Pooling in this way provides a larger sample size for evaluation and allows for a stronger conclusion than can be provided by any single study. Meta-analysis yields a quantitative summary of the combined results and current state of the literature.

discount rate to discount the future benefits of reducing GHG emissions and that discount rate uncertainty should be accounted for in selecting future discount rates in this intergenerational context. OMB's Circular A-4 points out that "the analytically preferred method of handling temporal differences between benefits and costs is to adjust all the benefits and costs to reflect their value in equivalent units of consumption and to discount them at the rate consumers and savers would normally use in discounting future consumption benefits" (OMB 2003). The damage module described above calculates future net damages in terms of reduced consumption (or monetary consumption equivalents), and so an application of this guidance is to use the consumption discount rate to calculate the SC-GHG. Thus, EPA concludes that the use of the social rate of return on capital (7 percent under current OMB Circular A-4 guidance), which does not reflect the consumption rate, to discount damages estimated in terms of reduced consumption would inappropriately underestimate the impacts of climate change for the purposes of estimating the SC-GHG.<sup>207</sup>

For the SC-GHG estimates used in this RIA, EPA relies on a dynamic discounting approach that more fully captures the role of uncertainty in the discount rate in a manner consistent with the other modules. Based on a review of the literature and data on consumption discount rates, the public comments received on individual EPA rulemakings, the February 2021 TSD (IWG 2021), and the (National Academies 2017)<sup>208</sup> recommendations for updating the discounting module, the SC-GHG estimates rely on discount rates that reflect more recent data on the consumption interest rate and uncertainty in future rates. Specifically, rather than using a constant discount rate, the evolution of the discount rate over time is defined following the latest empirical evidence on interest rate uncertainty and using a framework originally developed by (Ramsey 1928) that connects economic growth and interest rates. The Ramsey approach explicitly reflects (1) preferences for utility in one period relative to utility in a later period and (2) the value of additional consumption as income changes. The dynamic discount rates used to develop the SC-GHG estimates applied in this RIA have been calibrated following the (Newell, Pizer and Prest 2022) approach, as applied in (Rennert, Errickson, et al. 2022) (Rennert, Prest, et al. 2022a). This approach uses the discounting formula (Ramsey 1928) in which the parameters are calibrated such that (1) the decline in the certainty-equivalent discount rate matches the latest empirical evidence on interest rate uncertainty estimated by (Bauer and Rudebusch 2020) (Bauer and Rudebusch 2023) and (2) the average of the certainty-equivalent discount rate over the first decade matches a near-term consumption rate of interest. Uncertainty in the starting rate is addressed by using three near-term target rates (1.5, 2.0, and 2.5 percent) based on multiple lines of evidence on observed market interest rates.

The resulting dynamic discount rate provides a notable improvement over the constant discount rate framework used for SC-GHG estimation in previous EPA RIAs. Specifically, it provides internal consistency within the modeling and a more complete accounting of uncertainty consistent with economic theory (Arrow, et al. 2013) (Cropper, et al. 2014) and the (National Academies 2017) recommendation to employ a more structural, Ramsey-like approach

---

<sup>207</sup> See also the discussion of the inappropriateness of discounting consumption-equivalent measures of benefits and costs using a rate of return on capital in Circular A-4 (2023) (OMB 2003).

<sup>208</sup> Similarly, OMB's Circular A-4 (2023) points out that "The analytically preferred method of handling temporal differences between benefits and costs is to adjust all the benefits and costs to reflect their value in equivalent units of consumption before discounting them" (OMB 2003).

to discounting that explicitly recognizes the relationship between economic growth and discounting uncertainty. This approach is also consistent with the (National Academies 2017) recommendation to use three sets of Ramsey parameters that reflect a range of near-term certainty-equivalent discount rates and are consistent with theory and empirical evidence on consumption rate uncertainty. Finally, the value of aversion to risk associated with net damages from GHG emissions is explicitly incorporated into the modeling framework following the economic literature. See U.S. EPA (EPA 2023f) for a more detailed discussion of the entire discounting module and methodology used to value risk aversion in the SC-GHG estimates.

Taken together, the methodologies adopted in this SC-GHG estimation process allow for a more holistic treatment of uncertainty than past estimates used by the EPA. The updates incorporate a quantitative consideration of uncertainty into all modules and use a Monte Carlo approach that captures the compounding uncertainties across modules. The estimation process generates nine separate distributions of discounted marginal damages per metric ton – the product of using three damage modules and three near-term target discount rates – for each gas in each emissions year. These distributions have long right tails reflecting the extensive evidence in the scientific and economic literature that shows the potential for lower-probability but higher-impact outcomes from climate change, which would be particularly harmful to society. The uncertainty grows over the modeled time horizon. Therefore, under cases with a lower near-term target discount rate – that give relatively more weight to impacts in the future – the distribution of results is wider. To produce a range of estimates that reflects the uncertainty in the estimation exercise while also providing a manageable number of estimates for policy analysis, the EPA combines the multiple lines of evidence on damage modules by averaging the results across the three damage module specifications. The full results generated from the updated methodology for methane and other greenhouse gases (SC-CO<sub>2</sub>, SC-CH<sub>4</sub>, and SC-N<sub>2</sub>O) for emissions years 2020 through 2080 are provided in U.S. EPA (EPA 2023f).

Table 6-1 summarizes the resulting averaged certainty-equivalent SC-GHG estimates under each near-term discount rate that are used to estimate the climate benefits of the GHG emission reductions expected from the final rule. These estimates are reported in 2022 dollars but are otherwise identical to those presented in U.S. EPA (EPA 2023f). The SC-GHGs increase over time within the models — i.e., the societal harm from one metric ton emitted in 2030 is higher than the harm caused by one metric ton emitted in 2027 — because future emissions produce larger incremental damages as physical and economic systems become more stressed in response to greater climatic change, and because GDP is growing over time and many damage categories are modeled as proportional to GDP.



**Table 6-1: Annual Rounded SC-CO<sub>2</sub>, SC-CH<sub>4</sub>, and SC-N<sub>2</sub>O Values, 2027-2055.**

| SC-GHG and Near-term Ramsey Discount Rate |  |      |      |  |      |      |   |        |        |
|---|--|------|------|--|------|------|---|--------|--------|
| Emission<br>Year                          | SC-CO <sub>2</sub><br>(2022 dollars per metric ton<br>of CO <sub>2</sub> ) |      |      | SC-CH <sub>4</sub><br>(2022 dollars per metric ton<br>of CH <sub>4</sub> ) |      |      | SC-N <sub>2</sub> O<br>(2022 dollars per metric ton of<br>N <sub>2</sub> O) |        |        |
|   | Near-term rate   |      |      | Near-term rate   |      |      | Near-term rate  |        |        |
|   | 2.5%   | 2.0% | 1.5% | 2.5%   | 2.0% | 1.5% | 2.5%  | 2.0%   | 1.5%   |
| 2027                                      | 150  | 250  | 410  | 1900   | 2400 | 3200 | 47000   | 70000  | 110000 |
| 2028                                      | 160  | 250  | 420  | 2000   | 2500 | 3300 | 48000   | 72000  | 110000 |
| 2029                                      | 160  | 250  | 430  | 2000   | 2600 | 3400 | 49000   | 73000  | 110000 |
| 2030                                      | 160  | 260  | 430  | 2100   | 2600 | 3500 | 50000   | 74000  | 120000 |
| 2031                                      | 160  | 260  | 440  | 2200   | 2700 | 3600 | 51000   | 76000  | 120000 |
| 2032                                      | 170  | 270  | 440  | 2300   | 2800 | 3700 | 52000   | 77000  | 120000 |
| 2033                                      | 170  | 270  | 450  | 2400   | 2900 | 3800 | 53000   | 79000  | 120000 |
| 2034                                      | 170  | 270  | 450  | 2500   | 3000 | 4000 | 54000   | 80000  | 120000 |
| 2035                                      | 180  | 280  | 460  | 2500   | 3100 | 4100 | 55000   | 81000  | 120000 |
| 2036                                      | 180  | 280  | 460  | 2600   | 3200 | 4200 | 57000   | 83000  | 130000 |
| 2037                                      | 180  | 290  | 470  | 2700   | 3300 | 4300 | 58000   | 84000  | 130000 |
| 2038                                      | 190  | 290  | 470  | 2800   | 3400 | 4400 | 59000   | 86000  | 130000 |
| 2039                                      | 190  | 290  | 480  | 2900   | 3500 | 4500 | 60000   | 87000  | 130000 |
| 2040                                      | 190  | 300  | 480  | 3000   | 3600 | 4600 | 61000   | 88000  | 130000 |
| 2041                                      | 200  | 300  | 490  | 3100   | 3700 | 4800 | 62000   | 90000  | 140000 |
| 2042                                      | 200  | 310  | 490  | 3200   | 3800 | 4900 | 63000   | 91000  | 140000 |
| 2043                                      | 200  | 310  | 500  | 3300   | 3900 | 5000 | 65000   | 93000  | 140000 |
| 2044                                      | 210  | 320  | 500  | 3400   | 4100 | 5100 | 66000   | 95000  | 140000 |
| 2045                                      | 210  | 320  | 510  | 3500   | 4200 | 5200 | 67000   | 96000  | 140000 |
| 2046                                      | 210  | 330  | 520  | 3500   | 4300 | 5400 | 69000   | 98000  | 150000 |
| 2047                                      | 220  | 330  | 520  | 3600   | 4400 | 5500 | 70000   | 99000  | 150000 |
| 2048                                      | 220  | 340  | 530  | 3700   | 4500 | 5600 | 70000   | 100000 | 150000 |
| 2049                                      | 230  | 340  | 530  | 3800   | 4600 | 5700 | 72000   | 100000 | 150000 |
| 2050                                      | 230  | 340  | 540  | 3900   | 4700 | 5800 | 73000   | 100000 | 150000 |
| 2051                                      | 230  | 350  | 550  | 4000   | 4800 | 6000 | 75000   | 100000 | 150000 |
| 2052                                      | 240  | 350  | 550  | 4100   | 4900 | 6100 | 76000   | 110000 | 160000 |
| 2053                                      | 240  | 360  | 560  | 4200   | 5000 | 6200 | 77000   | 110000 | 160000 |
| 2054                                      | 240  | 360  | 560  | 4300   | 5100 | 6300 | 78000   | 110000 | 160000 |
| 2055                                      | 250  | 360  | 570  | 4400   | 5200 | 6400 | 79000   | 110000 | 160000 |

Source: (EPA 2023f)

Note: These SC-CH<sub>4</sub> values are identical to those reported in the technical report U.S. EPA (2023f) adjusted for inflation to 2022 dollars using the annual GDP Implicit Price Deflator values in the U.S. Bureau of Economic Analysis' (BEA) NIPA Table 1.1.9 (Bureau of Economic Analysis (BEA) 2021). The values are stated in \$/metric ton GHG and vary depending on the year of GHG emissions. This table displays the values rounded to two significant figures. The annual unrounded values used in the calculations in this RIA are available in Appendix A.5 of U.S. EPA (EPA 2023f) and at: [www.epa.gov/environmental-economics/scghg](http://www.epa.gov/environmental-economics/scghg).

The methodological updates described above represent a major step forward in bringing SC-GHG estimation closer to the frontier of climate science and economics and address many of the (National Academies 2017) near-term recommendations. Nevertheless, the resulting SC-GHG estimates presented in Table 9-1, still have several limitations, as would be expected for any modeling exercise that covers such a broad scope of scientific and economic issues across a complex global landscape. There are still many categories of climate impacts and associated damages that are only partially or not reflected yet in these estimates and sources of uncertainty that have not been fully characterized due to data and modeling limitations. For example, the

modeling omits most of the consequences of changes in precipitation, damages from extreme weather events, the potential for nongradual damages from passing critical thresholds (e.g., tipping elements) in natural or socioeconomic systems, and non-climate mediated effects of GHG emissions. More specifically for methane, the SC-CH<sub>4</sub> estimates do not account for the direct health and welfare impacts associated with tropospheric ozone produced by methane. As discussed further in U.S. EPA (EPA 2023f), recent studies have found the global ozone-related respiratory mortality benefits of CH<sub>4</sub> emissions reductions, which are not included in the SC-CH<sub>4</sub> values presented in Table 7-1, to be, in 2022 dollars, approximately \$2,700 per metric ton of methane emissions in 2030. (McDuffie, et al. 2023). In addition, the SC-CH<sub>4</sub> estimates do not reflect that methane emissions lead to a reduction in atmospheric oxidants, like hydroxyl radicals, nor do they account for impacts associated with CO<sub>2</sub> produced from methane oxidizing in the atmosphere. Importantly, the updated SC-GHG methodology does not yet reflect interactions and feedback effects within, and across, Earth and human systems. For example, it does not explicitly reflect potential interactions among damage categories, such as those stemming from the interdependencies of energy, water, and land use. These, and other, interactions and feedbacks were highlighted by the National Academies as an important area of future research for longer-term enhancements in the SC-GHG estimation framework.

### **6.3 Health Effects Associated with Exposure to Criteria and Air Toxics Pollutants**

Emissions sources impacted by this rule, including vehicles and power plants, emit pollutants that contribute to ambient concentrations of ozone, PM, NO<sub>2</sub>, SO<sub>2</sub>, CO, and air toxics. This chapter of the RIA discusses the health effects associated with exposure to these pollutants.

Additionally, because children have increased vulnerability and susceptibility for adverse health effects related to air pollution exposures, EPA’s findings regarding adverse effects for children related to exposure to pollutants that are impacted by this rule are noted in this section. The increased vulnerability and susceptibility of children to air pollution exposures may arise because infants and children generally breathe more relative to their size than adults do, and consequently may be exposed to relatively higher amounts of air pollution. (U.S. EPA 2009) Children also tend to breathe through their mouths more than adults, and their nasal passages are less effective at removing pollutants, which leads to greater lung deposition of some pollutants, such as PM. (U.S. EPA 2019) (Foos, et al. 2008) Furthermore, air pollutants may pose health risks specific to children because children’s bodies are still developing (U.S. EPA 2021).<sup>209</sup> For example, during periods of rapid growth such as fetal development, infancy, and puberty, their developing systems and organs may be more easily harmed. (U.S. EPA 2006, U.S. EPA 2005) EPA produces the report titled “America’s Children and the Environment,” which presents national trends on air pollution and other contaminants and environmental health of children. (U.S. EPA 2022)

---

<sup>209</sup> Children’s environmental health includes conception, infancy, early childhood and through adolescence until 21 years of age as described in an EPA Memorandum (US EPA 2021).

### **6.3.1 Particulate Matter**

#### **6.3.1.1 Background on Particulate Matter**

Particulate matter (PM) is a complex mixture of solid particles and liquid droplets distributed among numerous atmospheric gases which interact with solid and liquid phases. Particles in the atmosphere range in size from less than 0.01 to more than 10 micrometers ( $\mu\text{m}$ ) in diameter. (U.S. EPA 2020) Atmospheric particles can be grouped into several classes according to their aerodynamic diameter and physical sizes. Generally, the three broad classes of particles include ultrafine particles (UFPs, generally considered as particles with a diameter less than or equal to 0.1  $\mu\text{m}$  [typically based on physical size, thermal diffusivity, or electrical mobility]), “fine” particles ( $\text{PM}_{2.5}$ ; particles with a nominal mean aerodynamic diameter less than or equal to 2.5  $\mu\text{m}$ ), and “thoracic” particles ( $\text{PM}_{10}$ ; particles with a nominal mean aerodynamic diameter less than or equal to 10  $\mu\text{m}$ ). Particles that fall within the size range between  $\text{PM}_{2.5}$  and  $\text{PM}_{10}$ , are referred to as “thoracic coarse particles” ( $\text{PM}_{10-2.5}$ , particles with a nominal mean aerodynamic diameter greater than 2.5  $\mu\text{m}$  and less than or equal to 10  $\mu\text{m}$ ). EPA currently has NAAQS for  $\text{PM}_{2.5}$  and  $\text{PM}_{10}$  (40 CFR Part 50 2023, 40 CFR Part 53 2023, 40 CFR Part 58 2023).<sup>210</sup>

Most particles are found in the lower troposphere, where they can have residence times ranging from a few hours to weeks. Particles are removed from the atmosphere by wet deposition, such as when they are carried by rain or snow, or by dry deposition, when particles settle out of suspension due to gravity. Atmospheric lifetimes are generally longest for  $\text{PM}_{2.5}$ , which often remains in the atmosphere for days to weeks before being removed by wet or dry deposition. (U.S. EPA 2019) In contrast, atmospheric lifetimes for UFP and  $\text{PM}_{10-2.5}$  are shorter. Within hours, UFP can undergo coagulation and condensation that lead to formation of larger particles in the accumulation mode, or can be removed from the atmosphere by evaporation, deposition, or reactions with other atmospheric components.  $\text{PM}_{10-2.5}$  are also generally removed from the atmosphere within hours, through wet or dry deposition. (U.S. EPA 2019)

Particulate matter consists of both primary and secondary particles. Primary particles are emitted directly from sources, such as combustion-related activities (e.g., industrial activities, motor vehicle operation, biomass burning), while secondary particles are formed through atmospheric chemical reactions of gaseous precursors (e.g., sulfur oxides ( $\text{SO}_x$ ), nitrogen oxides ( $\text{NO}_x$ ), and volatile organic compounds (VOCs)). From 2000 to 2021, national annual average ambient  $\text{PM}_{2.5}$  concentrations have declined by over 35 percent,<sup>211</sup> largely reflecting reductions in emissions of precursor gases.

#### **6.3.1.2 Health Effects Associated with Exposure to Particulate Matter**

Scientific evidence spanning animal toxicological, controlled human exposure, and epidemiologic studies shows that exposure to ambient PM is associated with a broad range of health effects. These health effects are discussed in detail in the Integrated Science Assessment

---

<sup>210</sup> Regulatory definitions of PM size fractions, and information on reference and equivalent methods for measuring PM in ambient air, are provided in 40 CFR parts 50, 53, and 58. With regard to national ambient air quality standards (NAAQS) which provide protection against health and welfare effects, the 24-hour  $\text{PM}_{10}$  standard provides protection against effects associated with short-term exposure to thoracic coarse particles (i.e.,  $\text{PM}_{10-2.5}$ ).

<sup>211</sup> See <https://www.epa.gov/air-trends/particulate-matter-pm25-trends> for more information.

for Particulate Matter, which was finalized in December 2019 (2019 PM ISA) with a more targeted evaluation of studies published since the literature cutoff date of the 2019 PM ISA in the Supplement to the Integrated Science Assessment for PM (Supplement). (U.S. EPA 2019) (U.S. EPA 2022) The PM ISA characterizes the causal nature of relationships between PM exposure and broad health categories (e.g., cardiovascular effects, respiratory effects, etc.) using a weight-of-evidence approach. (U.S. EPA 2019) Within this characterization, the PM ISA summarizes the health effects evidence for short-term (i.e., hours up to one month) and long-term (i.e., one month to years) exposures to PM<sub>2.5</sub>, PM<sub>10-2.5</sub>, and ultrafine particles, and concludes that exposures to ambient PM<sub>2.5</sub> are associated with a number of adverse health effects. The following discussion highlights the PM ISA's conclusions and summarizes additional information from the Supplement where appropriate, pertaining to the health effects evidence for both short- and long-term PM exposures. Further discussion of PM-related health effects can also be found in the 2022 Policy Assessment for the review of the PM NAAQS. (U.S. EPA 2022)

EPA has concluded that recent evidence in combination with evidence evaluated in the 2009 PM ISA supports a “causal relationship” between both long- and short-term exposures to PM<sub>2.5</sub> and premature mortality and cardiovascular effects and a “likely to be causal relationship” between long- and short-term PM<sub>2.5</sub> exposures and respiratory effects. (U.S. EPA 2009) Additionally, recent experimental and epidemiologic studies provide evidence supporting a “likely to be causal relationship” between long-term PM<sub>2.5</sub> exposure and nervous system effects, and long-term PM<sub>2.5</sub> exposure and cancer. Because of remaining uncertainties and limitations in the evidence base, EPA determined the evidence is “suggestive of, but not sufficient to infer, a causal relationship” for long-term PM<sub>2.5</sub> exposure and reproductive and developmental effects (i.e., male/female reproduction and fertility; pregnancy and birth outcomes), long- and short-term exposures and metabolic effects, and short-term exposure and nervous system effects.

As discussed extensively in the 2019 PM ISA and the Supplement, recent studies continue to support a “causal relationship” between short- and long-term PM<sub>2.5</sub> exposures and mortality. (U.S. EPA 2019) (U.S. EPA 2022) For short-term PM<sub>2.5</sub> exposure, multi-city studies, in combination with single- and multi-city studies evaluated in the 2009 PM ISA, provide evidence of consistent, positive associations across studies conducted in different geographic locations, populations with different demographic characteristics, and studies using different exposure assignment techniques. Additionally, the consistent and coherent evidence across scientific disciplines for cardiovascular morbidity, including exacerbations of chronic obstructive pulmonary disease (COPD) and asthma, provide biological plausibility for cause-specific mortality and total mortality. Recent epidemiologic studies evaluated in the Supplement, including studies that employed alternative methods for confounder control, provide additional support to the evidence base that contributed to the 2019 PM ISA conclusion for short-term PM<sub>2.5</sub> exposure and mortality (U.S. EPA 2022).

The 2019 PM ISA concluded a “causal relationship” between long-term PM<sub>2.5</sub> exposure and mortality. In addition to re-analyses and extensions of the American Cancer Society (ACS) and Harvard Six Cities (HSC) cohorts, multiple new cohort studies conducted in the U.S. and Canada, consisting of people employed in a specific job (e.g., teacher, nurse) and that apply different exposure assignment techniques, provide evidence of positive associations between long-term PM<sub>2.5</sub> exposure and mortality. Biological plausibility for mortality due to long-term PM<sub>2.5</sub> exposure is provided by the coherence of effects across scientific disciplines for cardiovascular morbidity, particularly for coronary heart disease, stroke, and atherosclerosis, and

for respiratory morbidity, particularly for the development of COPD. Additionally, recent studies provide evidence indicating that as long-term PM<sub>2.5</sub> concentrations decrease there is an increase in life expectancy. Recent cohort studies evaluated in the Supplement, as well as epidemiologic studies that conducted accountability analyses or employed alternative methods for confounder controls, support and extend the evidence base that contributed to the 2019 PM ISA conclusion for long-term PM<sub>2.5</sub> exposure and mortality.

A large body of studies examining both short- and long-term PM<sub>2.5</sub> exposure and cardiovascular effects supports and extends the evidence base evaluated in the 2009 PM ISA. The strongest evidence for cardiovascular effects in response to short-term PM<sub>2.5</sub> exposures is for ischemic heart disease and heart failure. The evidence for short-term PM<sub>2.5</sub> exposure and cardiovascular effects is coherent across scientific disciplines and supports a continuum of effects ranging from subtle changes in indicators of cardiovascular health to serious clinical events, such as increased emergency department visits and hospital admissions due to cardiovascular disease and cardiovascular mortality. For long-term PM<sub>2.5</sub> exposure, there is strong and consistent epidemiologic evidence of a relationship with cardiovascular mortality. This evidence is supported by epidemiologic and animal toxicological studies demonstrating a range of cardiovascular effects including coronary heart disease, stroke, impaired heart function, and subclinical markers (e.g., coronary artery calcification, atherosclerotic plaque progression), which collectively provide coherence and biological plausibility. Recent epidemiologic studies evaluated in the Supplement, as well as studies that conducted accountability analyses or employed alternative methods for confounder control, support and extend the evidence base that contributed to the 2019 PM ISA conclusion for both short- and long-term PM<sub>2.5</sub> exposure and cardiovascular effects.

Studies evaluated in the 2019 PM ISA continue to provide evidence of a “likely to be causal relationship” between both short- and long-term PM<sub>2.5</sub> exposure and respiratory effects. Epidemiologic studies provide consistent evidence of a relationship between short-term PM<sub>2.5</sub> exposure and asthma exacerbation in children and COPD exacerbation in adults, as indicated by increases in emergency department visits and hospital admissions, which is supported by animal toxicological studies indicating worsening allergic airways disease and subclinical effects related to COPD. Epidemiologic studies also provide evidence of a relationship between short-term PM<sub>2.5</sub> exposure and respiratory mortality. However, there is inconsistent evidence of respiratory effects, specifically lung function declines and pulmonary inflammation, in controlled human exposure studies. With respect to long-term PM<sub>2.5</sub> exposure, epidemiologic studies conducted in the U.S. and abroad provide evidence of a relationship with respiratory effects, including consistent changes in lung function and lung function growth rate, increased asthma incidence, asthma prevalence, and wheeze in children; acceleration of lung function decline in adults; and respiratory mortality. The epidemiologic evidence is supported by animal toxicological studies, which provide coherence and biological plausibility for a range of effects including impaired lung development, decrements in lung function growth, and asthma development.

Since the 2009 PM ISA, a growing body of scientific evidence examined the relationship between long-term PM<sub>2.5</sub> exposure and nervous system effects, resulting for the first time in a causality determination for this health effects category of a “likely to be causal relationship.” The strongest evidence for effects on the nervous system come from epidemiologic studies that consistently report cognitive decrements and reductions in brain volume in adults. The effects observed in epidemiologic studies in adults are supported by animal toxicological studies

demonstrating effects on the brain of adult animals including inflammation, morphologic changes, and neurodegeneration of specific regions of the brain. There is more limited evidence for neurodevelopmental effects in children with some studies reporting positive associations with autism spectrum disorder and others providing limited evidence of an association with cognitive function. While there is some evidence from animal toxicological studies indicating effects on the brain (i.e., inflammatory and morphological changes) to support a biologically plausible pathway for neurodevelopmental effects, epidemiologic studies are limited due to their lack of control for potential confounding by copollutants, the small number of studies conducted, and uncertainty regarding critical exposure windows.

Building off the decades of research demonstrating mutagenicity, DNA damage, and other endpoints related to genotoxicity due to whole PM exposures, recent experimental and epidemiologic studies focusing specifically on PM<sub>2.5</sub> provide evidence of a relationship between long-term PM<sub>2.5</sub> exposure and cancer. Epidemiologic studies examining long-term PM<sub>2.5</sub> exposure and lung cancer incidence and mortality provide evidence of generally positive associations in cohort studies spanning different populations, locations, and exposure assignment techniques. Additionally, there is evidence of positive associations with lung cancer incidence and mortality in analyses limited to never smokers. The epidemiologic evidence is supported by both experimental and epidemiologic evidence of genotoxicity, epigenetic effects, carcinogenic potential, and that PM<sub>2.5</sub> exhibits several characteristics of carcinogens, which collectively provide biological plausibility for cancer development and resulted in the conclusion of a “likely to be causal relationship.”

For the additional health effects categories evaluated for PM<sub>2.5</sub> in the 2019 PM ISA, experimental and epidemiologic studies provide limited and/or inconsistent evidence of a relationship with PM<sub>2.5</sub> exposure. As a result, the 2019 PM ISA concluded that the evidence is “suggestive of, but not sufficient to infer a causal relationship” for short-term PM<sub>2.5</sub> exposure and metabolic effects and nervous system effects, and for long-term PM<sub>2.5</sub> exposures and metabolic effects as well as reproductive and developmental effects.

In addition to evaluating the health effects attributed to short- and long-term exposure to PM<sub>2.5</sub>, the 2019 PM ISA also conducted an extensive evaluation as to whether specific components or sources of PM<sub>2.5</sub> are more strongly related with health effects than PM<sub>2.5</sub> mass. An evaluation of those studies resulted in the 2019 PM ISA concluding that “many PM<sub>2.5</sub> components and sources are associated with many health effects, and the evidence does not indicate that any one source or component is consistently more strongly related to health effects than PM<sub>2.5</sub> mass.” (U.S. EPA 2019)

For both PM<sub>10-2.5</sub> and ultrafine particles (UFPs), for all health effects categories evaluated, the 2019 PM ISA concluded that the evidence was “suggestive of, but not sufficient to infer, a causal relationship” or “inadequate to determine the presence or absence of a causal relationship.” For PM<sub>10-2.5</sub>, although a Federal Reference Method (FRM) was instituted in 2011 to measure PM<sub>10-2.5</sub> concentrations nationally, the causality determinations reflect that the same uncertainty identified in the 2009 PM ISA with respect to the method used to estimate PM<sub>10-2.5</sub> concentrations in epidemiologic studies persists. Specifically, across epidemiologic studies, different approaches are used to estimate PM<sub>10-2.5</sub> concentrations (e.g., direct measurement of PM<sub>10-2.5</sub>, difference between PM<sub>10</sub> and PM<sub>2.5</sub> concentrations), and it remains unclear how well correlated PM<sub>10-2.5</sub> concentrations are both spatially and temporally across the different methods used.

For UFPs, which have often been defined as particles less than 0.1  $\mu\text{m}$  in diameter, the uncertainty in the evidence for the health effect categories evaluated across experimental and epidemiologic studies reflects the inconsistency in the exposure metric used (i.e., particle number concentration, surface area concentration, mass concentration) as well as the size fractions examined. In epidemiologic studies the size fraction examined can vary depending on the monitor used and exposure metric, with some studies examining number count over the entire particle size range, while experimental studies that use a particle concentrator often examine particles up to 0.3  $\mu\text{m}$ . Additionally, due to the lack of a monitoring network, there is limited information on the spatial and temporal variability of UFPs within the United States as well as population exposures to UFPs, which adds uncertainty to epidemiologic study results.

The 2019 PM ISA cites extensive evidence indicating that “both the general population as well as specific populations and life stages are at risk for  $\text{PM}_{2.5}$ -related health effects.” (U.S. EPA 2019) For example, in support of its “causal” and “likely to be causal” determinations, the ISA cites substantial evidence for (1) PM-related mortality and cardiovascular effects in older adults; (2) PM-related cardiovascular effects in people with pre-existing cardiovascular disease; (3) PM-related respiratory effects in people with pre-existing respiratory disease, particularly asthma exacerbations in children; and (4) PM-related impairments in lung function growth and asthma development in children. The ISA additionally notes that stratified analyses (i.e., analyses that directly compare PM-related health effects across groups) provide strong evidence for racial and ethnic differences in  $\text{PM}_{2.5}$  exposures and in the risk of  $\text{PM}_{2.5}$ -related health effects, specifically within Hispanic and non-Hispanic Black populations with some evidence of increased risk for populations of low socioeconomic status. Recent studies evaluated in the Supplement support the conclusion of the 2019 PM ISA with respect to disparities in both  $\text{PM}_{2.5}$  exposure and health risk by race and ethnicity and provide additional support for disparities for populations of lower socioeconomic status. (U.S. EPA 2022) Additionally, evidence spanning epidemiologic studies that conducted stratified analyses, experimental studies focusing on animal models of disease or individuals with pre-existing disease, dosimetry studies, as well as studies focusing on differential exposure suggest that populations with pre-existing cardiovascular or respiratory disease, populations that are overweight or obese, populations that have particular genetic variants, and current/former smokers could be at increased risk for adverse  $\text{PM}_{2.5}$ -related health effects. The 2022 Policy Assessment for the review of the PM NAAQS also highlights that factors that may contribute to increased risk of  $\text{PM}_{2.5}$ -related health effects include life stage (children and older adults), pre-existing diseases (cardiovascular disease and respiratory disease), race/ethnicity, and socioeconomic status. (U.S. EPA 2022)

## **6.3.2 Ozone**

### **6.3.2.1 Background on Ozone**

Ground-level ozone pollution forms in areas with high concentrations of ambient nitrogen oxides ( $\text{NO}_x$ ) and volatile organic compounds (VOCs) when solar radiation is strong. Major U.S. sources of  $\text{NO}_x$  are highway and nonroad motor vehicles, engines, power plants, and other industrial sources; natural sources, such as soil, vegetation, and lightning, serve as smaller sources. Vegetation is the dominant source of VOCs in the U.S. Volatile consumer and commercial products, such as propellants and solvents, highway and nonroad vehicles, engines, fires, and industrial sources also contribute to the atmospheric burden of VOCs at ground-level. EPA currently has NAAQS for ozone (40 CFR Part 50 2023, 40 CFR Part 58 2023).

The processes underlying ozone formation, transport, and accumulation are complex. Ground-level ozone is produced and destroyed by an interwoven network of free radical reactions involving the hydroxyl radical (OH), NO, NO<sub>2</sub>, and complex reaction intermediates derived from VOCs. Many of these reactions are sensitive to temperature and available sunlight. High ozone events most often occur when ambient temperatures and sunlight intensities remain high for several days under stagnant conditions. Ozone and its precursors can also be transported hundreds of miles downwind, which can lead to elevated ozone levels in areas with otherwise low VOC or NO<sub>x</sub> emissions. As an air mass moves and is exposed to changing ambient concentrations of NO<sub>x</sub> and VOCs, the ozone photochemical regime (relative sensitivity of ozone formation to NO<sub>x</sub> and VOC emissions) can change.

When ambient VOC concentrations are high, comparatively small amounts of NO<sub>x</sub> catalyze rapid ozone formation. Without available NO<sub>x</sub>, ground-level ozone production is severely limited, and VOC reductions would have little impact on ozone concentrations. Photochemistry under these conditions is said to be “NO<sub>x</sub>-limited.” When NO<sub>x</sub> levels are sufficiently high, faster NO<sub>2</sub> oxidation consumes more radicals, dampening ozone production. Under these “VOC-limited” conditions (also referred to as “NO<sub>x</sub>-saturated” conditions), VOC reductions are effective in reducing ozone, and NO<sub>x</sub> can react directly with ozone, resulting in suppressed ozone concentrations near NO<sub>x</sub> emission sources. Under these NO<sub>x</sub>-saturated conditions, NO<sub>x</sub> reductions can actually increase local ozone under certain circumstances, but overall ozone production (considering downwind formation) decreases, and even in VOC-limited areas, NO<sub>x</sub> reductions are not expected to increase ozone levels if the NO<sub>x</sub> reductions are sufficiently large enough to become NO<sub>x</sub>-limited.

### **6.3.2.2 Health Effects Associated with Exposure to Ozone**

This section provides a summary of the health effects associated with exposure to ambient concentrations of ozone.<sup>212</sup> The information in this section is based on the information and conclusions in the April 2020 Integrated Science Assessment for Ozone (Ozone ISA). (U.S. EPA 2020) The Ozone ISA concludes that human exposures to ambient concentrations of ozone are associated with a number of adverse health effects and characterizes the weight of evidence for these health effects.<sup>213</sup> The following discussion highlights the Ozone ISA’s conclusions pertaining to health effects associated with both short-term and long-term periods of exposure to ozone.

For short-term exposure to ozone, the Ozone ISA concludes that respiratory effects, including lung function decrements, pulmonary inflammation, exacerbation of asthma, respiratory-related hospital admissions, and mortality, are causally associated with ozone exposure. It also concludes that metabolic effects, including metabolic syndrome (i.e., changes in insulin or

---

<sup>212</sup> Human exposure to ozone varies over time due to changes in ambient ozone concentration and because people move between locations which have notably different ozone concentrations. Also, the amount of ozone delivered to the lung is influenced not only by the ambient concentrations but also by the breathing route and rate.

<sup>213</sup> The ISA evaluates evidence and draws conclusions on the causal relationship between relevant pollutant exposures and health effects, assigning one of five “weight of evidence” determinations: causal relationship, likely to be a causal relationship, suggestive of a causal relationship, inadequate to infer a causal relationship, and not likely to be a causal relationship. For more information on these levels of evidence, please refer to Table II in the Preamble of the ISA.



glucose levels, cholesterol levels, obesity, and blood pressure) and complications due to diabetes are likely to be causally associated with short-term exposure to ozone and that evidence is suggestive of a causal relationship between cardiovascular effects, central nervous system effects, and total mortality and short-term exposure to ozone.

For long-term exposure to ozone, the Ozone ISA concludes that respiratory effects, including new onset asthma, pulmonary inflammation, and injury, are likely to be causally related with ozone exposure. The Ozone ISA characterizes the evidence as suggestive of a causal relationship for associations between long-term ozone exposure and cardiovascular effects, metabolic effects, reproductive and developmental effects, central nervous system effects, and total mortality. The evidence is inadequate to infer a causal relationship between chronic ozone exposure and increased risk of cancer.

Finally, interindividual variation in human responses to ozone exposure can result in some groups being at increased risk for detrimental effects in response to exposure. In addition, some groups are at increased risk of exposure due to their activities, such as outdoor workers and children. The Ozone ISA identified several groups that are at increased risk for ozone-related health effects. These groups are people with asthma, children and older adults, individuals with reduced intake of certain nutrients (i.e., Vitamins C and E), outdoor workers, and individuals having certain genetic variants related to oxidative metabolism or inflammation. Ozone exposure during childhood can have lasting effects through adulthood. Such effects include altered function of the respiratory and immune systems. Children absorb higher doses (normalized to lung surface area) of ambient ozone, compared to adults, due to their increased time spent outdoors, higher ventilation rates relative to body size, and a tendency to breathe a greater fraction of air through the mouth. Children also have a higher asthma prevalence compared to adults. Recent epidemiologic studies provide generally consistent evidence that long-term ozone exposure is associated with the development of asthma in children. Studies comparing age groups reported higher magnitude associations for short-term ozone exposure and respiratory hospital admissions and emergency room visits among children than among adults. Panel studies also provide support for experimental studies with consistent associations between short-term ozone exposure and lung function and pulmonary inflammation in healthy children. Additional children's vulnerability and susceptibility factors are listed in Section IX.G of the preamble.

### **6.3.3 Nitrogen Oxides**

#### **6.3.3.1 Background on Nitrogen Oxides**

Oxides of nitrogen (NO<sub>x</sub>) refers to nitric oxide (NO) and nitrogen dioxide (NO<sub>2</sub>). Most NO<sub>2</sub> is formed in the air through the oxidation of nitric oxide (NO) emitted when fuel is burned at a high temperature. NO<sub>x</sub> is a criteria pollutant, regulated for its adverse effects on public health and the environment, and highway vehicles are an important contributor to NO<sub>x</sub> emissions. NO<sub>x</sub>, along with VOCs, are the two major precursors of ozone, and NO<sub>x</sub> is also a major contributor to secondary PM<sub>2.5</sub> formation.

#### **6.3.3.2 Health Effects Associated with Exposure to Nitrogen Oxides**

The most recent review of the health effects of oxides of nitrogen completed by EPA can be found in the 2016 Integrated Science Assessment for Oxides of Nitrogen - Health Criteria (Oxides of Nitrogen ISA). (U.S. EPA 2016) The largest source of NO<sub>2</sub> is motor vehicle

emissions, and ambient NO<sub>2</sub> concentrations tend to be highly correlated with other traffic-related pollutants. Thus, a key issue in characterizing the causality of NO<sub>2</sub>-health effect relationships was evaluating the extent to which studies supported an effect of NO<sub>2</sub> that is independent of other traffic-related pollutants. EPA concluded that the findings for asthma exacerbation integrated from epidemiologic and controlled human exposure studies provided evidence that is sufficient to infer a causal relationship between respiratory effects and short-term NO<sub>2</sub> exposure. The strongest evidence supporting an independent effect of NO<sub>2</sub> exposure comes from controlled human exposure studies demonstrating increased airway responsiveness in individuals with asthma following ambient-relevant NO<sub>2</sub> exposures. The coherence of this evidence with epidemiologic findings for asthma hospital admissions and ED visits as well as lung function decrements and increased pulmonary inflammation in children with asthma describe a plausible pathway by which NO<sub>2</sub> exposure can cause an asthma exacerbation. The 2016 ISA for Oxides of Nitrogen also concluded that there is likely to be a causal relationship between long-term NO<sub>2</sub> exposure and respiratory effects. This conclusion is based on new epidemiologic evidence for associations of NO<sub>2</sub> with asthma development in children combined with biological plausibility from experimental studies.

In evaluating a broader range of health effects, the 2016 ISA for Oxides of Nitrogen concluded that evidence is “suggestive of, but not sufficient to infer, a causal relationship” between short-term NO<sub>2</sub> exposure and cardiovascular effects and mortality and between long-term NO<sub>2</sub> exposure and cardiovascular effects and diabetes, birth outcomes, and cancer. In addition, the scientific evidence is inadequate (insufficient consistency of epidemiologic and toxicological evidence) to infer a causal relationship for long-term NO<sub>2</sub> exposure with fertility, reproduction, and pregnancy, as well as with postnatal development. A key uncertainty in understanding the relationship between these non-respiratory health effects and short- or long-term exposure to NO<sub>2</sub> is co-pollutant confounding, particularly by other roadway pollutants. The available evidence for non-respiratory health effects does not adequately address whether NO<sub>2</sub> has an independent effect or whether it primarily represents effects related to other or a mixture of traffic-related pollutants.

The 2016 ISA for Oxides of Nitrogen concluded that people with asthma, children, and older adults are at increased risk for NO<sub>2</sub>-related health effects. In these groups and lifestyles, NO<sub>2</sub> is consistently related to larger effects on outcomes related to asthma exacerbation, for which there is confidence in the relationship with NO<sub>2</sub> exposure.

### **6.3.4 Sulfur Oxides**

#### **6.3.4.1 Background on Sulfur Oxides**

Sulfur dioxide (SO<sub>2</sub>), a member of the sulfur oxide (SO<sub>x</sub>) family of gases, is formed from burning fuels containing sulfur (e.g., coal or oil), extracting gasoline from oil, or extracting metals from ore. SO<sub>2</sub> and its gas phase oxidation products can dissolve in water droplets and further oxidize to form sulfuric acid which reacts with ammonia to form sulfates, which are important components of ambient PM.

#### **6.3.4.2 Health Effects Associated with Exposure to Sulfur Oxides**

This section provides an overview of the health effects associated with SO<sub>2</sub>. Additional information on the health effects of SO<sub>2</sub> can be found in the 2017 Integrated Science Assessment

for Sulfur Oxides – Health Criteria (SO<sub>x</sub> ISA). (U.S. EPA 2017) Following an extensive evaluation of health evidence from animal toxicological, controlled human exposure, and epidemiologic studies, EPA has concluded that there is a causal relationship between respiratory health effects and short-term exposure to SO<sub>2</sub>. The immediate effect of SO<sub>2</sub> on the respiratory system in humans is bronchoconstriction. People with asthma are more sensitive to the effects of SO<sub>2</sub>, likely resulting from preexisting inflammation associated with this disease. In addition to those with asthma (both children and adults), there is suggestive evidence that all children and older adults may be at increased risk of SO<sub>2</sub>-related health effects. In free-breathing laboratory studies involving controlled human exposures to SO<sub>2</sub>, respiratory effects have consistently been observed following 5-10 min exposures at SO<sub>2</sub> concentrations  $\geq$  400 ppb in people with asthma engaged in moderate to heavy levels of exercise, with respiratory effects occurring at concentrations as low as 200 ppb in some individuals with asthma. A clear concentration-response relationship has been demonstrated in these studies following exposures to SO<sub>2</sub> at concentrations between 200 and 1000 ppb, both in terms of increasing severity of respiratory symptoms and decrements in lung function, as well as the percentage of individuals with asthma adversely affected. Epidemiologic studies have reported positive associations between short-term ambient SO<sub>2</sub> concentrations and hospital admissions and emergency department visits for asthma and for all respiratory causes, particularly among children and older adults ( $\geq$  65 years). The studies provide supportive evidence for the causal relationship.

For long-term SO<sub>2</sub> exposure and respiratory effects, EPA has concluded that the evidence is suggestive of a causal relationship. This conclusion is based on new epidemiologic evidence for positive associations between long-term SO<sub>2</sub> exposure and increases in asthma incidence among children, together with animal toxicological evidence that provides a pathophysiologic basis for the development of asthma. However, uncertainty remains regarding the influence of other pollutants on the observed associations with SO<sub>2</sub> because these epidemiologic studies have not examined the potential for co-pollutant confounding.

Consistent associations between short-term exposure to SO<sub>2</sub> and mortality have been observed in epidemiologic studies, with larger effect estimates reported for respiratory mortality than for cardiovascular mortality. While this finding is consistent with the demonstrated effects of SO<sub>2</sub> on respiratory morbidity, uncertainty remains with respect to the interpretation of these observed mortality associations due to potential confounding by various copollutants. Therefore, EPA has concluded that the overall evidence is suggestive of a causal relationship between short-term exposure to SO<sub>2</sub> and mortality.

### **6.3.5 Carbon Monoxide**

#### **6.3.5.1 Background on Carbon Monoxide**

Carbon Monoxide (CO) is a colorless, odorless gas formed by incomplete combustion of carbon-containing fuels and by photochemical reactions in the atmosphere. Nationally, particularly in urban areas, the majority of CO emissions to ambient air come from mobile sources. (U.S. EPA 2010)

#### **6.3.5.2 Health Effects Associated with Exposure to Carbon Monoxide**

Information on the health effects of carbon monoxide (CO) can be found in the January 2010 Integrated Science Assessment for Carbon Monoxide (CO ISA). (U.S. EPA 2010) The CO ISA

presents conclusions regarding the presence of causal relationships between CO exposure and categories of adverse health effects.<sup>214</sup> This section provides a summary of the health effects associated with exposure to ambient concentrations of CO, along with the CO ISA conclusions.<sup>215</sup>

Controlled human exposure studies of subjects with coronary artery disease show a decrease in the time to onset of exercise-induced angina (chest pain) and electrocardiogram changes following CO exposure. In addition, epidemiologic studies presented in the CO ISA observed associations between short-term CO exposure and cardiovascular morbidity, particularly increased emergency room visits and hospital admissions for coronary heart disease (including ischemic heart disease, myocardial infarction, and angina). Some epidemiologic evidence is also available for increased hospital admissions and emergency room visits for congestive heart failure and cardiovascular disease as a whole. The CO ISA concludes that a causal relationship is likely to exist between short-term exposures to CO and cardiovascular morbidity. It also concludes that available data are inadequate to conclude that a causal relationship exists between long-term exposures to CO and cardiovascular morbidity.

Animal studies show various neurological effects with in utero CO exposure. Controlled human exposure studies report central nervous system and behavioral effects following low-level CO exposures, although the findings have not been consistent across all studies. The CO ISA concludes that the evidence is suggestive of a causal relationship with both short- and long-term exposure to CO and central nervous system effects.

A number of studies cited in the CO ISA have evaluated the role of CO exposure in birth outcomes such as preterm birth or cardiac birth defects. There is limited epidemiologic evidence of a CO-induced effect on preterm births and birth defects, with weak evidence for a decrease in birth weight. Animal toxicological studies have found perinatal CO exposure to affect birth weight, as well as other developmental outcomes. The CO ISA concludes that the evidence is suggestive of a causal relationship between long-term exposures to CO and developmental effects and birth outcomes.

Epidemiologic studies provide evidence of associations between short-term CO concentrations and respiratory morbidity such as changes in pulmonary function, respiratory symptoms, and hospital admissions. A limited number of epidemiologic studies considered copollutants such as ozone, SO<sub>2</sub>, and PM in two-pollutant models and found that CO risk estimates were generally robust, although this limited evidence makes it difficult to disentangle effects attributed to CO itself from those of the larger complex air pollution mixture. Controlled human exposure studies have not extensively evaluated the effect of CO on respiratory morbidity. Animal studies at levels of 50-100 ppm CO show preliminary evidence of altered pulmonary vascular remodeling and oxidative injury. The CO ISA concludes that the evidence is

---

<sup>214</sup> The ISA evaluates the health evidence associated with different health effects, assigning one of five “weight of evidence” determinations: causal relationship, likely to be a causal relationship, suggestive of a causal relationship, inadequate to infer a causal relationship, and not likely to be a causal relationship. For definitions of these levels of evidence, please refer to Section 1.6 of the ISA.

<sup>215</sup> Personal exposure includes contributions from many sources, and in many different environments. Total personal exposure to CO includes both ambient and non-ambient components; and both components may contribute to adverse health effects.

suggestive of a causal relationship between short-term CO exposure and respiratory morbidity, and inadequate to conclude that a causal relationship exists between long-term exposure and respiratory morbidity.

Finally, the CO ISA concludes that the epidemiologic evidence is suggestive of a causal relationship between short-term concentrations of CO and mortality. Epidemiologic evidence suggests an association exists between short-term exposure to CO and mortality, but limited evidence is available to evaluate cause-specific mortality outcomes associated with CO exposure. In addition, the attenuation of CO risk estimates that was often observed in copollutant models contributes to the uncertainty as to whether CO is acting alone or as an indicator for other combustion-related pollutants. The CO ISA also concludes that there is not likely to be a causal relationship between relevant long-term exposures to CO and mortality.

### **6.3.6 Diesel Exhaust**

#### **6.3.6.1 Background on Diesel Exhaust**

Diesel exhaust is a complex mixture composed of particulate matter, carbon dioxide, oxygen, nitrogen, water vapor, carbon monoxide, nitrogen compounds, sulfur compounds, and numerous low-molecular-weight hydrocarbons. A number of these gaseous hydrocarbon components are individually known to be toxic, including aldehydes, benzene, and 1,3-butadiene. The diesel particulate matter present in diesel exhaust consists mostly of fine particles ( $< 2.5 \mu\text{m}$ ), of which a significant fraction is ultrafine particles ( $< 0.1 \mu\text{m}$ ). These particles have a large surface area which makes them an excellent medium for adsorbing organics and their small size makes them highly respirable. Many of the organic compounds present in the gases and on the particles, such as polycyclic organic matter, are individually known to have mutagenic and carcinogenic properties.

Diesel exhaust varies significantly in chemical composition and particle sizes between different engine types (heavy-duty, light-duty), engine operating conditions (idle, acceleration, deceleration), and fuel formulations (high/low sulfur fuel). Also, there are emissions differences between onroad and nonroad engines because the nonroad engines are generally of older technology. After being emitted in the engine exhaust, diesel exhaust undergoes dilution as well as chemical and physical changes in the atmosphere. The lifetimes of the components present in diesel exhaust range from seconds to months.

#### **6.3.6.2 Health Effects Associated with Exposure to Diesel Exhaust**

In EPA's 2002 Diesel Health Assessment Document (Diesel HAD), exposure to diesel exhaust was classified as likely to be carcinogenic to humans by inhalation from environmental exposures, in accordance with the revised draft 1996/1999 EPA cancer guidelines. (U.S. EPA 1999, U.S. EPA 2002) A number of other agencies (National Institute for Occupational Safety and Health, the International Agency for Research on Cancer, the World Health Organization, California EPA, and the U.S. Department of Health and Human Services) made similar hazard classifications prior to 2002. EPA also concluded in the 2002 Diesel HAD that it was not possible to calculate a cancer unit risk for diesel exhaust due to limitations in the exposure data for the occupational groups or the absence of a dose-response relationship.

In the absence of a cancer unit risk, the Diesel HAD sought to provide additional insight into the significance of the diesel exhaust cancer hazard by estimating possible ranges of risk that

might be present in the population. An exploratory analysis was used to characterize a range of possible lung cancer risk. The outcome was that environmental risks of cancer from long-term diesel exhaust exposures could plausibly range from as low as  $10^{-5}$  to as high as  $10^{-3}$ . Because of uncertainties, the analysis acknowledged that the risks could be lower than  $10^{-5}$ , and a zero risk from diesel exhaust exposure could not be ruled out.

Noncancer health effects of acute and chronic exposure to diesel exhaust emissions are also of concern to EPA. EPA derived a diesel exhaust reference concentration (RfC) from consideration of four well-conducted chronic rat inhalation studies showing adverse pulmonary effects. The RfC is  $5 \mu\text{g}/\text{m}^3$  for diesel exhaust measured as diesel particulate matter. This RfC does not consider allergenic effects such as those associated with asthma or immunologic or the potential for cardiac effects. There was emerging evidence in 2002, discussed in the Diesel HAD, that exposure to diesel exhaust can exacerbate these effects, but the exposure-response data were lacking at that time to derive an RfC based on these then-emerging considerations. The Diesel HAD states, “With [diesel particulate matter] being a ubiquitous component of ambient PM, there is an uncertainty about the adequacy of the existing [diesel exhaust] noncancer database to identify all of the pertinent [diesel exhaust]-caused noncancer health hazards.” The Diesel HAD also noted “that acute exposure to [diesel exhaust] has been associated with irritation of the eye, nose, and throat, respiratory symptoms (cough and phlegm), and neurophysiological symptoms such as headache, lightheadedness, nausea, vomiting, and numbness or tingling of the extremities.” The Diesel HAD notes that the cancer and noncancer hazard conclusions applied to the general use of diesel engines then on the market and as cleaner engines replace a substantial number of existing ones, the applicability of the conclusions would need to be reevaluated.

It is important to note that the Diesel HAD also briefly summarizes health effects associated with ambient PM and discusses EPA’s then-annual  $\text{PM}_{2.5}$  NAAQS of  $15 \mu\text{g}/\text{m}^3$ . In 2012, EPA revised the level of the annual  $\text{PM}_{2.5}$  NAAQS to  $12 \mu\text{g}/\text{m}^3$  and in 2024 EPA revised the level of the annual  $\text{PM}_{2.5}$  NAAQS to  $9.0 \mu\text{g}/\text{m}^3$ . (U.S. EPA 2024) There is a large and extensive body of human data showing a wide spectrum of adverse health effects associated with exposure to ambient PM, of which diesel exhaust is an important component. The  $\text{PM}_{2.5}$  NAAQS provides protection from the health effects attributed to exposure to  $\text{PM}_{2.5}$ . The contribution of diesel PM to total ambient PM varies in different regions of the country and, within a region, from one area to another. The contribution can be high in near-roadway environments, for example, or in other locations where diesel engine use is concentrated.

Since 2002, several new studies have been published which continue to report increased lung cancer risk associated with occupational exposure to diesel exhaust from older engines. Of particular note since 2011 are three new epidemiology studies that have examined lung cancer in occupational populations, including truck drivers, underground nonmetal miners, and other diesel motor-related occupations. These studies reported increased risk of lung cancer related to exposure to diesel exhaust, with evidence of positive exposure-response relationships to varying degrees. (Garshick 2012, Silverman 2012, Olsson 2011) These newer studies (along with others that have appeared in the scientific literature) add to the evidence EPA evaluated in the 2002 Diesel HAD and further reinforce the concern that diesel exhaust exposure likely poses a lung cancer hazard. The findings from these newer studies do not necessarily apply to newer technology diesel engines (i.e., heavy-duty highway engines from 2007 and later model years), since newer engines have large reductions in the emission constituents compared to older technology diesel engines.

In light of the growing body of scientific literature evaluating the health effects of exposure to diesel exhaust, in June 2012 the World Health Organization's International Agency for Research on Cancer (IARC), a recognized international authority on the carcinogenic potential of chemicals and other agents, evaluated the full range of cancer-related health effects data for diesel engine exhaust. IARC concluded that diesel exhaust should be regarded as "carcinogenic to humans." (IARC, Diesel and gasoline engine exhausts and some nitroarenes 2013) This designation was an update from its 1988 evaluation that considered the evidence to be indicative of a "probable human carcinogen."

### **6.3.7 Air Toxics**

Light- and medium-duty engine emissions contribute to ambient levels of air toxics that are known or suspected human or animal carcinogens, or that have noncancer health effects. These compounds include, but are not limited to, acetaldehyde, acrolein, benzene, 1,3-butadiene, formaldehyde, naphthalene, and polycyclic organic matter. These compounds were all identified as national or regional cancer risk drivers or contributors in the 2019 AirToxScreen Assessment. (U.S. EPA 2022, U.S. EPA 2023)

#### **6.3.7.1 Health Effects Associated with Exposure to Acetaldehyde**

Acetaldehyde is classified in EPA's IRIS database as a probable human carcinogen, based on nasal tumors in rats, and is considered toxic by the inhalation, oral, and intravenous routes. (U.S. EPA 1991) The inhalation unit risk estimate (URE) in IRIS for acetaldehyde is  $2.2 \times 10^{-6}$  per  $\mu\text{g}/\text{m}^3$ . (U.S. EPA 1991) Acetaldehyde is reasonably anticipated to be a human carcinogen by the NTP in the 14th Report on Carcinogens and is classified as possibly carcinogenic to humans (Group 2B) by the IARC. (NTP, Report on Carcinogens, Fourteenth Edition 2016) (IARC 1999)

The primary noncancer effects of exposure to acetaldehyde vapors include irritation of the eyes, skin, and respiratory tract. (U.S. EPA 1991) In short-term (4 week) rat studies, degeneration of olfactory epithelium was observed at various concentration levels of acetaldehyde exposure. (Appleman, Woutersen and Feron 1982) Data from these studies were used by EPA to develop an inhalation reference concentration of  $9 \mu\text{g}/\text{m}^3$ . Some asthmatics have been shown to be a sensitive subpopulation to decrements in functional expiratory volume (FEV1 test) and bronchoconstriction upon acetaldehyde inhalation. (Myou, et al. 1993) Children, especially those with diagnosed asthma, may be more likely to show impaired pulmonary function and symptoms of asthma than are adults following exposure to acetaldehyde. (OEHHA 2014)

#### **6.3.7.2 Health Effects Associated with Exposure to Benzene**

EPA's Integrated Risk Information System (IRIS) database lists benzene as a known human carcinogen (causing leukemia) by all routes of exposure, and concludes that exposure is associated with additional health effects, including genetic changes in both humans and animals and increased proliferation of bone marrow cells in mice. (U.S. EPA 2000, IARC 1982, Irons, et al. 1992) EPA states in its IRIS database that data indicate a causal relationship between benzene exposure and acute lymphocytic leukemia and suggest a relationship between benzene exposure and chronic non-lymphocytic leukemia and chronic lymphocytic leukemia. EPA's IRIS documentation for benzene also lists a range of  $2.2 \times 10^{-6}$  to  $7.8 \times 10^{-6}$  per  $\mu\text{g}/\text{m}^3$  as the unit

risk estimate (URE) for benzene.<sup>216</sup> (U.S. EPA 2000) The International Agency for Research on Cancer (IARC) has determined that benzene is a human carcinogen, and the U.S. Department of Health and Human Services (DHHS) has characterized benzene as a known human carcinogen. (IARC 2018, NTP, Report on Carcinogens, Fourteenth Edition 2016)

A number of adverse noncancer health effects, including blood disorders such as preleukemia and aplastic anemia, have also been associated with long-term exposure to benzene. (Aksoy 1989, Goldstein 1988) The most sensitive noncancer effect observed in humans, based on current data, is the depression of the absolute lymphocyte count in blood. (Rothman 1996, U.S. EPA 2002) EPA's inhalation reference concentration (RfC) for benzene is 30 µg/m<sup>3</sup>. The RfC is based on suppressed absolute lymphocyte counts seen in humans under occupational exposure conditions. In addition, studies sponsored by the Health Effects Institute (HEI) provide evidence that biochemical responses occur at lower levels of benzene exposure than previously known. (O. Qu, et al. 2003, Q. Qu, et al. 2002, Lan, et al. 2004, Turteltaub and Mani 2003) EPA's IRIS program has not yet evaluated these new data. EPA does not currently have an acute reference concentration for benzene. The Agency for Toxic Substances and Disease Registry (ATSDR) Minimal Risk Level (MRL) for acute exposure to benzene is 29 µg/m<sup>3</sup> for 1-14 days exposure.<sup>217</sup> (ATSDR, Toxicological profile for benzene 2007)

There is limited information from two studies regarding an increased risk of adverse effects to children whose parents have been occupationally exposed to benzene. (Corti and Snyder 1996, P.A., et al. 1991) Data from animal studies have shown benzene exposures result in damage to the hematopoietic (blood cell formation) system during development. (Keller and Snyder 1986, Keller and Snyder 1988, Corti and Snyder 1996) Also, key changes related to the development of childhood leukemia occur in the developing fetus. (U.S. EPA 2002) Several studies have reported that genetic changes related to eventual leukemia development occur before birth. For example, there is one study of genetic changes in twins who developed T cell leukemia at nine years of age. (Ford, et al. 1997)

### **6.3.7.3 Health Effects Associated with Exposure to 1,3-Butadiene**

EPA has characterized 1,3-butadiene as carcinogenic to humans by inhalation. (U.S. EPA 2002) (U.S. EPA 2002) The IARC has determined that 1,3-butadiene is a human carcinogen and the U.S. DHHS has characterized 1,3-butadiene as a known human carcinogen. (IARC 1999) (IARC 2008) (NTP 2016) (IARC 2012) There are numerous studies consistently demonstrating that 1,3-butadiene is metabolized into genotoxic metabolites by experimental animals and humans. The specific mechanisms of 1,3-butadiene-induced carcinogenesis are unknown; however, the scientific evidence strongly suggests that the carcinogenic effects are mediated by genotoxic metabolites. Animal data suggest that females may be more sensitive than males for cancer effects associated with 1,3-butadiene exposure; there are insufficient data in humans from which to draw conclusions about sensitive subpopulations. The URE for 1,3-butadiene is  $3 \times 10^{-5}$  per µg/m<sup>3</sup>. (U.S. EPA 2002) 1,3-butadiene also causes a variety of reproductive and developmental effects in mice; no human data on these effects are available. The most sensitive

---

<sup>216</sup> A unit risk estimate is defined as the increase in the lifetime risk of cancer of an individual who is exposed for a lifetime to 1 µg/m<sup>3</sup> benzene in air.

<sup>217</sup> A minimal risk level (MRL) is defined as an estimate of the daily human exposure to a hazardous substance that is likely to be without appreciable risk of adverse noncancer health effects over a specified duration of exposure.



effect was ovarian atrophy observed in a lifetime bioassay of female mice. (Bevan, Stadler and al 1996) Based on this critical effect and the benchmark concentration methodology, an RfC for chronic health effects was calculated at 0.9 ppb (approximately 2 µg/m<sup>3</sup>).

#### **6.3.7.4 Health Effects Associated with Exposure to Formaldehyde**

In 1991, EPA concluded that formaldehyde is a Class B1 probable human carcinogen based on limited evidence in humans and sufficient evidence in animals. (U.S. EPA 1990) An Inhalation URE for cancer and a Reference Dose for oral noncancer effects were developed by EPA and posted on the IRIS database. Since that time, the NTP and IARC have concluded that formaldehyde is a known human carcinogen. (NTP, Report on Carcinogens, Fourteenth Edition 2016, IARC 2006, IARC 2012)

The conclusions by IARC and NTP reflect the results of epidemiologic research published since 1991 in combination with previous and more recent animal, human, and mechanistic evidence. Research conducted by the National Cancer Institute reported an increased risk of nasopharyngeal cancer and specific lymphohematopoietic malignancies among workers exposed to formaldehyde. (Hauptmann, Lubin, et al. 2003, Hauptmann, Lubin, et al. 2004, Beane Freeman, et al. 2009) A National Institute of Occupational Safety and Health study of garment workers also reported increased risk of death due to leukemia among workers exposed to formaldehyde. (Pinkerton 2004) Extended follow-up of a cohort of British chemical workers did not report evidence of an increase in nasopharyngeal or lymphohematopoietic cancers, but a continuing statistically significant excess in lung cancers was reported. (Coggon, et al. 2003) Finally, a study of embalmers reported formaldehyde exposures to be associated with an increased risk of myeloid leukemia but not brain cancer. (Hauptmann, et al. 2009)

Health effects of formaldehyde in addition to cancer were reviewed by the Agency for Toxic Substances and Disease Registry in 1999, supplemented in 2010, and by the World Health Organization. (ATSDR 1999, ATSDR 2010, IPCS 2002) These organizations reviewed the scientific literature concerning health effects linked to formaldehyde exposure to evaluate hazards and dose response relationships and defined exposure concentrations for minimal risk levels (MRLs). The health endpoints reviewed included sensory irritation of eyes and respiratory tract, reduced pulmonary function, nasal histopathology, and immune system effects. In addition, research on reproductive and developmental effects and neurological effects were discussed along with several studies that suggest that formaldehyde may increase the risk of asthma – particularly in the young.

In June 2010, EPA released a draft Toxicological Review of Formaldehyde – Inhalation Assessment through the IRIS program for peer review by the National Research Council (NRC) and public comment. (U.S. EPA 2010) That draft assessment reviewed more recent research from animal and human studies on cancer and other health effects. The NRC released their review report in April 2011. (NRC, Review of the Environmental Protection Agency’s Draft IRIS Assessment of Formaldehyde 2011) EPA addressed the NRC (2011) recommendations and applied systematic review methods to the evaluation of the available noncancer and cancer health effects evidence and released a new draft IRIS Toxicological Review of Formaldehyde - Inhalation in April 2022. (US EPA 2022) In this draft, updates to the 1991 IRIS finding include a stronger determination of the carcinogenicity of formaldehyde inhalation to humans, as well as characterization of its noncancer effects to propose an overall reference concentration for inhalation exposure. The National Academies of Science, Engineering, and Medicine released

their review of EPA's 2022 Draft Formaldehyde Assessment in August 2023, concluding that EPA's "findings on formaldehyde hazard and quantitative risk are supported by the evidence identified." (National Academies of Sciences. Engineering 2023) EPA is currently revising the draft IRIS assessment in response to comments received.<sup>218</sup>

### 6.3.7.5 Health Effects Associated with Exposure to Naphthalene

Naphthalene is found in small quantities in gasoline and diesel fuels. Naphthalene emissions have been measured in larger quantities in both gasoline and diesel exhaust compared with evaporative emissions from mobile sources, indicating it is primarily a product of combustion.

Acute (short-term) exposure of humans to naphthalene by inhalation, ingestion, or dermal contact is associated with hemolytic anemia and damage to the liver and the nervous system. (U.S. EPA 1998) Chronic (long term) exposure of workers and rodents to naphthalene has been reported to cause cataracts and retinal damage. (U.S. EPA 1998) Children, especially neonates, appear to be more susceptible to acute naphthalene poisoning based on the number of reports of lethal cases in children and infants (hypothesized to be due to immature naphthalene detoxification pathways). (U.S. EPA 1998) EPA released an external review draft of a reassessment of the inhalation carcinogenicity of naphthalene based on a number of recent animal carcinogenicity studies. (U.S. EPA 1998) The draft reassessment completed external peer review. (Oak Ridge Institute for Science and Education 2004) Based on external peer review comments received, EPA is developing a revised draft assessment that considers inhalation and oral routes of exposure, as well as cancer and noncancer effects (U.S. EPA 2023). The external review draft does not represent official agency opinion and was released solely for the purposes of external peer review and public comment. The NTP listed naphthalene as "reasonably anticipated to be a human carcinogen" in 2004 on the basis of bioassays reporting clear evidence of carcinogenicity in rats and some evidence of carcinogenicity in mice. (NTP, Report on Carcinogens, Fourteenth Edition 2016) California EPA has released a risk assessment for naphthalene, and the IARC has reevaluated naphthalene and re-classified it as Group 2B: possibly carcinogenic to humans. (IARC 2002)

Naphthalene also causes a number of non-cancer effects in animals following chronic and less-than-chronic exposure, including abnormal cell changes and growth in respiratory and nasal tissues. (U.S. EPA 1998) The current EPA IRIS assessment includes noncancer data on hyperplasia and metaplasia in nasal tissue that form the basis of the inhalation RfC of 3  $\mu\text{g}/\text{m}^3$ . (U.S. EPA 1998) The ATSDR MRL for acute and intermediate duration oral exposure to naphthalene is 0.6 mg/kg/day based on maternal toxicity in a developmental toxicology study in rats. (ATSDR 2005) ATSDR also derived an ad hoc reference value of  $6 \times 10^{-2}$  mg/m<sup>3</sup> for acute ( $\leq 24$ -hour) inhalation exposure to naphthalene in a Letter Health Consultation dated March 24, 2014 to address a potential exposure concern in Illinois. (ATSDR 2014) The ATSDR acute inhalation reference value was based on a qualitative identification of an exposure level interpreted not to cause pulmonary lesions in mice. More recently, EPA developed acute RfCs for 1-, 8-, and 24-hour exposure scenarios; the  $\leq 24$ -hour reference value is  $2 \times 10^{-2}$  mg/m<sup>3</sup>. (U.S. EPA 2022) EPA's acute RfCs are based on a systematic review of the literature, benchmark dose

---

<sup>218</sup> For more information, see [https://cfpub.epa.gov/ncea/iris\\_drafts/recordisplay.cfm?deid=248150#](https://cfpub.epa.gov/ncea/iris_drafts/recordisplay.cfm?deid=248150#).

modeling of naphthalene-induced nasal lesions in rats, and application of a PBPK (physiologically based pharmacokinetic) model.

### **6.3.7.6 Health Effects Associated with Exposure to PAHs/POM**

The term polycyclic organic matter (POM) defines a broad class of compounds that includes the polycyclic aromatic hydrocarbon compounds (PAHs). One of these compounds, naphthalene, is discussed separately in Section 6.2.7.5. POM compounds are formed primarily from combustion and are present in the atmosphere in gas and particulate form as well as in some fried and grilled foods. Epidemiologic studies have reported an increase in lung cancer in humans exposed to diesel exhaust, coke oven emissions, roofing tar emissions, and cigarette smoke; all of these mixtures contain POM compounds. (ATSDR 1995) (U.S. EPA 2002) In 1991, EPA classified seven PAHs (benzo[a]pyrene, benz[a]anthracene, chrysene, benzo[b]fluoranthene, benzo[k]fluoranthene, dibenz[a,h]anthracene, and indeno[1,2,3-cd]pyrene) as Group B2, probable human carcinogens based on the 1986 EPA Guidelines for Carcinogen Risk Assessment. (U.S. EPA 1991) Studies in multiple animal species demonstrate that benzo[a]pyrene is carcinogenic at multiple tumor sites (alimentary tract, liver, kidney, respiratory tract, pharynx, and skin) by all routes of exposure. An increasing number of occupational studies demonstrate a positive exposure-response relationship with cumulative benzo[a]pyrene exposure and lung cancer. The inhalation URE in IRIS for benzo[a]pyrene is  $6 \times 10^{-4}$  per  $\mu\text{g}/\text{m}^3$  and the oral slope factor for cancer is 1 per mg/kg-day. (U.S. EPA 2017)

Animal studies demonstrate that exposure to benzo[a]pyrene is also associated with developmental (including developmental neurotoxicity), reproductive, and immunological effects. In addition, epidemiology studies involving exposure to PAH mixtures have reported associations between internal biomarkers of exposure to benzo[a]pyrene (benzo[a]pyrene diol epoxide-DNA adducts) and adverse birth outcomes (including reduced birth weight, postnatal body weight, and head circumference), neurobehavioral effects, and decreased fertility. The inhalation RfC for benzo[a]pyrene is  $2 \times 10^{-6}$  mg/m<sup>3</sup> and the RfD for oral exposure is  $3 \times 10^{-4}$  mg/kg-day. (U.S. EPA 2017)

### **6.3.8 Exposure and Health Effects Associated with Traffic**

Locations in close proximity to major roadways generally have elevated concentrations of many air pollutants emitted from motor vehicles. Hundreds of studies have been published in peer-reviewed journals, concluding that concentrations of CO, CO<sub>2</sub>, NO, NO<sub>2</sub>, benzene, aldehydes, PM, black carbon, and many other compounds are elevated in ambient air within approximately 300-600 meters (about 1,000-2,000 feet) of major roadways. The highest concentrations of most pollutants emitted directly by motor vehicles are found at locations within 50 meters (about 165 feet) of the edge of a roadway's traffic lanes.

A large-scale review of air quality measurements in the vicinity of major roadways between 1978 and 2008 concluded that the pollutants with the steepest concentration gradients in vicinities of roadways were CO, UFPs, metals, elemental carbon (EC), NO, NO<sub>x</sub>, and several VOCs. (Karner, Eisinger and Niemeier, Near-roadway air quality: synthesizing the findings from real-world data 2010) These pollutants showed a large reduction in concentrations within 100 meters downwind of the roadway. Pollutants that showed more gradual reductions with distance from roadways included benzene, NO<sub>2</sub>, PM<sub>2.5</sub>, and PM<sub>10</sub>. In reviewing the literature, Karner, Eisinger, and Niemeier (Karner, Eisinger and Niemeier, Near-roadway air quality: synthesizing

the findings from real-world data 2010) reported that results varied based on the method of statistical analysis used to determine the gradient in pollutant concentration. More recent studies continue to show significant concentration gradients of traffic-related air pollution around major roads. (McDonald, et al. 2014, Kimbrough, Baldauf, et al. 2013, Kimbrough, Palma and Baldauf 2014, Kimbrough, Owen, et al. 2017, Hilker, et al. 2019, Grivas, et al. 2019, Apte, et al. 2017, Dabek-Zlotorzynska, et al. 2019, Gu, et al. 2018) There is evidence that EPA's regulations for vehicles have lowered the near-road concentrations and gradients. (Sarnat, et al. 2018) Starting in 2010, EPA required through the NAAQS process that air quality monitors be placed near high-traffic roadways for determining concentrations of CO, NO<sub>2</sub>, and PM<sub>2.5</sub> (in addition to those existing monitors located in neighborhoods and other locations farther away from pollution sources). The monitoring data for NO<sub>2</sub> indicate that in urban areas, monitors near roadways often report the highest concentrations of NO<sub>2</sub>. (Gantt, Owen and Watkins 2021, Lal, Ramaswami and Russell 2020)

For pollutants with relatively high background concentrations relative to near-road concentrations, detecting concentration gradients can be difficult. For example, many carbonyls have high background concentrations because of photochemical breakdown of precursors from many different organic compounds. However, several studies have measured carbonyls in multiple weather conditions and found higher concentrations of many carbonyls downwind of roadways. (Liu, et al. 2006, Cahill, Charles and Seaman 2010) These findings suggest a substantial roadway source of these carbonyls.

In the past 30 years, many studies have been published with results reporting that populations who live, work, or go to school near high-traffic roadways experience higher rates of numerous adverse health effects, compared to populations far away from major roads.<sup>219</sup> In addition, numerous studies have found adverse health effects associated with spending time in traffic, such as commuting or walking along high-traffic roadways, including studies among children. (Laden, et al. 2007, Peters, et al. 2004, Zanobetti, et al. 2009, Adar, et al. 2007)

Numerous reviews of this body of health literature have been published. In a 2022 final report, an expert panel of the Health Effects Institute (HEI) employed a systematic review focusing on selected health endpoints related to exposure to traffic-related air pollution. (HEI 2022)<sup>220</sup> The HEI panel concluded that there was a high level of confidence in evidence between long-term exposure to traffic-related air pollution and health effects in adults, including all-cause, circulatory, and ischemic heart disease mortality. (Boogaard, et al. 2022) The panel also found that there is a moderate-to-high level of confidence in evidence of associations with asthma onset and acute respiratory infections in children and lung cancer and asthma onset in adults. This report follows on an earlier expert review published by HEI in 2010, where it found strongest evidence for asthma-related traffic impacts. Other literature reviews have been published with conclusions generally similar to the HEI panels' conclusions. (Boothe and Shendell 2008, Salam, Islam and Gilliland 2008, Sun, Zhang and Ma 2014, Raaschou-Nielsen

---

<sup>219</sup> In the widely used PubMed database of health publications, between January 1, 1990 and December 31, 2021, 1,979 publications contained the keywords "traffic, pollution, epidemiology," with approximately half the studies published after 2015.

<sup>220</sup> This more recent review focused on health outcomes related to birth effects, respiratory effects, cardiometabolic effects, and mortality.

and Reynolds 2006) Additionally, in 2014, researchers from the U.S. Centers for Disease Control and Prevention (CDC) published a systematic review and meta-analysis of studies evaluating the risk of childhood leukemia associated with traffic exposure and reported positive associations between “postnatal” proximity to traffic and leukemia risks, but no such association for “prenatal” exposures. (Boothe, et al. 2014) The U.S. Department of Health and Human Services’ National Toxicology Program (NTP) published a monograph including a systematic review of traffic-related air pollution and its impacts on hypertensive disorders of pregnancy. The NTP concluded that exposure to traffic-related air pollution is "presumed to be a hazard to pregnant women" for developing hypertensive disorders of pregnancy. (NTP 2019)

For several other health outcomes there are publications to suggest the possibility of an association with traffic-related air pollution, but insufficient evidence to draw definitive conclusions. Among these outcomes are neurological and cognitive impacts (e.g., autism and reduced cognitive function, academic performance, and executive function) and reproductive outcomes (e.g., preterm birth, low birth weight). (Volk, et al. 2011, Franco-Suglia, et al. 2007, Power, et al. 2011, Wu, et al. 2011, Stenson, et al. 2021, Gartland, et al. 2022)

Numerous studies have also investigated potential mechanisms by which traffic-related air pollution affects health, particularly for cardiopulmonary outcomes. For example, numerous studies indicate that near-roadway exposures may increase systemic inflammation, affecting organ systems, including blood vessels and lungs. (Riediker 2007, Alexeef, et al. 2011, Eckel, et al. 2011, Zhang, et al. 2009) Additionally, long-term exposures in near-road environments have been associated with inflammation-associated conditions, such as atherosclerosis and asthma. (Adar, Klein, et al. 2010, Kan, et al. 2008, McConnell, et al. 2010)

The risks associated with residence, workplace, or schools near major roads are of potentially high public health significance due to the large population in such locations. The 2013 U.S. Census Bureau’s American Housing Survey (AHS) was the last AHS that included whether housing units were within 300 feet of an “airport, railroad, or highway with four or more lanes.”<sup>221</sup> The 2013 survey reports that 17.3 million housing units, or 13 percent of all housing units in the U.S., were in such areas. Assuming that populations and housing units are in the same locations, this corresponds to a population of more than 41 million U.S. residents within 300 feet of high-traffic roadways or other transportation sources. According to the Central Intelligence Agency’s World Factbook, based on data collected between 2012-2014, the United States had 6,586,610 km of roadways, 293,564 km of railways, and 13,513 airports. As such, highways represent the overwhelming majority of transportation facilities described by this factor in the AHS.

Scientific literature suggests that some sociodemographic factors may increase susceptibility to the effects of traffic-associated air pollution. For example, several studies have found stronger adverse health associations in children experiencing chronic social stress, such as living in violent neighborhoods or in homes with low incomes or high family stress. (Islam, et al. 2011, Clougherty, et al. 2007, Chen, et al. 2008, Long, Lewis and Langpap 2021) HEI's 2022 critical review of traffic and health studies mentions additional potential mediators or effect modifiers of the relationship between traffic-related air pollution and health, including preexisting morbidities (e.g., obesity, hypertension), the built environment (i.e., green space, walkability), and

---

<sup>221</sup> The variable was known as "ETRANS" in the questions about the neighborhood.

socioeconomic characteristics, but notes that additional research is needed to better understand such interactions. (HEI 2022)

EPA conducted a study to estimate the number of people living near truck freight routes in the United States, which includes many large highways and other routes where light- and medium-duty vehicles operate. (U.S. EPA 2021) Based on a population analysis using the U.S. Department of Transportation's (USDOT) Freight Analysis Framework 4 (FAF4) and population data from the 2010 decennial census, an estimated 72 million people live within 200 meters of these FAF4 roads, which are used by all types of vehicles (U.S. DOT 2023).<sup>222,223</sup> This analysis includes the population living within twice the distance of major roads compared with the analysis of housing units near major roads described above in this section. The larger distance and other methodological differences explain the difference in the two estimates for populations living near major roads.

In examining schools near major roadways, we used the Common Core of Data from the U.S. Department of Education, which includes information on all public elementary and secondary schools and school districts nationwide.<sup>224,225</sup> To determine school proximities to major roadways, we used a geographic information system to map each school and roadways based on the U.S. Census's TIGER roadway file. Ten million students attend public schools within 200 meters of major roads, about 20 percent of the total number of public school students in the U.S., and about 800,000 students attend public schools within 200 meters of primary roads.<sup>226,227</sup> We found that students of color were overrepresented at schools within 200 meters of primary roadways, and schools within 200 meters of primary roadways had a disproportionately greater population of students eligible for free or reduced-price lunches. Black students represent 22 percent of students at schools located within 200 meters of a primary road, compared to 17 percent of students in all U.S. schools. Hispanic students represent 30 percent of students at schools located within 200 meters of a primary road, compared to 22 percent of students in all U.S. schools. (Pedde and Bailey 2011)

---

<sup>222</sup> FAF4 is a model from the USDOT's Bureau of Transportation Statistics (BTS) and Federal Highway Administration (FHWA), which provides data associated with freight movement in the U.S. It includes data from the 2012 Commodity Flow Survey (CFS), the Census Bureau on international trade, as well as data associated with construction, agriculture, utilities, warehouses, and other industries. FAF4 estimates the modal choices for moving goods by trucks, trains, boats, and other types of freight modes. It includes traffic assignments, including truck flows on a network of truck routes

<sup>223</sup> The same analysis estimated the population living within 100 meters of a FAF4 truck route is 41 million.

<sup>224</sup> This information is available at: <http://nces.ed.gov/ccd/>.

<sup>225</sup> TIGER/Line shapefiles for the year 2010. [Online at <https://www.census.gov/geographies/mapping-files/time-series/geo/tiger-line-file.2010.html>]

<sup>226</sup> Here, "major roads" refer to those TIGER classifies as either "Primary" or "Secondary." The Census Bureau describes primary roads as "generally divided limited-access highways within the Federal interstate system or under state management." Secondary roads are "main arteries, usually in the U.S. highway, state highway, or county highway system."

<sup>227</sup> For this analysis we analyzed a 200-meter distance based on the understanding that roadways generally influence air quality within a few hundred meters from the vicinity of heavily traveled roadways or along corridors with significant trucking traffic. See U.S. EPA, 2014. Near Roadway Air Pollution and Health: Frequently Asked Questions. EPA-420-F-14-044.

While near-roadway studies focus on residents near roads or others spending considerable time near major roads, the duration of commuting results in another important contributor to overall exposure to traffic-related air pollution. Studies of health that address time spent in transit have found evidence of elevated risk of cardiac impacts. (Riediker, Cascio, et al. 2004, Peters, et al. 2004, Adar, Gold and Coull 2007) Studies have also found that school bus emissions can increase student exposures to diesel-related air pollutants, and that programs that reduce school bus emissions may improve health and reduce school absenteeism. (Sabin, et al. 2005, Li, N and Ryan 2009, Austin, Heutel and Kreisman 2019, Adar, D.Souza and Sheppard 2015) Lastly, EPA's Exposure Factor Handbook indicates that, on average, Americans spend more than an hour traveling each day, bringing nearly all residents into a high-exposure microenvironment for part of the day. (U.S. EPA 2016)<sup>228</sup>

#### **6.4 Welfare Effects Associated with Exposure to Criteria and Air Toxics Pollutants**

This section discusses the environmental effects associated with non-GHG pollutants affected by this rule, specifically PM, ozone, NO<sub>x</sub>, SO<sub>x</sub>, and air toxics.

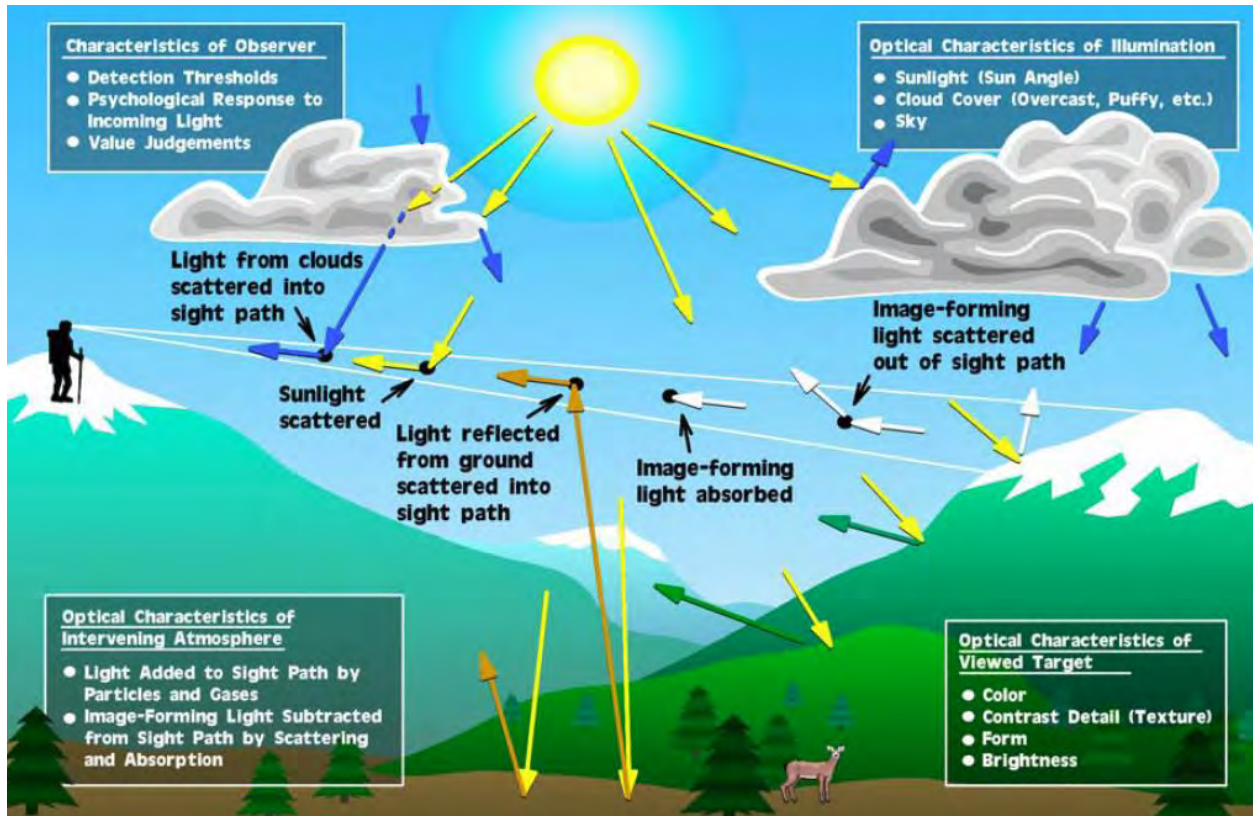
##### **6.4.1 Visibility Degradation**

Visibility can be defined as the degree to which the atmosphere is transparent to visible light. (NRC 1993) Visibility impairment is caused by light scattering and absorption by suspended particles and gases. It is dominated by contributions from suspended particles except under pristine conditions. Fine particles with significant light-extinction efficiencies include sulfates, nitrates, organic carbon, elemental carbon, sea salt, and soil. (J. e. Hand 2011, Sisler 1996) Visibility is important because it has direct significance to people's enjoyment of daily activities in all parts of the country. Individuals value good visibility for the well-being it provides them directly, where they live and work and in places where they enjoy recreational opportunities. Visibility is also highly valued in significant natural areas, such as national parks and wilderness areas, and special emphasis is given to protecting visibility in these areas. For more information on visibility, see the final 2019 PM ISA. (U.S. EPA 2019)

The extent to which any amount of light extinction affects a person's ability to view a scene depends on both scene and light characteristics. For example, the appearance of a nearby object (e.g., a building) is generally less sensitive to a change in light extinction than the appearance of a similar object at a greater distance. See Figure 6-1 for an illustration of the important factors affecting visibility. (Malm 2016)

---

<sup>228</sup> It is not yet possible to estimate the long-term impact of growth in telework associated with the COVID-19 pandemic on travel behavior. There were notable changes during the pandemic. For example, according to the 2021 American Time Use Survey, a greater fraction of workers did at least part of their work at home (38%) as compared with the 2019 survey (24%). [Online at <https://www.bls.gov/news.release/atus.nr0.htm>].



**Figure 6-1: Important Factors Involved in Seeing a Scenic Vista (Malm, 2016).**

EPA is working to address visibility impairment. Reductions in air pollution from implementation of various programs called for in the Clean Air Act Amendments of 1990 (CAAA) have resulted in substantial improvements in visibility and will continue to do so in the future. Nationally, because trends in haze are closely associated with trends in particulate sulfate and nitrate emissions due to the relationship between their concentration and light extinction, visibility trends have improved as emissions of SO<sub>2</sub> and NO<sub>x</sub> have decreased over time due to air pollution regulations such as the Acid Rain Program. (U.S. EPA 2019) However, in the western part of the country, changes in total light extinction were smaller, and the contribution of particulate organic matter to atmospheric light extinction was increasing due to increasing wildfire emissions. (Hand, et al. 2020)

In the Clean Air Act Amendments of 1977, Congress recognized visibility's value to society by establishing a national goal to protect national parks and wilderness areas from visibility impairment caused by manmade pollution (42 USC §7491 (a) 2013). In 1999, EPA finalized the regional haze program (64 FR 35714) to protect the visibility in Mandatory Class I Federal areas. There are 156 national parks, forests, and wilderness areas categorized as Mandatory Class I Federal areas (62 FR 38680-38681, July 18, 1997). These areas are defined in CAA Section 162 as those national parks exceeding 6,000 acres, wilderness areas and memorial parks exceeding 5,000 acres, and all international parks that were in existence on August 7, 1977. Figure 6-2 shows the location of the 156 Mandatory Class I Federal areas.





**Figure 6-2: Mandatory Class I Federal Areas in the U.S.**

EPA has also concluded that PM<sub>2.5</sub> causes adverse effects on visibility in other areas that are not targeted by the Regional Haze Rule, such as urban areas, depending on PM<sub>2.5</sub> concentrations and other factors such as dry chemical composition and relative humidity (i.e., an indicator of the water composition of the particles). The secondary (welfare-based) PM NAAQS provide protection against visibility effects. In recent PM NAAQS reviews, EPA evaluated a target level of protection for visibility impairment that is expected to be met through attainment of the existing secondary PM standards.

#### 6.4.1.1 Visibility Monitoring

In conjunction with the U.S. National Park Service, the U.S. Forest Service, other Federal land managers, and State organizations in the U.S., EPA has supported visibility monitoring in national parks and wilderness areas since 1988. The monitoring network was originally established at 20 sites, but it has now been expanded to 152 sites that represent all but one of the 156 Mandatory Federal Class I areas across the country (see Figure 6-2). This long-term visibility monitoring network is known as IMPROVE (Interagency Monitoring of Protected Visual Environments).

IMPROVE provides direct measurement of particles that contribute to visibility impairment. The IMPROVE network employs aerosol measurements at all sites, and optical and scene measurements at some of the sites. Aerosol measurements are taken for PM<sub>10</sub> and PM<sub>2.5</sub> mass, and for key constituents of PM<sub>2.5</sub>, such as sulfate, nitrate, organic and elemental carbon (OC and EC), and other elements that can be used to estimate soil dust and sea salt contributions. Measurements for specific aerosol constituents are used to calculate "reconstructed" aerosol light extinction by multiplying the mass for each constituent by its empirically-derived scattering and/or absorption efficiency, with adjustment for the relative humidity. The IMPROVE program utilizes both an "original" and a "revised" reconstruction formula for this purpose, with the latter

explicitly accounting for sea salt concentrations. Knowledge of the main constituents of a site's light extinction "budget" is critical for source apportionment and control strategy development. In addition to this indirect method of assessing light extinction, there are optical measurements which directly measure light extinction or its components. Such measurements are made principally with a nephelometer to measure light scattering; some sites also include an aethalometer for light absorption; and a few sites use a transmissometer, which measures total light extinction. Scene characteristics are typically recorded using digital or video photography and are used to determine the quality of visibility conditions (such as effects on color and contrast) associated with specific levels of light extinction as measured under both direct and aerosol-related methods. Directly measured light extinction is used under the IMPROVE protocol to cross check that total light extinction calculated from the IMPROVE reconstruction formula are consistent with directly measured extinction. Aerosol-derived light extinction from the IMPROVE equation is used to document spatial and temporal trends and to determine how changes in atmospheric constituents would affect future visibility conditions.

Annual average visibility conditions (reflecting light extinction due to both anthropogenic and non-anthropogenic sources) vary regionally across the U.S. Figures 13-1 through 13-14 in the PM ISA detail the percent contributions to particulate light extinction for ammonium nitrate and sulfate, EC and OC, and coarse mass and fine soil, by month. (U.S. EPA 2019)

#### **6.4.2 Plant and Ecosystem Effects of Ozone**

The welfare effects of ozone include effects on ecosystems, which can be observed across a variety of scales, i.e., subcellular, cellular, leaf, whole plant, population, and ecosystem. When ozone effects that begin at small spatial scales, such as the leaf of an individual plant, occur at sufficient magnitudes (or to a sufficient degree), they can result in effects being propagated higher and higher levels of biological organization. For example, effects at the individual plant level, such as altered rates of leaf gas exchange, growth and reproduction, can, when widespread, result in broad changes in ecosystems, such as productivity, carbon storage, water cycling, nutrient cycling, and community composition.

Ozone can produce both acute and chronic injury in sensitive plant species depending on the concentration level and the duration of the exposure. (U.S. EPA 2020) In those sensitive species,<sup>229</sup> effects from repeated exposure to ozone throughout the growing season of the plant can tend to accumulate, so that even relatively low concentrations experienced for a longer duration have the potential to create chronic stress on vegetation. (U.S. EPA 2020)<sup>230</sup> Ozone damage to sensitive plant species includes impaired photosynthesis and visible injury to leaves. The impairment of photosynthesis, the process by which the plant makes carbohydrates (its source of energy and food), can lead to reduced crop yields, timber production, and plant productivity and growth. Impaired photosynthesis can also lead to a reduction in root growth and carbohydrate storage below ground, resulting in other, more subtle plant and ecosystems impacts (U.S. EPA 2020). These latter impacts include increased susceptibility of plants to insect attack,

---

<sup>229</sup> Only a small percentage of all the plant species growing within the U.S. (over 43,000 species have been catalogued in the USDA PLANTS database) have been studied with respect to ozone sensitivity.

<sup>230</sup> The concentration at which ozone levels overwhelm a plant's ability to detoxify or compensate for oxidant exposure varies. Thus, whether a plant is classified as sensitive or tolerant depends in part on the exposure levels being considered.

disease, harsh weather, interspecies competition, and overall decreased plant vigor. The adverse effects of ozone on areas with sensitive species could potentially lead to species shifts and loss from the affected ecosystems,<sup>231</sup> resulting in a loss or reduction in associated ecosystem goods and services. (73 FR 16493-16494 2008) Additionally, visible ozone injury to leaves can result in a loss of aesthetic value in areas of special scenic significance like national parks and wilderness areas and reduced use of sensitive ornamentals in landscaping. (U.S. EPA 2020) In addition to ozone effects on vegetation, newer evidence suggests that ozone affects interactions between plants and insects by altering chemical signals (e.g., floral scents) that plants use to communicate to other community members, such as attraction of pollinators.

The Ozone ISA presents more detailed information on how ozone affects vegetation and ecosystems. (U.S. EPA 2020) The Ozone ISA reports causal and likely causal relationships between ozone exposure and a number of welfare effects and characterizes the weight of evidence for different effects associated with ozone.<sup>232</sup> The Ozone ISA concludes that visible foliar injury effects on vegetation, reduced vegetation growth, reduced plant reproduction, reduced productivity in terrestrial ecosystems, reduced yield and quality of agricultural crops, alteration of below-ground biogeochemical cycles, and altered terrestrial community composition are causally associated with exposure to ozone. It also concludes that increased tree mortality, altered herbivore growth and reproduction, altered plant-insect signaling, reduced carbon sequestration in terrestrial ecosystems, and alteration of terrestrial ecosystem water cycling are likely to be causally associated with exposure to ozone.

### **6.4.3 Deposition**

Deposited airborne pollutants contribute to adverse effects on ecosystems, and to soiling and materials damage. These welfare effects result mainly from exposure to excess amounts of specific chemical species, regardless of their source or predominant form (particle, gas, or liquid). Nitrogen and sulfur tend to comprise a large portion of PM in many locations; however, gas-phase forms of oxidized nitrogen and sulfur also cause adverse ecological effects. The following characterizations of the nature of these environmental effects are based on information contained in the 2019 PM ISA, and the 2020 Integrated Science Assessment for Oxides of Nitrogen, Oxides of Sulfur, and Particulate Matter - Ecological Criteria. (U.S. EPA 2020, U.S. EPA 2019)

#### **6.4.3.1 Deposition of Nitrogen and Sulfur**

Nitrogen and sulfur interactions in the environment are highly complex, as shown in Figure 6-3. (U.S. EPA 2020) Both nitrogen and sulfur are essential, and sometimes limiting, nutrients needed for growth and productivity of ecosystem components (e.g., algae, plants). In terrestrial and aquatic ecosystems, excesses of nitrogen or sulfur can lead to acidification and nutrient

---

<sup>231</sup> Per footnote above, ozone impacts could be occurring in areas where plant species sensitive to ozone have not yet been studied or identified.

<sup>232</sup> The Ozone ISA evaluates the evidence associated with different ozone related health and welfare effects, assigning one of five “weight of evidence” determinations: causal relationship, likely to be a causal relationship, suggestive of a causal relationship, inadequate to infer a causal relationship, and not likely to be a causal relationship. For more information on these levels of evidence, please refer to Table II of the ISA.

enrichment. (U.S. EPA 2020) In addition, in aquatic ecosystems, sulfur deposition can increase mercury methylation.

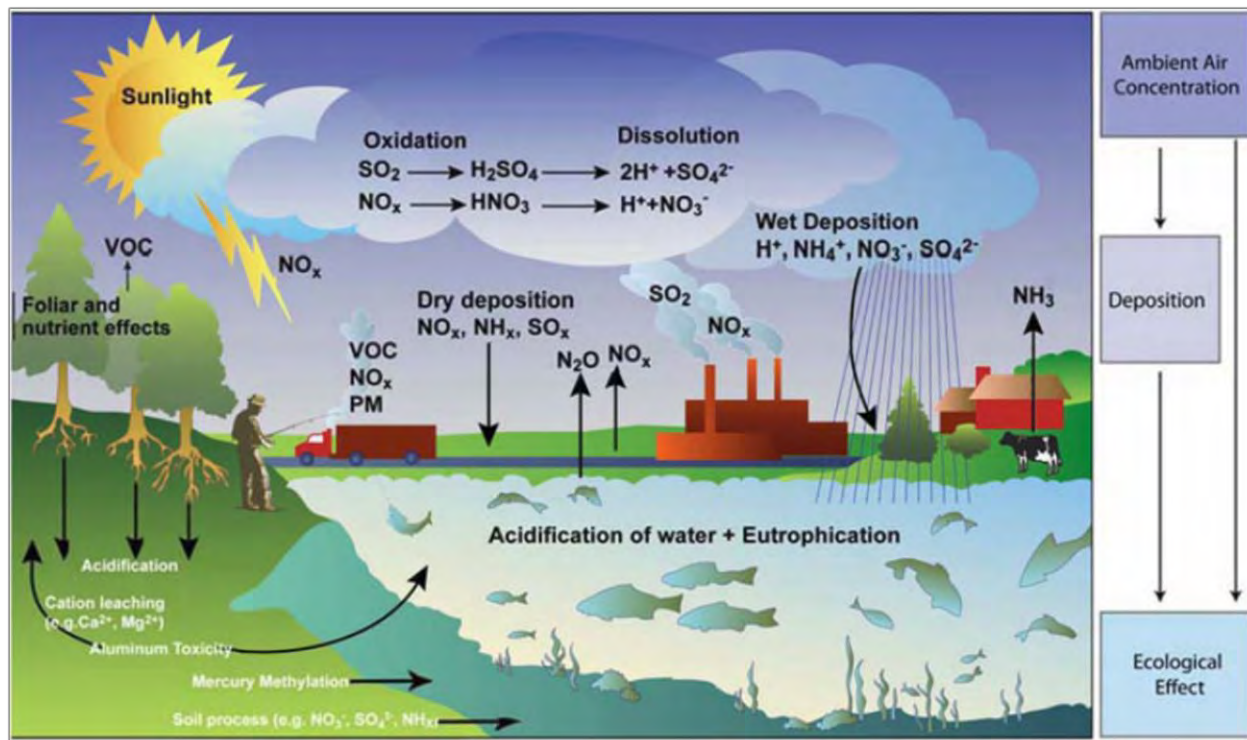


Figure 6-3: Nitrogen and Sulfur Cycling, and Interactions in the Environment.

#### 6.4.3.1.1 Ecological Effects of Acidification

Deposition of nitrogen and sulfur can cause acidification, which alters biogeochemistry and affects animal and plant life in terrestrial and aquatic ecosystems across the U.S. Soil acidification is a natural process, but is often accelerated by acidifying deposition, which can decrease concentrations of exchangeable base cations in soils. (U.S. EPA 2020) Biological effects of acidification in terrestrial ecosystems are generally linked to aluminum toxicity and decreased ability of plant roots to take up base cations. (U.S. EPA 2020) Decreases in the acid neutralizing capacity and increases in inorganic aluminum concentration contribute to declines in zooplankton, macro invertebrates, and fish species richness in aquatic ecosystems. (U.S. EPA 2020)

Geology (particularly surficial geology) is the principal factor governing the sensitivity of terrestrial and aquatic ecosystems to acidification from nitrogen and sulfur deposition. (U.S. EPA 2020) Geologic formations having low base cation supply generally underlie the watersheds of acid-sensitive lakes and streams. Other factors contribute to the sensitivity of soils and surface waters to acidifying deposition, including topography, soil chemistry, land use, and hydrologic flow path. (U.S. EPA 2020)

#### **6.4.3.1.1 Aquatic Acidification**

Aquatic effects of acidification have been well studied in the U.S. and elsewhere at various trophic levels. These studies indicate that aquatic biota have been affected by acidification at virtually all levels of the food web in acid sensitive aquatic ecosystems. Effects have been most clearly documented for fish, aquatic insects, other invertebrates, and algae. Biological effects are primarily attributable to a combination of low pH and high inorganic aluminum concentrations. Such conditions occur more frequently during rainfall and snowmelt that cause high flows of water, and less commonly during low-flow conditions, except where chronic acidity conditions are severe. Biological effects of episodes include reduced fish condition factor, changes in species composition, and declines in aquatic species richness across multiple taxa, ecosystems, and regions.

Because acidification primarily affects the diversity and abundance of aquatic biota, it also affects the ecosystem services, e.g., recreational and subsistence fishing, that are derived from the fish and other aquatic life found in these surface waters. For example, in the northeastern United States, the surface waters affected by acidification are a source of food for some recreational and subsistence fishermen and for other consumers with particularly high rates of self-caught fish consumption, such as the Hmong and Chippewa ethnic groups. (Hutchison 1994, Peterson, et al. 1994)

#### **6.4.3.1.2 Terrestrial Acidification**

Acidifying deposition has altered major biogeochemical processes in the U.S. by increasing the nitrogen and sulfur content of soils, accelerating nitrate and sulfate leaching from soil to drainage waters, depleting base cations (especially calcium and magnesium) from soils, and increasing the mobility of aluminum. Inorganic aluminum is toxic to some tree roots. Plants affected by high levels of aluminum from the soil often have reduced root growth, which restricts the ability of the plant to take up water and nutrients, especially calcium. (U.S. EPA 2020) These direct effects can, in turn, influence the response of these plants to climatic stresses such as droughts and cold temperatures. They can also influence the sensitivity of plants to other stresses, including insect pests and disease leading to increased mortality of canopy trees. (Joslin 1992) In the U.S., terrestrial effects of acidification are best described for forested ecosystems (especially red spruce and sugar maple ecosystems) with additional information on other plant communities, including shrubs and lichen. (U.S. EPA 2020)

Both coniferous and deciduous forests throughout the eastern U.S. have experienced gradual losses of base cation nutrients from the soil historically due to accelerated leaching from acidifying deposition. This change in cation availability may reduce the quality of forest nutrition over the long term. Evidence suggests that red spruce and sugar maple in some areas in the eastern U.S. have experienced declining health because of this deposition. For red spruce (*Picea rubens*), dieback or decline has been observed across high elevation landscapes of the northeastern U.S. and, to a lesser extent, the southeastern U.S., and acidifying deposition has been implicated as a causal factor. (DeHayes, et al. 1999)

### **6.4.3.1.2 Ecological Effects from Nitrogen Enrichment**

#### **6.4.3.1.2.1 Aquatic Enrichment**

Eutrophication in estuaries is associated with a range of adverse ecological effects including low dissolved oxygen (DO), harmful algal blooms (HABs), loss of submerged aquatic vegetation (SAV), and low water clarity. Low DO disrupts aquatic habitats, causing stress to fish and shellfish, which, in the short-term, can lead to episodic fish kills and, in the long-term, can damage overall growth in fish and shellfish populations. In addition to often being toxic to fish and shellfish and leading to fish kills and aesthetic impairments of estuaries, HABs can, in some instances, also be harmful to human health. SAV provides critical habitat for many aquatic species in estuaries and, in some instances, can also protect shorelines by reducing wave strength; therefore, declines in SAV due to nutrient enrichment are an important source of concern. Low water clarity is in part the result of accumulations of both algae and sediments in estuarine waters. In addition to contributing to declines in SAV, high levels of turbidity also degrade the aesthetic qualities of the estuarine environment.

In estuaries, nitrogen from the atmosphere and other sources contributes to increased primary productivity leading to eutrophication. An assessment of estuaries nationwide by the National Oceanic and Atmospheric Administration (NOAA) concluded that 64 estuaries (out of 99 with available data) suffered from moderate or high levels of eutrophication due to excessive inputs of both nitrogen (N) and phosphorus. (Bricker, et al. 2007) Source apportionment data in the 2008 NO<sub>x</sub>SO<sub>x</sub> ISA and the 2020 NO<sub>x</sub>SO<sub>x</sub>PM ISA indicate that atmospheric contributions to estuarine nitrogen are heterogeneous across the U.S., ranging from <10% to approximately 70% of total estuary nitrogen inputs. (U.S. EPA 2020) Estuaries are an important source of food production, in particular fish and shellfish. These complex systems are capable of supporting large stocks of resident commercial species, and they serve as the breeding grounds and interim habitat for several migratory species. Eutrophication in estuaries may also affect the demand for seafood (after well-publicized toxic blooms), water-based recreation, and erosion protection provided by SAV.

#### **6.4.3.1.2.2 Terrestrial Enrichment**

Terrestrial enrichment occurs when terrestrial ecosystems receive nitrogen loadings in excess of natural background levels, through either atmospheric deposition or direct application. Atmospheric nitrogen deposition is associated with changes in the types and number of species and biodiversity in terrestrial systems. This occurs because increased nitrogen affects competition between plant species, with certain species responding in growth more vigorously than others, leading to overall declines in species richness. Nitrogen enrichment occurs over a long time period; as a result, it may take as many as 50 years or more to see changes in ecosystem conditions and indicators. One of the main provisioning services potentially affected by nitrogen deposition is grazing opportunities offered by grasslands for livestock production in the Central U.S. Although nitrogen deposition on these grasslands can offer supplementary nutritive value and promote overall grass production, there are concerns that fertilization may favor invasive grasses and shift the species composition away from native grasses. This process may ultimately reduce the productivity of grasslands for livestock production.

Terrestrial enrichment also affects habitats, for example the Coastal Sage Scrub (CSS) and Mixed Conifer Forest (MCF) habitats which are an integral part of the California landscape.

Together the ranges of these habitats include the densely populated and valuable coastline and the mountain areas. Numerous threatened and endangered species at both the state and federal levels reside in CSS and MCF. Nutrient enrichment can also increase fire risk by encouraging the growth of more flammable, non-native grasses, thereby increasing the fuel load and increasing fire frequency.

#### **6.4.3.1.3 Vegetation Effects Associated with Gaseous Sulfur Dioxide, Nitric Oxide, Nitrogen Dioxide, Peroxyacetyl Nitrate, and Nitric Acid**

Uptake of gaseous pollutants in a plant canopy is a complex process involving adsorption to surfaces (leaves, stems, and soil) and absorption into leaves. These pollutants penetrate into leaves through the stomata, although there is evidence for limited pathways via the cuticle. (U.S. EPA 2020) Pollutants must be transported from the bulk air to the leaf boundary layer in order to reach the stomata. When the stomata are closed, as occurs under dark or drought conditions, resistance to gas uptake is very high and the plant has a very low degree of susceptibility to injury. In contrast, mosses and lichens do not have a protective cuticle barrier to gaseous pollutants or stomata and are generally more sensitive to gaseous sulfur and nitrogen than vascular plants. (U.S. EPA 2020)

Acute foliar injury from SO<sub>2</sub> usually happens within hours of exposure, involves a rapid absorption of a toxic dose, and involves collapse or necrosis of plant tissues. Another type of visible injury is termed chronic injury and is usually a result of variable SO<sub>2</sub> exposures over the growing season. Besides foliar injury, chronic exposure to low SO<sub>2</sub> concentrations can result in reduced photosynthesis, growth, and yield of plants. (U.S. EPA 2022) These effects are cumulative over the season and are often not associated with visible foliar injury. As with foliar injury, these effects vary among species and growing environment. SO<sub>2</sub> is also considered the primary factor causing the death of lichens in many urban and industrial areas. (Hutchinson, Maynard and Geiser 1996)

Similarly, in sufficient concentrations, nitric oxide (NO), nitrogen dioxide (NO<sub>2</sub>), peroxyacetyl nitrate (PAN), and nitric acid (HNO<sub>3</sub>) can have phytotoxic effects on plants such as decreasing photosynthesis and inducing visible foliar injury. It is also known that these gases can alter the nitrogen cycle in some ecosystems, especially in the western U.S., and contribute to nitrogen saturation. Further, there are several lines of evidence that past and current HNO<sub>3</sub> concentrations may be contributing to the decline in lichen species in the Los Angeles basin. (Riddell, Nash and Padgett 2008)

#### **6.4.3.1.4 Mercury Methylation**

Mercury is a persistent, bioaccumulative toxic metal that is emitted in three forms: gaseous elemental Hg (Hg<sup>0</sup>), oxidized Hg compounds (Hg<sup>+2</sup>), and particle-bound Hg (HgP). Methylmercury (MeHg) is formed by microbial action in the top layers of sediment and soils after Hg has precipitated from the air and deposited into waterbodies or land. Once formed, MeHg is taken up by aquatic organisms and bioconcentrates up the aquatic food web. Larger predatory fish may have MeHg concentrations many times higher, typically on the order of one million times, than the concentrations in the freshwater body in which they live. The NO<sub>x</sub> SO<sub>x</sub> ISA—Ecological Criteria concluded that evidence is sufficient to infer a causal relationship between sulfur deposition and increased mercury methylation in wetlands and aquatic environments. (U.S. EPA 2020) Specifically, there appears to be a relationship between SO<sub>4</sub><sup>2-</sup>

deposition and mercury methylation; however, the rate of mercury methylation varies according to several spatial and biogeochemical factors whose influence has not been fully quantified. Therefore, the correlation between  $\text{SO}_4^{2-}$  deposition and MeHg cannot yet be quantified for the purpose of interpolating the association across waterbodies or regions. Nevertheless, because changes in MeHg in ecosystems represent changes in significant human and ecological health risks, the association between sulfur and mercury cannot be neglected. (U.S. EPA 2020)

#### **6.4.3.2 Deposition of Metallic and Organic Constituents of PM**

Several significant ecological effects are associated with the deposition of chemical constituents of ambient PM such as metals and organics. (U.S. EPA 2020, U.S. EPA 2009) The trace metal constituents of PM can include cadmium, copper, chromium, mercury, nickel, zinc, and lead. Organic pollutants that may be associated with PM encompass several chemical classes including persistent organic pollutants (POPs), polyaromatic hydrocarbons (PAHs), and polybrominated diphenyl ethers (PBDEs). Direct effects of exposures to PM may occur via deposition (e.g., wet, dry or occult) to vegetation surfaces, while indirect exposure may occur via deposition to soils or surface waters where the deposited constituents of PM then interact with biota residing in these ecosystems. While both fine and coarse-mode particles have the potential to affect plants and other organisms, more often the chemical constituents drive the ecosystem response to PM. (Grantz, Garner and Johnson 2003) Ecological effects of PM include direct effects on plant foliage and indirect effects such as contribution to total metal loading resulting in alteration of soil biogeochemistry and microbial communities, reduced growth and reproduction in plants and animals, and contribution to total loading of organics which bioaccumulate and biomagnify in terrestrial and aquatic biota.

Particulate matter can adversely impact plants and ecosystem services provided by plants by deposition to vegetative surfaces. (U.S. EPA 2020, U.S. EPA 2009) Particulates deposited on the surfaces of leaves and needles can alter plant metabolism and photosynthesis by the blocking of sunlight. PM deposition near sources of heavy deposition can obstruct stomata (limiting gas exchange), and damage leaf surfaces. (U.S. EPA 2020, U.S. EPA 2009) Plants growing on roadsides exhibit impact damage from near-road PM deposition, having higher levels of organics and heavy metals, and accumulating salt from road de-icing during winter months. (U.S. EPA 2020) In addition, atmospheric PM can scatter direct solar radiation to diffuse radiation. (U.S. EPA 2020) Decreases in crop yields (a provisioning ecosystem service) due to reductions in solar radiation have been attributed to regional scale air pollution in counties with especially severe regional haze. (Chameides, et al. 1999)

In addition to damage to plant surfaces, deposited PM can be taken up by plants from soil or foliage. (U.S. EPA 2020, U.S. EPA 2009) Copper, zinc, and nickel have been shown to be directly toxic to vegetation under field conditions. (U.S. EPA 2020) The ability of vegetation to take up heavy metals is dependent upon the amount, solubility, and chemical composition of the deposited PM. Uptake of PM by plants from soils and vegetative surfaces can disrupt photosynthesis, alter pigments and mineral content, reduce plant vigor, decrease frost hardiness, and impair root development.

Particulate matter can also contain organic air toxic pollutants, including PAHs, which are a class of polycyclic organic matter (POM). PAHs can accumulate in soils, sediments, flora, and fauna. The bioavailability of PM-associated organics is dependent upon the physical, chemical, and biological conditions under which an organism is exposed at a particular geographic



location. (U.S. EPA 2020) Different species can have different uptake rates of PAHs. Biomagnification of organics has been extensively documented in aquatic and terrestrial ecosystems for several decades, and these compounds are detected in biota at remote locations due to long-range atmospheric transport processes. (U.S. EPA 2020)

Contamination of plant leaves by heavy metals can lead to elevated concentrations in the soil. Trace metals absorbed into the plant, frequently by binding to the leaf tissue, and then are shed when the leaf drops. As the fallen leaves decompose, the heavy metals are transferred into the soil. (Cotrufo, et al. 1995, Niklinska, Laskowski and Maryanski 1998) Many of the major indirect plant responses to PM deposition are chiefly soil-mediated and depend on the chemical composition of individual components of deposited PM. Upon entering the soil environment, PM pollutants can alter ecological processes of energy flow and nutrient cycling, inhibit nutrient uptake to plants, change microbial community structure, and affect biodiversity. Accumulation of heavy metals in soils depends on factors such as local soil characteristics, geologic origin of parent soils, and metal bioavailability. Heavy metals such as zinc, copper, and cadmium, and some pesticides can interfere with microorganisms that are responsible for decomposition of soil litter, an important regulating ecosystem service that serves as a source of soil nutrients. (U.S. EPA 2020) Surface litter decomposition is reduced in soils having high metal concentrations. Soil communities have associated bacteria, fungi, and invertebrates that are essential to soil nutrient cycling processes. Changes to the relative species abundance and community composition are associated with deposited PM to soil biota. (U.S. EPA 2020)

Atmospheric deposition can be the primary source of some organics and metals to watersheds. Deposition of PM to surfaces in urban settings increases the metal and organic component of storm water runoff. (U.S. EPA 2020) This atmospherically-associated pollutant burden can then be toxic to aquatic biota. The contribution of atmospherically deposited PAHs to aquatic food webs was demonstrated in high elevation mountain lakes with no other anthropogenic contaminant sources. (U.S. EPA 2020) Metals associated with PM deposition limit phytoplankton growth, affecting aquatic trophic structure. The Western Airborne Contaminants Assessment Project (WACAP) collected data on contaminant transport and PM depositional effects on sensitive ecosystems in the Western U.S. (Landers, et al. 2008) In this project, the transport, fate, and ecological impacts of anthropogenic contaminants from atmospheric sources were assessed from 2002 to 2007 in seven ecosystem components (air, snow, water, sediment, lichen, conifer needles, and fish) in eight core national parks. The study concluded that bioaccumulation of semi-volatile organic compounds occurred throughout park ecosystems, an elevational gradient in PM deposition exists with greater accumulation in higher altitude areas, and contaminants accumulate in proximity to individual agriculture and industry sources, which is counter to the original working hypothesis that most of the contaminants would originate from Eastern Europe and Asia.

#### **6.4.3.3 Materials Damage and Soiling**

Building materials including metals, stones, cements, and paints undergo natural weathering processes from exposure to environmental elements (e.g., wind, moisture, temperature fluctuations, sunlight, etc.). Pollution can worsen and accelerate these effects. Deposition of PM is associated with both physical damage (materials damage effects) and impaired aesthetic qualities (soiling effects). Wet and dry deposition of PM can physically affect materials, adding to the effects of natural weathering processes, by potentially promoting or accelerating the

corrosion of metals, degrading paints and deteriorating building materials such as stone, concrete and marble. (U.S. EPA 2020, U.S. EPA 2022) The effects of PM are exacerbated by the presence of acidic gases and can be additive or synergistic depending on the complex mixture of pollutants in the air and surface characteristics of the material. Acidic deposition has been shown to have an effect on materials including zinc/galvanized steel and other metal, carbonate stone (such as monuments and building facings), and surface coatings (paints). (Irving 1991) The effects on historic buildings and outdoor works of art are of particular concern because of the uniqueness and irreplaceability of many of these objects. In addition to aesthetic and functional effects on metals, stone, and glass, altered energy efficiency of photovoltaic panels by PM deposition is also becoming an important consideration for impacts of air pollutants on materials.

#### **6.4.4 Welfare Effects of Air Toxics**

Emissions from producing, transporting, and combusting fuel contribute to ambient levels of pollutants that contribute to adverse effects on vegetation. VOCs, some of which are considered air toxics, have long been suspected to play a role in vegetation damage. (U.S. EPA 1991) In laboratory experiments, a wide range of tolerance to VOCs has been observed. (Cape, et al. 2003) Decreases in harvested seed pod weight have been reported for the more sensitive plants, and some studies have reported effects on seed germination, flowering, and fruit ripening. Effects of individual VOCs or their role in conjunction with other stressors (e.g., acidification, drought, temperature extremes) have not been well studied. In a recent study of a mixture of VOCs including ethanol and toluene on herbaceous plants, significant effects on seed production, leaf water content, and photosynthetic efficiency were reported for some plant species. (Cape, et al. 2003)

Research suggests an adverse impact of vehicle exhaust on plants, which has in some cases been attributed to aromatic compounds and in other cases to NO<sub>x</sub>. (Viskari 2000, Ugrekheldze, Korte and Kvesitadze 1997, Kammerbauer, et al. 1987) The impacts of VOCs on plant reproduction may have long-term implications for biodiversity and survival of native species near major roadways. Most of the studies of the impacts of VOCs on vegetation have focused on short-term exposure and few studies have focused on long-term effects of VOCs on vegetation and the potential for metabolites of these compounds to affect herbivores or insects.

#### **6.5 Criteria Pollutant Human Health Benefits**

The light-duty passenger cars and light trucks and medium-duty vehicles subject to the final standards are significant sources of mobile source air pollution, including directly-emitted PM<sub>2.5</sub> as well as NO<sub>x</sub> and VOC emissions (both precursors to ozone formation and secondarily-formed PM<sub>2.5</sub>). The final program will reduce exhaust emissions of these pollutants from the regulated vehicles, which will in turn reduce ambient concentrations of ozone and PM<sub>2.5</sub>. Emissions from upstream sources will likely increase in some cases (e.g., power plants) and decrease in others (e.g., refineries). We project that in total, the final standards will result in substantial net reductions of emissions of pollutants like PM<sub>2.5</sub>, NO<sub>x</sub>, and VOCs and a net increase in emissions of SO<sub>2</sub>. Emissions changes attributable to the final standards are presented in Chapter 8 of the RIA. Exposures to ambient pollutants such as PM<sub>2.5</sub> and ozone are linked to adverse environmental and human health impacts, such as premature deaths and non-fatal illnesses (as explained in Chapters 6.2 and 6.3). Reducing human exposure to these pollutants results in significant and measurable health benefits.

Changes in ambient concentrations of ozone, PM<sub>2.5</sub>, and air toxics that will result from the standards are expected to improve human health by reducing premature deaths and other serious human health effects, and they are also expected to result in other important improvements in public health and welfare (see Chapters 6.2 and 6.3). Children, especially, benefit from reduced exposures to criteria and toxic pollutants because they tend to be more sensitive to the effects of these respiratory pollutants. Ozone and particulate matter have been associated with increased incidence of asthma and other respiratory effects in children, and particulate matter has been associated with a decrease in lung maturation.

This section discusses the economic benefits from reductions in adverse health and environmental impacts resulting from criteria pollutant emission reductions that can be expected to occur as a result of the final emission standards. When feasible, EPA conducts full-scale photochemical air quality modeling to demonstrate how its national mobile source regulatory actions affect ambient concentrations of regional pollutants throughout the United States. The estimation of the human health impacts of a regulatory action requires national-scale photochemical air quality modeling to conduct a full-scale assessment of PM<sub>2.5</sub> and ozone-related health benefits.

EPA conducted an air quality modeling analysis of a regulatory scenario involving light- and medium-duty vehicle emission reductions and corresponding changes in “upstream” emission sources like EGU (electric generating unit) emissions and refinery emissions (see RIA Chapter 8). Decisions about the emissions and other elements used in the air quality modeling were made early in the analytical process for this rulemaking. Accordingly, the air quality analysis reflects the impacts of a policy scenario that is slightly different than the final standards, however, we view the results of the modeling analysis as the best representation of the final rulemaking's impacts on PM<sub>2.5</sub> and ozone in 2055. For a complete description of the modeled air quality scenario and the results of that analysis, including a full analysis of PM<sub>2.5</sub>- and ozone-related health benefits in 2055, see Chapter 7. Because the air quality analysis was only conducted for one future year (2055), a year when the regulatory scenario will be fully implemented and when most of the regulated fleet will have turned over, we used the OMEGA-based emissions analysis (see RIA Chapter 8) and benefit-per-ton (BPT) values to estimate the criteria pollutant (PM<sub>2.5</sub>) health benefits of the final and alternative standards.

The BPT approach estimates the monetized economic value of PM<sub>2.5</sub>-related emission reductions or increases (such as direct PM, NO<sub>x</sub>, and SO<sub>2</sub>) due to implementation of the final program. Similar to the SC-GHG approach for monetizing reductions in GHGs, the BPT approach monetizes health benefits of avoiding one ton of PM<sub>2.5</sub>-related emissions from a particular onroad mobile or upstream source. The value of health benefits from reductions (or increases) in PM<sub>2.5</sub> emissions associated with the standards were estimated by multiplying PM<sub>2.5</sub>-related BPT values by the corresponding annual reduction (or increase) in tons of directly-emitted PM<sub>2.5</sub> and PM<sub>2.5</sub> precursor emissions (NO<sub>x</sub> and SO<sub>2</sub>).

The BPT approach monetizes avoided premature deaths and illnesses that are expected to occur as a result of reductions in directly-emitted PM<sub>2.5</sub> and PM<sub>2.5</sub> precursors. A chief limitation to using PM<sub>2.5</sub>-related BPT values is that they do not reflect benefits associated with reducing ambient concentrations of ozone, direct exposure to NO<sub>2</sub>, or exposure to mobile source air toxics, nor do they account for improved ecosystem effects or visibility. The estimated benefits

of the standards would be larger if we were able to monetize these unquantified benefits at this time.

Using the BPT approach, we estimate the annualized value of PM<sub>2.5</sub>-related benefits for the final program between 2027 and 2055 (discounted back to 2027) is \$5.3 to \$11 billion assuming a 3-percent discount rate and \$3.7 to \$7.2 billion assuming a 7-percent discount rate. Benefits are reported in year 2022 dollars and reflect the PM<sub>2.5</sub>-related benefits associated with reductions in NO<sub>x</sub>, SO<sub>2</sub>, and direct PM<sub>2.5</sub> emissions. Because premature mortality typically constitutes the vast majority of monetized benefits in a PM<sub>2.5</sub> benefits assessment, we present a range of PM benefits based on risk estimates reported from two different long-term exposure studies using different cohorts to account for uncertainty in the benefits associated with avoiding PM-related premature deaths. Tables of the monetized PM<sub>2.5</sub>-related benefits of the standards can be found in RIA Chapter 9.

### **6.5.1 Approach to Estimating Human Health Benefits**

This section summarizes EPA's approach to estimating the economic value of the PM<sub>2.5</sub>-related benefits for this rulemaking. We use a BPT approach that is conceptually consistent with EPA's use of BPT estimates in its regulatory analyses (U.S. EPA 2018) (U.S. EPA 2023). In this approach, the PM<sub>2.5</sub>-related BPT values are the total monetized human health benefits (the sum of the economic value of the reduced risk of premature death and illness) that are expected from reducing one ton of NO<sub>x</sub>, SO<sub>2</sub>, or directly-emitted PM<sub>2.5</sub>.

The mobile sector BPT estimates used in this analysis were published in 2019 but have been updated to be consistent with the health benefits Technical Support Document (Benefits TSD) that accompanied the 2023 PM NAAQS Reconsideration Proposal. (Wolfe, et al. 2019) (U.S. EPA 2022) (U.S. EPA 2023). The Benefits TSD details the approach used to estimate the PM<sub>2.5</sub>-related benefits reflected in these BPTs. The upstream Refinery and EGU BPT estimates used in this analysis were also recently updated to be consistent with the Benefits TSD (U.S. EPA 2023). We multiply these BPT values by national reductions in annual emissions in tons to estimate the total monetized human health benefits associated with the standards.

Our procedure for calculating BPT values follows three steps:

1. Using source apportionment photochemical modeling, predict annual average ambient concentrations of NO<sub>x</sub>, SO<sub>2</sub>, and primary PM<sub>2.5</sub> that are attributable to each source sector (Onroad Heavy-Duty Diesel, Onroad Heavy Duty Gas, Refineries, and Electricity Generating Units), for the Continental U.S. (48 states). This yields the estimated ambient pollutant concentrations to which the U.S. population is exposed.

2. For each sector, estimate the health impacts, and economic value of those impacts, associated with the attributable ambient concentrations of NO<sub>x</sub>, SO<sub>2</sub>, and primary PM<sub>2.5</sub> using the environmental Benefits Mapping and Analysis Program-Community Edition (BenMAP-CE)

(U.S. EPA 2023).<sup>233</sup> This yields the estimated total monetized value of health effects associated with exposure to the relevant pollutants by sector.

3. For each sector, divide the monetary value of health impacts by the inventory of associated precursor emissions. That is, primary PM<sub>2.5</sub> benefits for a given sector are divided by direct PM<sub>2.5</sub> emissions from that same sector, sulfate benefits are divided by SO<sub>2</sub> emissions, and nitrate benefits are divided by NO<sub>x</sub> emissions. This yields the estimated monetary value of one ton of sector-specific direct PM<sub>2.5</sub>, SO<sub>2</sub>, or NO<sub>x</sub> emissions.

The quantified and monetized PM<sub>2.5</sub> health categories that are included in the BPT values are summarized in Table 6-2.

Chapter 7.4.6 lists the ozone, PM<sub>2.5</sub>, SO<sub>2</sub>, and NO<sub>x</sub> health and welfare categories that are not quantified and monetized by the BPT approach and are therefore not included in the estimated benefits analysis for this rulemaking.

---

<sup>233</sup> BenMAP-CE is an open-source computer program developed by the EPA that calculates the number and economic value of air pollution-related deaths and illnesses. The software incorporates a database that includes many of the concentration-response relationships, population files, and health and economic data needed to quantify these impacts. Information on BenMAP is found at: <https://www.epa.gov/benmap/benmap-community-edition>, and the source code is available at: <https://github.com/BenMAPCE/BenMAP-CE>.

**Table 6-2 Human Health Effects of PM<sub>2.5</sub>**

| Pollutant  | Effect (age)  | Effect Quantified | Effect Monetized    | More Information    |
|--|---|-------------------|---------------------|---------------------|
| PM <sub>2.5</sub>  | Adult premature mortality based on cohort study estimates (>17 or >64)        | ✓                 | ✓                   | PM ISA              |
|  | Infant mortality (<1)   | ✓                 | ✓                   | PM ISA              |
|  | Non-fatal heart attacks (>18)   | ✓                 | ✓                   | PM ISA              |
|  | Hospital admissions - cardiovascular (all)                                    | ✓                 | ✓                   | PM ISA              |
|  | Hospital admissions - respiratory (<19 and >64)                               | ✓                 | ✓                   | PM ISA              |
|  | Hospital admissions - Alzheimer's disease (>64)                               | ✓                 | ✓                   | PM ISA              |
|  | Hospital admissions - Parkinson's disease (>64)                               | ✓                 | ✓                   | PM ISA              |
|  | Emergency department visits – cardiovascular (all)                            | ✓                 | ✓                   | PM ISA              |
|  | Emergency department visits – respiratory (all)                               | ✓                 | ✓                   | PM ISA              |
|  | Emergency hospital admissions (>65)   | ✓                 | ✓                   | PM ISA              |
|  | Non-fatal lung cancer (>29)   | ✓                 | ✓                   | PM ISA              |
|  | Stroke incidence (50-79)  | ✓                 | ✓                   | PM ISA              |
|  | New onset asthma (<12)  | ✓                 | ✓                   | PM ISA              |
|  | Exacerbated asthma – albuterol inhaler use (asthmatics, 6-13)                 | ✓                 | ✓                   | PM ISA              |
|  | Lost work days (18-64)  | ✓                 | ✓                   | PM ISA              |
|  | Other cardiovascular effects (e.g., doctor's visits, prescription medication) | —                 | —                   | PM ISA <sup>1</sup> |
|  | Other respiratory effects (e.g., pulmonary function, other ages)              | —                 | —                   | PM ISA <sup>1</sup> |
|  | Other cancer effects (e.g., mutagenicity, genotoxicity)                       | —                 | —                   | PM ISA <sup>1</sup> |
|  | Other nervous system effects (e.g., dementia)                                 | —                 | —                   | PM ISA <sup>1</sup> |
|  | Metabolic effects (e.g., diabetes, metabolic syndrome)                        | —                 | —                   | PM ISA <sup>1</sup> |
| Reproductive and developmental effects (e.g., low birth weight, pre-term births) | —   | —                 | PM ISA <sup>1</sup> |                     |

<sup>1</sup> We assess these benefits qualitatively due to epidemiological or economic data limitations.

Of the PM-related health endpoints listed in Table 6-2, EPA estimates the incidence of air pollution effects for only those classified as either "causal" or "likely-to-be-causal" in the 2019 PM Integrated Science Assessment (ISA) and the 2022 PM ISA update (U.S. EPA 2019) (U.S. EPA 2022).<sup>234</sup> The full complement of human health effects associated with PM remains unquantified because of current limitations in methods or available data. Thus, our quantified PM-related benefits omit a number of known or suspected health effects linked with PM, either because appropriate health impact functions are not available or because outcomes are not easily interpretable (e.g., changes in heart rate variability).

<sup>234</sup> The ISA synthesizes the toxicological, clinical, and epidemiological evidence to determine whether each pollutant is causally related to an array of adverse human health outcomes associated with either acute (i.e., hours- or days-long) or chronic (i.e. years-long) exposure. For each outcome, the ISA reports this relationship to be causal, likely to be causal, suggestive of a causal relationship, inadequate to infer a causal relationship, or not likely to be a causal relationship.

We anticipate the standards will also yield benefits from reduced exposure to ambient concentrations of ozone. However, the complex, non-linear photochemical processes that govern ozone formation prevent us from developing reduced-form ozone BPT values for mobile sources. The BPT approach also omits health effects associated with ambient concentrations of NO<sub>2</sub> as well as criteria pollutant-related welfare effects such as improvements in visibility, reductions in materials damage, ecological effects from reduced PM deposition, ecological effects from reduced nitrogen emissions, and vegetation effects from reduced ozone exposure.

We also do not provide estimated monetized benefits due to reductions in mobile source air toxics. This is primarily because currently available tools and methods to assess air toxics risk from mobile sources at the national scale are not adequate for extrapolation to incidence estimation or benefits assessment.

### **6.5.2 Estimating PM<sub>2.5</sub>-attributable Adult Premature Death**

Of the PM<sub>2.5</sub>-related health endpoints listed in Table 6-2, adult premature deaths typically account for the majority of total monetized PM benefits and are thus the primary component of the PM<sub>2.5</sub>-related BPT values. In this section, we provide more detail on PM mortality effect coefficients and the concentration-response functions that underlie the BPT values.

A substantial body of published scientific literature documents the association between PM<sub>2.5</sub> concentrations and the risk of premature death (U.S. EPA 2019) (U.S. EPA 2022). This body of literature reflects thousands of epidemiology, toxicology, and clinical studies. The PM ISA, completed as part of the review of the recently finalized PM NAAQS Reconsideration and reviewed by the Clean Air Scientific Advisory Committee (CASAC) (Sheppard 2022), concluded that there is a causal relationship between mortality and both long-term and short-term exposure to PM<sub>2.5</sub> based on the full body of scientific evidence. The size of the mortality effect estimates from epidemiologic studies, the serious nature of the effect itself, and the high monetary value ascribed to prolonging life make mortality risk reduction the most significant health endpoint quantified in this analysis. EPA selects Hazard Ratios<sup>235</sup> from cohort studies to estimate counts of PM-related premature death, following a systematic approach detailed in the Benefits TSD.

For adult PM-related mortality, the BPT values are based on the risk estimates from two alternative long-term exposure mortality studies: the National Health Interview Survey (NHIS) cohort study (Pope III et al. 2019) and an extended analysis of the Medicare cohort (Wu et al. 2020). In past analyses, EPA has used two alternate estimates of mortality: one from the American Cancer Society cohort and one from the Medicare cohort (Turner 2016) (Di 2017) respectively. We use a risk estimate from the Pope III et al., 2019 study in place of the risk estimate from the Turner et al., 2016 analysis, as it: (1) includes a longer follow-up period that includes more recent (and lower) PM<sub>2.5</sub> concentrations; (2) the NHIS cohort is more representative of the U.S. population than is the ACS cohort with respect to the distribution of individuals by race, ethnicity, income, and education.

---

<sup>235</sup> A Hazard Ratio is a measure of how often a particular event happens in one group compared to how often it happens in another group, such as mortality associated with exposure to PM<sub>2.5</sub>.

Based on the 2022 Supplement to the PM ISA, EPA substituted a risk estimate from Wu et al., 2020 in place of a risk estimate from Di et al., 2017. These two epidemiologic studies share many attributes, including the cohort and model used to characterize population exposure to PM<sub>2.5</sub>. As compared to Di et al., 2017, Wu et al., 2020 includes a longer follow-up period and reflects more recent PM<sub>2.5</sub> concentrations.

The PM ISA also concluded that the scientific literature supports the use of a no-threshold log-linear model to portray the PM-mortality concentration-response relationship while recognizing potential uncertainty about the exact shape of the concentration-response relationship. The 2019 PM ISA, which informed the final 2024 PM NAAQS Reconsideration, reviewed available studies that examined the potential for a population-level threshold to exist in the concentration-response relationship. Based on such studies, the ISA concluded that “evidence from recent studies reduce uncertainties related to potential co-pollutant confounding and continues to provide strong support for a linear, no-threshold concentration-response relationship.” Consistent with this evidence, the Agency historically has estimated health impacts above and below the prevailing NAAQS.

### **6.5.3 Economic Value of Health Benefits**

The BPT values used in this analysis are a reduced-form approach for relating emission reductions to reductions in ambient concentrations of PM<sub>2.5</sub> and associated improvements in human health. Reductions in ambient concentrations of air pollution generally decrease the risk of future adverse health effects by a small amount for a large population. To monetize these benefits, the appropriate economic measure is willingness to pay (WTP) for changes in risk of a health effect. For some health effects, such as hospital admissions, WTP estimates are generally not available, so we use the cost of treating or mitigating the effect. These cost-of-illness (COI) estimates generally (although not necessarily in every case) understate the true value of reductions in risk of a health effect. They tend to reflect the direct expenditures related to treatment, but not the value of avoided pain and suffering from the health effect. The WTP and COI unit values for each endpoint are provided in the Benefits TSD. These unit values were used to monetize the underlying health effects included in the PM<sub>2.5</sub> BPT values.

Avoided premature deaths typically account for the majority of monetized PM<sub>2.5</sub>-related benefits. The economics literature concerning the appropriate methodology for valuing reductions in premature mortality risk is still developing and is the subject of continuing discussion within the economics and public policy analysis community. Following the advice of the SAB’s Environmental Economics Advisory Committee (SAB-EEAC), EPA currently uses the value of statistical life (VSL) approach in calculating estimates of mortality benefits. This calculation provides the most reasonable single estimate of an individual’s WTP for reductions in mortality risk (U.S. EPA-SAB 2000). The VSL approach is a summary measure for the value of small changes in mortality risk experienced by a large number of people.

EPA consulted several times with the SAB-EEAC on valuing mortality risk reductions and continues work to update the Agency's guidance on the issue. Until updated guidance is available, EPA determined that a single, peer-reviewed estimate applied consistently best reflects the SAB-EEAC advice we have received. Therefore, EPA applies the VSL that was vetted and endorsed by the SAB in the Agency's Guidelines for Preparing Economic Analyses (U.S. EPA 2016). This VSL value is the mean of the values reported in 26 labor market and contingent valuation studies published between 1974 and 1991. The mean VSL across these studies is \$4.8



million (1990\$). We then adjust this VSL to account for the currency year and to account for income growth from 1990 to the analysis year. Specifically, the VSL applied in this analysis in 2022 dollars after adjusting for income growth to 2022 is \$12.6 million.

EPA is committed to using scientifically sound, appropriately reviewed evidence in valuing changes in the risk of premature death and continues to engage with the SAB to identify scientifically sound approaches to update its mortality risk valuation estimates. Most recently, the Agency proposed new meta-analytic approaches for updating its estimates, which were subsequently reviewed by the SAB-EEAC (U.S. EPA 2017). EPA is taking the SAB's formal recommendations under advisement.

#### **6.5.4 Dollar Value per Ton of Directly-Emitted PM<sub>2.5</sub> and PM<sub>2.5</sub> Precursors**

The value of health benefits from reductions in PM<sub>2.5</sub> emissions associated with the standards were estimated by multiplying PM<sub>2.5</sub>-related BPT values by the corresponding annual reduction in tons of directly-emitted PM<sub>2.5</sub> and PM<sub>2.5</sub> precursor emissions (NO<sub>x</sub> and SO<sub>2</sub>). As explained above, the PM<sub>2.5</sub> BPT values represent the monetized value of human health benefits, including reductions in both premature mortality and nonfatal illnesses. Table 6-3 presents the PM<sub>2.5</sub> BPT values estimated from two different PM-related premature mortality cohort studies, Wu et al., 2020 (the Medicare cohort study) and Pope III et al., 2019 (the NHIS cohort study). The table reports different values by source and pollutant because different pollutant emissions do not equally contribute to ambient PM<sub>2.5</sub> formation and different emissions sources do not equally contribute to population exposure and associated health impacts. BPT values are also estimated using either a 3 percent or 7 percent discount rate to account for a “cessation” lag between the change in PM exposures and the total realization of changes in mortality effects. The source sectors include: onroad light-duty gasoline cars, onroad light-duty gasoline trucks, onroad light-duty diesel cars/trucks, electricity generating units, and refineries. We note that reductions in medium-duty vehicle emissions are monetized using light-duty BPT values.

Detailed tables of the monetized PM<sub>2.5</sub>-related benefits of the standards can be found in RIA Chapter 9.

**Table 6-3: PM<sub>2.5</sub>-related Benefit Per Ton values (2022\$) associated with the reduction of NO<sub>x</sub>, SO<sub>2</sub> and directly emitted PM<sub>2.5</sub> emissions for (A) Onroad light-duty gasoline cars, (B) Onroad light-duty gasoline trucks, (C) Onroad light-duty diesel cars/trucks, (D) Electricity Generating Units, and (E) Refineries.**

| <b>A. Onroad Light-Duty Gasoline Cars</b>      |                  |          |                  |          |                  |             |                  |             |                  |             |                  |             |
|--|------------------|----------|------------------|----------|------------------|-------------|------------------|-------------|------------------|-------------|------------------|-------------|
|  | NOX              |          |                  |          | SO2              |             |                  |             | Direct PM        |             |                  |             |
|  | 3% Discount Rate |          | 7% Discount Rate |          | 3% Discount Rate |             | 7% Discount Rate |             | 3% Discount Rate |             | 7% Discount Rate |             |
|  | Wu               | Pope     | Wu               | Pope     | Wu               | Pope        | Wu               | Pope        | Wu               | Pope        | Wu               | Pope        |
| 2025   | \$7,230          | \$15,400 | \$6,490          | \$13,800 | \$128,000        | \$274,000   | \$115,000        | \$246,000   | \$709,000        | \$1,520,000 | \$637,000        | \$1,360,000 |
| 2030   | \$8,160          | \$16,800 | \$7,330          | \$15,100 | \$147,000        | \$303,000   | \$132,000        | \$273,000   | \$814,000        | \$1,680,000 | \$731,000        | \$1,510,000 |
| 2035   | \$9,200          | \$18,500 | \$8,260          | \$16,600 | \$169,000        | \$341,000   | \$152,000        | \$307,000   | \$939,000        | \$1,890,000 | \$843,000        | \$1,700,000 |
| 2040   | \$10,100         | \$19,900 | \$9,050          | \$17,900 | \$191,000        | \$378,000   | \$172,000        | \$340,000   | \$1,060,000      | \$2,100,000 | \$953,000        | \$1,890,000 |
| 2045   | \$10,700         | \$21,000 | \$9,640          | \$18,900 | \$211,000        | \$413,000   | \$190,000        | \$371,000   | \$1,170,000      | \$2,290,000 | \$1,050,000      | \$2,060,000 |
| 2050   | \$11,200         | \$21,600 | \$10,000         | \$19,500 | \$229,000        | \$443,000   | \$206,000        | \$398,000   | \$1,270,000      | \$2,450,000 | \$1,140,000      | \$2,200,000 |
| 2055   | \$11,700         | \$22,500 | \$10,500         | \$20,300 | \$249,000        | \$477,000   | \$224,000        | \$429,000   | \$1,370,000      | \$2,630,000 | \$1,240,000      | \$2,360,000 |
| <b>B. Onroad Light-Duty Gasoline Trucks</b>    |                  |          |                  |          |                  |             |                  |             |                  |             |                  |             |
|  | NOX              |          |                  |          | SO2              |             |                  |             | Direct PM        |             |                  |             |
|  | 3% Discount Rate |          | 7% Discount Rate |          | 3% Discount Rate |             | 7% Discount Rate |             | 3% Discount Rate |             | 7% Discount Rate |             |
|  | Wu               | Pope     | Wu               | Pope     | Wu               | Pope        | Wu               | Pope        | Wu               | Pope        | Wu               | Pope        |
| 2025   | \$6,550          | \$13,900 | \$5,880          | \$12,500 | \$102,000        | \$219,000   | \$91,700         | \$197,000   | \$597,000        | \$1,280,000 | \$536,000        | \$1,150,000 |
| 2030   | \$7,400          | \$15,200 | \$6,640          | \$13,700 | \$117,000        | \$243,000   | \$105,000        | \$218,000   | \$685,000        | \$1,420,000 | \$615,000        | \$1,270,000 |
| 2035   | \$8,360          | \$16,800 | \$7,510          | \$15,100 | \$135,000        | \$272,000   | \$121,000        | \$245,000   | \$789,000        | \$1,590,000 | \$708,000        | \$1,430,000 |
| 2040   | \$9,190          | \$18,200 | \$8,250          | \$16,400 | \$152,000        | \$302,000   | \$137,000        | \$271,000   | \$889,000        | \$1,760,000 | \$798,000        | \$1,580,000 |
| 2045   | \$9,820          | \$19,200 | \$8,820          | \$17,300 | \$168,000        | \$329,000   | \$151,000        | \$296,000   | \$979,000        | \$1,910,000 | \$880,000        | \$1,720,000 |
| 2050   | \$10,300         | \$19,900 | \$9,220          | \$17,900 | \$182,000        | \$352,000   | \$163,000        | \$316,000   | \$1,060,000      | \$2,040,000 | \$950,000        | \$1,840,000 |
| 2055   | \$10,800         | \$20,800 | \$9,700          | \$18,700 | \$197,000        | \$378,000   | \$177,000        | \$340,000   | \$1,140,000      | \$2,190,000 | \$1,030,000      | \$1,970,000 |
| <b>C. Onroad Light-Duty Diesel Cars/Trucks</b> |                  |          |                  |          |                  |             |                  |             |                  |             |                  |             |
|  | NOX              |          |                  |          | SO2              |             |                  |             | Direct PM        |             |                  |             |
|  | 3% Discount Rate |          | 7% Discount Rate |          | 3% Discount Rate |             | 7% Discount Rate |             | 3% Discount Rate |             | 7% Discount Rate |             |
|  | Wu               | Pope     | Wu               | Pope     | Wu               | Pope        | Wu               | Pope        | Wu               | Pope        | Wu               | Pope        |
| 2025   | \$5,790          | \$12,300 | \$5,200          | \$11,100 | \$305,000        | \$655,000   | \$274,000        | \$589,000   | \$489,000        | \$1,050,000 | \$439,000        | \$942,000   |
| 2030   | \$6,550          | \$13,500 | \$5,880          | \$12,100 | \$349,000        | \$725,000   | \$314,000        | \$652,000   | \$560,000        | \$1,160,000 | \$503,000        | \$1,040,000 |
| 2035   | \$7,400          | \$14,900 | \$6,640          | \$13,400 | \$402,000        | \$813,000   | \$361,000        | \$731,000   | \$646,000        | \$1,300,000 | \$580,000        | \$1,170,000 |
| 2040   | \$8,130          | \$16,100 | \$7,310          | \$14,500 | \$453,000        | \$900,000   | \$407,000        | \$810,000   | \$728,000        | \$1,440,000 | \$654,000        | \$1,300,000 |
| 2045   | \$8,700          | \$17,000 | \$7,820          | \$15,300 | \$500,000        | \$980,000   | \$449,000        | \$882,000   | \$803,000        | \$1,570,000 | \$721,000        | \$1,410,000 |
| 2050   | \$9,100          | \$17,700 | \$8,180          | \$15,900 | \$541,000        | \$1,050,000 | \$486,000        | \$944,000   | \$868,000        | \$1,680,000 | \$780,000        | \$1,510,000 |
| 2055   | \$9,570          | \$18,400 | \$8,600          | \$16,600 | \$587,000        | \$1,130,000 | \$528,000        | \$1,010,000 | \$939,000        | \$1,800,000 | \$844,000        | \$1,620,000 |
| <b>D. Electricity Generating Units</b>         |                  |          |                  |          |                  |             |                  |             |                  |             |                  |             |
|  | NOX              |          |                  |          | SO2              |             |                  |             | Direct PM        |             |                  |             |
|  | 3% Discount Rate |          | 7% Discount Rate |          | 3% Discount Rate |             | 7% Discount Rate |             | 3% Discount Rate |             | 7% Discount Rate |             |
|  | Wu               | Pope     | Wu               | Pope     | Wu               | Pope        | Wu               | Pope        | Wu               | Pope        | Wu               | Pope        |
| 2025   | \$7,470          | \$15,800 | \$6,710          | \$14,200 | \$55,200         | \$118,000   | \$49,700         | \$106,000   | \$110,000        | \$235,000   | \$98,400         | \$211,000   |
| 2030   | \$8,370          | \$17,100 | \$7,530          | \$15,400 | \$62,300         | \$129,000   | \$56,000         | \$116,000   | \$125,000        | \$258,000   | \$112,000        | \$232,000   |
| 2035   | \$9,370          | \$18,700 | \$8,420          | \$16,900 | \$69,900         | \$141,000   | \$62,900         | \$127,000   | \$142,000        | \$287,000   | \$128,000        | \$258,000   |
| 2040   | \$10,200         | \$20,000 | \$9,130          | \$18,000 | \$76,400         | \$152,000   | \$68,700         | \$136,000   | \$158,000        | \$314,000   | \$142,000        | \$283,000   |
| <b>E. Refineries</b>                           |                  |          |                  |          |                  |             |                  |             |                  |             |                  |             |
|  | NOX              |          |                  |          | SO2              |             |                  |             | Direct PM        |             |                  |             |
|  | 3% Discount Rate |          | 7% Discount Rate |          | 3% Discount Rate |             | 7% Discount Rate |             | 3% Discount Rate |             | 7% Discount Rate |             |
|  | Wu               | Pope     | Wu               | Pope     | Wu               | Pope        | Wu               | Pope        | Wu               | Pope        | Wu               | Pope        |
| 2025   | \$22,500         | \$48,300 | \$20,200         | \$43,400 | \$49,600         | \$107,000   | \$44,500         | \$96,400    | \$358,000        | \$776,000   | \$322,000        | \$698,000   |
| 2030   | \$24,800         | \$51,500 | \$22,300         | \$46,300 | \$54,800         | \$114,000   | \$49,200         | \$103,000   | \$395,000        | \$826,000   | \$355,000        | \$743,000   |
| 2035   | \$28,500         | \$57,500 | \$25,600         | \$51,800 | \$62,700         | \$127,000   | \$56,400         | \$115,000   | \$453,000        | \$923,000   | \$407,000        | \$831,000   |
| 2040   | \$31,900         | \$63,300 | \$28,700         | \$56,900 | \$70,100         | \$140,000   | \$63,000         | \$126,000   | \$509,000        | \$1,020,000 | \$458,000        | \$915,000   |

Notes: All estimates are rounded to three significant figures. The benefit-per-ton estimates presented in this table assume either a 3 percent or 7 percent discount rate in the valuation of premature mortality to account for a twenty-year segmented cessation lag. Benefit-per-ton values were estimated for years 2025, 2030, 2035, 2040, 2045, 2050 and 2055 for mobile sources, and for years 2025, 2030, 2035 and 2040 for EGUs and refineries. We hold values constant for intervening years (e.g., the 2025 values are assumed to apply to years 2021-2024, and so on). We hold 2040 values constant out to 2055 for EGUs and Refineries.

### **6.5.5 Characterizing Uncertainty in the Estimated Benefits**

There are likely to be sources of uncertainty in any complex analysis using estimated parameters and inputs from numerous models, including this analysis. The Benefits TSD details our approach to characterizing uncertainty in both quantitative and qualitative terms. That TSD describes the sources of uncertainty associated with key input parameters including emissions inventories, air quality data from models (with their associated parameters and inputs), population data, population estimates, health effect estimates from epidemiology studies, economic data for monetizing benefits, and assumptions regarding the future state of the country (i.e., regulations, technology, and human behavior). Each of these inputs is uncertain and affects the size and distribution of the estimated benefits. When the uncertainties from each stage of the analysis are compounded, even small uncertainties can have large effects on the total quantified benefits.

The BPT approach is a simplified approach that relies on additional assumptions and has its own limitations, some of which are described in Chapter 6.5.6. Additional uncertainties related to key assumptions underlying the estimates for PM<sub>2.5</sub>-related premature mortality described in Section 6.3.1.2 of this chapter include the following:

- We assume that all fine particles, regardless of their chemical composition, are equally potent in causing premature mortality. This is an important assumption because PM<sub>2.5</sub> varies considerably in composition across sources, but the scientific evidence is not yet sufficient to allow differentiation of effect estimates by particle type. The PM ISA, which was reviewed by CASAC, concluded that “across exposure durations and health effects categories ... the evidence does not indicate that any one source or component is consistently more strongly related with health effects than PM<sub>2.5</sub> mass.” (U.S. EPA 2019)
- We assume that the health impact function for fine particles is log-linear down to the lowest air quality levels modeled in this analysis. Thus, the estimates include health benefits from reducing fine particles in areas with varied concentrations of PM<sub>2.5</sub>, including both regions that are in attainment with the fine particle standard and those that do not meet the standard down to the lowest modeled concentrations. The PM ISA concluded that “the majority of evidence continues to indicate a linear, no-threshold concentration-response relationship for long-term exposure to PM<sub>2.5</sub> and total (nonaccidental) mortality.” (U.S. EPA 2019)
- We assume that there is a “cessation” lag between the change in PM exposures and the total realization of changes in mortality effects. Specifically, we assume that some of the incidences of premature mortality related to PM<sub>2.5</sub> exposures occur in a distributed fashion over the 20 years following exposure based on the advice of the SAB-HES, which affects the valuation of mortality benefits at different discount rates. The above assumptions are subject to uncertainty (U.S. EPA-SAB 2005). Similarly, we assume there is a cessation lag between the change in PM exposures and both the development and diagnosis of lung cancer.

### **6.5.6 Benefit-per-Ton Estimate Limitations**

All BPT estimates have inherent limitations. One limitation of using the PM<sub>2.5</sub>-related BPT approach is an inability to provide estimates of the health and welfare benefits associated with exposure to ozone, welfare benefits, and some unquantified health benefits associated with PM<sub>2.5</sub>, as well as health and welfare benefits associated with ambient NO<sub>2</sub> and SO<sub>2</sub>.

Table 6-4 presents a selection of unquantified criteria pollutant health and welfare benefits categories. Another limitation is that the mobile sector-specific air quality modeling that underlies the PM<sub>2.5</sub> BPT values did not provide estimates of the PM<sub>2.5</sub>-related benefits associated with reducing VOC emissions, but these unquantified benefits are generally small compared to benefits associated with other PM<sub>2.5</sub> precursors.

**Table 6-4: Unquantified Health and Welfare Benefits Categories**

| Category  | Unquantified Effect  | More Information                     |
|---|--|--------------------------------------|
| <b>Improved Human Health</b>                                    |  |                                      |
| Nonfatal morbidity from exposure to ozone                       | Premature respiratory mortality from short-term exposure (0-99)  | Ozone ISA <sup>a</sup>               |
|   | Premature respiratory mortality from long-term exposure (age 30-99)  | Ozone ISA <sup>a</sup>               |
|   | Hospital admissions—respiratory (ages 65-99)   | Ozone ISA <sup>a</sup>               |
|   | Emergency department visits—respiratory (ages 0-99)  | Ozone ISA <sup>a</sup>               |
|   | Asthma onset (0-17)  | Ozone ISA <sup>a</sup>               |
|   | Asthma symptoms/exacerbation (asthmatics age 5-17)   | Ozone ISA <sup>a</sup>               |
|   | Allergic rhinitis (hay fever) symptoms (ages 3-17)   | Ozone ISA <sup>a</sup>               |
|   | Minor restricted-activity days (age 18-65)   | Ozone ISA <sup>a</sup>               |
|   | School absence days (age 5-17)   | Ozone ISA <sup>a</sup>               |
|   | Decreased outdoor worker productivity (age 18-65)  | Ozone ISA <sup>b</sup>               |
|   | Metabolic effects (e.g., diabetes)   | Ozone ISA <sup>b</sup>               |
|   | Other respiratory effects (e.g., premature aging of lungs)   | Ozone ISA <sup>b</sup>               |
|   | Cardiovascular and nervous system effects  | Ozone ISA <sup>b</sup>               |
|   | Reproductive and developmental effects   | Ozone ISA <sup>b</sup>               |
| Reduced incidence of morbidity from exposure to NO <sub>2</sub> | Asthma hospital admissions   | NO <sub>2</sub> ISA <sup>a</sup>     |
|   | Chronic lung disease hospital admissions   | NO <sub>2</sub> ISA <sup>a</sup>     |
|   | Respiratory emergency department visits  | NO <sub>2</sub> ISA <sup>a</sup>     |
|   | Asthma exacerbation  | NO <sub>2</sub> ISA <sup>a</sup>     |
|   | Acute respiratory symptoms   | NO <sub>2</sub> ISA <sup>a</sup>     |
|   | Premature mortality  | NO <sub>2</sub> ISA <sup>a,b,c</sup> |
|   | Other respiratory effects (e.g., airway hyperresponsiveness and inflammation, lung function, other ages and populations)             | NO <sub>2</sub> ISA <sup>b,c</sup>   |
| <b>Improved Environment</b>                                     |  |                                      |
| Reduced visibility impairment                                   | Visibility in Class 1 areas  | PM ISA <sup>a</sup>                  |
|   | Visibility in residential areas  | PM ISA <sup>a</sup>                  |
| Reduced effects on materials                                    | Household soiling  | PM ISA <sup>a,b</sup>                |
|   | Materials damage (e.g., corrosion, increased wear)   | PM ISA <sup>b</sup>                  |
| Reduced effects from PM deposition (metals and organics)        | Effects on individual organisms and ecosystems   | PM ISA <sup>b</sup>                  |
| Reduced vegetation and ecosystem effects from exposure to ozone | Visible foliar injury on vegetation  | Ozone ISA <sup>a</sup>               |
|   | Reduced vegetation growth and reproduction   | Ozone ISA <sup>a</sup>               |
|   | Yield and quality of commercial forest products and crops  | Ozone ISA <sup>a</sup>               |
|   | Damage to urban ornamental plants  | Ozone ISA <sup>b</sup>               |
|   | Carbon sequestration in terrestrial ecosystems   | Ozone ISA <sup>a</sup>               |
|   | Recreational demand associated with forest aesthetics  | Ozone ISA <sup>b</sup>               |
|   | Other non-use effects  | Ozone ISA <sup>b</sup>               |
|   | Ecosystem functions (e.g., water cycling, biogeochemical cycles, net primary productivity, leaf-gas exchange, community composition) | Ozone ISA <sup>b</sup>               |

| Category   | Unquantified Effect  | More Information                                 |
|--|--|--|
| Reduced effects from acid deposition   | Recreational fishing   | NO <sub>x</sub> SO <sub>x</sub> ISA <sup>a</sup> |
|  | Tree mortality and decline   | NO <sub>x</sub> SO <sub>x</sub> ISA <sup>b</sup> |
|  | Commercial fishing and forestry effects                                      | NO <sub>x</sub> SO <sub>x</sub> ISA <sup>b</sup> |
|  | Recreational demand in terrestrial and aquatic ecosystems                    | NO <sub>x</sub> SO <sub>x</sub> ISA <sup>b</sup> |
|  | Other non-use effects  | NO <sub>x</sub> SO <sub>x</sub> ISA <sup>b</sup> |
|  | Ecosystem functions (e.g., biogeochemical cycles)                            | NO <sub>x</sub> SO <sub>x</sub> ISA <sup>b</sup> |
| Reduced effects from nutrient enrichment   | Species composition and biodiversity in terrestrial and estuarine ecosystems | NO <sub>x</sub> SO <sub>x</sub> ISA <sup>b</sup> |
|  | Coastal eutrophication   | NO <sub>x</sub> SO <sub>x</sub> ISA <sup>b</sup> |
|  | Recreational demand in terrestrial and estuarine ecosystems                  | NO <sub>x</sub> SO <sub>x</sub> ISA <sup>b</sup> |
|  | Other non-use effects  | NO <sub>x</sub> SO <sub>x</sub> ISA <sup>b</sup> |
|  | Ecosystem functions (e.g., biogeochemical cycles, fire regulation)           | NO <sub>x</sub> SO <sub>x</sub> ISA <sup>b</sup> |
| Reduced vegetation effects from ambient exposure to SO <sub>2</sub> and NO <sub>x</sub>  | Injury to vegetation from SO <sub>2</sub> exposure                           | NO <sub>x</sub> SO <sub>x</sub> ISA <sup>b</sup> |
|  | Injury to vegetation from NO <sub>x</sub> exposure                           | NO <sub>x</sub> SO <sub>x</sub> ISA <sup>b</sup> |
| <sup>a</sup> We assess these benefits qualitatively due to data and resource limitations for this RIA.<br><sup>b</sup> We assess these benefits qualitatively because we do not have sufficient confidence in available data or methods.<br><sup>c</sup> We assess these benefits qualitatively because current evidence is only suggestive of causality or there are other significant concerns over the strength of the association. |  |  |

There are also benefits associated with reductions in air toxic pollutant emissions that would result from the program (see RIA Chapter 6.3.7) but that the PM<sub>2.5</sub>-related BPT approach does not capture. While EPA continues to work to improve its benefits estimation tools, there remain critical limitations for estimating incidence and assessing benefits of reducing air toxics.

National-average BPT values reflect the geographic distribution of the underlying modeled emissions used in their calculation, which may not exactly match the geographic distribution of the emission reductions that would occur due to a specific rulemaking. Similarly, BPT estimates may not reflect local variability in population density, meteorology, exposure, baseline health incidence rates, or other local factors for any specific location. For instance, even though we assume that all fine particles have equivalent health effects, the BPT estimates vary across precursors depending on the location and magnitude of their impact on PM<sub>2.5</sub> levels, which drives population exposure. The photochemically-modeled emissions of the onroad mobile- and upstream sector-attributable PM<sub>2.5</sub> concentrations used to derive the BPT values may not match the change in air quality resulting from the control strategies associated with the final standards. For this reason, the PM-related health benefits reported here may be larger, or smaller, than those that would be realized through this rulemaking.

Given the uncertainty that surrounds BPT analysis, EPA systematically compared benefits estimated using its BPT approach (and other reduced-form approaches) to benefits derived from full-form photochemical model representation. This work is referred to as the “Reduced Form Tool Evaluation Project” (Project), which began in 2017, and the initial results were available at the end of 2018. The Agency’s goal was to better understand the suitability of alternative reduced-form air quality modeling techniques for estimating the health impacts of criteria pollutant emissions changes in EPA’s benefit-cost analysis. The Project analyzed air quality

policies that varied in the magnitude and composition of their emissions changes and in the emissions source affected (e.g., on-road mobile, industrial point, or electricity generating units). The policies also differed in terms of the spatial distribution of emissions and concentration changes, and in their impacts on directly-emitted PM<sub>2.5</sub> and secondary PM<sub>2.5</sub> precursor emissions (NO<sub>x</sub> and SO<sub>2</sub>).

For scenarios where the spatial distribution of emissions was similar to the inventories used to derive the BPT, the Project found that total PM<sub>2.5</sub> BPT-derived benefits were within approximately 10 percent to 30 percent of the health benefits calculated from full-form air quality modeling, though the discrepancies varied by regulated scenario and PM<sub>2.5</sub> species. The scenario-specific emission inputs developed for the Project, and a final project report, are available online (U.S. EPA 2019). We note that the BPT values used to monetize the benefits of the final standards were not part of the Project, though we believe they are our best estimate of the stream of benefits associated with the rulemaking absent year-over-year air quality modeling and we have confidence in the BPT approach and the appropriateness of relying on BPT health estimates for this rulemaking. EPA continues to research and develop reduced-form approaches for estimating PM<sub>2.5</sub> benefits.

## Chapter 6 References

- 40 CFR Part 50. 2023. <https://www.ecfr.gov/current/title-40/chapter-I/subchapter-C/part-50>.
- 40 CFR Part 53. 2023. <https://www.ecfr.gov/current/title-40/chapter-I/subchapter-C/part-53>.
- 40 CFR Part 58. 2023. <https://www.ecfr.gov/current/title-40/chapter-I/subchapter-C/part-58>.
- 42 USC §7491 (a). 2013. <https://www.govinfo.gov/content/pkg/USCODE-2013-title42/html/USCODE-2013-title42-chap85-subchapI-partC-subpartii-sec7491.htm>.
- 73 FR 16493-16494 . 2008.
- 81 FR 54422. 2016. "Finding that Greenhouse Gas Emissions From Aircraft Cause or Contribute to Air Pollution That May Reasonably Be Anticipated To Endanger Public Health and Welfare." August 15.
- Adar, S., G. Adamkiewicz, D.R. Gold, J. Schwartz, B.A. Coull, and H. Suh. 2007. "Ambient and microenvironmental particles and exhaled nitric oxide before and after a group bus trip." *Environ Health Perspect* 115: 507-512.
- Adar, S.D., D.R. Gold, and B.A. Coull. 2007. "Focused exposure to airborne traffic particles and heart rate variability in the elderly." *Epidemiology* 18: 95-103.
- Adar, S.D., J. D.Souza, and L. Sheppard. 2015. "Adopting clean fuels and technologies on school buses. Pollution and health impacts in children." *Am J Respir Crit Care Med* 191 (12): 1413-1421.
- Adar, S.D., R. Klein, E.K. Klein, and et al. 2010. "Air pollution and the microvasculature: a cross-sectional assessment of in vivo retinal images in the population-based Multi-Ethnic Study of Atherosclerosis." *PLoS Med* 7 (11): E1000372.
- Aksoy, M. 1989. "Hematotoxicity and carcinogenicity of benzene." *Environ. Health Perspect* 82: 193-197.
- Alexeef, S.E., B.A. Coull, A. Gryparis, and et al. 2011. "Medium-term exposure to traffic-related air pollution and markers of inflammation and endothelial function." *Environ Health Perspect* 119: 481-486.
- Anthoff, D, and R. S. J. Tol. 2013b. "The uncertainty about the social cost of carbon: A decomposition analysis using FUND." *Climate Change* 117(3), 515-530. doi:<https://doi.org/10.1007/s10584-013-0706-7>.
- Anthoff, D, and R.S.J Tol. 2013. "Erratum to: The uncertainty about the social cost of carbon: A decomposition analysis using FUND." *Climatic Change* 121(2), 413.
- Appleman, L.M., R.A. Woutersen, and V.J. Feron. 1982. "Inhalation toxicity of acetaldehyde in rats. I. Acute and subacute studies." *Toxicology* 23: 293-297.
- Apte, J.S., K.P. Messier, S. Gani, M. Brauer, T.W. Kirchstetter, M.M. Lunden, J.D. Marshall, C.J. Portier, R.C.H. Vermeulen, and S.P. Hamburg. 2017. "High-Resolution Air Pollution



Mapping with Google Street View Cars: Exploiting Big Data." *Environ Sci Technol* 51: 6999-7008.

Arrow, K, M Cropper, C Gollier, B Groom, G Heal, R Newell, W Nordhaus, R Pindyck, W Pizer, and P Portney. 2013. "Determining benefits and costs for future generations." *Science* 341(6144) : 349-350.

ATSDR. 2010. Addendum to the Toxicological Profile for Formaldehyde. Washington, DC: U.S. Department of Health and Human Services (HHS).

ATSDR. 2014. Letter Health Consultation, Radiac Abrasives, Inc. Chicago, Illinois: CDC. [https://www.atsdr.cdc.gov/HAC/pha/RadiacAbrasives/Radiac%20Abrasives,%20Inc.%20\\_%20LHC%20\(Final\)%20\\_%2003-24-2014%20\(2\)\\_508.pdf](https://www.atsdr.cdc.gov/HAC/pha/RadiacAbrasives/Radiac%20Abrasives,%20Inc.%20_%20LHC%20(Final)%20_%2003-24-2014%20(2)_508.pdf).

ATSDR. 2007. Toxicological profile for benzene. Atlanta: U.S. Agency for Toxic Substances and Disease Registry (ATSDR), U.S. Department of Health and Human Services, Public Health Service. <http://www.atsdr.cdc.gov/ToxProfiles/tp3.pdf>.

ATSDR. 1999. Toxicological Profile for Formaldehyde. Washington, DC: U.S. Department of Health and Human Services.

ATSDR. 2005. Toxicological Profile for Naphthalene, 1-Methylnaphthalene, and 2-Methylnaphthalene. CDC. <https://www.atsdr.cdc.gov/ToxProfiles/tp67-p.pdf>.

ATSDR. 1995. Toxicological profile for Polycyclic Aromatic Hydrocarbons (PAHs). Atlanta, GA: Agency for Toxic Substances and Disease Registry, U.S. Department of Health and Human Services, Public Health Service. <http://www.atsdr.cdc.gov/ToxProfiles/TP.asp?id=122&tid=25>.

Auffhammer, M. 2018. "Quantifying economic damages from climate change." *Journal of Economic Perspectives* 32(4): 33-52.

Austin, W., G. Heutel, and D. Kreisman. 2019. "School bus emissions, student health and academic performance." *Econ Edu Rev* 70: 108-112.

Bauer, MD, and GD Rudebusch. 2020. "Interest rates under falling stars." *American Economic Review* 110(5): 1316-54.

Bauer, MD, and GD Rudebusch. 2023. "The rising cost of climate change: evidence from the bond market." *The Review of Economics and Statistics* 105(5): 1255-1270.

Beane Freeman, L. E., A. Blair, J. H. Lubin, P. A. Stewart, R. B. Hayes, R. N. Hoover, and M. Hauptmann. 2009. "Mortality from lymphohematopoietic malignancies among workers in formaldehyde industries: The National Cancer Institute cohort." *J. National Cancer Inst.* 101: 751-761.

Bevan, C, J.C. Stadler, and et al. 1996. "Subchronic toxicity of 4-vinylcyclohexene in rats and mice by inhalation." *Fundamentals of Applied Toxicology* 1-10.

Blunden, J, and T Boyer. 2022. "State of the Climate in 2021." *Bulletin of the American Meteorological Society* 103 (8). <https://doi.org/10.1175/2022BAMSStateoftheClimate>.

- Boogaard, H., Patton, A.P., R.W. Atkinson, J.R. Brook, H.H. Chang, D.L. Crouse, J.C. Fussell, et al. 2022. "Long-term exposure to traffic-related air pollution and selected health outcomes: a systematic review and meta-analysis." *Environ Intl* 164: 107262.
- Boothe, V.L., and D.G. Shendell. 2008. "Potential health effects associated with residential proximity to freeways and primary roads: review of scientific literature, 1999-2006." *J Environ Health* 70: 33-41.
- Boothe, V.L., T.K. Boehmer, A.M. Wendel, and F.Y. Yip. 2014. "Residential traffic exposure and childhood leukemia: a systematic review and meta-analysis." *Am J Prev Med* 46: 413-422.
- Bricker, S., B. Longstaff, W. Dennison, A. Jones, K. Boicourt, C. Wicks, and J. Woerner. 2007. *Effects of Nutrient Enrichment In the Nation's Estuaries: A Decade of Change*. Silver Spring, MD: NOAA Coastal Ocean Program Decision Analysis Series No. 26. National Centers for Coastal Ocean Science.
- Bureau of Economic Analysis (BEA). 2021. "Table 1.1.9." *National Income and Product Accounts*. Accessed 2023.
- Cahill, T.M., M.J. Charles, and V.Y. Seaman. 2010. Development and application of a sensitive method to determine concentrations of acrolein and other carbonyls in ambient air. Health Effects Institute Research Report 149. <https://www.healtheffects.org/system/files/Cahill149.pdf>.
- Cape, J.N., I.D. Leith, J. Binnie, J. Content, M. Donkin, M. Skewes, D.N. Price, A.R. Brown, and A.D. Sharpe. 2003. "Effects of VOCs on herbaceous plants in an open-top chamber experiment." *Environ. Pollut* 124: 341-343.
- Carleton, T., Jina, A., Delgado, M., Greenstone, M., Houser, T., Hsiang, S., Hultgren, A., Kopp, R.E., McCusker, K.E., Nath, I., Rising, J., Ashwin, A., Seo, H., Viaene, A., Yaun, J., and Zhang, A., 2022. "Valuing the Global mortality Consequences of Climate Change Accounting for Adaptation Costs and Benefits." *The Quarterly Journal of Economics* 137(4): 2037-2105.
- Chameides, W.L., H. Yu, S.C. Liu, M. Bergin, X. Zhou, L. Mearns, G. Wang, et al. 1999. "Case study of the effects of atmospheric aerosols and regional haze on agriculture: an opportunity to enhance crop yields in China through emission controls?" *PNAS* 96: 13626-13633.
- Chen, E., H.M. Schrier, R.C. Strunk, and et al. 2008. "Chronic traffic-related air pollution and stress interact to predict biologic and clinical outcomes in asthma." *Environ Health Perspect* 116: 970-975.
- CIL, Climate Impact Lab. 2023. Documentation for Data-driven Spatial Climate Impact Model (DSCIM). [https://impactlab.org/wpcontent/uploads/2023/10/DSCIM\\_UserManual\\_Version092023-EPA.pdf](https://impactlab.org/wpcontent/uploads/2023/10/DSCIM_UserManual_Version092023-EPA.pdf).
- Clougherty, J.E., J.I. Levy, L.D. Kubzansky, and et al. 2007. "Synergistic effects of traffic-related air pollution and exposure to violence on urban asthma etiology." *Environ Health Perspect* 115: 1140-1146.
- Coggon, D., E.C. Harris, J. Poole, and K.T. Palmer. 2003. "Extended follow-up of a cohort of British chemical workers exposed to formaldehyde." *J National Cancer Inst.* 95: 1608-1615.

- Corti, M., and C.A. Snyder. 1996. "Influences of gender, development, pregnancy and ethanol consumption on the hematotoxicity of inhaled 10 ppm benzene." *Arch Toxicol* 70: 209-217.
- Cotrufo, M.F., De Santo A.V., Alfani A., Bartoli G., and De Cristofaro A. 1995. "Effects of urban heavy metal pollution on organic matter decomposition in *Quercus ilex* L. Woods." *Environmental Pollution* 89 (1): 81-87.
- Cropper, ML, MC Freeman, B Groom, and WA Pizer. 2014. "Declining discount rates." *American Economic Review* 104(5): 538-43.
- Dabek-Zlotorzynska, E., V. Celo, L. Ding, D. Herod, C-H. Jeong, G. Evans, and N. Hilker. 2019. "Characteristics and sources of PM<sub>2.5</sub> and reactive gases near roadways in two metropolitan areas in Canada." *Atmos Environ* 218: 116980.
- DeHayes, D.H., P.G. Schaberg, G.J. Hawley, and G.R. Strimbeck. 1999. "Acid rain impacts on calcium nutrition and forest health." *Bioscience* 49 (10): 789–800.
- Di, Q, Wang, Y, Zanobetti, A, Wang, Y, Koutrakis, P, Choirat, C, Dominici, F and Schwartz, JD. 2017. "Air pollution and mortality in the Medicare population." *New England Journal of Medicine* 376 (26): 2513-2522.
- Eckel, S.P., K. Berhane, M.T. Salam, and et al. 2011. "Residential Traffic-related pollution exposure and exhaled nitric oxide in the Children's Health Study." *Environ Health Perspect*. doi:10.1289/ehp.1103516.
- EPA. 2023f. "Supplementary Material for the Regulatory Impact Analysis for the Final Rulemaking: Standards of Performance for New, Reconstructed, and Modified Sources and Emissions Guidelines for Existing Sources: Oil and Natural Gas Sector Climate Review." EPA Report on the Social Cost of Greenhouse Gases: Estimates Incorporating Recent Scientific Advances, Washington, DC. doi:Docket ID No. EPA-HQ-OAR-2021-0317.
- Foos, B., M. Marty, J. Schwartz, W. Bennet, J. Moya, A.M. Jarabek, and A.G. Salmon. 2008. "Focusing on children's inhalation dosimetry and health effects for risk assessment: An introduction." *J Toxicol Environ Health* (71A): 149-165.
- Ford, AM, MS Pombo-de-Oliveira, KP McCarthy, JM MacLean, KC Carrico, RF Vincent, and M. Greaves. 1997. "Monoclonal origin of concordant T-cell malignancy in identical twins." *Blood* 89: 281-285.
- Franco-Suglia, S., A. Gryparis, R.O. Wright, and et al. 2007. "Association of black carbon with cognition among children in a prospective birth cohort study." *Am J Epidemiol*. doi:10.1093/aje/kwm308.
- Gantt, B, R.C. Owen, and N. Watkins. 2021. "Characterizing nitrogen oxides and fine particulate matter near major highways in the United States using the National Near-road Monitoring Network." *Environ Sci Technol* 55: 2831-2838.
- Garshick, Eric, Francine Laden, Jaime E. Hart, Mary E. Davis, Ellen A. Eisen, and Thomas J. Smith. 2012. "Lung cancer and elemental carbon exposure in trucking industry workers." *Environmental Health Perspectives* 120 (9): 1301-1306.

- Gartland, N, H.E. Aljofi, K. Dienes, L.A. Munford, A.L. Theakston, and M. van Tongeren. 2022. "The effects of traffic air pollution in and around schools on executive function and academic performance in children: a rapid review." *Int J Environ Res Public Health* 10: 749.
- Goldstein, B.D. 1988. "Benzene toxicity." *Occupational Medicine - State of the Art Reviews* 3: 541-554.
- Grantz, DA, JHB Garner, and DW Johnson. 2003. "Ecological effects of particulate matter." *Environ Int* 29: 213-239.
- Grivas, G., I. Stavroulas, E. Liakakou, D.G. Kaskaoutis, A. Bougiatioti, D. Paraskevopoulou, E. Gerasopoulos, and N. Mihalopoulos. 2019. "Measuring the spatial variability of black carbon in Athens during wintertime." *Air Quality, Atmosphere & Health* 12: 1405–1417.
- Gu, P., H.Z. Li, Q. Ye, and et al. 2018. "Intercity variability of particulate matter is driven by carbonaceous sources and correlated with land-use variables." *Environ Sci Technol* 52: 11545-11554.
- Hand, J.L. et al. 2011. Spatial and Temporal Variability of Haze and its Constituents in the United States. IMPROVE Report 0737-5352 (HERO #3121721). [http://vista.cira.colostate.edu/improve/wp-content/uploads/2016/08/IMPROVE\\_V\\_FullReport.pdf](http://vista.cira.colostate.edu/improve/wp-content/uploads/2016/08/IMPROVE_V_FullReport.pdf).
- Hand, JL, AJ Prenni, S Copeland, BA Schichtel, and WC Malm. 2020. "Thirty years of the Clean Air Act Amendments: Impacts on haze in remote regions of the United States (1990-2018)." *Atmos Environ* 243: 117865.
- Hartin, C. 2023. "Advancing the estimation of future climate impacts within the United States." *Earth System Dynamics* 14: 1015-1037. <https://dio.org/10.5194/esd-14-1015-2023>.
- Hauptmann, M., Stewart P. A., Lubin J. H., L. E. Beane Freeman, R. W. Hornung, R. F. Herrick, R. N. Hoover, J. F. Fraumeni, and R. B. Hayes. 2009. "Mortality from lymphohematopoietic malignancies and brain cancer among embalmers exposed to formaldehyde." *Journal of the National Cancer Institute* 101: 1696-1708.
- Hauptmann, M., J. H. Lubin, P. A. Stewart, R. B. Hayes, and A. Blair. 2003. "Mortality from lymphohematopoietic malignancies among workers in formaldehyde industries." *Journal of the National Cancer Institute* 95: 1615-1623.
- Hauptmann, M., J. H. Lubin, P. A. Stewart, R. B. Hayes, and A. Blair. 2004. "Mortality from solid cancers among workers in formaldehyde industries." *American Journal of Epidemiology* 159: 1117-1130.
- HEI. 2022. HEI Panel on the Health Effects of Long-Term Exposure to Traffic-Related Air Pollution (2022) Systematic review and meta-analysis of selected health effects of long-term exposure to traffic-related air pollution. Health Effects Institute Special Report 23. [https://www.healtheffects.org/system/files/hei-special-report-23\\_1.pdf](https://www.healtheffects.org/system/files/hei-special-report-23_1.pdf).
- Hilker, N., J.W. Wang, C-H. Jong, R.M. Healy, U. Sofowote, J. Deboasz, Y. Su, et al. 2019. "Traffic-related air pollution near roadways: discerning local impacts from background." *Atmos. Meas. Tech* 12: 5247–5261.

- Hope, C. 2013. "Critical issues for the calculation of the social cost of CO<sub>2</sub>: why the estimates from PAGE09 are higher than those from PAGE2002." *Climate Change* 117(3), 531-543. doi:<https://doi.org/10.1007/s10584-012-0633-z>.
- Howard, PH, and T Sterner. 2017. "Few and not so far between: a meta-analysis of climate damage estimates." *Environmental Resource Economics* 68(1): 197-225.
- Hutchinson, J, D Maynard, and L Geiser. 1996. Air quality and lichens - a literature review emphasizing the Pacific Northwest, USA. Pacific Northwest Region Air Resource Management Program; U.S. Forest Service; U.S. Department of Agriculture (USDA).
- Hutchison, R., and C.E. Kraft. 1994. "Hmong Fishing Activity and Fish Consumption." *Journal of Great Lakes Research* 20 (2): 471-487.
- IARC. 2013. "Diesel and gasoline engine exhausts and some nitroarenes." IARC Monographs 105. <http://monographs.iarc.fr/ENG/Monographs/vol105/index.php>.
- IARC. 1982. IARC monographs on the evaluation of carcinogenic risk of chemicals to humans. Lyons, France: International Agency for Research on Cancer, World Health Organization.
- IARC. 2008. "Monographs on the evaluation of carcinogenic risk of chemicals to humans, 1,3-butadiene, ethylene oxide, and vinyl halides, Vol 97."
- IARC. 2018. Monographs on the evaluation of carcinogenic risks to humans. Lyons, France: International Agency for Research on Cancer, World Health Organization. <http://publications.iarc.fr/Book-And-Report-Series/Iarc-Monographs-On-The-Identification-Of-Carcinogenic-Hazards-To-Humans/Benzene-2018>.
- IARC. 2012. Monographs on the Evaluation of Carcinogenic Risks to Humans, Volume 100F: Formaldehyde. International Agency for Research on Cancer.
- IARC. 2006. Monographs on the Evaluation of Carcinogenic Risks to Humans, Volume 88: Formaldehyde, 2-Butoxyethanol and 1-tert-Butoxypropan-2-ol. International Agency for Research on Cancer.
- IARC. 2002. Monographs on the Evaluation of the Carcinogenic Risk of Chemicals for Humans. Lyons, France: International Agency for Research on Cancer .
- IARC. 1999. Re-evaluation of some organic chemicals, hydrazine, and hydrogen peroxide. Lyon, France: IARC Monographs on the Evaluation of Carcinogenic Risk of Chemical to Humans Vol. 71.
- IPCC. 2021. Climate Change 2021 - The Physical Science Basis. Online: Cambridge University Press. [https://www.ipcc.ch/report/ar6/wg1/downloads/report/IPCC\\_AR6\\_WGI\\_Chapter07.pdf](https://www.ipcc.ch/report/ar6/wg1/downloads/report/IPCC_AR6_WGI_Chapter07.pdf).
- . 2021a. Climate Change 2021: The Physical Science Basis. Vol. Contribution of Working Group I to the Sixth Assessment Report of the Intergovernmental Panel on Climate Change. Online: Cambridge University Press. doi:<https://www.ipcc.ch/report/ar6/wg1>.
- . 2019. "Climate Change and Land: an IPCC special report on climate change, desertification, land degradation, sustainable land management, food security, and greenhouse gas fluxes in terrestrial ecosystems."

- . 2018. "Global Warming of 1.5 °C. An IPCC Special Report on the impacts of global warming of 1.5 °C above pre-industrial levels ..."
- IPCC. 2018. "Global Warming of 1.5°C: An IPCC Special Report on the impacts of global warming of 1.5°C above pre-industrial levels and related global greenhouse gas emission pathways."
- . 2019. "Special Report on the Ocean and Cryosphere in a Changing Climate."
- . 2021. "Summary for Policymakers. In: Climate Change 2021: The Physical Science Basis. Contribution of Working Group I to the Sixth Assessment Report of the Intergovernmental Panel on Climate Change." Cambridge, United Kingdom and New York, NY, USA: Cambridge University Press. 3-32. doi:10.1017/9781009157896.001.
- . 2013. "Summary for Policymakers. In: Climate Change 2023: Synthesis Report. Contribution of Working Groups I, II and III to the Sixth Assessment Report of the Intergovernmental Panel on Climate Change." Geneva. doi:10.59327/IPCC/AR6-9789291691647.001.
- IPCS. 2002. Concise International Chemical Assessment Document 40. Formaldehyde. World Health Organization.
- Irons, R.D., W.S. Stillman, D.B. Colagiovanni, and V.A. Henry. 1992. "Synergistic action of the benzene metabolite hydroquinone on myelopoietic stimulating activity of granulocyte/macrophage colony-stimulating factor in vitro." *Proc. Natl. Acad. Sci.* 89: 3691-3695.
- Irving, P.M. 1991. *Acidic deposition: State of science and technology. Vols I-IV.* Washington, DC: The U.S. National Acid Precipitation Assessment Program, 24-76.
- Islam, T., R. Urban, W.J. Gauderman, and et al. 2011. "Parental stress increases the detrimental effect of traffic exposure on children's lung function." *Am J Respir Crit Care Med.*
- IWG. 2016a. Addendum to Technical Support Document on Social Cost of Carbon for Regulatory Impact Analysis under Executive Order 12866: Application of the Methodology to Estimate the Social Cost of Methane and the Social Cost of Nitrous Oxide. [https://www.epa.gov/sites/default/files/2016-12/documents/addendum\\_to\\_sc-ghg\\_tsd\\_august\\_2016.pdf](https://www.epa.gov/sites/default/files/2016-12/documents/addendum_to_sc-ghg_tsd_august_2016.pdf).
- IWG. 2021. *Social Cost of Carbon, Methane, and Nitrous Oxide: Interim Estimates under Executive Order 13990.* Technical Support Government, Interagency Working Group on Social Cost of Carbon, United States Government.
- . 2010. *Technical Support Document: Social Cost of Carbon for Regulatory Impact Analysis under Executive Order 12866.* Accessed 2023. [https://www.epa.gov/sites/default/files/2016-12/documents/scc\\_tsd\\_2010.pdf](https://www.epa.gov/sites/default/files/2016-12/documents/scc_tsd_2010.pdf).
- . 2021. *Technical Support Document: Social Cost of Carbon, Methane, and Nitrous Oxide Interim Estimates under Executive Order 13990.* Accessed 2023. [https://www.whitehouse.gov/wp-content/uploads/2021/02/TechnicalSupportDocument\\_SocialCostofCarbonMethaneNitrouSOxide.pdf](https://www.whitehouse.gov/wp-content/uploads/2021/02/TechnicalSupportDocument_SocialCostofCarbonMethaneNitrouSOxide.pdf).

- . 2013. Technical Support Document: Technical Update of the Social Cost of Carbon for Regulatory Impact Analysis Under Executive Order 12866.  
[https://www.ourenergypolicy.org/wp-content/uploads/2013/06/social\\_cost\\_of\\_carbon\\_for\\_ria\\_2013\\_update.pdf](https://www.ourenergypolicy.org/wp-content/uploads/2013/06/social_cost_of_carbon_for_ria_2013_update.pdf).
- . 2016b. Technical Support Document: Technical Update of the Social Cost of Carbon for Regulatory Impact Analysis Under Executive Order 12866. Accessed 2023.  
[https://www.epa.gov/sites/default/files/2016-12/documents/sc\\_CO2\\_tsd\\_august\\_2016.pdf](https://www.epa.gov/sites/default/files/2016-12/documents/sc_CO2_tsd_august_2016.pdf).
- Joslin, J.D., Kelly, J.M., and van Miegroet, H. 1992. "Soil chemistry and nutrition of North American spruce-fir stands: evidence for recent change." *Journal of Environmental Quality* 21: 12-30.
- Kammerbauer, H., H. Selinger, R. Rommelt, A. Ziegler-Jons, D. Knoppik, and B. Hock. 1987. "Toxic components of motor vehicle emissions for the spruce *Picea abies*." *Environ. Pollut.* 48: 235-243.
- Kan, H., G. Heiss, K.M. Rose, and et al. 2008. "Prospective analysis of traffic exposure as a risk factor for incident coronary heart disease: The Atherosclerosis Risk in Communities (ARIC) study." *Environ Health Perspect* 116: 1463-1468.
- Karner, A.A., D.S. Eisinger, and D.A. Niemeier. 2010. "Near-roadway air quality: synthesizing the findings from real-world data." *Environ Sci Technol* 44: 5334-5344.
- Keller, KA, and CA. Snyder. 1988. "Mice exposed in utero to 20 ppm benzene exhibit altered numbers of recognizable hematopoietic cells up to seven weeks after exposure." *Fundam Appl Toxicol* 10: 224-232.
- Keller, KA, and CA. Snyder. 1986. "Mice exposed in utero to low concentrations of benzene exhibit enduring changes in their colony forming hematopoietic cells." *Toxicology* 42: 171-181.
- Kimbrough, S., R.C. Owen, M. Snyder, and J. Richmond-Bryant. 2017. "NO to NO2 Conversion Rate Analysis and Implications for Dispersion Model Chemistry Methods using Las Vegas, Nevada Near-Road Field Measurements." *Atmos Environ* 165: 23-24.
- Kimbrough, S., R.W. Baldauf, G.S.W. Hagler, R.C. Shores, W. Mitchell, D.A. Whitaker, C.W. Croghan, and D.A. Vallero. 2013. "Long-term continuous measurement of near-road air pollution in Las Vegas: seasonal variability in traffic emissions impact on air quality." *Air Qual Atmos Health* 6: 295-305.
- Kimbrough, S., T. Palma, and R.W. Baldauf. 2014. "Analysis of mobile source air toxics (MSATs)—Near-road VOC and carbonyl concentrations." *Journal of the Air & Waste Management Association* 64 (3): 349-359. doi:10.1080/10962247.2013.863814.
- Laden, F., J.E. Hart, T.J. Smith, M.E. Davis, and E. Garshick. 2007. "Cause-specific mortality in the unionized U.S. trucking industry." *Environmental Health Perspect* 115: 1192-1196.
- Lal, Raj M, Anu Ramaswami, and Armistead G Russell. 2020. "Assessment of the Near-Road (monitoring) Network including comparison with nearby monitors within U.S. cities." *Environmental Research Letters* (15): 114026. doi:10.1088/1748-9326/ab8156.

- Lan, Qing, L. Zhang, G. Li, and R., et al. Vermeulen. 2004. "Hematotoxicity in Workers Exposed to Low Levels of Benzene." *Science* 306: 1774-1776.
- Landers, DH, SL Simonich, DA Jaffe, LH Geiser, DH Campbell, AR Schwindt, CB Schreck, et al. 2008. *The Fate, Transport and Ecological Impacts of Airborne Contaminants in Western National Parks (USA)*. EPA/600/R-07/138. Corvallis, Oregon: U.S. Environmental Protection Agency, Office of Research and Development, NHEERL, Western Ecology Division.
- Li, C., Q. N, and P.H. Ryan. 2009. "School bus pollution and changes in the air quality at schools: a case study." *J Environ Monit* 11: 1037-1042.
- Liu, W., J. Zhang, J.I Kwon, and et al. 2006. "Concentrations and source characteristics of airborne carbonyl compounds measured outside urban residences." *J Air Waste Manage Assoc* 56: 1196-1204.
- Long, D., D. Lewis, and C. Langpap. 2021. "Negative traffic externalities and infant health: the role of income heterogeneity and residential sorting." *Environ and Resource Econ* 80: 637-674.
- Malm, William. 2016. *Visibility – The Seeing of Near and Distant Landscape Features*. Elsevier.
- McConnell, R., T. Islam, K. Shankardass, and et al. 2010. "Childhood incident asthma and traffic-related air pollution at home and school." *Environ Health Perspect* 1021-1026.
- McDonald, B.C., Z.C. McBride, E.W. Martin, and R.A. Harley. 2014. "High-resolution mapping of motor vehicle carbon dioxide emissions." *J. Geophys. Res. Atmos* 119: 5283–5298. doi:10.1002/2013JD021219.
- McDuffie, EE, MC Sarofim, W Raich, M Jackson, H Roman, K Seltzer, BH Henderson, et al. 2023. "The social cost of ozone-related mortality impacts from methane emissions." *Earth's Future* 11(9). doi:<https://doi.org/10.1029/2023EF003853>.
- Millar, RJ, ZR Nicholls, P Friedlingstein, and MR Allen. 2017. "A modified impulse-response representation of the global near-surface air temperature and atmospheric concentration response to carbon dioxide emissions." *Atmospheric Chemistry and Physics* 17(11): 7213-7228.
- Myou, S., M. Fujimura, Nishi K., T. Ohka, and T. and Matsuda. 1993. "Aerosolized acetaldehyde induces histamine-mediated bronchoconstriction in asthmatics." *Am. Rev. Respir. Dis* 148 (4 Pt 1): 940-943.
- NASEM. 2016. "Attribution of Extreme Weather Events in the Context of Climate Change." Washington, D.C.: National Academies of Sciences, Engineering, and Medicine, The National Academies Press. <https://doi.org/10.17226/21852>.
- . 2019. "Climate Change and Ecosystems." Washington, D.C.: National Academies of Sciences, Engineering, and Medicine, The National Academies Press. doi:<https://doi.org/10.17226/25504>.
- . 2017. "Valuing Climate Damages: Updating Estimation of the Social Cost of Carbon Dioxide." Washington, D.C.: National Academies of Sciences, Engineering, and Medicine, The National Academies Press. <https://doi.org/10.17226/24651>.



National Academies of Sciences, Engineering, and Medicine. 2023. Review of EPA's 2022 Draft Formaldehyde Assessment. The National Academies Press. doi:10.17226/27153.

National Academies. 2017. Valuing Climate Damages: Updating Estimation of the Social Cost of Carbon Dioxide. Washington, D.C.: The National Academies Press.

Newell, RG, WA Pizer, and BC Prest. 2022. "A discounting rule for the social cost of carbon." *Journal of the Association of Environmental and Resource Economists* 9(5): 1017-1046.

NIFC. 2021. "Total wildland fires and acres (1983-2020)." National Interagency Fire Center.

Niklinska, M, R Laskowski, and M. Maryanski. 1998. "Effect of heavy metals and storage time on two types of forest litter: basal respiration rate and exchangeable metals." *Ecotoxicological Environmental Safety* 41: 41.

NOAA. 2022. "State of the Climate 2021." <https://www.ncei.noaa.gov/bams-state-of-climate>.

Nordhaus, W. 2014. "Estimates of the social cost of carbon: concepts and results from the DICE 2013R model and alternative approaches." *Journal of the Association of Environmental Economists* 1(1/2): 273-312.

Nordhaus, W.D. 2010. "Economic aspects of global warming in a post-Copenhagen environment. ." *Proceedings of the National Academy of Sciences of the United States of America* 107(26), 11721-11726.

NRC. 1993. Protecting Visibility in National Parks and Wilderness Areas. Washington, DC: National Research Council, National Academy of Sciences Committee on Haze in National Parks and Wilderness Areas. <https://nap.nationalacademies.org/initiative/committee-on-haze-in-national-parks-and-wilderness-areas>.

NRC. 2011. Review of the Environmental Protection Agency's Draft IRIS Assessment of Formaldehyde. Washington, DC: National Research Council, National Academies Press. [http://books.nap.edu/openbook.php?record\\_id=13142](http://books.nap.edu/openbook.php?record_id=13142).

NTP. 2019. NTP Monograph on the Systematic Review of Traffic-related Air Pollution and Hypertensive Disorders of Pregnancy. National Toxicology Program Monograph 7. [https://ntp.niehs.nih.gov/ntp/ohat/trap/mgraph/trap\\_final\\_508.pdf](https://ntp.niehs.nih.gov/ntp/ohat/trap/mgraph/trap_final_508.pdf).

NTP. 2016. Report on Carcinogens, Fourteenth Edition. Washington, DC: National Toxicology Program, U.S. Department of Health and Human Services, Public Health Service. <https://ntp.niehs.nih.gov/go/roc14>.

Oak Ridge Institute for Science and Education. 2004. "External Peer Review for the IRIS Reassessment of the Inhalation Carcinogenicity of Naphthalene." <http://cfpub.epa.gov/ncea/cfm/recordisplay.cfm?deid=84403>.

OEHHA, California. 2014. "TSD for Noncancer RELs: Appendix D. Individual, Acute, 8-Hour, and Chronic Reference Exposure Level Summaries." <https://oehha.ca.gov/media/downloads/crnrr/appendixd1final.pdf>.

Olsson, Ann C., et al. 2011. "Exposure to diesel motor exhaust and lung cancer risk in a pooled analysis from case-control studies in Europe and Canada." *American journal of respiratory and critical care medicine* 183 (7): 941-948.

OMB. 2022. "Climate Risk Exposure: An Assessment of the Federal Government's Financial Risks to Climate Change, White Paper." Office of Management and Budget, April.

OMB, Office of Management and Budget. 2003. Circular A-4, Regulatory Analysis. Washington, DC: Office of Management and Budget.  
[https://obamawhitehouse.archives.gov/omb/circulars\\_a004\\_a-4](https://obamawhitehouse.archives.gov/omb/circulars_a004_a-4).

P.A., McKinney, F.E. Alexander, R.A. Cartwright, and et al. 1991. "Parental occupations of children with leukemia in west Cumbria, north Humberside, and Gateshead." *Br. Med. J* 302: 681-686.

Pedde, M., and C. Bailey. 2011. Identification of Schools within 200 Meters of U.S. Primary and Secondary Roads. Memorandum to the docket, U.S. Environmental Protection Agency.

Peters, A., S. von Klot, M. Heier, I. Trentinaglia, A. Hörmann, H.E. Wichmann, and H. Löwel. 2004. "Exposure to traffic and the onset of myocardial infarction." *New England J Med* 351: 1721-1730.

Peterson, D.E., M.S. Kanarek, M.A. Kuykendall, J.M. Diedrich, H.A. Anderson, P.L. Remington, and T.B. Sheffy. 1994. "Fish Consumption Patterns and Blood Mercury Levels in Wisconsin Chippewa Indians." *Archives of Environmental Health* 49 (1): 53–58.

Pindyck, RS. 2017. "Comments on Proposed Rule and Regulatory Impact Analysis on the Delay and Suspension of Certain Requirements for Waster Prevention and Resource Conservation." Accessed Comment submitted on Nov. 6, 2017. [https://downloads.regulations.gov/EPA-HQ-OAR-2018-0283-6184/attachment\\_6.pdf](https://downloads.regulations.gov/EPA-HQ-OAR-2018-0283-6184/attachment_6.pdf).

Pinkerton, L. E. 2004. "Mortality among a cohort of garment workers exposed to formaldehyde: an update." *Occup. Environ. Med.* 61: 193-200.

Pope III et al., CA, Lefler, JS, Ezzati, M, Higbee, JD, Marshall, JD, Kim, S-Y, Bechle, M, Gilliat, KS, Vernon, SE and Robinson, AL. 2019. "Mortality risk and fine particulate air pollution in a large, representative cohort of US adults." *Environmental Health Perspectives* 127 (7): 077007.

Power, M.C., M.G. Weisskopf, S.E. Alexeef, and et al. 2011. "Traffic-related air pollution and cognitive function in a cohort of older men." *Environ Health Perspect* 682-687.

Qu, O., R. Shore, G. Li, X. Jin, C.L. Chen, B. Cohen, A. Melikian, et al. 2003. Validation & Evaluation of Biomarkers in Workers Exposed to Benzene in China HEI Report 115. Health Effects Institute .

Qu, Q., R. Shore, G. Li, X. Jin, L.C. Chen, and et al. B. Cohen. 2002. "Hematological changes among Chinese workers with a broad range of benzene exposures." *American Journal of Industrial Medicine* 42: 275-285.

Raaschou-Nielsen, O., and P Reynolds. 2006. "Air pollution and childhood cancer: a review of the epidemiological literature." *Int J Cancer* 118: 2920-2929.

- Ramsey, FP. 1928. "A mathematical theory of saving." *The Economic Journal* 38(152): 543-559.
- Rennert, K, BC Prest, WA Pizer, RG Newell, D Anthoff, C Kingdon, L Rennels, et al. 2022a. "The social cost of carbon: Advances in long-term probabilistic projections of population, GDP, emissions, and discount rates." *Brookings Papers on Economic Activity* Fall 2021 223-305.
- Rennert, K, F Errickson, BC Prest, L Rennels, R Newell, W Pizer, C Kingdon, J Wingenroth, and R Cooke. 2022. "Comprehensive evidence implies a higher social cost of CO<sub>2</sub>." *Nature* 610(7933): 687-692.
- Rennert, K., Prest, B.C., Pizer, W.A., Newell, R.G., Anthoff, D., Kingdon, C., Rennels, L., Cooke, R., Raftery, A.E., Ševčíková, H. and Errickson, F. 2021. "The social cost of carbon: Advances in long-term probabilistic projections of population, GDP, emissions, and discount rates." *Brookings Papers on Economic Activity* 223-305.
- Riddell, J., T.H. Nash, and P. Padgett. 2008. "The effect of HNO<sub>3</sub> gas on the lichen *Ramalina menziesii*." *Flora - Morphology, Distribution, Functional Ecology of Plants* 203 (1): 47-54.
- Riediker, M. 2007. "Cardiovascular effects of fine particulate matter components in highway patrol officers." *Inhal Toxicol* 19: 99-105.
- Riediker, M., W.E. Cascio, T.R. Griggs, and et al. 2004. "Particulate matter exposure in cars is associated with cardiovascular effects in healthy young men." *Am J Respir Crit Care Med* 169.
- Rode, A, T Carleton, M Delgado, M Greenstone, T Houser, S Hsiang, A Hultgren, et al. 2021. "Estimating a social cost of carbon for global energy consumption." *Nature* 598(7880): 308-314.
- Rose, S, D Turner, G Blanford, J Bistline, F de la Chesnaye, and T Wilson. 2014. "Understanding the Social Cost of Carbon: A Technical Assessment." EPRI Technical Update Report, Palo Alto, CA.
- Rothman, N., G.L. Li, M. Dosemeci, W.E. Bechtold, G.E. Marti, Y.Z. Wang, M. Linet, L.Q. Xi, W. Lu, M.T. Smith, N. Titenko-Holland, L.P. Zhang, W. Blot, S.N. Yin, and R.B. Hayes. 1996. "Hematotoxicity among Chinese workers heavily exposed to benzene." *American Journal of Industrial Medicine* 29: 236-246.
- Sabin, L., E. Behrentz, A.M. Winer, and et al. 2005. "Characterizing the range of children's air pollutant exposure during school bus commutes." *J Expo Anal Environ Epidemiol* 15: 377-387.
- Salam, M.T., T. Islam, and F.D. Gilliland. 2008. "Recent evidence for adverse effects of residential proximity to traffic sources on asthma." *Curr Opin Pulm Med* 14: 3-8.
- Sarnat, J.A., A. Russell, D. Liang, J.L Moutinho, R. Golan, R. Weber, D. Gao, et al. 2018. Developing Multipollutant Exposure Indicators of Traffic Pollution: The Dorm Room Inhalation to Vehicle Emissions (DRIVE) Study. Health Effects Institute Research Report Number 196. <https://www.healtheffects.org/publication/developing-multipollutant-exposure-indicators-traffic-pollution-dorm-room-inhalation>.
- Sheppard, EL (2022). 2022. "Letter from Elizabeth A. (Lianne) Sheppard, Chair, Clean Air Scientific Advisory Committee, to Administrator Michale Regan. ." Re: CASAC Review of the EPA's Supplement to the 2019 Integrated Science Assessment for Particulate Matter (External Review Draft - October 2021). EPA-CASAC-22-001, March 18.

Silverman, D. T., Samanic, C. M., Lubin, J. H., Blair, A. E., Stewart, P. A., Vermeulen, R., & Attfield, M. D. 2012. "The diesel exhaust in miners study: a nested case-control study of lung cancer and diesel exhaust." *Journal of the National Cancer Institute*.

Sisler, J.F. 1996. Spatial and seasonal patterns and long-term variability of the composition of the haze in the United States: an analysis of data from the IMPROVE network. CIRA Report, ISSN 0737-5352-32, Colorado State University.

Smith, CJ, PM Forster, M Allen, N Leach, RJ Millar, GA Passerello, and LA Regayre. 2018. "FAIR v1.3: a simple emissions-based impulse response and carbon cycle model." *Geosci. Model Dev.* 11(6): 2273-2297. doi:<https://doi.org/10.5194/gmd-11-2273-2018>.

Stenson, C., A.J. Wheeler, A. Carver, and et al. 2021. "The impact of traffic-related air pollution on child and adolescent academic performance: a systematic review." *Environ Intl* 155: 106696.

Sun, X., S. Zhang, and X. Ma. 2014. "No association between traffic density and risk of childhood leukemia: a meta-analysis." *Asia Pac J Cancer Prev* 15: 5229-5232.

Tol, R. 2009. An analysis of mitigation as a response to climate change. Copenhagen Consensus on Climate, Copenhagen Consensus Center.

Turner, MC, Jerrett, M, Pope, A, III, Krewski, D, Gapstur, SM, Diver, WR, Beckerman, BS, Marshall, JD, Su, J, Crouse, DL and Burnett, RT (2016). 2016. "Long-term ozone exposure and mortality in a large prospective study." *American Journal of Respiratory and Critical Care Medicine* 193 (10): 1134-1142.

Turteltaub, K.W., and C. Mani. 2003. Benzene metabolism in rodents at doses relevant to human exposure from Urban Air. HEI Report 113. Health Effects Institutue.

U.S. Dept of State and U.S. Executive Office of the President. 2021. "The Long-Term Strategy of the United States: Pathways to Net-Zero Greenhouse Gas Emissions by 2050." Washington, D.C., November.

U.S. DOT. 2023. Freight Analysis Framework. [https://ops.fhwa.dot.gov/freight/freight\\_analysis/faf/](https://ops.fhwa.dot.gov/freight/freight_analysis/faf/).

U.S. EPA. 2002. 1,3-Butadiene IRIS page. [https://cfpub.epa.gov/ncea/iris2/chemicalLanding.cfm?substance\\_nmbr=139](https://cfpub.epa.gov/ncea/iris2/chemicalLanding.cfm?substance_nmbr=139).

U.S. EPA. 2023. 2019 AirToxScreen Risk Drivers. Washington, DC: U.S. Environmental Protection Agency. <https://www.epa.gov/AirToxScreen/airtoxscreen-risk-drivers>.

—. 2021. "2021 Policy on Children's Health." October 5. <https://www.epa.gov/system/files/documents/2021-10/2021-policy-on-childrens-health.pdf>.

U.S. EPA. 2022. "2023 PM NAAQS Reconsideration Proposal RIA." EPA-HQ-OAR-2019-0587.

U.S. EPA. 2006. "A Framework for Assessing Health Risks of Environmental Exposures to Children. EPA/600/R-05/093F." Washinton, DC.

—. 2022. America's Children and the Environment. May 16. Accessed March 7, 2023. <https://www.epa.gov/americaschildrenenvironment>.

- . 2023. BenMAP-CE. Accessed March 10, 2023. <https://github.com/BenMAPCE/BenMAP-CE>.
- U.S. EPA. 2022. Derivation of an acute reference concentration for inhalation exposure to naphthalene. EPA/600/R-21/292. Washington, D.C.: U.S. Environmental Protection Agency. <https://cfpub.epa.gov/ncea/risk/recordisplay.cfm?deid=355035>.
- U.S. EPA. 1991. Drinking Water Criteria Document for Polycyclic Aromatic Hydrocarbons (PAHS). ECAO-CIN-0010. EPA Research and Development.
- U.S. EPA. 1991. Effects of organic chemicals in the atmosphere on terrestrial plants. EPA/600/3-91/001. Washington, DC: U.S. Environmental Protection Agency.
- U.S. EPA. 2023. "Estimating PM<sub>2.5</sub>- and Ozone-Attributable Health Benefits. Technical Support Document (TSD) for the 2023 PM NAAQS Reconsideration Proposal." EPA-HQ-OAR-2019-0587.
- U.S. EPA. 2018. "Estimating the Benefit per Ton of reducing PM<sub>2.5</sub> Precursors from 17 Sectors." [https://www.epa.gov/sites/default/files/2018-02/documents/sourceapportionmentbpttsd\\_2018.pdf](https://www.epa.gov/sites/default/files/2018-02/documents/sourceapportionmentbpttsd_2018.pdf).
- U.S. EPA. 2021. Estimation of Population Size and Demographic Characteristics among People Living Near Truck Routes in the Conterminous United States. Memorandum to the Docket, U.S. Environmental Protection Agency.
- U.S. EPA. 2016. Exposure Factors Handbook: 2011 Edition. Chapter 16. U.S. Environmental Protection Agency. <https://www.epa.gov/sites/production/files/2015-09/documents/efh-Chapter16.pdf>.
- U.S. EPA. 1990. Formaldehyde (CASRN 50-00-0) Chemical Assessment Summary. Washington, DC: U.S. Environmental Protection Agency, Integrated Risk Information Systems (IRIS). [https://cfpub.epa.gov/ncea/iris2/chemicalLanding.cfm?substance\\_nmbr=419](https://cfpub.epa.gov/ncea/iris2/chemicalLanding.cfm?substance_nmbr=419).
- U.S. EPA. 1999. Guidelines for Carcinogen Risk Assessment (Review Draft) NCEA-F-0644. Washington, DC: U.S. Environmental Protection Agency. Accessed January 11, 2023. <https://cfpub.epa.gov/ncea/risk/recordisplay.cfm?deid=54932>.
- U.S. EPA. 2016. "Guidelines for Preparing Economic Analyses." Accessed March 10, 2023. <https://www.epa.gov/sites/default/files/2017-08/documents/ee-0568-50.pdf>.
- U.S. EPA. 2002. Health Assessment Document for Diesel Engine Exhaust. EPA/600/8-90/057F. Washington, DC: U.S. Environmental Protection Agency.
- U.S. EPA. 2002. "Health Assessment of 1,3-Butadiene." EPA 600-P-98-001F.
- U.S. EPA. 2000. Integrated Risk Information System File for Benzene. Washington, DC: U.S. Environmental Protection Agency. [https://cfpub.epa.gov/ncea/iris2/chemicalLanding.cfm?substance\\_nmbr=276](https://cfpub.epa.gov/ncea/iris2/chemicalLanding.cfm?substance_nmbr=276).
- U.S. EPA. 1991. Integrated Risk Information System File of Acetaldehyde. Washington, D.C.: Research and Development, National Center for Environmental Assessment, U.S. Environmental Protection Agency. [https://cfpub.epa.gov/ncea/iris2/chemicalLanding.cfm?substance\\_nmbr=290](https://cfpub.epa.gov/ncea/iris2/chemicalLanding.cfm?substance_nmbr=290).

U.S. EPA. 2010. Integrated Science Assessment (ISA) for Carbon Monoxide (Final Report) EPA/600/R-09/019F. Washington, DC: U.S. Environmental Protection Agency.

U.S. EPA. 2020. Integrated Science Assessment (ISA) for Oxides of Nitrogen, Oxides of Sulfur and Particulate Matter Ecological Criteria (Final Report) EPA/600/R-20/278. Washington, D.C.: U.S. Environmental Protection Agency.

U.S. EPA. 2020. Integrated Science Assessment (ISA) for Ozone and Related Photochemical Oxidants (Final Report) EPA/600/R-20/012. Washington, DC: US Environmental Protection Agency.

U.S. EPA. 2019. "Integrated Science Assessment (ISA) for Particulate Matter (Final Report)." Office of Research and Development, Center for Public Health and Environmental Assessment EPA-HQ-OAR-2020-0272.

U.S. EPA. 2017. Integrated Science Assessment (ISA) for Sulfur Oxides - Health Criteria (Final Report) EPA/600/R-17/451. Washington, DC: U.S. Environmental Protection Agency.

—. 2016. "Integrated Science Assessment for Oxides of Nitrogen - Health Criteria (Final Report)." National Center for Environmental Assessment, Research Triangle Park, NC. July. <https://cfpub.epa.gov/ncea/isa/recordisplay.cfm?deid=310879>.

U.S. EPA. 2019. "Integrated Science Assessment for Particulate Matter (Final Report) EPA/600/R-06/129F." Washington, DC, Ch 4 "Overall Conclusions" p. 4-1.

U.S. EPA. 2009. Integrated Science Assessment for Particulate Matter (Final Report) EPA/600/R-08/139F. Washinton, D.C.: U.S. Environmental Protection Agency.

—. 2023. IRIS - Naphthalene CASRN 91-20-3. [https://cfpub.epa.gov/ncea/iris\\_drafts/recordisplay.cfm?deid=340791](https://cfpub.epa.gov/ncea/iris_drafts/recordisplay.cfm?deid=340791).

U.S. EPA. 2009. Metabolically-derived ventilation rates: A revised approach based upon oxygen consumption rates EPA/600/R-06/129F. Washington, DC: Office of Research and Development. <http://cfpub.epa.gov/ncea/cfm/recordisplay.cfm?deid=202543>.

—. 2024. National Ambient Air Quality Standards (NAAQS) for PM. February 15. <https://www.epa.gov/pm-pollution/national-ambient-air-quality-standards-naaqs-pm>.

U.S. EPA. 2022. Policy Assessment (PA) for the Reconsideration of the National Ambient Air Quality Standards for Particulate Matter (Final Report) EPA/452/R-22-004. Washington, D.C.: U.S. Environmental Protection Agency.

U.S. EPA. 2020. Policy Assessment (PA) for the Review of the National Ambient Air Quality Standards for Particulate Matter (Final Report) EPA/452/R-20/002. Washington DC: US EPA.

—. 2019. "Reduced Form Evaluation Project Report." <https://www.epa.gov/benmap/reduced-form-evaluation-project-report>.

—. 2017. "SAB Review of EPA's Proposed Methodology for Updating Mortality Risk Valuation Estimates for Policy Analysis." <https://nepis.epa.gov/Exe/ZyPDF.cgi/P100ROQR.PDF?Dockey=P100ROQR.PDF>.

U.S. EPA. 2022. "Standards of Performance for New, Reconstructed, and Modified Sources and Emissions Guidelines for Existing Sources: Oil and Natural Gas Sector Climate Review EPA-HQ-OAR-2021-0317."

U.S. EPA. 2022. "Supplement to the 2019 Integrated Science Assessment for Particulate Matter (Final Report)." Office of Research and Development, Center for Public Health and Environmental Assessment EPA-600-R-19-188.

U.S. EPA. 2005. Supplemental guidance for assessing susceptibility from early-life exposure to carcinogens. EPA/630/R-03/003F. Washington, DC: Risk Assessment Forum. [https://www3.epa.gov/airtoxics/childrens\\_supplement\\_final.pdf](https://www3.epa.gov/airtoxics/childrens_supplement_final.pdf).

—. 2021. "Technical Documentation on the Framework for Evaluating Damages and Impacts (FrEDI) EPA 430-R-21-004." <https://www.epa.gov/cira/fredi>.

U.S. EPA. 2022. Technical Support Document (TSD) EPA Air Toxics Screening Assessment. 2018 AirToxScreen TSD. Washington, D.C.: U.S. Environmental Protection Agency. [https://www.epa.gov/system/files/documents/2023-02/AirToxScreen\\_2018%20TSD.pdf](https://www.epa.gov/system/files/documents/2023-02/AirToxScreen_2018%20TSD.pdf).

U.S. EPA. 2023. "Technical Support Document: Estimating the Benefit per Ton of Reducing Directly-Emitted PM<sub>2.5</sub>, PM<sub>2.5</sub> Precursors and Ozone Precursors from 21 Sectors."

U.S. EPA. 2002. Toxicological Review of Benzene (Noncancer Effects) EPA/635/R-02/001F. Washington, DC: U.S. Environmental Protection Agency, Integrated Risk Information System (IRIS), National Center for Environmental Assessment.

U.S. EPA. 2017. Toxicological Review of Benzo[a]pyrene. Washington, DC: U.S. Environmental Protection Agency. [https://cfpub.epa.gov/ncea/iris/iris\\_documents/documents/toxreviews/0136tr.pdf](https://cfpub.epa.gov/ncea/iris/iris_documents/documents/toxreviews/0136tr.pdf).

U.S. EPA. 2010. Toxicological Review of Formaldehyde (CAS No. 50-00-0) – Inhalation Assessment: In Support of Summary Information on the Integrated Risk Information System (IRIS). External Review Draft. EPA/635/R-10/002A. Washington, DC: U.S. Environmental Protection Agency. [http://cfpub.epa.gov/ncea/iris\\_drafts/recordisplay.cfm?deid=223614](http://cfpub.epa.gov/ncea/iris_drafts/recordisplay.cfm?deid=223614).

U.S. EPA. 1998. Toxicological Review of Naphthalene (Reassessment of the Inhalation Cancer Risk). Washington, D.C.: Environmental Protection Agency, Integrated Risk Information System, Research and Development, National Center for Environmental Assessment. [https://cfpub.epa.gov/ncea/iris\\_drafts/recordisplay.cfm?deid=56434](https://cfpub.epa.gov/ncea/iris_drafts/recordisplay.cfm?deid=56434).

U.S. EPA-SAB. 2005. "Advisory Council on Clean Air Compliance Analysis Response to Agency Request on Cessation Lag." EPA-COUNCIL-LTR-05-001. December. <https://council.epa.gov/ords/sab/f?p=104:12:968651521971>.

—. 2000. "An SAB Report on EPA's White Paper Valuing the Benefits of Fatal Cancer Risk Reduction." [https://www.epa.gov/system/files/documents/2022-03/86189901\\_0.pdf](https://www.epa.gov/system/files/documents/2022-03/86189901_0.pdf).

Ugrekheldze, D., F, Korte, and G. Kvesitadze. 1997. "Uptake and transformation of benzene and toluene by plant leaves." *Ecotox. Environ. Safety* 37: 24-29.

US EPA. 2021. "Climate Change and Social Vulnerability in the United States: A Focus on Six Impacts." EPA 430-R-21-003.

- US EPA. 2022. "IRIS Toxicological Review of Formaldehyde-Inhalation (External Review Draft)." EPA/635/R-22/039.
- USGCRP. 2023. "Ch. 1. Overview: Understanding risks, impacts, and responses. In: Fifth National Climate Assessment." Washington, D.C.: U.S. Global Change Research Program. doi:<https://doi.org/10.7930/NCA5.2023.CH1>.
- . 2017. "Climate Science Special Report: Fourth National Climate Assessment, Volume I." Washington, D.C.: U.S. Global Change Research Program. doi:10.7930/J0J964J6.
- . 2018. "Impacts, Risks, and Adaptation in the United States: Fourth National Climate Assessment, Volume II." Washington, D.C.: U.S. Global Change Research Program. doi:10.7930/NCA4.2018.
- . 2018. "Impacts, Risks, and Adaptation in the United States: Fourth National Climate Assessment, Volume II." Washington, D.C.: U.S. Global Change Research Program. doi:10.7930/NCA4.2018.
- . 2018. "Impacts, Risks, and Adaptation in the United States: Fourth National Climate Assessment, Volume II." Washington, D.C.: U.S. Global Change Research Program. [https://www.nifc.gov/fireInfo/fireInfo\\_stats\\_totalFires.html](https://www.nifc.gov/fireInfo/fireInfo_stats_totalFires.html).
- . 2016. "The Impacts of Climate Change on Human Health in the United States: A Scientific Assessment."
- Viskari, E.L. 2000. "Epicuticular wax of Norway spruce needles as indicator of traffic pollutant deposition." *Water, Air, and Soil Pollut.* 121: 327-337.
- Volk, H.E., I. Hertz-Picciotto, L. Delwiche, and et al. 2011. "Residential proximity to freeways and autism in the CHARGE study." *Environ Health Perspect* 119: 873-877.
- WMO. 2018. "Scientific Assessment of Ozone Depletion: 2018 Global Ozone Research and Monitoring Project – Report No. 58." Geneva, Switzerland: World Meteorological Association.
- Wolfe, P., K. Davidson, C. Fulcher, N. Fann, M. Zawacki, and K. R. Baker. 2019. "Monetized Health Benefits Attributable to Mobile Source Emission Reductions across the United States in 2025." *Science of the Total Environment* (650): 2490-2498. doi:<https://doi.org/10.1016/J.SCITOTENV.2018.09.273>.
- Wu et al., X, Braun, D, Schwartz, J, Kioumourtzoglou, M and Dominici, F. 2020. "Evaluating the impact of long-term exposure to fine particulate matter on mortality among the elderly." *Science Advances* 6 (29): eaba5692.
- Wu, J., M. Wilhelm, J. Chung, and et al. 2011. "Comparing exposure assessment methods for traffic-related air pollution in and adverse pregnancy outcome study." *Environ Res* 111: 6685-6692.
- Zanobetti, A., P.H. Stone, F.E. Spelzer, J.D. Schwartz, B.A. Coull, H.H. Suh, B.D. Nearling, M.A. Mittleman, R.L. Verrier, and D.R. Gold. 2009. "T-wave alternans, air pollution and traffic in high-risk subjects." *Am J Cardiol* 104: 665-670.



Zhang, J., J.E. McCreanor, P. Cullinan, and et al. 2009. "Health effects of real-world exposure diesel exhaust in persons with asthma." Res Rep Health Effects Inst 138.

Ziska, L, A Crimmins, A Auclair, S DeGrasse, J F Garofalo, A S Khan, I Loladze, et al. 2016. "Ch. 7: Food Safety, Nutrition, and Distribution. The Impacts of Climate Change on Human Health in the United States: A Scientific Assessment." Washington, D.C.: U.S. Global Change Research Program. 189-216.

## **Chapter 7: Analysis of Air Quality Impacts of Light- and Medium-Duty Vehicles Regulatory Scenario**

For this final rule, EPA conducted an air quality modeling (AQM) analysis of the proposed standards involving light- and medium-duty "onroad" vehicle emission reductions and corresponding changes in "upstream" emission sources like EGUs (electric generating units) and refineries. The analysis provides insight into the air quality impacts associated with emissions increases and decreases from these multiple sectors.

This chapter presents a discussion of current air quality in Chapter 7.1, information about the inventory used in the AQM analysis in Chapter 7.2, details related to the methodology used for the AQM analysis in Chapter 7.3, results of the AQM analysis in Chapter 7.4, and quantified and monetized benefits of the analysis in Chapter 7.5. Chapter 7.6 presents results of a demographic analysis based on the AQM.

### **7.1 Current Air Quality**

In this section, we present information related to current air pollutant concentrations and deposition amounts. This provides context for the modeled projections presented in Chapter 7.4.

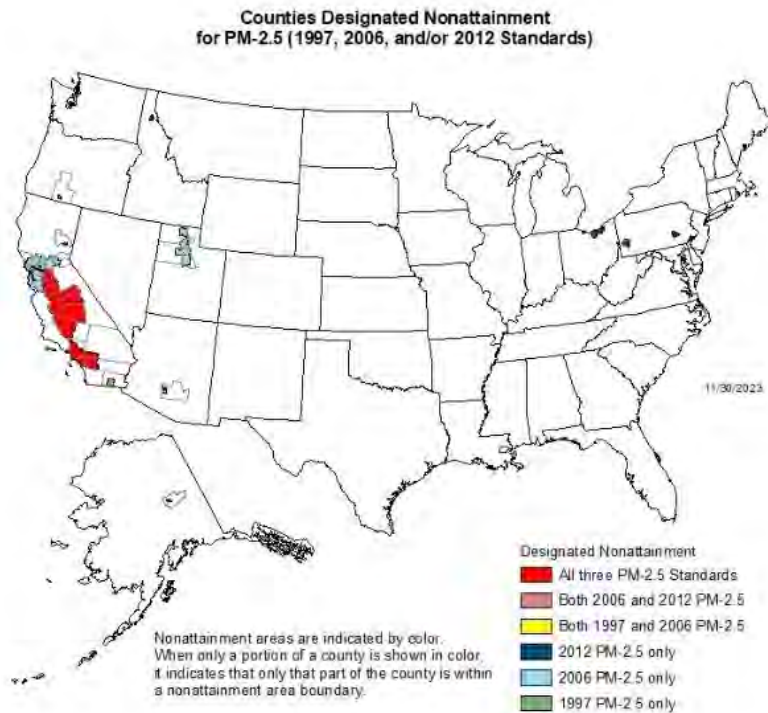
#### **7.1.1 PM<sub>2.5</sub> Concentrations**

As described in Chapter 6 of this RIA, PM causes adverse health effects, and EPA has set NAAQS to protect against those health effects. There are two primary NAAQS for PM<sub>2.5</sub>: an annual standard (9.0 micrograms per cubic meter ( $\mu\text{g}/\text{m}^3$ )) and a 24-hour standard (35  $\mu\text{g}/\text{m}^3$ ), and there are two secondary NAAQS for PM<sub>2.5</sub>: an annual standard (15.0  $\mu\text{g}/\text{m}^3$ ) and a 24-hour standard (35  $\mu\text{g}/\text{m}^3$ ). The initial PM<sub>2.5</sub> standards were set in 1997 and revisions to the standards were finalized in 2006, in 2012, retained in 2020, and finalized in 2024. On February 7, 2024, EPA finalized a rule to revise the primary annual PM<sub>2.5</sub> standard to 9.0  $\mu\text{g}/\text{m}^3$ . (U.S. EPA 2024)

There are areas of the country that are currently in nonattainment for the annual and 24-hour primary PM<sub>2.5</sub> NAAQS. As of November 30, 2023, more than 19 million people lived in the 3 areas that are designated as nonattainment for the 1997 annual PM<sub>2.5</sub> NAAQS. (U.S. EPA 2023) Also, as of November 30, 2023, more than 31 million people lived in the 11 areas that are designated as nonattainment for the 2006 24-hour PM<sub>2.5</sub> NAAQS, and more than 20 million people lived in the 5 areas designated as nonattainment for the 2012 annual PM<sub>2.5</sub> NAAQS. (U.S. EPA 2023) (U.S. EPA 2023) In total, there are currently 12 PM<sub>2.5</sub> nonattainment areas with a population of more than 32 million people. (U.S. EPA 2023)<sup>236</sup> Nonattainment areas for the PM<sub>2.5</sub> NAAQS, as of November 30, 2023, are pictured in Figure 7-1.

---

<sup>236</sup> The population total is calculated by summing, without double counting, the 1997, 2006 and 2012 PM<sub>2.5</sub> nonattainment populations contained in the Criteria Pollutant Nonattainment Summary report (<https://www.epa.gov/green-book/green-book-data-download>).



**Figure 7-1: Counties designated nonattainment for PM<sub>2.5</sub> (1997, 2006, and/or 2012 standards).**

The final standards will take effect in 2027 and may assist areas with attaining the NAAQS and may relieve areas with already stringent local regulations from some of the burden associated with adopting additional local controls. The rule may also provide assistance to counties with ambient concentrations near the level of the NAAQS who are working to ensure long-term attainment or maintenance of the PM<sub>2.5</sub> NAAQS.

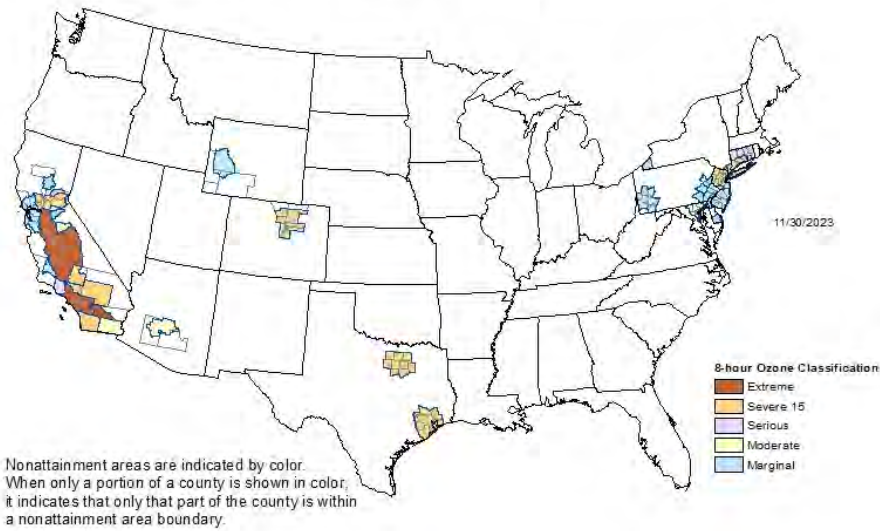
### **7.1.2 Ozone Concentrations**

As described in Chapter 6 of this RIA, ozone causes adverse health effects, and EPA has set national ambient air quality standards (NAAQS) to protect against those health effects. The primary NAAQS for ozone, established in 2015 and retained in 2020, is an 8-hour standard with a level of 0.07 ppm. (U.S. EPA 2020) EPA is also implementing the previous 8-hour ozone primary standard, set in 2008 at a level of 0.075 ppm. As of November 30, 2023, there were 34 ozone nonattainment areas for the 2008 primary ozone NAAQS, composed of 133 full or partial counties, with a population of more than 90 million (see Figure 7-2); there were 46 ozone nonattainment areas for the 2015 primary ozone NAAQS, composed of 191 full or partial counties, with a population of more than 115 million (see Figure 7-3). (U.S. EPA 2023) (U.S. EPA 2023) In total, there are currently (as of November 30, 2023) 54 ozone nonattainment areas with a population of more than 119 million people. (U.S. EPA 2023).<sup>237</sup>

---

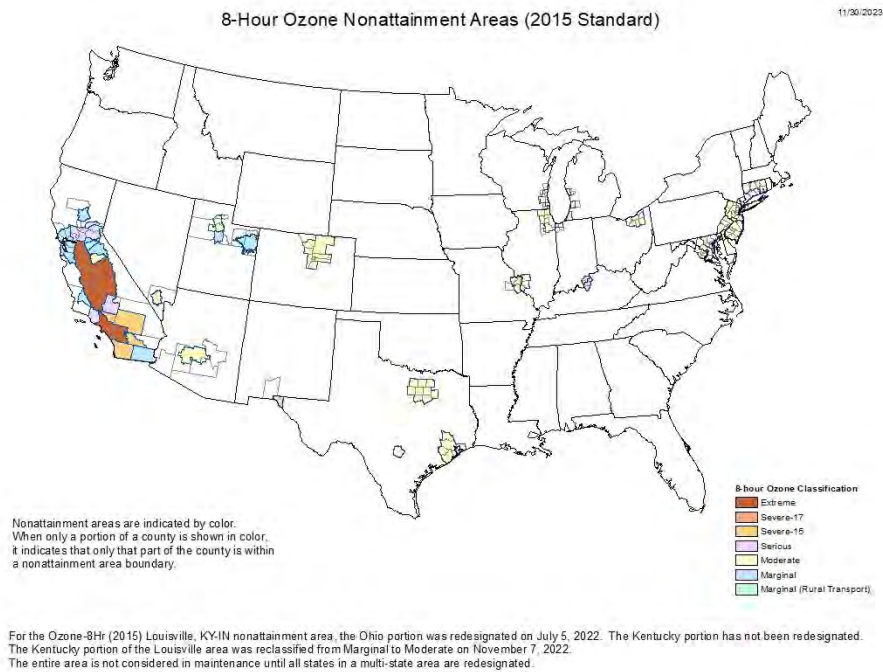
<sup>237</sup> The total population is calculated by summing, without double counting, the 2008 and 2015 ozone nonattainment populations contained in the Criteria Pollutant Nonattainment Summary report (<https://www.epa.gov/green-book/green-book-data-download>).

8-Hour Ozone Nonattainment Areas (2008 Standard)



**Figure 7-2: 8-Hour ozone nonattainment areas (2008 Standard).**

8-Hour Ozone Nonattainment Areas (2015 Standard)



**Figure 7-3: 8-Hour ozone nonattainment areas (2015 Standard).**

States with ozone nonattainment areas are required to take action to bring those areas into attainment. The attainment date assigned to an ozone nonattainment area is based on the area’s classification. The attainment dates for areas designated nonattainment for the 2008 8-hour ozone NAAQS are in the 2015 to 2032 timeframe, depending on the severity of the problem in each area. Attainment dates for areas designated nonattainment for the 2015 ozone NAAQS are

in the 2021 to 2038 timeframe, again depending on the severity of the problem in each area. The standards will take effect starting in MY 2027 and may assist areas with attaining the NAAQS and may relieve areas with already stringent local regulations from some of the burden associated with adopting additional local controls. The rule may also provide assistance to counties with ambient concentrations near the level of the NAAQS who are working to ensure long-term attainment or maintenance of the NAAQS.

### **7.1.3 NO<sub>2</sub> Concentrations**

There are two primary NAAQS for NO<sub>2</sub>: an annual standard (53 ppb) and a 1-hour standard (100 ppb).<sup>238</sup> In 2010, EPA established requirements for monitoring NO<sub>2</sub> near roadways expected to have the highest concentrations of NO<sub>2</sub> within large cities. Monitoring within this near-roadway network began in 2014, with additional sites deployed in the following years. At present, there are no nonattainment areas for NO<sub>2</sub>.

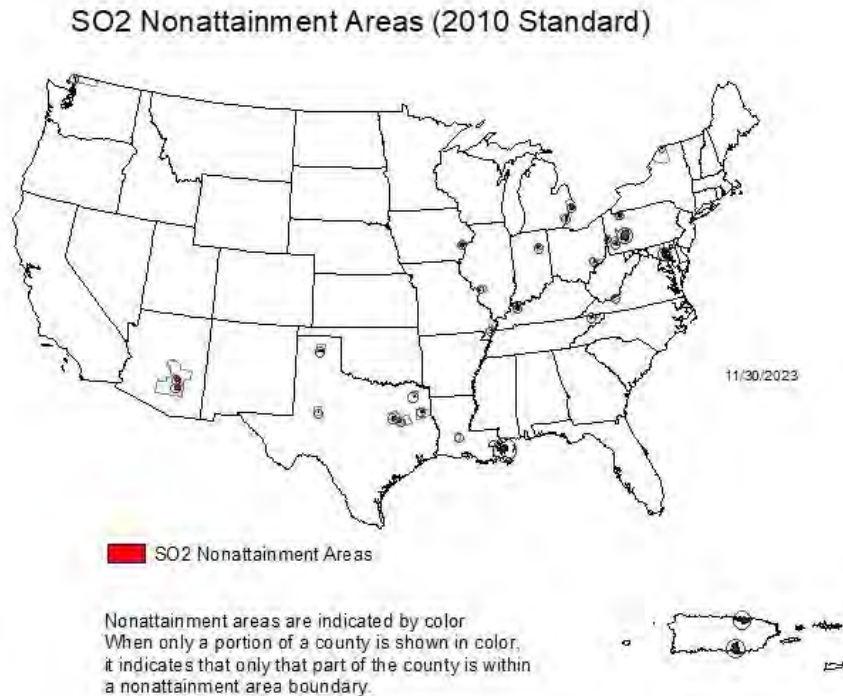
### **7.1.4 SO<sub>2</sub> Concentrations**

EPA most recently completed a review of the primary SO<sub>2</sub> NAAQS in February 2019 and decided to retain the existing 2010 SO<sub>2</sub> NAAQS. (US EPA 2023) The current primary NAAQS for SO<sub>2</sub> is a 1-hour standard of 75 ppb.<sup>239</sup> As of November 30, 2023, there are 40 counties that make up 30 SO<sub>2</sub> nonattainment areas, with a population of over 2 million people. (U.S. EPA 2023).

---

<sup>238</sup> The statistical form of the 1-hour NAAQS for NO<sub>2</sub> is the 3-year average of the yearly distribution of 1-hour daily maximum concentrations.

<sup>239</sup> The statistical form of the 1-hour NAAQS for SO<sub>2</sub> is the 3-year average of the 99th percentile of 1-hour daily maximum concentrations.



**Figure 7-4: Counties designated nonattainment for SO<sub>2</sub> (2010 standard).**

### **7.1.5 CO Concentrations**

There are two primary NAAQS for CO: an 8-hour standard (9 ppm) and a 1-hour standard (35 ppm). There are currently no CO nonattainment areas; as of September 27, 2010, all CO nonattainment areas had been redesignated to attainment.

### **7.1.6 Air Toxics Concentrations**

The most recent available data indicate that millions of Americans live in areas where air toxics pose potential health concerns. (U.S. EPA 2022) The levels of air toxics to which people are exposed vary depending on where people live and work and the kinds of activities in which they engage, as discussed in detail in EPA's 2007 Mobile Source Air Toxics Rule. (U.S. EPA 2007) According to EPA's 2017 National Emissions Inventory (NEI), mobile sources were responsible for 39 percent of outdoor anthropogenic toxic emissions. Further, mobile sources were the largest contributor to national average risk of cancer and immunological and respiratory health effects from directly emitted pollutants, according to EPA's Air Toxics Screening Assessment (AirToxScreen) for 2019. (U.S. EPA 2022)<sup>240</sup> Mobile sources are also significant contributors to precursor emissions which react to form air toxics. (Cook, et al. 2020) Formaldehyde is the largest contributor to cancer risk of all 72 pollutants quantitatively assessed in the 2019 AirToxScreen. Mobile sources were responsible for 26 percent of primary anthropogenic emissions of this pollutant in the 2017 NEI and are significant contributors to

---

<sup>240</sup> AirToxScreen also includes estimates of risk attributable to background concentrations, which includes contributions from long-range transport, persistent air toxics, and natural sources; as well as secondary concentrations, where toxics are formed via secondary formation. Mobile sources substantially contribute to long-range transport and secondarily formed air toxics.

formaldehyde precursor emissions. Benzene is also a large contributor to cancer risk, and mobile sources account for about 60 percent of average exposure to ambient concentrations.

### **7.1.7 Deposition**

Over the past two decades, the EPA has undertaken numerous efforts to reduce nitrogen and sulfur deposition across the U.S. Analyses of monitoring data for the U.S. show that deposition of nitrogen and sulfur compounds has decreased over the last 25 years. At 34 long-term monitoring sites in the eastern U.S., where data are most abundant, average total nitrogen deposition decreased by 43 percent between 1989-1991 and 2014-2016. (U.S. EPA 2022) Although total nitrogen deposition has decreased over time, many areas continue to be negatively impacted by deposition.

### **7.1.8 Visibility**

As of November 30, 2023, over 32 million people live in areas that are designated nonattainment for the PM<sub>2.5</sub> NAAQS. Overall, the evidence is sufficient to conclude that a causal relationship exists between PM and visibility impairment. (U.S. EPA 2019) Thus, the populations who live in nonattainment areas and travel to these areas will likely be experiencing visibility impairment. Additionally, while visibility trends have improved in Mandatory Class I Federal areas, these areas continue to suffer from visibility impairment. (US EPA 2023) (US EPA 2018) (US EPA 2020)<sup>241</sup> In summary, visibility impairment is experienced throughout the U.S., in multi-state regions, urban areas, and remote Mandatory Class I Federal areas.

## **7.2 Emissions Modeling for Air Quality Analysis**

Air pollution emission inventories are an important input to AQM. This section describes the modeled changes to onroad emissions from light- and medium-duty vehicles, as well as modeled emission changes from "upstream" sectors like electricity generating units (EGUs) and refineries. Emission inventories for unchanging sectors are referenced in the AQM Memo to the Docket. (U.S. EPA 2024b)

For this analysis, AQM was performed for a 2016 base case, a 2055 reference scenario, and a 2055 light- and medium-duty vehicle (LMDV) policy scenario. The "reference" scenario represents projected 2055 emissions and air quality without any additional LMDV controls. The LMDV "policy" scenario is based on the proposed standards. In this scenario, we estimated that battery electric vehicle (BEV) penetration would reach 71 percent for passenger cars and 66 percent for light-duty trucks in model year 2050. The policy scenario also assumes a phase-in of gasoline particulate filters (GPF) for gasoline vehicles beginning for model year 2027 and later. Air quality modeling was done for the future year 2055 when the LMDV policy scenario will be fully implemented and when most of the regulated fleet will have turned over. The emissions used for the policy scenario were the same as those in the reference scenario for all emissions sectors except for onroad mobile source emissions, EGU emissions, and petroleum sector emissions (specifically refineries, crude oil production well sites, and natural gas production well sites). The net changes in emissions for these sectors is summarized in Table 7-11 below.

---

<sup>241</sup> Mandatory Class I Federal areas are the 156 national parks and wilderness areas where state and federal agencies work to improve visibility.

The model used for the air quality analysis is the Community Multiscale Air Quality (CMAQ) model which requires hourly emissions of specific gas and particle species for the horizontal and vertical grid cells contained within the modeled region (i.e., modeling domain). Additional information on projecting air quality model-ready emissions is included in the AQM Memo to the Docket.

## **7.2.1 Onroad Vehicle Emission Estimates with MOVES**

### **7.2.1.1 Overview**

EPA’s MOtor Vehicle Emission Simulator (MOVES) is a state-of-the-science emissions modeling system that estimates air pollution emissions for criteria air pollutants, greenhouse gases, and air toxics. MOVES covers light-, medium-, and heavy-duty onroad vehicles such as cars, trucks and buses, and other mobile sources. MOVES accounts for the phase-in of federal emissions standards, vehicle and equipment activity, fuels, temperatures, humidity, and emission control activities such as inspection and maintenance (I/M) programs. (U.S. EPA 2023) Unlike the OMEGA model described elsewhere in the RIA, MOVES can be used to estimate emissions for specific counties as done here to capture geographical and temporal variation in onroad vehicle emissions.

Table 7-1 summarizes the change in total onroad emissions between the reference scenario and the policy scenario in calendar year 2055 as modeled for air quality analysis. Substantial reductions are seen for all pollutants.

**Table 7-1: Total onroad emissions impact in AQM policy scenario in 2055**

| <b>Pollutant</b>  | <b>Reference Scenario (tons/yr)</b> | <b>Policy Scenario (tons/yr)</b> | <b>Change in Emissions (tons/yr)</b> | <b>Percent Difference</b> |
|-------------------|-------------------------------------|----------------------------------|--------------------------------------|---------------------------|
| PM <sub>2.5</sub> | 34,667                              | 26,342                           | -8,325                               | -24%                      |
| NO <sub>X</sub>   | 403,861                             | 319,169                          | -84,692                              | -21%                      |
| SO <sub>2</sub>   | 6,458                               | 4,124                            | -2,334                               | -36%                      |
| VOC               | 502,643                             | 337,484                          | -165,159                             | -33%                      |

### **7.2.1.2 MOVES versions used for air quality modeling**

To generate the onroad emission inventories used for this AQM analysis, we developed internal regulatory versions of MOVES4. These versions incorporated all the substantive features of the public MOVES4.0 released August 30, 2023, but lacked some user-support tools and documentation, and used slightly different input databases. Table 7-2 lists the code and database versions associated with each of the three scenarios.

**Table 7-2: MOVES versions for AQM scenarios**

| <b>Scenario</b>         | <b>MOVES Code</b> | <b>MOVES Database</b> |
|-------------------------|-------------------|-----------------------|
| 2016 Base Year          | MOVES4.RC2        | movesdb20230515       |
| 2055 Reference Scenario | MOVES4.R1         | movesdb20230713       |
| 2055 Policy Scenario    | MOVES4.R2         | movesdb20230817       |

The code and database differences between these MOVES versions and the public MOVES4.0 are detailed in a docket memo. (Mo 2024) MOVES4.0 updates were peer reviewed



under EPA's peer review policy. (U.S. EPA 2015)(ERG 2023) (U.S. EPA 2023) Developing onroad inventories for the LMDV policy scenario required additional revised inputs as described in Section 7.2.1.4.

For both the reference and policy scenario, county-specific age distributions and fuel mix inputs were derived to preserve current differences between counties, such that counties with newer-than-average vehicle fleets and more light-duty electric vehicles than average in calendar year 2020 also have newer fleets and more electric vehicles in calendar year 2055. Additional detail is provided in the AQM Memo to the Docket.

### **7.2.1.3 Modeling the Reference scenario with MOVES**

The 2055 reference scenario was modelled with a slightly revised version of MOVES4.0. In particular, the electric vehicle fleet-wide CO<sub>2</sub> values for light-duty vehicles in the reference scenario were updated to be consistent with the OMEGA No Action case in the NPRM analysis. Similarly, LD electric vehicle sales were estimated using values from the NPRM OMEGA No Action case, reaching 33 percent and 36 percent in model year 2050 for light-duty trucks and passenger cars, respectively.

Electric vehicle fractions for heavy-duty vehicles were updated to reflect EPA's waiver of preemption for California's Advanced Clean Trucks (ACT) regulation. The national impact of the ACT was estimated based on the implementation of the rule in California and seven other states which had adopted the ACT at the time of analysis. In tandem with that work, heavy-duty electric vehicle adoption rates were updated for states that had not adopted the ACT. Finally, the energy efficiency of HD BEVs and Fuel Cell Electric Vehicles (FCEVs) was updated for consistency with EPA's analysis with the EPA TRUCS model. (Sui 2023)

Electric vehicle fractions for medium-duty vehicles were based on the updated modeling of ACT similarly to heavy-duty vehicles, except that adoption rates in non-ACT states were modeled using OMEGA.

### **7.2.1.4 Modeling the Policy scenario with MOVES**

The policy scenario was modeled with a light- and medium-duty fleet that phased-in new vehicle BEV sales based on NPRM OMEGA modeling of the proposed rule and an analysis of the expected national impact of California's ACT regulation. We assumed the required improvement in average CO<sub>2</sub> emissions for light-duty vehicles. For HC and NO<sub>x</sub> emissions, we modeled reduced fleet-wide emissions consistent with the proposed new bin structure. For PM, we modeled reduced LD gasoline vehicle organic carbon and elemental carbon rates consistent with predicted impact of GPFs based on OTAQ literature review and testing as described in 7.2.1.4.4.1. Vehicle age distributions were the same as in MOVES4.0. More details on each of these changes are provided below.

#### **7.2.1.4.1 EV sales and stock**

The policy scenario EV penetrations (fraction of new sales) for light-duty passenger cars and light-duty trucks were modeled in MOVES based on OMEGA EV outputs. These penetrations are fleet-wide BEV penetration by model year, with separate values for light-duty passenger cars and light-duty trucks. We assume BEV penetration will reach 71 percent for passenger cars and 66 percent for light-duty trucks in model year 2050. For medium-duty class 2b and 3, the policy

scenario was modeled based on an analysis of OMEGA NPRM outputs for the proposed standards and the expected national impact of California's ACT regulation. The distribution of EV sales among counties was similar to the reference scenario and is discussed in detail in the AQM Memo to the Docket.

Vehicle age distributions were the same as in the reference scenario.

#### **7.2.1.4.2 Internal Combustion Engine Vehicle Energy Consumption**

For the policy scenario modeling, the internal combustion engine vehicle (ICEV) energy rates (MY2027-MY2060) were adjusted to match rates from OMEGA modeling of a scenario in which EV sales were estimated as described above, and ICEV rates were limited by light-duty fleet-wide average standards that assume zero tailpipe CO<sub>2</sub> g/mi for BEVs and allow averaging between ICEVs and electric vehicles.

Energy consumption changes for medium-duty class 2b and 3 were driven by the EV fraction update in the policy scenario (described above). No additional adjustments were applied to the class 2b and 3 ICEV energy consumption rates to meet the LMDV policy scenario standards.

#### **7.2.1.4.3 ICEV HC and NO<sub>x</sub>**

After accounting for projected increases in the sales of electric vehicles following the onset of the phase-in period for the rule, we concluded that ICE vehicles meeting Tier-3 standards for NMOG+NO<sub>x</sub> as modelled in MOVES would comply with fleet-average requirements under the current rulemaking as well. Accordingly, the base emission rates for NO<sub>x</sub> and total hydrocarbons (THC) were not modified for the analyses supporting this RIA. This conclusion was reached by simulating FTP composite emissions for NMOG+NO<sub>x</sub> in MOVES using rates for the start- and running-exhaust emissions processes and applies to both light-duty and medium-duty vehicles.

However, the analyses also account for the possibility that the increased sales of electric vehicles could allow manufacturers to certify ICE vehicles to NMOG+NO<sub>x</sub> levels higher than they might absent the rule. This possibility was accounted for by assuming that manufacturers would certify ICE vehicles to the highest level achievable given assumed levels of EV sales in a given model year and within standard levels allowed by the rule. For light-duty vehicles, Tier-3 Bins above Bin70 were excluded to reflect the proposed bin changes under the LMDV. For medium-duty vehicles, fleet-average requirements are stringent enough that standard levels above Bin160 are effectively excluded. Adjustments to emissions levels to reflect these assumptions were developed and applied at the MOVES source type level through the emissionRateAdjustment table. For light-duty vehicles, adjustments range from 1.08-1.54. For medium-duty vehicles, adjustments ranged from 0.90-1.40 and 0.33-1.14 for vehicles in classes 2b and 3, respectively.

Additionally, the rule's provisions to control NMOG+NO<sub>x</sub> start emissions for "intermediate" soak periods were represented by reducing start emissions for soak periods between 40 minutes and 12 hours, covering MOVES operating modes 104 to 107. After verifying that Tier-3 rates at 45 minutes and 12 hours (operating modes 103 and 108) would meet requirements specific for those periods, we projected reduced emissions levels for the intervening periods by interpolating linearly between the levels at modes 103 and 108. These modifications were applied directly to the base rates for THC, CO, and NO<sub>x</sub> in the targeted operating modes in the MOVES emissionRateByAge table. Reductions are largest for NO<sub>x</sub>, THC, and CO, in that order.

#### 7.2.1.4.4 ICEV PM rates

PM emissions reductions were modeled for light-duty gasoline vehicles for model years 2027 and later. The modeled reductions were based on present-day GPFs as the best current PM reduction technology. GPFs filter PM in the exhaust, thus directly reducing PM emissions. The filter effectiveness differs for elemental carbon (EC) PM (MOVES Pollutant ID 112) and for non-EC PM (MOVES pollutant ID 118). To model the addition of GPFs, we apply a proportional reduction to the relevant start and running exhaust PM emission rates. In this case, the reductions are applied to start and running emissions for light-duty cars and trucks for gasoline, diesel and E85 fuels (MOVES fuelTypeID in 1,2,5).<sup>242</sup> For class 2b and 3 trucks, the reductions were applied for gasoline trucks only. Note, for MY 2010 and later, the MOVES emission rates for class 2b and 3 diesel trucks already included reductions representing control from diesel particulate filters (DPFs).

While we modeled substantial reductions in exhaust PM due to the rule, we model no change in brake and tire wear emissions, modeling BEVs with the same brake and tire wear as the ICEVs they replace.<sup>243</sup>

##### 7.2.1.4.4.1 PM emission reduction fractions

The reduction fractions applied to both EC and non-EC PM are derived from laboratory testing of a lightly loaded underfloor catalyzed GPF. (Bohac and Ludlum 2023) For that study, EC and organic carbon (OC) measurements were made using the NIOSH 870 method. Here, we use the observed reduction in EC to determine the reduction fraction for the MOVES EC pollutant. We use the observed OC reduction as the reduction fraction to apply to the MOVES non-EC PM pollutant. OC is not identical to non-EC PM because OC measurements do not include information about other elemental components of the particulate matter such as hydrogen, nitrogen, oxygen, calcium, and metallic ash components. For modeling purposes, we assume that the other components of non-EC PM are filtered by the GPF in the same proportion as the OC part.

The reduction factors for the start operating modes come from the study's 25°C FTP cycle tests. For running emissions excluding MOVES operating modes 30 and 40, the reduction factors come from averaging the results of the 60mph and highway fuel economy (HWFET) tests. The reduction fractions for operating modes 30 and 40 are from the US06 test. Finally, to avoid computational issues that arise from setting emission factors to zero, reductions originally reported as 100% were adjusted to 99.9%. The final PM reductions by operating mode are summarized in Table 7-3 below.

---

<sup>242</sup> While GPFs are relevant only for gasoline and E85 vehicles, in MOVES, the emission rates for light-duty gasoline vehicles were also applied to light-duty diesel. This has a negligible impact on calendar year 2055 emissions since we model the diesel fraction of the light-duty sales as less than 0.002% for all model years after 2018.

<sup>243</sup> Road dust, including road wear, is not modelled by MOVES, but is included in the air quality modeling as an area source. We modelled no difference in road dust from EVs as compared to ICEVs.

**Table 7-3: PM reduction by MOVES operating mode**

| Operating Modes | EC Reduction (%) | Non-EC PM Reduction (%) |
|-----------------|------------------|-------------------------|
| 0 - 29          | 99.9             | 75                      |
| 30              | 98.5             | 80                      |
| 33 - 39         | 99.9             | 75                      |
| 40              | 98.5             | 80                      |
| 101 - 108       | 99.9             | 91                      |

**7.2.1.4.4.2 PM reduction phase-in**

To model the air quality modeling policy scenario, we applied the PM reduction phase-in fractions shown in Table 7-4.

**Table 7-4: PM control fraction by MOVES reg class and model year**

| Model Year | Reg Class 20 | Reg Class 30 | Reg Class 41 |
|------------|--------------|--------------|--------------|
| 2026       | 0            | 0            | 0            |
| 2027       | 0.4          | 0.2          | 0            |
| 2028       | 0.8          | 0.4          | 0            |
| 2029       | 1            | 0.5          | 0            |
| 2030+      | 1            | 1            | 1            |

The phase-in was combined with the reduction factors for each operating mode to create weighted reduction factors for each model year. Finally, the weighted reduction factors were applied to the original MOVES base emission rates to create a set of new, lower PM emission rates.

**7.2.1.4.4.3 PM update for LEV rates**

The phase-in described above overlaps with the California 1 mg/mile PM standard that is relevant for California and for other states that have adopted California requirements under Clean Air Act Section 177. Prior to phasing in GPF-equivalent PM rates, the rates in the MOVES emissionRateByAgeLEV table were lower than the rates in the MOVES default emissionRateByAge table. For passenger cars, the policy scenario default values are lower than the LEV table values starting in model year 2027, and for light-duty trucks, the policy scenario default values are lower starting in 2030. Therefore, for the policy scenario modeling, the emissionRateByAgeLEV table was updated by dropping the rates for those years where the new default emission rates are lower than the LEV rates.

**7.2.2 Upstream Emission Estimates for AQ Modeling**

This section describes emission impacts estimated for the following "upstream" emission sources: EGU emissions (Chapter 7.2.2.1), refinery emissions (Chapter 0), emissions from crude oil production well sites and pipeline pumps (Chapter 7.2.2.3), and emissions from natural gas production well sites and pipeline pumps (Chapter 7.2.2.4).

EPA estimates that total upstream emissions in the policy scenario will decrease compared to the reference scenario.

Table 7-5 presents the net impact of the upstream sources by pollutant in 2055. The impacts include a projected increase in emissions from EGUs, as well as increased emissions projected

from natural gas production well sites and pipeline pumps, due to a projected increase in natural gas fueled EGUs. The emission impacts also include a projected decrease in emissions from refineries and crude production wells and pipeline pumps due to assumed decreases in activity at refineries related to a decrease in demand for liquid fuels for light- and medium-duty vehicles.

**Table 7-5: Total upstream emissions impact in AQM policy scenario in 2055**

| <b>Pollutant</b>  | <b>Reference Scenario (tons/yr)</b> | <b>Policy Scenario (tons/yr)</b> | <b>Change in Emissions (tons/yr)</b> | <b>Percent Difference</b> |
|-------------------|-------------------------------------|----------------------------------|--------------------------------------|---------------------------|
| PM <sub>2.5</sub> | 64,115                              | 62,722                           | -1,393                               | -2%                       |
| NO <sub>x</sub>   | 814,881                             | 805,238                          | -9,643                               | -1%                       |
| SO <sub>2</sub>   | 142,170                             | 139,241                          | -2,929                               | -2%                       |
| VOC               | 2,852,174                           | 2,823,145                        | -29,029                              | -1%                       |

There is uncertainty about the impact of reduced demand for petroleum fuels on refinery activity and emissions. In response to comments, we have updated our estimates of the impacts of reduced domestic fuel demand on U.S. refining. In the NPRM illustrative AQ analysis, we projected that the LMDV regulatory scenario would result in lower demand for onroad fuels and therefore reduce emissions from fuel refineries. The NPRM assumed that most of the refined product demand caused by the proposed rulemaking would result in a similar reduction in U.S. refinery operations (93 percent), and a sensitivity analysis was performed where U.S. refineries continued to operate at their current capacities. As noted by commenters, there are good economic reasons why U.S. refineries might continue to operate despite reduced domestic demand, leading to increased exports. Therefore, for this final rule analysis, we assumed that more of the drop in domestic demand would be offset by increased exports than in the NPRM analysis (see discussion in Chapter 0).

#### **7.2.2.1 Electricity Generating Units (EGUs)**

The EGU emissions inventories used in the air quality analysis were developed from 2050 outputs of the 2022 post-IRA Reference Case run of the Integrated Planning Model (IPM). This version of IPM included EGU fleet information and rules and regulations that were final at the time the IPM version was finalized, and included supply-side impacts (production and investment tax credits) associated with the Inflation Reduction Act (IRA). (U.S. EPA 2023) More detail on the rules and regulations included in this version of IPM, as well as additional information on the IPM version, can be found in the AQM Memo to the Docket.

Emissions of select pollutants from EGUs in 2050 (representing 2055 levels) are shown in Table 7-6. The policy scenario caused an increase in emissions of all pollutants, which is expected as the policy case includes an increase in electric vehicles.

**Table 7-6: EGU emissions impact in AQM inventories in 2055<sup>244</sup>**

| <b>Pollutant</b>  | <b>Reference Scenario (tons/yr)</b> | <b>Policy Scenario (tons/yr)</b> | <b>Change in Emissions (tons/yr)</b> | <b>Percent Difference</b> |
|-------------------|-------------------------------------|----------------------------------|--------------------------------------|---------------------------|
| PM <sub>2.5</sub> | 26,420                              | 27,459                           | 1,039                                | 4%                        |
| NO <sub>x</sub>   | 95,934                              | 97,539                           | 1,605                                | 2%                        |
| SO <sub>2</sub>   | 17,117                              | 19,063                           | 1,946                                | 11%                       |
| VOC               | 17,023                              | 17,490                           | 467                                  | 3%                        |

### 7.2.2.2 Refineries

The reference scenario refinery emission inventories used in the air quality analysis were a subset of the refinery emissions in the 2016v3 emissions modeling platform that were projected to 2050 using the reference case modeled by EIA in its 2023 Annual Energy Outlook (AEO) (U.S. EIA 2023) (U.S. EPA 2023). Pollutant-specific adjustment factors were developed and then applied to the reference scenario inventory to generate the policy scenario inventory. These adjustment factors are presented in

Table 7-7 and account for reduced domestic fuel demand in response to the policy scenario (proposed standards).

As mentioned above, in the NPRM air quality analysis, we assumed that 7% of the reduced domestic demand for refined fuels would be made up by an increase in exports, based on a comparison of the reference case and low economic growth case in AEO 2021. We received comments from several organizations that refineries would increase exports more than we assumed. After taking into consideration stakeholder comments, the more desirable economic conditions for refiners in the U.S., and the recent closures and conversions of some U.S. refineries, we have updated our projection of how refineries will be impacted by this rulemaking. For this final rule AQM analysis, we estimated policy case refinery emissions by assuming that U.S. refineries would increase exports to offset half of the projected reductions in domestic demand for liquid fuels. Thus, the total decrease in refinery activity, measured in gallons of gasoline and diesel refined, is half of the estimated drop in domestic fuel demand. Additional detail on how the adjustment factors were calculated is available in the AQM Memo to the Docket.

**Table 7-7: Adjustment factors to apply to 2050 refinery inventory**

| <b>Pollutant</b>  | <b>Policy Scenario</b> |
|-------------------|------------------------|
| PM <sub>2.5</sub> | 0.86                   |
| NO <sub>x</sub>   | 0.86                   |
| SO <sub>2</sub>   | 0.87                   |
| VOC               | 0.87                   |

---

<sup>244</sup> IPM output for a set of years with the furthest out year being 2055. The 2050 output was used in the air quality analysis and was assumed to represent 2055 to avoid any "end of timeframe" issues with using the furthest out year output from the model.

Emissions decreases of select pollutants from refineries in 2055 are shown in Table 7-8.

**Table 7-8: Refinery emissions impact in AQM inventories in 2055**

| Pollutant         | Reference Scenario (tons/yr) | Policy Scenario (tons/yr) | Change in Emissions (tons/yr) | Percent Difference |
|-------------------|------------------------------|---------------------------|-------------------------------|--------------------|
| PM <sub>2.5</sub> | 18,867                       | 16,399                    | -2,467                        | -13%               |
| NO <sub>x</sub>   | 80,188                       | 69,720                    | -10,468                       | -13%               |
| SO <sub>2</sub>   | 25,846                       | 22,779                    | -3,067                        | -12%               |
| VOC               | 62,842                       | 55,637                    | -7,205                        | -12%               |

### 7.2.2.3 Crude Production Well Sites and Pipeline Pumps

The reference case emission inventories for crude production well sites and associated pipeline pumps used in the air quality analysis were developed from emissions in the 2016v3 emissions modeling platform that were projected to 2050 using the reference case modeled by EIA in its 2023 AEO (U.S. EIA 2023) (U.S. EPA 2023). Policy case emissions were decreased (through application of an adjustment factor) to account for lower activity due to lower domestic demand for liquid fuels. This adjustment factor is 0.98 and additional detail on how the adjustment factor was calculated is available in the AQM Memo to the Docket. Decreases in emissions of select pollutants from crude production well sites and pipeline pumps in 2055 are shown in Table 7-9.

**Table 7-9: Crude production well site and pipeline pump impact in AQM inventories in 2055**

| Pollutant         | Reference Scenario (tons/yr) | Policy Scenario (tons/yr) | Change in Emissions (tons/yr) | Percent Difference |
|-------------------|------------------------------|---------------------------|-------------------------------|--------------------|
| PM <sub>2.5</sub> | 5,102                        | 5,000                     | -102                          | -2%                |
| NO <sub>x</sub>   | 238,895                      | 234,117                   | -4,778                        | -2%                |
| SO <sub>2</sub>   | 93,330                       | 91,464                    | -1,867                        | -2%                |
| VOC               | 1,667,134                    | 1,633,791                 | -33,343                       | -2%                |

### 7.2.2.4 Natural Gas Production Well Sites and Pipeline Pumps

The reference case emission inventories for natural gas production well sites and associated pipeline pumps used in the air quality analysis were developed from emissions in the 2016v3 emissions modeling platform that were projected to 2050 using the reference case modeled by EIA in its 2023 AEO (U.S. EIA 2023) (U.S. EPA 2023). Policy case emissions were increased (through application of an adjustment factor) to account for increased activity at natural gas production well sites and pipeline pumps consistent with increased demand for natural gas fueled EGUs. This adjustment factor is 1.01 and additional detail on how the adjustment factor was calculated is available in the AQM Memo to the Docket. Increases in emissions of select pollutants from natural gas production well sites and pipeline pumps in 2055 are shown in

Table 7-10.

**Table 7-10: Natural gas production well and pipeline pump impact in AQM inventories in 2055**

| Pollutant         | Reference Scenario (tons/yr) | Policy Scenario (tons/yr) | Change in Emissions (tons/yr) | Percent Difference |
|-------------------|------------------------------|---------------------------|-------------------------------|--------------------|
| PM <sub>2.5</sub> | 13,726                       | 13,863                    | 137                           | 1%                 |
| NO <sub>X</sub>   | 399,863                      | 403,862                   | 3,999                         | 1%                 |
| SO <sub>2</sub>   | 5,876                        | 5,935                     | 59                            | 1%                 |
| VOC               | 1,105,175                    | 1,116,227                 | 11,052                        | 1%                 |

### 7.2.2.5 Limitations of the Upstream Inventory

There is uncertainty associated with the upstream inventory. The air quality analysis assumes that there is no change in mandated renewable fuel volumes and percentages, that refineries will decrease some of their activity rather than export additional fuels, that the decreased production occurs at the same rate at all refineries and at all crude production wells and pipeline pumps, and that increased production occurs at the same rate at all natural gas production wells and pipeline pumps. In addition, projections out to 2055 inherently are less certain than projections that do not go out as far into the future. Lastly, the upstream emissions inventory does not account for all upstream sources related to vehicles, fuels, and electricity generation, such as charging infrastructure, storage of petroleum fuels, battery manufacture, etc.

### 7.2.3 Combined Onroad and Upstream Emission Impacts

Total onroad, upstream, and net emissions of select pollutants in 2055 are shown in

Table 7-11. The policy case has lower combined onroad and upstream emissions than the reference case, driven by reductions in the onroad sector.

**Table 7-11: Net impacts<sup>a</sup> on criteria pollutant emissions from the LMDV regulatory scenario.**

| Pollutant         | 2055 AQM Reference Scenario (tons/yr) |           |                           | 2055 AQM Policy Scenario (tons/yr) |           |                           | Net Emissions Impact (tons/yr) | Percent Change Emissions Impact |
|-------------------|---------------------------------------|-----------|---------------------------|------------------------------------|-----------|---------------------------|--------------------------------|---------------------------------|
|                   | Onroad                                | Upstream  | Total Onroad and Upstream | Onroad                             | Upstream  | Total Onroad and Upstream |                                |                                 |
| PM <sub>2.5</sub> | 34,667                                | 64,115    | 98,782                    | 26,342                             | 62,722    | 89,063                    | -9,719                         | -10%                            |
| NO <sub>X</sub>   | 403,861                               | 814,881   | 1,218,742                 | 319,169                            | 805,238   | 1,124,407                 | -94,335                        | -8%                             |
| SO <sub>2</sub>   | 6,458                                 | 142,170   | 148,628                   | 4,124                              | 139,241   | 143,365                   | -5,263                         | -4%                             |
| VOC               | 502,643                               | 2,852,174 | 3,354,817                 | 337,484                            | 2,823,145 | 3,160,629                 | -194,188                       | -6%                             |

<sup>a</sup> Emissions reductions are presented as negative numbers and emissions increases as positive numbers.



### 7.3 Air Quality Modeling Methodology

In this section we present information related to the methods used in the air quality analysis for this final rule. Additional information is available in the AQM Memo to the Docket. (U.S. EPA 2024b)

#### 7.3.1 Air Quality Model

CMAQ is a non-proprietary computer model that simulates the formation and fate of photochemical oxidants, primary and secondary PM concentrations, acid deposition, and air toxics, over regional and urban spatial scales for given inputs of meteorological conditions and emissions. CMAQ includes numerous science modules that simulate the emission, production, decay, deposition, and transport of organic and inorganic gas-phase and particle pollutants in the atmosphere. The CMAQ model is a well-known and well-respected tool and has been used in numerous national and international applications. (US EPA 2023) The AQM completed for this rule used the 2016v3 platform with the most recent multi-pollutant CMAQ code available at the time of AQM (CMAQ version 5.4). (UNC Institute for the Environment 2023) The 2016 CMAQ runs utilized the CB6r5 chemical mechanism (Carbon Bond with linearized halogen chemistry) for gas-phase chemistry, and AERO7 (aerosol model with non-volatile primary organic aerosol) for aerosols. The CMAQ model is regularly peer-reviewed; CMAQ versions 5.2 and 5.3 beta were most recently peer-reviewed in 2019 for the U.S. EPA. (Versar, Inc 2019)

#### 7.3.2 Model Domain and Configuration

The CMAQ modeling analyses used a domain covering the continental United States, as shown in Figure 7-5. This single domain covers the entire continental U.S. (CONUS) and large portions of Canada and Mexico using 12 km × 12 km horizontal grid spacing. The 2016 simulation used a Lambert Conformal map projection centered at (-97, 40) with true latitudes at 33 and 45 degrees north. The model extends vertically from the surface to 50 millibars (approximately 17,600 meters) using a sigma-pressure coordinate system with 35 vertical layers. Table 7-12 provides some basic geographic information regarding the CMAQ domains and Table 7-13 provides the vertical layer structure for the CMAQ domain.

**Table 7-12: Geographic elements of domains used in air quality modeling.**

|                          | <b>CMAQ Modeling Configuration</b>                             |
|--------------------------|--|
| <b>Grid Resolution</b>   | 12 km National Grid  |
| <b>Map Projection</b>    | Lambert Conformal Projection                                   |
| <b>Coordinate Center</b> | 97 deg W, 40 deg N   |
| <b>True Latitudes</b>    | 33 deg N and 45 deg N  |
| <b>Dimensions</b>        | 396 × 246 × 35   |
| <b>Vertical extent</b>   | 35 Layers: Surface to 50 millibar level<br>(see<br>Table 7-13) |

**Table 7-13: Vertical layer structure for CMAQ domain.**

| <b>Vertical Layers</b> | <b>Sigma P</b> | <b>Pressure (mb)</b> | <b>Approximate Height (m)</b> |
|------------------------|----------------|----------------------|-------------------------------|
| 35                     | 0.0000         | 50.00                | 17,556                        |
| 34                     | 0.0500         | 97.50                | 14,780                        |
| 33                     | 0.1000         | 145.00               | 12,822                        |
| 32                     | 0.1500         | 192.50               | 11,282                        |
| 31                     | 0.2000         | 240.00               | 10,002                        |
| 30                     | 0.2500         | 287.50               | 8,901                         |
| 29                     | 0.3000         | 335.00               | 7,932                         |
| 28                     | 0.3500         | 382.50               | 7,064                         |
| 27                     | 0.4000         | 430.00               | 6,275                         |
| 26                     | 0.4500         | 477.50               | 5,553                         |
| 25                     | 0.5000         | 525.00               | 4,885                         |
| 24                     | 0.5500         | 572.50               | 4,264                         |
| 23                     | 0.6000         | 620.00               | 3,683                         |
| 22                     | 0.6500         | 667.50               | 3,136                         |
| 21                     | 0.7000         | 715.00               | 2,619                         |
| 20                     | 0.7400         | 753.00               | 2,226                         |
| 19                     | 0.7700         | 781.50               | 1,941                         |
| 18                     | 0.8000         | 810.00               | 1,665                         |
| 17                     | 0.8200         | 829.00               | 1,485                         |
| 16                     | 0.8400         | 848.00               | 1,308                         |
| 15                     | 0.8600         | 867.00               | 1,134                         |
| 14                     | 0.8800         | 886.00               | 964                           |
| 13                     | 0.9000         | 905.00               | 797                           |
| 12                     | 0.9100         | 914.50               | 714                           |
| 11                     | 0.9200         | 924.00               | 632                           |
| 10                     | 0.9300         | 933.50               | 551                           |
| 9                      | 0.9400         | 943.00               | 470                           |
| 8                      | 0.9500         | 952.50               | 390                           |
| 7                      | 0.9600         | 962.00               | 311                           |
| 6                      | 0.9700         | 971.50               | 232                           |
| 5                      | 0.9800         | 981.00               | 154                           |
| 4                      | 0.9850         | 985.75               | 115                           |
| 3                      | 0.9900         | 990.50               | 77                            |
| 2                      | 0.9950         | 995.25               | 38                            |
| 1                      | 0.9975         | 997.63               | 19                            |
| 0                      | 1.0000         | 1000.00              | 0                             |



**Figure 7-5: Map of the CMAQ 12 km modeling domain (noted by the purple box).**

### **7.3.3 Model Inputs**

The key inputs to the CMAQ model include emissions from anthropogenic and biogenic sources, meteorological data, and initial and boundary conditions. The emissions inputs are summarized above in Chapter 7.2.

The CMAQ meteorological input files were derived from simulations of the Weather Research and Forecasting Model (WRF) version 3.8 for the entire 2016 year. (Skamarock 2008) (U.S. EPA 2019) The WRF Model is a state-of-the-science mesoscale numerical weather prediction system developed for both operational forecasting and atmospheric research applications. (National Center for Atmospheric Research 2022) The meteorological outputs from WRF were processed to create 12 km model-ready inputs for CMAQ using the Meteorology-Chemistry Interface Processor (MCIP) version 4.3. These inputs included hourly varying horizontal wind components (i.e., speed and direction), temperature, moisture, vertical diffusion rates, and rainfall rates for each grid cell in each vertical layer. (Byun, Ching and EPA 1999)

The boundary and initial species concentrations were provided by a northern hemispheric CMAQ modeling platform for the year 2016. (Henderson 2018) (Mathur 2017) The hemispheric-scale platform uses a polar stereographic projection at 108 km resolution to completely and

continuously cover the northern hemisphere for 2016. Meteorology is provided by WRF v3.8. Details on the emissions used for hemispheric CMAQ can be found in the 2016 hemispheric emissions modeling platform TSD. (U.S. EPA 2019) The atmospheric processing (transformation and fate) was simulated by CMAQ (v5.2.1) using the CB6r3 and the aerosol model with non-volatile primary organic carbon (AE6nvPOA). The CMAQ model also included the on-line windblown dust emission sources (excluding agricultural land), which are not always included in the regional platform but are important for large-scale transport of dust.

#### **7.3.4 Model Evaluation**

The CMAQ predictions for ozone, fine particulate matter, sulfate, nitrate, ammonium, organic carbon, elemental carbon, nitrogen and sulfur deposition, and specific air toxics (acetaldehyde, benzene, and formaldehyde) from the 2016 base scenario were compared to measured concentrations in order to evaluate the ability of the modeling platform to replicate observed concentrations. This evaluation was comprised of statistical and graphical comparisons of paired modeled and observed data. Details on the model performance evaluation, including a description of the methodology, the model performance statistics, and results, are provided in the AQM Memo to the Docket. (U.S. EPA 2024b)

#### **7.3.5 Model Simulation Scenarios**

As part of our analysis for this rulemaking, the CMAQ modeling system was used to calculate annual PM<sub>2.5</sub> concentrations and projected design values, 8-hour maximum average ozone season (April - Sept) concentrations and design values, annual NO<sub>2</sub>, SO<sub>2</sub>, and CO concentrations, annual and seasonal (summer and winter) air toxics concentrations, and annual nitrogen and sulfur deposition for each of the following scenarios:

- 2016 base year;
- 2055 reference;
- 2055 light- and medium-duty policy scenario based on proposed standards.

Decisions about the emissions and other elements used in the air quality modeling were made early in the analytical process for the final rulemaking and the decision was made to model the proposed standards. Accordingly, the air quality analysis does not fully represent the final regulatory scenario; however, we consider the modeling results to be a fair reflection of the impact the standards will have on air quality in 2055.

When possible, we use the predictions from the CMAQ model in a relative sense by combining the 2016 base-year predictions with predictions from the future-year scenario and applying these modeled ratios to ambient air quality observations to estimate future-year concentrations. The PM<sub>2.5</sub> and ozone concentrations are modeled using this relative method. The ambient air quality observations are average conditions, on a site-by-site basis, for a period centered around the model base year (i.e., 2014-2018).

The projected PM<sub>2.5</sub> concentrations and design values, and 8-hour ozone concentrations and design values, were calculated using the approach identified in EPA's guidance on air quality modeling attainment demonstrations. (US EPA 2018)

Additionally, we conducted an analysis to compare the absolute differences between the future year reference and policy scenario for annual and seasonal acetaldehyde, benzene, formaldehyde, and naphthalene, as well as annual NO<sub>2</sub>, SO<sub>2</sub>, CO, and nitrate/sulfate deposition. These data were not compared in a relative sense due to the limited observational data available.

#### **7.4 Results of Air Quality Analysis**

For this final rule, EPA conducted an air quality modeling analysis of the proposed standards involving light- and medium-duty "onroad" vehicle emission reductions and corresponding changes in "upstream" emission sources like EGU (electric generating unit) emissions and refinery emissions. We also modeled a sensitivity case that examined only the air quality impacts of the onroad emissions changes from the proposed standards. This "onroad-only" sensitivity case assumed no change in emissions from upstream sources and is based on the onroad emission inventories described in Chapter 7.2.1.

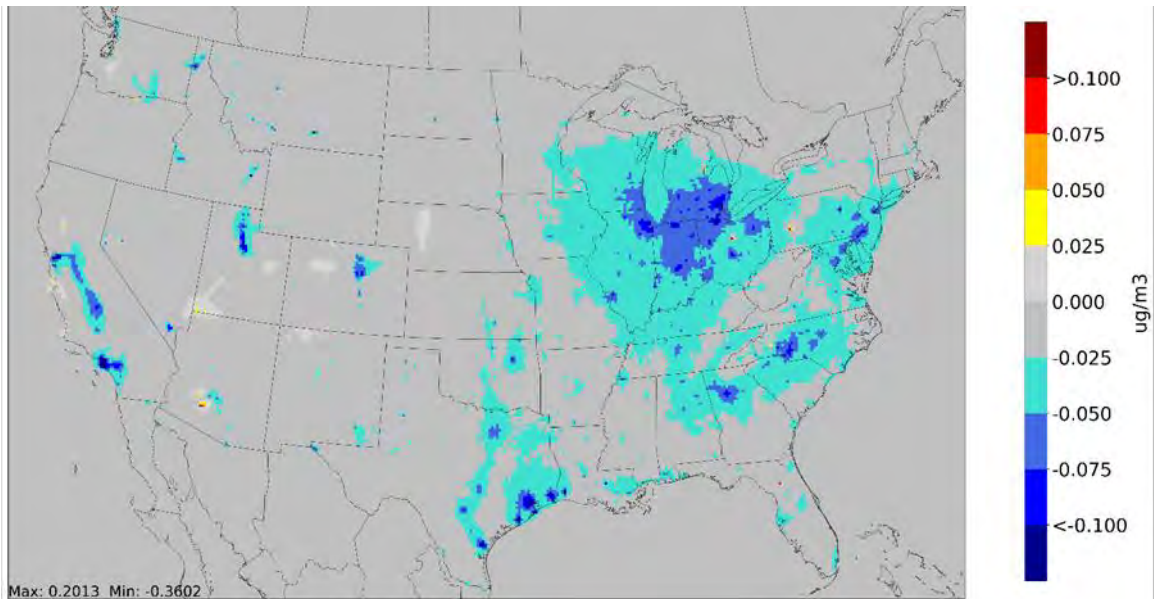
In this section, we summarize the results of our AQM based on the projected emission impacts of the policy scenario, as well as the onroad-only sensitivity case. Air quality modeling was done for the future year 2055, which is when the program will be fully implemented and when most of the regulated fleet will have turned over. The "reference" scenario represents projected 2055 air quality without the policy scenario, and the "policy" scenario represents projected 2055 emissions with the proposed standards. As described in Chapter 7.2, in this scenario we estimated that battery electric vehicle (BEV) penetration would reach 71 percent for passenger cars and 66 percent for light-duty trucks in model year 2050. The policy case also assumes a phase-in of gasoline particulate filters (GPF) for gasoline vehicles beginning in model year 2027.

##### **7.4.1 PM<sub>2.5</sub>**

###### **7.4.1.1 Overall Projected PM<sub>2.5</sub> Impacts**

This section summarizes projected changes in PM<sub>2.5</sub> concentrations in 2055 from the rule. Figure 7-6 presents the absolute changes in annual average PM<sub>2.5</sub> concentrations in 2055 between the reference and the policy scenario and indicates that there will be widespread decreases due to the projected reductions in primary PM, NO<sub>x</sub>, SO<sub>2</sub>, and VOC emissions, see

Table 7-11 (blue areas). In a few isolated areas, this rule is expected to result in increases in annual average PM<sub>2.5</sub>, likely due to increases in EGU emissions. We expect the power sector to become cleaner over time as a result of the IRA and future policies, which will reduce the air quality impacts of EGUs. Less than 0.1% of CMAQ grid cells are projected to have increases in annual average PM<sub>2.5</sub> concentration of  $\geq 0.025 \mu\text{g}/\text{m}^3$  (yellow and red areas), and only 0.1% of the population of CONUS lives in those areas.

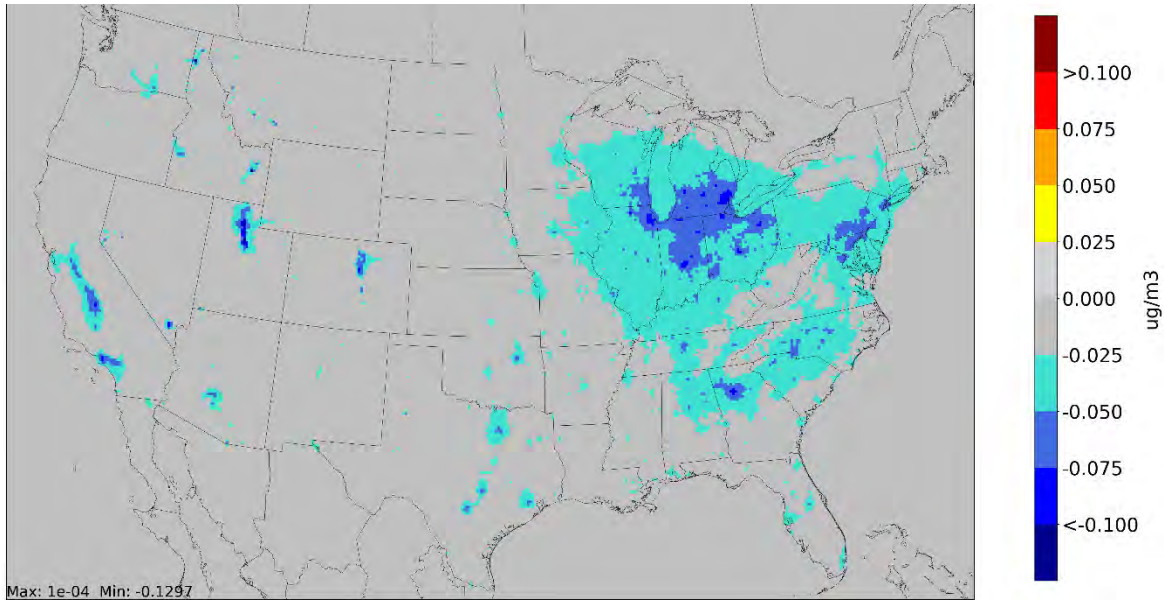


**Figure 7-6: Projected changes in annual average PM<sub>2.5</sub> concentrations in 2055 due to the rule.**

The rule will decrease annual average PM<sub>2.5</sub> concentrations by an average of 0.02  $\mu\text{g}/\text{m}^3$  in 2055, with a maximum decrease of 0.36  $\mu\text{g}/\text{m}^3$  and a maximum increase of 0.20  $\mu\text{g}/\text{m}^3$ . The population-weighted average change in annual average PM<sub>2.5</sub> concentrations will be a decrease of 0.04  $\mu\text{g}/\text{m}^3$  in 2055. We also expect that this rule’s reductions in directly emitted PM<sub>2.5</sub> will contribute to reductions in PM<sub>2.5</sub> concentrations near roadways, although our air quality modeling is not of sufficient resolution to capture that impact.

#### **7.4.1.2 Onroad-Only Projected PM<sub>2.5</sub> Impact**

We also modeled an “onroad-only” sensitivity case. Figure 7-7 presents the absolute changes in annual average PM<sub>2.5</sub> concentrations in 2055 between the reference and onroad-only sensitivity scenarios.

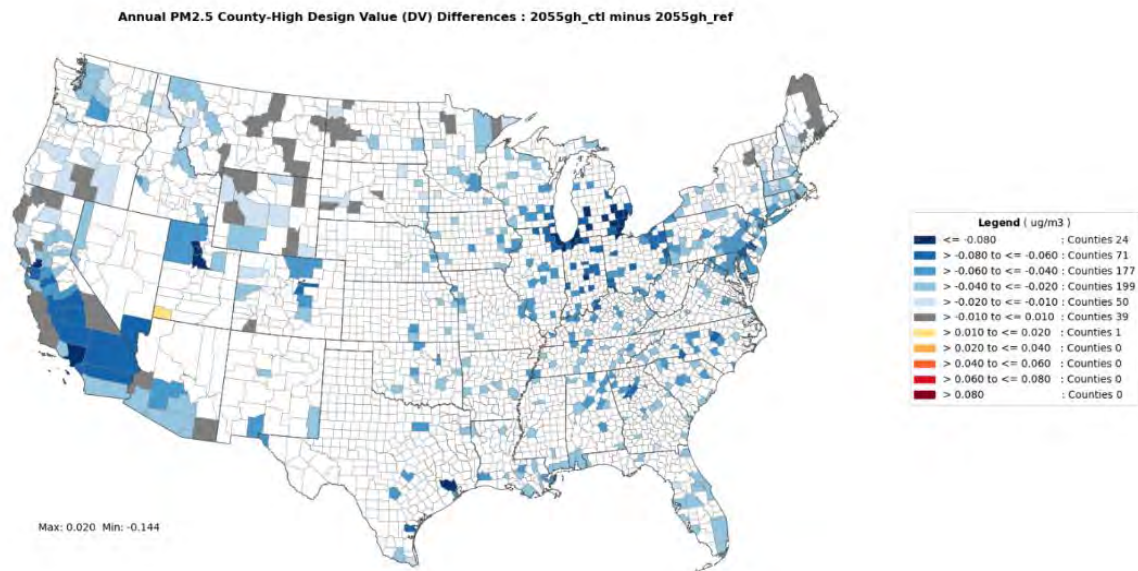


**Figure 7-7: Projected changes in annual average PM<sub>2.5</sub> concentrations in 2055 from "onroad-only" emissions changes.**

When only the onroad emissions impacts of the rule are considered, annual average PM<sub>2.5</sub> concentrations will decrease by an average of 0.02  $\mu\text{g}/\text{m}^3$  in 2055, with a maximum decrease of 0.13  $\mu\text{g}/\text{m}^3$ . The population-weighted average change in annual average PM<sub>2.5</sub> concentrations attributable to the onroad emissions reductions will be a decrease of 0.04  $\mu\text{g}/\text{m}^3$  in 2055.

#### **7.4.1.3 Projected Annual PM<sub>2.5</sub> Design Value Impacts in 2055**

This section summarizes the impacts of the final rule on projected annual PM<sub>2.5</sub> design value concentrations in 2055, based on our CMAQ modeling. Figure 7-8 presents the changes in annual PM<sub>2.5</sub> design value concentrations in 2055. Not all counties have monitor data that meet the requirements to calculate a design value concentration; counties without a calculated design value are left white on the map.



**Figure 7-8: Projected change in annual PM<sub>2.5</sub> Design Values in 2055 due to the rule.**

As shown in Figure 7-8, the majority of the design value decreases in 2055 are less than 0.1  $\mu\text{g}/\text{m}^3$ . A total of 561 counties were modeled to estimate projected design value changes; the mean impact of the rule on annual PM<sub>2.5</sub> design values in these counties is a decrease of 0.04  $\mu\text{g}/\text{m}^3$ . The maximum projected decrease in an annual PM<sub>2.5</sub> design value in 2055 is 0.14  $\mu\text{g}/\text{m}^3$  in Los Angeles County, California.

These modeling results project that the rule will not have considerable impact on the number of counties that are projected to be above and below the level of the 2012 annual primary PM<sub>2.5</sub> NAAQS. Forty-four counties are projected to have concentrations above the level of the 2024 standard in the 2055 reference scenario. While the number of counties with projected design values above the level of the NAAQS is less certain than the average projected changes in design values, we estimate that the rule will reduce annual PM<sub>2.5</sub> design values in two counties (Contra Costa County, California and Butler County, Ohio) from above the level of the 2024 standard, to below the standard. The projected population in these counties in 2055 is over 2 million people. While the air quality modeling results suggest that annual PM<sub>2.5</sub> design values will decrease as a result of emissions changes from the rule in the vast majority of counties, there is one county in 2055 that is projected to have an increase in modeled annual PM<sub>2.5</sub> design value concentration (Washington County, Utah).

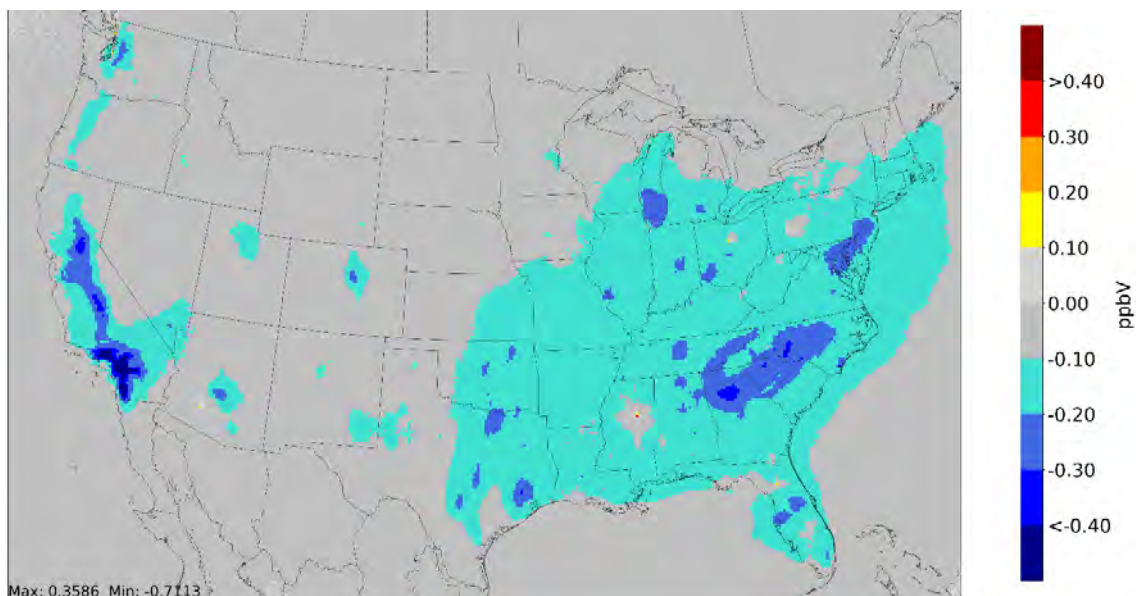
## **7.4.2 Ozone**

### **7.4.2.1 Overall Projected Ozone Impacts**

This section summarizes projected changes in ozone concentrations in 2055 from the rule. Figure 7-8 presents the absolute changes in 8-hour ozone maximum average concentrations over the ozone season (April - September) in 2055 between the reference and the policy scenario and indicates that there will be widespread decreases (blue areas). In a few isolated areas, this rule is



expected to result in increases in 8-hour maximum average ozone, likely due mainly to increases in EGU emissions. We expect the power sector to become cleaner over time as a result of the IRA and future policies, which will reduce the air quality impacts of EGUs. Less than 0.1% of CMAQ grid cells are projected to have increases in 8-hour maximum ozone concentration of  $\geq 0.1$  ppb (yellow and red areas), and only 0.1% of the population of CONUS lives in those areas.

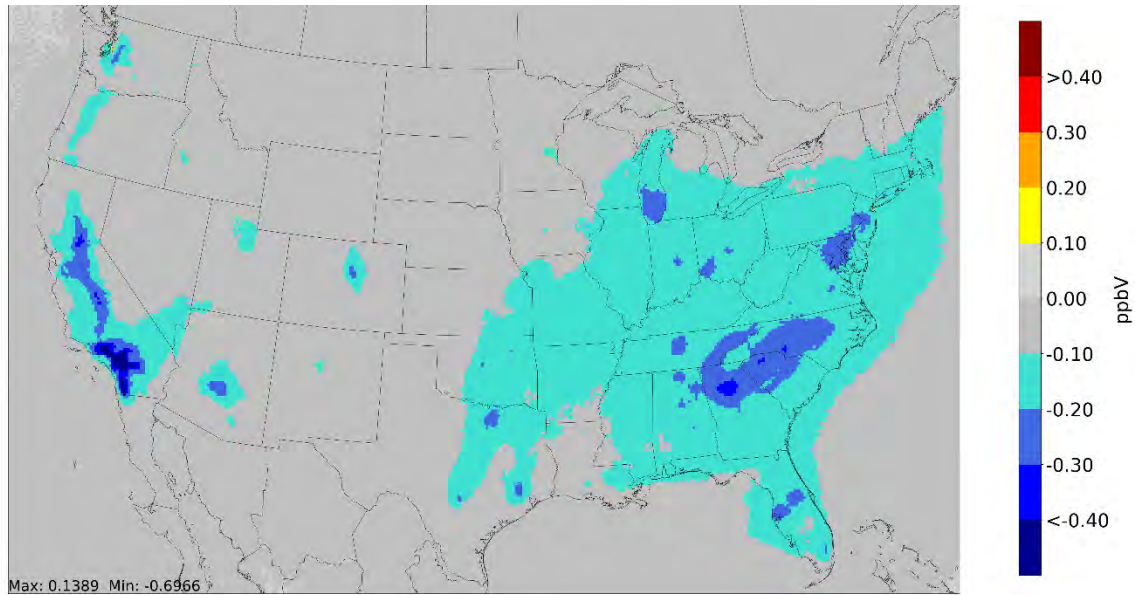


**Figure 7-8: Projected changes in 8-hour maximum average ozone concentrations in 2055 ozone season due to the rule.**

The rule will decrease 8-hour maximum average ozone concentrations by an average of 0.09 ppb in 2055, with a maximum decrease of 0.71 ppb and a maximum increase of 0.36 ppb. The population-weighted average change in 8-hour maximum average ozone concentrations will be a decrease of 0.16 ppb in 2055.

#### **7.4.2.2 Onroad-Only Projected Ozone Impacts**

We also modeled an “onroad-only” sensitivity case. Figure 7-9 presents the absolute changes in 8-hour maximum average ozone concentrations in 2055 between the reference and onroad-only sensitivity scenarios.

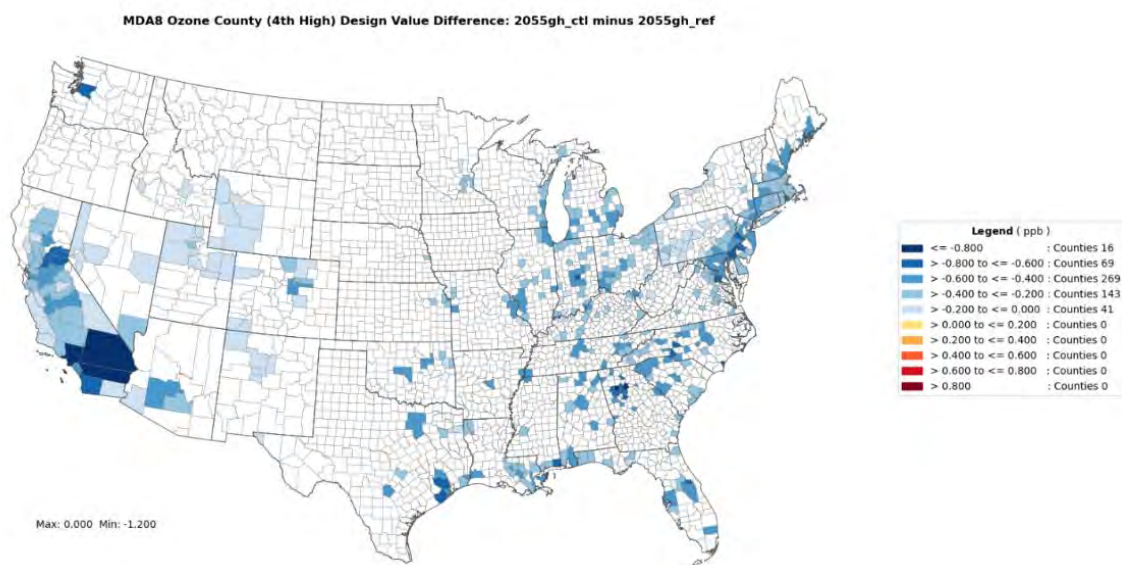


**Figure 7-9: Projected changes in 8-hour maximum average ozone concentrations in 2055 ozone season from "onroad-only" emissions changes.**

When only the onroad emissions impacts of the rule are considered, 8-hour maximum average ozone concentrations will decrease by an average of 0.09 ppb in 2055, with a maximum decrease of 0.70 ppb. The population-weighted average change in 8-hour maximum average ozone concentrations attributable to the onroad emissions reductions will be a decrease of 0.16 ppb in 2055.

#### **7.4.2.3 Projected Ozone Design Value Impacts in 2055**

This section summarizes the impacts of the final rule on projected ozone design value concentrations in 2055, based on our CMAQ modeling. Figure 7-10 presents the annual maximum 8-hour ozone design value concentrations in 2055. Not all counties have monitor data that meet the requirements to calculate a design value concentration; counties without a calculated design value are left white on the map.



**Figure 7-10 Projected change in 8-hour ozone design values in 2055 due to the Rule.**

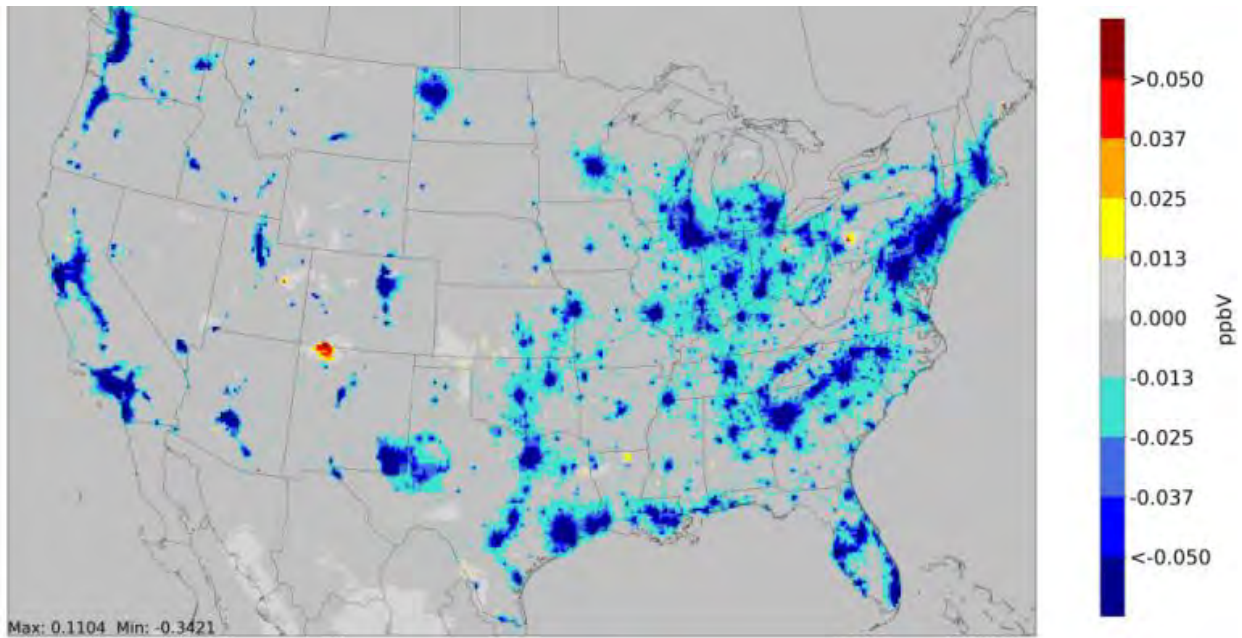
As shown in Figure 7-10, the majority of the design value decreases in 2055 are less than 1 ppb. A total of 538 counties were modeled to estimate projected design value changes; the mean impact of the rule on 8-hour ozone design values in these counties is a decrease of 0.4 ppb. The maximum projected decrease in 8-hour ozone design value in 2055 is 1.2 ppb in Los Angeles, Riverside, and San Bernardino Counties, California.

The number of counties with projected design values above the level of the NAAQS is less certain than the average projected changes in design values. That said, these modeling results project that the rule will not have an impact on the number of counties that are projected to be above and below the level of the 2015 ozone NAAQS.

### 7.4.3 NO<sub>2</sub>

#### 7.4.3.1 Overall Projected NO<sub>2</sub> Impacts

This section summarizes projected changes in NO<sub>2</sub> concentrations in 2055 from the rule. Figure 7-11 presents the absolute changes in annual average NO<sub>2</sub> concentrations in 2055 and indicates that there will be decreases in many urban areas (blue areas). In a few isolated areas, this rule is expected to result in increases in annual average NO<sub>2</sub>, likely due to increases in EGU emissions. We expect the power sector to become cleaner over time as a result of the IRA and future policies, which will reduce the air quality impacts of EGUs. Only 0.1% of CMAQ grid cells are projected to have increases in annual average NO<sub>2</sub> concentration of  $\geq 0.025$  ppb (yellow and red areas), and only 0.1% of the population of CONUS lives in those areas.

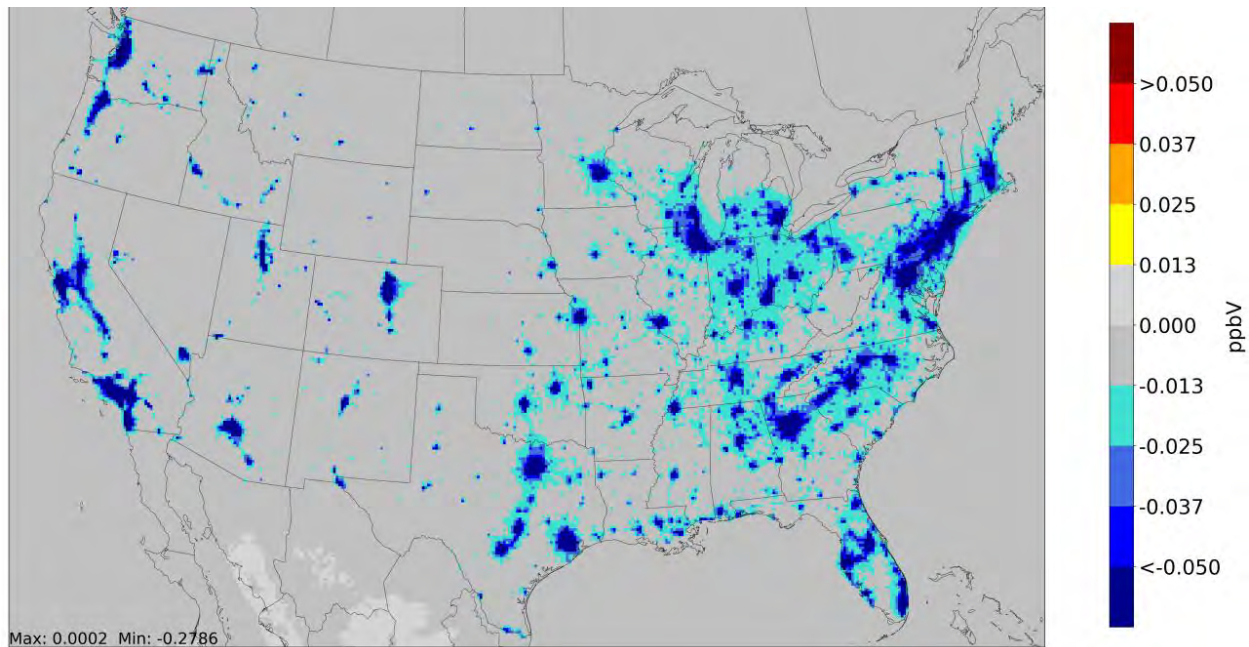


**Figure 7-11: Projected changes in annual average NO<sub>2</sub> concentrations in 2055 due to the rule.**

The rule will decrease annual average NO<sub>2</sub> concentrations by an average of 0.01 ppb in 2055, with a maximum decrease of 0.34 ppb and a maximum increase of 0.11 ppb. The population-weighted average change in annual average NO<sub>2</sub> concentrations will be a decrease of 0.08 ppb in 2055.

#### **7.4.3.2 Onroad-Only Projected NO<sub>2</sub> Impacts**

We also modeled an “onroad-only” sensitivity case. Figure 7-12 presents the absolute changes in annual average NO<sub>2</sub> concentrations in 2055 between the reference and onroad-only sensitivity scenarios.



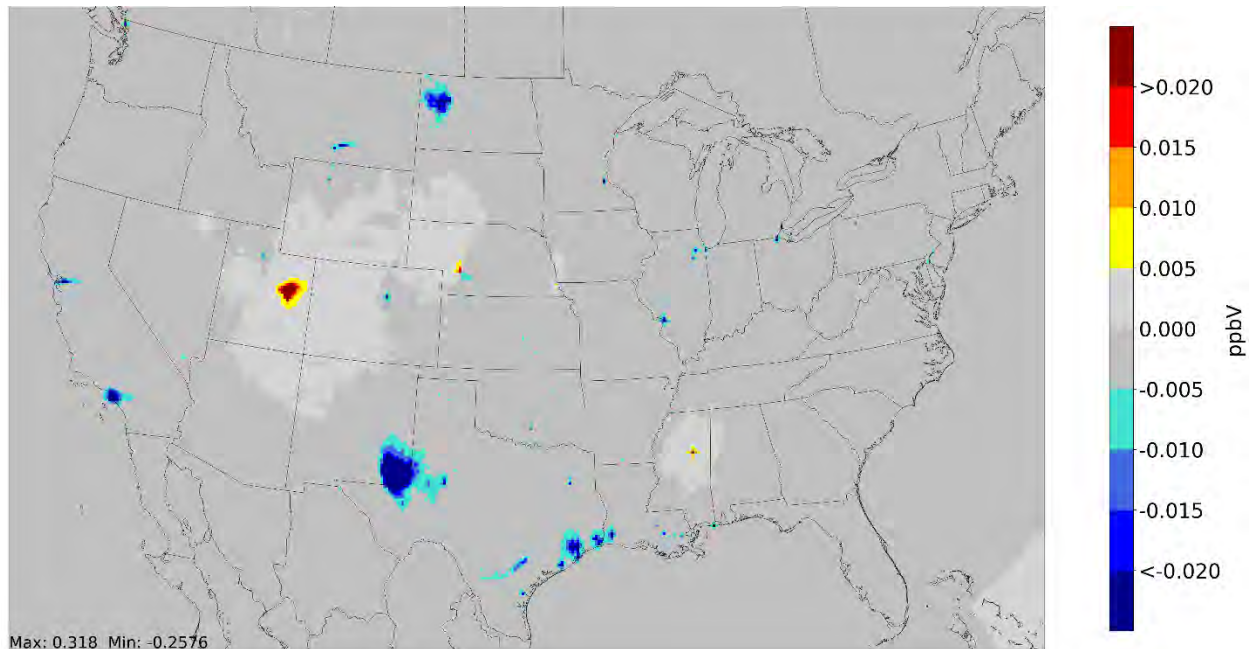
**Figure 7-12: Projected changes in annual average NO<sub>2</sub> concentrations in 2055 from "onroad-only" emissions changes.**

When only the onroad emissions impacts of the rule are considered, annual average NO<sub>2</sub> concentrations will decrease by an average of 0.01 ppb in 2055, with a maximum decrease of 0.28 ppb. The population-weighted average change in annual average NO<sub>2</sub> concentrations attributable to the onroad emissions reductions will be a decrease of 0.07 ppb in 2055.

#### **7.4.4 SO<sub>2</sub>**

##### **7.4.4.1 Overall Projected SO<sub>2</sub> Impacts**

This section summarizes projected changes in SO<sub>2</sub> concentrations in 2055 from the rule. Figure 7-13 presents the absolute changes in annual average SO<sub>2</sub> concentrations in 2055. In some areas there will be decreases (blue areas), and in some areas there will be increases, likely due to increases in EGU emissions. We expect the power sector to become cleaner over time as a result of the IRA and future policies, which will reduce the air quality impacts of EGUs. Only 0.2% of CMAQ grid cells are projected to have increases in annual average SO<sub>2</sub> concentration of  $\geq 0.005$  ppb (yellow and red areas), and less than 0.1% of the population of CONUS lives in those areas.

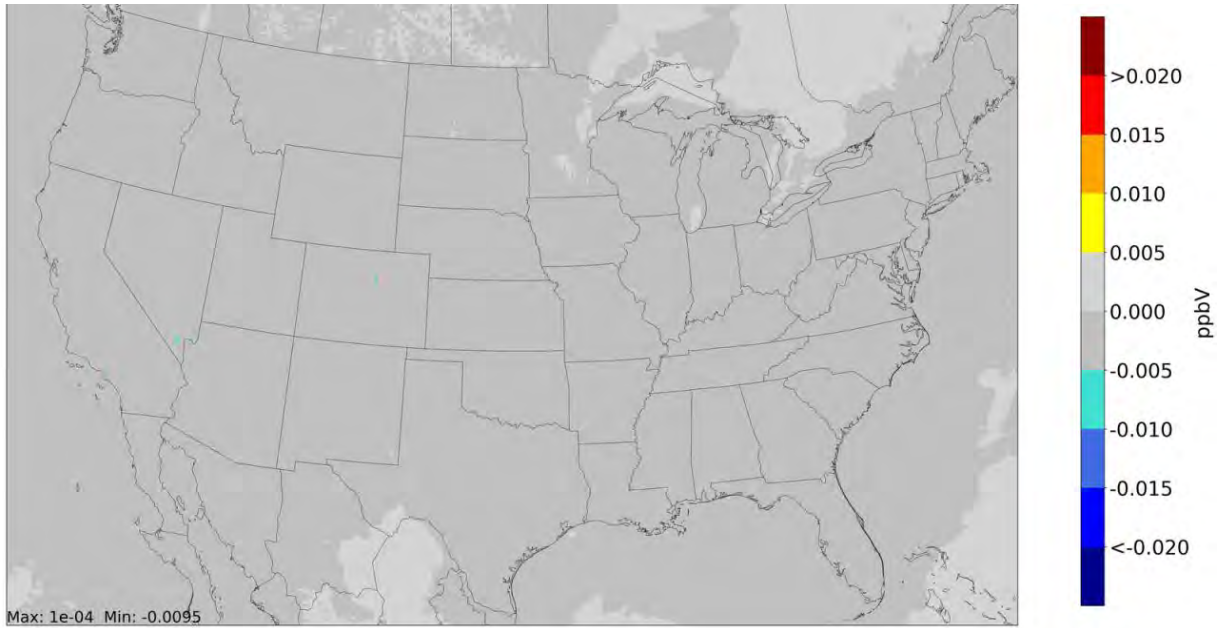


**Figure 7-13: Projected changes in annual average SO<sub>2</sub> concentrations in 2055 due to the rule.**

The rule will decrease annual average SO<sub>2</sub> concentrations by an average of 0.001 ppb in 2055, with a maximum decrease of 0.26 ppb and a maximum increase of 0.32 ppb. The population-weighted average change in annual average SO<sub>2</sub> concentrations will be a decrease of 0.003 ppb in 2055.

#### **7.4.4.2 Onroad-Only Projected SO<sub>2</sub> Impacts**

We also modeled an “onroad-only” sensitivity case. Figure 7-14 presents the absolute changes in annual average SO<sub>2</sub> concentrations in 2055 between the reference and onroad-only sensitivity scenarios.



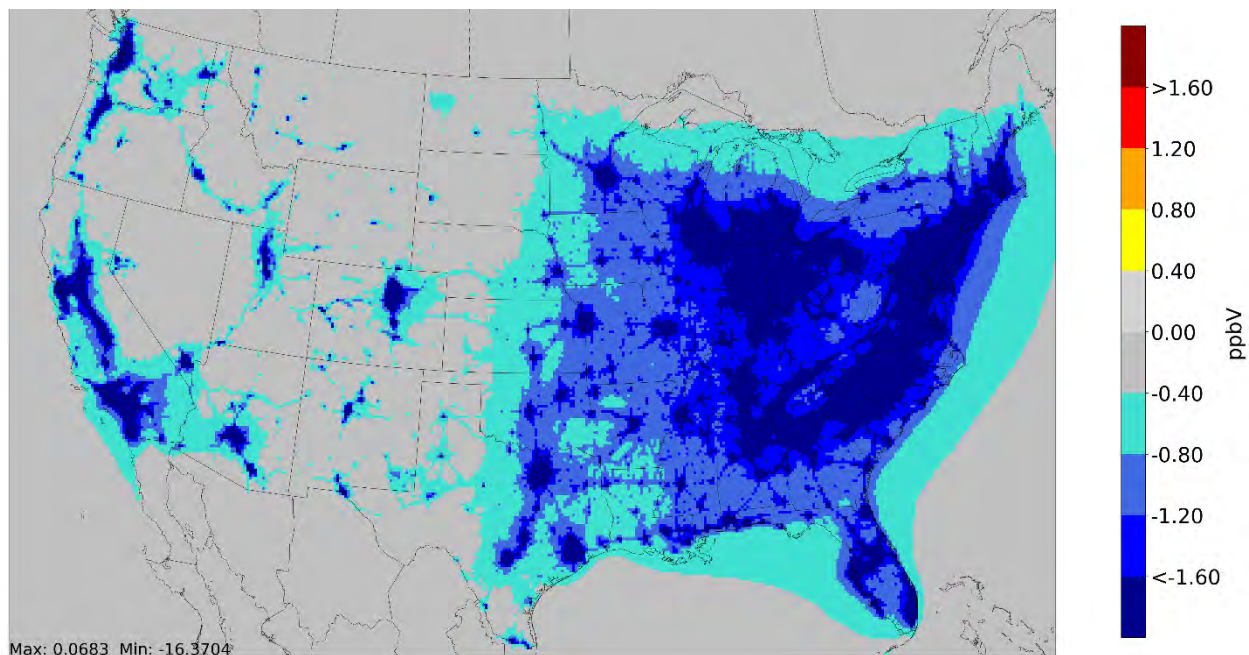
**Figure 7-14: Projected changes in annual average SO<sub>2</sub> concentrations in 2055 from "onroad-only" emissions changes.**

When only the onroad emissions impacts of the rule are considered, annual average SO<sub>2</sub> concentrations will decrease by an average of 0.0002 ppb in 2055, with a maximum decrease of 0.01 ppb. The population-weighted average change in annual average SO<sub>2</sub> concentrations attributable to the onroad emissions reductions will be a decrease of 0.001 ppb in 2055.

## **7.4.5 Carbon Monoxide**

### **7.4.5.1 Overall Projected CO Impacts**

This section summarizes projected changes in CO concentrations in 2055 from the rule. Figure 7-15 presents the absolute changes in annual average CO concentrations in 2055 between the reference and the policy scenario and indicates that there will be decreases in the vast majority of the country (blue areas). No CMAQ grid cells are projected to have increases in annual average CO concentration of  $\geq 0.4$  ppb (yellow and red areas).



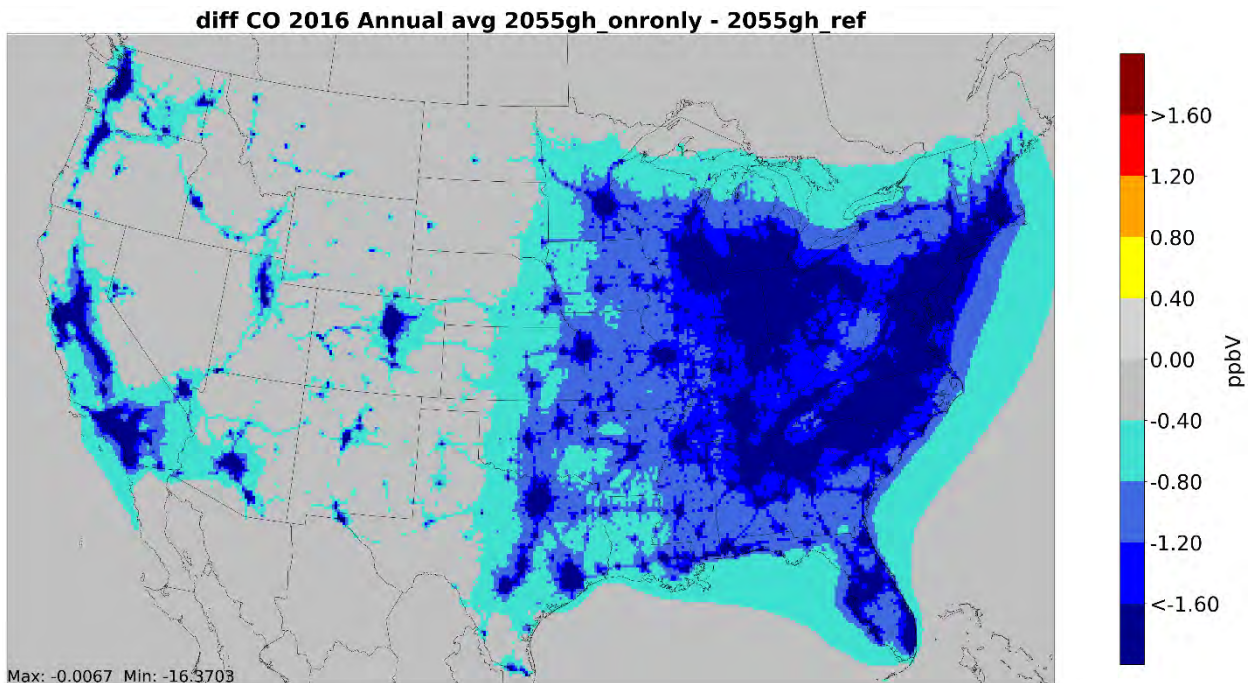
**Figure 7-15: Projected changes in annual average CO concentrations in 2055 due to the rule.**

The rule will decrease annual average CO concentrations by an average of 0.85 ppb in 2055, with a maximum decrease of 16.37 ppb and a maximum increase of 0.07 ppb. The population-weighted average change in annual average CO concentrations will be a decrease of 3.74 ppb in 2055.

#### **7.4.5.2 Onroad-only projected CO impacts of rulemaking**

We also modeled an “onroad-only” sensitivity case. Figure 7-16 presents the absolute changes in annual average CO concentrations in 2055 between the reference and onroad-only sensitivity scenarios.





**Figure 7-16: Projected changes in annual average CO concentrations in 2055 from "onroad-only" emissions changes.**

When only the onroad emissions impacts of the rule are considered, annual average CO concentrations will decrease by an average of 0.85 ppb in 2055, with a maximum decrease of 16.37 ppb. The population-weighted average change in annual average CO concentrations attributable to the onroad emissions reductions will be a decrease of 3.75 ppb in 2055.

## **7.4.6 Air Toxics**

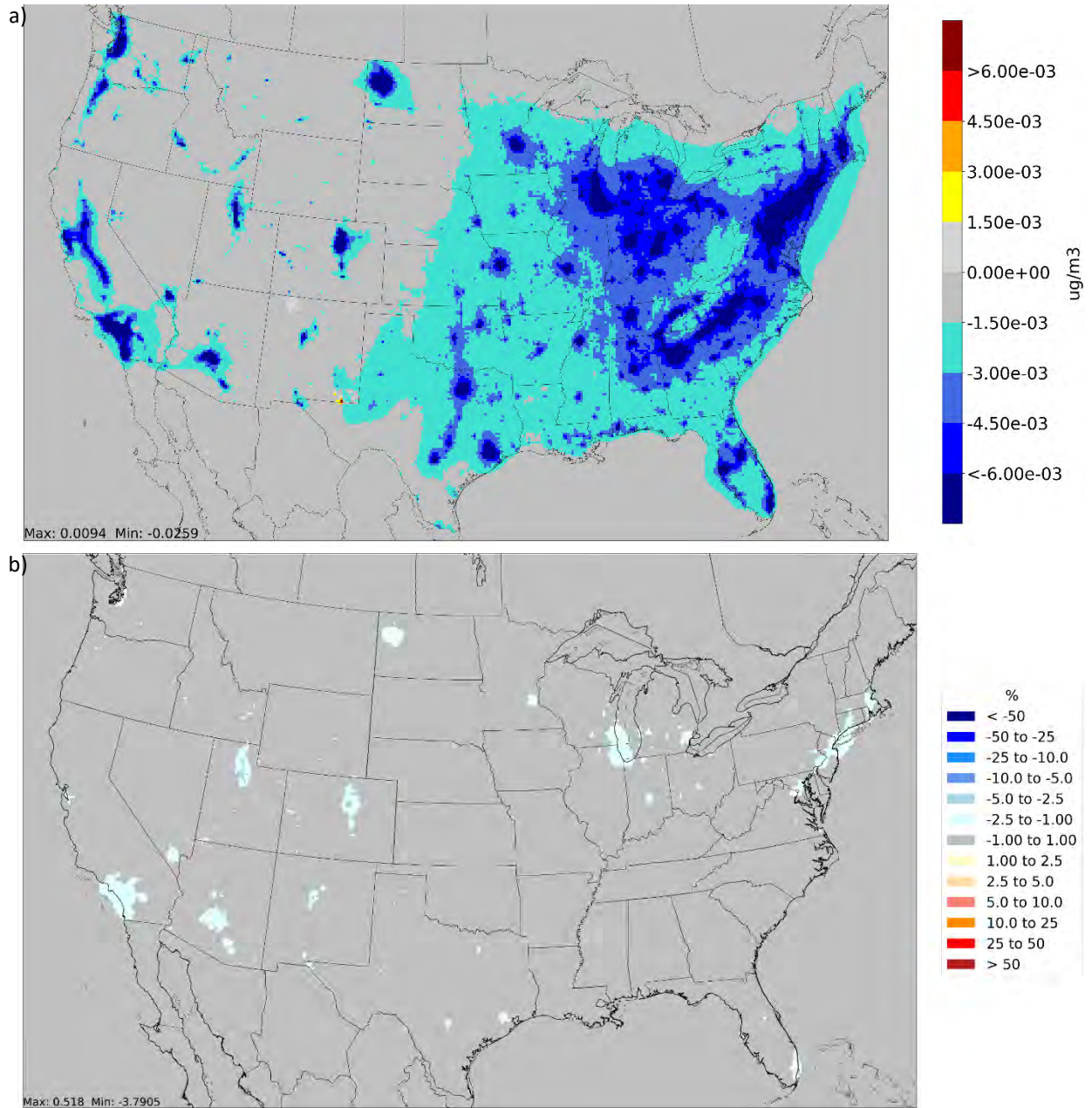
### **7.4.6.1 Overall Projected Air Toxics Impacts**

This section summarizes projected changes in concentrations of select air toxics in 2055 from the rule. Our modeling indicates that the rule will have relatively little impact on national average ambient concentrations of the modeled air toxics in 2055. Figure 7-17 to Figure 7-21 present the absolute changes in annual average acetaldehyde, benzene, 1,3-butadiene, formaldehyde, and naphthalene concentrations in 2055 between the reference and the policy scenario. National average annual concentrations in 2055 will decrease for all pollutants, although in some localized areas, this rule is expected to result in increases in annual average concentration of acetaldehyde, benzene, 1,3-butadiene or formaldehyde, likely due to increases in EGU emissions. We expect the power sector to become cleaner over time as a result of the IRA and future policies, which will reduce the air quality impacts of EGUs.

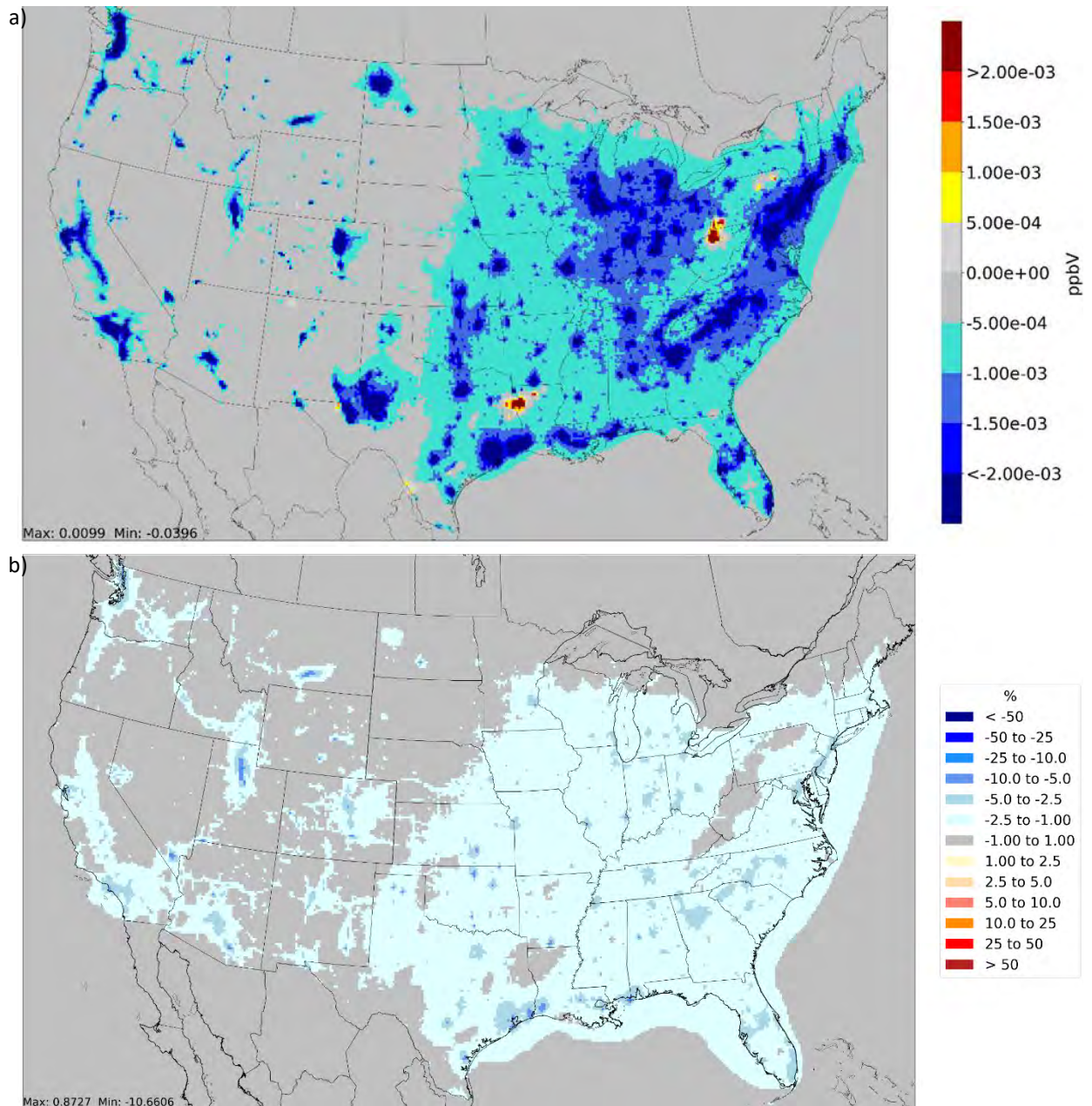
The projected impact of the standards on average air toxics concentrations in 2055 are presented in Table 7-14.

**Table 7-14: Projected changes in annual average air toxics concentrations in 2055 due to the rule.**

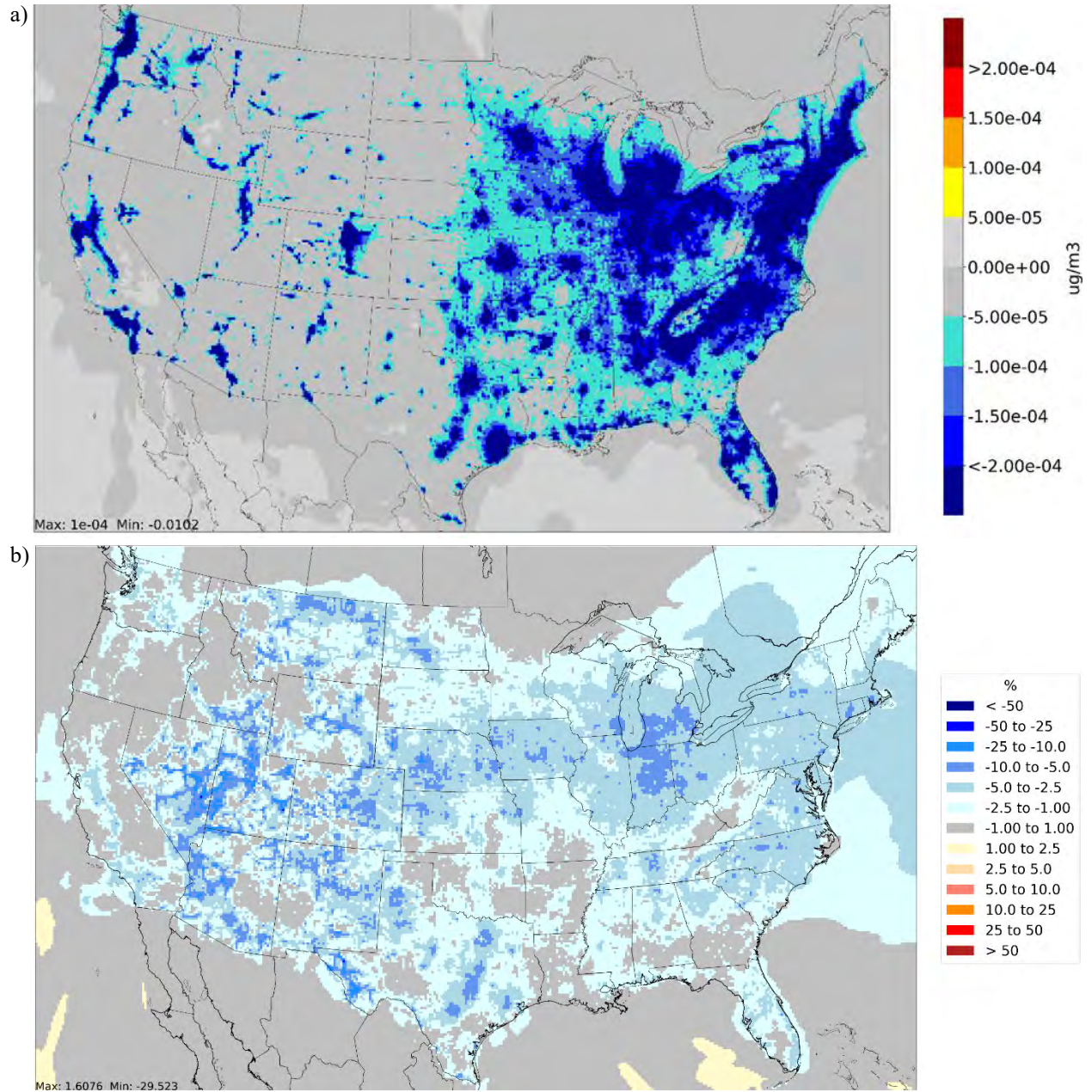
| <b>Pollutant</b> | <b>Unit</b> | <b>Average change</b> |
|------------------|-------------|-----------------------|
| Acetaldehyde     | µg/m3       | -0.0021               |
| Benzene          | ppb         | -0.0007               |
| 1,3-Butadiene    | µg/m3       | -0.0001               |
| Formaldehyde     | ppb         | -0.0023               |
| Naphthalene      | µg/m3       | -0.00004              |



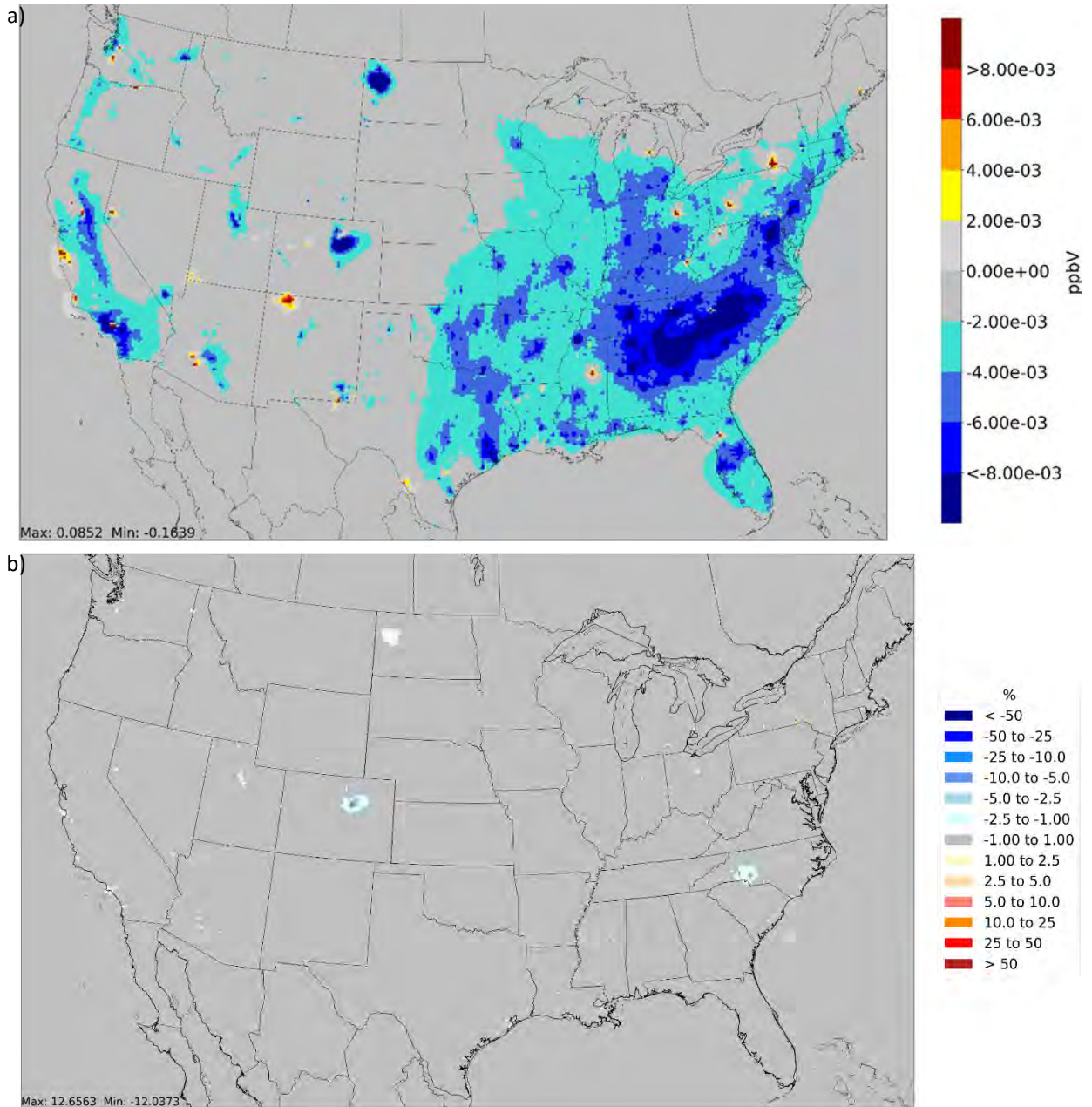
**Figure 7-17: Projected a) absolute changes and b) percent changes in annual average acetaldehyde concentrations in 2055 due to the rule.**



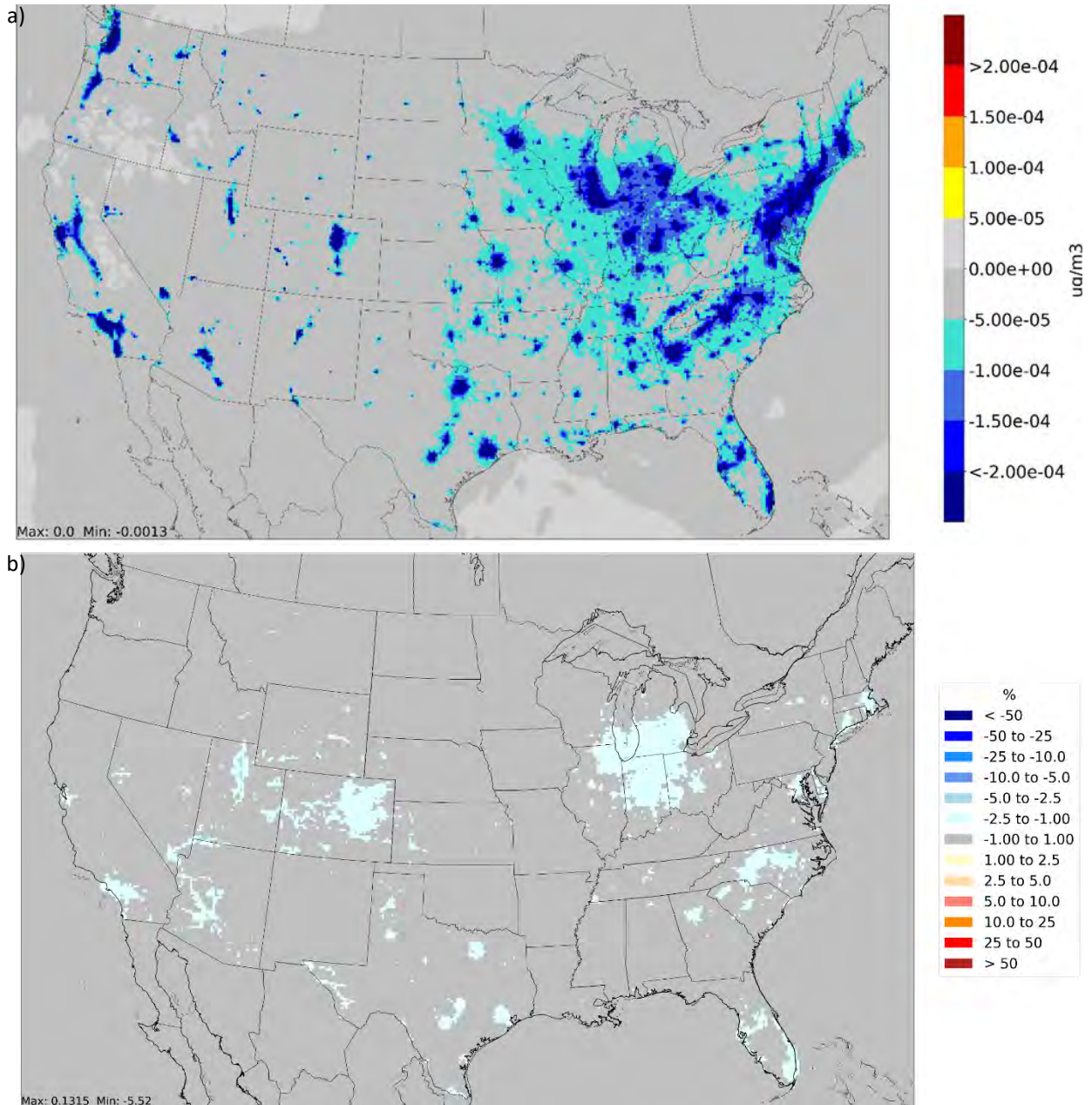
**Figure 7-18: Projected a) absolute changes and b) percent changes in annual average benzene concentrations in 2055 due to the rule.**



**Figure 7-19: Projected a) absolute changes and b) percent changes in annual average 1,3-butadiene concentrations in 2055 due to the rule.**



**Figure 7-20: Projected a) absolute changes and b) percent changes in annual average formaldehyde concentrations in 2055 due to the rule.**



**Figure 7-21: Projected a) absolute changes and b) percent changes in annual average naphthalene concentrations in 2055 due to the rule.**

### 7.4.6.2 Onroad-Only Projected Air Toxics Impacts

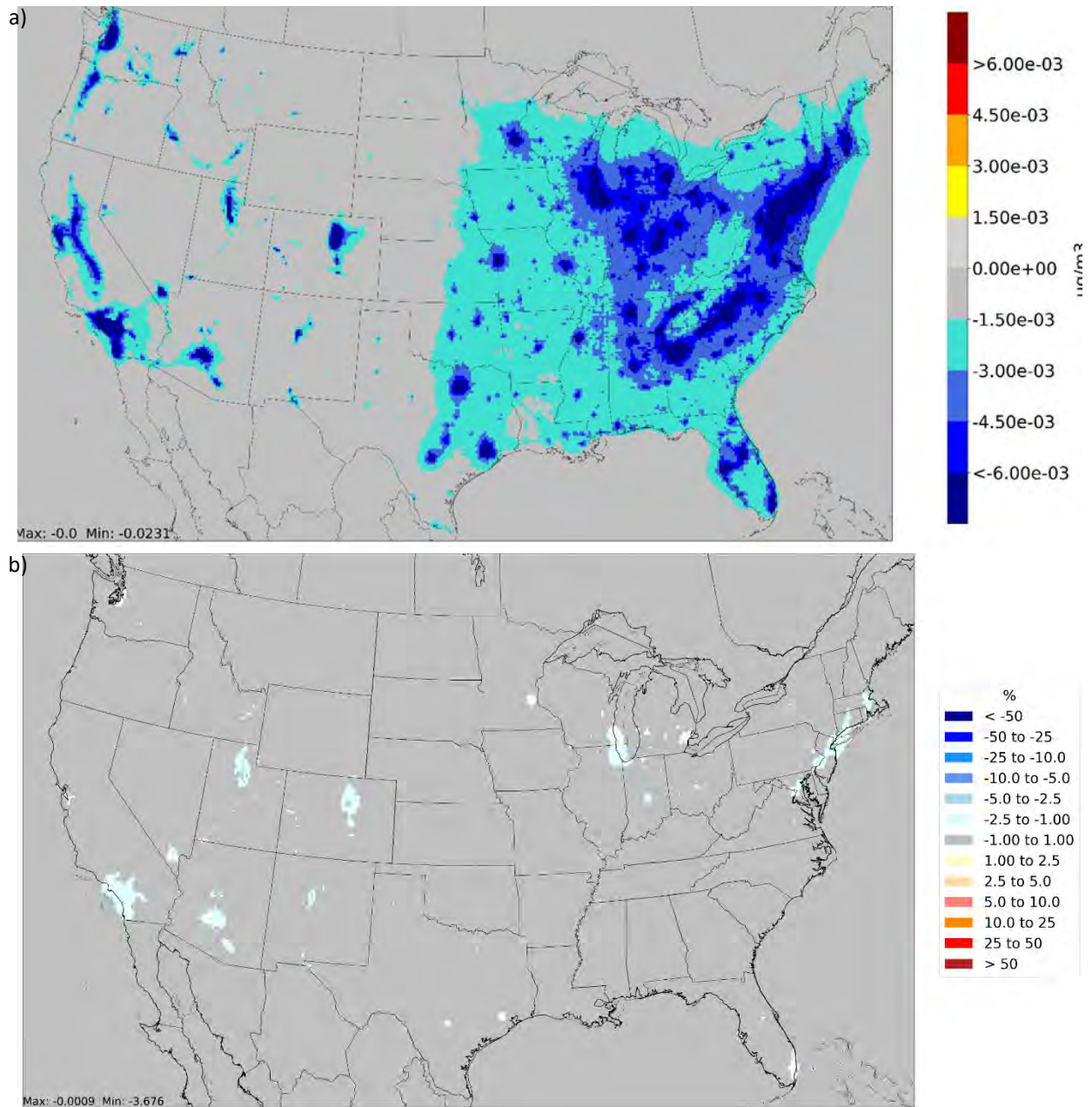
We also modeled an "onroad-only" sensitivity case. Figure 7-22 through Figure 7-26 present the absolute changes in annual average air toxic concentrations in 2055 between the reference and onroad-only sensitivity scenarios.

Summary statistics for the projected "onroad-only" impact of the standards on air toxics concentrations in 2055 are presented in Table 7-15.

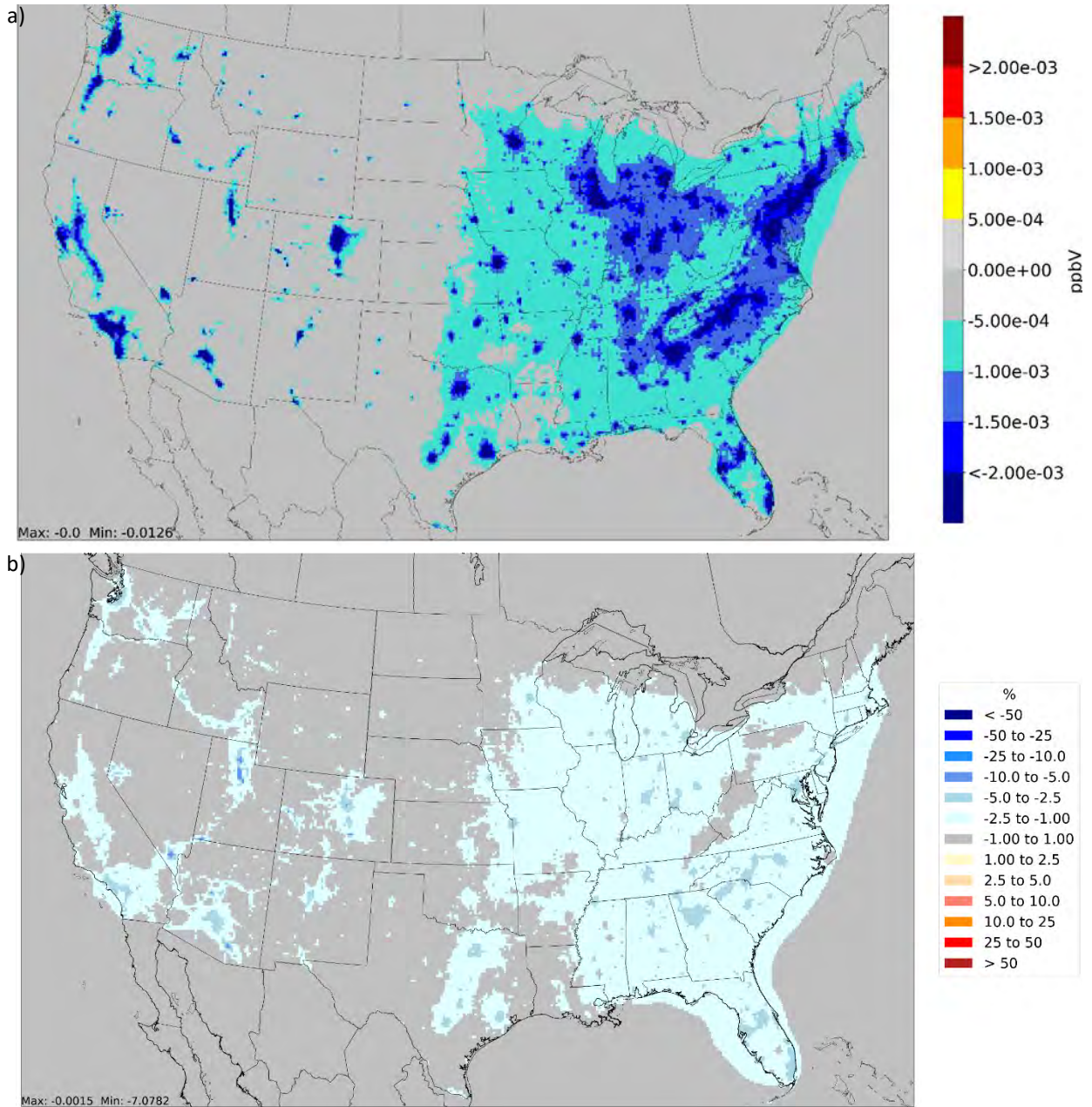
**Table 7-15: Projected changes in annual average air toxics concentrations in 2055 due to onroad-only emissions changes.**

| <b>Pollutant</b> | <b>Unit</b>       | <b>Average change</b> |
|------------------|-------------------|-----------------------|
| Acetaldehyde     | µg/m <sup>3</sup> | -0.0019               |
| Benzene          | ppb               | -0.0006               |
| 1,3-Butadiene    | µg/m <sup>3</sup> | -0.0001               |
| Formaldehyde     | ppb               | -0.0022               |
| Naphthalene      | µg/m <sup>3</sup> | -0.00004              |

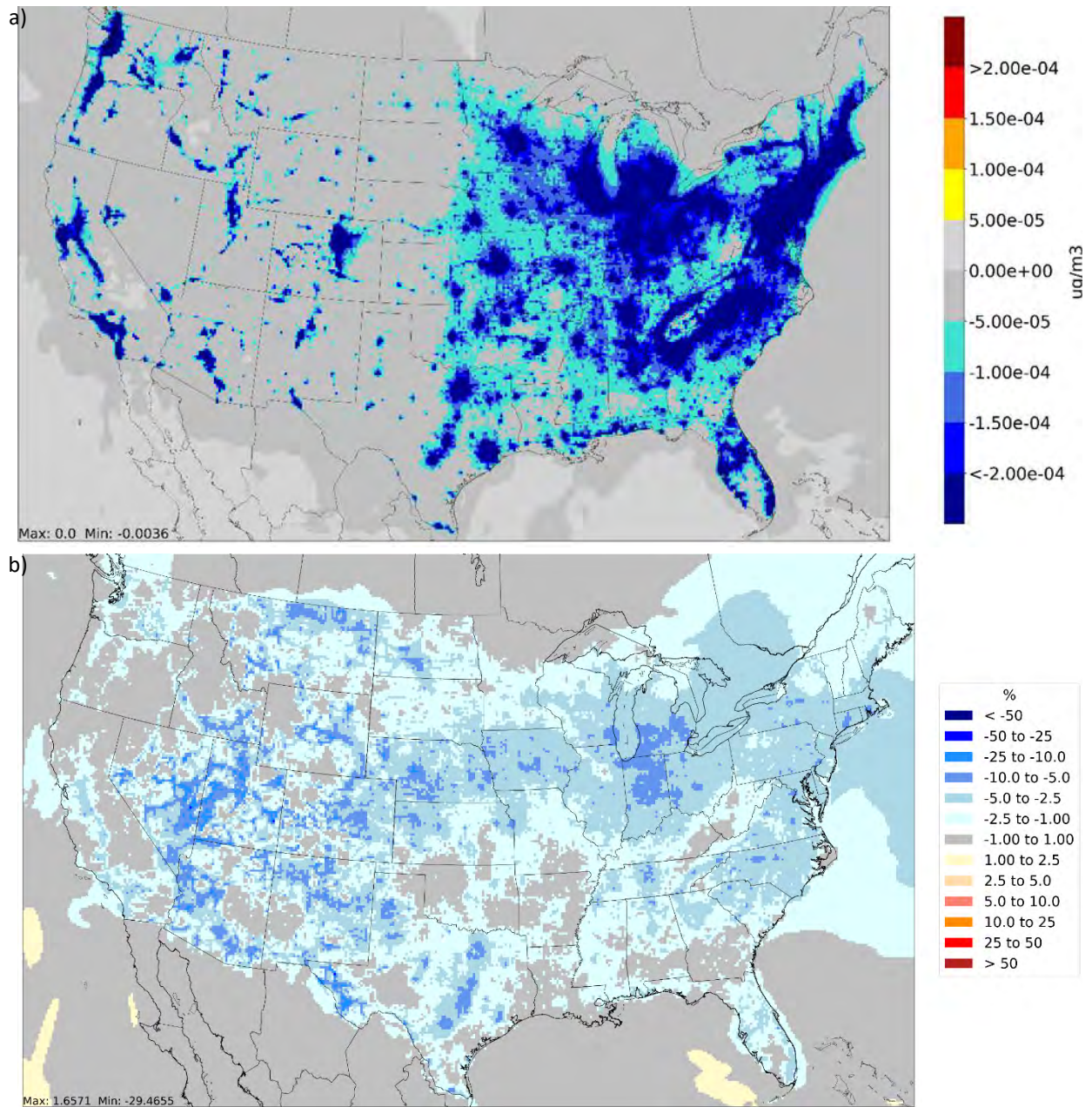




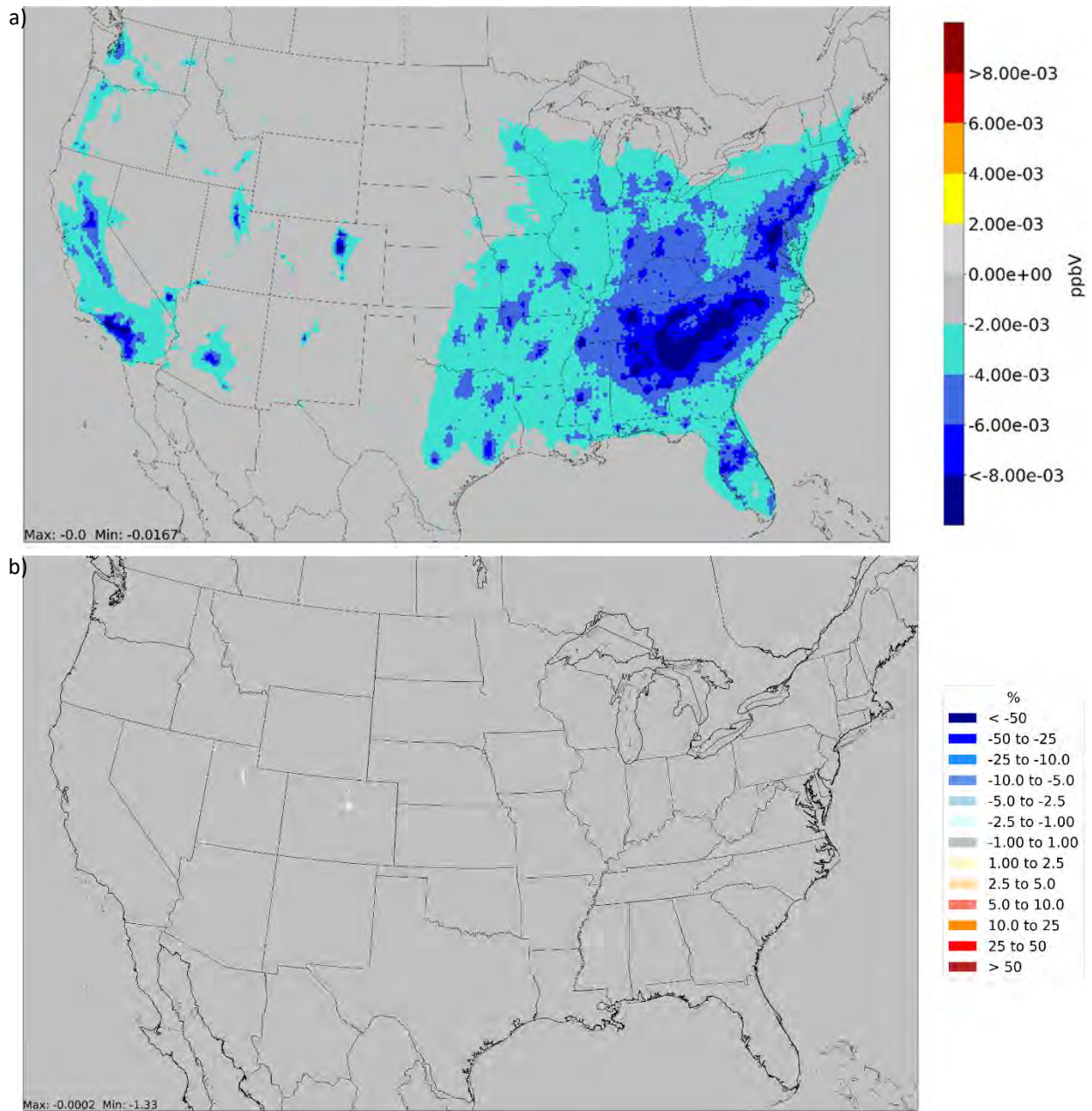
**Figure 7-22: Projected a) absolute changes and b) percent changes in annual average acetaldehyde concentrations in 2055 from "onroad-only" emissions changes.**



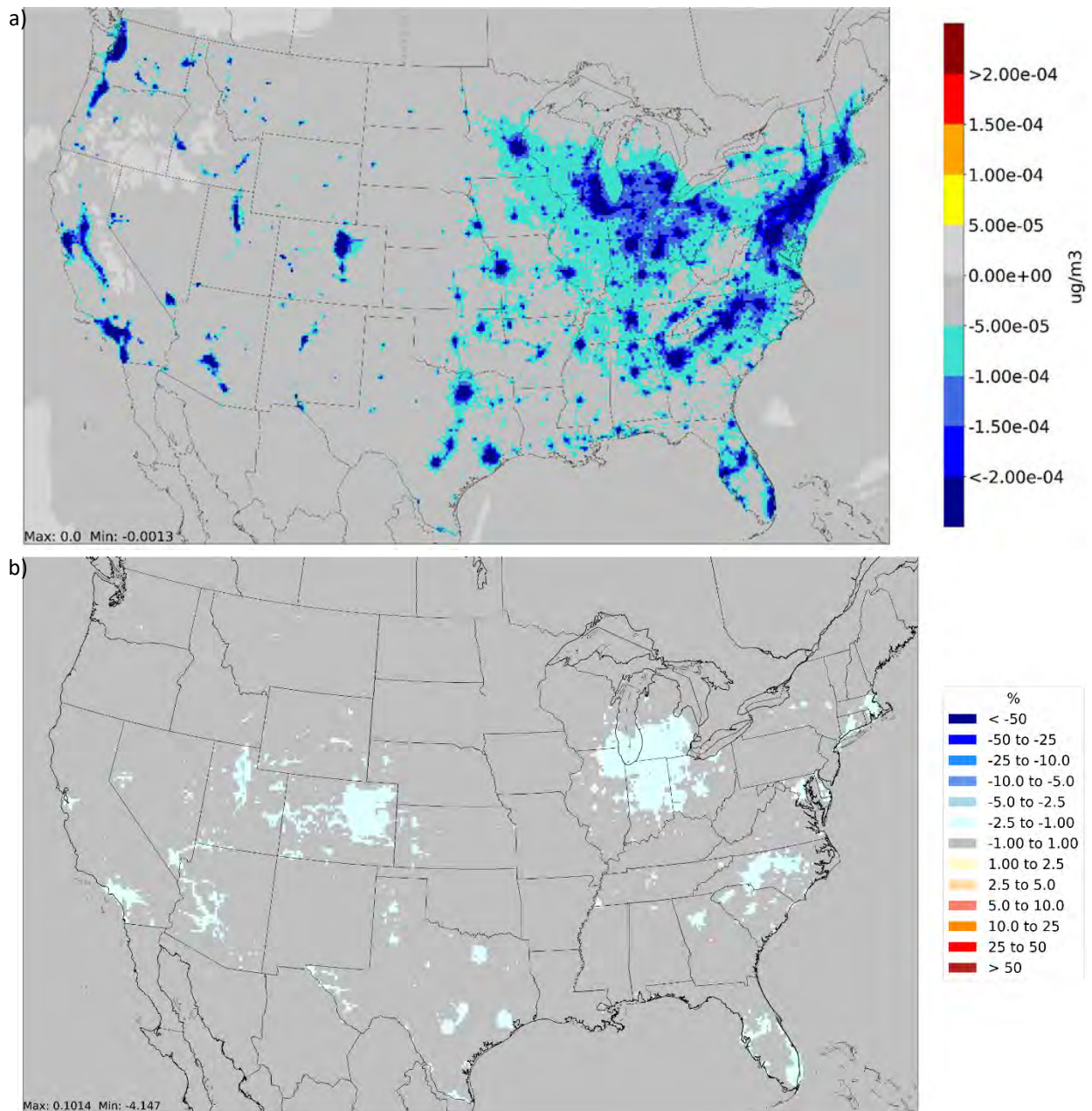
**Figure 7-23: Projected a) absolute changes and b) percent changes in annual average benzene concentrations in 2055 from "onroad-only" emissions changes.**



**Figure 7-24: Projected a) absolute changes and b) percent changes in annual average 1,3-butadiene concentrations in 2055 from "onroad-only" emissions changes.**



**Figure 7-25: Projected a) absolute changes and b) percent changes in annual average formaldehyde concentrations in 2055 from "onroad-only" emissions changes.**

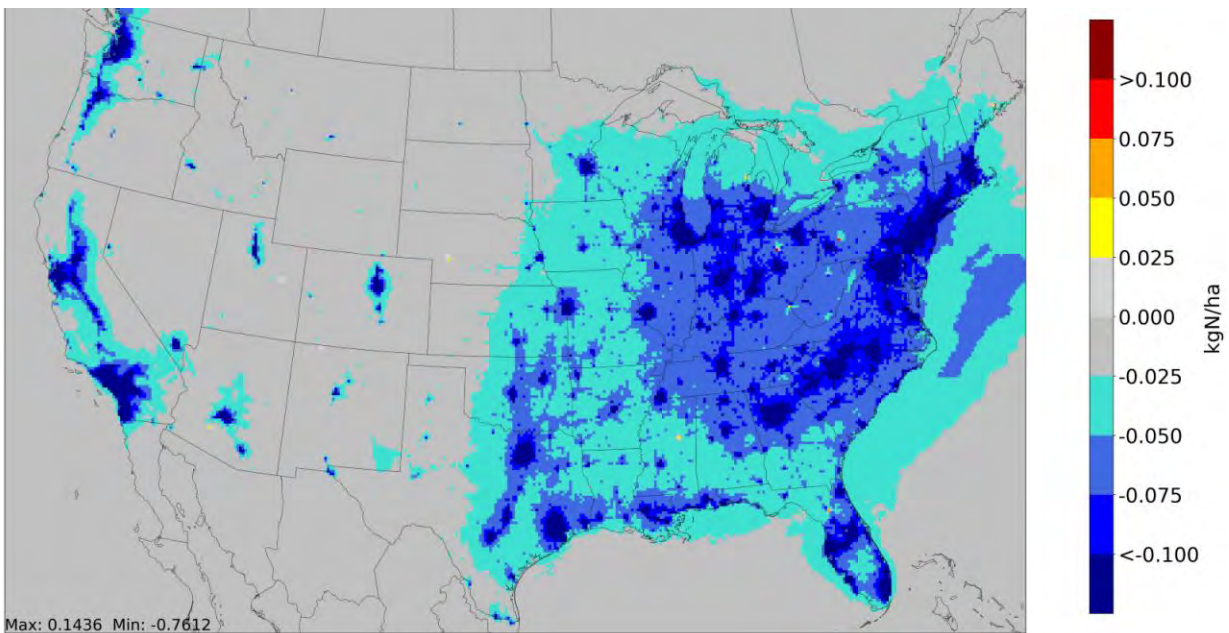


**Figure 7-26: Projected a) absolute changes and b) percent changes in annual average naphthalene concentrations in 2055 from "onroad-only" emissions changes.**

## 7.4.7 Deposition

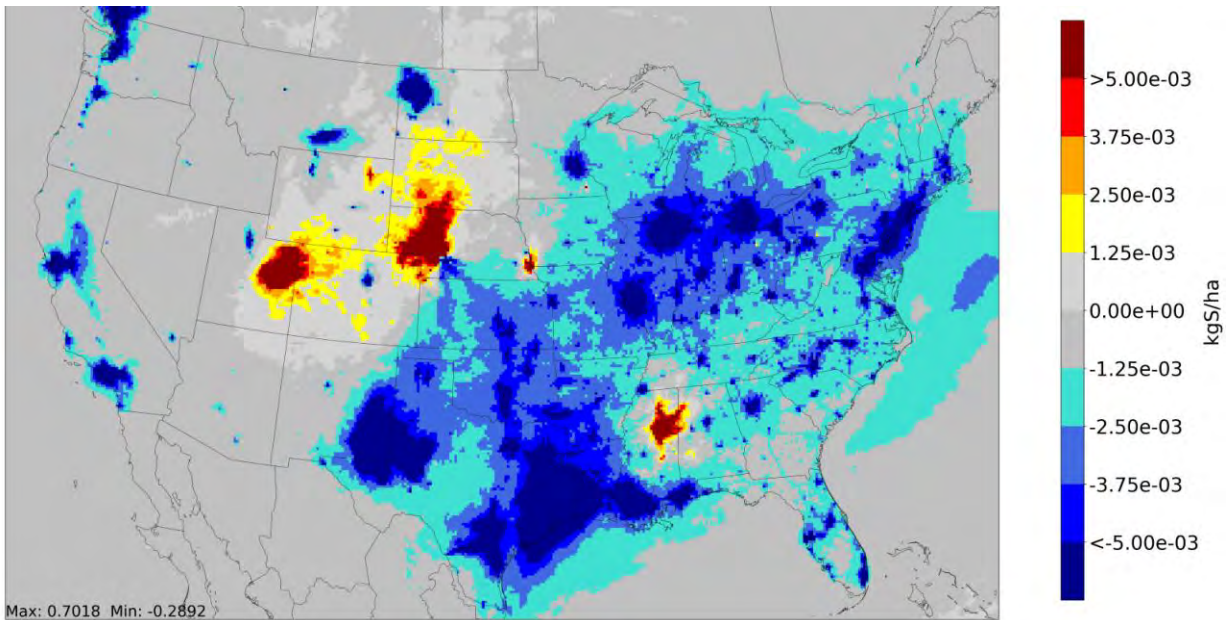
### 7.4.7.1 Overall Projected Nitrogen and Sulfur Deposition Impacts

This section summarizes projected changes in nitrogen (N) and sulfur (S) deposition in 2055 from the rule. Figure 7-27 and Figure 7-28 present the absolute changes in annual N and S deposition in 2055, respectively. Less than 0.1% of CMAQ grid cells are projected to have increases in annual average N deposition of  $\geq 0.01$  ppb (yellow and red areas), and less than 0.1% of the population of CONUS lives in those areas. Only 1.0% of CMAQ grid cells are projected to have increases in annual average S deposition of  $\geq 0.01$  ppb (yellow and red areas), and only 0.1% of the population of CONUS lives in those areas.



**Figure 7-27: Projected changes in annual nitrogen deposition in 2055 due to the rule.**

The rule will decrease annual average N deposition concentrations by an average of 0.04 kgN/ha in 2055, with a maximum decrease of 0.76 kgN/ha and a maximum increase of 0.14 kgN/ha. The population-weighted average change in annual average N deposition concentrations will be a decrease of 0.17 kgN/ha in 2055.

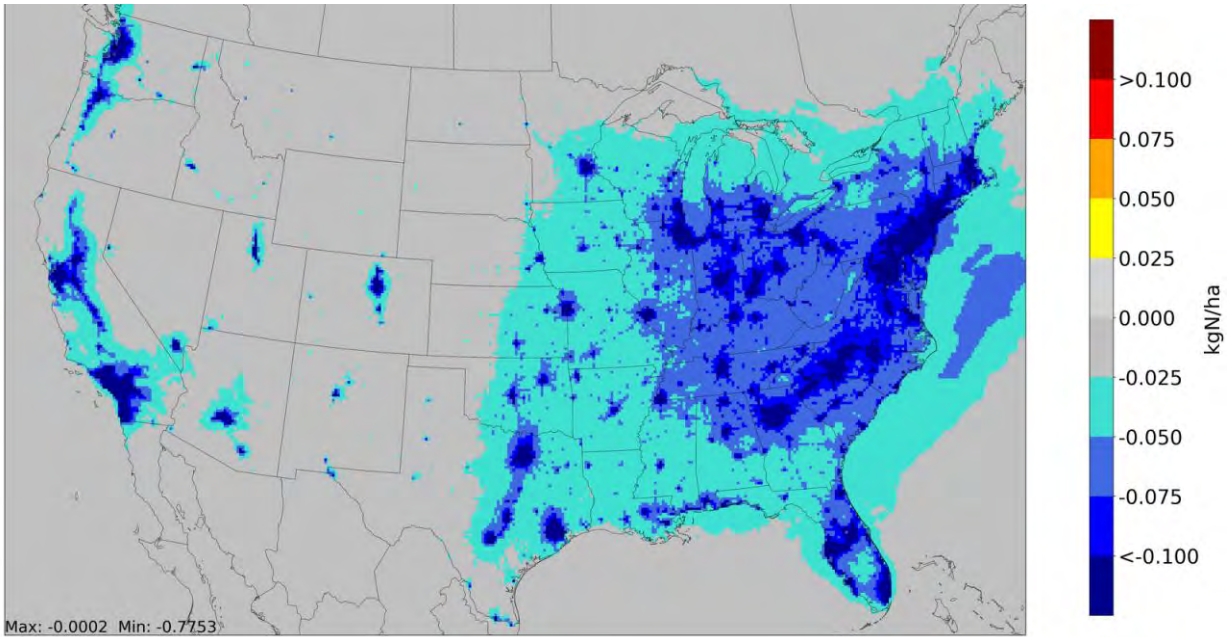


**Figure 7-28: Projected changes in annual sulfur deposition in 2055 due to the rule.**

The rule will decrease annual average S deposition concentrations by an average of 0.002 kgS/ha in 2055, with a maximum decrease of 0.29 kgS/ha and a maximum increase of 0.70 kgS/ha. The population-weighted average change in annual average S deposition concentrations will be a decrease of 0.01 kgS/ha in 2055.

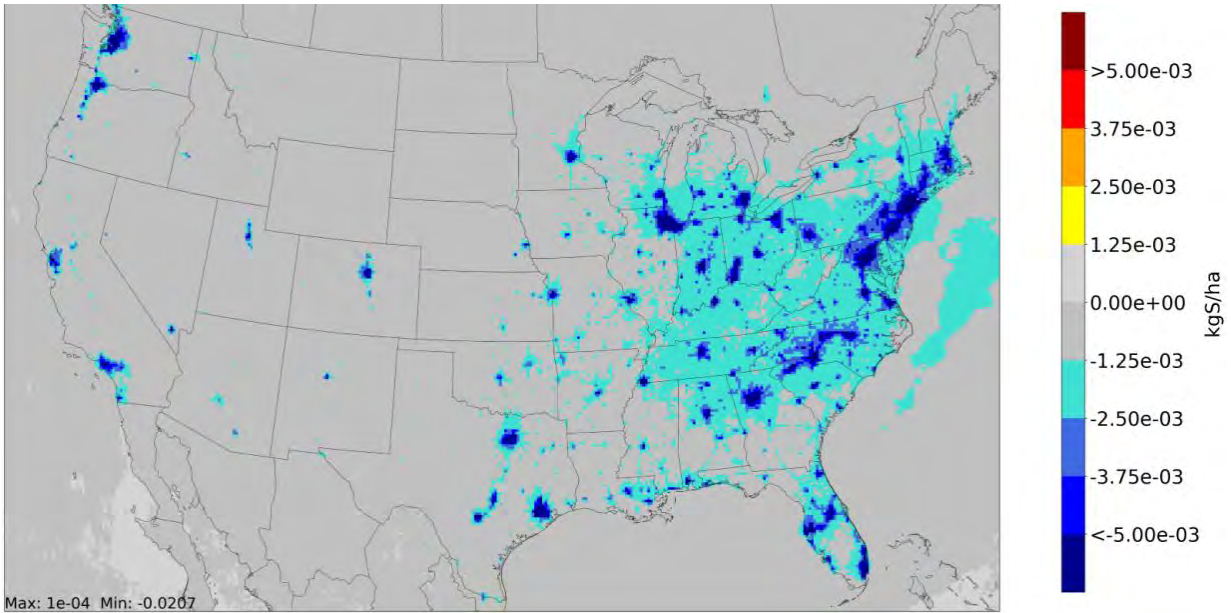
#### **7.4.7.2 Onroad-Only Projected Nitrogen and Sulfur Deposition Impacts**

We also modeled an “onroad-only” sensitivity case (i.e., without including any changes to emissions from the upstream sources included in the policy scenario). Figure 7-29 presents the absolute changes in annual N deposition in 2055 between the reference and onroad-only sensitivity scenarios and Figure 7-30 presents the absolute changes in annual S deposition.



**Figure 7-29: Projected changes in annual nitrogen deposition in 2055 from "onroad-only" emissions changes.**

When only the onroad emissions impacts of the policy scenario are considered, annual average N deposition concentrations will decrease by an average of 0.04 kgN/ha in 2055, with a maximum decrease of 0.77 kgN/ha. The population-weighted average change in annual average N deposition concentrations attributable to the onroad emissions reductions will be a decrease of 0.17 kgN/ha in 2055.



**Figure 7-30: Projected changes in annual sulfur deposition in 2055 from "onroad-only" emissions changes.**



When only the onroad emissions impacts of the policy scenario are considered, annual average S deposition concentrations will decrease by an average of 0.0008 kgS/ha in 2055, with a maximum decrease of 0.02 kgS/ha. The population-weighted average change in annual average S deposition concentrations attributable to the onroad emissions reductions will be a decrease of 0.004 kgS/ha in 2055.

### **7.5 Ozone and Particulate Matter Health Benefits**

As described in this Chapter, EPA conducted an air quality modeling analysis of a regulatory scenario in 2055 involving light- and medium-duty vehicle emission reductions and corresponding changes in “upstream” emission sources like EGU (electric generating unit) emissions and refinery emissions. Year 2055 was selected as a year that best represents the fleet turning over to nearly full implementation of the final standards. Decisions about the emissions and other elements used in the air quality modeling were made early in the analytical process for the final rulemaking. Accordingly, the air quality analysis does not fully represent the final regulatory scenario; however, we consider the modeling results to be a fair reflection of the impact the standards will have on PM<sub>2.5</sub> and ozone air quality, as well as associated health impacts, in the snapshot year of 2055. In contrast, the OMEGA-based emissions analysis (see RIA Chapter 8) does represent the final form of the standards. As a result, we used the OMEGA-based emissions analysis and benefit-per-ton (BPT) values to estimate the criteria pollutant (PM<sub>2.5</sub>) health benefits of these standards. RIA Chapter 6.4 describes the benefit-per-ton valuation methodology and RIA Chapter 9 presents the PM<sub>2.5</sub>-related health benefits.

The AQM analysis supports the conclusion that in 2055, the standards will result in widespread decreases in ozone and PM<sub>2.5</sub> that will lead to substantial improvements in public health and welfare. Using the AQM results, we have quantified and monetized health impacts in 2055, representing a LMDV regulatory scenario described in RIA Chapter 7.2. The approach we used to estimate health benefits is consistent with the approach described in the technical support document (TSD) that was published for the 2023 PM NAAQS Reconsideration Proposal. (U.S. EPA 2023)

Table 7-16 reports the PM<sub>2.5</sub>- and ozone-attributable effects we quantified and those we did not quantify in this benefits analysis. The list of benefit categories not quantified is not exhaustive. The table below omits welfare effects such as acidification and nutrient enrichment.

**Table 7-16: Health effects of ambient ozone and PM<sub>2.5</sub>.**

| Category   | Effect  | Effect Quantified | Effect Monetized       | More Information       |
|--|---|-------------------|------------------------|------------------------|
| Premature mortality from exposure to PM <sub>2.5</sub>     | Adult premature mortality from long-term exposure (age >17 or >64)  | ✓                 | ✓                      | PM ISA                 |
|  | Infant mortality (age <1)   | ✓                 | ✓                      | PM ISA                 |
| Nonfatal morbidity from exposure to PM <sub>2.5</sub>      | Non-fatal heart attacks (>18)   | ✓                 | ✓ <sup>a</sup>         | PM ISA                 |
|  | Hospital admissions - cardiovascular (all)  | ✓                 | ✓                      | PM ISA                 |
|  | Hospital admissions - respiratory (<19 and >64)   | ✓                 | ✓                      | PM ISA                 |
|  | Hospital admissions - Alzheimer's disease (>64)   | ✓                 | ✓                      | PM ISA                 |
|  | Hospital admissions - Parkinson's disease (>64)   | ✓                 | ✓                      | PM ISA                 |
|  | Emergency department visits – cardiovascular (all)  | ✓                 | ✓ <sup>a</sup>         | PM ISA                 |
|  | Emergency department visits – respiratory (all)   | ✓                 | ✓ <sup>a</sup>         | PM ISA                 |
|  | Emergency hospital admissions (>65)   | ✓                 | ✓                      | PM ISA                 |
|  | Non-fatal lung cancer (>29) <sup>2</sup>  | ✓                 | ✓                      | PM ISA                 |
|  | Out-of-hospital cardiac arrest (all)  | ✓                 | ✓                      | PM ISA                 |
|  | Stroke incidence (50-79)  | ✓                 | ✓                      | PM ISA                 |
|  | New onset asthma (<12)  | ✓                 | ✓                      | PM ISA                 |
|  | Exacerbated asthma – albuterol inhaler use (asthmatics, 6-13)   | ✓                 | ✓                      | PM ISA                 |
|  | Lost work days (18-64)  | ✓                 | ✓                      | PM ISA                 |
|  | Minor restricted-activity days (18-64)  | ✓                 | ✓                      | PM ISA                 |
| Mortality from exposure to ozone                           | Other cardiovascular effects (e.g., other ages)   | —                 | —                      | PM ISA <sup>b</sup>    |
|  | Other respiratory effects (e.g., pulmonary function, non-asthma ER visits, non-bronchitis chronic diseases, other ages and populations) | —                 | —                      | PM ISA <sup>b</sup>    |
|  | Other nervous system effects (e.g., autism, cognitive decline, dementia)  | —                 | —                      | PM ISA <sup>b</sup>    |
|  | Metabolic effects (e.g., diabetes)  | —                 | —                      | PM ISA <sup>b</sup>    |
|  | Reproductive and developmental effects (e.g., low birth weight, pre-term births, etc.)  | —                 | —                      | PM ISA <sup>b</sup>    |
|  | Cancer, mutagenicity, and genotoxicity effects  | —                 | —                      | PM ISA <sup>b</sup>    |
| Nonfatal morbidity from exposure to ozone                  | Premature respiratory mortality from short-term exposure (0-99)   | ✓                 | ✓                      | Ozone ISA              |
|  | Premature respiratory mortality from long-term exposure (age 30–99)   | ✓                 | ✓                      | Ozone ISA              |
|  | Hospital admissions—respiratory (ages 65-99)  | ✓                 | ✓                      | Ozone ISA              |
|  | Emergency department visits—respiratory (ages 0-99)   | ✓                 | ✓                      | Ozone ISA              |
|  | Asthma onset (0-17)   | ✓                 | ✓                      | Ozone ISA              |
|  | Asthma symptoms/exacerbation (asthmatics age 5-17)  | ✓                 | ✓                      | Ozone ISA              |
|  | Allergic rhinitis (hay fever) symptoms (ages 3-17)  | ✓                 | ✓                      | Ozone ISA              |
|  | Minor restricted-activity days (age 18–65)  | ✓                 | ✓                      | Ozone ISA              |
|  | School absence days (age 5–17)  | ✓                 | ✓                      | Ozone ISA              |
|  | Decreased outdoor worker productivity (age 18–65)   | —                 | —                      | Ozone ISA <sup>b</sup> |
| Metabolic effects (e.g., diabetes)                         | —   | —                 | Ozone ISA <sup>b</sup> |                        |
| Other respiratory effects (e.g., premature aging of lungs) | —   | —                 | Ozone ISA <sup>b</sup> |                        |
| Cardiovascular and nervous system effects                  | —   | —                 | Ozone ISA <sup>b</sup> |                        |
| Reproductive and developmental effects                     | —   | —                 | Ozone ISA <sup>b</sup> |                        |

<sup>a</sup> Valuation estimate excludes initial hospital and/or emergency department visits.

<sup>b</sup> Not quantified due to data availability limitations and/or because current evidence is only suggestive of causality.

Below we report the estimated number and economic value of reduced premature deaths and illnesses in 2055 attributable to the modeled regulatory scenario along with the 95 percent confidence interval. Table 7-17 reports the number of reduced deaths and illnesses associated with reductions in PM<sub>2.5</sub>, along with their monetized economic value.

Table 7-18 reports the number of reduced ozone-related deaths and illnesses, along with their monetized economic value. Table 7-19 reports total benefits associated with the regulatory scenario in 2055, reflecting alternative combinations of the economic value of PM<sub>2.5</sub>- and ozone-related premature deaths summed with the economic value of illnesses for each discount rate.

**Table 7-17: Quantified and monetized avoided PM<sub>2.5</sub>-related premature mortalities and illnesses of the regulatory scenario in 2055 (95% confidence interval)<sup>a</sup>.**

| Avoided PM Outcomes            |   | Point Estimate                        |                         | Valuation (Millions, 2022\$)   |                            |
|--------------------------------|---|---------------------------------------|-------------------------|--------------------------------|----------------------------|
| All-Cause Mortality            | (Wu et al. 2020) (65-99)                              | 1,000<br>(900 to 1,100)               | 2% <sup>b</sup>         | \$14,000 (\$1,300 to \$37,000) |                            |
|                                |   |                                       | 3%                      | \$14,000 (\$1,300 to \$36,000) |                            |
|                                |   |                                       | 7%                      | \$12,000 (\$1,100 to \$32,000) |                            |
|                                | (Pope III et al. 2019) (18-99)                        | 2,000<br>(1,400 to 2,500)             | 2%                      | \$27,000 (\$2,500 to \$74,000) |                            |
|                                |   |                                       | 3%                      | \$27,000 (\$2,400 to \$72,000) |                            |
|                                |   |                                       | 7%                      | \$24,000 (\$2,200 to \$65,000) |                            |
| (Woodruff 2008) (0-0)          | 1.6<br>(-0.98 to 4.0)                                 |                                       | \$23<br>(\$-13 to \$92) |                                |                            |
| ER visits, respiratory         | ER visits, All Cardiac Outcomes                       | 310<br>(-120 to 720)                  |                         | \$0.47<br>(\$-0.18 to \$1.1)   |                            |
|                                | ER visits, respiratory                                | 560<br>(110 to 1,200)                 |                         | \$0.64<br>(\$0.13 to \$1.3)    |                            |
| Hospital Admissions            | HA, Alzheimers Disease                                | 530<br>(390 to 660)                   |                         | \$8.3<br>(\$6.2 to \$10)       |                            |
|                                | HA, Cardio-, Cerebro- and Peripheral Vascular Disease | 150<br>(110 to 190)                   |                         | \$3.0<br>(\$2.2 to \$3.9)      |                            |
|                                | HA, Parkinsons Disease                                | 61<br>(31 to 90)                      |                         | \$1.0<br>(\$0.52 to \$1.5)     |                            |
|                                | HA, Respiratory-2 HA, All Respiratory                 | 91<br>(31 to 150)                     |                         | \$2.0<br>(\$0.42 to \$3.4)     |                            |
| Respiratory Incidence          | Incidence, Asthma                                     | 2,100<br>(2,000 to 2,200)             | 2%                      | \$120<br>(\$110 to \$130)      |                            |
|                                |   |                                       | 3%                      | \$120<br>(\$110 to \$130)      |                            |
|                                |   |                                       | 7%                      | \$76<br>(\$71 to \$80)         |                            |
|                                | Incidence, Hay Fever/Rhinitis                         | 14,000<br>(3,300 to 24,000)           |                         | \$11<br>(\$2.6 to \$19)        |                            |
|                                | Incidence, Lung Cancer                                | 74<br>(22 to 120)                     | 2%                      | \$3.1<br>(\$0.94 to \$5.2)     |                            |
|                                |   |                                       | 3%                      | \$2.6<br>(\$0.78 to \$4.3)     |                            |
|                                |   |                                       | 7%                      | \$1.9<br>(\$0.59 to \$3.2)     |                            |
|                                | Incidence, Out of Hospital Cardiac Arrest             | 15<br>(-6.1 to 34)                    | 2%                      | \$0.70<br>(\$-0.29 to \$1.6)   |                            |
|                                |   |                                       | 3%                      | \$0.70<br>(\$-0.29 to \$1.6)   |                            |
|                                |   |                                       | 7%                      | \$0.70<br>(\$-0.28 to \$1.6)   |                            |
|                                | Asthma Symptoms, Albuterol use                        | 400,000<br>(-200,000 to 980,000)      |                         | \$0.18<br>(\$-0.089 to \$0.45) |                            |
|                                | Additional Morbidity Effects                          | Acute Myocardial Infarction, Nonfatal | 33<br>(19 to 46)        | 2%                             | \$2.2<br>(\$1.3d to \$3.0) |
|                                |   |                                       |                         | 3%                             | \$2.1<br>(\$1.2 to \$3.0)  |
|                                |   |                                       |                         | 7%                             | \$2.1<br>(\$1.2 to \$2.9)  |
| Incidence, Stroke              |   | 58<br>(15 to 100)                     |                         | \$2.6<br>(\$0.67 to \$4.4)     |                            |
| Minor Restricted Activity Days |   | 680,000<br>(550,000 to 800,000)       |                         | \$65<br>(\$34 to \$99)         |                            |
| Work Loss Days                 |   | 110,000<br>(96,000 to 130,000)        |                         | \$25<br>(\$21 to \$29)         |                            |

<sup>a</sup> Values rounded to two significant figures.

<sup>b</sup> We discount the value of those avoided health outcomes that are expected to accrue over more than a single year. Note that for Asthma Incidence and Out of Hospital Cardiac Arrests, we do not yet have discounted value streams using a 2 percent discount rate. We repeat the 3 percent values in these instances.

**Table 7-18: Quantified and monetized avoided ozone-related premature mortalities and illnesses of the regulatory scenario in 2055 (95% confidence interval)<sup>a</sup>.**

| Avoided Ozone Outcomes                    |                     |   | Avoided Outcomes                  |                                   | Valuation<br>(Millions, 2022\$) |                              |
|---|---------------------|---|-----------------------------------|-----------------------------------|---------------------------------|------------------------------|
| Avoided Premature Respiratory Mortalities | Long-term Exposure  | (Turner 2016)                                   | 550<br>(380 to 710)               | 2% <sup>b</sup>                   | \$7,600<br>(\$680 to \$21,000)  |                              |
|   |                     |   |                                   | 3%                                | \$7,400<br>(\$660 to \$20,000)  |                              |
|   |                     |   |                                   | 7%                                | \$6,600<br>(\$600 to \$18,000)  |                              |
|   | Short-Term Exposure | (Katsouyanni 2009) and (Zanobetti 2008), pooled | 25<br>(10 to 39)                  |                                   | \$370<br>(\$30 to \$1,100)      |                              |
| Morbidity Effects                         | Long-term Exposure  | Asthma Onset                                    | 3,700<br>(3,200 to 4,200)         | 2%                                | \$210<br>(\$180 to \$250)       |                              |
|   |                     |   |                                   | 3%                                | \$210<br>(\$180 to \$250)       |                              |
|   |                     |   |                                   | 7%                                | \$130<br>(\$110 to \$150)       |                              |
|   |                     |   |                                   |                                   | Allergic Rhinitis Symptoms      | 22,000<br>(12,000 to 32,000) |
|   | Short-Term Exposure |   | Hospital Admissions - Respiratory | 73<br>(-19 to 160)                |                                 | \$3.5<br>(\$-0.91 to \$7.7)  |
|   |                     |   | ER Visits - Respiratory           | 1,300<br>(350 to 2,700)           |                                 | \$1.5<br>(\$0.41 to \$3.1)   |
|   |                     |   | Asthma Symptoms                   | 690,000<br>(-86,000 to 1,400,000) |                                 | \$210<br>(\$-25 to \$430)    |
|   |                     |   | MRADs                             | 350,000<br>(140,000 to 560,000)   |                                 | \$34<br>(\$12 to \$63)       |
|   |                     |   | School Absences                   | 250,000<br>(-36,000 to 530,000)   |                                 | \$34<br>(\$-4.8 to \$72)     |

<sup>a</sup> Values rounded to two significant figures.

<sup>b</sup> We discount the value of those avoided health outcomes that are expected to accrue over more than a single year. Note that for Asthma Onset, we do not yet have discounted value streams using a 2 percent discount rate. We repeat the 3 percent values in this instance.

**Table 7-19: Total PM<sub>2.5</sub> and ozone benefits of the regulatory scenario in 2055 (95% confidence interval, billions of 2022 dollars)<sup>a,b</sup>.**

|   | <b>PM<sub>2.5</sub></b> | <b>Ozone</b>                 | <b>Total</b>           |
|---|-------------------------|------------------------------|------------------------|
| Benefits using PM <sub>2.5</sub> -related mortality estimate from Pope III et al., 2019 (Pope III et al. 2019) and ozone-related mortality estimate from Turner et al., 2016 (Turner 2016)  |                         |                              |                        |
| 2% Discount Rate  | \$28<br>(\$2.7 - \$74)  | \$8.7<br>(\$0.65 - \$23)     | \$36<br>(\$3.3 - \$98) |
| 3% Discount Rate  | \$27<br>(\$2.6 - \$72)  | \$8.5<br>(\$0.63 - \$23)     | \$35<br>(\$3.2 - \$95) |
| 7% Discount Rate  | \$24<br>(\$2.3 - \$65)  | \$7.6<br>(\$0.50 - \$21)     | \$32<br>(\$2.8 - \$86) |
| Benefits using PM <sub>2.5</sub> -related mortality estimate from Wu et al., 2020 (Wu et al. 2020) and a pooled ozone-related mortality estimate from Katsouyanni et al., 2009 (Katsouyanni 2009) and Zanobetti et al., 2008 (Zanobetti 2008) |                         |                              |                        |
| 2% Discount Rate  | \$14<br>(\$1.5 - \$38)  | \$1.5<br>(\$-0.0010 - \$3.8) | \$16<br>(\$1.5 - \$41) |
| 3% Discount Rate  | \$14<br>(\$1.4 - \$36)  | \$1.5<br>(\$-0.0010 - \$3.8) | \$15<br>(\$1.4 - \$40) |
| 7% Discount Rate  | \$12<br>(\$1.3 - \$33)  | \$1.4<br>(\$ -0.071 - \$3.7) | \$14<br>(\$1.2 - \$37) |
| <sup>a</sup> Values rounded to two significant figures.   |                         |                              |                        |
| <sup>b</sup> The benefits associated with the standards presented here do not include the full complement of health and environmental benefits that, if quantified and monetized, would increase the total monetized benefits.                |                         |                              |                        |

In any complex analysis using estimated parameters and inputs from numerous models, there are likely to be many sources of uncertainty. The health benefits TSD that was published for the 2023 PM NAAQS Reconsideration Proposal details our approach to characterizing uncertainty in both quantitative and qualitative terms. That TSD describes the sources of uncertainty associated with key input parameters including emissions inventories, air quality data from models (with their associated parameters and inputs), population data, population estimates, health effect estimates from epidemiology studies, economic data for monetizing benefits, and assumptions regarding the future state of the country (i.e., regulations, technology, and human behavior). Each of these inputs is uncertain and affects the size and distribution of the estimated benefits. When the uncertainties from each stage of the analysis are compounded, even small uncertainties can have large effects on the total quantified benefits.

## 7.6 Demographic Analysis

### 7.6.1 Overview

When feasible, EPA conducts full-scale photochemical air quality modeling to demonstrate how its national mobile source regulatory actions affect ambient concentrations of regional pollutants throughout the United States. As described in this Chapter, we conducted air quality modeling of future (2055) projections of PM<sub>2.5</sub> and ozone concentrations in a “baseline” scenario absent the rule and in a “control” scenario that assumes the rule is in place. These baseline and control scenarios are also used as inputs to the health benefits analysis (see RIA Chapter 7.5). The ozone and PM<sub>2.5</sub> health benefits that are projected to result from the rule will be substantial.

This air quality modeling data can also be used to conduct an analysis of how human exposure to future air quality varies with population characteristics relevant to potential environmental justice concerns in scenarios with and without the rule in place. Although the spatial resolution of the air quality modeling is not sufficient to capture very local heterogeneity of human exposures, particularly the pollution concentration gradients near roads, the air quality modeling data can be used to observe demographic trends at a national scale.

We conducted an analysis using the air quality modeling data to demonstrate how this rule will affect different population groups with potential EJ concerns throughout the U.S. This rule applies nationally and will be implemented consistently throughout the nation. Specifically, because this final rule affects both onroad and upstream emissions, and because PM emission precursors and ozone can undergo long-range transport, it is appropriate to conduct a national-scale EJ assessment of the contiguous U.S.<sup>245</sup> As depicted in the maps presented in RIA Chapter 7.4, these reductions will be geographically widespread. Taking these factors into consideration, this demographic analysis evaluates both national average exposures and the distribution of exposure outcomes that will result from the final rule.

### 7.6.2 Air Quality, Population and Demographic Data

We began with projected 2055 baseline and control scenarios of modeled PM<sub>2.5</sub> and ozone concentration data (described in RIA Chapter 7.4). Ambient air quality concentration data (annual average  $\mu\text{g}/\text{m}^3$  for PM<sub>2.5</sub> and April-September daily maximum 8-hour average ppb for ozone) was estimated at a standard grid resolution of 12km x 12km across the contiguous United States (CONUS).

The analysis also used population projections based on proprietary economic forecasting models developed by Woods and Poole in 2015 (Woods & Poole 2015). The Woods and Poole database contains county-level projections of population by age, sex, and race out to 2060, relative to a baseline using the 2010 Census data. Population projections for each county are determined simultaneously with every other county in the U.S to consider patterns of economic growth and migration. The sum of growth in county-level populations is constrained to equal a previously determined national population growth, based on Bureau of Census estimates

---

<sup>245</sup> As we note in Chapter 7.3.2, the CMAQ modeling output we use as an input to the demographic analysis projects ambient concentrations of air pollution over a domain that is limited to the continental United States and portions of Canada and Mexico. We therefore are unable to conduct the same demographic analysis for Alaska, Hawaii, Puerto Rico, and the Pacific Islands.

(Hollmann, F. et al. 2000). According to Woods and Poole, linking county-level growth projections together and constraining to a national-level total growth avoids potential errors introduced by forecasting each county independently. Total projected population in 2055, and 2055 population stratified by race/ethnicity, was extracted from the Environmental Benefits Mapping and Analysis Program – Community Edition (BenMAP-CE) at the same 12km x 12km grid resolution as the air quality data to allow for the estimation of human exposure to PM<sub>2.5</sub> and ozone in scenarios both without and with the rule in place.<sup>246,247</sup>

The population variables considered in this EJ assessment are described in Table 7-20. These variables are relevant to potential EJ concerns and are consistent with those first presented in the recently finalized “Regulatory Impact Analysis of the Standards of Performance for New, Reconstructed, and Modified Sources and Emissions Guidelines for Existing Sources: Oil and Natural Gas Sector Climate Review” (U.S. EPA 2023). The variables include race and ethnicity (Hispanic, Non-Hispanic White, Non-Hispanic Black, Non-Hispanic Asian, Non-Hispanic Native American), linguistic isolation (those not fluent in English), educational attainment (those 25 and older with and without high school education), poverty status (those below the federal poverty line and those below 200% of the federal poverty line), Tribal lands, urban status (metropolitan area or not), historically redlined areas (HOLC Grades A-C and HOLC Grade D), life expectancy (those at or below the 25th percentile of life expectancy), health insurance status (insured or uninsured), and employment status (employed or unemployed). We have also added disability status (disabled or not disabled) to this analysis.

We note that for all variables except race/ethnicity, we applied recent measures of population characteristics to the projected population in 2055 (see Table 7-20). The projected populations for each of the population variables in 2055 were then extracted from BenMAP-CE at the same 12km x 12km grid resolution as the air quality data to allow for the estimation of human exposure to PM<sub>2.5</sub> and ozone in scenarios both without and with the rule in place. The use of this data to project conditions in the future is inherently uncertain since measures of recent population characteristics are not necessarily predictors of the status of future populations.

---

<sup>246</sup> Information about the BenMAP-CE tool can be found here: <https://www.epa.gov/benmap>. Additional information regarding the population projections used in this analysis can be found in Appendix J of the BenMAP-CE User’s Manual (<https://www.epa.gov/benmap/benmap-ce-manual-and-appendices>).

<sup>247</sup> In 2055, we estimate that there are 446 million people projected to be living in the contiguous United States; 209 million are projected to be Non-Hispanic-White (NH-White) and 236 million are projected to be people of color. To put these projections into perspective, 2010 populations for the contiguous United States were 201 million for NH-White and 106 million for people of color.



**Table 7-20: Demographic Population Variables Included in the EJ Analysis.**

| Population                           | Groups  | Age Range | Spatial Scale | Data Source   |
|--------------------------------------|---|-----------|---------------|---|
| Race/Ethnicity                       | Hispanic, Non-Hispanic (NH)<br>White, NH Native American, NH<br>Asian, NH Black     | 0-99      | Census Tract  | Woods & Poole <sup>c</sup>                            |
| Poverty Status                       | Above Federal Poverty Line (FPL),<br>Below FPL, Above Twice FPL,<br>Below Twice FPL | 0-99      | Census Tract  | American Community<br>Survey (2015-2019) <sup>d</sup> |
| Urban Status                         | Metropolitan (Metro) Area,<br>Non-Metro Area  | 0-99      | County        | USDA Rural Urban<br>Continuum Code <sup>e</sup>       |
| Historical<br>Redlining <sup>a</sup> | HOLC Grades A-C, HOLC Grade<br>D (“Redlined”)                                       | 0-99      | Census Tract  | Home Owners’<br>Loan Corporation <sup>f</sup>         |
| Linguistic<br>Isolation              | Linguistically Isolated (English <<br>“well”), Fluent in English                    | 0-99      | Census Tract  | American Community<br>Survey (2015-2019) <sup>d</sup> |
| Educational<br>Attainment            | No High School Degree, High<br>School Degree or More                                | 25-99     | Census Tract  | American Community<br>Survey (2015-2019) <sup>d</sup> |
| Disability Status                    | Not Disabled, Disabled  | 0-99      | Census Tract  | American Community<br>Survey (2015-2019) <sup>d</sup> |
| Employment<br>Status                 | Employed, Unemployed  | 0-99      | County        | U.S. Census Bureau, 2017<br>to 2021 <sup>g</sup>      |
| Health<br>Insurance Status           | Uninsured, Insured  | 0-64      | County        | U.S. Census Bureau, 2015<br>to 2019 <sup>h</sup>      |
| Tribal Land                          | Tribal Land, Not Tribal Land  | 0-99      | Census Tract  | Bureau of Indian Affairs <sup>i</sup>                 |
| Life<br>Expectancy <sup>b</sup>      | Bottom 25%ile; Top 75%ile   | 0-99      | Census Tract  | CDC USALEEP, 2010 to<br>2015 <sup>j</sup>             |

<sup>a</sup> The variable “redlined areas” is used to assess exposure in communities with a legacy of discriminatory land use designations and siting decisions (i.e., historically redlined areas).

<sup>b</sup> The life expectancy variable is one way to assess cumulative exposures and impacts. The variable differentiates between populations with differing baseline health levels and measures the average life expectancy within a census tract. For average life expectancy, low values indicate a higher overall burden or cumulative risk, while higher values indicate a lower overall burden or cumulative risk.

<sup>c</sup> Population data is projected out to the future year 2055 based on economic forecasting models developed by Woods and Poole, Inc. (Woods & Poole, 2015). The Woods and Poole database contains county-level projections of population by race/ethnicity out to 2060, relative to a baseline using 2010 Census data.

<sup>d</sup> The American Community Survey (ACS) data represent 5-year average estimates from 2015 to 2019.

<sup>e</sup> The US Department of Agriculture’s 2013 Rural Urban Continuum Codes (RUCC) classify metropolitan counties by the population size of their metropolitan area, and nonmetropolitan counties by the degree of urbanization and adjacency to a metro area.

<sup>f</sup> Graded census tracts developed by Noelke et al. (2022) from digitized Home Owners’ Loan Corporation (HOLC) residential security maps overlaid onto 2010 Census tracts. Each census tract is classified as being covered by “Mainly A,” “Mainly B,” “Mainly C,” and “Mainly D” grading, corresponding to coverage of different hazard ratings from original HOLC maps. Census tracts labeled “HOLC Grade D” are categorized as redlined areas and census tracts that were mainly “HOLC Grades A-C” are categorized as not redlined.

<sup>g</sup> County-level unemployment rates are from the Bureau of Labor Statistics from 2017 to 2021.

<sup>h</sup> County-level data from the Small Area Health Insurance Estimates (SAHIE) collected by the U.S. Census Bureau from 2015 to 2019.

<sup>i</sup> Tribal lands are defined by the Bureau of Indian Affairs (bia.gov).

<sup>j</sup> Census tract-level life expectancy estimates for the period 2010-2015 from CDC’s U.S. Small-area Life Expectancy Estimates Project (USALEEP).

### **7.6.3 National Population-Weighted Average Concentration Analysis**

In Table 7-21 and Table 7-22, we present the national population-weighted average PM<sub>2.5</sub> and ozone concentrations in 2055, respectively, for each specific population group in scenarios without (baseline) and with (control) the rule in place. We also present the reduction in PM<sub>2.5</sub> and ozone (from baseline to control) for each population group along with the relative reduction from baseline expressed as a percentage. To highlight the changes in each category, results are color-coded by air quality (lighter colors represent lower average concentrations and darker coloring represents higher average concentrations). We note that on average, all population groups will benefit from reductions in exposure to ambient PM<sub>2.5</sub> and ozone due to the final rule.

**Table 7-21: Population-weighted averages for the reference, control, absolute difference, and relative difference (in percentage terms) for each population group for PM<sub>2.5</sub> reductions in 2055 associated with the final rule.**

| Demographic Variable           | Population (million) | PM <sub>2.5</sub> Concentrations (µg/m <sup>3</sup> ) |         |                     |                    |
|--------------------------------|----------------------|---|---------|---------------------|--------------------|
|                                |                      | Baseline  | Control | Absolute Difference | Percent Difference |
| Total U.S. (CONUS)             | 446                  | 6.89  | 6.85    | 0.044               | 0.64%              |
| Hispanic                       | 127                  | 7.54  | 7.49    | 0.049               | 0.64%              |
| NH White                       | 209                  | 6.41  | 6.37    | 0.039               | 0.62%              |
| NH Asian                       | 43                   | 7.27  | 7.22    | 0.049               | 0.68%              |
| NH Black                       | 63                   | 6.97  | 6.92    | 0.048               | 0.69%              |
| NH Native American             | 3.4                  | 5.90  | 5.87    | 0.029               | 0.49%              |
| Fluent in English              | 424                  | 6.84  | 6.80    | 0.044               | 0.64%              |
| Linguistically Isolated        | 22                   | 7.84  | 7.79    | 0.052               | 0.67%              |
| With HS Education              | 268                  | 6.81  | 6.76    | 0.044               | 0.64%              |
| Without HS Education           | 46                   | 7.25  | 7.20    | 0.047               | 0.65%              |
| Disabled                       | 56                   | 6.77  | 6.73    | 0.042               | 0.62%              |
| Not Disabled                   | 390                  | 6.91  | 6.87    | 0.045               | 0.64%              |
| Below Poverty                  | 70                   | 7.07  | 7.02    | 0.045               | 0.64%              |
| Above Poverty                  | 376                  | 6.86  | 6.82    | 0.044               | 0.64%              |
| Below Twice Poverty            | 146                  | 7.03  | 6.99    | 0.045               | 0.64%              |
| Above Twice Poverty            | 299                  | 6.82  | 6.78    | 0.044               | 0.64%              |
| Tribal Lands                   | 4.6                  | 6.35  | 6.32    | 0.030               | 0.47%              |
| Not Tribal Land                | 441                  | 6.90  | 6.85    | 0.044               | 0.64%              |
| Metro                          | 391                  | 7.08  | 7.04    | 0.047               | 0.66%              |
| Non-Metro                      | 55                   | 5.53  | 5.50    | 0.026               | 0.46%              |
| HOLC Grades: A-C               | 50                   | 7.65  | 7.59    | 0.063               | 0.82%              |
| HOLC Grade: D – Redlined Areas | 18                   | 7.89  | 7.82    | 0.065               | 0.83%              |
| Top 75%ile Life Expectancy     | 329                  | 6.90  | 6.86    | 0.044               | 0.64%              |
| Bottom 25%ile Life Expectancy  | 88                   | 6.85  | 6.80    | 0.044               | 0.65%              |
| Has Health Insurance           | 317                  | 6.91  | 6.87    | 0.045               | 0.65%              |
| No Health Insurance            | 39                   | 7.01  | 6.97    | 0.045               | 0.64%              |
| Employed                       | 209                  | 6.88  | 6.84    | 0.045               | 0.65%              |
| Unemployed                     | 11                   | 7.05  | 7.00    | 0.046               | 0.65%              |

**Table 7-22: Population-weighted averages for the reference, control, absolute difference, and relative difference (in percentage terms) for each population group for ozone reductions in 2055 associated with the final rule.**

| Demographic Variable           | Population (million) | Ozone Concentrations (ppb) |         |                     |                    |
|--------------------------------|----------------------|----------------------------|---------|---------------------|--------------------|
|                                |                      | Baseline                   | Control | Absolute Difference | Percent Difference |
| Total U.S. (CONUS)             | 446                  | 38.93                      | 38.76   | 0.164               | 0.42%              |
| Hispanic                       | 127                  | 40.98                      | 40.81   | 0.168               | 0.41%              |
| NH White                       | 209                  | 37.99                      | 37.83   | 0.157               | 0.41%              |
| NH Asian                       | 43                   | 40.27                      | 40.11   | 0.168               | 0.42%              |
| NH Black                       | 63                   | 36.88                      | 36.70   | 0.176               | 0.48%              |
| NH Native American             | 3.4                  | 40.94                      | 40.81   | 0.125               | 0.31%              |
| Fluent in English              | 424                  | 38.82                      | 38.66   | 0.164               | 0.42%              |
| Linguistically Isolated        | 22                   | 40.94                      | 40.78   | 0.161               | 0.39%              |
| With HS Education              | 268                  | 38.74                      | 38.58   | 0.163               | 0.42%              |
| Without HS Education           | 46                   | 39.63                      | 39.47   | 0.163               | 0.41%              |
| Disabled                       | 56                   | 38.42                      | 38.26   | 0.160               | 0.42%              |
| Not Disabled                   | 390                  | 39.00                      | 38.83   | 0.164               | 0.42%              |
| Below Poverty                  | 70                   | 38.92                      | 38.76   | 0.162               | 0.41%              |
| Above Poverty                  | 376                  | 38.93                      | 38.76   | 0.164               | 0.42%              |
| Below Twice Poverty            | 146                  | 38.91                      | 38.75   | 0.162               | 0.42%              |
| Above Twice Poverty            | 299                  | 38.93                      | 38.77   | 0.165               | 0.42%              |
| Tribal Lands                   | 4.6                  | 39.99                      | 39.85   | 0.138               | 0.35%              |
| Not Tribal Land                | 441                  | 38.92                      | 38.75   | 0.164               | 0.42%              |
| Metro                          | 391                  | 39.30                      | 39.13   | 0.170               | 0.43%              |
| Non-Metro                      | 55                   | 36.28                      | 36.16   | 0.121               | 0.33%              |
| HOLC Grades: A-C               | 50                   | 40.51                      | 40.37   | 0.143               | 0.35%              |
| HOLC Grade: D – Redlined Areas | 18                   | 39.74                      | 39.61   | 0.131               | 0.33%              |
| Top 75%ile Life Expectancy     | 329                  | 39.35                      | 39.18   | 0.162               | 0.41%              |
| Bottom 25%ile Life Expectancy  | 88                   | 37.35                      | 37.19   | 0.168               | 0.45%              |
| Has Health Insurance           | 317                  | 39.06                      | 38.89   | 0.164               | 0.42%              |
| No Health Insurance            | 39                   | 38.37                      | 38.20   | 0.167               | 0.43%              |
| Employed                       | 209                  | 38.94                      | 38.77   | 0.163               | 0.42%              |
| Unemployed                     | 11                   | 39.50                      | 39.34   | 0.164               | 0.42%              |

As shown in Table 7-21, the 2055 population-weighted baseline concentration of PM<sub>2.5</sub> across the total CONUS population is 6.89 µg/m<sup>3</sup>. Certain population groups have population-weighted average baseline concentrations that are higher than the national average (the shaded concentrations in Table 7-21 and Table 7-22), indicating disproportionate exposures in the future baseline. For example, both Hispanics and those who are linguistically isolated are among the population groups that have higher population-weighted average baseline PM<sub>2.5</sub> concentrations compared to the national average, at 7.54 and 7.84 µg/m<sup>3</sup>, respectively. Large urban areas that were designated by HOLC as Grades A-C and Grade D are also among the population groups that have the highest baseline PM<sub>2.5</sub> concentrations compared to the national average, at 7.65 and 7.89 µg/m<sup>3</sup>, respectively. In general, those who are most exposed to elevated concentrations of PM<sub>2.5</sub> in the 2055 baseline will also experience some of the greatest absolute and relative reductions in PM<sub>2.5</sub> exposure. However, most population groups are projected to experience an absolute reduction in PM<sub>2.5</sub> that is similar to the national average of 0.044 µg/m<sup>3</sup>, and only minor differences in relative terms.

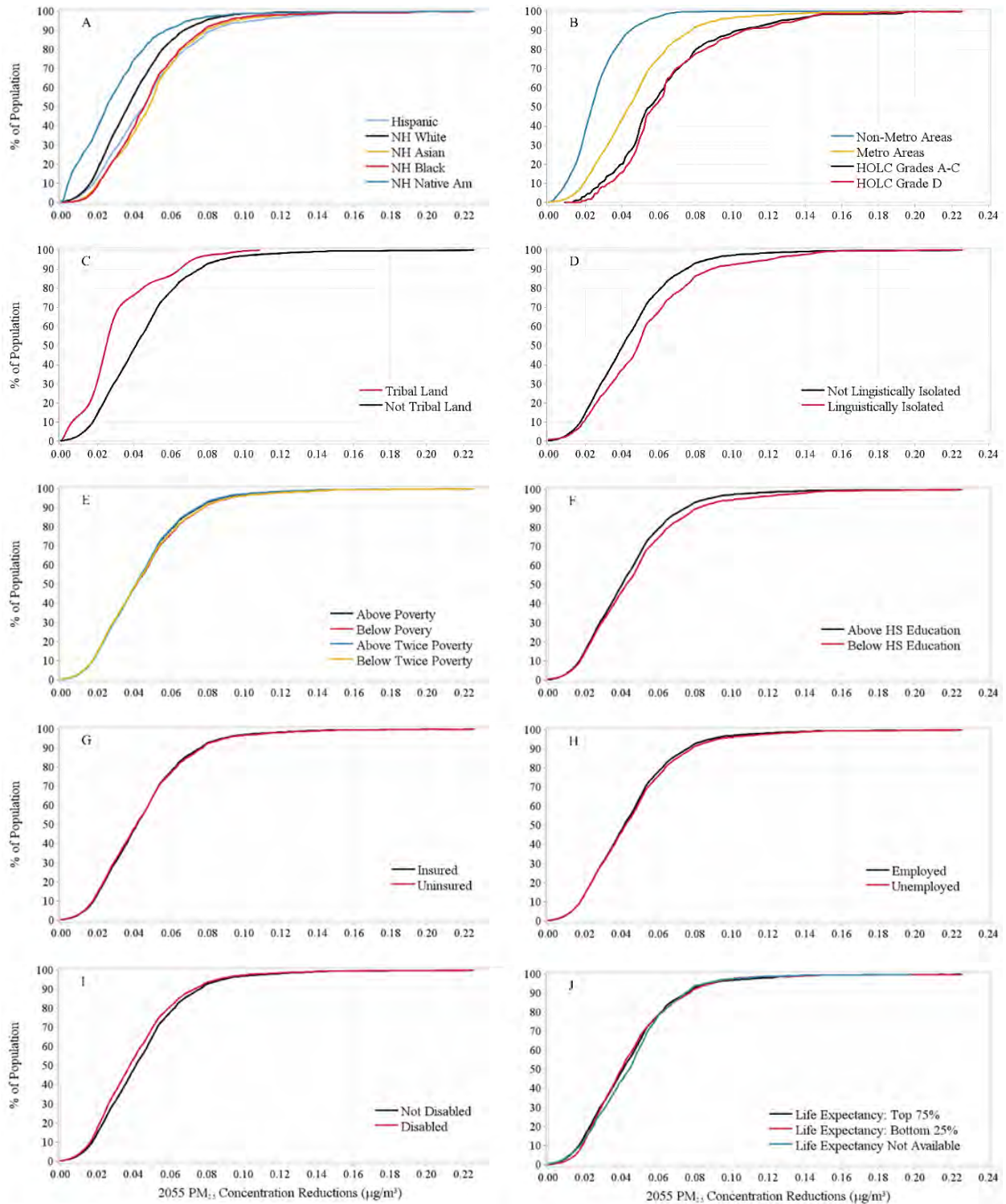
As shown in Table 7-22, the national population-weighted baseline ozone concentration is 38.93 ppb. Hispanics, Non-Hispanic Native Americans, and those who are linguistically isolated have higher baseline population-weighted averages, at 40.98, 40.94 and 40.94 ppb, respectively. Ozone is a more regional pollutant that is formed in the atmosphere and can undergo long-range transport, and the reduction in ozone from this final rule is relatively consistent across the population groups. Most population groups are projected to experience an absolute difference in the ozone concentration that is similar to the national average of 0.16 ppb, and only very minor differences in relative terms. The Non-Hispanic Black population will experience the greatest absolute and percent reduction in ozone concentration.

In summary, projected disparities in 2055 are not likely mitigated or exacerbated by the rule for most of the population groups evaluated, due to the relatively similar pollution concentration reductions across demographic groups, especially for ozone. However, for some population groups, nationally-averaged exposure disparity is mitigated to a small degree in both absolute and relative terms.

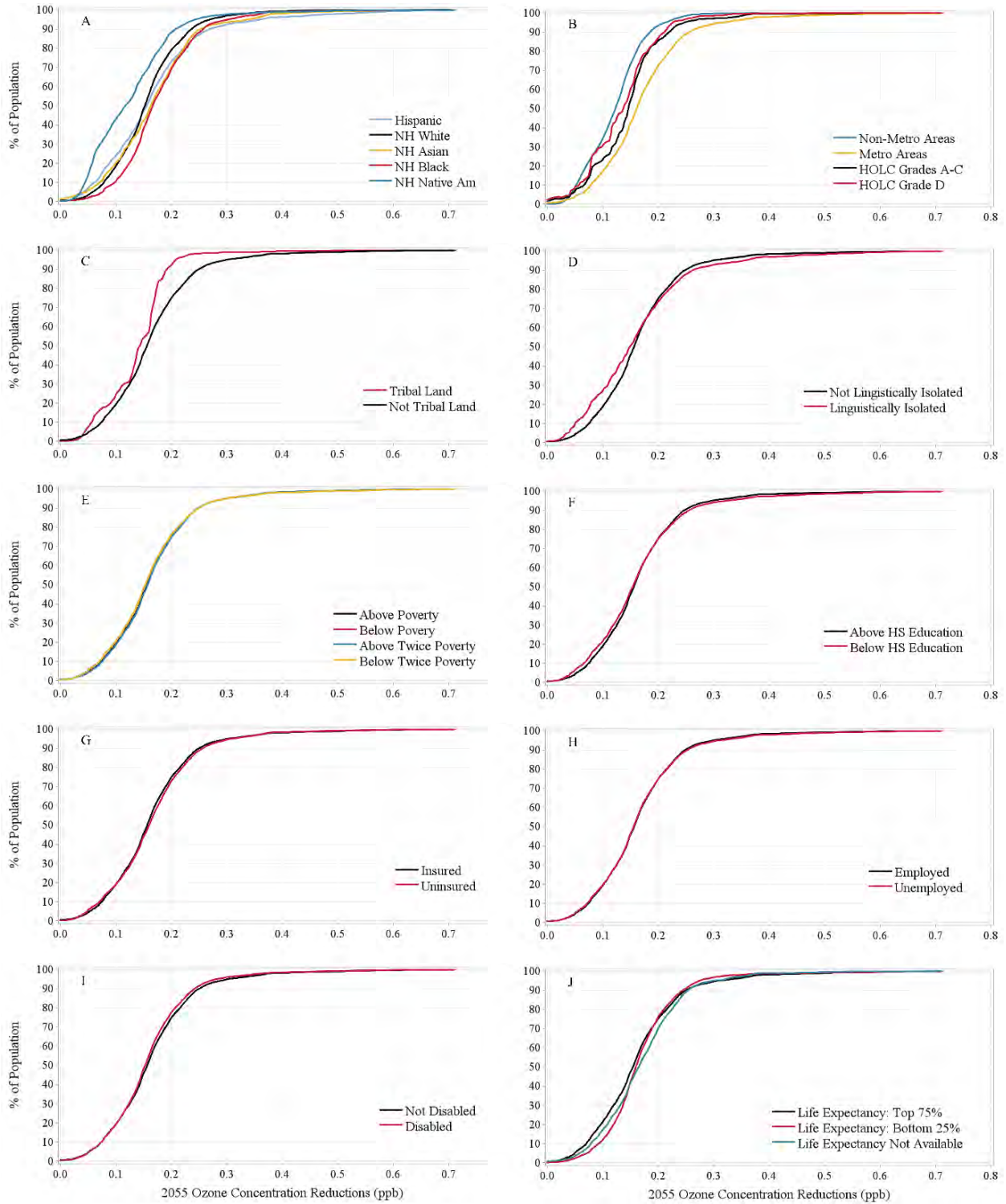
#### **7.6.4 National Distributional Analysis**

While the national average results described above can provide some insight when comparing within and across population groups, they do not provide information on the full distribution of concentration impacts. This is because both population groups and ambient concentrations can be unevenly distributed across the spectrum of exposures, meaning that average exposures may mask important regional disparities. We therefore conducted a distributional analysis using cumulative distribution plots of pollution exposure reductions for each EJ population variable for this final rule. However, given the spatial scale of our air quality modeling data (12km grid cell resolution), this distributional analysis does not reflect near-roadway impacts.

To evaluate how the distribution of exposure reductions varies within and across population groups, we plot the full array of exposure reductions projected to be experienced by the entirety of each population group for PM<sub>2.5</sub> and ozone (Figure 7-31 and Figure 7-32, respectively). The distribution plots present the running sum of each group's total population on the y-axis expressed as a percentage (i.e., cumulative percent of population). By constructing the cumulative percent metric, we are able to directly compare exposure reductions across population groups with different population sizes. The x-axis shows reductions in PM<sub>2.5</sub> and ozone concentrations from low to high concentration reductions. Similar to the national average analysis described above, pollution concentrations are at a 12km grid cell resolution and population demographics have been area-weighted at a 12km grid cell resolution for consistency. In other words, plots compare the running sum of each population group against PM<sub>2.5</sub> and ozone concentration reductions such that populations whose trendlines are further right on the plot have a higher proportion of their population experiencing larger reductions in pollution concentrations as a result of the final rule.



**Figure 7-31: Distribution of PM<sub>2.5</sub> concentration reductions ( $\mu\text{g}/\text{m}^3$ ) for each population group in 2055 from this final rule.**



**Figure 7-32: Distribution of ozone concentration reductions (ppb) for each population group in 2055 from this final rule.**



For most of the population groups, the small differences in the distributional plots suggest that the rule is not likely to exacerbate nor mitigate PM<sub>2.5</sub> or ozone exposure concerns. However, differences in the distribution of impacts between some groups do exist.

Nearly the entire distribution of PM<sub>2.5</sub> reductions for Hispanic, NH Black, and NH Asian populations are to the right of the distribution of reductions for NH White and NH Native American populations, meaning those population groups experience larger reductions in PM<sub>2.5</sub> pollution concentrations as a result of the final rule (Figure 7-31, Panel A). However, the differences in reductions are comparatively small between population groups, and all race/ethnicity groups are projected to benefit from the final rule. A similar, though less pronounced, trend in race/ethnicity distributions can also be observed for reductions in ozone exposures (Figure 7-32, Panel A).

Most notably, the distribution plots show that populations who live in urban centers (metropolitan and HOLC-graded areas), and those who are linguistically isolated, are more likely to experience larger reductions in PM<sub>2.5</sub> concentrations than their comparison groups (Figure 7-31, Panels B and D). Because these population groups also have higher average baseline exposures (see Table 7-21), the likelihood that a greater percentage of these population groups experience larger reductions may somewhat mitigate existing disparities in PM<sub>2.5</sub> exposure.

The distribution plot of ozone reductions in metropolitan areas (Figure 7-32, Panel B) is also to the right of the distribution of reductions in non-metropolitan areas, likely reflecting the regional nature of ozone formation and the breadth of metropolitan area definitions.

We also note that tribal areas experience lower PM<sub>2.5</sub> and ozone concentration reductions compared to reductions experienced in non-Tribal areas (Figure 7-31, Panel C and Figure 7-32, Panel C).

### **7.6.5 Uncertainty in the Demographic Analysis**

The results of this demographic analysis are dependent on the available input data and its associated uncertainty. As we note in both the air quality modeling and health benefits chapters, uncertainties exist along the entire pathway from emissions to air quality to population projections and exposure. This analysis is subject to these same sources of uncertainty.

A limitation of this analysis is the 12km x 12km horizontal grid spacing of the air quality modeling domain. Such resolution is unable to capture the heterogeneity of human exposures to pollutants within that area, especially pollutant concentration gradients that exist near roads. EPA is considering how to better estimate the near-roadway air quality impacts of its regulatory actions and how those impacts are distributed across populations.

Another key source of uncertainty is the accuracy of the projected concentrations of PM<sub>2.5</sub> and ozone in 2055. Assumptions that influence projections of future air quality include emissions in the future and the meteorology used to model air quality (2016 conditions). For example, in a few isolated areas, increased electricity generation is projected to increase ambient SO<sub>2</sub>, PM<sub>2.5</sub>, ozone, or some air toxics. However, we expect those projected impacts will decrease over time as the electric power sector becomes cleaner as a result of the IRA and future policies. We therefore urge caution when interpreting with precision the magnitude and location of emissions and pollution concentrations in the future. We also note that decisions about the emissions and other elements used in the air quality modeling were made early in the analytical process for the

final rulemaking. Accordingly, the air quality analysis does not fully represent the final regulatory scenario; however, we consider the modeling results to be a fair reflection of the impact the standards will have on air quality in 2055.

There is also inherent uncertainty in the Woods & Poole-based populations projected out to 2055. As mentioned above, the population projections are based on proprietary economic forecasting models developed by Woods and Poole in 2015 and are relative to a baseline using the 2010 Census data. Underlying the population projections are forecasted variables such as income, employment, and population. Each of these forecasts require many assumptions: economy-wide modeling to project income and employment, net migration rates based on employment opportunities and taking into account fertility and mortality, and the estimation of age/sex/race distributions at the county-level based on historical rates of mortality, fertility, and migration. To the extent these patterns and assumptions have changed since the population projections were estimated, and to the extent that these patterns and assumptions may change in the future, we would expect the projections of future population would be different than those used in this analysis. EPA continues to investigate how best to incorporate population projections into our analyses.

Many of the population variables used in this analysis (see Table 7-20) are based on data from the American Community Survey representing five-year average data collected between 2015-2019, or other recent data sources, that are not projected into the future. The use of this data to project conditions in the future is inherently uncertain since measures of recent population characteristics are not necessarily predictors of the status of future populations. We intend to continue to refine demographic analyses in future rulemakings.

## Chapter 7 References

- Bohac, Stanislav V., and Scott Ludlum. 2023. "Characterization of a Lightly Loaded Underfloor Catalyzed Gasoline Particulate Filter in a Turbocharged Light Duty Truck." *Journal of Engineering for Gas Turbines and Power* 021024-1 - 021024-7.
- Byun, D.W., J.K.S. Ching, and US EPA. 1999. "Science Algorithms of EPA Models-3 Community Multiscale Air Quality (CMAQ) Modeling System."
- Cook, Rich, Sharon Phillips, Madeleine Strum, Alison Eyth, and James Thurman. 2020. "Contribution of mobile sources to secondary formation of carbonyl compounds." *Journal of the Air and Waste Management Association*.
- ERG. 2023. "EXTERNAL PEER REVIEW OF MOVES3.R1 REPORTS: UPDATES TO THE MODELING OF ELECTRIC VEHICLES AND UPDATES TO REFUELING AND NH3 CRITERIA EMISSIONS, Final Peer Review Report."  
[https://cfpub.epa.gov/si/si\\_public\\_file\\_download.cfm?p\\_download\\_id=546439&Lab=OTAQ](https://cfpub.epa.gov/si/si_public_file_download.cfm?p_download_id=546439&Lab=OTAQ).
- Henderson, B. et al. 2018. "Hemispheric-CMAQ Application and Evaluation for 2016." 2019 CMAS Conference .
- Hollmann, F. et al. 2000. Methodology and assumptions for the population projections of the United States: 199 to 2100 (Population Division Working Paper No. 38). Washington, DC: US Bureau of the Census.
- Katsouyanni, K, Samet, JM, Anderson, HR, Atkinson, R, Le Tertre, A, Medina, S, Samoli, E, Touloumi, G, Burnett, RT, Krewski, D, Ramsay, T, Dominici, F, Peng, RD, Schwartz, J, Zanobetti, A and Committee, HEIHR (2009). 2009. "Air pollution and health: a European and North American approach (APHENA)." *Res Rep Health Eff Inst* 142: 5-90.
- Mathur, R. et al. 2017. "Extending the Community Multiscale Air Quality (CMAQ) Modeling System to Hemispheric Scales: Overview of Process Considerations and Initial Applications." *Atmospheric Chemistry Physics* 12449-12474.
- Mo, Tiffany. 2024. "MOVES Versions used in FRM AQM for the Multi-Pollutant Emissions Standards for Model Years 2027 and Later Light-Duty and Medium-Duty Vehicles." Memorandum to Docket EPA-HQ-OAR-2022-0829. February 10.
- National Center for Atmospheric Research. 2022. Weather Research & Forecasting Model (WRF), v4.42. Accessed 2023. <https://www.mmm.ucar.edu/models/wrf>.
- Pope III et al., CA, Lefler, JS, Ezzati, M, Higbee, JD, Marshall, JD, Kim, S-Y, Bechle, M, Gilliat, KS, Vernon, SE and Robinson, AL. 2019. "Mortality risk and fine particulate air pollution in a large, representative cohort of US adults." *Environmental Health Perspectives* 127 (7): 077007.
- Skamarock, W.C. et al. 2008. "A Description of the Advanced Research WRF Version 3."
- Sui, Lang. 2023. "Memorandum to Docket EPA-HQ-OAR-2022-0985. "Heavy-Duty Technology Resource Use Case Scenario Tool (HD TRUCS)"." April.

Turner, MC, Jerrett, M, Pope, A, III, Krewski, D, Gapstur, SM, Diver, WR, Beckerman, BS, Marshall, JD, Su, J, Crouse, DL and Burnett, RT (2016). 2016. "Long-term ozone exposure and mortality in a large prospective study." *American Journal of Respiratory and Critical Care Medicine* 193 (10): 1134-1142.

U.S. EIA. 2023. Annual Energy Outlook 2023. Accessed 2023. [https://www.eia.gov/outlooks/aeo/tables\\_ref.php](https://www.eia.gov/outlooks/aeo/tables_ref.php).

U.S. EPA. 2019. "PM ISA."

—. 2022. 2019 AirToxScreen: Assessment Results. <https://www.epa.gov/AirToxScreen/2019-airtoxscreen-assessment-results>.

—. 2023. 8-Hour Ozone (2008) Nonattainment Area Summary. November 30. Accessed December 2023. <https://www3.epa.gov/airquality/greenbook/hnsum.html>.

—. 2023. 8-Hour Ozone (2015) Nonattainment Area Summary. November 30. Accessed December 2023. <https://www3.epa.gov/airquality/greenbook/jnsum.html>.

U.S. EPA. 2007. "Control of Hazardous Air Pollutants from Mobile Sources Regulatory Impact Analysis." EPA 420-R-07-002. <https://nepis.epa.gov/Exe/ZyPdf.cgi?Dockey=P1004LNN.PDF>.

—. 2023. "EPA Responses to MOVES3.R1 Peer Review Comments to Updates on the Modeling of Electric Vehicles and Updates to Refueling and NH3 Criteria Emissions." EPA Science Inventory. Accessed March 5, 2024. [https://cfpub.epa.gov/si/si\\_public\\_file\\_download.cfm?p\\_download\\_id=546440&Lab=OTAQ](https://cfpub.epa.gov/si/si_public_file_download.cfm?p_download_id=546440&Lab=OTAQ).

U.S. EPA. 2023. "Estimating PM<sub>2.5</sub>- and Ozone-Attributable Health Benefits. Technical Support Document (TSD) for the 2023 PM NAAQS Reconsideration Proposal." EPA-HQ-OAR-2019-0587,.

—. 2023. Green Book Data Download. November 30. Accessed December 2023. <https://www.epa.gov/green-book/green-book-data-download>.

U.S. EPA. 2024b. "Memo to the Docket: Air Quality Modeling Analysis for the Light- and Medium- Duty 2027 Multipollutant Final Rule." EPA-HQ-OAR-2022-0829.

U.S. EPA. 2019. "Meteorological Model Performance for Annual 2016 Simulation WRF v3.8."

—. 2024. National Ambient Air Quality Standards (NAAQS) for PM. Accessed February 2024. <https://www.epa.gov/pm-pollution/national-ambient-air-quality-standards-naaqs-pm>.

U.S. EPA. 2023. Overview of EPA's MOtor Vehicle Emission Simulator (MOVES4). Ann Arbor: Office of Transportation and Air Quality. US Environmental Protection Agency.

—. 2020. Ozone National Ambient Air Quality Standards (NAAQS). December 23. Accessed January 20, 2023. <https://www.epa.gov/ground-level-ozone-pollution/ozone-national-ambient-air-quality-standards-naaqs>.

—. 2023. PM-2.5 (1997) Nonattainment Area Summary. November 30. Accessed December 2023. <https://www3.epa.gov/airquality/greenbook/qnsum.html>.

—. 2023. PM-2.5 (2006) Nonattainment Area Summary. November 30. Accessed December 2023. <https://www3.epa.gov/airquality/greenbook/rnsum.html>.

—. 2023. PM-2.5 (2012) Nonattainment Area Summary. November 30. Accessed December 2023. <https://www3.epa.gov/airquality/greenbook/knsum.html>.

—. 2023. Power Sector Modeling. Accessed 2023. <https://www.epa.gov/power-sector-modeling/post-ira-2022-reference-case>.

U.S. EPA. 2023. "Regulatory Impact Analysis of the Standards of Performance for New, Reconstructed, and Modified Sources and Emissions Guidelines for Existing Sources: Oil and Natural Gas Sector Climate Review." Office of Air Quality Planning and Standards, Health and Environmental Impacts Division, Research Triangle Park, NC. Accessed January 11, 2024. [https://www.epa.gov/system/files/documents/2023-12/eo12866\\_oil-and-gas-nsp-eg-climate-review-2060-av16-ria-20231130.pdf](https://www.epa.gov/system/files/documents/2023-12/eo12866_oil-and-gas-nsp-eg-climate-review-2060-av16-ria-20231130.pdf).

—. 2022. Report on the Environment, technical documentation for acid deposition. <https://cfpub.epa.gov/roe/indicator.cfm?i=1>.

—. 2023. Sulfur Dioxide (2010) Nonattainment Area Summary. November 30. Accessed December 2023. <https://www3.epa.gov/airquality/greenbook/tsum.html>.

U.S. EPA. 2023. "Technical Support Document (TSD): Preparation of Emissions Inventories for the 2016v3 North American Emissions Modeling Platform, EPA-454/B-23-002." [https://www.epa.gov/system/files/documents/2023-03/2016v3\\_EmisMod\\_TSD\\_January2023\\_1.pdf](https://www.epa.gov/system/files/documents/2023-03/2016v3_EmisMod_TSD_January2023_1.pdf).

U.S. EPA. 2022. "Technical Support Document EPA Air Toxics Screening Assessment. 2017 AirToxScreen TSD." [https://www.epa.gov/system/files/documents/2022-03/airtoxscreen\\_2017tsd.pdf](https://www.epa.gov/system/files/documents/2022-03/airtoxscreen_2017tsd.pdf).

U.S. EPA. 2023. "Technical Support Document: Preparation of Emissions Inventories for the 2016v3 North American Emissions Modeling Platform EPA-454/B-23-002." <https://www.epa.gov/air-emissions-modeling/2016v3-platform>.

U.S. EPA. 2019. "Technical Support Document: Preparation of Emissions Inventories for the Version 7.1 2016 hemispheric Emissions Modeling Platform." <https://www.epa.gov/air-emissions-modeling/2016-version-71-technical-support-document>.

—. 2015. "U.S. Environmental Protection Agency Peer Review Handbook." EPA-100-B15-001. [https://www.epa.gov/sites/default/files/2020-08/documents/epa\\_peer\\_review\\_handbook\\_4th\\_edition.pdf](https://www.epa.gov/sites/default/files/2020-08/documents/epa_peer_review_handbook_4th_edition.pdf).

UNC Institute for the Environment. 2023. CMAS: CMAQ. <https://www.cmascenter.org/cmaq/>.

US EPA. 2023. CMAQ: The Community Multiscale Air Quality Modeling System. <https://www.epa.gov/cmaq>.

US EPA. 2018. "Modeling Guidance for Demonstrating Air Quality Goals for Ozone, PM<sub>2.5</sub> and Regional Haze." [https://www.epa.gov/sites/default/files/2020-10/documents/o3-pm-rh-modeling\\_guidance-2018.pdf](https://www.epa.gov/sites/default/files/2020-10/documents/o3-pm-rh-modeling_guidance-2018.pdf).

- . 2023. Primary National Ambient Air Quality Standard (NAAQS) for Sulfur Dioxide. <https://www.epa.gov/SO2-pollution/primary-national-ambient-air-quality-standard-naaqs-sulfur-dioxide>.
- . 2023. Regional Haze Program. <https://www.epa.gov/visibility/regional-haze-program>.
- . 2020. Regional Haze Storymap. <https://epa.maps.arcgis.com/apps/Cascade/index.html?appid=e4dbe2263e1f49fb849af1c73a04e2f2>.
- . 2018. Report on the Environment: Regional Haze. <https://cfpub.epa.gov/roe/indicator.cfm?i=21>.
- Versar, Inc. 2019. "The Sixth External Peer Review of the Community Multiscale Air Quality (CMAQ) Modeling System." [https://www.epa.gov/sites/production/files/2019-08/documents/sixth\\_cmaq\\_peer\\_review\\_comment\\_report\\_6.19.19.pdf](https://www.epa.gov/sites/production/files/2019-08/documents/sixth_cmaq_peer_review_comment_report_6.19.19.pdf).
- Woodruff, T.J., J. Grillo, and K.C. Schoendorf. 2008. "Air pollution and postneonatal infant mortality in the United States, 1999–2002." *Environmental Health Perspectives* 116 (1): 110-115.
- Woods & Poole. 2015. "Complete Demographic Database." <https://www.woodsandpoole.com/>.
- Wu et al., X, Braun, D, Schwartz, J, Kioumourtzoglou, M and Dominici, F. 2020. "Evaluating the impact of long-term exposure to fine particulate matter on mortality among the elderly." *Science Advances* 6 (29): eaba5692.
- Zanobetti, A and Schwartz, J. 2008. "Mortality displacement in the association of ozone with mortality: an analysis of 48 cities in the United States ." *Am J Respir Crit Care Med* 177 (2): 184-189.

## **Chapter 8: OMEGA Physical Effects of the Final Standards and Alternatives**

This chapter describes the methods and approaches used within the OMEGA model to estimate physical effects of the final standards and alternatives. Physical effects refer to emission inventories, fuel consumption, oil imports, vehicle miles traveled including effects associated with the rebound effect, and safety effects. The cost and benefits of the final standards are tied directly to these physical effects and are discussed in Chapter 9 of this RIA.

We have made several changes to the calculation of physical effects since the NPRM. Those are:

- 1) We have updated to Annual Energy Outlook ("AEO") AEO 2023 from AEO 2021. This impacts fleet mix and liquid fuel prices, the latter of which impacts fuel costs per mile estimates and rebound VMT for any liquid fueled vehicles including PHEVs.
- 2) We no longer use AEO for electricity prices; instead we use EPA estimates based on IPM modeling as discussed in Chapter 5 of this RIA. This impacts fuel costs per mile estimates and rebound VMT for PHEVs and BEVs where applicable.
- 3) We have updated our safety effects to be consistent with the August 2023 CAFE proposed rule.
- 4) We have corrected the electricity consumption estimates to include charging losses between the charge point and the vehicle battery. These losses were inadvertently excluded from the NPRM analysis.
- 5) We have updated our EGU inventory estimates via use of updated EGU inventory modeling as discussed in Chapter 5 of this RIA.
- 6) We have updated our refinery inventory estimates via use of updated refinery emission modeling as discussed in Chapter 7 of this RIA along with employing an updated and more comprehensive methodology to estimating refinery emissions.
- 7) We have updated our estimate of the share of domestic liquid fuel demand reduction leading to reduced domestic refining.
- 8) We have updated our estimate of the share of domestic liquid fuel demand reduction leading to reduced oil imports and its impact on energy security.

### **8.1 The OMEGA "Context"**

OMEGA makes use of projections of fleet size, market shares, fuel prices, vehicle miles travelled (VMT), etc., from the Annual Energy Outlook ("AEO"). Any AEO can be used provided the input files are made available to OMEGA. For this final analysis, EPA has used AEO 2023. (U.S. EIA 2023) AEO 2023 was done assuming that the future fleet would comply with the 2022 CAFE FRM (NHTSA 2022) and would include impacts associated with the Inflation Reduction Act (IRA). However, the way that the IRA was reflected in AEO 2023 was not as impactful as we believe it should have been. Hence, when running OMEGA, the first scenario run, the context run, reflects EPA's 2021 LD GHG FRM which was similar in stringency to the 2022 CAFE FRM, and does not reflect IRA tax credits. This context OMEGA

run, or session, is then used as a reference session from which future fleet VMT and rebound VMT can be calculated, as described below.

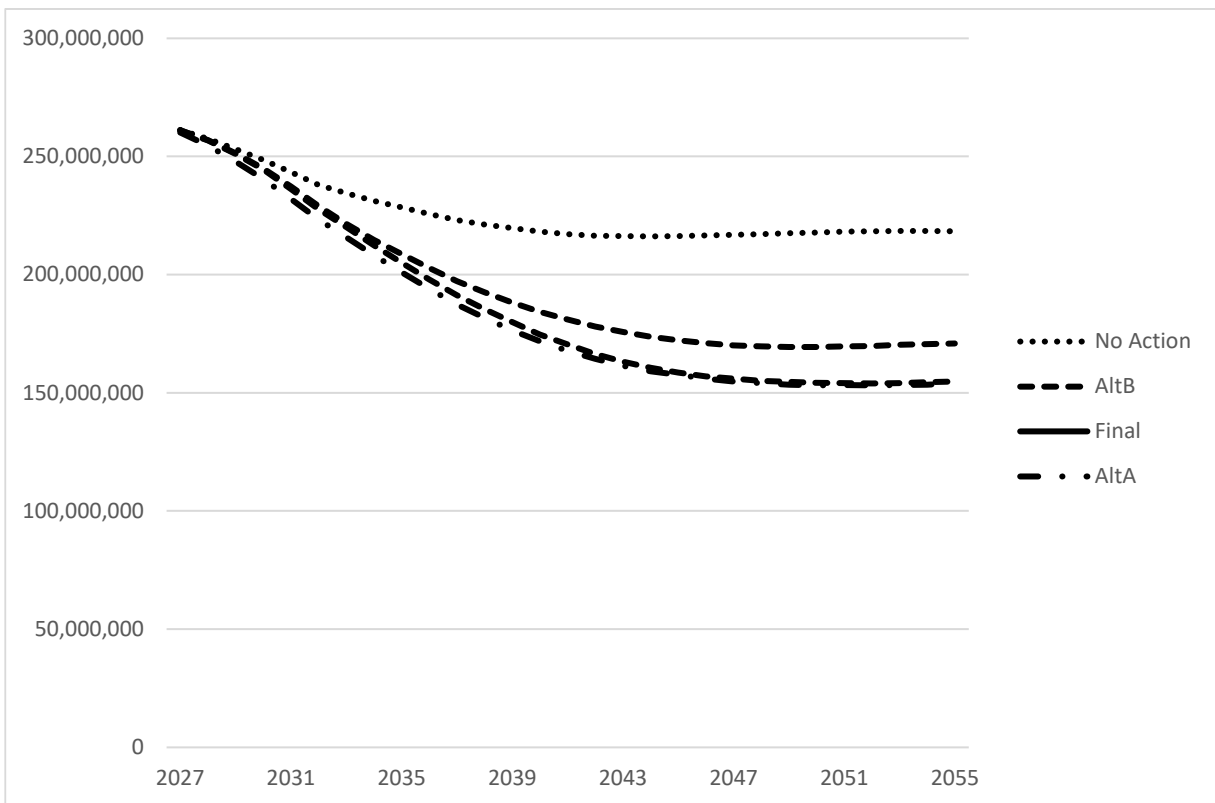
## **8.2 The Analysis Fleet and the Legacy Fleet**

OMEGA uses as a "base year fleet," a comprehensive list of vehicles sold in a recent model year. This base year fleet includes all models of vehicles, their sales, and a long list of attributes such as their curb weights, their footprints, and the primary GHG technologies on those vehicles. For this analysis, EPA is using the MY 2022 light-duty fleet as the base year fleet, updated from the MY 2019 fleet used in the NPRM, and the same MY 2020 medium-duty base year fleet that we used in the NPRM. When OMEGA runs, it begins with the 2023 calendar year as the first year of the analysis and uses the fleet of vehicles contained in the base year fleet as the starting point for the analysis. These MY 2023 and later vehicles are referred to as the "analysis fleet."

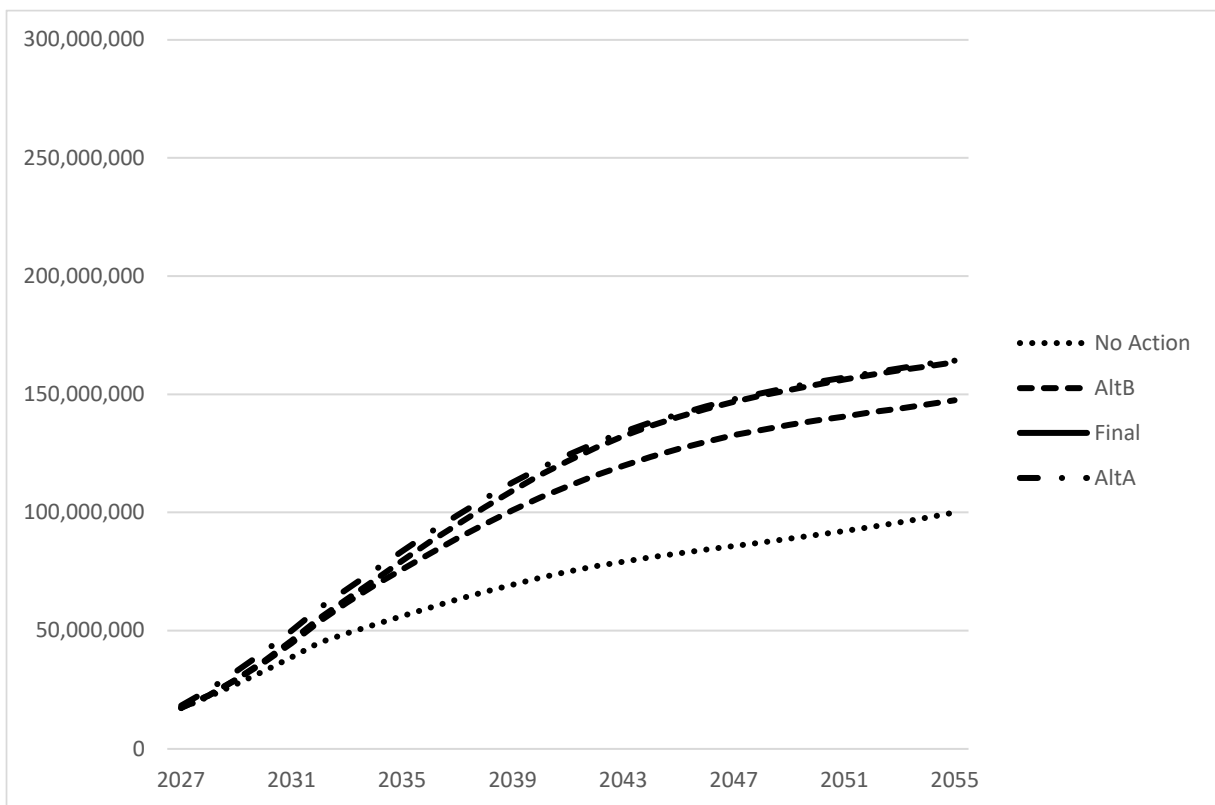
Vehicles that exist in the fleet prior to the first year of the analysis (i.e., MY 2023) are referred to as the "legacy fleet." These vehicles include vehicles of all ages that exist in the fleet as of calendar year 2022. Those vehicles are "aged out" of the fleet over the course of running the analysis. The legacy fleet vehicles are not changed in any way within OMEGA other than being scrapped (aging out) and driving fewer miles per year as they age.

Figure 8-1 shows ICE vehicle stock—liquid-fueled vehicles including HEVs—and Figure 8-2 shows BEV and PHEV stock. The ICE vehicle stock can be seen to be aging out of the fleet as the BEV and PHEV stock grows. Figure 8-3 shows the total vehicle stock with growth representing economic and population growth going forward. Figure 8-3 also highlights that OMEGA scales fleet stock for consistency with AEO projections given that each alternative, despite differences in ICE, HEV, PHEV, and BEV numbers have the same total stock.

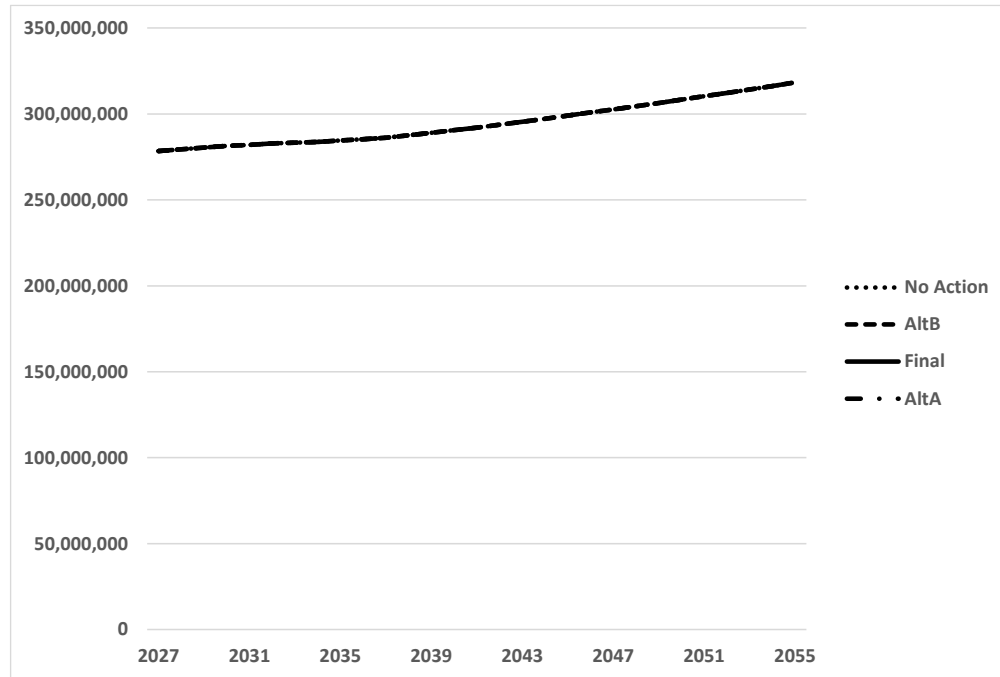




**Figure 8-1: ICE vehicle stock in OMEGA effects calculations.**

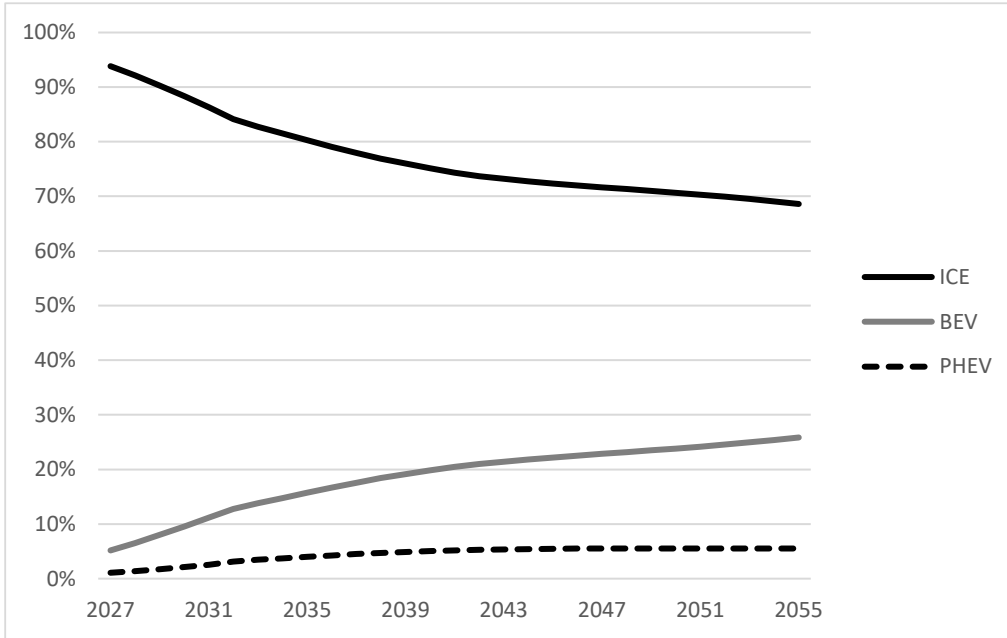


**Figure 8-2: BEV & PHEV stock in OMEGA effects calculations.**

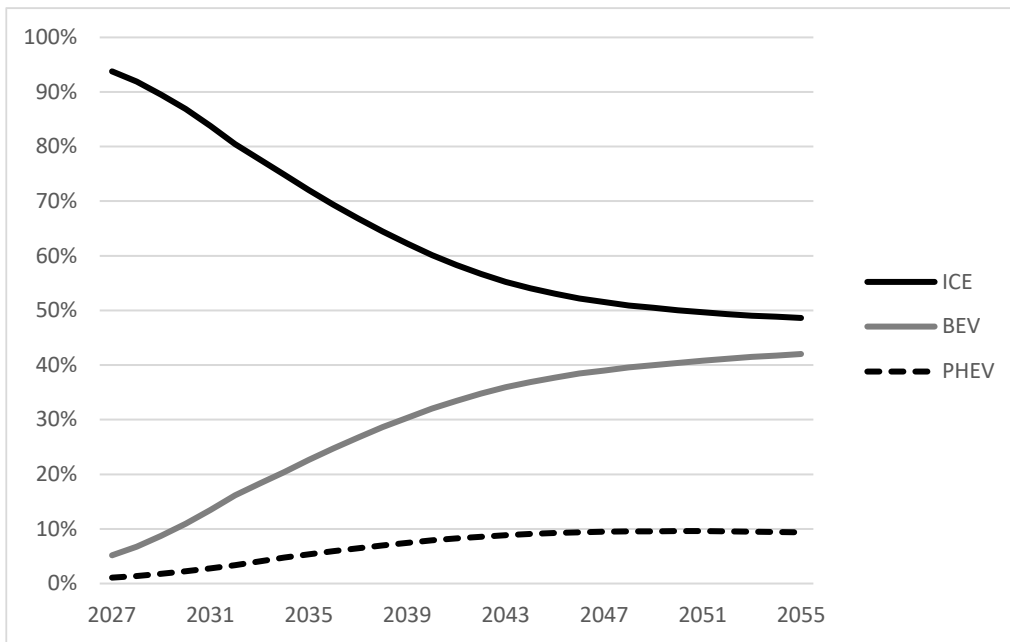


**Figure 8-3: Light- and medium-duty stock in OMEGA effects calculations.**

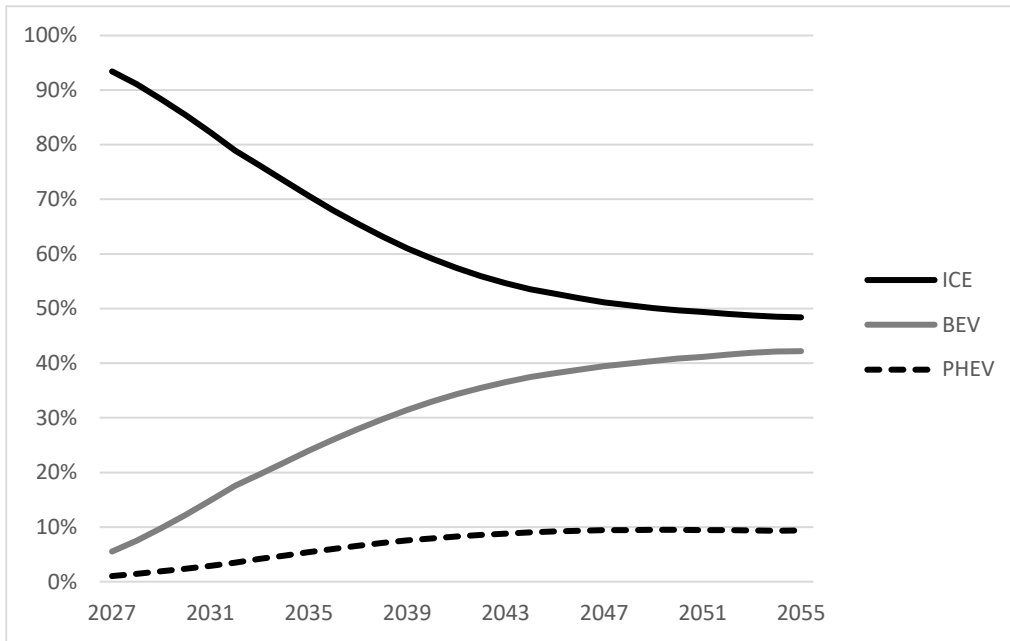
Figure 8-4 through Figure 8-7 show the share of ICE (including HEV), PHEV, and BEV vehicles in the total light- and medium-duty stock for the calendar years 2027 through 2055 in the No Action, Final, Alternative A, and Alternative B scenarios, respectively.



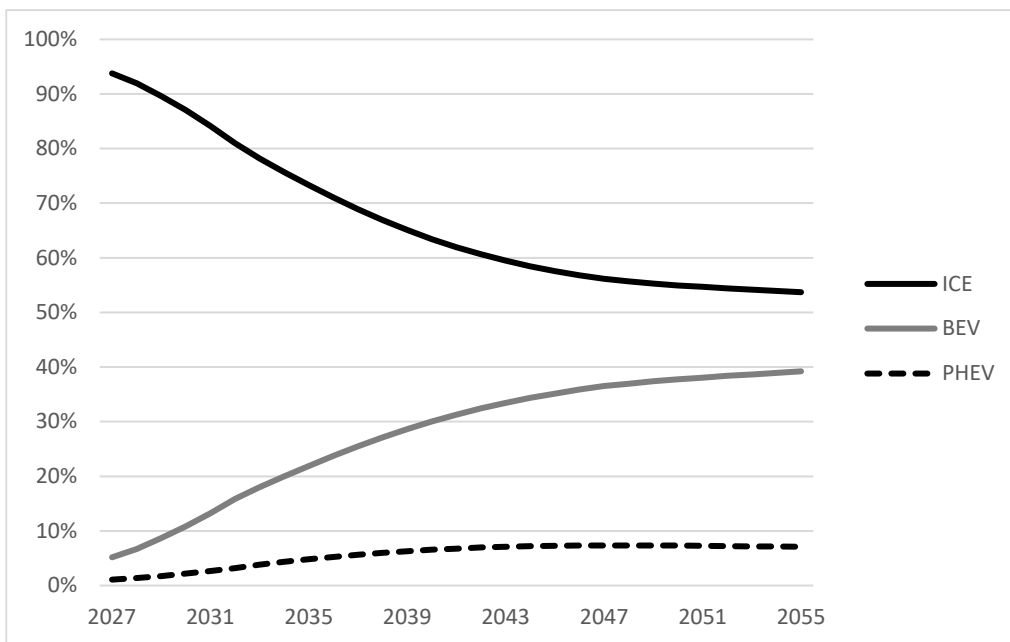
**Figure 8-4: Share of ICE (including HEV), PHEV and BEV in the total light- and medium-duty stock in the No Action scenario.**



**Figure 8-5: Share of ICE (including HEV), PHEV and BEV in the total light- and medium-duty stock under the Final standards.**



**Figure 8-6: Share of ICE (including HEV), PHEV and BEV in the total light- and medium-duty stock under Alternative A.**



**Figure 8-7: Share of ICE (including HEV), PHEV and BEV in the total light- and medium-duty stock under Alternative B.**

### 8.3 Estimating Vehicle, Fleet, and Rebound VMT

OMEGA uses a static set of mileage accumulation rates based on body style. OMEGA uses three self-explanatory body styles: sedan\_wagon; cuv\_suv\_van; and pickup. All vehicles in both

the analysis and legacy fleets are characterized as being of one of these body styles. The rates at which each body style is aged-out of the fleet, or re-registered, and the miles driven by age are shown in Table 8-1 for light-duty and medium-duty. The same values are used in both the analysis and the legacy fleets based on vehicle age.

**Table 8-1: Mileage accumulation and re-registration rates used for light-duty.**

| Age | Mileage Accumulation |       |             | Re-Registration Rate |        |       |             |        |
|-----|----------------------|-------|-------------|----------------------|--------|-------|-------------|--------|
|     | Sedan                | Wagon | CUV SUV Van | Pickup               | Sedan  | Wagon | CUV SUV Van | Pickup |
| 0   | 15,922               |       | 16,234      | 18,964               | 100.0% |       | 100.0%      | 100.0% |
| 1   | 15,379               |       | 15,805      | 17,986               | 98.8%  |       | 98.8%       | 97.8%  |
| 2   | 14,864               |       | 15,383      | 17,076               | 97.7%  |       | 97.7%       | 96.3%  |
| 3   | 14,378               |       | 14,966      | 16,231               | 96.1%  |       | 96.1%       | 94.3%  |
| 4   | 13,917               |       | 14,557      | 15,449               | 94.5%  |       | 94.5%       | 93.1%  |
| 5   | 13,481               |       | 14,153      | 14,726               | 93.0%  |       | 93.0%       | 91.5%  |
| 6   | 13,068               |       | 13,756      | 14,060               | 91.1%  |       | 91.1%       | 89.3%  |
| 7   | 12,677               |       | 13,366      | 13,448               | 89.1%  |       | 89.1%       | 87.0%  |
| 8   | 12,305               |       | 12,982      | 12,886               | 86.9%  |       | 86.9%       | 84.1%  |
| 9   | 11,952               |       | 12,605      | 12,372               | 84.0%  |       | 84.0%       | 79.6%  |
| 10  | 11,615               |       | 12,234      | 11,903               | 80.0%  |       | 80.0%       | 74.2%  |
| 11  | 11,294               |       | 11,870      | 11,476               | 75.6%  |       | 75.6%       | 69.2%  |
| 12  | 10,986               |       | 11,512      | 11,088               | 70.6%  |       | 70.6%       | 64.1%  |
| 13  | 10,690               |       | 11,161      | 10,737               | 65.3%  |       | 65.3%       | 58.3%  |
| 14  | 10,405               |       | 10,816      | 10,418               | 59.5%  |       | 59.5%       | 53.5%  |
| 15  | 10,129               |       | 10,477      | 10,131               | 53.1%  |       | 53.1%       | 48.6%  |
| 16  | 9,860                |       | 10,146      | 9,871                | 45.8%  |       | 45.8%       | 44.2%  |
| 17  | 9,597                |       | 9,820       | 9,635                | 38.3%  |       | 38.3%       | 39.8%  |
| 18  | 9,338                |       | 9,501       | 9,421                | 30.8%  |       | 30.8%       | 35.2%  |
| 19  | 9,081                |       | 9,189       | 9,226                | 24.1%  |       | 24.1%       | 30.9%  |
| 20  | 8,826                |       | 8,883       | 9,047                | 18.3%  |       | 18.3%       | 26.7%  |
| 21  | 8,570                |       | 8,583       | 8,882                | 13.9%  |       | 13.9%       | 22.8%  |
| 22  | 8,313                |       | 8,290       | 8,726                | 10.7%  |       | 10.7%       | 20.2%  |
| 23  | 8,051                |       | 8,004       | 8,577                | 8.2%   |       | 8.2%        | 17.5%  |
| 24  | 7,785                |       | 7,724       | 8,433                | 6.3%   |       | 6.3%        | 15.8%  |
| 25  | 7,511                |       | 7,450       | 8,290                | 5.1%   |       | 5.1%        | 14.5%  |
| 26  | 7,229                |       | 7,183       | 8,146                | 4.2%   |       | 4.2%        | 13.9%  |
| 27  | 6,938                |       | 6,923       | 7,998                | 3.4%   |       | 3.4%        | 12.5%  |
| 28  | 6,635                |       | 6,669       | 7,842                | 2.8%   |       | 2.8%        | 11.1%  |
| 29  | 6,319                |       | 6,421       | 7,676                | 2.4%   |       | 2.4%        | 10.3%  |
| 30  | 5,988                |       | 6,180       | 7,497                | 0.0%   |       | 0.0%        | 9.3%   |
| 31  | 5,641                |       | 5,946       | 7,302                | 0.0%   |       | 0.0%        | 8.3%   |
| 32  | 5,277                |       | 5,718       | 7,089                | 0.0%   |       | 0.0%        | 7.3%   |
| 33  | 4,893                |       | 5,496       | 6,853                | 0.0%   |       | 0.0%        | 6.2%   |
| 34  | 4,488                |       | 5,281       | 6,593                | 0.0%   |       | 0.0%        | 5.0%   |
| 35  | 4,061                |       | 5,072       | 6,305                | 0.0%   |       | 0.0%        | 3.8%   |
| 36  | 3,610                |       | 4,870       | 5,987                | 0.0%   |       | 0.0%        | 2.7%   |
| 37  | 3,133                |       | 4,674       | 5,635                | 0.0%   |       | 0.0%        | 0.0%   |

### **8.3.1 OMEGA "Context" VMT**

When running OMEGA, the mileage accumulation rates and re-registration rates shown in Table 8-1 are used for all vehicles in both the analysis and legacy fleets at the indicated ages. To ensure that the "context" VMT (i.e., the total VMT of the analysis and legacy fleets) travels the number of miles projected by EIA's Annual Energy Outlook, OMEGA adjusts the VMT of every vehicle such that the total fleet VMT in any calendar year will equal that projected in AEO. This is done by determining the ratio of the AEO projection for a given calendar year to that given calendar year's total VMT within OMEGA estimated using the static mileage accumulation rates shown in Table 8-1. That ratio is then applied to every vehicle's "static" VMT to arrive at a "context" VMT. This way, the fleet context VMT within OMEGA will be equivalent to the fleet VMT projected by AEO. Importantly, this context VMT does not yet include any rebound VMT, which is discussed below.

$$VehicleVMT_{context} = VehicleVMT_{static} \times \frac{FleetVMT_{AEO}}{FleetVMT_{OMEGA}}$$

Where,

$VehicleVMT_{context}$  = miles driven in OMEGA scenario 0 (the NTR without IRA impacts (light-duty) and the heavy-duty phase 2 GHG FRM plus impacts of the Advanced Clean Trucks program (medium-duty))

$VehicleVMT_{static}$  = miles driven using values shown in Table 8-1

$FleetVMT_{static}$  = the projected annual VMT in the AEO report being used

$FleetVMT_{OMEGA}$  = the calculated annual VMT within OMEGA using  $VehicleVMT_{static}$  values

### **8.3.2 Context Fuel Costs Per Mile**

The VMT rebound effect is discussed in detail in Chapter 4.2. Estimates of "rebound" miles driven depends, traditionally, on changing fuel prices and their effect on the number of miles people drive--as fuel prices rise and the cost per mile of driving increases, people drive less. In OMEGA, we estimate the rebound effect not based on changing fuel prices, but rather on the changing cost per mile of driving for vehicles of different fuel consumption. In other words, someone that has purchased a new vehicle that consumes less fuel per mile might drive that vehicle more than if they would have continued to drive their prior vehicle that consumed more fuel per mile. As such, OMEGA's estimate of rebound VMT does not include any rebound VMT in the legacy fleet since the fuel consumption characteristics of the legacy fleet are not changing.

For the analysis fleet, OMEGA first determines the fuel cost per mile for each base year fleet vehicle in every calendar year included in the analysis. This way, the base year fleet vehicle's fuel consumption characteristics are not changing through the years but its fuel costs per mile are due to changing fuel prices. These fuel costs per mile are then sales weighted by context size

class<sup>248</sup> and by non-BEV vs. BEV powertrains. These sales-weighted fuel costs per mile for every non-BEV or BEV context size class vehicle are then used as the context fleet, or context vehicle, fuel costs per mile.

In subsequent OMEGA scenarios, which include unique GHG standards that can result in unique fuel consumption characteristics for all vehicles, the fuel costs per mile for those individual vehicles are determined and compared to their non-BEV or BEV context size class fuel cost per mile in each year of its life. This way, the fuel cost per mile of each vehicle in OMEGA can be compared to the context fuel cost per mile of similarly categorized vehicles to determine how its miles would be estimated to change due to the policy.

### **8.3.3 Rebound VMT**

As discussed in Chapter 4.2, rebound VMT depends on the elasticity of demand for more driving. The input values used in the analysis were -0.1 for ICE vehicles and PHEVs and zero for BEVs. We have used a value of zero for BEV vehicles as explained in Chapter 4 of this RIA. The cost per mile of operation and the subsequent rebound effect miles can then be calculated as:

$$CPM = \left[ \frac{\left( \frac{kWh}{mile} \right)_{onroad}}{charge\ efficiency} \times \frac{\$}{kWh} \right] + \left[ \frac{\left( \frac{CO_2}{mile} \right)_{onroad}}{\frac{CO_2}{gallon}} \times \frac{\$}{gallon} \right]$$

Where,

$CPM$  = cost per mile

$charge\ efficiency = 0.9$  to capture losses between the charge point and the vehicle battery

$CO_2\ per\ gallon$  is for the applicable liquid fuel (8887 for gasoline, 10180 for diesel)

$\$ values$  are retail values for electricity and the applicable liquid fuel

Note that the kWh per mile and CO<sub>2</sub> per mile values in the cost per mile equation are weighted values that account for the share of operation on electricity versus liquid fuel. For BEVs the liquid fuel portion of the equation would be zero while the electricity portion would be zero for pure ICE vehicles and HEVs. PHEVs would make use of both the electricity and liquid fuel portions of the equation.

$$VehicleVMT_{rebound} = VehicleVMT_{context} \times Elasticity \times \frac{(CPM_{policy} - CPM_{context})}{CPM_{context}}$$

Where,

$VehicleVMT_{rebound}$  = the rebound miles driven

$VehicleVMT_{context}$  = the context VMT discussed above

---

<sup>248</sup> OMEGA has 14 context size classes: Minicompact, Subcompact, Compact, Midsize, Large, Two Seater, Small Crossover, Large Crossover, Small Pickup, Large Pickup, Small Van, Large Van, Small Utility, Large Utility.

*Elasticity* = elasticity of demand

$CPM_{policy}$  = the cost per mile in the policy scenario

$CPM_{context}$  = the cost per mile in the context scenario for similarly categorized vehicles based on context size class and non-BEV vs. BEV.

And to calculate vehicle miles traveled in the policy scenario:

$$VehicleVMT_{policy} = VehicleVMT_{context} + VehicleVMT_{rebound}$$

Where,

$VehicleVMT_{policy}$  = the policy VMT

$VehicleVMT_{context}$  = the context VMT discussed above

$VehicleVMT_{rebound}$  = the rebound miles driven

#### **8.3.4 Summary of VMT in the Analysis**

The analysis fleet VMT will vary depending on the rebound elasticities used and the level of GHG standards, the latter of which impact the fuel consumption characteristics of the future fleet. The OMEGA No Action VMT and the projected fleet VMT under the final standards and alternative standards are shown in Table 8-2. Table 8-3 shows the rebound VMT.



**Table 8-2: VMT summary, light-duty and medium-duty (billion miles).**

| Calendar Year | OMEGA No Action | OMEGA Final | OMEGA Alternative A | OMEGA Alternative B |
|---------------|-----------------|-------------|---------------------|---------------------|
| 2027          | 3,151           | 3,151       | 3,151               | 3,151               |
| 2028          | 3,177           | 3,177       | 3,178               | 3,177               |
| 2029          | 3,197           | 3,198       | 3,199               | 3,198               |
| 2030          | 3,215           | 3,216       | 3,218               | 3,217               |
| 2031          | 3,229           | 3,231       | 3,233               | 3,231               |
| 2032          | 3,243           | 3,244       | 3,247               | 3,244               |
| 2033          | 3,260           | 3,264       | 3,267               | 3,263               |
| 2034          | 3,281           | 3,288       | 3,290               | 3,286               |
| 2035          | 3,303           | 3,311       | 3,314               | 3,310               |
| 2036          | 3,320           | 3,331       | 3,334               | 3,329               |
| 2037          | 3,340           | 3,353       | 3,355               | 3,351               |
| 2038          | 3,362           | 3,377       | 3,379               | 3,375               |
| 2039          | 3,384           | 3,402       | 3,404               | 3,399               |
| 2040          | 3,410           | 3,429       | 3,431               | 3,426               |
| 2041          | 3,435           | 3,457       | 3,459               | 3,454               |
| 2042          | 3,461           | 3,484       | 3,486               | 3,481               |
| 2043          | 3,487           | 3,512       | 3,513               | 3,509               |
| 2044          | 3,515           | 3,542       | 3,543               | 3,539               |
| 2045          | 3,543           | 3,571       | 3,573               | 3,568               |
| 2046          | 3,577           | 3,607       | 3,608               | 3,603               |
| 2047          | 3,612           | 3,643       | 3,643               | 3,639               |
| 2048          | 3,648           | 3,681       | 3,681               | 3,677               |
| 2049          | 3,684           | 3,718       | 3,718               | 3,714               |
| 2050          | 3,725           | 3,759       | 3,759               | 3,755               |
| 2051          | 3,765           | 3,800       | 3,800               | 3,797               |
| 2052          | 3,806           | 3,842       | 3,842               | 3,838               |
| 2053          | 3,848           | 3,884       | 3,884               | 3,880               |
| 2054          | 3,890           | 3,926       | 3,926               | 3,923               |
| 2055          | 3,932           | 3,969       | 3,969               | 3,965               |

**Table 8-3: Rebound VMT relative to no action, light-duty and medium-duty (billion miles).**

| Calendar Year | OMEGA Final | OMEGA Alternative A | OMEGA Alternative B |
|---------------|-------------|---------------------|---------------------|
| 2027          | 0.0136      | 0.0288              | 0.0175              |
| 2028          | 0.374       | 0.933               | 0.357               |
| 2029          | 0.711       | 1.8                 | 0.679               |
| 2030          | 1.04        | 2.69                | 1.15                |
| 2031          | 1.35        | 3.47                | 1.48                |
| 2032          | 1.56        | 4                   | 1.62                |
| 2033          | 4.02        | 6.4                 | 3.13                |
| 2034          | 6.56        | 8.72                | 5.05                |
| 2035          | 8.79        | 10.9                | 7.09                |
| 2036          | 11.1        | 13.2                | 9.12                |
| 2037          | 13.3        | 15.4                | 11.1                |
| 2038          | 15.5        | 17.5                | 13.1                |
| 2039          | 17.6        | 19.5                | 15                  |
| 2040          | 19.6        | 21.3                | 16.9                |
| 2041          | 21.5        | 23.1                | 18.7                |
| 2042          | 23.3        | 24.8                | 20.4                |
| 2043          | 24.9        | 26.3                | 22                  |
| 2044          | 26.6        | 27.8                | 23.5                |
| 2045          | 28.1        | 29.2                | 24.9                |
| 2046          | 29.8        | 30.8                | 26.5                |
| 2047          | 31.2        | 31.9                | 27.7                |
| 2048          | 32.4        | 33                  | 28.9                |
| 2049          | 33.5        | 33.9                | 29.9                |
| 2050          | 34.5        | 34.6                | 30.8                |
| 2051          | 35.1        | 35.2                | 31.5                |
| 2052          | 35.5        | 35.6                | 32                  |
| 2053          | 36          | 35.9                | 32.5                |
| 2054          | 36.4        | 36.2                | 32.9                |
| 2055          | 36.6        | 36.7                | 33.1                |

Values show 3 significant digits.

#### 8.4 Estimating Safety Effects

OMEGA estimates safety effects consistent with methods used in past light-duty GHG analyses and consistent with the methods developed by NHTSA for use in the CAFE Compliance and Effects Modeling System (CCEMS). In fact, the inputs used in OMEGA are identical to inputs used by NHTSA in CCEMS in support of their August 2023 CAFE NPRM (NHTSA 2023). NHTSA is the government entity tasked with regulating vehicle safety and, as such, NHTSA has the foremost experts in the field. EPA has worked closely with NHTSA through the years of joint GHG/CAFE regulatory development and has weighed in extensively on the statistical analyses used in estimating vehicle safety effects. That said, EPA has always used modeling parameters in OMEGA that are identical to those used by NHTSA in the CCEMS.

As noted, OMEGA uses vehicle travel fatality rates and safety values associated with mass reduction that have been generated by NHTSA. These fatality rates and safety values and how they are generated are described at length in the regulatory documents supporting NHTSA’s 2023 CAFE NPRM. (NHTSA 2023) The discussion here does not attempt to provide that same level of detail and is meant only to summarize the NHTSA analysis to help in understanding the input values used in OMEGA.

The safety analysis is meant to capture effects associated with three factors:

- Changes in vehicle mass or weight;

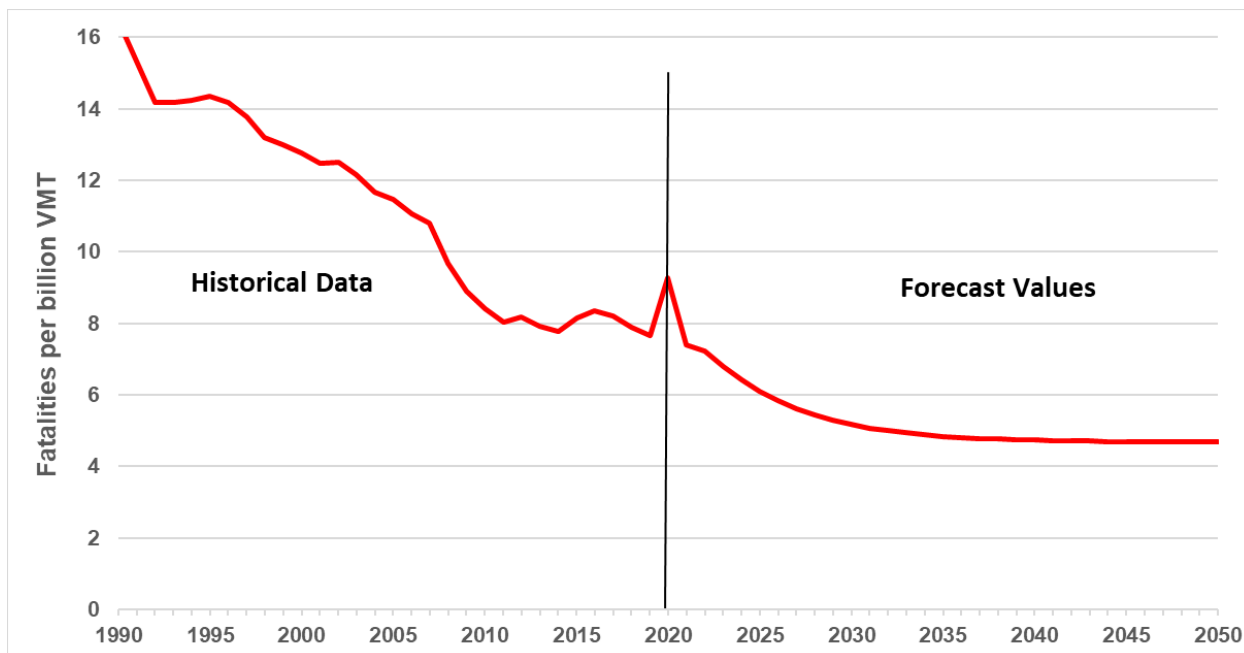
- Changes associated with fleet composition including car, CUV, SUV, pickup shares, and fleet turnover; and,
- The potential for additional safety impacts associated with additional driving (i.e., the “rebound effect” as mentioned in Chapter 8.3) that might arise from lower fuel costs resulting from more stringent GHG standards.

In the following, we first cover the base fatality rates of vehicles in the legacy fleet. We then cover the changes to those fatality rates associated with changes in vehicle mass and changes in the analysis fleet composition. We then summarize the calculation approach to estimating fatalities within OMEGA and present results.

#### **8.4.1 Fatality Rates used in OMEGA**

To estimate the impact of the standards on safety, NHTSA uses statistical models that explicitly incorporate variation in the safety performance of individual vehicle model years. They use a model for fatalities that tracks vehicles from when they are produced and sold, enter the fleet, gradually age, and are ultimately retired from service. NHTSA also considers how newer technologies are likely to affect the safety of both individual vehicles and the combined fleet. The overall safety of the light-duty vehicle fleet during any future calendar year is determined by the safety performance of the individual model year cohorts comprising it at the ages they will have reached during that year, the representation of each model year cohort in that (calendar) year’s fleet, and a host of external factors that fluctuate over time, such as driver demographics and behavior, economic conditions, traffic levels, and emergency response and medical care. Combining forecasts of future crash rates for individual model year cohorts at different ages with the composition of the vehicle fleet produces baseline forecasts of fatalities. Regulatory alternatives that establish new standards for future model years can change these forecasts by altering the representation of different model year cohorts making up the future light-duty fleet. (U.S. NHTSA 2022) NHTSA’s work produces estimates of fatality rates for each model year making up the fleet during each future calendar year, and the process is continued until calendar year 2050. Multiplying these rates by the estimated number of miles driven by vehicles of each model year in use during a future calendar year produces baseline estimates of total fatalities.

As an example, Figure 8-8 illustrates the recent history and baseline forecast of the overall fatality rate for occupants of cars and light trucks. According to NHTSA, the sharp rise in the fatality rate for 2020 coincided with the steep drop in car and light truck VMT during that year due to the COVID-19 pandemic and accompanying restrictions on activity, combined with an increased number of fatalities in 2020. These rates are also used as the basis for estimating future fatalities and for estimating changes in safety resulting from reductions in the mass of new vehicles, additional rebound-effect driving, and changes in the numbers of cars and light trucks from different model years making up each calendar year’s fleet. The underlying causes and methods for estimating each of those three sources of changes in safety are discussed in detail in various sub-sections of Chapter 7 of the Technical Support Document (TSD) accompanying NHTSA’s 2023 CAFE NPRM. (NHTSA 2023)



**Figure 8-8 Recent and Projected Future Fatality Rates for Cars and Light Trucks (NHTSA 2023)**

#### **8.4.2 Calculating Safety Effects tied to Vehicle Weight Changes**

To calculate the safety effects associated with changes to vehicle weight, OMEGA makes use of fatality rate changes per billion miles of vehicle travel associated with vehicles of different body styles—as with base fatality rates, these are developed by NHTSA—and weight changes determined within OMEGA as vehicles change to meet future GHG standards. The first of these factors are, as noted, developed by NHTSA through an analytical process that is detailed in their 2023 CAFE NRPM. (NHTSA 2023) OMEGA makes use of the input parameters used by NHTSA in CCEMS model runs supporting their 2023 NPRM. Those values are shown in Table 8-4 and are used for both light-duty and medium-duty vehicles with medium-duty vans using the `cuv_suv` entries. Note that these values differ slightly from those used in the NPRM analysis with the changes resulting from the inclusion of all-wheel drive passenger cars in the regressions.

**Table 8-4: Safety values used in OMEGA (U.S. NHTSA 2022).**

| Body style | NHTSA Safety Class | Threshold (lbs) | Change per 100 lbs below threshold | Change per 100 lbs at or above threshold |
|------------|--------------------|-----------------|------------------------------------|--|
| sedan      | PC                 | 3201            | 0.0112                             | 0.0089                                   |
| pickup     | LT/SUV             | 5014            | 0.0031                             | -0.0061                                  |
| cuv_suv    | CUV/Minivan        | 3872            | -0.0025                            | -0.0025                                  |

For example, the base fatality rate for a pickup would change by -0.0061 for every 100 pounds of weight reduced over 5,014 pounds. However, if that vehicle had a starting weight of 5,064 pounds and its weight was reduced by 100 pounds, then the first 50 of those pounds would reduce the base fatality rate by -0.00305 (-0.0061 per 100 pounds but for only 50 pounds) and the next 50 pounds would increase the base fatality rate by 0.00155 (0.0031 per 100 pounds but for only 50 pounds). In other words, reducing pickup weight above 5,014 pounds reduces

fatalities while reducing pickup weight below 5,104 increases fatalities. In contrast, increasing pickup weight above 5,014 pounds increases fatalities while increasing pickup weight below 5,014 pounds reduces fatalities.

Therefore, OMEGA first determines the weight change of the given vehicle. This is calculated as the curb weight of the vehicle in the policy scenario (i.e., the final weight) relative to the curb weight of the vehicle in the base year fleet.

$$\text{DeltaWeight} = \text{FinalWeight} - \text{BaseYearWeight}$$

Where,

*DeltaWeight* = the change in weight, where a weight reduction will be a negative value

*FinalWeight* = the weight of the vehicle in the policy scenario

*BaseYearWeight* = the weight of the vehicle in the base year fleet

Knowing the delta weight, OMEGA then determines the weight change above and below the threshold for the body style of the given vehicle. Importantly, because OMEGA sometimes increases the curb weight of vehicles (e.g., due to conversion to BEV), whether the weight change is positive (increased weight) or negative (decreased weight) is important given the safety values and their signs as shown in Table 8-4.

To determine the pounds changed below the threshold, and whether they involve increased or decreased weight, OMEGA uses the logic shown below:

If:  $\text{Threshold} < \text{BaseWeight}$  and  $\text{Threshold} < \text{FinalWeight}$ :

Then:  $\text{DeltaPounds}_{\text{below}} = 0$

Else if:  $\text{BaseWeight} < \text{Threshold}$  and  $\text{FinalWeight} < \text{Threshold}$ :

Then:  $\text{DeltaPounds}_{\text{below}} = \text{FinalWeight} - \text{BaseWeight}$

Else if:  $\text{BaseWeight} < \text{Threshold} < \text{FinalWeight}$ :

Then:  $\text{DeltaPounds}_{\text{below}} = \text{Threshold} - \text{BaseWeight}$

Else if:  $\text{FinalWeight} < \text{Threshold} < \text{BaseWeight}$ :

Then:  $\text{DeltaPounds}_{\text{below}} = \text{FinalWeight} - \text{Threshold}$

To determine the pounds changed above the threshold, and whether they involve increased or decreased weight, OMEGA uses the logic shown below:

If:  $\text{BaseWeight} < \text{Threshold}$  and  $\text{FinalWeight} < \text{Threshold}$

Then:  $\text{DeltaPounds}_{\text{above}} = 0$

Else if:  $\text{Threshold} \leq \text{BaseWeight}$  and  $\text{Threshold} \leq \text{FinalWeight}$

Then:  $\text{DeltaPounds}_{\text{above}} = \text{FinalWeight} - \text{BaseWeight}$

Else if:  $\text{BaseWeight} \leq \text{Threshold} \leq \text{FinalWeight}$ :

Then:  $\Delta Pounds_{above} = FinalWeight - Threshold$

Else if:  $FinalWeight \leq Threshold \leq BaseWeight$ :

Then:  $\Delta Pounds_{above} = Threshold - BaseWeight$

The sales weighted curb weights and changes to those curb weights in the No Action and under the Final standards and for select years are shown in Table 8-5.

**Table 8-5: Light- and medium-duty fleet-weighted attributes in the OMEGA safety analysis for the No Action and Final Standards (pounds)\*.**

| Body Style | Calendar Year | No Action Curb Weight | Final Curb Weight | Change in Curb Weight | Change in Curb Weight Below Threshold | Change in Curb Weight Above Threshold |
|------------|---------------|-----------------------|-------------------|-----------------------|---------------------------------------|---------------------------------------|
| sedan      | 2027          | 3,527                 | 3,527             | 0                     | 0                                     | 0                                     |
|            | 2032          | 3,523                 | 3,554             | 31                    | 3                                     | 28                                    |
|            | 2040          | 3,482                 | 3,598             | 113                   | 8                                     | 105                                   |
|            | 2050          | 3,443                 | 3,651             | 204                   | 9                                     | 195                                   |
|            | 2055          | 3,437                 | 3,666             | 226                   | 8                                     | 218                                   |
| pickup     | 2027          | 5,193                 | 5,194             | 1                     | 0                                     | 1                                     |
|            | 2032          | 5,326                 | 5,376             | 50                    | 8                                     | 41                                    |
|            | 2040          | 5,374                 | 5,473             | 100                   | 30                                    | 70                                    |
|            | 2050          | 5,343                 | 5,414             | 76                    | 28                                    | 49                                    |
|            | 2055          | 5,370                 | 5,423             | 57                    | 20                                    | 37                                    |
| cuv_suv    | 2027          | 4,328                 | 4,328             | 0                     | 0                                     | 0                                     |
|            | 2032          | 4,301                 | 4,335             | 34                    | 6                                     | 28                                    |
|            | 2040          | 4,236                 | 4,326             | 88                    | 10                                    | 78                                    |
|            | 2050          | 4,209                 | 4,330             | 118                   | 8                                     | 111                                   |
|            | 2055          | 4,218                 | 4,340             | 120                   | 6                                     | 114                                   |

\* The threshold weights are shown in Table 8-4. Fleet weighting here reflects the entire light- and medium-duty stock of vehicles, not just new sales.

With the weight change above and below the threshold, OMEGA calculates the fatality rate changes as shown below:

$$RateChange_{below} = ChangePer100Pounds_{below} \times (-\Delta Pounds_{below})$$

$$RateChange_{above} = ChangePer100Pounds_{above} \times (-\Delta Pounds_{above})$$

Where,

$RateChange$  = the change in fatality rate below/above the weight threshold for the given body style as shown in Table 8-4; the base fatality rate that is changed by this rate change is discussed in the next section.

$ChangePer100Pounds$  = the applicable value for the given body style as shown in Table 8-4

$\Delta Pounds$  = the applicable value according to the logic described above.

### **8.4.3 Calculating Fatalities**

OMEGA first calculates the fatality rate of a given vehicle in the given policy scenario. This is done using the equation below.

$$FatalityRate_{policy} = FatalityRate_{base} \times (1 + RateChange_{below}) \times (1 + RateChange_{above})$$

Where,

$FatalityRate_{policy}$  = the fatality rate per billion miles traveled in the policy scenario

$FatalityRate_{base}$  = the fatality rate per billion miles traveled in the base case (Chapter 8.4.1)

$RateChange$  = the applicable result for the calculations described above (Chapter 8.4.2)

The number of fatalities in the given policy scenario are then calculated as:

$$Fatalities_{policy} = FatalityRate_{policy} \times VMT_{policy} / 10^9$$

Where,

$Fatalities_{policy}$  = the number of fatalities in the policy scenario

$FatalityRate_{policy}$  = the fatality rate in the policy, as described above

$VMT_{policy}$  = the vehicle miles traveled in the policy, as described in Chapter 8.3

### **8.4.4 Summary of Safety Effects in the Analysis**

Table 8-6 shows the number of fatalities estimated in the No Action case (i.e., the EPA 2021 FRM remains in place) and the Final standards and Alternatives. Table 8-7 shows fatality rate impacts per billion miles of vehicle travel.

**Table 8-6: Fatalities per year, light-duty and medium-duty.**

| Calendar Year | No Action | Final  | Alternative A | Alternative B | Final % Change | Alternative A % Change | Alternative B % Change |
|---------------|-----------|--------|---------------|---------------|----------------|------------------------|------------------------|
| 2027          | 15,829    | 15,830 | 15,835        | 15,830        | 0.01%          | 0.04%                  | 0.01%                  |
| 2028          | 15,597    | 15,601 | 15,611        | 15,600        | 0.02%          | 0.09%                  | 0.02%                  |
| 2029          | 15,410    | 15,417 | 15,432        | 15,416        | 0.04%          | 0.14%                  | 0.04%                  |
| 2030          | 15,275    | 15,286 | 15,304        | 15,284        | 0.07%          | 0.20%                  | 0.06%                  |
| 2031          | 15,172    | 15,188 | 15,209        | 15,186        | 0.11%          | 0.24%                  | 0.09%                  |
| 2032          | 15,107    | 15,127 | 15,148        | 15,125        | 0.13%          | 0.27%                  | 0.12%                  |
| 2033          | 15,089    | 15,128 | 15,147        | 15,120        | 0.26%          | 0.39%                  | 0.20%                  |
| 2034          | 15,109    | 15,164 | 15,183        | 15,151        | 0.36%          | 0.49%                  | 0.28%                  |
| 2035          | 15,147    | 15,215 | 15,232        | 15,200        | 0.45%          | 0.56%                  | 0.35%                  |
| 2036          | 15,182    | 15,260 | 15,276        | 15,244        | 0.52%          | 0.62%                  | 0.41%                  |
| 2037          | 15,236    | 15,323 | 15,337        | 15,306        | 0.57%          | 0.67%                  | 0.46%                  |
| 2038          | 15,315    | 15,408 | 15,422        | 15,391        | 0.61%          | 0.70%                  | 0.50%                  |
| 2039          | 15,400    | 15,499 | 15,514        | 15,483        | 0.64%          | 0.74%                  | 0.54%                  |
| 2040          | 15,504    | 15,607 | 15,621        | 15,592        | 0.66%          | 0.76%                  | 0.57%                  |
| 2041          | 15,613    | 15,720 | 15,734        | 15,706        | 0.68%          | 0.78%                  | 0.59%                  |
| 2042          | 15,724    | 15,834 | 15,849        | 15,822        | 0.70%          | 0.79%                  | 0.62%                  |
| 2043          | 15,838    | 15,951 | 15,966        | 15,941        | 0.71%          | 0.81%                  | 0.64%                  |
| 2044          | 15,962    | 16,079 | 16,093        | 16,068        | 0.73%          | 0.82%                  | 0.66%                  |
| 2045          | 16,087    | 16,206 | 16,220        | 16,196        | 0.74%          | 0.82%                  | 0.68%                  |
| 2046          | 16,234    | 16,358 | 16,369        | 16,346        | 0.77%          | 0.83%                  | 0.69%                  |
| 2047          | 16,388    | 16,515 | 16,524        | 16,502        | 0.78%          | 0.83%                  | 0.70%                  |
| 2048          | 16,552    | 16,683 | 16,690        | 16,669        | 0.79%          | 0.83%                  | 0.71%                  |
| 2049          | 16,716    | 16,851 | 16,854        | 16,835        | 0.80%          | 0.83%                  | 0.71%                  |
| 2050          | 16,897    | 17,033 | 17,036        | 17,018        | 0.81%          | 0.82%                  | 0.72%                  |
| 2051          | 17,078    | 17,216 | 17,218        | 17,200        | 0.81%          | 0.82%                  | 0.72%                  |
| 2052          | 17,257    | 17,397 | 17,398        | 17,381        | 0.81%          | 0.82%                  | 0.72%                  |
| 2053          | 17,440    | 17,581 | 17,581        | 17,565        | 0.81%          | 0.81%                  | 0.71%                  |
| 2054          | 17,624    | 17,766 | 17,765        | 17,749        | 0.81%          | 0.80%                  | 0.71%                  |
| 2055          | 17,810    | 17,952 | 17,952        | 17,934        | 0.80%          | 0.80%                  | 0.70%                  |



**Table 8-7: Fatality rate impacts, light-duty and medium-duty (fatalities per billion miles).**

| Calendar Year | No Action | Final | Alternative A | Alternative B | Final % Change | Alternative A % Change | Alternative B % Change |
|---------------|-----------|-------|---------------|---------------|----------------|------------------------|------------------------|
| 2027          | 5.02      | 5.02  | 5.03          | 5.02          | 0.01%          | 0.04%                  | 0.01%                  |
| 2028          | 4.91      | 4.91  | 4.91          | 4.91          | 0.00%          | 0.09%                  | 0.02%                  |
| 2029          | 4.82      | 4.82  | 4.83          | 4.82          | 0.01%          | 0.14%                  | 0.04%                  |
| 2030          | 4.75      | 4.75  | 4.76          | 4.75          | 0.02%          | 0.19%                  | 0.06%                  |
| 2031          | 4.70      | 4.70  | 4.71          | 4.70          | 0.04%          | 0.24%                  | 0.09%                  |
| 2032          | 4.66      | 4.66  | 4.67          | 4.66          | 0.06%          | 0.27%                  | 0.12%                  |
| 2033          | 4.62      | 4.63  | 4.64          | 4.63          | 0.19%          | 0.41%                  | 0.23%                  |
| 2034          | 4.60      | 4.61  | 4.62          | 4.61          | 0.30%          | 0.53%                  | 0.32%                  |
| 2035          | 4.57      | 4.59  | 4.60          | 4.59          | 0.38%          | 0.61%                  | 0.40%                  |
| 2036          | 4.56      | 4.58  | 4.59          | 4.58          | 0.45%          | 0.68%                  | 0.47%                  |
| 2037          | 4.54      | 4.57  | 4.58          | 4.57          | 0.51%          | 0.73%                  | 0.53%                  |
| 2038          | 4.53      | 4.56  | 4.57          | 4.56          | 0.55%          | 0.78%                  | 0.57%                  |
| 2039          | 4.53      | 4.55  | 4.56          | 4.55          | 0.59%          | 0.81%                  | 0.62%                  |
| 2040          | 4.52      | 4.55  | 4.56          | 4.55          | 0.61%          | 0.84%                  | 0.65%                  |
| 2041          | 4.52      | 4.55  | 4.56          | 4.55          | 0.63%          | 0.86%                  | 0.68%                  |
| 2042          | 4.51      | 4.54  | 4.55          | 4.54          | 0.65%          | 0.88%                  | 0.70%                  |
| 2043          | 4.51      | 4.54  | 4.55          | 4.54          | 0.67%          | 0.89%                  | 0.73%                  |
| 2044          | 4.51      | 4.54  | 4.55          | 4.54          | 0.69%          | 0.90%                  | 0.75%                  |
| 2045          | 4.50      | 4.54  | 4.55          | 4.54          | 0.71%          | 0.91%                  | 0.77%                  |
| 2046          | 4.50      | 4.53  | 4.54          | 4.54          | 0.74%          | 0.93%                  | 0.79%                  |
| 2047          | 4.50      | 4.53  | 4.54          | 4.53          | 0.76%          | 0.93%                  | 0.79%                  |
| 2048          | 4.50      | 4.53  | 4.54          | 4.53          | 0.78%          | 0.93%                  | 0.80%                  |
| 2049          | 4.50      | 4.53  | 4.54          | 4.53          | 0.79%          | 0.92%                  | 0.81%                  |
| 2050          | 4.49      | 4.53  | 4.54          | 4.53          | 0.80%          | 0.92%                  | 0.81%                  |
| 2051          | 4.49      | 4.53  | 4.53          | 4.53          | 0.81%          | 0.92%                  | 0.81%                  |
| 2052          | 4.49      | 4.53  | 4.53          | 4.53          | 0.81%          | 0.91%                  | 0.81%                  |
| 2053          | 4.49      | 4.53  | 4.53          | 4.53          | 0.81%          | 0.90%                  | 0.80%                  |
| 2054          | 4.49      | 4.53  | 4.53          | 4.52          | 0.81%          | 0.89%                  | 0.80%                  |
| 2055          | 4.49      | 4.52  | 4.53          | 4.52          | 0.80%          | 0.89%                  | 0.79%                  |

## 8.5 Estimating Fuel Consumption in OMEGA

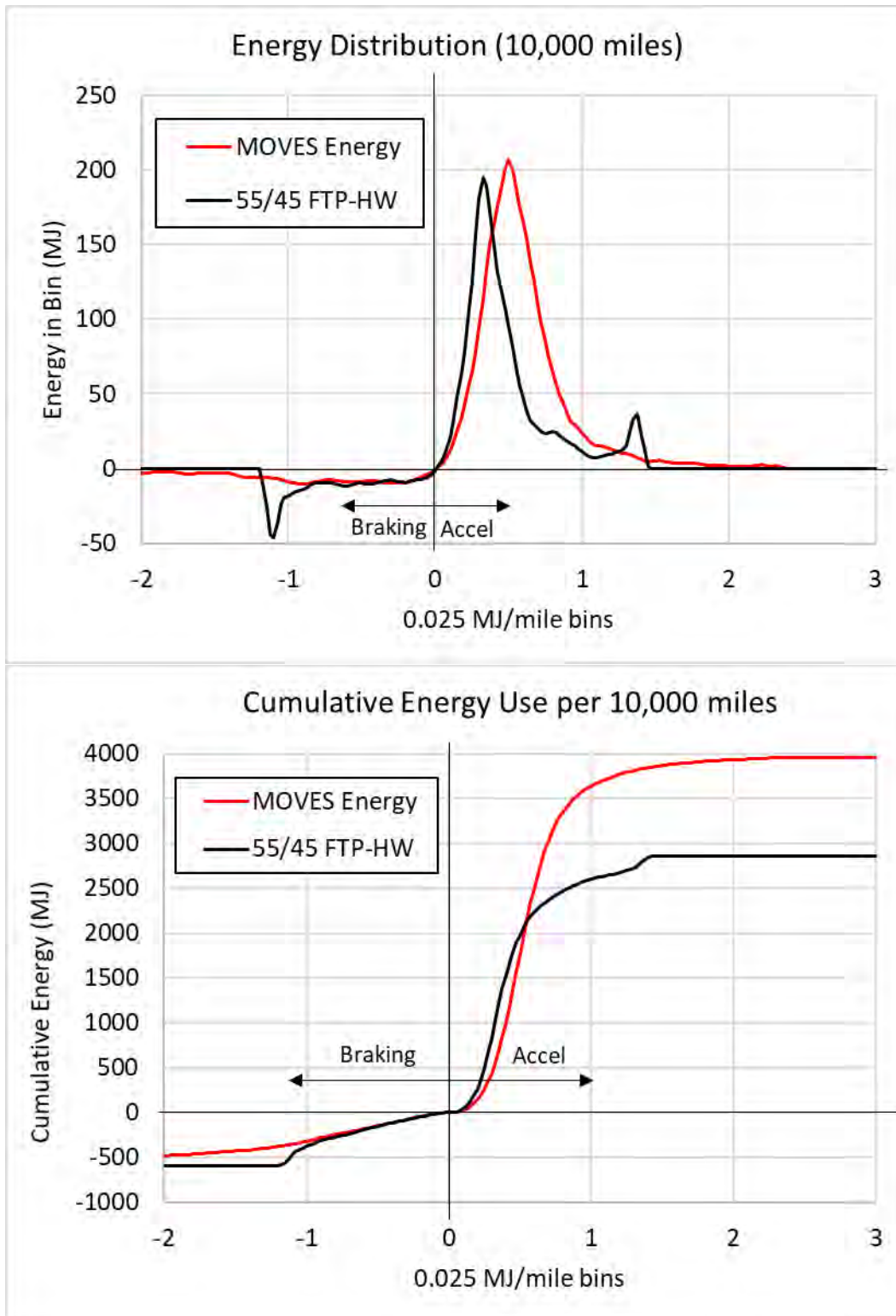
### 8.5.1 Drive Cycles for Onroad Fuel Consumption

To develop a best mix of regulatory cycles representing typical onroad vehicle operation, EPA used two sources: the MOVES light-duty drive cycles and associated weights, and aggregate vehicle behavior gleaned from California Real Emissions Assessment Logging (REAL) data.

The MOVES model uses 18 representative cycles. For each cycle, the time, distance, and energy expenditure at each speed was calculated, then binned in 0.5 mph increments. Additionally, the average speed and positive kinetic energy ("PKE;" a measure of driver aggressiveness) was calculated. The energy expenditure was calculated using the equivalent test weight (ETW) and road load of a nominal vehicle. Nominal vehicle characteristics were determined using the MOVES average passenger car and light truck parameters, weighted by vehicle miles traveled (VMT). The statistics for all cycles were combined and weighted based on the VMT associated with each cycle. The end result indicated an average speed of 36.6 mph and a PKE of 3700 km/hr<sup>2</sup>.

From the California REAL data, the average vehicle speed and positive kinetic energy was determined across a range of vehicles. These data indicated an average speed higher than that from the MOVES model data (41.1 mph), but a similar PKE (3900 km/hr<sup>2</sup>).

To represent onroad behavior, EPA began with the energy expenditure distribution from the MOVES data, as shown in Figure 8-9. The MOVES energy expenditure distribution is shown compared to the energy expenditure distribution of the "city" (FTP) and highway (HW) cycles, weighted 55%/45%. As can be seen, the 55/45 FTP/HW cycle has peak energy expenditure at a noticeably lower Megajoule per mile (MJ/mile) value, leading to a substantially lower cumulative energy expenditure. (The small peaks in the 55/45 FTP/HW cycle correspond to accelerations of positive and negative 3.3 mph/sec, accelerations at which these cycles are truncated.)



**Figure 8-9: Energy distribution (top) and cumulative energy use (bottom) over 10,000 miles for the MOVES onroad data, compared to FTP/HW regulatory cycles, weighted 55%/45%.**

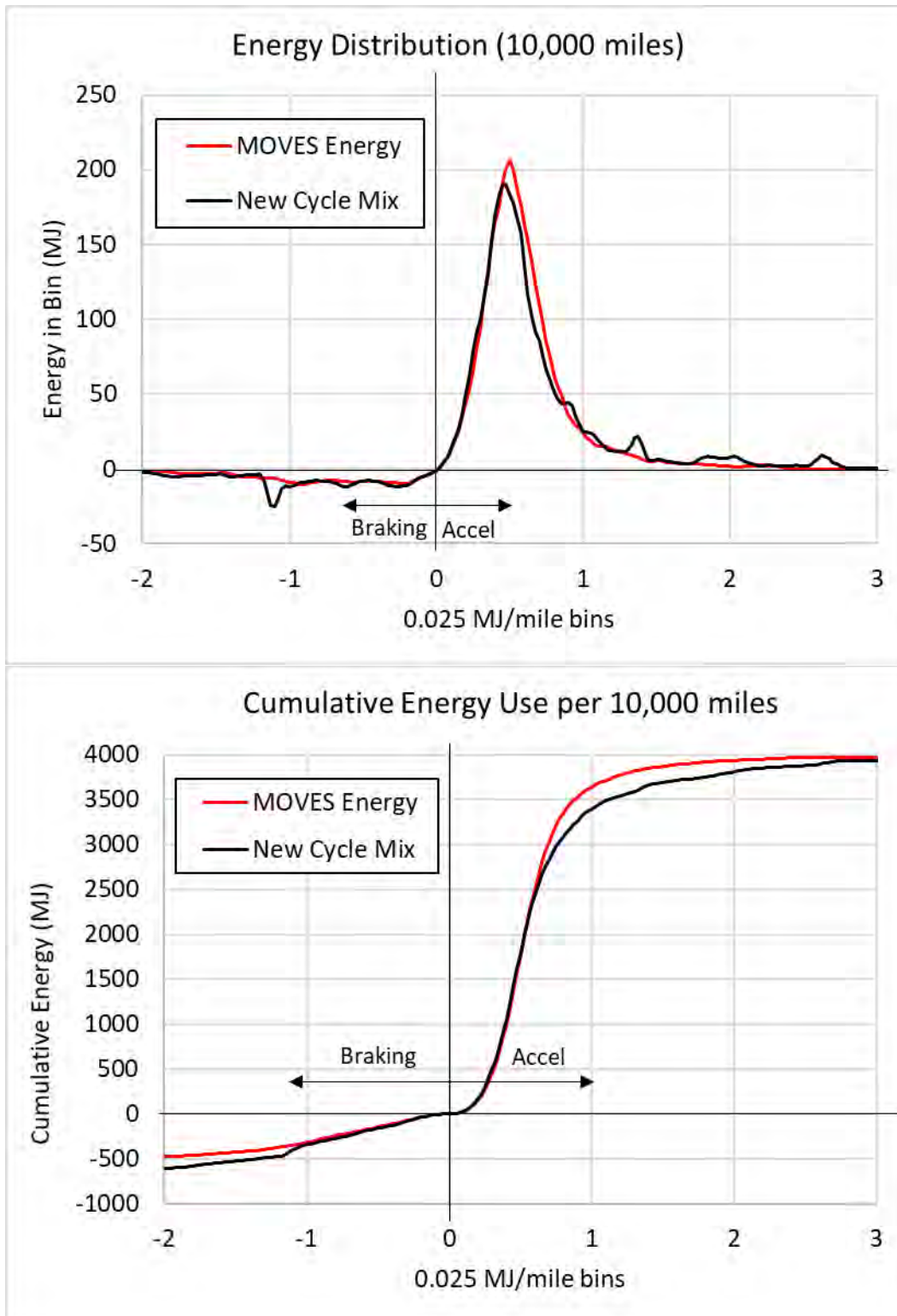
To develop a better mix of cycles to represent onroad operation, EPA looked primarily at the energy distribution, but also factored in the distribution of speeds and the PKE. At the end, a mix of cycles was chosen that best matched these multiple optimization criteria.

EPA evaluated reweighting the bags of the FTP and incorporating portions of the US06 cycle.<sup>249</sup> Reweighting the FTP did not improve the energy distribution match between vehicle operation across cycles and representative onroad operation used to estimate energy use and fuel consumption. However, incorporating the high acceleration and high-speed portions of the US06 did improve the energy distribution match with the MOVES data. Moreover, with the inclusion of the US06 cycle, incorporating the HW cycle conferred no benefit, and this cycle was dropped.

After considering the effects of various cycle mixes, EPA selected a mix of cycles where the weighting was 27% FTP, 6% US06 bag 1 (a high acceleration "city" bag), and 67% US06 bag 2 (a high speed "highway" bag). The energy expenditure distribution for this new cycle mix is shown in Figure 8-10, again compared to the MOVES data. As can be seen, the energy distribution of this cycle mix is much better aligned with the MOVES data, and the total positive energy expended is nearly identical.

---

<sup>249</sup> The FTP dynamometer cycle is divided into three (or, for hybrids, four) sequential sections, known as "bags." The bags represent different operational characteristics, both for powertrain warmup and cycle speeds and accelerations. Emissions from each bag are recorded separately. Bag results are weighted to represent on-road driving behavior more closely, and the weighted results combined to produce the final FTP emissions values.



**Figure 8-10: Energy distribution (top) and cumulative energy use (bottom) over 10,000 miles for the new cycle mix (27% FTP, 6% US06 bag 1, 67% US06 bag 2) compared to the MOVES onroad data.**

In choosing this new cycle mix, EPA also considered the speed distribution of the mix and the PKE. This mix of cycles had a PKE of 4300 km/hr<sup>2</sup> (slightly higher than the MOVES or REAL data) and an average speed of 40.6 mph. This average speed is higher than that of the MOVES data, and closer to (but lower than) the REAL data. The speed distribution for this mix is shown in Figure 8-11.

As can be inferred from Figure 8-11, the FTP and US06 cycles have substantial periods of operation within a small speed window, giving the speed distribution the clear double-humped shape. However, the overall speed profile remains similar that from the MOVES data.

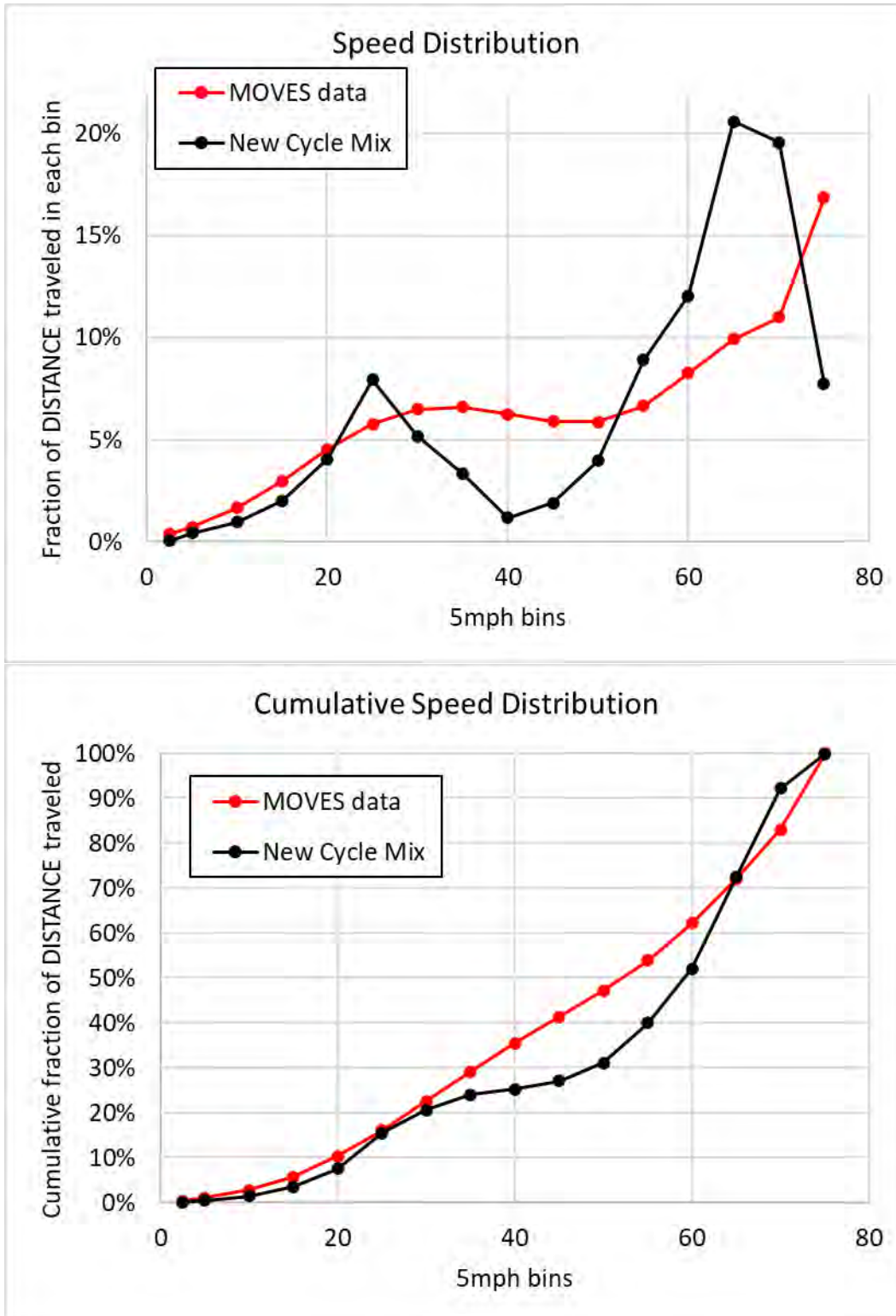


Figure 8-11: Speed distribution for the new cycle mix (27% FTP, 6% US06 bag 1, 67% US06 bag 2) compared to the MOVES onroad data.

To estimate fuel consumption impacts, OMEGA considers both the fuel(s) used by a given vehicle and the share of miles driven by the vehicle on that fuel or fuels. For a fossil fuel-only vehicle (including HEVs) or a BEV, the share of miles driven on the primary fuel would be 100 percent. For a PHEV, the share of miles driven on each fuel, the primary fuel (presumably liquid fuel), and the secondary fuel (presumably electricity), are considered.

First, the vehicle miles traveled for the given vehicle on each fuel is calculated as below.

$$VMT_{vehicle;liquid\ fuel} = VMT_{vehicle} \times \text{Onroad EngineON fraction}$$

$$VMT_{vehicle;electricity} = VMT_{vehicle} - VMT_{vehicle;liquid\ fuel}$$

Where,

$VMT_{vehicle}$  = the VMT of the vehicle

$VMT_{vehicle;electricity}$  = the VMT of the vehicle on electricity

$VMT_{vehicle;liquid\ fuel}$  = the VMT of the vehicle on liquid fuel

*Onroad EngineON fraction* is the fraction of operation with the internal combustion engine running which is calculated for each vehicle in the OMEGA compliance calculations.

### **8.5.2 Electricity Consumption**

To estimate BEV energy consumption, the VMT is multiplied by the rate of energy consumption, or kWh/mile during onroad operation.

Electricity consumption is then calculated as:

$$Consumption_{vehicle;electricity} = VMT_{vehicle;electricity} \times \frac{\left(\frac{kWh}{mile}\right)_{vehicle; onroad}}{charge\ efficiency}$$

Where,

$Consumption_{vehicle; electricity}$  = the electricity consumption of the given vehicle

$VMT_{vehicle; electricity}$  = the vehicle miles traveled on electricity

$(kWh/mile)_{vehicle; onroad}$  = the vehicle rate of energy consumption onroad

*Charge efficiency* = factor to capture losses between the charge point and the vehicle battery, set via the onroad\_fuels.csv OMEGA input file

### **8.5.3 Liquid-Fuel Consumption**

For liquid fuel consumption, OMEGA calculates the onroad fuel consumption rate making use of the onroad CO<sub>2</sub>/mile and the CO<sub>2</sub> content of a gallon of the applicable liquid fuel, as below.



$$\left(\frac{\text{Gallons}}{\text{mile}}\right)_{\text{vehicle;onroad}} = \frac{\left(\frac{\text{CO}_2}{\text{mile}}\right)_{\text{vehicle;onroad}}}{\left(\frac{\text{CO}_2}{\text{gallon}}\right)_{\text{fuel}}}$$

Where,

$(\text{Gallons}/\text{mile})_{\text{vehicle;onroad}}$  = the fuel consumption rate of the given vehicle onroad

$(\text{CO}_2/\text{mile})_{\text{vehicle;onroad}}$  = the CO<sub>2</sub>/mile of the given vehicle on the road

$(\text{CO}_2/\text{gallon})_{\text{fuel}}$  = the CO<sub>2</sub> emitted from combustion of a gallon of fuel (8,596 for gasoline, 10,049 for diesel, see below)

Liquid-fuel consumption is then calculated as below.

$$\text{Consumption}_{\text{vehicle;liquid fuel}} = \text{VMT}_{\text{vehicle;liquid fuel}} \times \left(\frac{\text{Gallons}}{\text{mile}}\right)_{\text{vehicle;onroad}}$$

Where,

$\text{Consumption}_{\text{vehicle; liquid fuel}}$  = the liquid fuel consumption of the given vehicle

$\text{VMT}_{\text{vehicle; liquid fuel}}$  = the vehicle miles traveled on liquid fuel

$(\text{Gallons}/\text{mile})_{\text{vehicle; onroad}}$  = the vehicle rate of liquid-fuel consumption onroad

We use values of 8,596 grams CO<sub>2</sub> per gallon of gasoline and 10,049 grams CO<sub>2</sub> per gallon of diesel based on information provided by the Energy Information Administration. (EIA 2014) That EIA source showed that burning a gallon of petroleum-only gasoline produces 19.64 grams of CO<sub>2</sub> while burning a gallon of E100 (pure ethanol) produces 12.72 pounds of CO<sub>2</sub>. Similarly, burning a gallon of petroleum-only diesel produces 22.38 pounds of CO<sub>2</sub> while burning a gallon of B100 (100 percent biodiesel) produces 20.13 pounds of CO<sub>2</sub>. For retail gasoline we used a share of 90 percent petroleum-only and 10 percent ethanol and used the same ratios for diesel fuel to arrive at the values shown above using the equations shown here:

$$\left(\frac{\text{CO}_2}{\text{gallon}}\right)_{\text{gasoline}} = (0.9 \times 19.64 + 0.1 \times 12.72) \times 453.6$$

$$\left(\frac{\text{CO}_2}{\text{gallon}}\right)_{\text{diesel}} = (0.9 \times 22.38 + 0.1 \times 20.13) \times 453.6$$

Where,

19.64 = pounds of CO<sub>2</sub> per gallon of pure gasoline

12.72 = pounds of CO<sub>2</sub> per gallon of E100

22.38 = pounds of CO<sub>2</sub> per gallon of pure diesel

20.13 = pounds of CO<sub>2</sub> per gallon of B100

453.6 = the conversion from pounds to grams

### **8.5.4 Summary of Fuel and Electricity Consumption in the Analysis**

In the tables presented in this summary of liquid fuel and electricity consumption impacts, the percent changes reflect changes in light- and medium-duty liquid fuel and electricity consumption relative to the No Action scenario and do not represent percent changes in total U.S. consumption. Note that according to the Energy Information Administration (EIA), 2022 U.S. electricity consumption was roughly 4,050 TWh. (EIA 2023) This means that the 0.94 TWh increase shown in 2027 is less than 0.1% of 2022 U.S. electricity consumption and the 360 TWh increase shown in 2055 is less than 9% of 2022 U.S. electricity consumption.

**Table 8-8: Fuel and electricity consumption impacts, final standards.**

| Calendar Year | Liquid Fuel (billion gallons) | Electricity (TWh) | Liquid Fuel % Change | Electricity % Change |
|---------------|-------------------------------|-------------------|----------------------|----------------------|
| 2027          | -0.07                         | 0.94              | -0.049%              | 0.93%                |
| 2028          | -0.48                         | 4.1               | -0.35%               | 3.2%                 |
| 2029          | -1.5                          | 13                | -1.1%                | 8%                   |
| 2030          | -3                            | 27                | -2.4%                | 15%                  |
| 2031          | -5                            | 47                | -4.1%                | 21%                  |
| 2032          | -7.2                          | 67                | -6.1%                | 27%                  |
| 2033          | -10                           | 94                | -9.1%                | 35%                  |
| 2034          | -14                           | 120               | -12%                 | 43%                  |
| 2035          | -17                           | 150               | -15%                 | 49%                  |
| 2036          | -20                           | 180               | -19%                 | 55%                  |
| 2037          | -23                           | 200               | -22%                 | 59%                  |
| 2038          | -25                           | 220               | -25%                 | 63%                  |
| 2039          | -28                           | 240               | -27%                 | 67%                  |
| 2040          | -30                           | 260               | -30%                 | 70%                  |
| 2041          | -32                           | 270               | -32%                 | 72%                  |
| 2042          | -34                           | 290               | -34%                 | 74%                  |
| 2043          | -36                           | 310               | -36%                 | 76%                  |
| 2044          | -37                           | 320               | -38%                 | 78%                  |
| 2045          | -39                           | 330               | -39%                 | 78%                  |
| 2046          | -40                           | 340               | -40%                 | 79%                  |
| 2047          | -41                           | 340               | -41%                 | 78%                  |
| 2048          | -42                           | 350               | -42%                 | 78%                  |
| 2049          | -42                           | 350               | -42%                 | 77%                  |
| 2050          | -43                           | 350               | -42%                 | 76%                  |
| 2051          | -43                           | 360               | -43%                 | 75%                  |
| 2052          | -43                           | 360               | -43%                 | 73%                  |
| 2053          | -43                           | 360               | -43%                 | 72%                  |
| 2054          | -43                           | 360               | -43%                 | 69%                  |
| 2055          | -43                           | 360               | -42%                 | 68%                  |
| Sum           | -780                          | 6,700             |                      |                      |

Negative values represent decreases, positive values increases; One Terawatt hour (TWh) is equal to 1 billion kilowatt hours (kWh).

**Table 8-9: Fuel and electricity consumption impacts, Alternative A.**

| Calendar Year | Liquid Fuel (billion gallons) | Electricity (TWh) | Liquid Fuel % Change | Electricity % Change |
|---------------|-------------------------------|-------------------|----------------------|----------------------|
| 2027          | -0.78                         | 6.9               | -0.54%               | 6.9%                 |
| 2028          | -2.1                          | 18                | -1.6%                | 14%                  |
| 2029          | -3.9                          | 34                | -3%                  | 22%                  |
| 2030          | -6                            | 52                | -4.7%                | 28%                  |
| 2031          | -8.3                          | 72                | -6.8%                | 33%                  |
| 2032          | -11                           | 92                | -9%                  | 37%                  |
| 2033          | -14                           | 120               | -12%                 | 44%                  |
| 2034          | -17                           | 140               | -15%                 | 51%                  |
| 2035          | -20                           | 170               | -18%                 | 57%                  |
| 2036          | -23                           | 200               | -21%                 | 61%                  |
| 2037          | -25                           | 220               | -24%                 | 65%                  |
| 2038          | -28                           | 240               | -27%                 | 69%                  |
| 2039          | -30                           | 260               | -30%                 | 72%                  |
| 2040          | -32                           | 270               | -32%                 | 74%                  |
| 2041          | -34                           | 290               | -34%                 | 75%                  |
| 2042          | -36                           | 300               | -36%                 | 77%                  |
| 2043          | -37                           | 310               | -38%                 | 78%                  |
| 2044          | -39                           | 320               | -39%                 | 79%                  |
| 2045          | -40                           | 330               | -40%                 | 79%                  |
| 2046          | -41                           | 340               | -41%                 | 80%                  |
| 2047          | -42                           | 350               | -42%                 | 80%                  |
| 2048          | -42                           | 350               | -42%                 | 79%                  |
| 2049          | -43                           | 360               | -43%                 | 78%                  |
| 2050          | -43                           | 360               | -43%                 | 77%                  |
| 2051          | -44                           | 360               | -43%                 | 76%                  |
| 2052          | -44                           | 360               | -43%                 | 74%                  |
| 2053          | -44                           | 360               | -43%                 | 72%                  |
| 2054          | -44                           | 360               | -43%                 | 70%                  |
| 2055          | -44                           | 360               | -43%                 | 68%                  |
| Sum           | -830                          | 7,000             |                      |                      |

Negative values represent decreases, positive values increases; One Terawatt hour (TWh) is equal to 1 billion kilowatt hours (kWh)

**Table 8-10: Fuel and electricity consumption impacts, Alternative B.**

| Calendar Year | Liquid Fuel (billion gallons) | Electricity (TWh) | Liquid Fuel % Change | Electricity % Change |
|---------------|-------------------------------|-------------------|----------------------|----------------------|
| 2027          | -0.052                        | 0.79              | -0.036%              | 0.78%                |
| 2028          | -0.4                          | 3.1               | -0.29%               | 2.4%                 |
| 2029          | -1.4                          | 11                | -1%                  | 7%                   |
| 2030          | -2.8                          | 23                | -2.2%                | 12%                  |
| 2031          | -4.5                          | 39                | -3.7%                | 18%                  |
| 2032          | -6.6                          | 58                | -5.6%                | 23%                  |
| 2033          | -9.4                          | 84                | -8.3%                | 31%                  |
| 2034          | -12                           | 110               | -11%                 | 38%                  |
| 2035          | -15                           | 130               | -13%                 | 42%                  |
| 2036          | -17                           | 140               | -16%                 | 46%                  |
| 2037          | -19                           | 160               | -18%                 | 48%                  |
| 2038          | -21                           | 180               | -21%                 | 51%                  |
| 2039          | -23                           | 190               | -23%                 | 53%                  |
| 2040          | -25                           | 200               | -25%                 | 55%                  |
| 2041          | -27                           | 210               | -27%                 | 56%                  |
| 2042          | -28                           | 220               | -28%                 | 57%                  |
| 2043          | -30                           | 230               | -30%                 | 59%                  |
| 2044          | -31                           | 240               | -31%                 | 59%                  |
| 2045          | -32                           | 250               | -33%                 | 60%                  |
| 2046          | -33                           | 260               | -34%                 | 60%                  |
| 2047          | -34                           | 260               | -34%                 | 60%                  |
| 2048          | -35                           | 270               | -35%                 | 60%                  |
| 2049          | -35                           | 270               | -35%                 | 59%                  |
| 2050          | -36                           | 270               | -36%                 | 58%                  |
| 2051          | -36                           | 270               | -36%                 | 57%                  |
| 2052          | -36                           | 270               | -36%                 | 55%                  |
| 2053          | -36                           | 270               | -36%                 | 54%                  |
| 2054          | -36                           | 270               | -35%                 | 52%                  |
| 2055          | -36                           | 270               | -35%                 | 50%                  |
| Sum           | -660                          | 5,200             |                      |                      |

Negative values represent decreases, positive values increases; One Terawatt hour (TWh) is equal to 1 billion kilowatt hours (kWh)

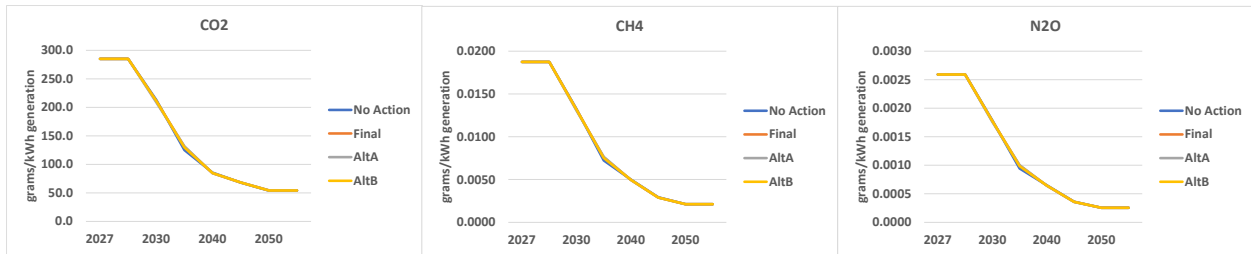
## **8.6 Estimating Emission Inventories in OMEGA**

To estimate emission inventory effects due to a potential policy, OMEGA uses, as inputs, a set of vehicle and electricity generating unit (EGU) emission inventories. In a circular process, we first generate emission inventories using very detailed emissions models that estimate inventories from vehicles (EPA's MOVES model), EGUs (EPA's Power Sector Modeling Platform, v.6.21), and refineries (EPA's 2016v3 emissions modeling platform). The generation of those inventories is described in Chapter 7 and Chapter 5. However, upstream inventories (EGUs) made use of a set of bounding runs that looked at two possible futures—one with a low level of fleet electrification and another with a higher level of electrification. These bounding runs represented our best estimate of these two possible futures—the continuation of the 2021 FRM (lower) and our proposed Alternative 3 (upper)—at the time that those model runs were conducted. With those bounded sets of inventories, and the associated fuel and electricity demands within them (i.e., electricity demands for EGUs), we can calculate emission rates for the two ends of these bounds. Using those rates, we can interpolate, using the given OMEGA policy scenario's fuel demands, to generate a unique set of emission rates for that OMEGA policy scenario. Using those unique rates, OMEGA then generates emission inventories for any future OMEGA policy scenario depending on the liquid fuel and electricity demands of that specific policy.

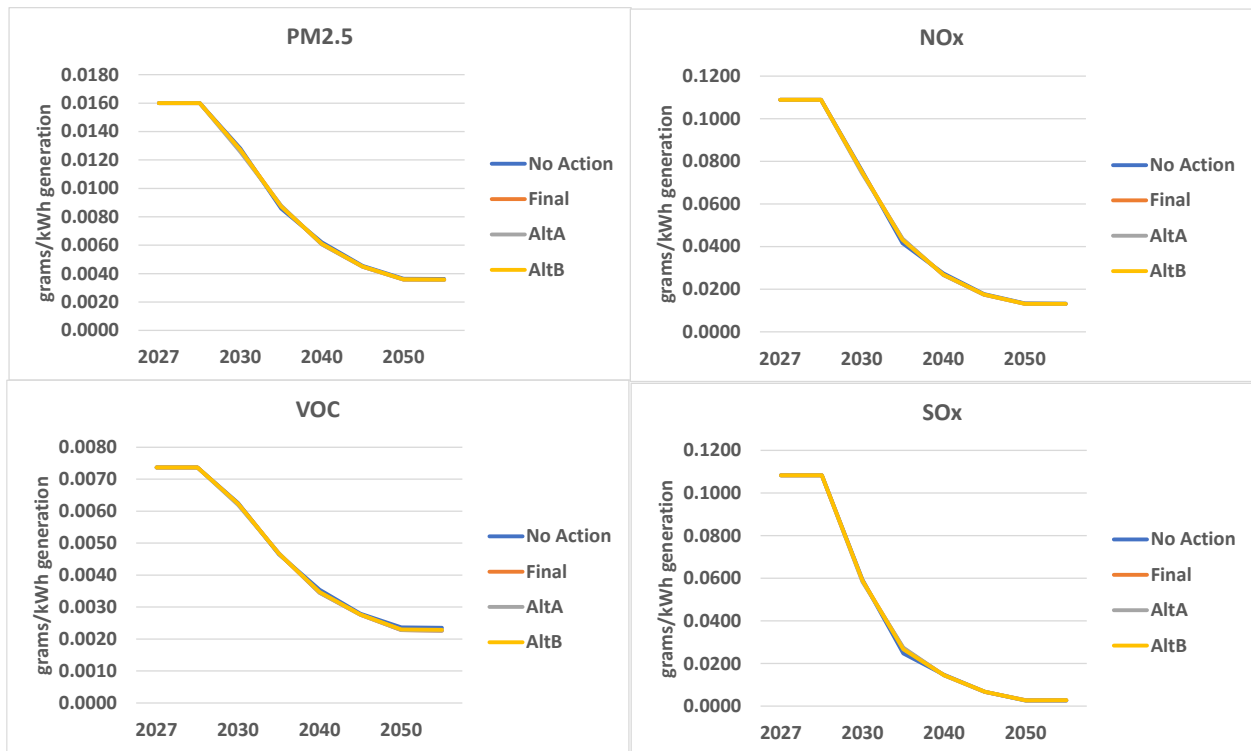
For vehicle emissions, EPA made use of two sets of MOVES emission inventory runs—one assuming no future use of gasoline particulate filters and one assuming such use. Using the miles traveled (for tailpipe, tire wear, and brake wear emissions) and liquid fuel consumed (for evaporative and fuel spillage emissions), we can then generate sets of emission rates for use in OMEGA. Using those rates, which are specific to fuel types and vehicle types (car vs. truck, etc.), we can then generate unique emission inventories for the given OMEGA policy scenario. This is important given the changing nature of the transportation fleet (BEV vs ICE, car vs CUV vs pickup) and the way those change for any possible policy scenario and the many factors within that impact the future fleet composition and the very different vehicle emission rates for BEV vs ICE vehicles. This is especially true given the consumer choice elements within OMEGA and the wide variety of input parameters that can have significant impacts on the projected future fleet.

### **8.6.1 Calculating EGU Emission Rates in OMEGA**

As described in Chapter 5 and presented in Chapter 5.2.3, EPA has generated EGU inventories for the no-action case and the proposed Alternative 3. Those inventories are presented in Tables 5-2 and 5-3 and are shown graphically in the accompanying charts. To generate those inventories, EPA first ran OMEGA to estimate PEV energy demands into the future. Those energy demands were used in the modeling of EGU inventories presented in Chapter 5. EPA then uses the resultant inventories along with the associated "Generation" values shown in Tables 5-2 and 5-3, appropriately, and the estimated PEV energy demands from OMEGA used in generating the EGU inventory results, and linear interpolation between years to generate a set of emission rates as a function of years from 2028. The resultant EGU emission rates by scenario and pollutant are shown in Figure 8-12 and Figure 8-13.



**Figure 8-12: EGU GHG emission rates in the no action, final and alternative scenarios (grams/kWh of US generation).**



**Figure 8-13: EGU criteria pollutant emission rates in the no action, final and alternative scenarios (grams/kWh of US generation).**

Using these curves, OMEGA can calculate the estimated U.S. electricity generation in any year of the analysis under any scenario and then calculate the EGU inventories unique to that scenario.

To estimate the unique EGU emission rates for any given OMEGA scenario, OMEGA first determines the PEV consumption estimate for a given year, which is driven by the level of the standards and the expected PEV penetration rate, among other impacts (consumer acceptance, critical materials, etc.). OMEGA then calculates a base U.S. generation as the IPM modeled low demand generation less the light- and medium-duty fleet demand used in generating the IPM inventories. To that result, OMEGA adds the estimated scenario demand to arrive at a new U.S. generation for the policy in any given year. With that estimated scenario demand, OMEGA then

interpolates the scenario emission rate using the IPM modeled demands and the rates calculated using the IPM modeled inventories.

$$Rate_{scenario} = \left[ \frac{(Generation_{US;scenario} - Generation_{US;low\ demand})}{(Generation_{US;high\ demand} - Generation_{US;low\ demand}) + Rate_{low\ demand}} \times (Rate_{high\ demand} - Rate_{low\ demand}) \right]$$

Where, for a given pollutant in a given year of a given OMEGA scenario,

$Rate_{scenario}$  = the EGU emission rate in the scenario

$Rate_{low\ demand}$  = the EGU emission rate calculated using the low demand inventory

$Rate_{high\ demand}$  = the EGU emission rate calculated using the high demand inventory

$Generation_{US; low\ demand}$  = US electricity generation using the low demand IPM results

$Generation_{US; high\ demand}$  = US electricity generation using the high demand IPM results

$Generation_{US; scenario}$  = US estimated electricity generation in the scenario

### **8.6.2 Calculating Refinery Emission Rates in OMEGA**

To estimate refinery emission inventories, OMEGA needs refinery emission rates, i.e., grams of pollutant per gallon of fuel refined. These refinery emission rates can then be applied to fuel consumption or, more specifically, changes in fuel consumption to estimate refinery emission impacts associated with the liquid fuel consumption impacts expected from the light-duty and medium-duty fleets.

The starting point for estimating the refinery emission rates was the refinery emission inventory estimates generated in support of the air quality modeling (U.S. EPA 2024). Those refinery inventories were generated for select calendar years and reflect estimates associated with the air quality modeling no action, or reference, case. These are shown in Table 8-11.

**Table 8-11: Emissions from Refineries that Refine Onroad Liquid Fuels (US tons per year).**

| Calendar Year | CO     | CO <sub>2</sub> | CH <sub>4</sub> | N <sub>2</sub> O | NO <sub>x</sub> | PM <sub>2.5</sub> | SO <sub>x</sub> | VOC    |
|---------------|--------|-----------------|-----------------|------------------|-----------------|-------------------|-----------------|--------|
| 2030          | 50,463 | 179,019,970     | 9,608           | 1,529            | 75,350          | 17,738            | 22,955          | 57,274 |
| 2035          | 50,498 | 179,497,795     | 9,583           | 1,533            | 75,484          | 17,759            | 22,996          | 57,298 |
| 2040          | 50,829 | 180,908,447     | 9,621           | 1,545            | 76,169          | 17,883            | 23,134          | 57,416 |
| 2045          | 51,266 | 183,618,188     | 9,662           | 1,568            | 76,945          | 18,054            | 23,316          | 57,608 |
| 2050          | 51,794 | 186,521,729     | 9,743           | 1,593            | 77,830          | 18,253            | 23,501          | 57,829 |

Knowing the gallons of fuel refined in generating those emissions inventories, we could use them to generate the desired emissions per gallon refined. But the number of gallons refined by U.S. refiners, especially the gallons refined specifically for domestic consumption, is not readily known. Refineries in the U.S. refine onroad liquid fuels not only for consumption on domestic roads, but also for export and consumption elsewhere. Further, refineries in the U.S. refine more products than onroad gasoline and diesel fuels. As a result, not all their emissions are the result of refining onroad liquid fuel for domestic consumption.

To account for the former effect, that of exports, we start with the level of domestic fuel use, or consumption. For this, we can use AEO 2023 as presented in Table 8-12. This gives us the gasoline and diesel fuel use in the U.S., but it does not give us the fuel refined by U.S. refiners. We note that the U.S. is now a net exporter of petroleum products. AEO 2023 does not include estimated exports of liquid fuels. Instead, it presents estimates of net product imports along with projections of liquid fuel use in the U.S. We present those projections in Table 8-13 (note that AEO 2023 projects net imports and shows them as negative values, i.e., exports; we show them as positive net exports for clarity here).

**Table 8-12: AEO 2023 Projections of Domestic Liquid Fuel Use (Million Barrels per Day, (U.S. EIA 2023) see Table 11, Reference case).**

| Calendar Year | Motor Gasoline | Diesel Fuel | Other Petroleum Products |
|---------------|----------------|-------------|--------------------------|
| 2023          | 8.75           | 3.66        | 7.61                     |
| 2030          | 8.12           | 3.31        | 8.15                     |
| 2035          | 7.61           | 3.22        | 8.47                     |
| 2040          | 7.30           | 3.19        | 8.79                     |
| 2045          | 7.23           | 3.20        | 9.16                     |
| 2050          | 7.43           | 3.20        | 9.53                     |

Note the presence of a value for net exports in calendar year 2022. We present this value because we use it to calculate a net export scaler that we then apply to subsequent projections of domestic fuel use. Remember that the emission inventories we started with and the AEO projections of fuel use do not reflect the projected light-duty and medium-duty fleets that we project with each run of the OMEGA model and the different policies considered in each. Those scaling factors are shown in Table 8-13 and are simple ratios of each calendar year projection to the 2022 value for net exports.

**Table 8-13: Net Exports and Export Scaler Used to Project Future Net Exports Associated with any OMEGA Policy Scenario (Million Barrels per Day, (U.S. EIA 2023) see Table 11, Reference case).**

| Calendar Year | Net Exports | Export Scaler |
|---------------|-------------|---------------|
| 2022          | 3.99        | 1.00          |
| 2023          | 4.28        | 1.07          |
| 2030          | 6.08        | 1.53          |
| 2035          | 6.56        | 1.65          |
| 2040          | 6.80        | 1.70          |
| 2045          | 6.86        | 1.72          |
| 2050          | 6.43        | 1.61          |

However, our goal was to estimate the share of the net exports shown in Table 8-13 that are gasoline versus diesel versus other products. To this end, we consulted EIA's database of past exports. This database showed that, in 2022, the U.S. exported motor gasoline, low sulfur diesel fuel, and finished petroleum products in the amounts shown in Table 8-14.



**Table 8-14: EIA Petroleum Product Export Data for 2022 (EIA Imports by Area of Entry 2023)**

| Product                     | Million Barrels per Day |
|-----------------------------|-------------------------|
| Motor Gasoline              | 0.867                   |
| Low Sulfur Diesel Fuel      | 1.011                   |
| Finished Petroleum Products | 3.087                   |

Combining the export scalars presented in Table 8-13 with the data shown in Table 8-14, we then generated projections of future exports of gasoline, diesel, and other products that comprise the net exports shown in Table 8-13. Our projections are shown in Table 8-15. Note that the projections for "Other Petroleum Products" are simply the AEO 2023 net exports value less our projections for motor gasoline and diesel.

**Table 8-15: EPA Projections of Net Exports of Petroleum Products (Million Barrels per Day).**

| Calendar Year | Motor Gasoline | Diesel Fuel | Other Petroleum Products | Net Exports |
|---------------|----------------|-------------|--------------------------|-------------|
| 2023          | 0.93           | 1.08        | 2.26                     | 4.28        |
| 2030          | 1.32           | 1.54        | 3.22                     | 6.08        |
| 2035          | 1.43           | 1.66        | 3.47                     | 6.56        |
| 2040          | 1.48           | 1.72        | 3.60                     | 6.80        |
| 2045          | 1.49           | 1.74        | 3.63                     | 6.86        |
| 2050          | 1.40           | 1.63        | 3.40                     | 6.43        |

Combining the domestic fuel use data presented in Table 8-12 with our projected exports of each fuel as shown in Table 8-15, we then estimated the amount of each refined by U.S. refiners. Those results are shown in Table 8-16.

**Table 8-16: EPA Estimated Domestic Refining (Million Barrels per Day).**

| Calendar Year | Motor Gasoline | Diesel Fuel | Other Petroleum Products | Total |
|---------------|----------------|-------------|--------------------------|-------|
| 2023          | 9.68           | 4.75        | 9.87                     | 24.30 |
| 2030          | 9.44           | 4.85        | 11.37                    | 25.67 |
| 2035          | 9.04           | 4.89        | 11.94                    | 25.86 |
| 2040          | 8.78           | 4.92        | 12.39                    | 26.08 |
| 2045          | 8.73           | 4.94        | 12.79                    | 26.45 |
| 2050          | 8.83           | 4.84        | 12.93                    | 26.59 |

To account for the latter effect impacting the refinery emissions attributable to refining of liquid fuel for domestic consumption, that being that refineries refine more products than onroad liquid fuels, we calculated scaling factors to apportion emission inventories specifically to the refining of gasoline and diesel fuels versus other refined products. The scaling factors are based on the relative energy demand of refining various fuels calculated by Wang et al. (Wang 2004). Wang et al. expressed the energy demand of refining fuels in terms of mass and included outputs that are not refinery products, so we removed non-refinery products and adjusted the energy demand factors to be based on volume instead of mass.

Refinery emissions for refined products are related to the energy needed to refine those products, but also depend on the emissions of other pollutants specific to refining those products.

For example, the refining of gasoline causes higher methane emissions than an equivalent volume of diesel. We developed pollutant-specific apportionment factors based on relative emissions of refining gasoline, diesel, and other products using emission factors from DOE's Greenhouse gases, Regulated Emissions, and Energy use in Technologies model (GREET 2021). Final apportionment factors for each pollutant we modeled in our refinery analysis appear in Table 8-17.

**Table 8-17: Refinery Emission Apportionment by Fuel Type (unitless).**

| Pollutant                               | Gasoline | Diesel |
|---|----------|--------|
| Carbon Monoxide (CO)                    | 0.602    | 0.057  |
| Carbon Dioxide (CO <sub>2</sub> )       | 0.591    | 0.061  |
| Methane (CH <sub>4</sub> )              | 0.640    | 0.053  |
| Nitrous Oxide (N <sub>2</sub> O)        | 0.583    | 0.063  |
| Nitrogen Oxides (NO <sub>x</sub> )      | 0.610    | 0.056  |
| Particulate Matter (PM <sub>2.5</sub> ) | 0.620    | 0.054  |
| Sulfur Dioxide (SO <sub>2</sub> )       | 0.596    | 0.058  |
| Volatile Organic Compounds (VOC)        | 0.570    | 0.058  |

OMEGA uses the inventory data presented in Table 8-11, the estimated domestic refining data presented in Table 8-16, and the apportionment data presented in Table 8-17 to internally calculate refinery emission rates. That is, the rates are not inputs to OMEGA, but rather the raw data outlined above are the inputs. OMEGA also uses linear interpolations in years between the years where data are available. Further, for years prior to 2030, the 2030 inventory data are used, and beyond 2050, the 2050 data are used. In other words, we do not extrapolate data outside the bounds of data availability. When OMEGA runs, the refinery emission rates that are internally calculated are saved as one of the output files. Those results are shown in Table 8-18 for gasoline and Table 8-19 for diesel.

**Table 8-18: Refinery Emission Rates Calculated in OMEGA for Gasoline (US tons per billion gallons refined).**

| Calendar Year | CO  | CO <sub>2</sub> | CH <sub>4</sub> | N <sub>2</sub> O | NO <sub>x</sub> | PM <sub>2.5</sub> | SO <sub>x</sub> | VOC |
|---------------|-----|-----------------|-----------------|------------------|-----------------|-------------------|-----------------|-----|
| 2030          | 210 | 731,000         | 42.5            | 6.16             | 317             | 76.1              | 94.6            | 226 |
| 2035          | 220 | 766,000         | 44.3            | 6.45             | 332             | 79.5              | 99              | 236 |
| 2040          | 228 | 795,000         | 45.8            | 6.69             | 345             | 82.4              | 103             | 243 |
| 2045          | 231 | 811,000         | 46.2            | 6.83             | 351             | 83.7              | 104             | 246 |
| 2050          | 231 | 814,000         | 46.1            | 6.86             | 350             | 83.7              | 104             | 244 |

**Table 8-19: Refinery Emission Rates Calculated in OMEGA for Diesel Fuel (US tons per billion gallons refined).**

| Calendar Year | CO   | CO <sub>2</sub> | CH <sub>4</sub> | N <sub>2</sub> O | NO <sub>x</sub> | PM <sub>2.5</sub> | SO <sub>x</sub> | VOC  |
|---------------|------|-----------------|-----------------|------------------|-----------------|-------------------|-----------------|------|
| 2030          | 38.7 | 147,000         | 6.81            | 1.29             | 56.4            | 12.7              | 18              | 44.9 |
| 2035          | 38.5 | 146,000         | 6.75            | 1.29             | 56.1            | 12.7              | 17.9            | 44.6 |
| 2040          | 38.5 | 146,000         | 6.73            | 1.29             | 56.3            | 12.7              | 17.9            | 44.4 |
| 2045          | 38.7 | 148,000         | 6.73            | 1.30             | 56.7            | 12.8              | 18              | 44.4 |
| 2050          | 39.9 | 154,000         | 6.93            | 1.35             | 58.5            | 13.2              | 18.5            | 45.5 |

After calculating the refinery emission rates shown, OMEGA uses them to estimate refinery emissions associated with refining the fuels at issue, namely gasoline and diesel fuel meant for domestic onroad consumption. This is done using the methodology described in 8.6.4 where we also describe how our estimated reductions in fuel consumption are expected to impact refining in the U.S.

### **8.6.3 Vehicle Emission Rates in OMEGA**

For this analysis, EPA used an updated regulatory version of MOVES4, MOVES4.R2, to create criteria pollutant and air toxic emission rate inputs for OMEGA. As described in Chapter 7 and further detailed in a memo to the docket (Mo 2024), MOVES4.R2 was developed to represent our understanding of expected emissions under the rule at the time of our air quality modeling analysis. Months later, when we ran MOVES to develop OMEGA emission rate inputs, we had more information about how the final rule would regulate emissions of NMOG and NO<sub>x</sub> emissions and the implications for ICE vehicles. Given the form and values of the standards in the final rule, we now expect “backsliding” of hydrocarbon and NO<sub>x</sub> emissions among LD and MD ICE vehicles will be negligible. Thus, we created new default input databases for MOVES4.R2: MOVES4.R2a and MOVES4.R2b. These lack the LD and MD changes to the "emissionrateadjustment" table described in the docket memo.

To create inputs for OMEGA, EPA ran MOVES for two scenarios: gasoline engines with gasoline particulate filters (GPFs) (MOVES4.R2a) and without GPFs (MOVES4.R2b). The emission rates for these scenarios differed in that in the scenario with GPFs, the emission rates for exhaust PM were calculated by applying the GPF reduction factors and phase-in described in Chapter 7 for MY 2027 and later. In the scenario without GPFs, the emission rates remain at MOVES4 levels. We ran MOVES in inventory mode to create inventory and activity output by calendar year, model year, fuel type, source type, and regulatory class for brake wear, tire wear, start, running, and evaporative emissions for criteria emission precursors and air toxics. In these runs, the only air toxics affected by GPFs were particle-phase PAHs, which are chained to exhaust PM in MOVES. We consolidated the polycyclic aromatic hydrocarbons (PAH) output to separately report emissions for naphthalene and for a potency-weighted (U.S. EPA 2021) sum of the 15 other PAHs estimated by MOVES.

These two sets of MOVES output were then used to generate vehicle emission rates for use as OMEGA inputs. Since MOVES generates emission inventories, and the applicable miles traveled or gallons consumed attributes associated with those inventories, we can calculate nationwide vehicle emission rates from them (grams per mile or grams per gallon). These emission rates are then multiplied by the applicable miles driven or gallons consumed to estimate

vehicle exhaust, evaporative, tire wear, and brake wear emissions for all vehicles in both the analysis and legacy fleets and for each age in their lifetimes.

## **8.6.4 Calculating Upstream Emission Inventories**

### **8.6.4.1 Electric Generating Units**

To calculate upstream emission inventories, OMEGA operates on individual vehicles making use of the  $VMT_{policy}$  on each applicable fuel in the given OMEGA scenario.

For upstream emissions from EGUs, OMEGA first calculates the given vehicle's electricity consumption according to the  $Consumption_{vehicle;electricity}$  equation shown in Chapter 8.5.2. OMEGA then estimates the required EGU generation by accounting for grid losses as below.

$$Generation_{vehicle;electricity} = \frac{Consumption_{vehicle;electricity}}{transmission\ efficiency}$$

Where,

$Generation_{vehicle;electricity}$  = the estimated EGU generation requirement to satisfy the electricity consumption of the vehicle

$Consumption_{vehicle;electricity}$  = the electricity consumption of the given vehicle (described above), inclusive of estimated charging losses

$transmission\ efficiency$  = factor to account for the estimated efficiency of grid transmission, set via the `onroad_fuels.csv` OMEGA input file

OMEGA then calculates the annual electricity demand for the light- and medium-duty fleet. Using that value, OMEGA calculates a U.S. electricity generation for the given year as:

$$US\ Generation_{scenario} = US\ Generation_{low\ demand} - Demand_{IPM\ low\ demand} + Demand_{scenario}$$

where,

$US\ Generation_{scenario}$  = the estimated U.S. electricity generation in the given year for the given scenario or policy

$US\ Generation_{low\ demand}$  = the U.S. generation used in the IPM modeling discussed in Chapter 5

$Demand_{IPM\ low\ demand}$  = the light- and medium-duty fleet demand used in the IPM modeling discussed in Chapter 5

$Demand_{scenario}$  = the light- and medium-duty fleet demand calculated in OMEGA for the given year and scenario

OMEGA then uses the estimated U.S. generation to interpolate an emission rate for each pollutant using the IPM modeling results and the emission rates generated from them as described in Chapter 8.6.1. With the applicable emission rate, OMEGA then calculates an inventory for the given year as:

$$Tons_{pollutant} = Demand_{scenario} \times \frac{Rate_{pollutant;scenario}}{grams\ per\ ton}$$

Where,

$Tons_{pollutant}$  = The inventory tons (U.S. or metric) of the given pollutant

$Demand_{scenario}$  = the estimated EGU generation requirement to satisfy the light- and medium-duty fleet in the given year

$Rate_{pollutant;scenario}$  = the EGU emission rate for the given pollutant in the given scenario and year

$grams\ per\ ton$  = 1,000,000 for metric tons (GHGs) or 907,185 for US (short) tons (criteria air pollutants)

Importantly, the EGU inventories calculated in OMEGA represent EGU emissions associated with generating electricity for the light- and medium-duty fleet. The EGU inventories are not meant to reflect total US inventories. As such, any reductions or increases and percentage changes reflect changes in emissions associated only with generating electricity for the light- and medium-duty fleet, not the entire U.S.

#### 8.6.4.2 Refineries

We have made several updates to the calculation of refinery emissions relative to what was done in the DRIA. Those are:

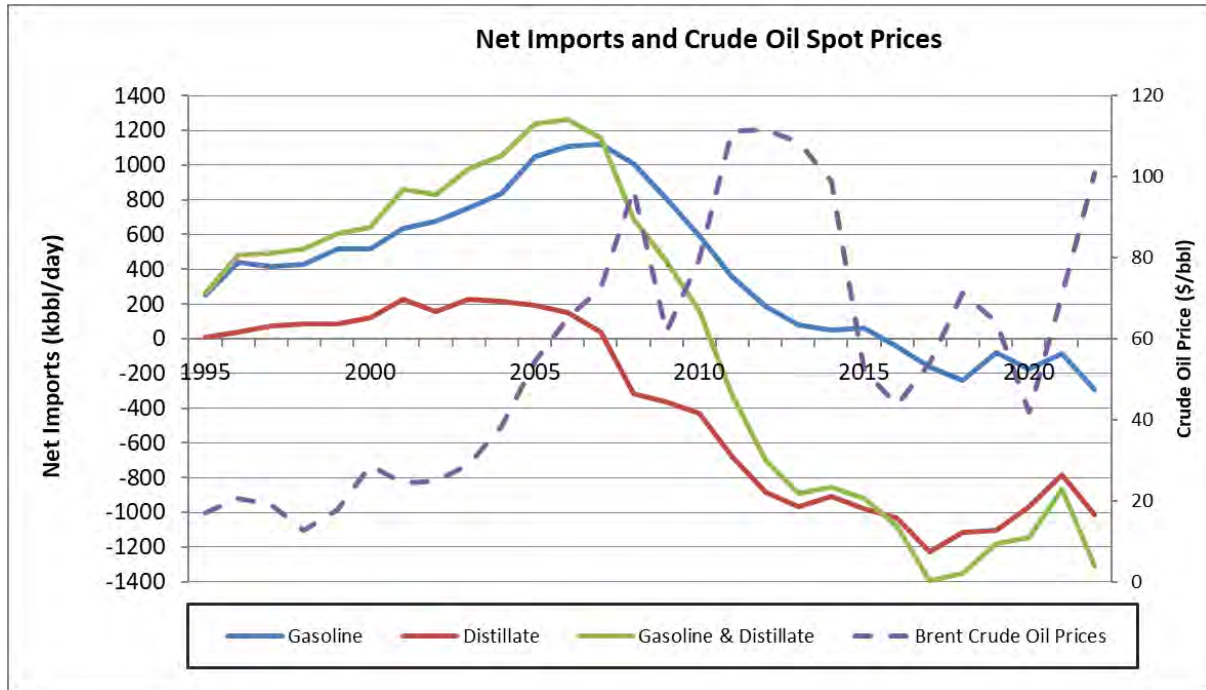
- 1) Refinery impacts make use of refinery inventories generated as part of our AQM as described in 8.6.2. We use those inventories to generate refinery emission rates and to establish a "context" inventory from which any impacts can be calculated; and,
- 2) We have updated our estimates of the impacts on U.S. refining resulting from our projected changes in domestic fuel demand.

Regarding number 2 above, while our NPRM analysis assumed that most of the reduced refined product demand caused by the proposed rulemaking would result in a similar reduction in U.S. refinery operations (93 percent), for reasons explained below, we also conducted a sensitivity case in which U.S. refineries would continue to operate at current crude oil capacities. If refineries continue to operate at their current capacities while demand for U.S. refined products is decreasing, it means that there would be reduced U.S. product imports and increased exports and U.S. refiners would continue to produce refined products, including coproducts such as asphalt and tires.

There are good economic reasons why U.S. refineries might continue to operate despite reduced U.S. product demand. In addition to coproducts as mentioned, the generally lower natural gas and crude oil prices available in the U.S. allows U.S. refineries to have lower production costs compared to other refinery regions around the world. The lower refinery production costs are attributed to the lower feedstock costs. (EIA Today in Energy 2014)

The higher profit margins experienced by U.S. refineries starting after 2005 would be expected to result in lower imports and higher exports and this is in fact is what has occurred. Figure 8-14 shows US gasoline and diesel fuel net imports over time and shows a decrease in

gasoline and diesel fuel net imports starting in 2006 associated with improved U.S. refinery margins. (EIA Imports by Area of Entry 2023) (EIA Spot Prices 2024) Note that the decrease in net imports could either be a decrease in imports or increase in exports.



**Figure 8-14: US Net Imports and Crude Oil Spot Prices.**

As Figure 8-14 also shows, the decrease in net imports corresponded with the increase in crude oil prices. Although not shown in the figure, the decrease in net gasoline imports also corresponded with the increase in blending more corn ethanol into gasoline, which on a volumetric basis could account for a large portion of the decline in net gasoline imports. Beginning in 2014, the rate of decreased net exports began to level off and perhaps was associated with simultaneous decrease in lower crude oil prices and leveling of ethanol demand.

Despite the favorable economic conditions for refiners here in the U.S., there were some refinery closures or conversions. There were a couple refinery closures in the last several years and they seem to be at least partially due to impacts from the COVID-19 pandemic when product demand, crude oil prices, and refinery margins plummeted. In addition to the pandemic, damage from a hurricane and a desire to pivot toward lower carbon fuel options were reasons provided by Shell for why it closed its Convent, Louisiana, refinery at the end of 2020—the Convent refinery had a crude oil refining capacity of 211,000 barrels per day (bbd). (Mosbrucker, Without a buyer, Shell may convert shuttered Convent refinery into alternative fuels facility 2021) Also citing significant hurricane damage in 2021, Phillips 66 decided to shutter its Belle Chasse, Louisiana, refinery—the Belle Chasse refinery had a crude oil refining capacity of 255,000 bpd. (1012 Industry Report 2021) Additionally, several refiners have opted to fully or partially convert their petroleum refineries to produce renewable diesel in recent years, including full conversions of the Marathon refinery in Dickinson, North Dakota, and the Holly Frontier

refineries in Artesia, New Mexico, and Cheyenne, Wyoming, and a partial conversion of the CVR refinery in Wynnewood, Oklahoma.

Despite better refinery margins in the U.S. overall, the simultaneous closure or conversion of some U.S. refineries in recent years makes the case that there is likely to continue to be the closure or conversion of some U.S. refineries that have lower margins or face other issues as demand for gasoline and diesel fuel declines in the U.S. The extent that U.S. refineries keep operating, shutdown, or are converted, is difficult to project since it depends on the economics of each particular refinery, the economic condition of the parent company, and strategy pursued by each company's board for providing a return to its shareholders.

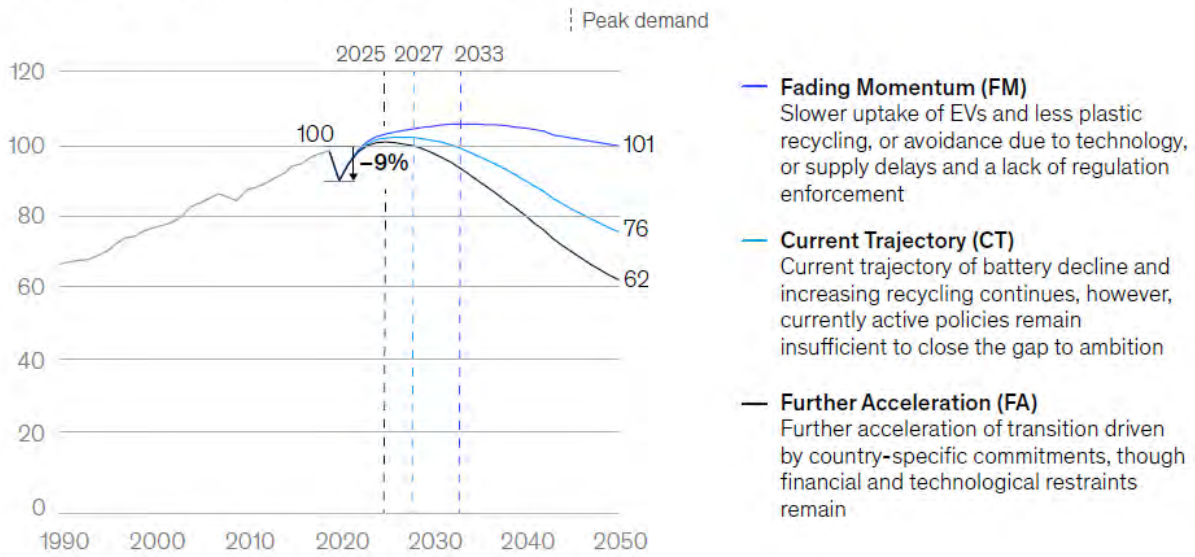
After careful consideration of the above, the history of decreased U.S. refinery net imports associated with the more desirable economic conditions for refiners in the U.S., and weighing this against the closure/conversion of some U.S. refineries over the past several years, we have changed our projection of how refinery emissions would be impacted by this rulemaking. Instead of estimating that U.S. refineries would largely reduce their production in response to reduced refined product demand as done in the NPRM, we are now estimating that U.S. refineries would respond at the midpoint of our range. Thus, of a certain reduction in U.S. refined fuel demand, U.S. refinery output would account for half of that reduced demand, while reduced net imports would account for the other half of that reduced demand.

A recently issued refining industry study seems to also support choosing a midpoint of the range. McKinsey and Company projected how increased electrification of transportation vehicles would affect refinery production in different refining production regions. (Cherry Ding 2022) As shown in Figure 8-15, the McKinsey study analyzed three different demand outlook scenarios which estimated three different rates of divestment from petroleum fuels. These demand outlook scenarios estimate reductions in crude oil refined by the world's refineries by nine distinct refinery sectors over time.

Exhibit 1

### Global liquids demand peaks before 2035 across scenarios.

Global liquids demand outlook by scenario, mbd



Disclaimer: Analysis conducted before the invasion of Ukraine in February 2022.  
Source: McKinsey Energy Insights' Global Energy Perspective 2022

**Figure 8-15: Global liquids demand; from (Cherry Ding 2022).**

It is necessary to link the demand scenarios in the above figure to the impacts on refinery throughput for the various world refining sectors. Per Figure 8-16, the study estimated refining impacts for 2030 and 2040 based on these demand scenarios.



Distillation capacity change by region, % of 2019 capacity

|                          | Fading momentum |            | Current trajectory |             | Further acceleration |              | Change, % |
|--------------------------|-----------------|------------|--------------------|-------------|----------------------|--------------|-----------|
|                          | 2030            | 2040       | 2030               | 2040        | 2030                 | 2040         |           |
| North America            | -5              | -8         | -7                 | -22         | -10                  | -41          | >10       |
| Latin America            | 8               | 8          | 8                  | 8           | 8                    | 5            | (0-10)    |
| Europe                   | -4              | -19        | -9                 | -46         | -14                  | -58          | (-10-0)   |
| FSU <sup>†</sup>         | 2               | 1          | -5                 | -17         | -8                   | -26          | <-10      |
| Africa                   | 12              | 12         | 12                 | 12          | 12                   | 9            |           |
| Middle East              | 25              | 25         | 21                 | 21          | 21                   | 19           |           |
| South and SE Asia        | 16              | 34         | 7                  | 11          | 6                    | -3           |           |
| China                    | 17              | 33         | 13                 | 11          | 8                    | -20          |           |
| Northeast Asia exc China | -3              | -10        | -6                 | -22         | -10                  | -30          |           |
| <b>Global, %</b>         | <b>6</b>        | <b>7</b>   | <b>2</b>           | <b>-9</b>   | <b>-1</b>            | <b>-23</b>   |           |
| <b>Global, mbd</b>       | <b>6.5</b>      | <b>7.7</b> | <b>2.3</b>         | <b>-9.5</b> | <b>-0.8</b>          | <b>-23.9</b> |           |

Disclaimer: Analysis conducted before the invasion of Ukraine in February 2022.  
<sup>†</sup>Former Soviet Union.  
 Source: McKinsey Energy Insights' Global Downstream Model 2022

**Figure 8-16: Distillation capacity change by region; from (Cherry Ding 2022).**

The report (Cherry Ding 2022) estimates that North American refining capacity would decrease by 41 percent in 2040 based on the Further Acceleration scenario, and this scenario estimates a 19 percent reduction in crude oil demand as shown in Figure 8-15. This final rulemaking is estimated to reduce gasoline and diesel fuel demand by about 40 billion gallons per year toward the end of the analysis period, which equates to 2.6 million barrels per day. Assuming that each barrel of gasoline/diesel fuel reduced equates to a barrel of crude oil reduced, this amounts to 2.5 percent of the world crude oil demand which was about 100 million barrels per day in 2019, the baseline year of the McKinsey analysis. We can estimate this rulemaking's impact on North American refining production based on this McKinsey study by comparing the 2.5 percent impact on crude oil production to the 19 percent estimated by the study—doing so projects that this rulemaking would have 2.5/19 impact on crude oil demand estimated in the study. Assuming that this smaller impact in world crude demand would impact North American refineries at the same rate in the study, then North American refineries would experience a  $2.5/19 \times 41$  percent decrease in crude oil throughput, which equates to 5.6 percent decrease in North American refinery throughput volume. North American refineries are estimated to refine around 22 to 25 million barrels of crude oil per day, so the reduction in crude oil refining would amount to 1.3 million barrels per day of decreased crude oil throughput at North American refineries. The 1.3 MMbbl/day decreased crude oil throughput is half of the estimated 2.6 MMbbl/day decrease in gasoline and diesel demand caused by the rulemaking. Despite some simplifying assumptions used in this analysis using the McKinsey study, it does seem to support our premise that of the decrease in U.S. refined product demand caused by this rulemaking, about half would be due to reduced U.S. refinery production, while the balance would be reduced net imports. As a sensitivity, EPA also estimated that 20 percent of reduced

domestic liquid fuel demand would result in reduced domestic refining. We chose this sensitivity as an estimate that falls between our central case where 50 percent of reduced demand would result in reduced domestic refining and a possible case in which this final rule would have no impact on domestic refining.

Regarding establishing a "context" inventory from which to estimate refinery impacts, we start with the EPA estimates of domestic refining as shown in Table 8-16. The refinery estimates shown in Table 8-16 reflect our estimates of refining throughput for all onroad gasoline and diesel fuel. But we want to estimate the refinery impacts associated with passenger cars, light trucks, and medium-duty vehicles. Therefore, we need context refinery throughput at a more granular level than simply gasoline and diesel. To do this, we first ran OMEGA using a no-action set of inputs to determine the gasoline and diesel fuel consumed by passenger cars, light trucks, and medium-duty vehicles. With those results, we could apportion the liquid fuel consumption as shown in Table 8-20.

**Table 8-20: Share of Gasoline and Diesel Fuel Consumed by Regulatory Class (unitless).**

| Calendar Year | Gasoline      |             |             | Diesel        |             |             |
|---------------|---------------|-------------|-------------|---------------|-------------|-------------|
|               | Passenger Car | Light Truck | Medium-Duty | Passenger Car | Light Truck | Medium-Duty |
| 2023          | 0.42          | 0.53        | 0.05        | 0.04          | 0.06        | 0.90        |
| 2030          | 0.32          | 0.62        | 0.07        | 0.02          | 0.11        | 0.87        |
| 2035          | 0.25          | 0.68        | 0.08        | 0.01          | 0.14        | 0.86        |
| 2040          | 0.21          | 0.71        | 0.08        | 0.00          | 0.15        | 0.85        |
| 2045          | 0.20          | 0.72        | 0.09        | 0.00          | 0.15        | 0.85        |
| 2050          | 0.19          | 0.72        | 0.09        | 0.00          | 0.15        | 0.85        |

We then estimated the share of onroad gasoline and diesel that are consumed by light- and medium-duty vehicles versus heavy-duty vehicles using data generated in support of our heavy-duty phase 3 final rule (Sherwood, OMEGA Refinery Data Inputs 2024). Those shares are shown in Table 8-21.

**Table 8-21: Share of Gasoline and Diesel fuel Consumed by Weight Classes (unitless).**

| Calendar Year | Light- and Medium-Duty |        | Heavy-Duty |        |
|---------------|------------------------|--------|------------|--------|
|               | Gasoline               | Diesel | Gasoline   | Diesel |
| 2023          | 0.98                   | 0.15   | 0.02       | 0.85   |
| 2030          | 0.97                   | 0.14   | 0.03       | 0.86   |
| 2035          | 0.97                   | 0.13   | 0.03       | 0.87   |
| 2040          | 0.97                   | 0.13   | 0.03       | 0.87   |
| 2045          | 0.97                   | 0.14   | 0.03       | 0.86   |

By applying the shares shown in Table 8-20 and Table 8-21 to the estimated refinery throughput shown in Table 8-16, we can get a better estimate of the context refinery throughput from which to measure changes in fuel consumption within any OMEGA session. Note that billion barrels per day are converted to gallons per year using 42 gallons per barrel and 365 days per year.

The refinery inventories are estimated on an annual basis by regulatory class and fuel type and by powertrain type. This latter element matters in the case of plug-in hybrid vehicles which consume both liquid fuel and electricity. This is discussed in more detail below.

For pure ICE, HEV, and PHEV powertrains that burn liquid fuel, we first calculate the context gallons as described above using the values in Table 8-16 multiplied by the appropriate apportionment shown in Table 8-20 and Table 8-21. We then determine the session fuel consumption each year for the given regulatory class and fuel type. The inventory in the given year for that regulatory class and fuel type is calculated as:

$$Inventory = \frac{EmissionRate \times [Gallons_{Context} - Impact \times (Gallons_{Context} - Gallons_{Session})]}{ConversionFactor}$$

Where,

*EmissionRate* = the specific pollutant rate as shown in Table 8-18 or Table 8-19 converted to grams per gallon

*Gallons<sub>Context</sub>* = the context gallons for the given regulatory class and fuel type by combining Table 8-16 with Table 8-20 and Table 8-21

*Gallons<sub>Session</sub>* = the session gallons for the given regulatory class and fuel type

*Impact* = the share of fuel savings that lead to reductions in domestic refining as described above.

*ConversionFactor* = a conversion to U.S. tons for criteria pollutants or metric tons for GHGs

Note that the calculations for refinery inventories are done for every session in an OMEGA run, including the No Action session. We then estimate the refinery impacts associated with any action set of standards relative to the no action session and not relative to the context session.

Regarding refinery impacts of pure ICE and HEVs versus PHEVs, we calculate the annual share of fuel consumed by PHEVs within a given regulatory class and fuel type relative to the share consumed by pure ICE and HEVs. We then apportion the refinery impacts according to those shares. For example, if PHEV gasoline cars consume 10 percent of the gasoline consumed by gasoline cars in a given year, then we apportion 10 percent of the inventory impacts to PHEVs and the remaining 90 percent to the pure ICE and HEV gasoline cars.

### **8.6.5 Calculating Vehicle Emission Inventories**

A similar process to that described above for upstream emissions is used for vehicle emissions with the exception that exhaust emission rates and both brake wear and tire wear emission rates are multiplied by the VMT<sub>policy</sub> value, while evaporative, spillage, and leakage emission rates are multiplied by the liquid-fuel consumption values described in Chapter 8.5.3. Exhaust emission inventories are then added to evaporative, spillage, and leakage emission inventories to arrive at vehicle emission inventories.

## 8.6.6 Summary of Inventories and Inventory Impacts

### 8.6.6.1 Greenhouse Gas Inventory Impacts

Note that, in the tables presented in this section, CO<sub>2</sub> equivalent (CO<sub>2</sub>e) values use 100-year global warming potential values of 28 and 265 for CH<sub>4</sub> and N<sub>2</sub>O, respectively. (IPCC 2014) Note also that any percent changes reflect changes in light- and medium-duty inventories relative to the No Action scenario and do not represent percent changes in total U.S. inventories.

**Table 8-22: Greenhouse gas emission inventory impacts, Final standards (million metric tons)\*.**

| Calendar Year | CO <sub>2</sub> |      |          | CH <sub>4</sub> |          |           | N <sub>2</sub> O |          |           | CO <sub>2</sub> e |      |          |
|---------------|-----------------|------|----------|-----------------|----------|-----------|------------------|----------|-----------|-------------------|------|----------|
|               | Vehicle         | EGU  | Refinery | Vehicle         | EGU      | Refinery  | Vehicle          | EGU      | Refinery  | Vehicle           | EGU  | Refinery |
| 2027          | -0.66           | 0.27 | -0.022   | -0.000059       | 0.000018 | -0.000013 | -0.000087        | 0.000025 | -0.000002 | -0.67             | 0.27 | -0.022   |
| 2028          | -4.5            | 1.2  | -0.16    | -0.000045       | 0.000078 | -0.000009 | -0.000051        | 0.000011 | -0.000013 | -4.5              | 1.2  | -0.16    |
| 2029          | -14             | 2.8  | -0.48    | -0.00016        | 0.00018  | -0.000028 | -0.00019         | 0.000024 | -0.000004 | -14               | 2.8  | -0.48    |
| 2030          | -29             | 5.6  | -0.97    | -0.00035        | 0.00035  | -0.000056 | -0.00043         | 0.000048 | -0.000082 | -29               | 5.6  | -0.97    |
| 2031          | -48             | 9.4  | -1.6     | -0.00059        | 0.00059  | -0.000094 | -0.00071         | 0.000079 | -0.000014 | -48               | 9.4  | -1.6     |
| 2032          | -68             | 13   | -2.4     | -0.00087        | 0.00079  | -0.00014  | -0.0011          | 0.00011  | -0.00002  | -69               | 13   | -2.4     |
| 2033          | -99             | 17   | -3.4     | -0.0013         | 0.001    | -0.0002   | -0.0016          | 0.00013  | -0.000029 | -99               | 17   | -3.4     |
| 2034          | -130            | 19   | -4.5     | -0.0018         | 0.0012   | -0.00026  | -0.0021          | 0.00015  | -0.000038 | -130              | 20   | -4.6     |
| 2035          | -160            | 22   | -5.7     | -0.0023         | 0.0013   | -0.00033  | -0.0026          | 0.00017  | -0.000048 | -160              | 22   | -5.7     |
| 2036          | -190            | 24   | -6.8     | -0.0028         | 0.0014   | -0.00039  | -0.0031          | 0.00018  | -0.000057 | -190              | 24   | -6.8     |
| 2037          | -210            | 24   | -7.8     | -0.0033         | 0.0014   | -0.00045  | -0.0036          | 0.00018  | -0.000065 | -220              | 24   | -7.8     |
| 2038          | -240            | 24   | -8.8     | -0.0038         | 0.0014   | -0.0005   | -0.004           | 0.00018  | -0.000074 | -240              | 24   | -8.8     |
| 2039          | -260            | 24   | -9.7     | -0.0043         | 0.0014   | -0.00056  | -0.0044          | 0.00018  | -0.000082 | -260              | 24   | -9.7     |
| 2040          | -290            | 23   | -11      | -0.0047         | 0.0014   | -0.00061  | -0.0048          | 0.00018  | -0.000089 | -290              | 23   | -11      |
| 2041          | -300            | 24   | -11      | -0.0052         | 0.0013   | -0.00065  | -0.0051          | 0.00017  | -0.000095 | -310              | 24   | -11      |
| 2042          | -320            | 24   | -12      | -0.0056         | 0.0013   | -0.00069  | -0.0055          | 0.00016  | -0.0001   | -320              | 24   | -12      |
| 2043          | -340            | 24   | -13      | -0.006          | 0.0012   | -0.00073  | -0.0058          | 0.00015  | -0.00011  | -340              | 24   | -13      |
| 2044          | -360            | 24   | -13      | -0.0063         | 0.0011   | -0.00076  | -0.006           | 0.00014  | -0.00011  | -360              | 24   | -13      |
| 2045          | -370            | 24   | -14      | -0.0066         | 0.001    | -0.00079  | -0.0063          | 0.00013  | -0.00012  | -370              | 24   | -14      |
| 2046          | -380            | 24   | -14      | -0.0069         | 0.00098  | -0.00082  | -0.0065          | 0.00012  | -0.00012  | -380              | 24   | -14      |
| 2047          | -390            | 23   | -15      | -0.0072         | 0.00095  | -0.00083  | -0.0066          | 0.00012  | -0.00012  | -390              | 23   | -15      |
| 2048          | -400            | 23   | -15      | -0.0074         | 0.00091  | -0.00085  | -0.0068          | 0.00011  | -0.00013  | -400              | 23   | -15      |
| 2049          | -400            | 22   | -15      | -0.0075         | 0.00086  | -0.00086  | -0.0069          | 0.0001   | -0.00013  | -400              | 22   | -15      |
| 2050          | -410            | 21   | -15      | -0.0076         | 0.00082  | -0.00087  | -0.0069          | 0.0001   | -0.00013  | -410              | 21   | -15      |
| 2051          | -410            | 21   | -16      | -0.0077         | 0.00083  | -0.00088  | -0.007           | 0.0001   | -0.00013  | -410              | 22   | -16      |
| 2052          | -410            | 22   | -16      | -0.0078         | 0.00083  | -0.00088  | -0.0071          | 0.0001   | -0.00013  | -410              | 22   | -16      |
| 2053          | -410            | 22   | -16      | -0.0078         | 0.00083  | -0.00088  | -0.0071          | 0.0001   | -0.00013  | -410              | 22   | -16      |
| 2054          | -410            | 21   | -16      | -0.0078         | 0.00083  | -0.00088  | -0.0071          | 0.0001   | -0.00013  | -410              | 22   | -16      |
| 2055          | -410            | 21   | -16      | -0.0079         | 0.00083  | -0.00088  | -0.0071          | 0.0001   | -0.00013  | -410              | 21   | -16      |
| Sum           | -7,500          | 550  | -280     | -0.13           | 0.027    | -0.016    | -0.13            | 0.0034   | -0.0023   | -7,500            | 550  | -280     |

\* Negative values reflect reductions; positive values increases.

**Table 8-23: Greenhouse gas emission inventory impacts, Alternative A  
(million metric tons)\*.**

| Calendar Year | CO2     |     |          | CH4       |         |           | N2O       |          |            | CO2e    |     |          |
|---------------|---------|-----|----------|-----------|---------|-----------|-----------|----------|------------|---------|-----|----------|
|               | Vehicle | EGU | Refinery | Vehicle   | EGU     | Refinery  | Vehicle   | EGU      | Refinery   | Vehicle | EGU | Refinery |
| 2027          | -7.3    | 2.  | -0.25    | -0.000078 | 0.00013 | -0.000015 | -0.000093 | 0.000018 | -0.0000021 | -7.4    | 2.  | -0.25    |
| 2028          | -20     | 5.3 | -0.7     | -0.00021  | 0.00035 | -0.000041 | -0.00024  | 0.000048 | -0.0000059 | -20     | 5.4 | -0.7     |
| 2029          | -37     | 7.3 | -1.3     | -0.0004   | 0.00046 | -0.000075 | -0.00046  | 0.000063 | -0.000011  | -37     | 7.3 | -1.3     |
| 2030          | -57     | 11  | -2.      | -0.00065  | 0.00067 | -0.00011  | -0.00077  | 0.00009  | -0.000017  | -58     | 11  | -2.      |
| 2031          | -79     | 14  | -2.7     | -0.00093  | 0.0009  | -0.00016  | -0.0011   | 0.00012  | -0.000023  | -79     | 15  | -2.7     |
| 2032          | -100    | 17  | -3.5     | -0.0012   | 0.0011  | -0.0002   | -0.0015   | 0.00014  | -0.000029  | -100    | 18  | -3.5     |
| 2033          | -130    | 21  | -4.5     | -0.0017   | 0.0013  | -0.00026  | -0.002    | 0.00017  | -0.000038  | -130    | 21  | -4.5     |
| 2034          | -160    | 23  | -5.6     | -0.0022   | 0.0014  | -0.00033  | -0.0025   | 0.00018  | -0.000047  | -160    | 23  | -5.7     |
| 2035          | -190    | 25  | -6.7     | -0.0027   | 0.0015  | -0.00039  | -0.003    | 0.0002   | -0.000057  | -190    | 25  | -6.8     |
| 2036          | -220    | 26  | -7.7     | -0.0032   | 0.0015  | -0.00045  | -0.0035   | 0.0002   | -0.000065  | -220    | 26  | -7.8     |
| 2037          | -240    | 27  | -8.7     | -0.0036   | 0.0016  | -0.0005   | -0.0039   | 0.0002   | -0.000073  | -240    | 27  | -8.7     |
| 2038          | -260    | 26  | -9.6     | -0.0041   | 0.0015  | -0.00055  | -0.0043   | 0.0002   | -0.000081  | -270    | 26  | -9.7     |
| 2039          | -290    | 25  | -11      | -0.0046   | 0.0015  | -0.00061  | -0.0047   | 0.00019  | -0.000089  | -290    | 26  | -11      |
| 2040          | -300    | 24  | -11      | -0.0051   | 0.0014  | -0.00065  | -0.005    | 0.00019  | -0.000095  | -310    | 24  | -11      |
| 2041          | -320    | 25  | -12      | -0.0054   | 0.0014  | -0.00069  | -0.0053   | 0.00018  | -0.0001    | -320    | 25  | -12      |
| 2042          | -340    | 25  | -13      | -0.0058   | 0.0013  | -0.00072  | -0.0056   | 0.00017  | -0.00011   | -340    | 25  | -13      |
| 2043          | -350    | 25  | -13      | -0.0062   | 0.0012  | -0.00076  | -0.0059   | 0.00016  | -0.00011   | -360    | 25  | -13      |
| 2044          | -370    | 25  | -14      | -0.0065   | 0.0011  | -0.00079  | -0.0062   | 0.00014  | -0.00012   | -370    | 25  | -14      |
| 2045          | -380    | 25  | -14      | -0.0068   | 0.001   | -0.00081  | -0.0063   | 0.00013  | -0.00012   | -380    | 25  | -14      |
| 2046          | -390    | 24  | -15      | -0.0071   | 0.00099 | -0.00083  | -0.0065   | 0.00012  | -0.00012   | -390    | 24  | -15      |
| 2047          | -400    | 24  | -15      | -0.0073   | 0.00096 | -0.00085  | -0.0067   | 0.00012  | -0.00013   | -400    | 24  | -15      |
| 2048          | -400    | 23  | -15      | -0.0075   | 0.00092 | -0.00087  | -0.0068   | 0.00011  | -0.00013   | -400    | 23  | -15      |
| 2049          | -410    | 22  | -16      | -0.0076   | 0.00087 | -0.00088  | -0.0069   | 0.00011  | -0.00013   | -410    | 22  | -16      |
| 2050          | -410    | 22  | -16      | -0.0077   | 0.00084 | -0.00089  | -0.007    | 0.0001   | -0.00013   | -420    | 22  | -16      |
| 2051          | -420    | 22  | -16      | -0.0078   | 0.00084 | -0.00089  | -0.0071   | 0.0001   | -0.00013   | -420    | 22  | -16      |
| 2052          | -420    | 22  | -16      | -0.0079   | 0.00084 | -0.0009   | -0.0071   | 0.0001   | -0.00013   | -420    | 22  | -16      |
| 2053          | -420    | 22  | -16      | -0.0079   | 0.00084 | -0.0009   | -0.0072   | 0.0001   | -0.00013   | -420    | 22  | -16      |
| 2054          | -420    | 22  | -16      | -0.0079   | 0.00084 | -0.0009   | -0.0072   | 0.0001   | -0.00013   | -420    | 22  | -16      |
| 2055          | -410    | 22  | -16      | -0.0079   | 0.00084 | -0.00089  | -0.0072   | 0.0001   | -0.00013   | -420    | 22  | -16      |
| Sum           | -7,900  | 600 | -300     | -0.14     | 0.03    | -0.017    | -0.13     | 0.0039   | -0.0025    | -8,000  | 600 | -300     |

\* Negative values reflect reductions; positive values increases.

**Table 8-24: Greenhouse gas emission inventory impacts, Alternative B  
(million metric tons) \*.**

| Calendar Year | CO2     |      |          | CH4       |          |            | N2O        |           |            | CO2e    |      |          |
|---------------|---------|------|----------|-----------|----------|------------|------------|-----------|------------|---------|------|----------|
|               | Vehicle | EGU  | Refinery | Vehicle   | EGU      | Refinery   | Vehicle    | EGU       | Refinery   | Vehicle | EGU  | Refinery |
| 2027          | -0.49   | 0.23 | -0.017   | -0.000004 | 0.000015 | -0.000001  | -0.0000069 | 0.0000021 | -0.0000001 | -0.49   | 0.23 | -0.017   |
| 2028          | -3.8    | 0.9  | -0.13    | -0.000035 | 0.000059 | -0.0000076 | -0.00004   | 0.0000082 | -0.0000011 | -3.8    | 0.9  | -0.13    |
| 2029          | -13     | 2.4  | -0.45    | -0.00015  | 0.00015  | -0.000026  | -0.00017   | 0.000021  | -0.0000038 | -13     | 2.4  | -0.45    |
| 2030          | -27     | 4.8  | -0.9     | -0.00033  | 0.0003   | -0.000052  | -0.0004    | 0.000041  | -0.0000076 | -27     | 4.8  | -0.91    |
| 2031          | -43     | 7.9  | -1.5     | -0.00054  | 0.00049  | -0.000085  | -0.00066   | 0.000066  | -0.000012  | -43     | 8.   | -1.5     |
| 2032          | -63     | 11   | -2.2     | -0.0008   | 0.00067  | -0.00012   | -0.00099   | 0.00009   | -0.000018  | -63     | 11   | -2.2     |
| 2033          | -90     | 15   | -3.1     | -0.0012   | 0.00089  | -0.00018   | -0.0014    | 0.00012   | -0.000026  | -90     | 15   | -3.1     |
| 2034          | -120    | 17   | -4.1     | -0.0016   | 0.001    | -0.00023   | -0.0018    | 0.00013   | -0.000034  | -120    | 17   | -4.1     |
| 2035          | -140    | 18   | -4.9     | -0.0019   | 0.0011   | -0.00029   | -0.0022    | 0.00014   | -0.000042  | -140    | 18   | -5.      |
| 2036          | -160    | 19   | -5.8     | -0.0023   | 0.0011   | -0.00033   | -0.0026    | 0.00015   | -0.000049  | -160    | 19   | -5.8     |
| 2037          | -180    | 20   | -6.6     | -0.0027   | 0.0011   | -0.00038   | -0.0029    | 0.00015   | -0.000055  | -180    | 20   | -6.6     |
| 2038          | -200    | 19   | -7.3     | -0.0031   | 0.0011   | -0.00042   | -0.0033    | 0.00015   | -0.000062  | -200    | 19   | -7.4     |
| 2039          | -220    | 19   | -8.1     | -0.0035   | 0.0011   | -0.00047   | -0.0036    | 0.00014   | -0.000068  | -220    | 19   | -8.1     |
| 2040          | -240    | 18   | -8.8     | -0.0038   | 0.0011   | -0.0005    | -0.0039    | 0.00014   | -0.000074  | -240    | 18   | -8.8     |
| 2041          | -250    | 18   | -9.4     | -0.0041   | 0.001    | -0.00054   | -0.0042    | 0.00013   | -0.000079  | -250    | 18   | -9.4     |
| 2042          | -270    | 19   | -10      | -0.0045   | 0.00098  | -0.00057   | -0.0045    | 0.00013   | -0.000084  | -270    | 19   | -10      |
| 2043          | -280    | 19   | -11      | -0.0048   | 0.00092  | -0.0006    | -0.0047    | 0.00012   | -0.000089  | -280    | 19   | -11      |
| 2044          | -300    | 19   | -11      | -0.0051   | 0.00085  | -0.00063   | -0.0049    | 0.00011   | -0.000093  | -300    | 19   | -11      |
| 2045          | -310    | 18   | -12      | -0.0054   | 0.00078  | -0.00066   | -0.0051    | 0.000096  | -0.000097  | -310    | 19   | -12      |
| 2046          | -320    | 18   | -12      | -0.0056   | 0.00076  | -0.00068   | -0.0053    | 0.000093  | -0.0001    | -320    | 18   | -12      |
| 2047          | -330    | 18   | -12      | -0.0058   | 0.00073  | -0.0007    | -0.0055    | 0.00009   | -0.0001    | -330    | 18   | -12      |
| 2048          | -330    | 17   | -13      | -0.006    | 0.00069  | -0.00071   | -0.0056    | 0.000085  | -0.00011   | -330    | 17   | -13      |
| 2049          | -340    | 17   | -13      | -0.0061   | 0.00066  | -0.00072   | -0.0057    | 0.00008   | -0.00011   | -340    | 17   | -13      |
| 2050          | -340    | 16   | -13      | -0.0062   | 0.00063  | -0.00073   | -0.0058    | 0.000076  | -0.00011   | -340    | 16   | -13      |
| 2051          | -340    | 16   | -13      | -0.0063   | 0.00063  | -0.00073   | -0.0059    | 0.000076  | -0.00011   | -340    | 16   | -13      |
| 2052          | -340    | 16   | -13      | -0.0064   | 0.00063  | -0.00074   | -0.0059    | 0.000076  | -0.00011   | -350    | 16   | -13      |
| 2053          | -340    | 16   | -13      | -0.0064   | 0.00063  | -0.00073   | -0.0059    | 0.000076  | -0.00011   | -350    | 16   | -13      |
| 2054          | -340    | 16   | -13      | -0.0064   | 0.00062  | -0.00073   | -0.006     | 0.000075  | -0.00011   | -350    | 16   | -13      |
| 2055          | -340    | 16   | -13      | -0.0064   | 0.00062  | -0.00073   | -0.006     | 0.000075  | -0.00011   | -340    | 16   | -13      |
| Sum           | -6,300  | 430  | -230     | -0.11     | 0.021    | -0.013     | -0.11      | 0.0027    | -0.002     | -6,300  | 430  | -230     |

\* Negative values reflect reductions; positive values increases.

**Table 8-25: Net Greenhouse gas emission inventory impacts, Final standards\*.**

| Calendar Year | Vehicle, EGU, Refinery<br>(Million metric tons per year) |           |            |        | % Change |         |         |         |
|---------------|--|-----------|------------|--------|----------|---------|---------|---------|
|               | CO2  | CH4       | N2O        | CO2e   | CO2      | CH4     | N2O     | CO2e    |
| 2027          | -0.41  | 0.000011  | -0.0000064 | -0.41  | -0.027%  | 0.022%  | -0.028% | -0.027% |
| 2028          | -3.5   | 0.000024  | -0.000042  | -3.5   | -0.24%   | 0.052%  | -0.19%  | -0.24%  |
| 2029          | -12  | -0.000011 | -0.00017   | -12    | -0.83%   | -0.026% | -0.77%  | -0.83%  |
| 2030          | -24  | -0.000057 | -0.00039   | -24    | -1.8%    | -0.14%  | -1.9%   | -1.8%   |
| 2031          | -40  | -0.0001   | -0.00064   | -40    | -3%      | -0.27%  | -3.2%   | -3%     |
| 2032          | -58  | -0.00023  | -0.00097   | -58    | -4.6%    | -0.64%  | -5%     | -4.6%   |
| 2033          | -85  | -0.00054  | -0.0015    | -86    | -7%      | -1.6%   | -7.8%   | -7%     |
| 2034          | -110   | -0.00092  | -0.002     | -110   | -9.5%    | -2.9%   | -11%    | -9.5%   |
| 2035          | -140   | -0.0013   | -0.0025    | -140   | -12%     | -4.5%   | -14%    | -12%    |
| 2036          | -170   | -0.0018   | -0.003     | -170   | -15%     | -6.3%   | -17%    | -15%    |
| 2037          | -200   | -0.0023   | -0.0035    | -200   | -18%     | -8.4%   | -19%    | -18%    |
| 2038          | -220   | -0.0029   | -0.0039    | -230   | -20%     | -11%    | -22%    | -20%    |
| 2039          | -250   | -0.0034   | -0.0043    | -250   | -23%     | -13%    | -24%    | -23%    |
| 2040          | -270   | -0.004    | -0.0047    | -270   | -25%     | -16%    | -27%    | -25%    |
| 2041          | -290   | -0.0045   | -0.0051    | -290   | -27%     | -18%    | -29%    | -27%    |
| 2042          | -310   | -0.005    | -0.0054    | -310   | -29%     | -21%    | -31%    | -29%    |
| 2043          | -330   | -0.0055   | -0.0057    | -330   | -31%     | -23%    | -33%    | -31%    |
| 2044          | -340   | -0.006    | -0.006     | -350   | -32%     | -26%    | -34%    | -32%    |
| 2045          | -360   | -0.0064   | -0.0063    | -360   | -34%     | -28%    | -35%    | -34%    |
| 2046          | -370   | -0.0068   | -0.0065    | -370   | -35%     | -30%    | -36%    | -35%    |
| 2047          | -380   | -0.007    | -0.0066    | -380   | -36%     | -31%    | -37%    | -36%    |
| 2048          | -390   | -0.0073   | -0.0068    | -390   | -36%     | -32%    | -37%    | -36%    |
| 2049          | -390   | -0.0075   | -0.0069    | -400   | -37%     | -33%    | -38%    | -37%    |
| 2050          | -400   | -0.0077   | -0.007     | -400   | -37%     | -34%    | -38%    | -37%    |
| 2051          | -400   | -0.0078   | -0.0071    | -410   | -37%     | -34%    | -38%    | -37%    |
| 2052          | -410   | -0.0078   | -0.0071    | -410   | -38%     | -34%    | -38%    | -38%    |
| 2053          | -410   | -0.0079   | -0.0071    | -410   | -38%     | -35%    | -38%    | -38%    |
| 2054          | -410   | -0.0079   | -0.0072    | -410   | -37%     | -34%    | -38%    | -37%    |
| 2055          | -410   | -0.0079   | -0.0072    | -410   | -37%     | -34%    | -38%    | -37%    |
| Sum           | -7,200   | -0.12     | -0.13      | -7,200 | -21%     | -15%    | -23%    | -21%    |

\* Negative values reflect reductions; positive values increases. Percent change reflects emissions associated with the light- and medium-duty fleet only, not total US EGU emissions.

**Table 8-26: Net Greenhouse gas emission inventory impacts, Alternative A\*.**

| Calendar Year | Vehicle, EGU, Refinery<br>(Million metric tons per year) |                 |                  |                   | % Change        |                 |                  |                   |
|---------------|--|-----------------|------------------|-------------------|-----------------|-----------------|------------------|-------------------|
|               | CO <sub>2</sub>  | CH <sub>4</sub> | N <sub>2</sub> O | CO <sub>2</sub> e | CO <sub>2</sub> | CH <sub>4</sub> | N <sub>2</sub> O | CO <sub>2</sub> e |
| 2027          | -5.6   | 0.00004         | -0.000076        | -5.6              | -0.37%          | 0.083%          | -0.33%           | -0.37%            |
| 2028          | -16  | 0.0001          | -0.00019         | -16               | -1.1%           | 0.23%           | -0.87%           | -1.1%             |
| 2029          | -31  | -0.000012       | -0.00041         | -31               | -2.2%           | -0.029%         | -1.9%            | -2.2%             |
| 2030          | -49  | -0.000096       | -0.0007          | -49               | -3.6%           | -0.24%          | -3.3%            | -3.6%             |
| 2031          | -67  | -0.00019        | -0.00099         | -67               | -5.1%           | -0.49%          | -4.9%            | -5.1%             |
| 2032          | -86  | -0.00037        | -0.0013          | -87               | -6.8%           | -1%             | -6.9%            | -6.8%             |
| 2033          | -110   | -0.00071        | -0.0018          | -110              | -9.2%           | -2.1%           | -9.6%            | -9.2%             |
| 2034          | -140   | -0.0011         | -0.0023          | -140              | -12%            | -3.6%           | -13%             | -12%              |
| 2035          | -170   | -0.0016         | -0.0028          | -170              | -15%            | -5.3%           | -16%             | -15%              |
| 2036          | -200   | -0.0021         | -0.0033          | -200              | -17%            | -7.2%           | -18%             | -17%              |
| 2037          | -220   | -0.0026         | -0.0038          | -220              | -20%            | -9.4%           | -21%             | -20%              |
| 2038          | -250   | -0.0032         | -0.0042          | -250              | -22%            | -12%            | -24%             | -22%              |
| 2039          | -270   | -0.0037         | -0.0046          | -270              | -25%            | -15%            | -26%             | -25%              |
| 2040          | -290   | -0.0043         | -0.0049          | -290              | -27%            | -17%            | -28%             | -27%              |
| 2041          | -310   | -0.0048         | -0.0053          | -310              | -29%            | -20%            | -30%             | -29%              |
| 2042          | -330   | -0.0052         | -0.0056          | -330              | -31%            | -22%            | -32%             | -31%              |
| 2043          | -340   | -0.0057         | -0.0059          | -340              | -32%            | -24%            | -33%             | -32%              |
| 2044          | -360   | -0.0062         | -0.0061          | -360              | -34%            | -27%            | -35%             | -34%              |
| 2045          | -370   | -0.0066         | -0.0063          | -370              | -35%            | -29%            | -36%             | -35%              |
| 2046          | -380   | -0.0069         | -0.0065          | -380              | -36%            | -30%            | -37%             | -36%              |
| 2047          | -390   | -0.0072         | -0.0067          | -390              | -36%            | -32%            | -37%             | -36%              |
| 2048          | -400   | -0.0074         | -0.0068          | -400              | -37%            | -33%            | -38%             | -37%              |
| 2049          | -400   | -0.0076         | -0.007           | -400              | -38%            | -34%            | -38%             | -38%              |
| 2050          | -410   | -0.0078         | -0.0071          | -410              | -38%            | -34%            | -39%             | -38%              |
| 2051          | -410   | -0.0078         | -0.0071          | -410              | -38%            | -35%            | -39%             | -38%              |
| 2052          | -410   | -0.0079         | -0.0072          | -410              | -38%            | -35%            | -39%             | -38%              |
| 2053          | -410   | -0.008          | -0.0072          | -420              | -38%            | -35%            | -39%             | -38%              |
| 2054          | -410   | -0.008          | -0.0072          | -410              | -38%            | -35%            | -39%             | -38%              |
| 2055          | -410   | -0.008          | -0.0072          | -410              | -37%            | -35%            | -38%             | -37%              |
| Sum           | -7,600   | -0.12           | -0.13            | -7,700            | -23%            | -15%            | -24%             | -23%              |

\* Negative values reflect reductions; positive values increases. Percent change reflects emissions associated with the light- and medium-duty fleet only, not total US EGU emissions.



**Table 8-27: Net Greenhouse gas emission inventory impacts, Alternative B\*.**

| Calendar Year | Vehicle, EGU, Refinery<br>(Million metric tons per year) |                 |                  |                   | % Change        |                 |                  |                   |
|---------------|--|-----------------|------------------|-------------------|-----------------|-----------------|------------------|-------------------|
|               | CO <sub>2</sub>  | CH <sub>4</sub> | N <sub>2</sub> O | CO <sub>2</sub> e | CO <sub>2</sub> | CH <sub>4</sub> | N <sub>2</sub> O | CO <sub>2</sub> e |
| 2027          | -0.28  | 0.00001         | -0.0000049       | -0.28             | -0.018%         | 0.021%          | -0.022%          | -0.018%           |
| 2028          | -3   | 0.000016        | -0.000033        | -3                | -0.21%          | 0.036%          | -0.15%           | -0.21%            |
| 2029          | -11  | -0.000017       | -0.00015         | -11               | -0.78%          | -0.04%          | -0.71%           | -0.78%            |
| 2030          | -23  | -0.000078       | -0.00037         | -23               | -1.7%           | -0.2%           | -1.8%            | -1.7%             |
| 2031          | -37  | -0.00013        | -0.0006          | -37               | -2.8%           | -0.35%          | -3%              | -2.8%             |
| 2032          | -54  | -0.00026        | -0.00092         | -54               | -4.3%           | -0.73%          | -4.7%            | -4.3%             |
| 2033          | -78  | -0.00048        | -0.0013          | -79               | -6.4%           | -1.4%           | -7%              | -6.4%             |
| 2034          | -100   | -0.00078        | -0.0017          | -100              | -8.6%           | -2.4%           | -9.3%            | -8.6%             |
| 2035          | -130   | -0.0011         | -0.0021          | -130              | -11%            | -3.7%           | -12%             | -11%              |
| 2036          | -150   | -0.0015         | -0.0025          | -150              | -13%            | -5.2%           | -14%             | -13%              |
| 2037          | -170   | -0.0019         | -0.0029          | -170              | -15%            | -6.9%           | -16%             | -15%              |
| 2038          | -190   | -0.0023         | -0.0032          | -190              | -17%            | -8.9%           | -18%             | -17%              |
| 2039          | -210   | -0.0028         | -0.0035          | -210              | -19%            | -11%            | -20%             | -19%              |
| 2040          | -230   | -0.0033         | -0.0039          | -230              | -21%            | -13%            | -22%             | -21%              |
| 2041          | -240   | -0.0037         | -0.0041          | -240              | -23%            | -15%            | -23%             | -23%              |
| 2042          | -260   | -0.0041         | -0.0044          | -260              | -24%            | -17%            | -25%             | -24%              |
| 2043          | -270   | -0.0045         | -0.0047          | -280              | -26%            | -19%            | -27%             | -26%              |
| 2044          | -290   | -0.0049         | -0.0049          | -290              | -27%            | -21%            | -28%             | -27%              |
| 2045          | -300   | -0.0053         | -0.0051          | -300              | -28%            | -23%            | -29%             | -28%              |
| 2046          | -310   | -0.0055         | -0.0053          | -310              | -29%            | -24%            | -30%             | -29%              |
| 2047          | -320   | -0.0058         | -0.0055          | -320              | -30%            | -25%            | -31%             | -30%              |
| 2048          | -330   | -0.006          | -0.0056          | -330              | -31%            | -26%            | -31%             | -31%              |
| 2049          | -330   | -0.0062         | -0.0057          | -330              | -31%            | -27%            | -32%             | -31%              |
| 2050          | -340   | -0.0063         | -0.0058          | -340              | -31%            | -28%            | -32%             | -31%              |
| 2051          | -340   | -0.0064         | -0.0059          | -340              | -32%            | -28%            | -32%             | -32%              |
| 2052          | -340   | -0.0065         | -0.006           | -340              | -32%            | -28%            | -32%             | -32%              |
| 2053          | -340   | -0.0065         | -0.006           | -340              | -31%            | -29%            | -32%             | -31%              |
| 2054          | -340   | -0.0065         | -0.006           | -340              | -31%            | -29%            | -32%             | -31%              |
| 2055          | -340   | -0.0066         | -0.006           | -340              | -31%            | -29%            | -32%             | -31%              |
| Sum           | -6,100   | -0.099          | -0.1             | -6,100            | -18%            | -12%            | -19%             | -18%              |

\* Negative values reflect reductions; positive values increases. Percent change reflects emissions associated with the light- and medium-duty fleet only, not total US EGU emissions.

### 8.6.6.2 Criteria Air Pollutant Inventory Impacts

**Table 8-28: Criteria air pollutant impacts from vehicles, Final standards.  
(US tons per year)**

| Calendar Year | PM2.5  | NOX     | NMOG     | SOX    | CO         |
|---------------|--------|---------|----------|--------|------------|
| 2027          | -110   | 14      | -37      | -2.9   | -410       |
| 2028          | -290   | -88     | -470     | -21    | -6,700     |
| 2029          | -510   | -580    | -1,700   | -66    | -25,000    |
| 2030          | -860   | -1,600  | -3,700   | -130   | -54,000    |
| 2031          | -1,200 | -2,700  | -6,400   | -220   | -91,000    |
| 2032          | -1,600 | -4,300  | -9,400   | -320   | -130,000   |
| 2033          | -2,000 | -6,400  | -14,000  | -460   | -210,000   |
| 2034          | -2,500 | -8,500  | -19,000  | -600   | -290,000   |
| 2035          | -2,900 | -11,000 | -25,000  | -750   | -380,000   |
| 2036          | -3,300 | -13,000 | -31,000  | -890   | -470,000   |
| 2037          | -3,800 | -15,000 | -37,000  | -1,000 | -570,000   |
| 2038          | -4,300 | -17,000 | -43,000  | -1,100 | -670,000   |
| 2039          | -4,800 | -19,000 | -48,000  | -1,200 | -770,000   |
| 2040          | -5,300 | -22,000 | -54,000  | -1,300 | -870,000   |
| 2041          | -5,700 | -23,000 | -60,000  | -1,400 | -960,000   |
| 2042          | -6,100 | -25,000 | -67,000  | -1,500 | -1,100,000 |
| 2043          | -6,400 | -27,000 | -73,000  | -1,600 | -1,200,000 |
| 2044          | -6,700 | -28,000 | -80,000  | -1,700 | -1,300,000 |
| 2045          | -7,000 | -30,000 | -85,000  | -1,700 | -1,300,000 |
| 2046          | -7,300 | -31,000 | -92,000  | -1,800 | -1,400,000 |
| 2047          | -7,500 | -32,000 | -99,000  | -1,800 | -1,500,000 |
| 2048          | -7,700 | -32,000 | -110,000 | -1,900 | -1,600,000 |
| 2049          | -7,900 | -33,000 | -110,000 | -1,900 | -1,600,000 |
| 2050          | -8,000 | -33,000 | -120,000 | -1,900 | -1,600,000 |
| 2051          | -8,200 | -34,000 | -120,000 | -1,900 | -1,700,000 |
| 2052          | -8,300 | -34,000 | -130,000 | -1,900 | -1,700,000 |
| 2053          | -8,300 | -34,000 | -130,000 | -1,900 | -1,700,000 |
| 2054          | -8,400 | -35,000 | -140,000 | -1,900 | -1,700,000 |
| 2055          | -8,500 | -35,000 | -140,000 | -1,900 | -1,700,000 |

\* Negative values reflect reductions; positive values increases.

**Table 8-29: Criteria air pollutant impacts from vehicles, Alternative A  
(US tons per year).**

| Calendar Year | PM <sub>2.5</sub> | NO <sub>X</sub> | NMOG     | SO <sub>X</sub> | CO         |
|---------------|-------------------|-----------------|----------|-----------------|------------|
| 2027          | -130              | -190            | -830     | -34             | -13,000    |
| 2028          | -330              | -550            | -2,300   | -95             | -34,000    |
| 2029          | -560              | -1,300          | -4,400   | -180            | -65,000    |
| 2030          | -910              | -2,500          | -7,200   | -270            | -100,000   |
| 2031          | -1,300            | -3,800          | -10,000  | -370            | -150,000   |
| 2032          | -1,600            | -5,500          | -14,000  | -470            | -200,000   |
| 2033          | -2,100            | -7,600          | -19,000  | -600            | -280,000   |
| 2034          | -2,600            | -9,800          | -24,000  | -750            | -370,000   |
| 2035          | -3,000            | -12,000         | -29,000  | -880            | -450,000   |
| 2036          | -3,400            | -14,000         | -35,000  | -1,000          | -550,000   |
| 2037          | -3,900            | -16,000         | -42,000  | -1,100          | -650,000   |
| 2038          | -4,400            | -19,000         | -48,000  | -1,200          | -750,000   |
| 2039          | -4,900            | -21,000         | -54,000  | -1,300          | -850,000   |
| 2040          | -5,300            | -23,000         | -59,000  | -1,400          | -940,000   |
| 2041          | -5,700            | -24,000         | -65,000  | -1,500          | -1,000,000 |
| 2042          | -6,100            | -26,000         | -71,000  | -1,600          | -1,100,000 |
| 2043          | -6,400            | -27,000         | -78,000  | -1,700          | -1,200,000 |
| 2044          | -6,800            | -29,000         | -84,000  | -1,700          | -1,300,000 |
| 2045          | -7,000            | -30,000         | -89,000  | -1,800          | -1,400,000 |
| 2046          | -7,300            | -31,000         | -97,000  | -1,800          | -1,500,000 |
| 2047          | -7,500            | -32,000         | -100,000 | -1,900          | -1,500,000 |
| 2048          | -7,700            | -33,000         | -110,000 | -1,900          | -1,600,000 |
| 2049          | -7,900            | -33,000         | -120,000 | -1,900          | -1,600,000 |
| 2050          | -8,100            | -34,000         | -120,000 | -1,900          | -1,700,000 |
| 2051          | -8,200            | -34,000         | -130,000 | -1,900          | -1,700,000 |
| 2052          | -8,300            | -34,000         | -130,000 | -2,000          | -1,700,000 |
| 2053          | -8,400            | -35,000         | -140,000 | -2,000          | -1,700,000 |
| 2054          | -8,400            | -35,000         | -140,000 | -2,000          | -1,800,000 |
| 2055          | -8,500            | -35,000         | -140,000 | -1,900          | -1,800,000 |

\* Negative values reflect reductions; positive values increases.

**Table 8-30: Criteria air pollutant impacts from vehicles, Alternative B  
(US tons per year).**

| Calendar Year | PM <sub>2.5</sub> | NO <sub>X</sub> | NMOG     | SO <sub>X</sub> | CO         |
|---------------|-------------------|-----------------|----------|-----------------|------------|
| 2027          | -110              | 19              | -17      | -2.1            | -110       |
| 2028          | -290              | -65             | -380     | -18             | -5,100     |
| 2029          | -500              | -540            | -1,600   | -61             | -23,000    |
| 2030          | -860              | -1,500          | -3,500   | -120            | -50,000    |
| 2031          | -1,200            | -2,500          | -5,800   | -200            | -83,000    |
| 2032          | -1,600            | -4,000          | -8,600   | -290            | -120,000   |
| 2033          | -2,000            | -5,900          | -13,000  | -420            | -190,000   |
| 2034          | -2,500            | -7,600          | -17,000  | -540            | -250,000   |
| 2035          | -2,900            | -9,300          | -21,000  | -650            | -310,000   |
| 2036          | -3,300            | -11,000         | -25,000  | -760            | -380,000   |
| 2037          | -3,800            | -13,000         | -30,000  | -850            | -450,000   |
| 2038          | -4,300            | -15,000         | -35,000  | -950            | -530,000   |
| 2039          | -4,800            | -16,000         | -39,000  | -1,000          | -610,000   |
| 2040          | -5,300            | -18,000         | -44,000  | -1,100          | -690,000   |
| 2041          | -5,700            | -20,000         | -48,000  | -1,200          | -760,000   |
| 2042          | -6,100            | -21,000         | -54,000  | -1,300          | -830,000   |
| 2043          | -6,400            | -22,000         | -59,000  | -1,300          | -910,000   |
| 2044          | -6,700            | -24,000         | -64,000  | -1,400          | -980,000   |
| 2045          | -7,000            | -25,000         | -69,000  | -1,400          | -1,100,000 |
| 2046          | -7,300            | -26,000         | -75,000  | -1,500          | -1,100,000 |
| 2047          | -7,500            | -27,000         | -80,000  | -1,500          | -1,200,000 |
| 2048          | -7,700            | -27,000         | -85,000  | -1,600          | -1,200,000 |
| 2049          | -7,900            | -28,000         | -90,000  | -1,600          | -1,300,000 |
| 2050          | -8,000            | -28,000         | -94,000  | -1,600          | -1,300,000 |
| 2051          | -8,100            | -29,000         | -98,000  | -1,600          | -1,300,000 |
| 2052          | -8,200            | -29,000         | -100,000 | -1,600          | -1,400,000 |
| 2053          | -8,300            | -29,000         | -110,000 | -1,600          | -1,400,000 |
| 2054          | -8,400            | -30,000         | -110,000 | -1,600          | -1,400,000 |
| 2055          | -8,400            | -30,000         | -110,000 | -1,600          | -1,400,000 |

\* Negative values reflect reductions; positive values increases.

**Table 8-31: Criteria air pollutant impacts from EGUs and refineries, Final standards (US tons per year) \*.**

| Calendar Year | EGU   |       |       |       | Refinery |        |        |        |        |
|---------------|-------|-------|-------|-------|----------|--------|--------|--------|--------|
|               | PM2.5 | NOX   | NMOG  | SOX   | PM2.5    | NOX    | NMOG   | SOX    | CO     |
| 2027          | 17    | 110   | 7.8   | 110   | -2.6     | -11    | -7.6   | -3.2   | -7.1   |
| 2028          | 73    | 500   | 34    | 490   | -18      | -74    | -53    | -22    | -49    |
| 2029          | 180   | 1,200 | 92    | 1,000 | -55      | -230   | -160   | -68    | -150   |
| 2030          | 370   | 2,200 | 190   | 1,700 | -110     | -460   | -330   | -140   | -310   |
| 2031          | 630   | 3,700 | 310   | 2,800 | -190     | -780   | -550   | -230   | -520   |
| 2032          | 860   | 4,900 | 430   | 3,700 | -270     | -1,100 | -800   | -340   | -740   |
| 2033          | 1,100 | 6,200 | 570   | 4,600 | -390     | -1,600 | -1,200 | -490   | -1,100 |
| 2034          | 1,400 | 7,300 | 700   | 5,100 | -520     | -2,200 | -1,500 | -650   | -1,400 |
| 2035          | 1,600 | 8,000 | 820   | 5,300 | -650     | -2,700 | -1,900 | -810   | -1,800 |
| 2036          | 1,700 | 8,500 | 900   | 5,500 | -780     | -3,200 | -2,300 | -970   | -2,100 |
| 2037          | 1,800 | 8,600 | 950   | 5,400 | -890     | -3,700 | -2,600 | -1,100 | -2,500 |
| 2038          | 1,800 | 8,500 | 980   | 5,200 | -1,000   | -4,200 | -3,000 | -1,200 | -2,800 |
| 2039          | 1,800 | 8,200 | 1,000 | 4,800 | -1,100   | -4,600 | -3,300 | -1,400 | -3,100 |
| 2040          | 1,800 | 7,900 | 1,000 | 4,300 | -1,200   | -5,100 | -3,600 | -1,500 | -3,300 |
| 2041          | 1,800 | 7,800 | 1,000 | 4,100 | -1,300   | -5,400 | -3,800 | -1,600 | -3,600 |
| 2042          | 1,800 | 7,600 | 1,100 | 3,800 | -1,400   | -5,800 | -4,100 | -1,700 | -3,800 |
| 2043          | 1,800 | 7,400 | 1,100 | 3,500 | -1,500   | -6,100 | -4,300 | -1,800 | -4,000 |
| 2044          | 1,800 | 7,000 | 1,100 | 3,000 | -1,500   | -6,400 | -4,500 | -1,900 | -4,200 |
| 2045          | 1,700 | 6,600 | 1,100 | 2,600 | -1,600   | -6,600 | -4,600 | -2,000 | -4,400 |
| 2046          | 1,700 | 6,500 | 1,000 | 2,400 | -1,600   | -6,800 | -4,800 | -2,000 | -4,500 |
| 2047          | 1,600 | 6,300 | 1,000 | 2,100 | -1,700   | -7,000 | -4,900 | -2,100 | -4,600 |
| 2048          | 1,600 | 6,000 | 1,000 | 1,800 | -1,700   | -7,100 | -5,000 | -2,100 | -4,700 |
| 2049          | 1,500 | 5,700 | 960   | 1,500 | -1,700   | -7,200 | -5,000 | -2,100 | -4,800 |
| 2050          | 1,500 | 5,500 | 940   | 1,300 | -1,700   | -7,300 | -5,100 | -2,200 | -4,800 |
| 2051          | 1,500 | 5,600 | 940   | 1,300 | -1,800   | -7,400 | -5,100 | -2,200 | -4,800 |
| 2052          | 1,500 | 5,600 | 950   | 1,300 | -1,800   | -7,400 | -5,200 | -2,200 | -4,900 |
| 2053          | 1,500 | 5,600 | 950   | 1,300 | -1,800   | -7,400 | -5,200 | -2,200 | -4,900 |
| 2054          | 1,500 | 5,600 | 940   | 1,300 | -1,800   | -7,400 | -5,100 | -2,200 | -4,900 |
| 2055          | 1,500 | 5,500 | 930   | 1,300 | -1,800   | -7,400 | -5,100 | -2,200 | -4,900 |

\* Negative values reflect reductions; positive values increases. Data were not available for calculating CO inventories from EGUs.

**Table 8-32: Criteria air pollutant impacts from EGUs and refineries, Alternative A (US tons per year) \*.**

| Calendar Year | EGU   |       |       |       | Refinery |        |        |        |        |
|---------------|-------|-------|-------|-------|----------|--------|--------|--------|--------|
|               | PM2.5 | NOX   | NMOG  | SOX   | PM2.5    | NOX    | NMOG   | SOX    | CO     |
| 2027          | 120   | 850   | 57    | 840   | -29      | -120   | -86    | -36    | -80    |
| 2028          | 330   | 2,200 | 150   | 2,200 | -80      | -340   | -240   | -100   | -220   |
| 2029          | 480   | 3,100 | 240   | 2,600 | -150     | -610   | -440   | -180   | -410   |
| 2030          | 700   | 4,200 | 360   | 3,300 | -230     | -940   | -670   | -280   | -620   |
| 2031          | 960   | 5,600 | 480   | 4,400 | -310     | -1,300 | -920   | -390   | -860   |
| 2032          | 1,200 | 6,700 | 590   | 5,100 | -400     | -1,700 | -1,200 | -500   | -1,100 |
| 2033          | 1,400 | 7,900 | 710   | 5,800 | -520     | -2,200 | -1,500 | -640   | -1,400 |
| 2034          | 1,600 | 8,700 | 830   | 6,100 | -640     | -2,700 | -1,900 | -800   | -1,800 |
| 2035          | 1,800 | 9,300 | 940   | 6,200 | -770     | -3,200 | -2,300 | -960   | -2,100 |
| 2036          | 1,900 | 9,500 | 1,000 | 6,200 | -890     | -3,700 | -2,600 | -1,100 | -2,400 |
| 2037          | 1,900 | 9,500 | 1,000 | 6,000 | -990     | -4,200 | -2,900 | -1,200 | -2,700 |
| 2038          | 2,000 | 9,200 | 1,100 | 5,600 | -1,100   | -4,600 | -3,300 | -1,400 | -3,000 |
| 2039          | 1,900 | 8,800 | 1,100 | 5,200 | -1,200   | -5,000 | -3,600 | -1,500 | -3,300 |
| 2040          | 1,900 | 8,300 | 1,100 | 4,600 | -1,300   | -5,400 | -3,800 | -1,600 | -3,600 |
| 2041          | 1,900 | 8,100 | 1,100 | 4,300 | -1,400   | -5,700 | -4,000 | -1,700 | -3,800 |
| 2042          | 1,900 | 7,900 | 1,100 | 4,000 | -1,400   | -6,000 | -4,200 | -1,800 | -4,000 |
| 2043          | 1,800 | 7,600 | 1,100 | 3,600 | -1,500   | -6,300 | -4,500 | -1,900 | -4,200 |
| 2044          | 1,800 | 7,200 | 1,100 | 3,100 | -1,600   | -6,600 | -4,600 | -2,000 | -4,300 |
| 2045          | 1,700 | 6,700 | 1,100 | 2,600 | -1,600   | -6,800 | -4,800 | -2,000 | -4,500 |
| 2046          | 1,700 | 6,500 | 1,100 | 2,400 | -1,700   | -7,000 | -4,900 | -2,100 | -4,600 |
| 2047          | 1,700 | 6,300 | 1,000 | 2,100 | -1,700   | -7,100 | -5,000 | -2,100 | -4,700 |
| 2048          | 1,600 | 6,100 | 1,000 | 1,900 | -1,700   | -7,300 | -5,100 | -2,100 | -4,800 |
| 2049          | 1,600 | 5,800 | 980   | 1,600 | -1,800   | -7,400 | -5,100 | -2,200 | -4,800 |
| 2050          | 1,500 | 5,600 | 950   | 1,300 | -1,800   | -7,400 | -5,200 | -2,200 | -4,900 |
| 2051          | 1,500 | 5,600 | 950   | 1,300 | -1,800   | -7,500 | -5,200 | -2,200 | -4,900 |
| 2052          | 1,500 | 5,700 | 960   | 1,300 | -1,800   | -7,500 | -5,200 | -2,200 | -4,900 |
| 2053          | 1,500 | 5,700 | 960   | 1,300 | -1,800   | -7,500 | -5,200 | -2,200 | -5,000 |
| 2054          | 1,500 | 5,600 | 950   | 1,300 | -1,800   | -7,500 | -5,200 | -2,200 | -4,900 |
| 2055          | 1,500 | 5,600 | 940   | 1,300 | -1,800   | -7,400 | -5,200 | -2,200 | -4,900 |

\* Negative values reflect reductions; positive values increases. Data were not available for calculating CO inventories from EGUs.

**Table 8-33: Criteria air pollutant impacts from EGUs and refineries, Alternative B  
(US tons per year) \***

| Calendar Year | EGU   |       |      |       | Refinery |        |        |        |        |
|---------------|-------|-------|------|-------|----------|--------|--------|--------|--------|
|               | PM2.5 | NOX   | NMOG | SOX   | PM2.5    | NOX    | NMOG   | SOX    | CO     |
| 2027          | 14    | 96    | 6.5  | 96    | -1.9     | -7.9   | -5.6   | -2.4   | -5.2   |
| 2028          | 56    | 380   | 26   | 380   | -15      | -63    | -45    | -19    | -42    |
| 2029          | 160   | 1,000 | 80   | 880   | -51      | -210   | -150   | -64    | -140   |
| 2030          | 320   | 1,900 | 160  | 1,500 | -100     | -430   | -310   | -130   | -290   |
| 2031          | 530   | 3,100 | 260  | 2,400 | -170     | -700   | -500   | -210   | -470   |
| 2032          | 740   | 4,200 | 370  | 3,200 | -250     | -1,000 | -730   | -310   | -680   |
| 2033          | 1,000 | 5,600 | 510  | 4,100 | -360     | -1,500 | -1,100 | -440   | -990   |
| 2034          | 1,200 | 6,400 | 610  | 4,400 | -460     | -1,900 | -1,400 | -580   | -1,300 |
| 2035          | 1,300 | 6,700 | 690  | 4,400 | -560     | -2,400 | -1,700 | -700   | -1,600 |
| 2036          | 1,400 | 7,000 | 740  | 4,500 | -660     | -2,800 | -2,000 | -820   | -1,800 |
| 2037          | 1,400 | 7,000 | 770  | 4,300 | -750     | -3,100 | -2,200 | -940   | -2,100 |
| 2038          | 1,500 | 6,800 | 790  | 4,100 | -840     | -3,500 | -2,500 | -1,000 | -2,300 |
| 2039          | 1,400 | 6,600 | 800  | 3,800 | -930     | -3,900 | -2,700 | -1,200 | -2,600 |
| 2040          | 1,400 | 6,200 | 800  | 3,400 | -1,000   | -4,200 | -3,000 | -1,200 | -2,800 |
| 2041          | 1,400 | 6,100 | 810  | 3,200 | -1,100   | -4,500 | -3,100 | -1,300 | -2,900 |
| 2042          | 1,400 | 5,900 | 820  | 3,000 | -1,100   | -4,800 | -3,300 | -1,400 | -3,100 |
| 2043          | 1,400 | 5,700 | 830  | 2,700 | -1,200   | -5,000 | -3,500 | -1,500 | -3,300 |
| 2044          | 1,400 | 5,400 | 820  | 2,300 | -1,300   | -5,300 | -3,700 | -1,600 | -3,500 |
| 2045          | 1,300 | 5,100 | 820  | 2,000 | -1,300   | -5,500 | -3,900 | -1,600 | -3,600 |
| 2046          | 1,300 | 5,000 | 810  | 1,800 | -1,400   | -5,700 | -4,000 | -1,700 | -3,700 |
| 2047          | 1,300 | 4,800 | 790  | 1,600 | -1,400   | -5,800 | -4,100 | -1,700 | -3,800 |
| 2048          | 1,200 | 4,600 | 770  | 1,400 | -1,400   | -5,900 | -4,100 | -1,800 | -3,900 |
| 2049          | 1,200 | 4,400 | 740  | 1,200 | -1,400   | -6,000 | -4,200 | -1,800 | -4,000 |
| 2050          | 1,200 | 4,200 | 730  | 950   | -1,500   | -6,100 | -4,300 | -1,800 | -4,000 |
| 2051          | 1,200 | 4,200 | 730  | 950   | -1,500   | -6,100 | -4,300 | -1,800 | -4,000 |
| 2052          | 1,200 | 4,200 | 730  | 960   | -1,500   | -6,200 | -4,300 | -1,800 | -4,100 |
| 2053          | 1,100 | 4,200 | 720  | 950   | -1,500   | -6,200 | -4,300 | -1,800 | -4,100 |
| 2054          | 1,100 | 4,200 | 720  | 950   | -1,500   | -6,200 | -4,300 | -1,800 | -4,000 |
| 2055          | 1,100 | 4,200 | 710  | 950   | -1,500   | -6,100 | -4,300 | -1,800 | -4,000 |

\* Negative values reflect reductions; positive values increases. Data were not available for calculating CO inventories from EGUs.

**Table 8-34: Net criteria air pollutant impacts from vehicles, EGUs and refineries, Final standards \*.**

| Calendar Year | Vehicle, EGU, Refinery<br>(US tons per year) |         |          |        |            | % Change |        |          |       |          |
|---------------|--|---------|----------|--------|------------|----------|--------|----------|-------|----------|
|               | PM2.5  | NOX     | NMOG     | SOX    | CO         | PM2.5    | NOX    | NMOG     | SOX   | CO       |
| 2027          | -93  | 120     | -37      | 110    | -420       | -0.22%   | 0.023% | -0.0054% | 0.32% | -0.0039% |
| 2028          | -230   | 330     | -490     | 450    | -6,700     | -0.55%   | 0.072% | -0.079%  | 1.3%  | -0.068%  |
| 2029          | -380   | 350     | -1,800   | 880    | -25,000    | -0.92%   | 0.085% | -0.31%   | 2.6%  | -0.28%   |
| 2030          | -600   | 170     | -3,900   | 1,500  | -54,000    | -1.5%    | 0.045% | -0.72%   | 4.7%  | -0.64%   |
| 2031          | -770   | 170     | -6,600   | 2,400  | -92,000    | -1.9%    | 0.049% | -1.3%    | 7.7%  | -1.2%    |
| 2032          | -970   | -480    | -9,800   | 3,100  | -140,000   | -2.4%    | -0.16% | -2%      | 10%   | -1.9%    |
| 2033          | -1,300                                       | -1,700  | -15,000  | 3,600  | -210,000   | -3.3%    | -0.63% | -3.2%    | 12%   | -3.2%    |
| 2034          | -1,600                                       | -3,400  | -20,000  | 3,800  | -300,000   | -4.2%    | -1.3%  | -4.4%    | 14%   | -4.7%    |
| 2035          | -2,000                                       | -5,400  | -26,000  | 3,800  | -380,000   | -5.2%    | -2.3%  | -6.1%    | 15%   | -6.6%    |
| 2036          | -2,400                                       | -7,500  | -32,000  | 3,700  | -470,000   | -6.3%    | -3.5%  | -7.9%    | 15%   | -8.9%    |
| 2037          | -2,900                                       | -10,000 | -38,000  | 3,300  | -570,000   | -7.7%    | -5.1%  | -10%     | 13%   | -12%     |
| 2038          | -3,500                                       | -13,000 | -45,000  | 2,800  | -680,000   | -9.3%    | -7%    | -12%     | 12%   | -15%     |
| 2039          | -4,100                                       | -16,000 | -51,000  | 2,200  | -780,000   | -11%     | -9.1%  | -14%     | 9.4%  | -18%     |
| 2040          | -4,700                                       | -19,000 | -57,000  | 1,500  | -870,000   | -13%     | -11%   | -17%     | 6.7%  | -21%     |
| 2041          | -5,200                                       | -21,000 | -63,000  | 1,100  | -970,000   | -14%     | -13%   | -19%     | 4.9%  | -25%     |
| 2042          | -5,600                                       | -23,000 | -70,000  | 600    | -1,100,000 | -15%     | -15%   | -22%     | 2.8%  | -29%     |
| 2043          | -6,100                                       | -25,000 | -77,000  | 78     | -1,200,000 | -16%     | -17%   | -24%     | 0.37% | -32%     |
| 2044          | -6,500                                       | -28,000 | -83,000  | -510   | -1,300,000 | -18%     | -19%   | -27%     | -2.5% | -36%     |
| 2045          | -6,900                                       | -30,000 | -89,000  | -1,100 | -1,300,000 | -19%     | -20%   | -29%     | -5.7% | -39%     |
| 2046          | -7,200                                       | -31,000 | -96,000  | -1,400 | -1,400,000 | -19%     | -22%   | -32%     | -7.5% | -42%     |
| 2047          | -7,500                                       | -32,000 | -100,000 | -1,800 | -1,500,000 | -20%     | -23%   | -34%     | -9.5% | -44%     |
| 2048          | -7,800                                       | -34,000 | -110,000 | -2,100 | -1,600,000 | -21%     | -23%   | -36%     | -12%  | -46%     |
| 2049          | -8,100                                       | -34,000 | -120,000 | -2,500 | -1,600,000 | -21%     | -24%   | -38%     | -14%  | -48%     |
| 2050          | -8,300                                       | -35,000 | -120,000 | -2,800 | -1,700,000 | -22%     | -25%   | -40%     | -16%  | -49%     |
| 2051          | -8,400                                       | -36,000 | -130,000 | -2,800 | -1,700,000 | -22%     | -25%   | -41%     | -16%  | -50%     |
| 2052          | -8,500                                       | -36,000 | -130,000 | -2,800 | -1,700,000 | -22%     | -25%   | -43%     | -16%  | -51%     |
| 2053          | -8,600                                       | -36,000 | -140,000 | -2,800 | -1,700,000 | -22%     | -25%   | -44%     | -16%  | -51%     |
| 2054          | -8,700                                       | -36,000 | -140,000 | -2,800 | -1,700,000 | -22%     | -25%   | -45%     | -16%  | -51%     |
| 2055          | -8,700                                       | -36,000 | -150,000 | -2,800 | -1,700,000 | -22%     | -25%   | -46%     | -16%  | -52%     |

\* Negative values reflect reductions; positive values increases. Data were not available for calculating CO inventories from EGUs. Percent change reflects emissions associated with the light- and medium-duty fleet only, not total US emissions.



**Table 8-35: Net criteria air pollutant impacts from vehicles, EGUs and refineries,  
Alternative A \*.**

| Calendar Year | Vehicle, EGU, Refinery<br>(US tons per year) |         |          |        |            | % Change |        |        |       |        |
|---------------|--|---------|----------|--------|------------|----------|--------|--------|-------|--------|
|               | PM2.5  | NOX     | NMOG     | SOX    | CO         | PM2.5    | NOX    | NMOG   | SOX   | CO     |
| 2027          | -37  | 530     | -860     | 770    | -13,000    | -0.087%  | 0.1%   | -0.13% | 2.3%  | -0.12% |
| 2028          | -81  | 1,400   | -2,300   | 2,000  | -34,000    | -0.19%   | 0.29%  | -0.38% | 5.8%  | -0.35% |
| 2029          | -230   | 1,200   | -4,600   | 2,300  | -66,000    | -0.55%   | 0.28%  | -0.81% | 6.8%  | -0.73% |
| 2030          | -440   | 750     | -7,500   | 2,700  | -110,000   | -1.1%    | 0.2%   | -1.4%  | 8.8%  | -1.3%  |
| 2031          | -620   | 520     | -11,000  | 3,600  | -150,000   | -1.5%    | 0.15%  | -2.1%  | 12%   | -1.9%  |
| 2032          | -850   | -440    | -14,000  | 4,100  | -200,000   | -2.1%    | -0.14% | -3%    | 14%   | -2.8%  |
| 2033          | -1,200                                       | -1,900  | -19,000  | 4,500  | -280,000   | -3%      | -0.69% | -4.2%  | 16%   | -4.2%  |
| 2034          | -1,600                                       | -3,800  | -25,000  | 4,600  | -370,000   | -4%      | -1.5%  | -5.5%  | 17%   | -5.9%  |
| 2035          | -2,000                                       | -6,000  | -31,000  | 4,400  | -450,000   | -5.1%    | -2.6%  | -7.2%  | 17%   | -7.9%  |
| 2036          | -2,400                                       | -8,300  | -37,000  | 4,100  | -550,000   | -6.3%    | -3.9%  | -9.1%  | 16%   | -10%   |
| 2037          | -2,900                                       | -11,000 | -44,000  | 3,600  | -650,000   | -7.7%    | -5.6%  | -12%   | 15%   | -13%   |
| 2038          | -3,500                                       | -14,000 | -50,000  | 3,000  | -760,000   | -9.4%    | -7.5%  | -14%   | 13%   | -17%   |
| 2039          | -4,100                                       | -17,000 | -56,000  | 2,300  | -860,000   | -11%     | -9.7%  | -16%   | 10%   | -20%   |
| 2040          | -4,700                                       | -20,000 | -62,000  | 1,500  | -950,000   | -13%     | -12%   | -18%   | 6.8%  | -23%   |
| 2041          | -5,200                                       | -22,000 | -68,000  | 1,100  | -1,000,000 | -14%     | -14%   | -21%   | 4.9%  | -27%   |
| 2042          | -5,700                                       | -24,000 | -75,000  | 570    | -1,100,000 | -15%     | -16%   | -23%   | 2.7%  | -30%   |
| 2043          | -6,100                                       | -26,000 | -81,000  | 31     | -1,200,000 | -17%     | -17%   | -26%   | 0.15% | -34%   |
| 2044          | -6,500                                       | -28,000 | -88,000  | -560   | -1,300,000 | -18%     | -19%   | -28%   | -2.8% | -37%   |
| 2045          | -6,900                                       | -30,000 | -93,000  | -1,200 | -1,400,000 | -19%     | -21%   | -31%   | -6%   | -40%   |
| 2046          | -7,300                                       | -31,000 | -100,000 | -1,500 | -1,500,000 | -20%     | -22%   | -33%   | -7.8% | -43%   |
| 2047          | -7,600                                       | -33,000 | -110,000 | -1,800 | -1,500,000 | -20%     | -23%   | -35%   | -9.8% | -45%   |
| 2048          | -7,800                                       | -34,000 | -110,000 | -2,200 | -1,600,000 | -21%     | -24%   | -37%   | -12%  | -47%   |
| 2049          | -8,100                                       | -35,000 | -120,000 | -2,500 | -1,600,000 | -22%     | -24%   | -39%   | -14%  | -48%   |
| 2050          | -8,300                                       | -36,000 | -120,000 | -2,800 | -1,700,000 | -22%     | -25%   | -41%   | -16%  | -50%   |
| 2051          | -8,400                                       | -36,000 | -130,000 | -2,900 | -1,700,000 | -22%     | -25%   | -42%   | -16%  | -50%   |
| 2052          | -8,500                                       | -36,000 | -130,000 | -2,900 | -1,700,000 | -22%     | -25%   | -44%   | -16%  | -51%   |
| 2053          | -8,600                                       | -37,000 | -140,000 | -2,900 | -1,700,000 | -22%     | -25%   | -45%   | -16%  | -52%   |
| 2054          | -8,700                                       | -37,000 | -140,000 | -2,900 | -1,800,000 | -22%     | -25%   | -46%   | -16%  | -52%   |
| 2055          | -8,700                                       | -37,000 | -150,000 | -2,800 | -1,800,000 | -22%     | -25%   | -46%   | -16%  | -52%   |

\* Negative values reflect reductions; positive values increases. Data were not available for calculating CO inventories from EGUs. Percent change reflects emissions associated with the light- and medium-duty fleet only, not total US emissions.

**Table 8-36: Net criteria air pollutant impacts from vehicles, EGUs and refineries,  
Alternative B\*.**

| Calendar Year | Vehicle, EGU, Refinery<br>(US tons per year) |         |          |        |            | % Change |         |          |        |          |
|---------------|--|---------|----------|--------|------------|----------|---------|----------|--------|----------|
|               | PM2.5  | NOX     | NMOG     | SOX    | CO         | PM2.5    | NOX     | NMOG     | SOX    | CO       |
| 2027          | -94  | 110     | -16      | 91     | -120       | -0.22%   | 0.021%  | -0.0024% | 0.27%  | -0.0011% |
| 2028          | -240   | 250     | -400     | 340    | -5,200     | -0.58%   | 0.054%  | -0.064%  | 0.96%  | -0.053%  |
| 2029          | -390   | 260     | -1,600   | 760    | -23,000    | -0.96%   | 0.063%  | -0.29%   | 2.3%   | -0.25%   |
| 2030          | -640   | -34     | -3,600   | 1,200  | -50,000    | -1.6%    | -0.009% | -0.67%   | 4%     | -0.6%    |
| 2031          | -850   | -160    | -6,000   | 2,000  | -83,000    | -2.1%    | -0.047% | -1.2%    | 6.4%   | -1.1%    |
| 2032          | -1,100                                       | -880    | -9,000   | 2,600  | -120,000   | -2.7%    | -0.29%  | -1.9%    | 8.4%   | -1.7%    |
| 2033          | -1,400                                       | -1,800  | -13,000  | 3,200  | -190,000   | -3.5%    | -0.64%  | -2.8%    | 11%    | -2.8%    |
| 2034          | -1,800                                       | -3,200  | -17,000  | 3,300  | -250,000   | -4.5%    | -1.3%   | -3.8%    | 12%    | -4%      |
| 2035          | -2,200                                       | -4,900  | -22,000  | 3,100  | -310,000   | -5.6%    | -2.1%   | -5.1%    | 12%    | -5.4%    |
| 2036          | -2,600                                       | -6,800  | -26,000  | 2,900  | -380,000   | -6.8%    | -3.2%   | -6.5%    | 12%    | -7.2%    |
| 2037          | -3,100                                       | -8,900  | -31,000  | 2,600  | -460,000   | -8.3%    | -4.5%   | -8.3%    | 10%    | -9.4%    |
| 2038          | -3,700                                       | -11,000 | -36,000  | 2,100  | -540,000   | -9.9%    | -6.1%   | -10%     | 8.9%   | -12%     |
| 2039          | -4,300                                       | -14,000 | -41,000  | 1,600  | -620,000   | -11%     | -7.9%   | -12%     | 7%     | -14%     |
| 2040          | -4,800                                       | -16,000 | -46,000  | 1,100  | -690,000   | -13%     | -9.7%   | -14%     | 4.7%   | -17%     |
| 2041          | -5,300                                       | -18,000 | -51,000  | 690    | -760,000   | -14%     | -11%    | -16%     | 3.1%   | -20%     |
| 2042          | -5,800                                       | -20,000 | -56,000  | 300    | -840,000   | -16%     | -13%    | -18%     | 1.4%   | -23%     |
| 2043          | -6,200                                       | -22,000 | -62,000  | -130   | -910,000   | -17%     | -14%    | -20%     | -0.64% | -25%     |
| 2044          | -6,600                                       | -23,000 | -67,000  | -600   | -990,000   | -18%     | -16%    | -22%     | -3%    | -28%     |
| 2045          | -7,000                                       | -25,000 | -72,000  | -1,100 | -1,100,000 | -19%     | -17%    | -24%     | -5.5%  | -31%     |
| 2046          | -7,300                                       | -27,000 | -78,000  | -1,400 | -1,100,000 | -20%     | -18%    | -26%     | -7.1%  | -33%     |
| 2047          | -7,600                                       | -28,000 | -84,000  | -1,600 | -1,200,000 | -20%     | -19%    | -27%     | -8.7%  | -35%     |
| 2048          | -7,900                                       | -29,000 | -89,000  | -1,900 | -1,200,000 | -21%     | -20%    | -29%     | -10%   | -36%     |
| 2049          | -8,100                                       | -30,000 | -94,000  | -2,200 | -1,300,000 | -22%     | -21%    | -31%     | -12%   | -38%     |
| 2050          | -8,300                                       | -30,000 | -98,000  | -2,500 | -1,300,000 | -22%     | -21%    | -32%     | -14%   | -39%     |
| 2051          | -8,400                                       | -31,000 | -100,000 | -2,500 | -1,300,000 | -22%     | -21%    | -33%     | -14%   | -40%     |
| 2052          | -8,600                                       | -31,000 | -110,000 | -2,500 | -1,400,000 | -22%     | -22%    | -35%     | -14%   | -40%     |
| 2053          | -8,600                                       | -31,000 | -110,000 | -2,500 | -1,400,000 | -22%     | -22%    | -35%     | -14%   | -41%     |
| 2054          | -8,700                                       | -31,000 | -110,000 | -2,500 | -1,400,000 | -22%     | -22%    | -36%     | -14%   | -41%     |
| 2055          | -8,800                                       | -32,000 | -120,000 | -2,500 | -1,400,000 | -22%     | -22%    | -37%     | -14%   | -42%     |

\* Negative values reflect reductions; positive values increases. Data were not available for calculating CO inventories from EGUs. Percent change reflects emissions associated with the light- and medium-duty fleet only, not total US emissions.

## 8.7 Estimating Energy Security Effects

The energy security premia (the energy security savings in dollars per barrel of reduced imported oil) and the process used to estimate those values are described in Chapter 10. The discussion here focuses on how OMEGA estimates the oil consumption impacts to which the energy security premia can be multiplied to estimate monetized benefits.

### 8.7.1 Calculating Oil Consumption from Fuel Consumption

Chapter 8.5.3 describes how OMEGA estimates liquid-fuel consumption. This is done for every vehicle that operates any miles on a liquid-fuel, whether that fuel be gasoline or diesel. Chapter 8.5.4 presents the estimated impacts of the final standards and alternatives on overall fuel consumption.

### 8.7.2 Calculating Oil Imports from Oil Consumption

To estimate energy security benefits, OMEGA converts fuel consumption impacts to oil import impacts. This is done using the values shown in Table 8-37: Parameters used in estimating oil import impacts.

**Table 8-37: Parameters used in estimating oil import impacts.**

| Item  | Value |
|---|-------|
| Share of pure gasoline in retail gasoline                     | 0.9   |
| Share of pure diesel in retail diesel                         | 1.0   |
| Energy density ratio of pure gasoline to crude oil            | 0.881 |
| Energy density ratio of diesel to crude oil                   | 0.998 |
| Gallons per barrel of crude oil                               | 42    |
| Oil import reduction as percent of total oil demand reduction | 0.948 |

The barrels of oil consumed in a given scenario are estimated as shown below.

$$Barrels = FuelConsumption_{vehicle;liquid} \times Share \times \frac{EnergyDensityRatio}{GallonsPerBarrel}$$

Where,

*Barrels* = the barrels of oil associated with the fuel consumption value

*FuelConsumption<sub>vehicle;liquid</sub>* = the liquid-fuel consumption of the given vehicle (see Chapter 8.5.3)

*Share* = the applicable "pure share" shown in Table 8-37

*EnergyDensityRatio* = the applicable energy density ratio shown in Table 8-37

*GallonsPerBarrel* = 42 as shown in Table 8-37

Table 8-37 shows an "Oil import reduction as percent of total oil demand reduction" factor equal to 0.948. In Chapter 8.6.4.2, we described our new estimate of the impact of reduced domestic liquid fuel demand on U.S. refinery throughput. That estimate also impacts our estimate of the oil import factor used in the energy security analysis. As explained in Chapter 11.4 of the draft LMDV RIA:

*“For this energy security analysis, we undertake a detailed analysis of differences in U.S. fuel consumption, crude oil imports/exports, and exports of petroleum products for the time frame 2027–2050 using the AEO 2021 (Reference Case) in comparison with an alternative AEO 2021 sensitivity case, Low Economic Growth. The Low Economic Growth Case is used since oil demand decreases in comparison to the Reference Case. EPA estimates that approximately 90.7 percent of the change in fuel consumption resulting from these proposed standards is likely to be reflected in reduced U.S. imports of crude oil over the time frame of analysis of this proposed rule. The 90.7 percent oil import reduction factor is calculated by taking the ratio of the changes in U.S. net crude oil and refined petroleum product imports. We are using AEO 2021, as opposed to the more recent AEO 2022, for the quantitative analysis of this proposed rule to maintain consistency with other parts of the analysis (i.e., air quality modeling) of this proposed rule. The AEO 2021 projects oil market trends through 2050. The time frame for EPA's analysis of this proposed rule is from 2027 to 2055. Thus, we report oil market trends to 2050 based upon AEO 2021 in Table 11-1. We also report U.S. oil import reductions through 2055 in Table 11-1 as well. Calculated using series “Petroleum Consumption (Excluding Biofuels) Annual” (Table 1.3) and “Petroleum Consumption Total Heat Content Annual” (Table A3). We looked at changes in U.S. crude oil imports/exports and net petroleum products in the AEO 2021 Reference Case, Table 11. Petroleum and Other Liquids Supply and Disposition, in comparison to an alternative case, the Low Economic Growth Case. See the spreadsheet in the Docket, “AEO2021 Change in product demand on imports” divided by the change in U.S. oil consumption in the two different AEO cases considered.”*

The docketed spreadsheet contains a summary table for the analysis contained in the spreadsheet, and Table 8-38 shows that for the reduction in refined product estimated by AEO 2021 Low Economic Growth Case relative to the Reference Case, 83.7 percent of the reduced product demand is attributed to reduced imported crude oil, while 7.0 percent is attributed to reduced net imports—resulting in the 90.7 percent import factor.

**Table 8-38 Oil Import Factor based on AEO 2021**

| Average over the years 2027 to 2050 |   |
|-------------------------------------|---|
| 83.7                                | Percent of imported crude oil             |
| 9.3                                 | Percent reduction in domestic crude oil   |
| 7.0                                 | Percent reduction in net imported product |
| 100.0                               |   |
| 90.7                                | Total percentage of imported petroleum    |

For the final rule, the same methodology based on the AEO 2023 would result in a 89.6 percent oil import factor—84.8 percent of which would be due to reduced imported crude oil and 4.8 percent would be due to reduced net imports.

**Table 8-39 Oil Import Factor based on AEO 2023**

| Average over the years 2027 to 2050 |   |
|-------------------------------------|---|
| 84.8                                | Percent of imported crude oil             |
| 10.3                                | Percent reduction in domestic crude oil   |
| 4.8                                 | Percent reduction in net imported product |
| 100.0                               |   |
| 89.6                                | Total percentage of imported petroleum    |

Use of the two AEO cases cited above estimates a large reduction in U.S. refinery throughput—AEO2021 estimates that 93 percent (83.7+9.3) of the reduced product demand would be attributed to reduced throughput at U.S. refineries, while based on AEO2023, the reduction in U.S. refinery throughput would be 95.1 percent. However, for the final rulemaking we are estimating that refineries would not reduce their throughput to the same extent. Instead, of a given volume reduction of gasoline and diesel fuel demand caused by this rulemaking, we are estimating that 50 percent of that reduced demand would be due to reduced production by U.S. refineries, while the other 50 percent would be from reduced net imports (see Chapter 8.6.4.2 for an explanation on the basis for this assumption). Thus, we needed a way to estimate the energy security impacts assuming that U.S. refiners would continue producing domestic fuels at a much higher level associated with the 50/50 assumption.

Since we are now estimating that in response to reduced refined product demand, half of that reduced demand would be reduced production from U.S. refineries and the other half would be decreased net imports, two different methods for estimating the oil import factor can both be used. The portion of reduced refinery demand projected to result in reduced refinery throughput can be represented by the oil import factor estimated by the two AEO cases. However, since reduced refinery throughput is estimated to comprise all of the reduced demand, we instead assumed that the percent reduction in net imported product would also be reduced imported crude oil—thus, all of the 89.6 percent reduced imported petroleum would be imported crude oil. Conversely, the balance of reduced refinery demand which US refineries keep operating can be represented by the oil import factor, which by definition would be 100 percent (since net imports would have to decrease at the same rate that refinery demand decreases). Thus, the oil import factor is estimated by the following equation:

$$\text{Oil import reduction as percent of total oil demand reduction} = 89.6\% \times 0.5 + 100\% \times 0.5 = 94.8\%$$

The reduced barrels of imported oil are then calculated as shown below.

$$\text{Barrels}_{\text{change in imports}} = (\text{Barrels}_{\text{NoAction}} - \text{Barrels}_{\text{Action}}) \times \text{Oil import factor}$$

Where,

*Oil impact factor* = the Oil import reduction as percent of total oil demand reduction

### 8.7.3 Summary of Energy Security Effects

**Table 8-40: Impacts on oil consumption and oil imports, Final standards (millions).**

| Calendar Year | Barrels | Barrels Imported | Barrels Imported per Day |
|---------------|---------|------------------|--------------------------|
| 2027          | -1.3    | -1.3             | -0.0035                  |
| 2028          | -9.     | -8.5             | -0.023                   |
| 2029          | -28     | -27              | -0.073                   |
| 2030          | -57     | -54              | -0.15                    |
| 2031          | -95     | -90              | -0.25                    |
| 2032          | -140    | -130             | -0.36                    |
| 2033          | -200    | -190             | -0.51                    |
| 2034          | -260    | -240             | -0.67                    |
| 2035          | -320    | -300             | -0.83                    |
| 2036          | -380    | -360             | -0.98                    |
| 2037          | -430    | -410             | -1.1                     |
| 2038          | -480    | -450             | -1.2                     |
| 2039          | -530    | -500             | -1.4                     |
| 2040          | -570    | -540             | -1.5                     |
| 2041          | -610    | -570             | -1.6                     |
| 2042          | -640    | -610             | -1.7                     |
| 2043          | -680    | -640             | -1.8                     |
| 2044          | -710    | -670             | -1.8                     |
| 2045          | -730    | -700             | -1.9                     |
| 2046          | -760    | -720             | -2.                      |
| 2047          | -770    | -730             | -2.                      |
| 2048          | -790    | -750             | -2.1                     |
| 2049          | -800    | -760             | -2.1                     |
| 2050          | -810    | -770             | -2.1                     |
| 2051          | -820    | -770             | -2.1                     |
| 2052          | -820    | -780             | -2.1                     |
| 2053          | -820    | -780             | -2.1                     |
| 2054          | -820    | -780             | -2.1                     |
| 2055          | -820    | -780             | -2.1                     |
| Sum           | -15,000 | -14,000          |                          |

\* Negative values reflect reductions; positive values increases.

**Table 8-41: Impacts on oil consumption and oil imports, Alternative A  
(millions).**

| Calendar Year | Barrels | Barrels Imported | Barrels Imported per Day |
|---------------|---------|------------------|--------------------------|
| 2027          | -15     | -14              | -0.038                   |
| 2028          | -41     | -39              | -0.11                    |
| 2029          | -75     | -71              | -0.19                    |
| 2030          | -110    | -110             | -0.3                     |
| 2031          | -160    | -150             | -0.41                    |
| 2032          | -200    | -190             | -0.52                    |
| 2033          | -260    | -240             | -0.67                    |
| 2034          | -320    | -300             | -0.83                    |
| 2035          | -380    | -360             | -0.98                    |
| 2036          | -430    | -410             | -1.1                     |
| 2037          | -480    | -450             | -1.2                     |
| 2038          | -530    | -500             | -1.4                     |
| 2039          | -570    | -540             | -1.5                     |
| 2040          | -610    | -580             | -1.6                     |
| 2041          | -640    | -610             | -1.7                     |
| 2042          | -680    | -640             | -1.8                     |
| 2043          | -710    | -670             | -1.8                     |
| 2044          | -730    | -700             | -1.9                     |
| 2045          | -750    | -710             | -2.                      |
| 2046          | -770    | -730             | -2.                      |
| 2047          | -790    | -750             | -2.1                     |
| 2048          | -800    | -760             | -2.1                     |
| 2049          | -820    | -770             | -2.1                     |
| 2050          | -820    | -780             | -2.1                     |
| 2051          | -830    | -790             | -2.2                     |
| 2052          | -830    | -790             | -2.2                     |
| 2053          | -840    | -790             | -2.2                     |
| 2054          | -840    | -790             | -2.2                     |
| 2055          | -830    | -780             | -2.1                     |
| Sum           | -16,000 | -15,000          |                          |

\* Negative values reflect reductions; positive values increases.

**Table 8-42: Impacts on oil consumption and oil imports, Alternative B (millions).**

| Calendar Year | Barrels | Barrels Imported | Barrels Imported per Day |
|---------------|---------|------------------|--------------------------|
| 2027          | -0.99   | -0.94            | -0.0026                  |
| 2028          | -7.6    | -7.2             | -0.02                    |
| 2029          | -26     | -25              | -0.068                   |
| 2030          | -53     | -50              | -0.14                    |
| 2031          | -86     | -82              | -0.22                    |
| 2032          | -130    | -120             | -0.33                    |
| 2033          | -180    | -170             | -0.47                    |
| 2034          | -230    | -220             | -0.6                     |
| 2035          | -280    | -260             | -0.72                    |
| 2036          | -320    | -310             | -0.84                    |
| 2037          | -360    | -350             | -0.95                    |
| 2038          | -400    | -380             | -1.                      |
| 2039          | -440    | -420             | -1.1                     |
| 2040          | -470    | -450             | -1.2                     |
| 2041          | -500    | -480             | -1.3                     |
| 2042          | -530    | -510             | -1.4                     |
| 2043          | -560    | -540             | -1.5                     |
| 2044          | -590    | -560             | -1.5                     |
| 2045          | -610    | -580             | -1.6                     |
| 2046          | -630    | -600             | -1.6                     |
| 2047          | -650    | -620             | -1.7                     |
| 2048          | -660    | -630             | -1.7                     |
| 2049          | -670    | -640             | -1.7                     |
| 2050          | -680    | -650             | -1.8                     |
| 2051          | -680    | -650             | -1.8                     |
| 2052          | -690    | -650             | -1.8                     |
| 2053          | -690    | -650             | -1.8                     |
| 2054          | -690    | -650             | -1.8                     |
| 2055          | -680    | -650             | -1.8                     |
| Sum           | -13,000 | -12,000          |                          |

\* Negative values reflect reductions; positive values increases.



## Chapter 8 References

1012 Industry Report. 2021. "Belle Chasse oil refinery closing after being damaged by Hurricane Ida." 1012 Industry Report. November 16. Accessed 3 7, 2024.

<https://www.1012industryreport.com/industry/belle-chasse-oil-refinery-closing-after-being-damaged-by-hurricane-ida/>.

Cherry Ding, Alexandre Ferro, Tim Fitzgibbon, and Piotr Szabat. 2022. "Refining in the energy transition through 2040." McKinsey & Company, October.

EIA. 2014. "How much carbon dioxide is produced by burning gasoline and diesel fuel?" Energy Information Administration, May 21. Accessed February 1, 2024.

EIA Imports by Area of Entry. 2023. "Imports by Area of Entry, Petroleum and Other Liquids." Petroleum and Other Liquids. Accessed 3 7, 2024.

[https://www.eia.gov/dnav/pet/pet\\_move\\_imp\\_dc\\_NUS-Z00\\_mbbldpd\\_a.htm](https://www.eia.gov/dnav/pet/pet_move_imp_dc_NUS-Z00_mbbldpd_a.htm).

EIA Spot Prices. 2024. "Spot Prices; Petroleum and Other Liquids." Petroleum and Other Liquids. Accessed 3 7, 2024. [https://www.eia.gov/dnav/pet/pet\\_pri\\_spt\\_s1\\_a.htm](https://www.eia.gov/dnav/pet/pet_pri_spt_s1_a.htm).

EIA Today in Energy. 2014. "Lower crude feedstock costs contribute to North American refinery profitability." Today in Energy. June 5. Accessed 3 7, 2024. <https://www.eia.gov/todayinenergy/detail.php?id=16571>.

2021. "GREET." Greenhouse gases, Regulated Emissions, and Energy use in Technologies Model ® (2021 Excel). Computer Software, Web. doi:10.11578/GREET-Excel-2021/dc.20210902.1. U.S. Department of Energy (DOE) Office of Energy Efficiency and Renewable Energy (EERE), October 11.

IPCC. 2014. "Climate Change 2014: Synthesis Report. Contribution of Working Groups I, II and III to the Fifth Assessment Report of the Intergovernmental Panel on Climate Change." Climate Change 2014. IPCC. 87.

Mo, Tiffany. 2024. "Revisions to MOVES for Air Quality Modeling to support the FRM for the Multi-Pollutant Emissions Standards for Model Years 2027 and Later Light-Duty and Medium-Duty Vehicles ." Memorandum to Docket.

Mosbrucker, Kristen. 2021. "Without a buyer, Shell may convert shuttered Convent refinery into alternative fuels facility." The Advocate. October 14. Accessed 3 7, 2024.

[https://www.theadvocate.com/baton\\_rouge/news/business/without-a-buyer-shell-may-convert-shuttered-convent-refinery-into-alternative-fuel-facility/article\\_54ff85f2-2d18-11ec-af75-13fba5943b71.html](https://www.theadvocate.com/baton_rouge/news/business/without-a-buyer-shell-may-convert-shuttered-convent-refinery-into-alternative-fuel-facility/article_54ff85f2-2d18-11ec-af75-13fba5943b71.html).

NHTSA. 2023. "88 FR 56128." Corporate Average Fuel Economy Standards for Passenger Cars and Light Trucks for Model Years 2027–2032 and Fuel Efficiency Standards for Heavy-Duty Pickup Trucks and Vans for Model Years 2030–2035. NHTSA, August 17.

—. 2022. "Corporate Average Fuel Economy Standards for Model Years 2024–2026 Passenger Cars and Light Trucks." May 2.

—. 2023. "Draft Technical Support Document." Corporate Average Fuel Economy Standards for Passenger Cars and Light Trucks for Model Years 2027 and Beyond and Fuel Efficiency Standards for Heavy-Duty Pickup Trucks and Vans for Model Years 2030 and Beyond. July.

Sherwood, Todd. 2024. "OMEGA Refinery Data Inputs." Memo to Docket No. EPA-HQ-OAR-2022-0829.

U.S. EIA. 2023. Annual Energy Outlook. U.S. Energy Information Administration.

U.S. EPA. 2021. Dose-Response Assessment for Assessing Health Risks Associated With Exposure to Hazardous Air Pollutants. September 29. Accessed November 15, 2022. <https://www.epa.gov/fera/dose-response-assessment-assessing-health-risks-associated-exposure-hazardous-air-pollutants>.

U.S. EPA. 2024. "Memo to the Docket: Air Quality Modeling Analysis for the Light- and Medium- Duty 2027 Multipollutant Final Rule." EPA-HQ-OAR-2022-0829.

U.S. NHTSA. 2022. "2022 CAFE FRIA." Final Regulatory Impact Analysis: Final Rulemaking for Model Years 2024-2026 Light-Duty Vehicle Corporate Average Fuel Economy Standards. U.S. Department of Transportation, National Highway Traffic Safety Administration, March.

Wang, M., Lee, H. & Molburg, J. 2004. Allocation of energy use in petroleum refineries to petroleum products. <https://doi.org/10.1007/BF02978534>, Int J LCA 9, 34–44 (2004).

## Chapter 9: Costs and Benefits of the Final Standards in OMEGA

This chapter presents the costs and benefits calculated within OMEGA. The results presented here show the estimated annual costs, fuel savings, and benefits of the program for the indicated calendar years (CY). Costs and benefits presented here are calculated relative to No Action unless stated otherwise. The results also show the present-values (PV) and the equivalent annualized values (AV) of costs and benefits for the calendar years 2027–2055 using 2, 3, and 7 percent discount rates. For the estimation of the stream of costs and benefits, we assume that the MY 2032 standards apply to each year thereafter.

### 9.1 Costs

Vehicle technology costs are estimated in OMEGA using the technology cost inputs presented in Chapter 2 of this RIA. Insurance, repair, maintenance, congestion, and noise costs are estimated in OMEGA using the approaches described in Chapter 4 of this RIA. The resultant costs associated with the final standards are presented in Table 9-1. Table 9-2 and Table 9-3 show the analogous results for Alternatives A and B, respectively.

**Table 9-1: Costs associated with the final standards (billions of 2022 dollars)\*.**

| Calendar Year | Vehicle Technology Costs** | Insurance Costs | Repair Costs | Maintenance Costs | Congestion Costs | Noise Costs | Sum of Costs |
|---------------|----------------------------|-----------------|--------------|-------------------|------------------|-------------|--------------|
| 2027          | \$2.6                      | \$0.02          | \$0.027      | \$0.042           | \$0.0013         | \$0.000015  | \$2.7        |
| 2028          | \$7.3                      | \$0.06          | \$0.081      | \$0.096           | \$0.027          | \$0.00041   | \$7.6        |
| 2029          | \$16                       | \$0.15          | \$0.16       | \$0.089           | \$0.05           | \$0.00077   | \$17         |
| 2030          | \$23                       | \$0.27          | \$0.26       | -\$0.027          | \$0.073          | \$0.0011    | \$24         |
| 2031          | \$29                       | \$0.41          | \$0.35       | -\$0.35           | \$0.094          | \$0.0015    | \$29         |
| 2032          | \$30                       | \$0.55          | \$0.38       | -\$0.9            | \$0.11           | \$0.0017    | \$30         |
| 2035          | \$55                       | \$1.5           | \$0.7        | -\$3.3            | \$0.59           | \$0.0095    | \$54         |
| 2040          | \$50                       | \$2.1           | -\$0.81      | -\$13             | \$1.3            | \$0.021     | \$40         |
| 2045          | \$46                       | \$2.3           | -\$3.4       | -\$24             | \$1.9            | \$0.03      | \$23         |
| 2050          | \$42                       | \$2.1           | -\$5.7       | -\$32             | \$2.3            | \$0.037     | \$9.4        |
| 2055          | \$38                       | \$1.9           | -\$7.1       | -\$35             | \$2.4            | \$0.04      | \$0.59       |
| PV2           | \$870                      | \$33            | -\$40        | -\$300            | \$25             | \$0.41      | \$590        |
| PV3           | \$760                      | \$28            | -\$32        | -\$250            | \$21             | \$0.34      | \$530        |
| PV7           | \$450                      | \$15            | -\$12        | -\$110            | \$10             | \$0.17      | \$350        |
| AV2           | \$40                       | \$1.5           | -\$1.8       | -\$14             | \$1.2            | \$0.019     | \$27         |
| AV3           | \$39                       | \$1.4           | -\$1.6       | -\$13             | \$1.1            | \$0.018     | \$28         |
| AV7           | \$37                       | \$1.2           | -\$0.99      | -\$9.3            | \$0.83           | \$0.014     | \$29         |

\* Negative values reflect decreased costs, or savings; positive values reflect increased costs.  
 \*\* Costs exclude consideration of IRA battery tax credits (IRS 45X) and IRA purchase tax credits (IRS 30D and 45W).

As shown, estimated repair and maintenance costs, or reductions in those costs, are significant. BEVs have considerably less maintenance needs than do ICE vehicles (see Chapter 4.3 of this RIA which shows BEVs having 30 to 40 percent less maintenance than ICE vehicles). Congestion and noise costs are associated with rebound VMT as discussed in Chapter 4.3.8. Insurance costs were not included in the NPRM so are new for the final analysis and are discussed in Chapter 4.3.6 of this RIA.

**Table 9-2: Costs associated with Alternative A (billions of 2022 dollars)\*.**

| Calendar Year | Vehicle Technology Costs** | Insurance Costs | Repair Costs | Maintenance Costs | Congestion Costs | Noise Costs | Sum of Costs |
|---------------|----------------------------|-----------------|--------------|-------------------|------------------|-------------|--------------|
| 2027          | \$16                       | \$0.099         | \$0.091      | \$0.097           | \$0.0034         | \$0.000031  | \$16         |
| 2028          | \$25                       | \$0.24          | \$0.23       | \$0.14            | \$0.066          | \$0.001     | \$26         |
| 2029          | \$32                       | \$0.4           | \$0.36       | -\$0.0079         | \$0.12           | \$0.0019    | \$33         |
| 2030          | \$36                       | \$0.56          | \$0.48       | -\$0.34           | \$0.18           | \$0.0029    | \$37         |
| 2031          | \$35                       | \$0.7           | \$0.55       | -\$0.91           | \$0.24           | \$0.0038    | \$36         |
| 2032          | \$33                       | \$0.82          | \$0.57       | -\$1.7            | \$0.27           | \$0.0043    | \$33         |
| 2035          | \$54                       | \$1.6           | \$0.75       | -\$4.9            | \$0.73           | \$0.012     | \$52         |
| 2040          | \$49                       | \$2.2           | -\$0.88      | -\$15             | \$1.4            | \$0.023     | \$37         |
| 2045          | \$45                       | \$2.3           | -\$3.4       | -\$25             | \$1.9            | \$0.032     | \$21         |
| 2050          | \$43                       | \$2.1           | -\$5.7       | -\$32             | \$2.3            | \$0.038     | \$9.5        |
| 2055          | \$39                       | \$1.9           | -\$7.3       | -\$35             | \$2.4            | \$0.04      | \$0.2        |
| PV2           | \$940                      | \$35            | -\$40        | -\$320            | \$27             | \$0.44      | \$640        |
| PV3           | \$820                      | \$30            | -\$31        | -\$270            | \$23             | \$0.37      | \$580        |
| PV7           | \$510                      | \$17            | -\$12        | -\$130            | \$11             | \$0.18      | \$400        |
| AV2           | \$43                       | \$1.6           | -\$1.8       | -\$15             | \$1.2            | \$0.02      | \$29         |
| AV3           | \$43                       | \$1.6           | -\$1.6       | -\$14             | \$1.2            | \$0.019     | \$30         |
| AV7           | \$41                       | \$1.4           | -\$0.94      | -\$10             | \$0.92           | \$0.015     | \$33         |

\* Negative values reflect decreased costs, or savings; positive values reflect increased costs.  
\*\* Costs exclude consideration of IRA battery tax credits (IRS 45X) and IRA purchase tax credits (IRS 30D and 45W).

**Table 9-3: Costs associated with Alternative B (billions of 2022 dollars)\*.**

| Calendar Year | Vehicle Technology Costs** | Insurance Costs | Repair Costs | Maintenance Costs | Congestion Costs | Noise Costs | Sum of Costs |
|---------------|----------------------------|-----------------|--------------|-------------------|------------------|-------------|--------------|
| 2027          | \$2.3                      | \$0.018         | \$0.026      | \$0.042           | \$0.0016         | \$0.000019  | \$2.4        |
| 2028          | \$5.9                      | \$0.047         | \$0.067      | \$0.083           | \$0.025          | \$0.00039   | \$6.1        |
| 2029          | \$15                       | \$0.13          | \$0.14       | \$0.09            | \$0.046          | \$0.00074   | \$16         |
| 2030          | \$21                       | \$0.24          | \$0.24       | -\$0.0077         | \$0.078          | \$0.0012    | \$22         |
| 2031          | \$24                       | \$0.35          | \$0.33       | -\$0.29           | \$0.1            | \$0.0016    | \$24         |
| 2032          | \$27                       | \$0.48          | \$0.36       | -\$0.79           | \$0.11           | \$0.0018    | \$27         |
| 2035          | \$42                       | \$1.1           | \$0.35       | -\$3.2            | \$0.47           | \$0.0077    | \$41         |
| 2040          | \$40                       | \$1.7           | -\$1.1       | -\$11             | \$1.1            | \$0.018     | \$30         |
| 2045          | \$39                       | \$1.8           | -\$3.3       | -\$20             | \$1.7            | \$0.027     | \$19         |
| 2050          | \$35                       | \$1.7           | -\$5.3       | -\$27             | \$2              | \$0.033     | \$6.3        |
| 2055          | \$30                       | \$1.5           | -\$6.6       | -\$30             | \$2.2            | \$0.036     | -\$2.8       |
| PV2           | \$710                      | \$26            | -\$41        | -\$260            | \$22             | \$0.36      | \$450        |
| PV3           | \$610                      | \$22            | -\$32        | -\$210            | \$18             | \$0.3       | \$410        |
| PV7           | \$360                      | \$12            | -\$13        | -\$98             | \$8.9            | \$0.15      | \$270        |
| AV2           | \$32                       | \$1.2           | -\$1.9       | -\$12             | \$1              | \$0.017     | \$21         |
| AV3           | \$32                       | \$1.2           | -\$1.7       | -\$11             | \$0.96           | \$0.016     | \$21         |
| AV7           | \$30                       | \$0.98          | -\$1.1       | -\$8              | \$0.73           | \$0.012     | \$22         |

\* Negative values reflect decreased costs, or savings; positive values reflect increased costs.  
\*\* Costs exclude consideration of IRA battery tax credits (IRS 45X) and IRA purchase tax credits (IRS 30D and 45W).

## 9.2 Fuel Savings

The final standards are projected to reduce liquid fuel consumption (e.g., gasoline) while simultaneously increasing electricity consumption. The estimated impacts on fuel and electricity consumption are shown in Chapter 8.5 of this RIA.

The net effect of these changes in consumption for consumers is decreased liquid-fuel expenditures or fuel savings and increased electricity expenditures. For more information of fuel and electricity consumption, including other considerations like rebound driving, see RIA Chapter 4.

Table 9-4 shows the undiscounted annual monetized fuel savings associated with the final standards as well as the present value (PV) of those costs and equivalent annualized value (AV) for the calendar years 2027–2055 using 2, 3, and 7 percent discount rates. We include here the social costs associated with EVSE ports, as discussed in detail in Chapter 5.3. These reflect the upfront costs associated with procuring and installing PEV charging infrastructure needed to meet the anticipated electricity demand relative to the no action case. We include these EVSE port costs in the net benefits presented in Chapter 9.6. Net benefits are determined using pre-tax fuel savings since fuel taxes do not contribute to the value of the fuel and the EVSE port costs. We present fuel taxes and other transfers below in Chapter 9.7.

**Table 9-4: Pretax fuel savings and EVSE port costs associated with the final standards (billions of 2022 dollars)\*.**

| Calendar Year | Gasoline Savings | Diesel Savings | Electricity Savings | EVSE Port Costs | Sum    |
|---------------|------------------|----------------|---------------------|-----------------|--------|
| 2027          | \$0.14           | \$0.0079       | \$0.02              | \$1.3           | -\$1.2 |
| 2028          | \$1.1            | \$0.013        | -\$0.24             | \$0.55          | \$0.34 |
| 2029          | \$3.5            | \$0.095        | -\$1.1              | \$2.3           | \$0.25 |
| 2030          | \$7.1            | \$0.3          | -\$2.5              | \$2.3           | \$2.7  |
| 2031          | \$12             | \$0.52         | -\$4.3              | \$10            | -\$2.5 |
| 2032          | \$17             | \$0.86         | -\$6.4              | \$10            | \$0.93 |
| 2035          | \$39             | \$1.7          | -\$13               | \$10            | \$17   |
| 2040          | \$72             | \$2.6          | -\$21               | \$9             | \$44   |
| 2045          | \$94             | \$3.3          | -\$26               | \$12            | \$60   |
| 2050          | \$110            | \$3.9          | -\$27               | \$13            | \$74   |
| 2055          | \$120            | \$4.3          | -\$27               | \$8.6           | \$86   |
| PV2           | \$1,300          | \$49           | -\$360              | \$190           | \$820  |
| PV3           | \$1,100          | \$41           | -\$300              | \$160           | \$680  |
| PV7           | \$560            | \$21           | -\$160              | \$96            | \$330  |
| AV2           | \$61             | \$2.3          | -\$17               | \$9             | \$37   |
| AV3           | \$58             | \$2.2          | -\$16               | \$8.8           | \$35   |
| AV7           | \$46             | \$1.7          | -\$13               | \$7.9           | \$26   |

\* Negative electricity savings represent increased costs; the Sum column is the sum of Savings columns less the EVSE Port Costs column.

**Table 9-5: Pretax fuel savings and EVSE port costs associated with Alternative A  
(billions of 2022 dollars) \*.**

| <b>Calendar Year</b> | <b>Gasoline</b> | <b>Diesel</b> | <b>Electricity</b> | <b>EVSE Port Costs</b> | <b>Sum</b> |
|----------------------|-----------------|---------------|--------------------|------------------------|------------|
| 2027                 | \$2             | \$0.025       | -\$0.73            | \$1.3                  | -\$0.052   |
| 2028                 | \$5.2           | \$0.078       | -\$1.8             | \$0.55                 | \$3        |
| 2029                 | \$9.4           | \$0.2         | -\$3.2             | \$2.3                  | \$4.2      |
| 2030                 | \$14            | \$0.42        | -\$4.8             | \$2.3                  | \$7.7      |
| 2031                 | \$20            | \$0.64        | -\$6.7             | \$10                   | \$3.2      |
| 2032                 | \$25            | \$0.97        | -\$8.8             | \$10                   | \$7        |
| 2035                 | \$47            | \$1.8         | -\$15              | \$10                   | \$23       |
| 2040                 | \$77            | \$2.8         | -\$22              | \$9                    | \$48       |
| 2045                 | \$97            | \$3.5         | -\$27              | \$12                   | \$62       |
| 2050                 | \$110           | \$4           | -\$28              | \$13                   | \$75       |
| 2055                 | \$120           | \$4.3         | -\$28              | \$8.6                  | \$86       |
| PV2                  | \$1,400         | \$52          | -\$390             | \$190                  | \$900      |
| PV3                  | \$1,200         | \$43          | -\$330             | \$160                  | \$750      |
| PV7                  | \$630           | \$23          | -\$180             | \$96                   | \$370      |
| AV2                  | \$66            | \$2.4         | -\$18              | \$9                    | \$41       |
| AV3                  | \$63            | \$2.3         | -\$17              | \$8.8                  | \$39       |
| AV7                  | \$51            | \$1.8         | -\$15              | \$7.9                  | \$30       |

\* Negative electricity savings represent increased costs; the Sum column is the sum of Savings columns less the EVSE Port Costs column.

**Table 9-6: Pretax fuel savings and EVSE port costs associated with Alternative B  
(billions of 2022 dollars) \*.**

| <b>Calendar Year</b> | <b>Gasoline</b> | <b>Diesel</b> | <b>Electricity</b> | <b>EVSE Port Costs</b> | <b>Sum</b> |
|----------------------|-----------------|---------------|--------------------|------------------------|------------|
| 2027                 | \$0.094         | \$0.0063      | \$0.041            | \$1.3                  | -\$1.2     |
| 2028                 | \$0.98          | \$0.011       | -\$0.17            | \$0.55                 | \$0.26     |
| 2029                 | \$3.4           | \$0.089       | -\$1.1             | \$2.3                  | \$0.16     |
| 2030                 | \$6.7           | \$0.29        | -\$2.3             | \$2.3                  | \$2.5      |
| 2031                 | \$11            | \$0.5         | -\$3.8             | \$10                   | -\$2.9     |
| 2032                 | \$16            | \$0.81        | -\$5.9             | \$10                   | \$0.41     |
| 2035                 | \$34            | \$1.6         | -\$12              | \$10                   | \$14       |
| 2040                 | \$61            | \$2.5         | -\$18              | \$9                    | \$37       |
| 2045                 | \$80            | \$3.2         | -\$22              | \$12                   | \$50       |
| 2050                 | \$94            | \$3.7         | -\$23              | \$13                   | \$62       |
| 2055                 | \$100           | \$4           | -\$23              | \$8.6                  | \$73       |
| PV2                  | \$1,100         | \$47          | -\$310             | \$190                  | \$690      |
| PV3                  | \$950           | \$39          | -\$260             | \$160                  | \$570      |
| PV7                  | \$480           | \$20          | -\$140             | \$96                   | \$270      |
| AV2                  | \$52            | \$2.1         | -\$14              | \$9                    | \$31       |
| AV3                  | \$50            | \$2           | -\$14              | \$8.8                  | \$29       |
| AV7                  | \$39            | \$1.6         | -\$11              | \$7.9                  | \$22       |

\* Negative electricity savings represent increased costs; the Sum column is the sum of Savings columns less the EVSE Port Costs column.

### 9.3 Non-Emission Benefits

Non-emission benefits are shown in Table 9-7 through Table 9-9 for the final standards, Alternative A, and Alternative B, respectively. The drive value represents the value that consumers place on the additional driving they may do resulting from the rebound effect. The value is positive here which represents a benefit to consumers because we have estimated a small amount of rebound driving relative to the no action case. The value of time spent refueling is shown as a negative benefit, or disbenefit, because we estimate additional time spent refueling relative to the no-action scenario. This is due to the additional BEV stock in the fleet and the additional time required, using current estimates, to refuel a BEV relative to the refueling time involved for an ICE vehicle. Energy security benefits (which are discussed further in Chapter 10) are shown as positive because we estimate reductions in liquid-fuel consumption and corresponding reductions in imported oil. Note that any benefits shown as negative values represent disbenefits.

**Table 9-7: Non-emission benefits associated with the final standards  
(billions of 2022 dollars) \*.**

| Calendar Year | Drive Value | Value of Time Spent Refueling | Energy Security | Total    |
|---------------|-------------|-------------------------------|-----------------|----------|
| 2027          | \$0.002     | \$0.0022                      | \$0.0047        | \$0.0089 |
| 2028          | \$0.042     | \$0.026                       | \$0.032         | \$0.1    |
| 2029          | \$0.081     | -\$0.012                      | \$0.1           | \$0.17   |
| 2030          | \$0.12      | -\$0.11                       | \$0.21          | \$0.22   |
| 2031          | \$0.16      | -\$0.27                       | \$0.36          | \$0.26   |
| 2032          | \$0.2       | -\$0.47                       | \$0.53          | \$0.26   |
| 2035          | \$1         | -\$0.59                       | \$1.3           | \$1.7    |
| 2040          | \$2.3       | -\$0.86                       | \$2.5           | \$3.9    |
| 2045          | \$3.3       | -\$1.1                        | \$3.4           | \$5.6    |
| 2050          | \$4.2       | -\$1.4                        | \$4             | \$6.8    |
| 2055          | \$4.7       | -\$1.7                        | \$4.1           | \$7      |
| PV2           | \$46        | -\$17                         | \$47            | \$75     |
| PV3           | \$38        | -\$15                         | \$39            | \$62     |
| PV7           | \$18        | -\$7.5                        | \$20            | \$30     |
| AV2           | \$2.1       | -\$0.8                        | \$2.1           | \$3.4    |
| AV3           | \$2         | -\$0.76                       | \$2             | \$3.2    |
| AV7           | \$1.5       | -\$0.61                       | \$1.6           | \$2.5    |

\* Positive values represent benefits while negative values represent disbenefits.

**Table 9-8: Non-emission benefits associated with Alternative A  
(billions of 2022 dollars) \*.**

| <b>Calendar Year</b> | <b>Drive Value</b> | <b>Value of Time Spent Refueling</b> | <b>Energy Security</b> | <b>Total</b> |
|----------------------|--------------------|--------------------------------------|------------------------|--------------|
| 2027                 | \$0.0052           | \$0.023                              | \$0.052                | \$0.08       |
| 2028                 | \$0.11             | \$0.099                              | \$0.15                 | \$0.35       |
| 2029                 | \$0.21             | \$0.11                               | \$0.27                 | \$0.59       |
| 2030                 | \$0.32             | \$0.039                              | \$0.43                 | \$0.79       |
| 2031                 | \$0.42             | -\$0.098                             | \$0.59                 | \$0.92       |
| 2032                 | \$0.5              | -\$0.28                              | \$0.77                 | \$0.98       |
| 2035                 | \$1.3              | -\$0.43                              | \$1.5                  | \$2.4        |
| 2040                 | \$2.5              | -\$0.75                              | \$2.7                  | \$4.4        |
| 2045                 | \$3.4              | -\$1                                 | \$3.5                  | \$5.9        |
| 2050                 | \$4.2              | -\$1.4                               | \$4.1                  | \$7          |
| 2055                 | \$4.7              | -\$1.7                               | \$4.1                  | \$7          |
| PV2                  | \$49               | -\$15                                | \$50                   | \$84         |
| PV3                  | \$41               | -\$13                                | \$42                   | \$70         |
| PV7                  | \$20               | -\$6.2                               | \$21                   | \$36         |
| AV2                  | \$2.2              | -\$0.7                               | \$2.3                  | \$3.8        |
| AV3                  | \$2.1              | -\$0.66                              | \$2.2                  | \$3.6        |
| AV7                  | \$1.7              | -\$0.5                               | \$1.8                  | \$2.9        |

\* Positive values represent benefits while negative values represent disbenefits.

**Table 9-9: Non-emission benefits associated with Alternative B  
(billions of 2022 dollars) \*.**

| <b>Calendar Year</b> | <b>Drive Value</b> | <b>Value of Time Spent Refueling</b> | <b>Energy Security</b> | <b>Total</b> |
|----------------------|--------------------|--------------------------------------|------------------------|--------------|
| 2027                 | \$0.0024           | \$0.0015                             | \$0.0035               | \$0.0074     |
| 2028                 | \$0.043            | \$0.023                              | \$0.027                | \$0.093      |
| 2029                 | \$0.082            | -\$0.018                             | \$0.096                | \$0.16       |
| 2030                 | \$0.14             | -\$0.12                              | \$0.2                  | \$0.22       |
| 2031                 | \$0.19             | -\$0.29                              | \$0.33                 | \$0.23       |
| 2032                 | \$0.22             | -\$0.5                               | \$0.48                 | \$0.2        |
| 2035                 | \$0.87             | -\$0.76                              | \$1.1                  | \$1.2        |
| 2040                 | \$2                | -\$1.2                               | \$2.1                  | \$2.9        |
| 2045                 | \$3                | -\$1.5                               | \$2.9                  | \$4.3        |
| 2050                 | \$3.8              | -\$1.8                               | \$3.4                  | \$5.4        |
| 2055                 | \$4.3              | -\$2.2                               | \$3.4                  | \$5.5        |
| PV2                  | \$41               | -\$23                                | \$39                   | \$58         |
| PV3                  | \$34               | -\$19                                | \$33                   | \$48         |
| PV7                  | \$17               | -\$9.8                               | \$17                   | \$23         |
| AV2                  | \$1.9              | -\$1.1                               | \$1.8                  | \$2.6        |
| AV3                  | \$1.8              | -\$1                                 | \$1.7                  | \$2.5        |
| AV7                  | \$1.3              | -\$0.8                               | \$1.3                  | \$1.9        |

\* Positive values represent benefits while negative values represent disbenefits.



## 9.4 Benefits of GHG Reductions

Table 9-10 through Table 9-13 present the estimated annual, undiscounted climate benefits of reduced CO<sub>2</sub>, CH<sub>4</sub>, N<sub>2</sub>O emissions under the final rule, and the annual total monetized climate benefits (i.e., from all GHG reductions), using the three SC-CO<sub>2</sub>, SC-CH<sub>4</sub>, SC-N<sub>2</sub>O estimates presented in U.S. EPA (EPA 2023f) for the stream of years beginning with the first year of rule implementation, 2027, through 2055. Also shown are the present values (PV) and equivalent annualized values (AV) associated with each of the three SC-GHG values. In this analysis, to calculate the present and annualized values of climate benefits, EPA uses the same discount rate as the near-term target Ramsey rate used to discount the climate benefits from future GHG reductions. That is, future climate benefits estimated with the SC-GHG at the near-term 2 percent Ramsey rate are discounted to 2027 using the same 2 percent rate.<sup>250</sup> Table 9-14 and Table 9-15 present the benefits of reduced GHG emissions associated with Alternatives A and B, respectively.

---

<sup>250</sup> As discussed in U.S. EPA (EPA 2023f), the error associated with using a constant discount rate rather than the certainty-equivalent rate path to calculate the present value of a future stream of monetized climate benefits is small for analyses with moderate time frames (e.g., 30 years or less). U.S. EPA (EPA 2023f) also provides an illustration of the amount that climate benefits from reductions in future emissions will be underestimated by using a constant discount rate relative to the more complicated certainty-equivalent rate path.

**Table 9-10: Benefits of reduced CO<sub>2</sub> emissions from the final standards.  
(billions of 2022 dollars)**

| Calendar Year | Near-term Ramsey Discount Rate |         |         |
|---------------|--------------------------------|---------|---------|
|               | 2.5%                           | 2.0%    | 1.5%    |
| 2027          | \$0.063                        | \$0.1   | \$0.17  |
| 2028          | \$0.54                         | \$0.87  | \$1.5   |
| 2029          | \$1.8                          | \$3     | \$5     |
| 2030          | \$3.9                          | \$6.2   | \$10    |
| 2031          | \$6.5                          | \$10    | \$17    |
| 2032          | \$9.7                          | \$15    | \$26    |
| 2033          | \$15                           | \$23    | \$38    |
| 2034          | \$20                           | \$31    | \$51    |
| 2035          | \$25                           | \$40    | \$66    |
| 2036          | \$31                           | \$49    | \$79    |
| 2037          | \$36                           | \$57    | \$93    |
| 2038          | \$42                           | \$65    | \$110   |
| 2039          | \$47                           | \$73    | \$120   |
| 2040          | \$53                           | \$81    | \$130   |
| 2041          | \$57                           | \$88    | \$140   |
| 2042          | \$62                           | \$96    | \$150   |
| 2043          | \$67                           | \$100   | \$160   |
| 2044          | \$72                           | \$110   | \$170   |
| 2045          | \$76                           | \$110   | \$180   |
| 2046          | \$79                           | \$120   | \$190   |
| 2047          | \$83                           | \$130   | \$200   |
| 2048          | \$86                           | \$130   | \$200   |
| 2049          | \$89                           | \$130   | \$210   |
| 2050          | \$92                           | \$140   | \$220   |
| 2051          | \$94                           | \$140   | \$220   |
| 2052          | \$96                           | \$140   | \$220   |
| 2053          | \$97                           | \$150   | \$230   |
| 2054          | \$98                           | \$150   | \$230   |
| 2055          | \$100                          | \$150   | \$230   |
| PV            | \$940                          | \$1,600 | \$2,800 |
| AV            | \$46                           | \$72    | \$120   |

Note: Climate benefits are based on changes (reductions) in CO<sub>2</sub> emissions and are calculated using updated estimates of the SC-CO<sub>2</sub> from U.S. EPA (EPA 2023f). Climate benefits include changes in vehicle, EGU and refinery CO<sub>2</sub> emissions.

**Table 9-11: Benefits of reduced CH<sub>4</sub> emissions from the final standards.  
(billions of 2022 dollars)**

| Calendar Year | Near-term Ramsey Discount Rate |             |             |
|---------------|--------------------------------|-------------|-------------|
|               | 2.5%                           | 2.0%        | 1.5%        |
| 2027          | -\$0.000021                    | -\$0.000026 | -\$0.000035 |
| 2028          | -\$0.000048                    | -\$0.00006  | -\$0.00008  |
| 2029          | \$0.000023                     | \$0.000028  | \$0.000038  |
| 2030          | \$0.00012                      | \$0.00015   | \$0.0002    |
| 2031          | \$0.00023                      | \$0.00028   | \$0.00037   |
| 2032          | \$0.00053                      | \$0.00065   | \$0.00085   |
| 2033          | \$0.0013                       | \$0.0016    | \$0.0021    |
| 2034          | \$0.0023                       | \$0.0028    | \$0.0037    |
| 2035          | \$0.0035                       | \$0.0043    | \$0.0055    |
| 2036          | \$0.0048                       | \$0.0059    | \$0.0076    |
| 2037          | \$0.0064                       | \$0.0078    | \$0.01      |
| 2038          | \$0.0082                       | \$0.01      | \$0.013     |
| 2039          | \$0.01                         | \$0.012     | \$0.016     |
| 2040          | \$0.012                        | \$0.015     | \$0.019     |
| 2041          | \$0.014                        | \$0.017     | \$0.022     |
| 2042          | \$0.016                        | \$0.019     | \$0.025     |
| 2043          | \$0.018                        | \$0.022     | \$0.028     |
| 2044          | \$0.02                         | \$0.024     | \$0.031     |
| 2045          | \$0.022                        | \$0.027     | \$0.034     |
| 2046          | \$0.024                        | \$0.029     | \$0.036     |
| 2047          | \$0.026                        | \$0.031     | \$0.039     |
| 2048          | \$0.028                        | \$0.033     | \$0.041     |
| 2049          | \$0.029                        | \$0.035     | \$0.043     |
| 2050          | \$0.03                         | \$0.036     | \$0.045     |
| 2051          | \$0.031                        | \$0.038     | \$0.047     |
| 2052          | \$0.032                        | \$0.039     | \$0.048     |
| 2053          | \$0.033                        | \$0.04      | \$0.049     |
| 2054          | \$0.034                        | \$0.04      | \$0.05      |
| 2055          | \$0.035                        | \$0.041     | \$0.051     |
| PV            | \$0.26                         | \$0.35      | \$0.48      |
| AV            | \$0.013                        | \$0.016     | \$0.021     |

Note: Climate benefits are based on changes (reductions) in CH<sub>4</sub> emissions and are calculated using updated estimates of the SC-CH<sub>4</sub> from U.S. EPA (EPA 2023f). Climate benefits include changes in vehicle, EGU and refinery CH<sub>4</sub> emissions.

**Table 9-12: Benefits of reduced N<sub>2</sub>O emissions from the final standards (billions of 2022 dollars).**

| Calendar Year | Near-term Ramsey Discount Rate |           |          |
|---------------|--------------------------------|-----------|----------|
|               | 2.5%                           | 2.0%      | 1.5%     |
| 2027          | \$0.0003                       | \$0.00045 | \$0.0007 |
| 2028          | \$0.002                        | \$0.003   | \$0.0047 |
| 2029          | \$0.0081                       | \$0.012   | \$0.019  |
| 2030          | \$0.019                        | \$0.029   | \$0.045  |
| 2031          | \$0.033                        | \$0.049   | \$0.075  |
| 2032          | \$0.051                        | \$0.075   | \$0.12   |
| 2033          | \$0.079                        | \$0.12    | \$0.18   |
| 2034          | \$0.11                         | \$0.16    | \$0.24   |
| 2035          | \$0.14                         | \$0.2     | \$0.31   |
| 2036          | \$0.17                         | \$0.25    | \$0.38   |
| 2037          | \$0.2                          | \$0.29    | \$0.44   |
| 2038          | \$0.23                         | \$0.33    | \$0.51   |
| 2039          | \$0.26                         | \$0.38    | \$0.57   |
| 2040          | \$0.29                         | \$0.42    | \$0.63   |
| 2041          | \$0.32                         | \$0.46    | \$0.69   |
| 2042          | \$0.34                         | \$0.49    | \$0.74   |
| 2043          | \$0.37                         | \$0.53    | \$0.8    |
| 2044          | \$0.4                          | \$0.57    | \$0.85   |
| 2045          | \$0.42                         | \$0.6     | \$0.9    |
| 2046          | \$0.44                         | \$0.63    | \$0.94   |
| 2047          | \$0.46                         | \$0.66    | \$0.97   |
| 2048          | \$0.48                         | \$0.68    | \$1      |
| 2049          | \$0.5                          | \$0.7     | \$1      |
| 2050          | \$0.51                         | \$0.73    | \$1.1    |
| 2051          | \$0.53                         | \$0.74    | \$1.1    |
| 2052          | \$0.54                         | \$0.76    | \$1.1    |
| 2053          | \$0.55                         | \$0.78    | \$1.1    |
| 2054          | \$0.56                         | \$0.79    | \$1.1    |
| 2055          | \$0.57                         | \$0.8     | \$1.2    |
| PV            | \$5.2                          | \$8.2     | \$13     |
| AV            | \$0.26                         | \$0.38    | \$0.58   |

Note: Climate benefits are based on changes (reductions) in N<sub>2</sub>O emissions and are calculated using updated estimates of the SC-N<sub>2</sub>O from U.S. EPA (EPA 2023f). Climate benefits include changes in vehicle, EGU and refinery N<sub>2</sub>O emissions.

**Table 9-13: : Benefits of reduced GHG emissions from the final standards.**

| Calendar Year | Near-term Ramsey Discount Rate |         |         |
|---------------|--------------------------------|---------|---------|
|               | 2.5%                           | 2.0%    | 1.5%    |
| 2027          | \$0.063                        | \$0.1   | \$0.17  |
| 2028          | \$0.54                         | \$0.87  | \$1.5   |
| 2029          | \$1.9                          | \$3     | \$5     |
| 2030          | \$3.9                          | \$6.2   | \$10    |
| 2031          | \$6.6                          | \$10    | \$17    |
| 2032          | \$9.8                          | \$15    | \$26    |
| 2033          | \$15                           | \$23    | \$38    |
| 2034          | \$20                           | \$31    | \$52    |
| 2035          | \$26                           | \$40    | \$66    |
| 2036          | \$31                           | \$49    | \$80    |
| 2037          | \$37                           | \$57    | \$93    |
| 2038          | \$42                           | \$65    | \$110   |
| 2039          | \$48                           | \$74    | \$120   |
| 2040          | \$53                           | \$82    | \$130   |
| 2041          | \$58                           | \$89    | \$140   |
| 2042          | \$63                           | \$96    | \$150   |
| 2043          | \$67                           | \$100   | \$160   |
| 2044          | \$72                           | \$110   | \$170   |
| 2045          | \$76                           | \$120   | \$180   |
| 2046          | \$80                           | \$120   | \$190   |
| 2047          | \$83                           | \$130   | \$200   |
| 2048          | \$87                           | \$130   | \$210   |
| 2049          | \$90                           | \$130   | \$210   |
| 2050          | \$92                           | \$140   | \$220   |
| 2051          | \$94                           | \$140   | \$220   |
| 2052          | \$96                           | \$140   | \$220   |
| 2053          | \$98                           | \$150   | \$230   |
| 2054          | \$99                           | \$150   | \$230   |
| 2055          | \$100                          | \$150   | \$230   |
| PV            | \$950                          | \$1,600 | \$2,800 |
| AV            | \$46                           | \$72    | \$120   |

Note: Climate benefits are based on changes (reductions) in GHG emissions and are calculated using updated estimates of the SC-GHG from U.S. EPA (EPA 2023f). Climate benefits include changes in vehicle, EGU and refinery GHG emissions.

**Table 9-14: Benefits of reduced GHG emissions from Alternative A.**

| Calendar Year | Near-term Ramsey Discount Rate |         |         |
|---------------|--------------------------------|---------|---------|
|               | 2.5%                           | 2.0%    | 1.5%    |
| 2027          | \$0.85                         | \$1.4   | \$2.3   |
| 2028          | \$2.5                          | \$3.9   | \$6.6   |
| 2029          | \$5                            | \$8     | \$13    |
| 2030          | \$7.9                          | \$13    | \$21    |
| 2031          | \$11                           | \$18    | \$29    |
| 2032          | \$15                           | \$23    | \$38    |
| 2033          | \$19                           | \$31    | \$50    |
| 2034          | \$25                           | \$39    | \$64    |
| 2035          | \$30                           | \$47    | \$78    |
| 2036          | \$36                           | \$56    | \$91    |
| 2037          | \$41                           | \$64    | \$100   |
| 2038          | \$46                           | \$72    | \$120   |
| 2039          | \$52                           | \$80    | \$130   |
| 2040          | \$57                           | \$88    | \$140   |
| 2041          | \$61                           | \$94    | \$150   |
| 2042          | \$66                           | \$100   | \$160   |
| 2043          | \$70                           | \$110   | \$170   |
| 2044          | \$75                           | \$110   | \$180   |
| 2045          | \$78                           | \$120   | \$190   |
| 2046          | \$82                           | \$120   | \$200   |
| 2047          | \$85                           | \$130   | \$200   |
| 2048          | \$88                           | \$130   | \$210   |
| 2049          | \$91                           | \$140   | \$220   |
| 2050          | \$94                           | \$140   | \$220   |
| 2051          | \$96                           | \$140   | \$220   |
| 2052          | \$98                           | \$150   | \$230   |
| 2053          | \$99                           | \$150   | \$230   |
| 2054          | \$100                          | \$150   | \$230   |
| 2055          | \$100                          | \$150   | \$230   |
| PV            | \$1,000                        | \$1,700 | \$2,900 |
| AV            | \$49                           | \$77    | \$130   |

Note: Climate benefits are based on changes (reductions) in GHG emissions and are calculated using updated estimates of the SC-GHG from U.S. EPA (EPA 2023f). Climate benefits include changes in vehicle, EGU and refinery GHG emissions.

**Table 9-15: Benefits of reduced GHG emissions from Alternative B.**

| Calendar Year | Near-term Ramsey Discount Rate |         |         |
|---------------|--------------------------------|---------|---------|
|               | 2.5%                           | 2.0%    | 1.5%    |
| 2027          | \$0.043                        | \$0.068 | \$0.12  |
| 2028          | \$0.47                         | \$0.76  | \$1.3   |
| 2029          | \$1.7                          | \$2.8   | \$4.7   |
| 2030          | \$3.7                          | \$5.9   | \$9.8   |
| 2031          | \$6.1                          | \$9.6   | \$16    |
| 2032          | \$9.1                          | \$14    | \$24    |
| 2033          | \$13                           | \$21    | \$35    |
| 2034          | \$18                           | \$28    | \$46    |
| 2035          | \$22                           | \$35    | \$58    |
| 2036          | \$27                           | \$42    | \$69    |
| 2037          | \$31                           | \$49    | \$80    |
| 2038          | \$36                           | \$55    | \$90    |
| 2039          | \$40                           | \$62    | \$100   |
| 2040          | \$44                           | \$68    | \$110   |
| 2041          | \$48                           | \$74    | \$120   |
| 2042          | \$52                           | \$80    | \$130   |
| 2043          | \$56                           | \$86    | \$140   |
| 2044          | \$60                           | \$92    | \$150   |
| 2045          | \$64                           | \$97    | \$150   |
| 2046          | \$67                           | \$100   | \$160   |
| 2047          | \$70                           | \$110   | \$170   |
| 2048          | \$73                           | \$110   | \$170   |
| 2049          | \$76                           | \$110   | \$180   |
| 2050          | \$78                           | \$120   | \$180   |
| 2051          | \$79                           | \$120   | \$190   |
| 2052          | \$81                           | \$120   | \$190   |
| 2053          | \$82                           | \$120   | \$190   |
| 2054          | \$83                           | \$120   | \$190   |
| 2055          | \$84                           | \$120   | \$190   |
| PV            | \$800                          | \$1,300 | \$2,300 |
| AV            | \$39                           | \$61    | \$100   |

Note: Climate benefits are based on changes (reductions) in GHG emissions and are calculated using updated estimates of the SC-GHG from U.S. EPA (EPA 2023f). Climate benefits include changes in vehicle, EGU and refinery GHG emissions.

Unlike many environmental problems where the causes and impacts are distributed more locally, GHG emissions are a global externality making climate change a true global challenge. GHG emissions contribute to damages around the world regardless of where they are emitted. Because of the distinctive global nature of climate change, in the RIA for this final rule the EPA centers attention on a global measure of climate benefits from GHG reductions. Consistent with all IWG recommended SC-GHG estimates to date, the SC-GHG values presented in Section 6 provide a global measure of monetized damages from CO<sub>2</sub>, CH<sub>4</sub>, and N<sub>2</sub>O and Table 9-10 through Table 9-12 present the monetized global climate benefits of the CO<sub>2</sub>, CH<sub>4</sub>, and N<sub>2</sub>O emission reductions expected from the final rule. This approach is the same as that taken in EPA

regulatory analyses from 2009 through 2016 and since 2021. It is also consistent with OMB Circular A-4 guidance that states when a regulation is likely to have international effects, “these effects should be reported.”<sup>251</sup> EPA also notes that EPA’s cost estimates in RIAs, including the cost estimates contained in this RIA, regularly do not differentiate between the share of compliance costs expected to accrue to U.S. firms versus foreign interests, such as to foreign investors in regulated entities.<sup>252</sup> A global perspective on climate effects is therefore consistent with the approach EPA takes on costs. There are many reasons, as summarized in this section—and as articulated by OMB and in IWG assessments (IWG 2010) (IWG 2013) (IWG 2016a) (IWG 2016b) (IWG 2021), the 2015 Response to Comments (IWG 2015), and in detail in U.S. EPA (EPA 2023f) and in Appendix A of the Response to Comments document for the December 2023 Final Oil and Gas NSPS/EG Rulemaking—why the EPA focuses on the global value of climate change impacts when analyzing policies that affect GHG emissions.

International cooperation and reciprocity are essential to successfully addressing climate change, as the global nature of greenhouse gases means that a ton of GHGs emitted in any other country harms individuals in the U.S. just as much as a ton emitted within the territorial U.S. Assessing the benefits of U.S. GHG mitigation activities requires consideration of how those actions may affect mitigation activities by other countries, as those international mitigation actions will provide a benefit to U.S. citizens and residents by mitigating climate impacts that affect U.S. citizens and residents. This is a classic public goods problem because each country’s reductions benefit everyone else, and no country can be excluded from enjoying the benefits of other countries’ reductions. The only way to achieve an efficient allocation of resources for emissions reduction on a global basis—and so benefit the U.S. and its citizens and residents—is for all countries to base their policies on global estimates of damages. A wide range of scientific and economic experts have emphasized the issue of international cooperation and reciprocity as support for assessing global damages of GHG emission in domestic policy analysis. Using a global estimate of damages in U.S. analyses of regulatory actions allows the U.S. to continue to actively encourage other nations, including emerging major economies, to also assess global climate damages of their policies and to take steps to reduce emissions. For example, many

---

<sup>251</sup> While OMB Circular A-4 recommends that international effects be reported separately, the guidance also explains that “[d]ifferent regulations may call for different emphases in the analysis, depending on the nature and complexity of the regulatory issues.” Circular A-4 (2023) states that “[i]n certain contexts, it may be particularly appropriate to include effects experienced by noncitizens residing abroad in your primary analysis. Such contexts include, for example, when:

- assessing effects on noncitizens residing abroad provides a useful proxy for effects on U.S. citizens and residents that are difficult to otherwise estimate;
- assessing effects on noncitizens residing abroad provides a useful proxy for effects on U.S. national interests that are not otherwise fully captured by effects experienced by particular U.S. citizens and residents (e.g., national security interests, diplomatic interests, etc.);
- regulating an externality on the basis of its global effects supports a cooperative international approach to the regulation of the externality by potentially inducing other countries to follow suit or maintain existing efforts; or
- international or domestic legal obligations require or support a global calculation of regulatory effects”.

<sup>252</sup> For example, in the RIA for the 2018 Proposed Reconsideration of the Oil and Natural Gas Sector Emission Standards for New, Reconstructed, and Modified Sources, the EPA acknowledged that some portion of regulatory costs will likely “accru[e] to entities outside U.S. borders” through foreign ownership, employment, or consumption (EPA 2018). In general, a significant share of U.S. corporate debt and equities are foreign-owned, including in the oil and gas industry.



countries and international institutions have already explicitly adapted the global SC-GHG estimates used by EPA in their domestic analyses (e.g., Canada, Israel) or developed their own estimates of global damages (e.g., Germany), and recently, there has been renewed interest by other countries to update their estimates since the draft release of the updated SC-GHG estimates presented in the December 2022 Oil and Gas NSPS/EG Supplemental Proposal RIA.<sup>253</sup> Several recent studies have empirically examined the evidence on international GHG mitigation reciprocity, through both policy diffusion and technology diffusion effects. See U.S. EPA (EPA 2023f) for more discussion.

For all of these reasons, the EPA believes that a global metric is appropriate for assessing the climate benefits of avoided GHG emissions in this final RIA. In addition, as emphasized in the (National Academies 2017) recommendations, “[i]t is important to consider what constitutes a domestic impact in the case of a global pollutant that could have international implications that impact the United States.” The global nature of GHG pollution and its impacts means that U.S. interests are affected by climate change impacts through a multitude of pathways and these need to be considered when evaluating the benefits of GHG mitigation to U.S. citizens and residents. The increasing interconnectedness of global economies and populations means that impacts occurring outside of U.S. borders can have significant impacts on U.S. interests. Examples of affected interests include direct effects on U.S. citizens and assets located abroad, international trade, and tourism, and spillover pathways such as economic and political destabilization and global migration that can lead to adverse impacts on U.S. national security, public health, and humanitarian concerns. Those impacts point to the global nature of the climate change problem and are better captured within global measures of the social cost of greenhouse gases.

In the case of these global pollutants, for the reasons articulated in this section, the assessment of global net damages of GHG emissions allows EPA to fully disclose and contextualize the net climate benefits of GHG emission reductions expected from this final rule. As EPA explained in the final Oil and Gas NSPS/EG rule, EPA disagrees with public comments received on the December 2022 Oil and Gas NSPS/EG Supplemental Proposal that suggested that the EPA can or should use a metric focused on benefits resulting solely from changes in climate impacts occurring within U.S. borders.<sup>254</sup> The global models used in the SC-GHG modeling described above do not lend themselves to be disaggregated in a way that could provide sufficiently robust information about the distribution of the rule's climate benefits to citizens and residents of particular countries, or population groups across the globe and within the U.S. Two of the models used to inform the damage module, the GIVE and DSCIM models, have spatial resolution that allows for some geographic disaggregation of future climate impacts across the world. This permits the calculation of a partial GIVE and DSCIM-based SC-GHG measuring the damages from four or five climate impact categories projected to physically occur within the

---

<sup>253</sup> In April 2023, the government of Canada announced the publication of an interim update to their SC-GHG guidance, recommending SC-GHG estimates identical to the EPA's updated estimates presented in the December 2022 Supplemental Proposal RIA. The Canadian interim guidance will be used across all Canadian federal departments and agencies, with the values expected to be finalized by the end of the year. See more at <https://www.canada.ca/en/environment-climate-change/services/climate-change/science-research-data/social-cost-ghg.html>

<sup>254</sup> EPA is noting this for informational purposes only. We are not reopening the Oil and Gas NSPS/EG Rule in this proceeding.

U.S., respectively, subject to caveats. As discussed at length in U.S. EPA (EPA 2023f), these damage modules are only a partial accounting and do not capture all of the pathways through which climate change affects public health and welfare. For example, this modeling omits most of the consequences of changes in precipitation, damages from extreme weather events (e.g., wildfires), the potential for nongradual damages from passing critical thresholds (e.g., tipping elements) in natural or socioeconomic systems, and non-climate mediated effects of GHG emissions other than CO<sub>2</sub> fertilization (e.g., tropospheric ozone formation due to CH<sub>4</sub> emissions). Thus, they only cover a subset of potential climate change impacts. Furthermore, as discussed at length in U.S. EPA (EPA, 2023f), the damage modules do not capture spillover or indirect effects whereby climate impacts in one country or region can affect the welfare of residents in other countries or regions—such as through the effect of climate change on international markets, trade, tourism, and other activities. Supply chain disruptions are a prominent pathway through which U.S. business and consumers can be affected by climate change impacts abroad. Additional climate change-induced international spillovers can occur through pathways such as damages across transboundary resources, economic and political destabilization, and global migration that can lead to adverse impacts on U.S. national security, public health, and humanitarian concerns.

Additional modeling efforts can and have shed further light on some omitted damage categories. For example, the Framework for Evaluating Damages and Impacts (FrEDI) is an open-source modeling framework developed by the EPA<sup>255</sup> to facilitate the characterization of net annual climate change impacts in numerous impact categories within the contiguous U.S. and monetize the associated distribution of modeled damages (Sarofim, et al. 2021) (EPA 2021). The additional impact categories included in FrEDI reflect the availability of U.S.-specific data and research on climate change effects. As discussed in U.S. EPA (EPA 2023f) results from FrEDI show that annual damages resulting from climate change impacts within the contiguous U.S. (CONUS) (i.e., excluding Hawaii, Alaska, and U.S. territories) and for impact categories not represented in GIVE and DSCIM are expected to be substantial. As discussed in U.S. EPA (EPA 2021), results from FrEDI show that annual damages resulting from climate change impacts within the contiguous U.S. (CONUS) (i.e., excluding Hawaii, Alaska, and U.S. territories) and for impact categories not represented in GIVE and DSCIM are expected to be substantial. For example, FrEDI estimates a partial SC-CO<sub>2</sub> of \$41/mtCO<sub>2</sub> for damages physically occurring within CONUS for 2030 emissions (under a 2 percent near-term Ramsey discount rate) (Hartin, McDuffie, et al. 2023), compared to a GIVE and DSCIM-based U.S.-specific SC-CO<sub>2</sub> of \$18/mtCO<sub>2</sub> and \$16/mtCO<sub>2</sub>, respectively, for 2030 emissions (2022 USD). While the FrEDI results help to illustrate how monetized damages physically occurring within CONUS increase as more impacts are reflected in the modeling framework, they are still subject to many of the same limitations associated with the DSCIM and GIVE damage modules, including the omission or

---

<sup>255</sup> The FrEDI framework and Technical Documentation have been subject to a public review comment period and an independent external peer review, following guidance in the EPA Peer-Review Handbook for Influential Scientific Information (ISI). Information on the FrEDI peer-review is available at the EPA Science Inventory.

partial modeling of important damage categories.<sup>256,257</sup> Finally, none of these modeling efforts—GIVE, DSCIM, and FrEDI—reflect non-climate mediated effects of GHG emissions experienced by U.S. populations (other than CO<sub>2</sub> fertilization effects on agriculture). In addition to its climate impacts, methane also contributes to the chemical formation of tropospheric ozone, which contributes to mortality. One recent paper on this effect, (McDuffie, et al. 2023) estimated the monetized increase in respiratory-related human mortality risk from the ozone produced from a marginal pulse of methane emissions. Using the socioeconomics from the RFF-SPs and the 2 percent near-term Ramsey discounting approach, this additional health risk to U.S. populations is on the order of approximately \$360/mtCH<sub>4</sub> (2022 USD) for 2030 emissions.

Applying the U.S.-specific partial SC-GHG estimates derived from the multiple lines of evidence described above to the GHG emissions reduction expected under the final rule would yield substantial benefits. For example, the present value of the climate benefits of the final rule as measured by FrEDI from climate change impacts in CONUS are estimated to be \$231 billion (under a 2 percent near-term Ramsey discount rate).<sup>258</sup> However, the numerous explicitly omitted damage categories and other modeling limitations discussed above and throughout U.S. EPA (EPA 2023f) make it likely that these estimates underestimate the benefits to U.S. citizens and residents of the GHG reductions from the final rule; the limitations in developing a U.S.-specific estimate that accurately captures direct and spillover effects on U.S. citizens and residents further demonstrates that it is more appropriate to use a global measure of climate benefits from GHG reductions. The EPA will continue to review developments in the literature, including more robust methodologies for estimating the magnitude of the various damages to U.S. populations from climate impacts and reciprocal international mitigation activities, and explore ways to better inform the public of the full range of GHG impacts.

---

<sup>256</sup> Another method that has produced estimates of the effect of climate change on U.S.-specific outcomes uses a top-down approach to estimate aggregate damage functions. Published research using this approach include total-economy empirical studies that econometrically estimate the relationship between GDP and a climate variable, usually temperature. As discussed in U.S. EPA (EPA 2023f) the modeling framework used in the existing published studies using this approach differ in important ways from the inputs underlying the SC-GHG estimates described above (e.g., discounting, risk aversion, and scenario uncertainty) and focus solely on SC-CO<sub>2</sub>. Hence, we do not consider this line of evidence in the analysis for this RIA. Updating the framework of total-economy empirical damage functions to be consistent with the methods described in this RIA and *ibid.* would require new analysis. Finally, because total-economy empirical studies estimate market impacts, they do not include any non-market impacts of climate change (e.g., heat related mortality) and therefore are also only a partial estimate. The EPA will continue to review developments in the literature and explore ways to better inform the public of the full range of GHG impacts.

<sup>257</sup> FrEDI estimates a partial SC-CH<sub>4</sub> (N<sub>2</sub>O) of \$660/mtCH<sub>4</sub> (\$12,000/mtN<sub>2</sub>O) for damages physically occurring within CONUS for 2030 emissions (under a 2 percent near-term Ramsey discount rate) (Hartin, et al. 2023) compared to a GIVE and DSCIM-based U.S.-specific SC-CH<sub>4</sub> of \$310/mtCH<sub>4</sub> (\$5,600/mtN<sub>2</sub>O) and \$84/mtCH<sub>4</sub> (\$4,300/mtN<sub>2</sub>O), respectively, for 2030 emissions (2022 USD).

<sup>258</sup> DSCIM and GIVE use global damage functions. Damage functions based on only U.S.-data and research, but not for other parts of the world, were not included in those models. FrEDI does make use of some of this U.S.-specific data and research and as a result has a broader coverage of climate impact categories.

## 9.5 Criteria Air Pollutant Benefits

For the analysis of the final standards, we use the same reduced-form “benefit-per-ton” (BPT) approach used in the proposal to estimate the monetized PM<sub>2.5</sub>-related health benefits of the final standards, except the constant dollar year has been updated from year 2020 dollars to year 2022 dollars. As described in RIA Chapter 6.4, the BPT approach monetizes avoided premature deaths and illnesses that are expected to occur as a result of reductions in directly-emitted PM<sub>2.5</sub> and PM<sub>2.5</sub> precursors attributable to the standards. The upstream BPT estimates used in this final rule are the same as those used in the proposal and were also updated to year 2022 dollars. A chief limitation to using PM<sub>2.5</sub>-related BPT values is that they do not reflect benefits associated with reducing ambient concentrations of ozone, direct exposure to NO<sub>2</sub>, or exposure to mobile source air toxics, nor do they account for improved ecosystem effects or visibility. The estimated benefits of the final standards would be larger if we were able to monetize these unquantified benefits at this time.

Using the BPT approach, we estimate the annualized value of PM<sub>2.5</sub>-related benefits of the final standards to be \$5.3 to \$10 billion at a 3% discount rate and \$3.6 to \$7.2 billion at a 7% discount rate. Benefits are reported in year 2022 dollars and reflect the PM<sub>2.5</sub>-related benefits associated with reductions in NO<sub>x</sub>, SO<sub>2</sub>, and direct PM<sub>2.5</sub> emissions. Because premature mortality typically constitutes the vast majority of monetized benefits in a PM<sub>2.5</sub> benefits assessment, we present PM benefits based on risk estimates reported from two different long-term exposure studies using different cohorts to account for uncertainty in the benefits associated with avoiding PM-related premature deaths: the National Health Interview Survey (NHIS) cohort study (Pope III et al. 2019) and an extended analysis of the Medicare cohort (Wu et al. 2020).

Table 9-16 presents the annual, undiscounted PM<sub>2.5</sub>-related health benefits estimated for the stream of years beginning with the first year of rule implementation, 2027, through 2055 for the final standards. Benefits are presented by source (onroad and upstream) and are estimated using either a 3 percent or 7 percent discount rate to account for annual avoided health outcomes that are expected to accrue over more than a single year (the “cessation” lag between the change in PM exposures and the total realization of changes in health effects). Table 9-16 also shows the present and annualized values of PM<sub>2.5</sub>-related benefits for the final program between 2027 and 2055 (discounted back to 2027). Table 9-17 and Table 9-18 present the results for each of the alternatives.

We use a constant 3-percent and 7-percent discount rate to calculate present and annualized values in Table 9-17, consistent with current applicable OMB Circular A-4 guidance. For the purposes of presenting total net benefits (see RIA Chapter 9.6), we also use a constant 2-percent discount rate to calculate present and annualized values. We note that we do not currently have BPT estimates that use a 2-percent discount rate to account for cessation lag. If we discount the stream of annual benefits in Table 9-17 based on the 3-percent cessation lag BPT using a constant 2-percent discount rate, the present value of total PM<sub>2.5</sub>-related benefits would be \$120 to \$240 billion and the annualized value of total PM<sub>2.5</sub>-related benefits would be \$6.4 to \$13 billion, depending on the assumed long-term exposure study of PM<sub>2.5</sub>-related premature mortality risk.

This analysis includes many data sources that are each subject to uncertainty, including projected emission inventories, air quality data from models, population data, population estimates, health effect estimates from epidemiology studies, economic data, and assumptions

regarding the future state of the world (i.e., regulations, technology, and human behavior). When compounded, even small uncertainties can greatly influence the size of the total quantified benefits. There are also inherent limitations associated with using the BPT approach. Despite these uncertainties, we believe the criteria pollutant benefits presented here are our best estimate of benefits absent air quality modeling and we have confidence in the BPT approach and the appropriateness of relying on BPT health estimates for this rulemaking. Please refer to RIA Chapter 6 for more information on the uncertainty associated with the benefits presented here.

**Table 9-16: Monetized PM<sub>2.5</sub> health benefits of onroad and upstream emissions reductions associated with the final standards (billions of 2022 dollars).**

| Calendar Year    | Total Onroad     |                  | Total Upstream    |                   | Total Benefits   |                  |
|------------------|------------------|------------------|-------------------|-------------------|------------------|------------------|
|                  | 3% Discount Rate | 7% Discount Rate | 3% Discount Rate  | 7% Discount Rate  | 3% Discount Rate | 7% Discount Rate |
| 2027             | 0.078 to 0.17    | 0.07 to 0.15     | -0.0087 to -0.019 | -0.0078 to -0.017 | 0.069 to 0.15    | 0.062 to 0.13    |
| 2028             | 0.21 to 0.45     | 0.19 to 0.41     | -0.034 to -0.072  | -0.03 to -0.064   | 0.18 to 0.38     | 0.16 to 0.34     |
| 2029             | 0.38 to 0.81     | 0.34 to 0.73     | -0.064 to -0.14   | -0.057 to -0.12   | 0.31 to 0.67     | 0.28 to 0.61     |
| 2030             | 0.74 to 1.5      | 0.66 to 1.4      | -0.12 to -0.25    | -0.11 to -0.23    | 0.61 to 1.3      | 0.55 to 1.1      |
| 2031             | 1 to 2.1         | 0.93 to 1.9      | -0.2 to -0.42     | -0.18 to -0.38    | 0.84 to 1.7      | 0.75 to 1.6      |
| 2032             | 1.3 to 2.8       | 1.2 to 2.5       | -0.26 to -0.53    | -0.23 to -0.47    | 1.1 to 2.2       | 0.98 to 2        |
| 2033             | 1.8 to 3.6       | 1.6 to 3.3       | -0.29 to -0.59    | -0.26 to -0.53    | 1.5 to 3         | 1.3 to 2.7       |
| 2034             | 2.2 to 4.5       | 1.9 to 4         | -0.29 to -0.59    | -0.26 to -0.53    | 1.9 to 3.9       | 1.7 to 3.5       |
| 2035             | 2.9 to 5.9       | 2.6 to 5.3       | -0.28 to -0.55    | -0.25 to -0.5     | 2.6 to 5.3       | 2.4 to 4.8       |
| 2036             | 3.3 to 6.7       | 3 to 6.1         | -0.23 to -0.45    | -0.21 to -0.4     | 3.1 to 6.3       | 2.8 to 5.7       |
| 2037             | 3.8 to 7.7       | 3.4 to 6.9       | -0.15 to -0.29    | -0.13 to -0.26    | 3.7 to 7.4       | 3.3 to 6.7       |
| 2038             | 4.3 to 8.7       | 3.9 to 7.8       | -0.053 to -0.096  | -0.049 to -0.085  | 4.3 to 8.6       | 3.8 to 7.8       |
| 2039             | 4.8 to 9.7       | 4.3 to 8.7       | 0.058 to 0.13     | 0.051 to 0.12     | 4.9 to 9.8       | 4.4 to 8.9       |
| 2040             | 6 to 12          | 5.4 to 11        | 0.21 to 0.43      | 0.19 to 0.38      | 6.2 to 12        | 5.5 to 11        |
| 2041             | 6.4 to 13        | 5.8 to 11        | 0.3 to 0.6        | 0.27 to 0.54      | 6.7 to 13        | 6.1 to 12        |
| 2042             | 6.9 to 14        | 6.2 to 12        | 0.39 to 0.8       | 0.35 to 0.71      | 7.3 to 14        | 6.5 to 13        |
| 2043             | 7.3 to 14        | 6.5 to 13        | 0.49 to 1         | 0.45 to 0.89      | 7.7 to 15        | 7 to 14          |
| 2044             | 7.6 to 15        | 6.8 to 14        | 0.6 to 1.2        | 0.54 to 1.1       | 8.2 to 16        | 7.4 to 15        |
| 2045             | 8.7 to 17        | 7.8 to 15        | 0.7 to 1.4        | 0.63 to 1.3       | 9.4 to 18        | 8.5 to 17        |
| 2046             | 9.1 to 18        | 8.1 to 16        | 0.77 to 1.5       | 0.69 to 1.4       | 9.8 to 19        | 8.8 to 17        |
| 2047             | 9.4 to 18        | 8.4 to 16        | 0.83 to 1.7       | 0.75 to 1.5       | 10 to 20         | 9.1 to 18        |
| 2048             | 9.6 to 19        | 8.6 to 17        | 0.89 to 1.8       | 0.8 to 1.6        | 10 to 21         | 9.4 to 19        |
| 2049             | 9.8 to 19        | 8.8 to 17        | 0.95 to 1.9       | 0.85 to 1.7       | 11 to 21         | 9.7 to 19        |
| 2050             | 11 to 21         | 9.7 to 19        | 0.99 to 2         | 0.9 to 1.8        | 12 to 23         | 11 to 21         |
| 2051             | 11 to 21         | 9.8 to 19        | 1 to 2            | 0.9 to 1.8        | 12 to 23         | 11 to 21         |
| 2052             | 11 to 21         | 10 to 19         | 1 to 2            | 0.91 to 1.8       | 12 to 23         | 11 to 21         |
| 2053             | 11 to 22         | 10 to 19         | 1 to 2            | 0.91 to 1.8       | 12 to 24         | 11 to 21         |
| 2054             | 11 to 22         | 10 to 20         | 1 to 2            | 0.91 to 1.8       | 12 to 24         | 11 to 21         |
| 2055             | 12 to 23         | 11 to 21         | 1 to 2            | 0.91 to 1.8       | 13 to 25         | 12 to 23         |
| Present Value    | 97 to 190        | 43 to 86         | 4.6 to 9.3        | 1.3 to 2.6        | 100 to 200       | 45 to 88         |
| Annualized Value | 5.1 to 10        | 3.5 to 7         | 0.24 to 0.49      | 0.11 to 0.22      | 5.3 to 10        | 3.6 to 7.2       |

The benefits in this table reflect two separate but equally plausible premature mortality estimates derived from the Medicare study (Wu et al. 2020) or the NHIS study (Pope III et al. 2019), respectively. All benefits estimates are rounded to two significant figures. Annual benefit values presented here are not discounted. Negative values are health disbenefits related to increases in estimated emissions. The present value of benefits is the total aggregated value of the series of discounted annual benefits that occur between 2027-2055 (in 2022 dollars) using either a 3 percent or 7 percent discount rate. The upstream impacts associated with the standards presented here include health benefits associated with reduced criteria pollutant emissions from refineries and health disbenefits associated with increased criteria pollutant emissions from EGUs. The benefits in this table also do not include the full complement of health and environmental benefits (such as health benefits related to reduced ozone exposure) that, if quantified and monetized, would increase the total monetized benefits.

**Table 9-17: Monetized PM<sub>2.5</sub> health benefits of onroad and upstream emissions reductions associated with Alternative A (billions of 2022 dollars).**

| Calendar Year    | Total Onroad     |                  | Total Upstream   |                  | Total Benefits   |                  |
|------------------|------------------|------------------|------------------|------------------|------------------|------------------|
|                  | 3% Discount Rate | 7% Discount Rate | 3% Discount Rate | 7% Discount Rate | 3% Discount Rate | 7% Discount Rate |
| 2027             | 0.1 to 0.21      | 0.09 to 0.19     | -0.059 to -0.12  | -0.053 to -0.11  | 0.042 to 0.09    | 0.037 to 0.081   |
| 2028             | 0.25 to 0.54     | 0.23 to 0.49     | -0.15 to -0.33   | -0.14 to -0.29   | 0.1 to 0.21      | 0.089 to 0.19    |
| 2029             | 0.43 to 0.93     | 0.39 to 0.83     | -0.17 to -0.35   | -0.15 to -0.31   | 0.27 to 0.58     | 0.24 to 0.52     |
| 2030             | 0.8 to 1.7       | 0.72 to 1.5      | -0.23 to -0.46   | -0.2 to -0.42    | 0.57 to 1.2      | 0.52 to 1.1      |
| 2031             | 1.1 to 2.3       | 1 to 2.1         | -0.3 to -0.61    | -0.27 to -0.55   | 0.81 to 1.7      | 0.73 to 1.5      |
| 2032             | 1.4 to 2.9       | 1.3 to 2.6       | -0.33 to -0.68   | -0.3 to -0.61    | 1.1 to 2.3       | 0.98 to 2        |
| 2033             | 1.8 to 3.8       | 1.6 to 3.4       | -0.35 to -0.72   | -0.32 to -0.65   | 1.5 to 3.1       | 1.3 to 2.8       |
| 2034             | 2.2 to 4.6       | 2 to 4.2         | -0.33 to -0.67   | -0.3 to -0.6     | 1.9 to 4         | 1.7 to 3.6       |
| 2035             | 3 to 6.1         | 2.7 to 5.5       | -0.31 to -0.62   | -0.28 to -0.56   | 2.7 to 5.5       | 2.4 to 4.9       |
| 2036             | 3.4 to 6.9       | 3.1 to 6.2       | -0.24 to -0.48   | -0.22 to -0.43   | 3.2 to 6.5       | 2.9 to 5.8       |
| 2037             | 3.9 to 7.9       | 3.5 to 7.1       | -0.16 to -0.3    | -0.14 to -0.27   | 3.8 to 7.6       | 3.4 to 6.8       |
| 2038             | 4.4 to 8.9       | 4 to 8           | -0.047 to -0.083 | -0.044 to -0.073 | 4.4 to 8.8       | 3.9 to 7.9       |
| 2039             | 4.9 to 9.9       | 4.4 to 8.9       | 0.074 to 0.16    | 0.065 to 0.15    | 5 to 10          | 4.5 to 9         |
| 2040             | 6.1 to 12        | 5.4 to 11        | 0.24 to 0.49     | 0.21 to 0.44     | 6.3 to 12        | 5.7 to 11        |
| 2041             | 6.5 to 13        | 5.9 to 12        | 0.33 to 0.66     | 0.29 to 0.6      | 6.8 to 14        | 6.2 to 12        |
| 2042             | 6.9 to 14        | 6.2 to 12        | 0.42 to 0.86     | 0.38 to 0.77     | 7.4 to 15        | 6.6 to 13        |
| 2043             | 7.3 to 14        | 6.6 to 13        | 0.52 to 1.1      | 0.47 to 0.95     | 7.8 to 16        | 7 to 14          |
| 2044             | 7.7 to 15        | 6.9 to 14        | 0.63 to 1.3      | 0.56 to 1.1      | 8.3 to 16        | 7.4 to 15        |
| 2045             | 8.8 to 17        | 7.9 to 15        | 0.73 to 1.5      | 0.65 to 1.3      | 9.5 to 19        | 8.5 to 17        |
| 2046             | 9.1 to 18        | 8.2 to 16        | 0.79 to 1.6      | 0.71 to 1.4      | 9.9 to 19        | 8.9 to 17        |
| 2047             | 9.4 to 18        | 8.4 to 17        | 0.85 to 1.7      | 0.76 to 1.5      | 10 to 20         | 9.2 to 18        |
| 2048             | 9.6 to 19        | 8.7 to 17        | 0.91 to 1.8      | 0.82 to 1.6      | 11 to 21         | 9.5 to 19        |
| 2049             | 9.8 to 19        | 8.8 to 17        | 0.97 to 1.9      | 0.87 to 1.7      | 11 to 21         | 9.7 to 19        |
| 2050             | 11 to 21         | 9.7 to 19        | 1 to 2           | 0.91 to 1.8      | 12 to 23         | 11 to 21         |
| 2051             | 11 to 21         | 9.9 to 19        | 1 to 2.1         | 0.92 to 1.8      | 12 to 23         | 11 to 21         |
| 2052             | 11 to 21         | 10 to 19         | 1 to 2.1         | 0.92 to 1.8      | 12 to 24         | 11 to 21         |
| 2053             | 11 to 22         | 10 to 19         | 1 to 2.1         | 0.93 to 1.9      | 12 to 24         | 11 to 21         |
| 2054             | 11 to 22         | 10 to 20         | 1 to 2.1         | 0.92 to 1.8      | 12 to 24         | 11 to 21         |
| 2055             | 12 to 23         | 11 to 21         | 1 to 2           | 0.91 to 1.8      | 13 to 26         | 12 to 23         |
| Present Value    | 98 to 190        | 44 to 87         | 4.2 to 8.5       | 0.95 to 1.9      | 100 to 200       | 45 to 89         |
| Annualized Value | 5.1 to 10        | 3.6 to 7.1       | 0.22 to 0.44     | 0.077 to 0.15    | 5.4 to 11        | 3.7 to 7.3       |

The benefits in this table reflect two separate but equally plausible premature mortality estimates derived from the Medicare study (Wu et al. 2020) or the NHIS study (Pope III et al. 2019), respectively. All benefits estimates are rounded to two significant figures. Annual benefit values presented here are not discounted. Negative values are health disbenefits related to increases in estimated emissions. The present value of benefits is the total aggregated value of the series of discounted annual benefits that occur between 2027-2055 (in 2022 dollars) using either a 3 percent or 7 percent discount rate. The upstream impacts associated with the standards presented here include health benefits associated with reduced criteria pollutant emissions from refineries and health disbenefits associated with increased criteria pollutant emissions from EGUs. The benefits in this table also do not include the full complement of health and environmental benefits (such as health benefits related to reduced ozone exposure) that, if quantified and monetized, would increase the total monetized benefits.

**Table 9-18: Monetized PM<sub>2.5</sub> health benefits of onroad and upstream emissions reductions associated with Alternative B (billions of 2022 dollars).**

| Calendar Year    | Total Onroad     |                  | Total Upstream    |                   | Total Benefits   |                  |
|------------------|------------------|------------------|-------------------|-------------------|------------------|------------------|
|                  | 3% Discount Rate | 7% Discount Rate | 3% Discount Rate  | 7% Discount Rate  | 3% Discount Rate | 7% Discount Rate |
| 2027             | 0.077 to 0.16    | 0.069 to 0.15    | -0.0074 to -0.016 | -0.0067 to -0.014 | 0.07 to 0.15     | 0.063 to 0.13    |
| 2028             | 0.21 to 0.45     | 0.19 to 0.4      | -0.025 to -0.053  | -0.022 to -0.047  | 0.18 to 0.39     | 0.17 to 0.36     |
| 2029             | 0.38 to 0.8      | 0.34 to 0.72     | -0.054 to -0.11   | -0.049 to -0.1    | 0.32 to 0.69     | 0.29 to 0.62     |
| 2030             | 0.73 to 1.5      | 0.66 to 1.4      | -0.1 to -0.21     | -0.091 to -0.19   | 0.63 to 1.3      | 0.57 to 1.2      |
| 2031             | 1 to 2.1         | 0.93 to 1.9      | -0.16 to -0.34    | -0.15 to -0.3     | 0.87 to 1.8      | 0.78 to 1.6      |
| 2032             | 1.3 to 2.8       | 1.2 to 2.5       | -0.21 to -0.43    | -0.19 to -0.38    | 1.1 to 2.3       | 1 to 2.1         |
| 2033             | 1.7 to 3.6       | 1.6 to 3.3       | -0.25 to -0.52    | -0.23 to -0.46    | 1.5 to 3.1       | 1.3 to 2.8       |
| 2034             | 2.1 to 4.4       | 1.9 to 4         | -0.24 to -0.5     | -0.22 to -0.45    | 1.9 to 3.9       | 1.7 to 3.5       |
| 2035             | 2.9 to 5.8       | 2.6 to 5.3       | -0.22 to -0.43    | -0.2 to -0.39     | 2.7 to 5.4       | 2.4 to 4.9       |
| 2036             | 3.3 to 6.7       | 3 to 6           | -0.16 to -0.32    | -0.15 to -0.29    | 3.1 to 6.4       | 2.8 to 5.7       |
| 2037             | 3.8 to 7.6       | 3.4 to 6.8       | -0.095 to -0.18   | -0.087 to -0.16   | 3.7 to 7.4       | 3.3 to 6.7       |
| 2038             | 4.3 to 8.6       | 3.8 to 7.7       | -0.014 to -0.017  | -0.013 to -0.015  | 4.3 to 8.6       | 3.8 to 7.7       |
| 2039             | 4.8 to 9.6       | 4.3 to 8.6       | 0.079 to 0.17     | 0.07 to 0.15      | 4.8 to 9.8       | 4.3 to 8.8       |
| 2040             | 5.9 to 12        | 5.3 to 10        | 0.21 to 0.42      | 0.19 to 0.38      | 6.1 to 12        | 5.5 to 11        |
| 2041             | 6.3 to 13        | 5.7 to 11        | 0.28 to 0.57      | 0.25 to 0.51      | 6.6 to 13        | 6 to 12          |
| 2042             | 6.8 to 13        | 6.1 to 12        | 0.36 to 0.73      | 0.33 to 0.66      | 7.1 to 14        | 6.4 to 13        |
| 2043             | 7.1 to 14        | 6.4 to 13        | 0.45 to 0.9       | 0.4 to 0.81       | 7.6 to 15        | 6.8 to 14        |
| 2044             | 7.5 to 15        | 6.7 to 13        | 0.53 to 1.1       | 0.48 to 0.96      | 8 to 16          | 7.2 to 14        |
| 2045             | 8.6 to 17        | 7.7 to 15        | 0.62 to 1.2       | 0.56 to 1.1       | 9.2 to 18        | 8.3 to 16        |
| 2046             | 8.9 to 17        | 8 to 16          | 0.67 to 1.4       | 0.61 to 1.2       | 9.6 to 19        | 8.6 to 17        |
| 2047             | 9.2 to 18        | 8.3 to 16        | 0.73 to 1.5       | 0.66 to 1.3       | 9.9 to 19        | 8.9 to 18        |
| 2048             | 9.5 to 19        | 8.5 to 17        | 0.78 to 1.6       | 0.7 to 1.4        | 10 to 20         | 9.2 to 18        |
| 2049             | 9.7 to 19        | 8.7 to 17        | 0.83 to 1.7       | 0.74 to 1.5       | 11 to 21         | 9.4 to 19        |
| 2050             | 11 to 21         | 9.6 to 19        | 0.87 to 1.7       | 0.78 to 1.6       | 12 to 22         | 10 to 20         |
| 2051             | 11 to 21         | 9.7 to 19        | 0.87 to 1.7       | 0.79 to 1.6       | 12 to 23         | 10 to 20         |
| 2052             | 11 to 21         | 9.8 to 19        | 0.88 to 1.8       | 0.79 to 1.6       | 12 to 23         | 11 to 21         |
| 2053             | 11 to 21         | 9.9 to 19        | 0.88 to 1.8       | 0.79 to 1.6       | 12 to 23         | 11 to 21         |
| 2054             | 11 to 21         | 10 to 19         | 0.88 to 1.8       | 0.79 to 1.6       | 12 to 23         | 11 to 21         |
| 2055             | 12 to 23         | 11 to 21         | 0.87 to 1.8       | 0.79 to 1.6       | 13 to 25         | 12 to 22         |
| Present Value    | 96 to 190        | 43 to 85         | 4.3 to 8.6        | 1.3 to 2.6        | 100 to 200       | 44 to 87         |
| Annualized Value | 5 to 9.8         | 3.5 to 6.9       | 0.22 to 0.45      | 0.1 to 0.21       | 5.2 to 10        | 3.6 to 7.1       |

The benefits in this table reflect two separate but equally plausible premature mortality estimates derived from the Medicare study (Wu et al. 2020) or the NHIS study (Pope III et al. 2019), respectively. All benefits estimates are rounded to two significant figures. Annual benefit values presented here are not discounted. Negative values are health disbenefits related to increases in estimated emissions. The present value of benefits is the total aggregated value of the series of discounted annual benefits that occur between 2027-2055 (in 2022 dollars) using either a 3 percent or 7 percent discount rate. The upstream impacts associated with the standards presented here include health benefits associated with reduced criteria pollutant emissions from refineries and health disbenefits associated with increased criteria pollutant emissions from EGUs. The benefits in this table also do not include the full complement of health and environmental benefits (such as health benefits related to reduced ozone exposure) that, if quantified and monetized, would increase the total monetized benefits.

## 9.6 Summary and Net Benefits

We summarize the costs, savings, and benefits of the final rule, as shown in Table 9-19. Table 9-19 reproduces the final rule’s costs from Table 9-1, fuel savings less EVSE port costs from Table 9-4, non-emission benefits from Table 9-7, climate benefits from Table 9-13, and criteria air pollutant benefits from Table 9-16, in a single table. We summarize the costs, savings, and benefits of Alternatives A and B in Table 9-20 and Table 9-21, respectively.

**Table 9-19: Summary of costs, fuel savings and benefits of the final standards  
(billions of 2022 dollars)<sup>a,b,c,d</sup>.**

|   | <b>CY 2055</b> | <b>PV, 2%</b>  | <b>PV, 3%</b>  | <b>PV, 7%</b>  | <b>AV, 2%</b> | <b>AV, 3%</b> | <b>AV, 7%</b> |
|---|----------------|----------------|----------------|----------------|---------------|---------------|---------------|
| Vehicle Technology Costs                        | \$38           | \$870          | \$760          | \$450          | \$40          | \$39          | \$37          |
| Insurance Costs                                 | \$1.9          | \$33           | \$28           | \$15           | \$1.5         | \$1.4         | \$1.2         |
| Repair Costs                                    | -\$7.1         | -\$40          | -\$32          | -\$12          | -\$1.8        | -\$1.6        | -\$0.99       |
| Maintenance Costs                               | -\$35          | -\$300         | -\$250         | -\$110         | -\$14         | -\$13         | -\$9.3        |
| Congestion Costs                                | \$2.4          | \$25           | \$21           | \$10           | \$1.2         | \$1.1         | \$0.83        |
| Noise Costs                                     | \$0.04         | \$0.41         | \$0.34         | \$0.17         | \$0.019       | \$0.018       | \$0.014       |
| <b>Sum of Costs</b>                             | <b>\$0.59</b>  | <b>\$590</b>   | <b>\$530</b>   | <b>\$350</b>   | <b>\$27</b>   | <b>\$28</b>   | <b>\$29</b>   |
| Pre-tax Fuel Savings                            | \$94           | \$1,000        | \$840          | \$420          | \$46          | \$44          | \$34          |
| EVSE Port Costs                                 | \$8.6          | \$190          | \$160          | \$96           | \$9           | \$8.8         | \$7.9         |
| <b>Sum of Fuel Savings less EVSE Port Costs</b> | <b>\$86</b>    | <b>\$820</b>   | <b>\$680</b>   | <b>\$330</b>   | <b>\$37</b>   | <b>\$35</b>   | <b>\$26</b>   |
| Drive Value Benefits                            | \$4.7          | \$46           | \$38           | \$18           | \$2.1         | \$2           | \$1.5         |
| Refueling Time Benefits                         | -\$1.7         | -\$17          | -\$15          | -\$7.5         | -\$0.8        | -\$0.76       | -\$0.61       |
| Energy Security Benefits                        | \$4.1          | \$47           | \$39           | \$20           | \$2.1         | \$2           | \$1.6         |
| <b>Sum of Non-Emission Benefits</b>             | <b>\$7</b>     | <b>\$75</b>    | <b>\$62</b>    | <b>\$30</b>    | <b>\$3.4</b>  | <b>\$3.2</b>  | <b>\$2.5</b>  |
| Climate Benefits, 2% Near-term Ramsey           | \$150          | \$1,600        | \$1,600        | \$1,600        | \$72          | \$72          | \$72          |
| PM2.5 Health Benefits                           | \$25           | \$240          | \$200          | \$88           | \$13          | \$10          | \$7.2         |
| <b>Sum of Emission Benefits</b>                 | <b>\$170</b>   | <b>\$1,800</b> | <b>\$1,800</b> | <b>\$1,700</b> | <b>\$85</b>   | <b>\$83</b>   | <b>\$80</b>   |
| <b>Net Benefits</b>                             | <b>\$270</b>   | <b>\$2,100</b> | <b>\$2,000</b> | <b>\$1,700</b> | <b>\$99</b>   | <b>\$94</b>   | <b>\$80</b>   |

<sup>a</sup> Net benefits are emission benefits, non-emission benefits, and fuel savings (less EVSE port costs) minus the costs of the program. Values rounded to two significant figures; totals may not sum due to rounding. Present and annualized values are based on the stream of annual calendar year costs and benefits included in the analysis (2027 – 2055) and discounted back to year 2027. Climate benefits are based on reductions in GHG emissions and are calculated using three different SC-GHG estimates that assume either a 1.5 percent, 2.0 percent, or 2.5 percent near-term Ramsey discount rate. See EPA’s Report on the Social Cost of Greenhouse Gases: Estimates Incorporating Recent Scientific Advances (EPA, 2023). For presentational purposes in this table, we use the climate benefits associated with the SC-GHG estimates under the 2-percent near-term Ramsey discount rate. See Chapter 9.4 of this RIA for the full range of monetized climate benefit estimates. All other costs and benefits are discounted using either a 2-percent, 3-percent, or 7-percent constant discount rate. For further discussion of the SC-GHGs and how EPA accounted for these estimates, please refer to Chapter 6.2 of the RIA.

<sup>b</sup> To calculate net benefits, we use the monetized suite of total avoided PM2.5-related health effects that includes avoided deaths based on the Pope III et al., 2019 study, which is the larger of the two PM2.5 health benefits estimates presented in Chapter 9.5 of this RIA.

<sup>c</sup> The annual PM2.5 health benefits estimate presented in the CY 2055 column reflects the value of certain avoided health outcomes, such as avoided deaths, that are expected to accrue over more than a single year discounted using a 3-percent discount rate.

<sup>d</sup> We do not currently have year-over-year estimates of PM2.5 benefits that discount such annual health outcomes using a 2-percent discount rate. We have therefore discounted the annual stream of health benefits that reflect a 3-percent discount rate lag adjustment using a 2-percent discount rate to populate the PV, 2% and AV, 2% columns. The annual stream of PM2.5-related health benefits that reflect a 3-percent and 7-percent discount rate lag adjustment were used to populate the PV/AV 3% and PV/AV 7% columns, respectively. See Chapter 9.5 of this RIA for more details on the annual stream of PM2.5-related benefits associated with this rule.



**Table 9-20: Summary of costs, fuel savings and benefits of Alternative A  
(billions of 2022 dollars)<sup>a,b,c</sup>.**

|   | <b>CY 2055</b> | <b>PV, 2%</b>  | <b>PV, 3%</b>  | <b>PV, 7%</b>  | <b>AV, 2%</b> | <b>AV, 3%</b> | <b>AV, 7%</b> |
|---|----------------|----------------|----------------|----------------|---------------|---------------|---------------|
| Vehicle Technology Costs                        | \$39           | \$940          | \$820          | \$510          | \$43          | \$43          | \$41          |
| Insurance Costs                                 | \$1.9          | \$35           | \$30           | \$17           | \$1.6         | \$1.6         | \$1.4         |
| Repair Costs                                    | -\$7.3         | -\$40          | -\$31          | -\$12          | -\$1.8        | -\$1.6        | -\$0.94       |
| Maintenance Costs                               | -\$35          | -\$320         | -\$270         | -\$130         | -\$15         | -\$14         | -\$10         |
| Congestion Costs                                | \$2.4          | \$27           | \$23           | \$11           | \$1.2         | \$1.2         | \$0.92        |
| Noise Costs                                     | \$0.04         | \$0.44         | \$0.37         | \$0.18         | \$0.02        | \$0.019       | \$0.015       |
| Sum of Costs                                    | \$0.2          | \$640          | \$580          | \$400          | \$29          | \$30          | \$33          |
| Pre-tax Fuel Savings                            | \$95           | \$1,100        | \$910          | \$470          | \$50          | \$47          | \$38          |
| EVSE Port Costs                                 | \$8.6          | \$190          | \$160          | \$96           | \$9           | \$8.8         | \$7.9         |
| <b>Sum of Fuel Savings less EVSE Port Costs</b> | <b>\$86</b>    | <b>\$900</b>   | <b>\$750</b>   | <b>\$370</b>   | <b>\$41</b>   | <b>\$39</b>   | <b>\$30</b>   |
| Drive Value Benefits                            | \$4.7          | \$49           | \$41           | \$20           | \$2.2         | \$2.1         | \$1.7         |
| Refueling Time Benefits                         | -\$1.7         | -\$15          | -\$13          | -\$6.2         | -\$0.7        | -\$0.66       | -\$0.5        |
| Energy Security Benefits                        | \$4.1          | \$50           | \$42           | \$21           | \$2.3         | \$2.2         | \$1.8         |
| <b>Sum of Non-Emission Benefits</b>             | <b>\$7</b>     | <b>\$84</b>    | <b>\$70</b>    | <b>\$36</b>    | <b>\$3.8</b>  | <b>\$3.6</b>  | <b>\$2.9</b>  |
| Climate Benefits, 2% Near-term Ramsey           | \$150          | \$1,700        | \$1,700        | \$1,700        | \$77          | \$77          | \$77          |
| PM <sub>2.5</sub> Health Benefits               | \$26           | \$250          | \$200          | \$89           | \$13          | \$11          | \$7.3         |
| <b>Sum of Emission Benefits</b>                 | <b>\$180</b>   | <b>\$1,900</b> | <b>\$1,900</b> | <b>\$1,800</b> | <b>\$90</b>   | <b>\$88</b>   | <b>\$84</b>   |
| <b>Net Benefits</b>                             | <b>\$270</b>   | <b>\$2,300</b> | <b>\$2,100</b> | <b>\$1,800</b> | <b>\$110</b>  | <b>\$100</b>  | <b>\$85</b>   |

<sup>a</sup> Net benefits are emission benefits, non-emission benefits, and fuel savings (less EVSE port costs) minus the costs of the program. Values rounded to two significant figures; totals may not sum due to rounding. Present and annualized values are based on the stream of annual calendar year costs and benefits included in the analysis (2027 – 2055) and discounted back to year 2027. Climate benefits are based on reductions in GHG emissions and are calculated using three different SC-GHG estimates that assume either a 1.5 percent, 2.0 percent, or 2.5 percent near-term Ramsey discount rate. See EPA’s Report on the Social Cost of Greenhouse Gases: Estimates Incorporating Recent Scientific Advances (EPA, 2023). For presentational purposes in this table, we use the climate benefits associated with the SC-GHG estimates under the 2-percent near-term Ramsey discount rate. See Chapter 9.4 of this RIA for the full range of monetized climate benefit estimates. All other costs and benefits are discounted using either a 2-percent, 3-percent, or 7-percent constant discount rate. For further discussion of the SC-GHGs and how EPA accounted for these estimates, please refer to Chapter 6.2 of the RIA.

<sup>b</sup> To calculate net benefits, we use the monetized suite of total avoided PM<sub>2.5</sub>-related health effects that includes avoided deaths based on the Pope III et al., 2019 study, which is the larger of the two PM<sub>2.5</sub> health benefits estimates presented in Chapter 9.5 of this RIA.

<sup>c</sup> The annual PM<sub>2.5</sub> health benefits estimate presented in the CY 2055 column reflects the value of certain avoided health outcomes, such as avoided deaths, that are expected to accrue over more than a single year discounted using a 3-percent discount rate.

<sup>d</sup> We do not currently have year-over-year estimates of PM<sub>2.5</sub> benefits that discount such annual health outcomes using a 2-percent discount rate. We have therefore discounted the annual stream of health benefits that reflect a 3-percent discount rate lag adjustment using a 2-percent discount rate to populate the PV, 2% and AV, 2% columns. The annual stream of PM<sub>2.5</sub>-related health benefits that reflect a 3-percent and 7-percent discount rate lag adjustment were used to populate the PV/AV 3% and PV/AV 7% columns, respectively. See Chapter 9.5 of this RIA for more details on the annual stream of PM<sub>2.5</sub>-related benefits associated with this rule.

**Table 9-21 Summary of costs, fuel savings and benefits of Alternative B  
(billions of 2022 dollars)<sup>a,b,c</sup>**

|   | <b>CY 2055</b> | <b>PV, 2%</b>  | <b>PV, 3%</b>  | <b>PV, 7%</b>  | <b>AV, 2%</b> | <b>AV, 3%</b> | <b>AV, 7%</b> |
|---|----------------|----------------|----------------|----------------|---------------|---------------|---------------|
| Vehicle Technology Costs                        | \$30           | \$710          | \$610          | \$360          | \$32          | \$32          | \$30          |
| Insurance Costs                                 | \$1.5          | \$26           | \$22           | \$12           | \$1.2         | \$1.2         | \$0.98        |
| Repair Costs                                    | -\$6.6         | -\$41          | -\$32          | -\$13          | -\$1.9        | -\$1.7        | -\$1.1        |
| Maintenance Costs                               | -\$30          | -\$260         | -\$210         | -\$98          | -\$12         | -\$11         | -\$8          |
| Congestion Costs                                | \$2.2          | \$22           | \$18           | \$8.9          | \$1           | \$0.96        | \$0.73        |
| Noise Costs                                     | \$0.036        | \$0.36         | \$0.3          | \$0.15         | \$0.017       | \$0.016       | \$0.012       |
| <b>Sum of Costs</b>                             | <b>-\$2.8</b>  | <b>\$450</b>   | <b>\$410</b>   | <b>\$270</b>   | <b>\$21</b>   | <b>\$21</b>   | <b>\$22</b>   |
| Pre-tax Fuel Savings                            | \$81           | \$880          | \$730          | \$370          | \$40          | \$38          | \$30          |
| EVSE Port Costs                                 | \$8.6          | \$190          | \$160          | \$96           | \$9           | \$8.8         | \$7.9         |
| <b>Sum of Fuel Savings less EVSE Port Costs</b> | <b>\$73</b>    | <b>\$690</b>   | <b>\$570</b>   | <b>\$270</b>   | <b>\$31</b>   | <b>\$29</b>   | <b>\$22</b>   |
| Drive Value Benefits                            | \$4.3          | \$41           | \$34           | \$17           | \$1.9         | \$1.8         | \$1.3         |
| Refueling Time Benefits                         | -\$2.2         | -\$23          | -\$19          | -\$9.8         | -\$1.1        | -\$1          | -\$0.8        |
| Energy Security Benefits                        | \$3.4          | \$39           | \$33           | \$17           | \$1.8         | \$1.7         | \$1.3         |
| <b>Sum of Non-Emission Benefits</b>             | <b>\$5.5</b>   | <b>\$58</b>    | <b>\$48</b>    | <b>\$23</b>    | <b>\$2.6</b>  | <b>\$2.5</b>  | <b>\$1.9</b>  |
| Climate Benefits, 2% Near-term Ramsey           | \$120          | \$1,300        | \$1,300        | \$1,300        | \$61          | \$61          | \$61          |
| PM <sub>2.5</sub> Health Benefits               | \$25           | \$240          | \$200          | \$87           | \$12          | \$10          | \$7.1         |
| <b>Sum of Emission Benefits</b>                 | <b>\$150</b>   | <b>\$1,600</b> | <b>\$1,500</b> | <b>\$1,400</b> | <b>\$74</b>   | <b>\$72</b>   | <b>\$68</b>   |
| <b>Net Benefits</b>                             | <b>\$230</b>   | <b>\$1,900</b> | <b>\$1,700</b> | <b>\$1,400</b> | <b>\$87</b>   | <b>\$82</b>   | <b>\$70</b>   |

<sup>a</sup> Net benefits are emission benefits, non-emission benefits, and fuel savings (less EVSE port costs) minus the costs of the program. Values rounded to two significant figures; totals may not sum due to rounding. Present and annualized values are based on the stream of annual calendar year costs and benefits included in the analysis (2027 – 2055) and discounted back to year 2027. Climate benefits are based on reductions in GHG emissions and are calculated using three different SC-GHG estimates that assume either a 1.5 percent, 2.0 percent, or 2.5 percent near-term Ramsey discount rate. See EPA’s Report on the Social Cost of Greenhouse Gases: Estimates Incorporating Recent Scientific Advances (EPA, 2023). For presentational purposes in this table, we use the climate benefits associated with the SC-GHG estimates under the 2-percent near-term Ramsey discount rate. See Chapter 9.4 of this RIA for the full range of monetized climate benefit estimates. All other costs and benefits are discounted using either a 2-percent, 3-percent, or 7-percent constant discount rate. For further discussion of the SC-GHGs and how EPA accounted for these estimates, please refer to Chapter 6.2 of the RIA.

<sup>b</sup> To calculate net benefits, we use the monetized suite of total avoided PM<sub>2.5</sub>-related health effects that includes avoided deaths based on the Pope III et al., 2019 study, which is the larger of the two PM<sub>2.5</sub> health benefits estimates presented in Chapter 9.5 of this RIA.

<sup>c</sup> The annual PM<sub>2.5</sub> health benefits estimate presented in the CY 2055 column reflects the value of certain avoided health outcomes, such as avoided deaths, that are expected to accrue over more than a single year discounted using a 3-percent discount rate.

<sup>d</sup> We do not currently have year-over-year estimates of PM<sub>2.5</sub> benefits that discount such annual health outcomes using a 2-percent discount rate. We have therefore discounted the annual stream of health benefits that reflect a 3-percent discount rate lag adjustment using a 2-percent discount rate to populate the PV, 2% and AV, 2% columns. The annual stream of PM<sub>2.5</sub>-related health benefits that reflect a 3-percent and 7-percent discount rate lag adjustment were used to populate the PV/AV 3% and PV/AV 7% columns, respectively. See Chapter 9.5 of this RIA for more details on the annual stream of PM<sub>2.5</sub>-related benefits associated with this rule.

## 9.7 Transfers

There are four types of transfers included in our analysis. Two of these transfers come in the form of tax credits arising from the Inflation Reduction Act to encourage investment in battery technology and the purchase of electrified vehicles. These are transfers from the government to producers of vehicles (the 45X battery production tax credits), or to purchasers of vehicles (the 30D tax credit) or to lessors or commercial purchasers (the 45W tax credit). There are also transfers from the government to residents and businesses who install EVSE (the 30C tax credit)<sup>259</sup> though we don't quantify these transfers as part of our analysis. The third, new for the final rule, is state taxes on the purchase of new, higher cost vehicles which represents transfers from purchasers to government. The fourth is fuel and electricity taxes which are transfers from purchasers of fuel to the government. The final standards result in less liquid-fuel consumed and, therefore, less money transferred from purchasers of liquid fuel to the government while the reverse is true for electricity consumption where the increase associated with PEVs results in more money transferred from purchasers to the government. For more detail on the IRS Section 45X, 30D, and 45W tax credits please see Section IV of the preamble and Chapter 2.6.8 of this RIA. Table 9-22 presents transfers associated with the final standards. Table 9-23 and Table 9-24 present transfers associated with Alternatives A and B, respectively.

**Table 9-22: Transfers associated with the final standards  
(billions of 2020 dollars).**

| Calendar Year | Battery Tax Credits | Vehicle Purchase Tax Credits | State Sales Taxes | Liquid Fuel and Electricity Taxes | Sum of Transfers |
|---------------|---------------------|------------------------------|-------------------|-----------------------------------|------------------|
| 2027          | \$0.25              | \$0.4                        | -\$0.12           | \$0.036                           | \$0.56           |
| 2028          | \$1.4               | \$2                          | -\$0.27           | \$0.23                            | \$3.4            |
| 2029          | \$4.1               | \$5.4                        | -\$0.61           | \$0.69                            | \$9.5            |
| 2030          | \$5.1               | \$9.2                        | -\$0.9            | \$1.4                             | \$15             |
| 2031          | \$5.4               | \$15                         | -\$1.2            | \$2.2                             | \$22             |
| 2032          | \$3.6               | \$20                         | -\$1.3            | \$3.2                             | \$25             |
| 2035          | \$0                 | \$0                          | -\$2.7            | \$7.3                             | \$4.5            |
| 2040          | \$0                 | \$0                          | -\$2.5            | \$13                              | \$10             |
| 2045          | \$0                 | \$0                          | -\$2.3            | \$16                              | \$13             |
| 2050          | \$0                 | \$0                          | -\$2.1            | \$18                              | \$16             |
| 2055          | \$0                 | \$0                          | -\$1.9            | \$18                              | \$16             |
| PV2           | \$18                | \$47                         | -\$43             | \$230                             | \$250            |
| PV3           | \$17                | \$45                         | -\$37             | \$190                             | \$220            |
| PV7           | \$15                | \$38                         | -\$22             | \$98                              | \$130            |
| AV2           | \$0.83              | \$2.2                        | -\$2              | \$10                              | \$11             |
| AV3           | \$0.91              | \$2.4                        | -\$1.9            | \$9.9                             | \$11             |
| AV7           | \$1.2               | \$3.1                        | -\$1.8            | \$7.9                             | \$10             |

\* Negative values reflect transfers from taxpayers to governments; positive values reflect transfers from government to taxpayers.

<sup>259</sup> The IRA extends the Internal Revenue Code 30C Alternative Fuel Refueling Property Tax Credit through Dec 31, 2032, with modifications. See Preamble Section IV.C.4 and RIA Chapter 5 for more details.

**Table 9-23: Transfers associated with Alternative A  
(billions of 2022 dollars).**

| Calendar Year | Battery Tax Credits | Vehicle Purchase Tax Credits | State Sales Taxes | Liquid Fuel and Electricity Taxes | Sum of Transfers |
|---------------|---------------------|------------------------------|-------------------|-----------------------------------|------------------|
| 2027          | \$3.3               | \$3.9                        | -\$0.65           | \$0.37                            | \$7              |
| 2028          | \$5                 | \$6.7                        | -\$1              | \$1                               | \$12             |
| 2029          | \$7.2               | \$9.8                        | -\$1.3            | \$1.8                             | \$18             |
| 2030          | \$6.9               | \$12                         | -\$1.4            | \$2.8                             | \$21             |
| 2031          | \$5.9               | \$17                         | -\$1.5            | \$3.7                             | \$25             |
| 2032          | \$3.7               | \$20                         | -\$1.5            | \$4.7                             | \$27             |
| 2035          | \$0                 | \$0                          | -\$2.7            | \$8.6                             | \$5.9            |
| 2040          | \$0                 | \$0                          | -\$2.5            | \$13                              | \$11             |
| 2045          | \$0                 | \$0                          | -\$2.3            | \$16                              | \$14             |
| 2050          | \$0                 | \$0                          | -\$2.2            | \$19                              | \$17             |
| 2055          | \$0                 | \$0                          | -\$1.9            | \$18                              | \$16             |
| PV2           | \$30                | \$64                         | -\$46             | \$250                             | \$290            |
| PV3           | \$29                | \$62                         | -\$40             | \$210                             | \$260            |
| PV7           | \$25                | \$52                         | -\$24             | \$110                             | \$160            |
| AV2           | \$1.4               | \$2.9                        | -\$2.1            | \$11                              | \$13             |
| AV3           | \$1.5               | \$3.2                        | -\$2.1            | \$11                              | \$13             |
| AV7           | \$2.1               | \$4.3                        | -\$2              | \$8.9                             | \$13             |

\* Negative values reflect transfers from taxpayers to governments; positive values reflect transfers from government to taxpayers.

**Table 9-24: Transfers associated with Alternative B  
(billions of 2022 dollars).**

| Calendar Year | Battery Tax Credits | Vehicle Purchase Tax Credits | State Sales Taxes | Liquid Fuel and Electricity Taxes | Sum of Transfers |
|---------------|---------------------|------------------------------|-------------------|-----------------------------------|------------------|
| 2027          | \$0.17              | \$0.33                       | -\$0.11           | \$0.028                           | \$0.42           |
| 2028          | \$1.2               | \$1.6                        | -\$0.23           | \$0.2                             | \$2.7            |
| 2029          | \$4                 | \$5.1                        | -\$0.56           | \$0.64                            | \$9.2            |
| 2030          | \$4.5               | \$8                          | -\$0.85           | \$1.3                             | \$13             |
| 2031          | \$4.5               | \$13                         | -\$0.98           | \$2                               | \$18             |
| 2032          | \$3.4               | \$17                         | -\$1.2            | \$2.9                             | \$23             |
| 2035          | \$0                 | \$0                          | -\$2.1            | \$6.4                             | \$4.2            |
| 2040          | \$0                 | \$0                          | -\$2              | \$11                              | \$8.5            |
| 2045          | \$0                 | \$0                          | -\$2              | \$13                              | \$11             |
| 2050          | \$0                 | \$0                          | -\$1.8            | \$16                              | \$14             |
| 2055          | \$0                 | \$0                          | -\$1.5            | \$15                              | \$14             |
| PV2           | \$16                | \$41                         | -\$35             | \$190                             | \$220            |
| PV3           | \$16                | \$39                         | -\$30             | \$160                             | \$190            |
| PV7           | \$13                | \$33                         | -\$18             | \$83                              | \$110            |
| AV2           | \$0.75              | \$1.9                        | -\$1.6            | \$8.9                             | \$9.9            |
| AV3           | \$0.82              | \$2                          | -\$1.6            | \$8.4                             | \$9.7            |
| AV7           | \$1.1               | \$2.7                        | -\$1.4            | \$6.8                             | \$9.1            |

\* Negative values reflect transfers from taxpayers to governments; positive values reflect transfers from government to taxpayers.

## Chapter 9 References

- EPA. 2023f. "Supplementary Material for the Regulatory Impact Analysis for the Final Rulemaking: Standards of Performance for New, Reconstructed, and Modified Sources and Emissions Guidelines for Existing Sources: Oil and Natural Gas Sector Climate Review." EPA Report on the Social Cost of Greenhouse Gases: Estimates Incorporating Recent Scientific Advances, Washington, DC. doi:Docket ID No. EPA-HQ-OAR-2021-0317.
- . 2021. "Technical Documentation on the framework for evaluating damages and impacts (FrEDI)." EPA Science Inventory.  
[https://cfpub.epa.gov/si/si\\_public\\_record\\_report.cfm?dirEntryId=351316&Lab=OAP&simplesearch=0&showcriteria=2&sortby=pubDate&searchall=fredi&timstype=&datebeginpublishedpresented=02/14/2021](https://cfpub.epa.gov/si/si_public_record_report.cfm?dirEntryId=351316&Lab=OAP&simplesearch=0&showcriteria=2&sortby=pubDate&searchall=fredi&timstype=&datebeginpublishedpresented=02/14/2021).
- Hartin, C, EE McDuffie, K Noiva, M Sarofim, B Parthum, J Martinich, S Barr, J Neumann, J Wilwerth, and A Fawcett. 2023. "Advancing the estimation of future climate impacts within the United States." *Earth System Dynamics* 14(5): 1015-1037.
- IWG. 2016a. Addendum to Technical Support Document on Social Cost of Carbon for Regulatory Impact Analysis under Executive Order 12866: Application of the Methodology to Estimate the Social Cost of Methane and the Social Cost of Nitrous Oxide.  
[https://www.epa.gov/sites/default/files/2016-12/documents/addendum\\_to\\_sc-ghg\\_tsd\\_august\\_2016.pdf](https://www.epa.gov/sites/default/files/2016-12/documents/addendum_to_sc-ghg_tsd_august_2016.pdf).
- IWG. 2015. Response to comments: social cost of carbon for regulatory impact analysis under executive order 12866. Response to Comments, United States Government.  
<https://obamawhitehouse.archives.gov/sites/default/files/omb/inforeg/scc-responseto-comments-final-july-2015.pdf>.
- . 2010. Technical Support Document: Social Cost of Carbon for Regulatory Impact Analysis under Executive Order 12866. Accessed 2023. [https://www.epa.gov/sites/default/files/2016-12/documents/scc\\_tsd\\_2010.pdf](https://www.epa.gov/sites/default/files/2016-12/documents/scc_tsd_2010.pdf).
- . 2021. Technical Support Document: Social Cost of Carbon, Methane, and Nitrous Oxide Interim Estimates under Executive Order 13990. Accessed 2023.  
[https://www.whitehouse.gov/wp-content/uploads/2021/02/TechnicalSupportDocument\\_SocialCostofCarbonMethaneNitrouSOxide.pdf](https://www.whitehouse.gov/wp-content/uploads/2021/02/TechnicalSupportDocument_SocialCostofCarbonMethaneNitrouSOxide.pdf).
- . 2013. Technical Support Document: Technical Update of the Social Cost of Carbon for Regulatory Impact Analysis Under Executive Order 12866.  
[https://www.ourenergypolicy.org/wp-content/uploads/2013/06/social\\_cost\\_of\\_carbon\\_for\\_ria\\_2013\\_update.pdf](https://www.ourenergypolicy.org/wp-content/uploads/2013/06/social_cost_of_carbon_for_ria_2013_update.pdf).
- . 2016b. Technical Support Document: Technical Update of the Social Cost of Carbon for Regulatory Impact Analysis Under Executive Order 12866. Accessed 2023.  
[https://www.epa.gov/sites/default/files/2016-12/documents/sc\\_CO2\\_tsd\\_august\\_2016.pdf](https://www.epa.gov/sites/default/files/2016-12/documents/sc_CO2_tsd_august_2016.pdf).

McDuffie, EE, MC Sarofim, W Raich, M Jackson, H Roman, K Seltzer, BH Henderson, et al. 2023. "The social cost of ozone-related mortality impacts from methane emissions." *Earth's Future* 11(9). doi:<https://doi.org/10.1029/2023EF003853>.

National Academies. 2017. *Valuing Climate Damages: Updating Estimation of the Social Cost of Carbon Dioxide*. Washington, D.C.: The National Academies Press.

Pope III et al., CA, Lefler, JS, Ezzati, M, Higbee, JD, Marshall, JD, Kim, S-Y, Bechle, M, Gilliat, KS, Vernon, SE and Robinson, AL. 2019. "Mortality risk and fine particulate air pollution in a large, representative cohort of US adults." *Environmental Health Perspectives* 127(7): 077007.

Sarofim, MC, J Martinich, JE Neumann, J Willwerth, Z Kerrich, M Kolian, C Fant, and C Hartin. 2021. "A temperature binning approach for multi-sector climate impact analysis." *Climate Change* 165(22). <https://doi.org/10.1007/s10584-021-03048-6>.

Wu et al., X, Braun, D, Schwartz, J, Kioumourtzoglou, M and Dominici, F. 2020. "Evaluating the impact of long-term exposure to fine particulate matter on mortality among the elderly." *Science Advances* 6 (29): eaba5692.

## Appendix to Chapter 9

This appendix presents the climate benefits of the final standards using the interim Social Cost of Greenhouse Gas (SC-GHG) values used in the NPRM. We have updated the interim values to 2022 dollars for the analysis in this RIA. The updated interim SC-GHG values are presented in Table 9-25. The climate benefits using these values are presented in Table 9-26 through Table 9-29 for the reductions in CO<sub>2</sub>, CH<sub>4</sub>, N<sub>2</sub>O and all GHGs, respectively. Table 9-30 presents the summary of cost and benefits of the final standards using the 3% average benefits across the GHGs. Costs and benefits presented here are calculated relative to the No Action case unless stated otherwise.

**Table 9-25 Interim Social Cost of GHG Values, 2027-2055 (2022 \$/metric ton)**

| Calendar Year | CO <sub>2</sub> |        |          |                             | CH <sub>4</sub> |         |          |                             | N <sub>2</sub> O |          |          |                             |
|---------------|-----------------|--------|----------|-----------------------------|-----------------|---------|----------|-----------------------------|------------------|----------|----------|-----------------------------|
|               | 5% Avg          | 3% Avg | 2.5% Avg | 3% 95 <sup>th</sup> pctlile | 5% Avg          | 3% Avg  | 2.5% Avg | 3% 95 <sup>th</sup> pctlile | 5% Avg           | 3% Avg   | 2.5% Avg | 3% 95 <sup>th</sup> pctlile |
| 2027          | \$20            | \$66   | \$96     | \$197                       | \$959           | \$2,030 | \$2,621  | \$5,379                     | \$8,053          | \$24,029 | \$34,734 | \$63,484                    |
| 2028          | \$21            | \$67   | \$97     | \$201                       | \$989           | \$2,083 | \$2,683  | \$5,523                     | \$8,279          | \$24,518 | \$35,358 | \$64,836                    |
| 2029          | \$21            | \$68   | \$99     | \$205                       | \$1,020         | \$2,135 | \$2,745  | \$5,667                     | \$8,505          | \$25,008 | \$35,981 | \$66,188                    |
| 2030          | \$22            | \$69   | \$100    | \$209                       | \$1,050         | \$2,188 | \$2,807  | \$5,810                     | \$8,731          | \$25,497 | \$36,604 | \$67,540                    |
| 2031          | \$22            | \$70   | \$102    | \$213                       | \$1,089         | \$2,250 | \$2,879  | \$5,983                     | \$9,008          | \$26,048 | \$37,288 | \$69,062                    |
| 2032          | \$23            | \$72   | \$103    | \$218                       | \$1,127         | \$2,312 | \$2,950  | \$6,155                     | \$9,285          | \$26,598 | \$37,973 | \$70,583                    |
| 2033          | \$24            | \$73   | \$105    | \$222                       | \$1,165         | \$2,374 | \$3,022  | \$6,327                     | \$9,563          | \$27,149 | \$38,657 | \$72,105                    |
| 2034          | \$24            | \$74   | \$106    | \$226                       | \$1,204         | \$2,436 | \$3,093  | \$6,499                     | \$9,840          | \$27,700 | \$39,342 | \$73,626                    |
| 2035          | \$25            | \$76   | \$108    | \$230                       | \$1,242         | \$2,498 | \$3,165  | \$6,671                     | \$10,117         | \$28,250 | \$40,026 | \$75,148                    |
| 2036          | \$26            | \$77   | \$109    | \$235                       | \$1,281         | \$2,560 | \$3,236  | \$6,843                     | \$10,395         | \$28,801 | \$40,711 | \$76,669                    |
| 2037          | \$26            | \$78   | \$111    | \$239                       | \$1,319         | \$2,622 | \$3,308  | \$7,015                     | \$10,672         | \$29,352 | \$41,395 | \$78,191                    |
| 2038          | \$27            | \$79   | \$112    | \$243                       | \$1,358         | \$2,684 | \$3,379  | \$7,188                     | \$10,949         | \$29,902 | \$42,079 | \$79,712                    |
| 2039          | \$28            | \$81   | \$114    | \$248                       | \$1,396         | \$2,746 | \$3,451  | \$7,360                     | \$11,227         | \$30,453 | \$42,764 | \$81,234                    |
| 2040          | \$28            | \$82   | \$115    | \$252                       | \$1,435         | \$2,808 | \$3,522  | \$7,532                     | \$11,504         | \$31,004 | \$43,448 | \$82,755                    |
| 2041          | \$29            | \$83   | \$117    | \$256                       | \$1,477         | \$2,870 | \$3,593  | \$7,694                     | \$11,829         | \$31,596 | \$44,169 | \$84,349                    |
| 2042          | \$30            | \$85   | \$118    | \$260                       | \$1,519         | \$2,933 | \$3,663  | \$7,856                     | \$12,154         | \$32,189 | \$44,891 | \$85,944                    |
| 2043          | \$30            | \$86   | \$120    | \$264                       | \$1,561         | \$2,996 | \$3,734  | \$8,018                     | \$12,479         | \$32,781 | \$45,612 | \$87,538                    |
| 2044          | \$31            | \$87   | \$121    | \$267                       | \$1,603         | \$3,058 | \$3,804  | \$8,180                     | \$12,803         | \$33,374 | \$46,333 | \$89,132                    |
| 2045          | \$32            | \$88   | \$123    | \$271                       | \$1,645         | \$3,121 | \$3,875  | \$8,342                     | \$13,128         | \$33,967 | \$47,054 | \$90,727                    |
| 2046          | \$33            | \$90   | \$124    | \$275                       | \$1,687         | \$3,183 | \$3,946  | \$8,504                     | \$13,453         | \$34,559 | \$47,775 | \$92,321                    |
| 2047          | \$33            | \$91   | \$126    | \$279                       | \$1,729         | \$3,246 | \$4,016  | \$8,666                     | \$13,778         | \$35,152 | \$48,496 | \$93,915                    |
| 2048          | \$34            | \$92   | \$127    | \$283                       | \$1,771         | \$3,309 | \$4,087  | \$8,828                     | \$14,103         | \$35,745 | \$49,217 | \$95,510                    |
| 2049          | \$35            | \$93   | \$129    | \$287                       | \$1,813         | \$3,371 | \$4,157  | \$8,990                     | \$14,428         | \$36,337 | \$49,939 | \$97,104                    |
| 2050          | \$35            | \$95   | \$130    | \$291                       | \$1,855         | \$3,434 | \$4,228  | \$9,152                     | \$14,753         | \$36,930 | \$50,660 | \$98,698                    |
| 2051          | \$36            | \$95   | \$132    | \$292                       | \$1,887         | \$3,478 | \$4,276  | \$9,204                     | \$15,141         | \$37,548 | \$51,366 | \$99,533                    |
| 2052          | \$37            | \$96   | \$133    | \$293                       | \$1,913         | \$3,513 | \$4,314  | \$9,243                     | \$15,500         | \$38,141 | \$52,071 | \$101,081                   |
| 2053          | \$38            | \$97   | \$135    | \$294                       | \$1,939         | \$3,548 | \$4,352  | \$9,282                     | \$15,859         | \$38,735 | \$52,775 | \$102,629                   |
| 2054          | \$38            | \$99   | \$136    | \$295                       | \$1,965         | \$3,584 | \$4,390  | \$9,320                     | \$16,219         | \$39,329 | \$53,480 | \$104,177                   |
| 2055          | \$39            | \$100  | \$137    | \$298                       | \$1,991         | \$3,619 | \$4,428  | \$9,359                     | \$16,578         | \$39,922 | \$54,184 | \$105,724                   |

Note: The 2027-2055 values are identical to those reported in the 2016 TSD (IWG 2016a) adjusted to 2022 dollars using the annual GDP Implicit Price Deflator values used elsewhere in the analysis presented in this RIA. This table displays the values rounded to the nearest dollar; the annual unrounded values used in the calculations in this analysis are available on OMB's website:

<https://www.whitehouse.gov/omb/information-regulatory-affairs/regulatory-matters/#scghgs>. The estimates were extended for the period 2051 to 2055 using methods, assumptions, and parameters identical to the 2020-2050 estimates. The values are stated in \$/metric ton and vary depending on the year.

**Table 9-26 Benefits of reduced CO<sub>2</sub> emissions from the final standards using the interim SC-GHG values  
(billions of 2022 dollars)**

| Calendar Year | Discount Rate |         |        |                       |
|---------------|---------------|---------|--------|-----------------------|
|               | 5%            | 3%      | 2.5%   | 3%<br>95th percentile |
| 2027          | \$0.0083      | \$0.027 | \$0.04 | \$0.081               |
| 2028          | \$0.072       | \$0.23  | \$0.34 | \$0.7                 |
| 2029          | \$0.25        | \$0.8   | \$1.2  | \$2.4                 |
| 2030          | \$0.52        | \$1.7   | \$2.4  | \$5                   |
| 2031          | \$0.89        | \$2.8   | \$4    | \$8.5                 |
| 2032          | \$1.3         | \$4.2   | \$6    | \$13                  |
| 2033          | \$2           | \$6.2   | \$9    | \$19                  |
| 2034          | \$2.8         | \$8.5   | \$12   | \$26                  |
| 2035          | \$3.6         | \$11    | \$16   | \$33                  |
| 2036          | \$4.4         | \$13    | \$19   | \$40                  |
| 2037          | \$5.2         | \$16    | \$22   | \$47                  |
| 2038          | \$6           | \$18    | \$25   | \$55                  |
| 2039          | \$6.9         | \$20    | \$28   | \$62                  |
| 2040          | \$7.7         | \$22    | \$31   | \$69                  |
| 2041          | \$8.4         | \$24    | \$34   | \$75                  |
| 2042          | \$9.2         | \$26    | \$37   | \$81                  |
| 2043          | \$10          | \$28    | \$39   | \$87                  |
| 2044          | \$11          | \$30    | \$42   | \$92                  |
| 2045          | \$11          | \$32    | \$44   | \$97                  |
| 2046          | \$12          | \$33    | \$46   | \$100                 |
| 2047          | \$13          | \$34    | \$48   | \$110                 |
| 2048          | \$13          | \$36    | \$49   | \$110                 |
| 2049          | \$14          | \$37    | \$51   | \$110                 |
| 2050          | \$14          | \$38    | \$52   | \$120                 |
| 2051          | \$15          | \$38    | \$53   | \$120                 |
| 2052          | \$15          | \$39    | \$54   | \$120                 |
| 2053          | \$15          | \$40    | \$55   | \$120                 |
| 2054          | \$16          | \$40    | \$55   | \$120                 |
| 2055          | \$16          | \$40    | \$56   | \$120                 |
| PV            | \$89          | \$360   | \$550  | \$1,100               |
| AV            | \$5.9         | \$19    | \$27   | \$57                  |

Note: Climate benefits are based on changes (reductions) in CO<sub>2</sub> emissions and are calculated using the IWG interim SC-GHG estimates from (IWG 2021). Climate benefits include changes in vehicle, EGU, and refinery CO<sub>2</sub> emissions.



**Table 9-27 Benefits of reduced CH<sub>4</sub> emissions from the final standards using the interim SC-GHG values  
(billions of 2022 dollars)**

| Calendar Year | Discount Rate |             |             |                       |
|---------------|---------------|-------------|-------------|-----------------------|
|               | 5%            | 3%          | 2.5%        | 3%<br>95th percentile |
| 2027          | -\$0.00001    | -\$0.000022 | -\$0.000028 | -\$0.000058           |
| 2028          | -\$0.000024   | -\$0.00005  | -\$0.000064 | -\$0.00013            |
| 2029          | \$0.000011    | \$0.000023  | \$0.00003   | \$0.000062            |
| 2030          | \$0.00006     | \$0.00013   | \$0.00016   | \$0.00033             |
| 2031          | \$0.00011     | \$0.00023   | \$0.00029   | \$0.00061             |
| 2032          | \$0.00025     | \$0.00052   | \$0.00067   | \$0.0014              |
| 2033          | \$0.00063     | \$0.0013    | \$0.0016    | \$0.0034              |
| 2034          | \$0.0011      | \$0.0022    | \$0.0028    | \$0.006               |
| 2035          | \$0.0017      | \$0.0034    | \$0.0042    | \$0.009               |
| 2036          | \$0.0023      | \$0.0046    | \$0.0058    | \$0.012               |
| 2037          | \$0.003       | \$0.0061    | \$0.0076    | \$0.016               |
| 2038          | \$0.0039      | \$0.0077    | \$0.0097    | \$0.021               |
| 2039          | \$0.0048      | \$0.0095    | \$0.012     | \$0.025               |
| 2040          | \$0.0057      | \$0.011     | \$0.014     | \$0.03                |
| 2041          | \$0.0066      | \$0.013     | \$0.016     | \$0.035               |
| 2042          | \$0.0076      | \$0.015     | \$0.018     | \$0.039               |
| 2043          | \$0.0086      | \$0.016     | \$0.02      | \$0.044               |
| 2044          | \$0.0096      | \$0.018     | \$0.023     | \$0.049               |
| 2045          | \$0.011       | \$0.02      | \$0.025     | \$0.054               |
| 2046          | \$0.011       | \$0.022     | \$0.027     | \$0.057               |
| 2047          | \$0.012       | \$0.023     | \$0.028     | \$0.061               |
| 2048          | \$0.013       | \$0.024     | \$0.03      | \$0.064               |
| 2049          | \$0.014       | \$0.025     | \$0.031     | \$0.067               |
| 2050          | \$0.014       | \$0.026     | \$0.032     | \$0.07                |
| 2051          | \$0.015       | \$0.027     | \$0.033     | \$0.071               |
| 2052          | \$0.015       | \$0.028     | \$0.034     | \$0.072               |
| 2053          | \$0.015       | \$0.028     | \$0.034     | \$0.073               |
| 2054          | \$0.016       | \$0.028     | \$0.035     | \$0.074               |
| 2055          | \$0.016       | \$0.029     | \$0.035     | \$0.074               |
| PV            | \$0.074       | \$0.21      | \$0.29      | \$0.55                |
| AV            | \$0.0049      | \$0.011     | \$0.014     | \$0.029               |

Note: Climate benefits are based on changes (reductions) in CH<sub>4</sub> emissions and are calculated using the IWG interim SC-GHG estimates from (IWG 2021). Climate benefits include changes in vehicle, EGU, and refinery CH<sub>4</sub> emissions.

**Table 9-28 Benefits of reduced N<sub>2</sub>O emissions from the final standards using the interim SC-GHG values  
(billions of 2022 dollars)**

| Calendar Year | Discount Rate |           |           |                       |
|---------------|---------------|-----------|-----------|-----------------------|
|               | 5%            | 3%        | 2.5%      | 3%<br>95th percentile |
| 2027          | \$0.000051    | \$0.00015 | \$0.00022 | \$0.00041             |
| 2028          | \$0.00035     | \$0.001   | \$0.0015  | \$0.0027              |
| 2029          | \$0.0014      | \$0.0041  | \$0.0059  | \$0.011               |
| 2030          | \$0.0034      | \$0.0099  | \$0.014   | \$0.026               |
| 2031          | \$0.0058      | \$0.017   | \$0.024   | \$0.044               |
| 2032          | \$0.009       | \$0.026   | \$0.037   | \$0.069               |
| 2033          | \$0.014       | \$0.04    | \$0.057   | \$0.11                |
| 2034          | \$0.02        | \$0.055   | \$0.079   | \$0.15                |
| 2035          | \$0.025       | \$0.071   | \$0.1     | \$0.19                |
| 2036          | \$0.031       | \$0.087   | \$0.12    | \$0.23                |
| 2037          | \$0.037       | \$0.1     | \$0.14    | \$0.27                |
| 2038          | \$0.043       | \$0.12    | \$0.16    | \$0.31                |
| 2039          | \$0.049       | \$0.13    | \$0.19    | \$0.35                |
| 2040          | \$0.054       | \$0.15    | \$0.21    | \$0.39                |
| 2041          | \$0.06        | \$0.16    | \$0.22    | \$0.43                |
| 2042          | \$0.066       | \$0.17    | \$0.24    | \$0.47                |
| 2043          | \$0.072       | \$0.19    | \$0.26    | \$0.5                 |
| 2044          | \$0.077       | \$0.2     | \$0.28    | \$0.54                |
| 2045          | \$0.082       | \$0.21    | \$0.29    | \$0.57                |
| 2046          | \$0.087       | \$0.22    | \$0.31    | \$0.6                 |
| 2047          | \$0.091       | \$0.23    | \$0.32    | \$0.62                |
| 2048          | \$0.096       | \$0.24    | \$0.33    | \$0.65                |
| 2049          | \$0.099       | \$0.25    | \$0.34    | \$0.67                |
| 2050          | \$0.1         | \$0.26    | \$0.35    | \$0.69                |
| 2051          | \$0.11        | \$0.26    | \$0.36    | \$0.7                 |
| 2052          | \$0.11        | \$0.27    | \$0.37    | \$0.72                |
| 2053          | \$0.11        | \$0.28    | \$0.38    | \$0.73                |
| 2054          | \$0.12        | \$0.28    | \$0.38    | \$0.75                |
| 2055          | \$0.12        | \$0.29    | \$0.39    | \$0.76                |
| PV            | \$0.64        | \$2.4     | \$3.7     | \$6.4                 |
| AV            | \$0.042       | \$0.13    | \$0.18    | \$0.33                |

Note: Climate benefits are based on changes (reductions) in N<sub>2</sub>O emissions and are calculated using the IWG interim SC-GHG estimates from (IWG 2021). Climate benefits include changes in vehicle, EGU, and refinery N<sub>2</sub>O emissions.

**Table 9-29 Benefits of reduced GHG emissions from the final standards using the interim SC-GHG values  
(billions of 2022 dollars)**

| Calendar Year | Discount Rate |         |        |                       |
|---------------|---------------|---------|--------|-----------------------|
|               | 5%            | 3%      | 2.5%   | 3%<br>95th percentile |
| 2027          | \$0.0083      | \$0.027 | \$0.04 | \$0.082               |
| 2028          | \$0.072       | \$0.23  | \$0.34 | \$0.7                 |
| 2029          | \$0.25        | \$0.8   | \$1.2  | \$2.4                 |
| 2030          | \$0.52        | \$1.7   | \$2.4  | \$5                   |
| 2031          | \$0.89        | \$2.8   | \$4.1  | \$8.5                 |
| 2032          | \$1.3         | \$4.2   | \$6    | \$13                  |
| 2033          | \$2           | \$6.3   | \$9    | \$19                  |
| 2034          | \$2.8         | \$8.5   | \$12   | \$26                  |
| 2035          | \$3.6         | \$11    | \$16   | \$33                  |
| 2036          | \$4.4         | \$13    | \$19   | \$41                  |
| 2037          | \$5.3         | \$16    | \$22   | \$48                  |
| 2038          | \$6.1         | \$18    | \$25   | \$55                  |
| 2039          | \$6.9         | \$20    | \$29   | \$62                  |
| 2040          | \$7.7         | \$22    | \$32   | \$69                  |
| 2041          | \$8.5         | \$24    | \$34   | \$75                  |
| 2042          | \$9.3         | \$26    | \$37   | \$81                  |
| 2043          | \$10          | \$28    | \$40   | \$87                  |
| 2044          | \$11          | \$30    | \$42   | \$93                  |
| 2045          | \$11          | \$32    | \$44   | \$98                  |
| 2046          | \$12          | \$33    | \$46   | \$100                 |
| 2047          | \$13          | \$35    | \$48   | \$110                 |
| 2048          | \$13          | \$36    | \$50   | \$110                 |
| 2049          | \$14          | \$37    | \$51   | \$110                 |
| 2050          | \$14          | \$38    | \$53   | \$120                 |
| 2051          | \$15          | \$39    | \$54   | \$120                 |
| 2052          | \$15          | \$39    | \$55   | \$120                 |
| 2053          | \$15          | \$40    | \$55   | \$120                 |
| 2054          | \$16          | \$40    | \$56   | \$120                 |
| 2055          | \$16          | \$41    | \$56   | \$120                 |
| PV            | \$90          | \$360   | \$550  | \$1,100               |
| AV            | \$5.9         | \$19    | \$27   | \$57                  |

Note: Climate benefits are based on changes (reductions) in GHG emissions and are calculated using the IWG interim SC-GHG estimates from (IWG 2021). Climate benefits include changes in vehicle, EGU, and refinery GHG emissions.

**Table 9-30 Summary of costs, fuel savings and benefits of the final standards  
(billions of 2022 dollars)\***

|  | <b>CY 2055</b> | <b>PV, 2%</b> | <b>PV, 3%</b> | <b>PV, 7%</b> | <b>AV, 2%</b> | <b>AV, 3%</b> | <b>AV, 7%</b> |
|--|----------------|---------------|---------------|---------------|---------------|---------------|---------------|
| Vehicle Technology Costs   | \$38           | \$870         | \$760         | \$450         | \$40          | \$39          | \$37          |
| Insurance Costs  | \$1.9          | \$33          | \$28          | \$15          | \$1.5         | \$1.4         | \$1.2         |
| Repair Costs   | -\$7.1         | -\$40         | -\$32         | -\$12         | -\$1.8        | -\$1.6        | -\$0.99       |
| Maintenance Costs  | -\$35          | -\$300        | -\$250        | -\$110        | -\$14         | -\$13         | -\$9.3        |
| Congestion Costs   | \$2.4          | \$25          | \$21          | \$10          | \$1.2         | \$1.1         | \$0.83        |
| Noise Costs  | \$0.04         | \$0.41        | \$0.34        | \$0.17        | \$0.019       | \$0.018       | \$0.014       |
| <b>Sum of Costs</b>  | <b>\$0.59</b>  | <b>\$590</b>  | <b>\$530</b>  | <b>\$350</b>  | <b>\$27</b>   | <b>\$28</b>   | <b>\$29</b>   |
| Pre-tax Fuel Savings   | \$94           | \$1,000       | \$840         | \$420         | \$46          | \$44          | \$34          |
| EVSE Port Costs  | \$8.6          | \$190         | \$160         | \$96          | \$9           | \$8.8         | \$7.9         |
| <b>Sum of Fuel Savings less EVSE Port Costs</b>  | <b>\$86</b>    | <b>\$820</b>  | <b>\$680</b>  | <b>\$330</b>  | <b>\$37</b>   | <b>\$35</b>   | <b>\$26</b>   |
| Drive Value Benefits   | \$4.7          | \$46          | \$38          | \$18          | \$2.1         | \$2           | \$1.5         |
| Refueling Time Benefits  | -\$1.7         | -\$17         | -\$15         | -\$7.5        | -\$0.8        | -\$0.76       | -\$0.61       |
| Energy Security Benefits   | \$4.1          | \$47          | \$39          | \$20          | \$2.1         | \$2           | \$1.6         |
| <b>Sum of Non-Emission Benefits</b>  | <b>\$7</b>     | <b>\$75</b>   | <b>\$62</b>   | <b>\$30</b>   | <b>\$3.4</b>  | <b>\$3.2</b>  | <b>\$2.5</b>  |
| Climate Benefits, 3% Average   | \$41           | \$360         | \$360         | \$360         | \$19          | \$19          | \$19          |
| PM <sub>2.5</sub> Health Benefits  | \$25           | \$240         | \$200         | \$88          | \$13          | \$10          | \$7.2         |
| <b>Sum of Emission Benefits</b>  | <b>\$66</b>    | <b>\$600</b>  | <b>\$560</b>  | <b>\$450</b>  | <b>\$31</b>   | <b>\$29</b>   | <b>\$26</b>   |
| <b>Net Benefits</b>  | <b>\$160</b>   | <b>\$910</b>  | <b>\$770</b>  | <b>\$450</b>  | <b>\$45</b>   | <b>\$40</b>   | <b>\$26</b>   |
| * Please see the footnotes to Table 9-21 of this RIA. Climate benefits are based on changes (reductions) in GHG emissions and are calculated using the IWG interim SC-GHG estimates from (IWG 2021). |                |               |               |               |               |               |               |

## Chapter 10: Energy Security Impacts

In this Chapter of the RIA, we evaluate the energy security impacts of this final light- and medium-duty vehicle (LMDV) GHG rule (2027–2032). Energy security is broadly defined as the uninterrupted availability of energy sources at affordable prices (IEA 2019). Most discussions of U.S. energy security revolve around the topic of the economic costs of U.S. dependence on oil imports.<sup>260</sup> Energy independence and energy security are distinct but related concepts, and an analysis of energy independence informs our assessment of energy security. The goal of U.S. energy independence is generally the elimination of all U.S. imports of petroleum and other foreign sources of energy, or more broadly, reducing the sensitivity of the U.S. economy to energy imports and foreign energy markets (Greene 2010).

The U.S.'s oil consumption had been gradually increasing in recent years (2015–2019) before the COVID-19 pandemic in 2020 dramatically decreased U.S. and global oil consumption (U.S. EIA 2022). By July 2021, U.S. oil consumption had returned to pre-pandemic levels and has remained fairly stable since then (U.S. EIA 2022). The U.S. has increased its production of oil, particularly “tight” (i.e., shale) oil, over the last decade (U.S. EIA 2022). As a result of the recent increase in U.S. oil production, the U.S. became a net exporter of crude oil and refined petroleum products in 2020 and is projected to be a net exporter of crude oil and refined petroleum products for the foreseeable future (U.S. EIA 2023). This is a significant reversal of the U.S.'s net export position since the U.S. has been a substantial net importer of crude oil and refined petroleum products starting in the early 1950s (U.S. EIA 2022).

Oil is a commodity that is globally traded and, as a result, an oil price shock is transmitted globally. Given that the U.S. is projected to be a net exporter of crude oil and refined petroleum products for the timeframe of this analysis (2027–2055) for this rule, one could reason that the U.S. no longer has a significant energy security problem. However, U.S. refineries still rely on significant imports of heavy crude oil which could be subject to supply disruptions. Also, oil exporters with a large share of global production have the ability to raise or lower the price of oil by exerting the market power associated with the Organization of Petroleum Exporting Countries (OPEC) to alter oil supply relative to demand. These factors contribute to the vulnerability of the U.S. economy to episodic oil supply shocks and price spikes, even when the U.S. is projected to be an overall net exporter of crude oil and refined petroleum products. Reducing U.S. net oil imports and use reduces the U.S.'s exposure to oil price volatility.

EPA estimates that U.S. consumption and net imports of petroleum will be reduced as a result of this final rule, both from an increase in fuel efficiency of LMDVs using petroleum-based fuels and from the greater use of plug-in electric vehicles (PEVs), which are fueled with electricity. A reduction of U.S. net petroleum imports reduces both financial and strategic risks caused by potential sudden disruptions in the supply of petroleum to the U.S. and global market, thus increasing U.S. energy security. In other words, reduced U.S. oil imports act as a “shock absorber” when there is a supply disruption in world oil markets.

---

<sup>260</sup> The issue of cyberattacks is another energy security issue that could grow in significance over time. For example, in 2021, one of the U.S.'s largest pipeline operators, Colonial Pipeline, was forced to shut down after being hit by a ransomware attack. The pipeline carries refined gasoline and jet fuel from Texas to New York. (New York Times 2021).

It is anticipated that manufacturers will choose to comply with this final standard with significant increases in PEVs in the light- and medium-duty vehicle fleet. The wider use of electricity to power vehicles in the U.S. will likely result in the use of a generally more affordable fuel that has less price volatility compared to the current widespread use of gasoline in light- and medium-duty vehicles. Furthermore, the U.S. supply and demand of electricity is almost entirely domestic, and largely independent of electricity markets outside of North America. Over time, the wider penetration of PEVs into the U.S. vehicle fleet will likely provide significant energy security benefits, principally by reducing the overall U.S. demand for oil. As new PEVs enter the vehicle market and the stock of PEVs becomes an increasingly larger fraction of the total stock of vehicles on the road, high oil prices and oil price shocks will have a diminishing impact on the overall U.S. economy, leading to greater energy security. The wider use of electricity to power LMDVs will also move the U.S. toward energy independence; that is independence of foreign markets, since the electricity to power PEVs will almost exclusively be produced in the U.S.

This Chapter of the RIA first reviews the historical and recent energy security literature relevant in the context of this final rule. This review provides a discussion of recent oil security literature, recent studies on tight oil and recent electricity security studies on the wider use of PEVs. Second, this Chapter also provides an assessment of the electricity security implications of this final rule. Third, in the last section of this Chapter, the agency's estimates of U.S. oil import reductions of the final standards are presented. The military cost impacts of this final rule are discussed as well. However, due to methodological limitations, we do not quantify the military costs savings from reduced U.S. oil imports.

### **10.1 Review of Historical Energy Security Literature**

Energy security discussions are typically based around the concept of the oil import premium, sometimes also labeled the oil security premium. The oil import premium is the extra cost/impacts of importing oil beyond the price of the oil itself as a result of: (1) potential macroeconomic disruption and increased oil import costs to the economy from oil price spikes or "shocks"; and (2) monopsony impacts. Monopsony impacts stem from changes in the demand for imported oil, which changes the price of all imported oil. Oil import premia are used to quantify decreases in vulnerability to oil supply shocks resulting from a policy which reduces U.S. net imports of oil.

The so-called oil import premium gained attention as a guiding concept for energy policy in the aftermath of the oil shocks of the 1970s. (Bohi and Montgomery 1982), (EMF 1982), and (Plummer, et al. 1982) provided valuable discussion of many of the key issues related to the oil import premium as well as the analogous oil stockpiling premium. (Bohi and Montgomery 1982) detailed the theoretical foundations of the oil import premium and established many of the critical analytic relationships. Broadman and Hogan revised and extended the established analytical framework to estimate optimal oil import premia with a more detailed accounting of macroeconomic effects (Broadman and Hogan 1988) (Broadman 1986) (Hogan 1981). Since the original work on energy security was undertaken in the 1980s, there have been a couple of reviews on this topic: (Leiby, Jones, et al. 1997), (Parry and Darmstadter 2003).

The economics literature on whether oil shocks are the same level of threat to economic stability as they once were is mixed. Some of the literature asserts that the macroeconomic component of the energy security externality is small. For example, (National Research Council

2010) argued that the non-environmental externalities associated with dependence on foreign oil are small, and potentially trivial. (Nordhaus 2007) and (Blanchard and Galí 2010) question the impact of oil price shocks on the economy in the early 2000s timeframe. They were motivated by attempts to explain why the economy actually expanded during the oil shock in the early-2000s timeframe, and why there was no evidence of higher energy prices being passed on through higher wage inflation. One reason, according to Nordhaus and Blanchard and Galí, is that monetary policy has become more accommodating to the price impacts of oil shocks. Another reason is that consumers have simply decided that such movements are temporary and have noted that price impacts are not passed on as inflation in other parts of the economy.

One study, by (Hamilton 2012), reviews the empirical literature on oil shocks and suggests that the results are mixed, noting that some work finds less evidence for economic effects of oil shocks or declining effects of shocks (Rasmussen and Roitman 2011) (Blanchard and Galí 2010), while other work continues to find evidence regarding the economic importance of oil shocks. For example, (Baumeister and Peersman 2013) find that an “oil price increase of a given size seems to have a decreasing effect over time, but noted that the declining price-elasticity of demand meant that a given physical disruption had a bigger effect on price and turned out to have a similar effect on output as in the earlier data.” Hamilton observes that “a negative effect of oil prices on real output has also been reported for a number of other countries, particularly when non-linear functional forms have been employed” (citing as examples (Kim 2012) and (Engemann, Kliesen and Owyang 2011)). Alternatively, rather than a declining effect, (Ramey and Vine 2010) find “remarkable stability in the response of aggregate real variables to oil shocks once we account for the extra costs imposed on the economy in the 1970s by price controls and a complex system of entitlements that led to some rationing and shortages.”

Some of the literature on oil price shocks emphasizes that economic impacts depend on the nature of the oil shock, with differences between price increases caused by a sudden supply loss and those caused by rapidly growing demand. Recent analyses of oil price shocks have confirmed that “demand-driven” oil price shocks have greater effects on oil prices and tend to have positive effects on the economy while “supply-driven” oil shocks still have negative economic impacts (Baumeister, Peersman and Van Robays 2010). (Kilian and Vigfusson 2014), for example, assigns a more prominent role to the effects of price increases that are unusual, in the sense of being beyond the range of recent experience. Kilian and Vigfusson also conclude that the difference in response to oil shocks may well stem from the different effects of demand- and supply-based price increases: “One explanation is that oil price shocks are associated with a range of oil demand and oil supply shocks, some of which stimulate the U.S. economy in the short-run and some of which slow down U.S. growth” (Kilian 2009).

The general conclusion that oil supply-driven shocks reduce economic output is also reached in (Cashin, et al. 2014), which focused on 38 countries from 1979 to 2011. They state: “The results indicate that the economic consequences of a supply-driven oil-price shock are very different from those of an oil-demand shock driven by global economic activity and vary for oil-importing countries compared to energy exporters.” Cashin et al. continues “...oil importers (including the U.S.) typically face a long-lived fall in economic activity in response to a supply-driven surge in oil prices.” But almost all countries see an increase in real output caused by an oil-demand disturbance.

Considering all of the recent energy security literature, EPA’s assessment concludes that there are benefits to the U.S. from reductions in its oil imports. There is some debate as to the magnitude of energy security benefits from U.S. oil import reductions. However, differences in economic impacts from oil demand and oil supply shocks have been distinguished, with oil supply shocks resulting in economic losses in oil importing countries. The oil import premium calculations in this analysis (described in Chapter 10.4.2) are based on price shocks from potential future supply events. Oil supply shocks, which reduce economic activity, have been the predominant focus of oil security issues since the oil price shocks/oil embargoes of the 1970s.

## **10.2 Review of Recent Energy Security Literature**

There have also been a handful of recent studies that are relevant for the issue of oil security: one by Resources for the Future (RFF), a study by Brown, two studies by Oak Ridge National Laboratory (ORNL), and three studies by Newell and Prest, Bjørnland et al. and Walls and Zheng, on the responsiveness of U.S. tight oil to world oil price changes. We provide a review and high-level summary of each of these studies below. In addition, we review the recent literature on electricity security in the context of the wider use of PEVs.

### **10.2.1 Recent Oil Security Studies**

The first studies on the energy security impacts of oil that we review are by Resources for the Future (RFF), a study by Brown and two studies by Oak Ridge National Laboratory (ORNL).

The RFF study (Krupnick, et al. 2017) attempts to develop updated estimates of the relationship among gross domestic product (GDP), oil supply and oil price shocks, and world oil demand and supply elasticities. In a follow-on study, (Brown 2018) summarized the RFF study results as well. The RFF work argues that there have been major changes that have occurred in recent years that have reduced the impacts of oil shocks on the U.S. economy. First, the U.S. is less dependent on imported oil than in the early 2000s due in part to the “fracking revolution” (i.e., tight/shale oil), and to a lesser extent, increased production of renewable fuels such as ethanol and biodiesel. In addition, RFF argues that the U.S. economy is more resilient to oil shocks than in the earlier 2000s timeframe. Some of the factors that make the U.S. more resilient to oil shocks include increased global financial integration and greater flexibility of the U.S. economy (especially labor and financial markets), many of the same factors that Nordhaus and Blanchard and Gali pointed to as discussed above.

In the RFF effort, a number of comparative modeling scenarios are conducted by several economic modeling teams using three different types of energy-economic models to examine the impacts of oil shocks on U.S. GDP. The first is a dynamic stochastic general equilibrium model developed by (Balke and Brown 2018). The second set of modeling frameworks use alternative structural vector autoregressive models of the global crude oil market (Kilian 2009), (Kilian and Murphy 2014), (Baumeister and Hamilton 2019). The last of the models utilized is the U.S. Energy Information Administration’s National Energy Modeling System (NEMS).

Two key parameters are focused upon to estimate the impacts of oil shock simulations on U.S. GDP: oil price responsiveness (i.e., the short-run price elasticity of demand for oil) and GDP sensitivity (i.e., the elasticity of GDP to an oil price shock). The more inelastic (i.e., the less responsive) short-run oil demand is to changes in the price of oil, the higher will be the price impacts of a future oil shock. Higher price impacts from an oil shock result in higher GDP



losses. The more inelastic (i.e., less sensitive) GDP is to an oil price change, the less the loss of U.S. GDP with future oil price shocks.

For oil price responsiveness, RFF reports three different values: a short-run price elasticity of oil demand from their assessment of the “new literature,”  $-0.17$ ; a “blended” elasticity estimate,  $-0.05$ ; and short-run oil price elasticities from the “new models” RFF uses, ranging from  $-0.20$  to  $-0.35$ . The “blended” elasticity is characterized by RFF in the following way: “Recognizing that these two sets of literature [old and new] represent an evolution in thinking and modeling, but that the older literature has not been wholly overtaken by the new, Benchmark-E [the blended elasticity] allows for a range of estimates to better capture the uncertainty involved in calculating the oil security premiums.”

The second parameter that RFF examines is the GDP sensitivity. For this parameter, RFF’s assessment of the “new literature” finds a value of  $-0.018$ , a “blended elasticity” estimate of  $-0.028$ , and a range of GDP elasticities from the “new models” that RFF uses that range from  $-0.007$  to  $-0.027$ . One of the limitations of the RFF study is that the large variations in oil price over the last fifteen years are believed to be predominantly “demand shocks”: for example, a rapid growth in global oil demand followed by the Great Recession and then the post-recession recovery.

There have only been two recent situations where events have led to a potential significant supply-side oil shock in the last several years. The first event was the attack on the Saudi Aramco Abqaiq oil processing facility and the Khurais oil field. On September 14, 2019, a drone and cruise missile attack damaged the Saudi Aramco Abqaiq oil processing facility and the Khurais oil field in eastern Saudi Arabia. The Abqaiq oil processing facility is the largest crude oil processing and stabilization plant in the world, with a capacity of roughly 7 MMBD or about 7 percent of global crude oil production capacity (U.S. EIA 2019). On September 16, the first full day of commodity trading after the attack, both Brent and WTI crude oil prices surged by  $\$7.17/\text{barrel}$  and  $\$8.34/\text{barrel}$ , respectively, in response to the attack, the largest price increase in roughly a decade.

However, by September 17, Saudi Aramco reported that the Abqaiq plant was producing 2 MMBD, and they expected its entire output capacity to be fully restored by the end of September (U.S. EIA 2019). Tanker loading estimates from third-party data sources indicated that loadings at two Saudi Arabian export facilities were restored to the pre-attack levels (U.S. EIA 2019). As a result, both Brent and WTI crude oil prices fell on September 17th, but not back to their original levels. The oil price spike from the attack on the Abqaiq plant and Khurais oil field was prominent and unusual, as Kilian and Vigfusson (2014) describe. While pointing to possible risks to world oil supply, the oil shock was short-lived, and generally viewed by market participants as being transitory, so it did not influence oil markets over a sustained time period.

The second situation is the set of events leading to the recent world oil price spike experienced in 2022. World oil prices rose fairly rapidly at the beginning of 2022. For example, as of January 3, 2022, the WTI crude oil price was roughly  $\$76$  per barrel (U.S. EIA 2023). The WTI oil price increased to roughly  $\$123$  per barrel on March 8, 2022, a 62 percent increase (U.S. EIA 2023). High and volatile oil prices in the first part of 2022 were a result of supply concerns with Russia’s invasion of Ukraine on February 24 contributing to crude oil price increases (U.S. EIA 2022). Russia’s invasion of Ukraine came after eight consecutive quarters of global crude oil inventory decreases. The lower inventory of crude oil stocks was the result of rising economic

activity after COVID-19 pandemic restrictions were eased. Oil prices drifted downwards throughout the second half of 2022 and in the early part of 2023. Since both significant demand and supply factors were influencing world oil prices in 2022, it is not clear how to evaluate unfolding oil market price trends from an energy security standpoint. Thus, the attack of the Abqaiq oil processing facility in Saudi Arabia and the unfolding events in the world oil market in 2022 do not currently provide enough empirical evidence to undertake an updated estimate of the response of the U.S. economy to an oil supply shock of a significant magnitude.<sup>261</sup>

More recently, in its November 2023 *Short-term Energy Outlook*, EIA is forecasting global oil production will increase by 1.0 million barrels per day in 2024 (U. EIA 2023). Ongoing OPEC+ production cuts will offset production growth from non-OPEC countries and help maintain a relatively balanced global oil market in 2024. The surprise attack by Hamas on Israel on October 7, 2023, leading to the Hamas-Israel War, is leaving oil markets on edge, increasing fears that fighting between Israel and Hamas may affect oil production in the Middle East. Although the conflict between Israel and Hamas has not affected physical oil supply at this point, uncertainties surrounding the conflict and other global oil supply conditions could put upward pressure on crude oil prices in the coming months. EIA is forecasting the average price of Brent crude oil will be \$93/barrel in 2024.

A second set of recent studies related to energy security are from ORNL. In the first study, (Uría-Martínez, et al. 2018) undertake a quantitative meta-analysis of world oil demand elasticities based upon the recent economics literature. The ORNL study estimates oil demand elasticities for two sectors (transportation and non-transportation) and by world regions (OECD and Non-OECD) by meta-regression. To establish the dataset for the meta-analysis, the authors undertake a literature search of peer-reviewed journal articles and working papers between 2000 and 2015 that contain estimates of oil demand elasticities. The dataset consisted of 1,983 elasticity estimates from 75 published studies. The study finds a short-run price elasticity of world oil demand of  $-0.07$  and a long-run price elasticity of world oil demand of  $-0.26$ .

The second relevant ORNL study from the standpoint of energy security is a meta-analysis that examines the impacts of oil price shocks on the U.S. economy as well as many other net oil-importing economies (Oladosu, et al. 2018). Nineteen studies after 2000 were identified that contain quantitative/accessible estimates of the economic impacts of oil price shocks. Almost all studies included in the review were published since 2008. The key result that the study finds is a short-run oil price elasticity of U.S. GDP, roughly one year after an oil shock, of  $-0.021$ , with a 68 percent confidence interval of  $-0.006$  to  $-0.036$ .

---

<sup>261</sup> The Hurricanes Katrina/Rita in 2005 primarily caused a disruption in U.S. oil refinery production, with a more limited disruption of some crude supply in the U.S. Gulf Coast area. Thus, the loss of refined petroleum products exceeded the loss of crude oil, and the regional impact varied even within the U.S. The Katrina/Rita hurricanes were a different type of oil disruption event than is quantified in the Stanford EMF risk analysis framework, which provides the oil disruption probabilities that ORNL is using.

### **10.2.2 Recent Tight (i.e., Shale) Oil Studies**

The discovery and development of U.S. tight (i.e., shale) oil reserves that started in the mid-2000s could affect U.S. energy security in at least a couple of ways.<sup>262</sup> First, the increased availability of domestic supplies has resulted in a reduction of U.S. oil imports and an increasing role of the U.S. as exporter of crude oil and petroleum-based products. In December 2015, the 40-year ban on the export of domestically produced crude oil was lifted as part of the Consolidated Appropriations Act, 2016. Pub. L. 114-113 (Dec. 18, 2015). According to the GAO, the ban was lifted in part due to increases in tight (i.e., shale) oil (U.S. GAO 2020).<sup>263</sup> Second, due to differences in development cycle characteristics and average well productivity, tight oil producers could be more price responsive than most other oil producers. However, the oil price level that triggers a substantial increase in tight oil production appears to be higher in 2021–2022 relative to the 2010s as tight oil producers seek higher profit margins per barrel in order to reduce the debt burden accumulated in previous cycles of production growth (Kemp 2021). Other factors such as cost inflation and supply chain constraints have contributed to the slow pace of tight oil production growth in the early 2020s, despite high world oil prices. Although some of those factors may be transitory, the muted production response of 2021–2022 suggests that tight oil producers (and their investors) are not likely to increase drilling in a quick, coordinated manner in response to future potential world oil price spikes. For that reason, the short-run price responsiveness assumed for U.S. tight oil for the estimation of the oil security benefits of this final rule is the same as for other non-OPEC oil supplies.

U.S. crude oil production increased from 5.0 Million Barrels a Day (MMBD) in 2008 to an all-time peak of 12.7 MMBD in 2023 (January through July) and tight oil wells have been responsible for most of the increase (U.S. EIA 2023). Figure 10-1 below shows tight oil production changes from various tight oil producing regions (i.e., Eagle Ford, Bakken etc.) in the U.S. and the West Texas Intermediate (WTI) crude oil spot price. As illustrated in Figure 10-1, the annual average U.S. tight oil production grew from 0.6 MMBD in 2008 to 7.8 MMBD in 2019 (U.S. EIA 2023). Growth in U.S. tight oil production during this period was only interrupted in 2015–2016 following the world oil price downturn which began in mid-2014. The second growth phase started in late 2016 and continued until 2020. The sharp decrease in demand that followed the onset of the COVID-19 pandemic resulted in a 25 percent decrease in tight oil production in the period from December 2019 to May 2020. U.S. tight oil production in 2020 and 2021 averaged 7.4 MMBD and 7.2 MMBD, respectively. More recently, in March 2023, tight oil production surpassed the previous historical maximum (8.37 MMBD in November 2019) with 8.43 MMBD. Growth in tight oil production continued over the following

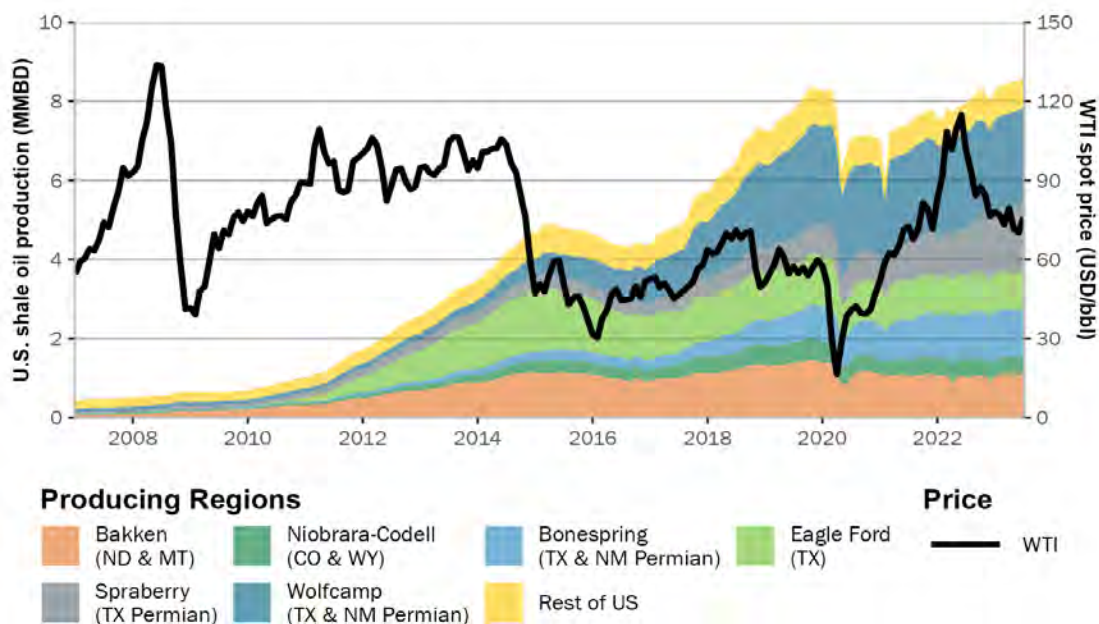
---

<sup>262</sup> The Union of Concerned Scientist define tight oil as follows: “Tight oil is a type of oil found in impermeable shale and limestone rock deposits. Also known as “shale oil,” tight oil is processed into gasoline, diesel, and jet fuels – just like conventional oil – but is extracted using hydraulic fracturing, or “fracking.” (Union of Concerned Scientists 2015).

<sup>263</sup> According to the GAO, “Between 1975 and the end of 2015, the Energy Policy and Conservation Act directed a ban on nearly all exports of U.S. crude oil. This ban was not considered a significant policy issue when U.S. oil production was declining and import volumes were increasing. However, U.S. crude oil production roughly doubled from 2009 to 2015, due in part to a boom in shale oil production made possible by advancements in drilling technologies. In December 2015, Congress effectively repealed the ban, allowing the free export of U.S. crude oil worldwide.”

months, reaching 8.57 MMBD in July 2023. Most of the 2023 growth has come from two Permian producing regions: Spraberry and Bonespring.

Importantly, U.S. tight oil is considered the most price-elastic component of non-OPEC supply due to differences between its development and production cycle and that of conventional oil wells. Unlike conventional wells where oil starts flowing naturally after drilling, tight oil wells require the additional step of fracking to complete the well and release the oil.<sup>264</sup> Tight oil producers keep a stock of drilled but uncompleted wells and can optimize the timing of the completion operation depending on oil price expectations. Combining this decoupling between drilling and production with the “front-loaded” production profile of tight oil – the fraction of total output from a well that is extracted in the first year of production is higher for tight oil wells than conventional oil wells – tight oil producers have a clear incentive to be responsive to prices in order to maximize their revenues (Bjørnland, Nordvik and Rohrer 2020).



**Figure 10-1: U.S. tight oil production by producing regions (in MMBD) and West Texas Intermediate (WTI) crude oil spot price (in U.S. Dollars per Barrel) Source: (U.S. EIA 2023) (U.S. EIA 2023).**

Only in recent years have the implications of the “tight/shale oil revolution” been felt in the international market where U.S. production of oil is rising to be roughly on par with Saudi Arabia and Russia. Recent economics literature of the tight oil expansion in the U.S. has a bearing on the issue of energy security as well. It could be that the large expansion in tight oil has eroded the ability of OPEC to set world oil prices to some degree, since OPEC cannot directly influence tight oil production decisions. Also, by affecting the percentage of global oil supply controlled by OPEC, the growth in U.S. oil production may be influencing OPEC’s

<sup>264</sup> Hydraulic fracturing (“fracking”) involves injecting water, chemicals, and sand at high pressure to open fractures in low-permeability rock formations and release the oil that is trapped in them.

degree of market power. But given that the tight oil expansion is a relatively recent trend, it is difficult to know how much of an impact the increase in tight oil is having, or will have, on OPEC behavior.

Three recent studies have examined the characteristics of tight oil supply that have relevance for the topic of energy security. In the context of energy security, the question that arises is: can tight oil respond to an oil price shock more quickly and substantially than conventional oil? If so, then tight oil could potentially lessen the impacts of future oil shocks on the U.S. economy by moderating the price increases from a future oil supply shock.

The first study considered, (Newell and Prest 2019), looks at differences in the price responsiveness of conventional versus tight oil wells, using a detailed dataset of 150,000 oil wells, during the timeframe of 2005–2017 in five major oil-producing states: Texas, North Dakota, California, Oklahoma, and Colorado. For both conventional oil wells and tight oil wells, Newell and Prest estimate the elasticities of drilling operations and well completion operations with respect to expected revenues and the elasticity of supply from wells already in operation with respect to spot prices. Combining the three elasticities and accounting for the increased share of tight oil in total U.S. oil production during the period of analysis, they conclude that U.S. oil supply responsiveness to prices increased more than tenfold from 2006 to 2017. They find that tight oil wells are more price responsive than conventional oil wells, mostly due to their much higher productivity, but the estimated oil supply elasticity is still relatively small. Newell and Prest note that the tight oil supply response still takes more time to arise than is typically considered for a “swing producer,” referring to a supplier able to increase production quickly, within 30–90 days. In the past, only Saudi Arabia and possibly one or two other oil producers in the Middle East have been able to ramp up oil production in such a short period of time.

Another study, (Bjørnland, Nordvik and Rohrer 2020), uses a well-level monthly production data set covering more than 16,000 crude oil wells in North Dakota from February 1990 to June 2017 to examine differences in supply responses between conventional and tight oil. They find a short-run (i.e., one-month) supply elasticity with respect to oil price for tight oil wells of 0.71, whereas the one-month response of conventional oil supply is not statistically different from zero. It should be noted that the elasticity value estimated by Bjørnland et al. combines the supply response to changes in the spot price of oil as well as changes in the spread between the spot price and the 3-month futures price. (Walls and Zheng 2022) explore the change in U.S. oil supply elasticity that resulted from the tight oil revolution using monthly, state-level data on oil production and crude oil prices from January 1986 to February 2019 for North Dakota, Texas, New Mexico, and Colorado. They conduct statistical tests that reveal an increase in the supply price elasticities starting between 2008 and 2011 coinciding with the times in which tight oil production increased sharply in each of these states. Walls and Zheng also find that supply responsiveness in the tight oil era is greater with respect to price increases than price decreases. The short-run (one-month) supply elasticity with respect to price increases during the tight oil area ranges from zero in Colorado to 0.076 in New Mexico; pre-tight oil, it ranged from zero to 0.021.

The results from (Newell and Prest 2019), (Bjørnland, Nordvik and Rohrer 2020), and (Walls and Zheng 2022) all suggest that tight oil may have a larger supply response to oil prices in the short-run than conventional oil, although the estimated short-run elasticity is still relatively small. The three studies use datasets that end in 2019 or earlier. The responsiveness of U.S. tight

oil production to recent price increases does not appear to be consistent with that observed during the episodes of crude oil price increases in the 2010s captured in these three studies. Despite an 80 percent increase in the WTI crude oil spot price from October 2020 to the end of 2021, Figure 10-1 shows that U.S. tight oil production has increased by only 8 percent in the same period. It is a somewhat challenging period in which to examine the supply response of tight oil to its price to some degree, given that the 2020–2021 time period coincided with the COVID-19 pandemic. Previous tight oil production growth cycles were financed predominantly with debt, at very low interest rates (McLean 2018). Most U.S. tight oil producers did not generate positive cashflow (McLean 2018). As of 2021, U.S. tight oil producers have pledged to repay their debt and reward shareholders through dividends and stock buybacks (Crowley and Wethe 2021). These pledges translate into higher prices that need to be reached (or sustained for a longer period) than in the past decade to trigger large increases in drilling activity.

In its first quarter 2022 energy survey, the Dallas Fed (Federal Reserve Bank of Dallas 2022) asked oil exploration and production firms about the WTI price levels needed to cover operating expenses for existing wells or to profitably drill a new well. The average breakeven price to continue operating existing wells in the tight oil regions ranged from \$23/barrel (bbl) to \$35/bbl. To profitably drill new wells, the required average WTI prices ranged from \$48/bbl to \$69/bbl. For both types of breakeven prices, there was substantial variation across companies, even within the same region. The actual WTI price level observed in the first quarter of 2022 was roughly \$95/bbl, substantially larger than the breakeven price to drill new wells. However, the median production growth expected by the respondents to the Dallas Fed Energy Survey from the fourth quarter of 2021 to the fourth quarter of 2022 is modest (6 percent among large firms and 15 percent among small firms). Investor pressure to maintain capital discipline was cited by 59 percent of respondents as the primary reason why publicly traded oil producers are restraining growth despite high oil prices. The other reasons cited included supply chain constraints, difficulty in hiring workers, environmental, social, and governance concerns, lack of access to financing, and government regulations. Given the recent behavior of tight oil producers, we do not believe that tight oil will provide additional significant energy security benefits in the timeframe of this analysis, 2027–2055, due to its muted price responsiveness. The ORNL model still accounts for the effect of U.S. tight oil production increases on U.S. oil imports and, in turn, the U.S.’s energy security position.

Finally, despite continuing uncertainty about oil market behavior and outcomes and the sensitivity of the U.S. economy to oil shocks, it is generally agreed that it is beneficial to reduce petroleum fuel consumption from an energy security standpoint. The relative significance of petroleum consumption and import levels for the macroeconomic disturbances that follow from oil price shocks is not fully understood. Recognizing that changing petroleum consumption will change U.S. imports, our quantitative assessment of the oil security costs of this rule focuses on those incremental social costs that follow from the resulting changes in net imports, employing the usual oil import premium measure used in the energy security literature.

### **10.2.3 Recent Electricity Security Studies**

The International Energy Agency (IEA) defines energy security as the uninterrupted availability of energy sources at affordable prices (IEA 2019). The energy security literature, first developed in response to the oil shocks of the 1970s, is extensive. This literature mainly focuses on the energy security benefits of reduced oil use, particularly oil imports. However, even though

there is likely to be a substantial increase in the use of electricity from PEVs in the U.S., the literature on the topic of the energy security implications of wider use of PEVs is somewhat limited. We have not been able to identify any study that systematically quantifies the differential energy security risks of using electricity versus petroleum-based fuels to power vehicles in the U.S. Nonetheless, a review of existing, published studies provides information to help assess the implications of the use of electricity as transportation fuel in light- and medium-duty vehicles in the U.S. across multiple dimensions of energy security – affordability, price stability, and resilience/reliability – as well as energy independence.<sup>265</sup>

Since the energy security literature has largely focused on the economic and national security risks associated with oil imports, early studies considering the energy security benefits of PEVs focus on the reduction in oil imports that results from widespread PEV adoption. (Michalek, et al. 2011) quantifies this aspect of the energy security impacts of PEVs. The study focuses on the benefits associated with a reduction in U.S. oil imports from the wider use of PEVs and provides a direct estimate of the energy security benefits of using PEVs in the U.S. based on the amount of oil PEVs displace over the lifetime of a typical PEV. They use a \$0.34/gal (2010 dollars) estimate of the avoided macroeconomic disruption costs/monopsony/military cost savings for oil to calculate an energy security benefit of roughly \$1,000 over the lifetime of a PEV. (Michalek, et al. 2011) is similar to the approach used by EPA in past vehicle rulemakings: estimate the displaced petroleum use and apply a security cost premium that draws on some of the same studies that EPA uses. But EPA does not include monopsony impacts or quantify military cost savings as benefits. The Michalek et al. study also does not account for electricity supply stability.

### **10.2.3.1 Fuel Costs**

Most of the cost comparisons of PEVs versus gasoline-powered vehicles in the literature are total cost of ownership (TCO) studies, which compare the total cost of purchasing, owning, and operating each type of vehicle for a specified number of years. They include the vehicle purchase costs as well as annual operation (fees, fuel, and insurance) and maintenance costs.

Vehicles are refueled fairly frequently and increased fueling costs due to energy price spikes are felt almost immediately by consumers, whereas the impact of price changes in components and materials used to produce vehicles (e.g., alloys, batteries, etc.), which are also considered in a TCO analysis, only impact consumers when purchasing a vehicle. Our focus in this Chapter is on energy markets. Critical materials and the supply chains necessary for PEV production are, therefore, outside of our intended scope in this discussion of energy security. See preamble IV.C.7 and Chapter 3 of the RIA for a discussion of critical materials and PEV supply chains.

TCO studies of vehicles in the U.S. find that fuel costs are lower for PEVs than internal combustion engine (ICE) vehicles. See, for examples, (Slowik, Isenstadt, et al., Assessment of Light-duty Electric Vehicle Costs and Consumer Benefits in the United States in the 2022-2035 Time Frame 2022), (Liu, et al. 2021), (Lutsey and Nicholas 2019), and (Breetz and Salon 2018). TCO studies tend to not explore in great detail the heterogeneity in fuel costs for PEV owners

---

<sup>265</sup> Our discussion of "affordability" in this Chapter only considers fuel costs, including gasoline prices and charging costs for PEVs. Vehicle purchase costs are not considered within the scope of our evaluation of energy security. More discussion of consumer impacts in the context of PEVs is presented in Chapter 4 of this RIA.

depending on geography and charging location or strategy, but other studies focus on the sources of PEV fuel cost variability. For example, a 2017 brief by the Union of Concerned Scientists examines the rates offered by electric utilities in the 50 largest U.S. cities and finds that all of them offered at least one electricity rate that results in fuel savings for PEV owners compared to a gasoline-powered vehicle, with median annual savings of \$770 (Union of Concerned Scientists 2015). Clearly these savings depend on the prevailing price of petroleum fuels, which varies widely over location and the assumed efficiency of the comparable gasoline vehicle.

One study, by (Borlaug, Salisbury, et al., *Levelized Cost of Charging Electric Vehicles in the United States* 2020), performed a detailed analysis of PEV charging costs in the U.S. that takes into consideration the type of charging equipment, a range of real-world electricity rates, and frequency of charging at home versus workplace or public stations. They find that PEV fuel cost savings over a 15-year period ranged from \$3,000 to \$10,500 (2019 dollars) for average U.S. electricity and gasoline price projections, respectively, with additional variability across states and depending on PEV lifetimes. The percentage of battery charging done at home versus using public chargers is an important source of variability in the fuel costs of individual PEV owners. Extracting charging rate information from a commercial database that includes records for more than 30,000 U.S. public chargers, (Trinko, et al. 2021) reports mean rates of 28 cents/kWh for Level 2 chargers and 32 cents/kWh for faster Direct Current Fast Charging chargers; in contrast, the study reports a lower mean residential electric rate of 13 cents/kWh as of March 2021.

To date, residential charging access has been prevalent among PEV owners. (Y. Ge, C. Simeone, et al., *There's No Place Like Home: Residential Parking, Electrical Access, and Implications for the Future of Electric Vehicle Charging Infrastructure* 2021) find that the percentage of PEVs with residential charging access is likely to become more uncertain as the PEV market share of light-duty vehicles increases. They conducted a survey to gather detailed information on residential parking availability, parking behavior, and electrical access by parking location. Combining public data on housing stock and light-duty vehicle stock characteristics with the survey results, the authors develop estimates of residential charging access percentages for each housing type and a PEV adoption likelihood model using housing type, housing tenure (owning versus renting), income, population density, and presence/absence of zero emission vehicle incentives in the state of residence as explanatory variables. For PEV shares no greater than 10 percent of total light-duty vehicles, residential charging access is estimated to range from 78 percent to 98 percent. For a 90 percent PEV share, the estimated residential charging access percentage ranges from 35 percent to 75 percent. The higher end of the ranges represents a scenario that requires modifications in parking behavior (e.g., parking in garage rather than driveway) and installation of electrical access whenever possible, if not already available at the residential parking location.

In a study for the California Public Utilities Commission, (Sieren-Smith, et al. 2021) projects future fuel costs of PEVs in California for the 2020–2030 timeframe in comparison to gasoline-powered vehicles. This study finds that there is wide spatial variability in fuel costs for PEVs and there are substantial differences across individual electric utilities within California alone. The study also finds that for customers with Time of Use (TOU) tariffs, charging a PEV regularly at the off-peak rates (i.e., “managed charging” as opposed to “unmanaged charging”) results in significant fuel cost savings. With TOU tariffs or Time Variable Pricing, electricity prices depend on the time of use, and change at set times and amounts through the day – generally with higher prices in an afternoon peak period and lower prices in overnight off-peak hours (U.S.



DOE 2022). The study also finds that PEV fuel costs are likely to be lower than gasoline-powered vehicles' fuel costs across a variety of assumptions about projected gasoline and electricity prices and managed/unmanaged PEV charging rates in California over the timeframe of the analysis.

In the U.S., according to (Hardman, et al. 2021), the lowest income households spend 11.2 percent of their annual income on fuel, maintenance, and repairs of vehicles compared to all other households that spend 4.5 percent of their annual income on these expenses. For the most common use case in terms of PEV charging equipment (i.e., at-home charging), fuel costs in the U.S. are lower for PEVs than gasoline-powered vehicles. Therefore, owning a PEV results in a lower percentage of household income going toward that expense category. However, (Hardman, et al. 2021) find that lower income households are less able to afford installation of residential charging equipment and more likely to live in multi-unit dwellings without a designated parking space and charging equipment. Thus, low-income households that purchase a PEV and have no residential charging and, thus, rely primarily on public chargers, could potentially face higher fuel costs and a larger overall energy burden (i.e., fraction of household income directed toward energy costs) with a PEV than a gasoline-powered vehicle. The Inflation Reduction Act (IRA) signed into law on August 16, 2022, can help reduce the costs for deploying charging infrastructure (Inflation Reduction Act 2022). The IRA extends the Alternative Fuel Refueling Property Tax Credit (Section 13404) through Dec 31, 2032, with modifications. Under the new provisions, residents in low-income and rural areas would be eligible for a 30 percent credit for the cost of installing residential charging equipment up to a \$1,000 cap.

#### **10.2.3.2 Fuel Price Stability/Volatility**

One study, by (Melodia and Karlsson 2022), shows that the rate of inflation and volatility of U.S. retail electricity prices have been historically much lower than for gasoline. Using consumer price data from the Bureau of Labor Statistics from 1968 to 2022, the authors report that gasoline was almost four times more volatile than electricity during that period. The diversity of the fuel mix used to produce electricity and the stronger regulatory oversight of the U.S. electricity sector, where residential electricity rates must meet a “just and reasonable” standard, are among the reasons for the lower volatility of electricity prices versus gasoline prices. The authors also discuss how renewable electricity generation can contribute to electricity price stability. First, the cost profile of renewable resources such as wind and solar involves an initial large fixed-capital investment but have no fuel costs once they are in operation, removing a key source of the price volatility experienced by electricity generation plants that use fossil fuels. Moreover, wind and solar resources are available much more widely across the globe than oil and gas resulting in lower geopolitical supply risk – although some risk is still present through the critical materials needed to produce renewable energy infrastructure components such as wind turbines, solar panels, and electric batteries (Melodia and Karlsson 2022).

While (Melodia and Karlsson 2022) discuss the positive contribution that increased use of renewables can make to electricity price stability, other authors consider how the process of decarbonization in the energy sector might affect oil price stability. (Bordoff and O’Sullivan 2022) suggest that a smooth transition to clean energy in response to climate change may be challenging and may result in more price volatility in oil markets. In other words, they suggest that the transition to clean energy may be “jagged.” According to the authors, the combination of pressure on investors to divest from fossil fuels and uncertainty about the future of oil demand

may raise concerns that oil investment levels may decrease in the future, leading to oil supplies declining at a faster rate than oil demand falls – or declining even as oil demand continues to rise. This outcome could produce more volatile oil prices. Also, in the early stages of the transition to clean energy before oil demand declines significantly, the power of OPEC and other non-competitive suppliers could be boosted by increasing their revenues, while giving OPEC extra clout as a “swing producer” when world oil markets are tight.

### **10.2.3.3 Electricity Reliability/Resiliency**

Reliability and resilience of electricity service are needed to ensure the “continuous availability” of service that is required for a fuel to be considered secure. (U.S. DOE 2017) defines the two terms as follows. Reliability is “the ability of the electric power sector to provide a stable source of electricity to consumers, both households and businesses, under normal operating conditions.” Resilience is “the ability of the electric power sector to withstand and recover from any disruptions created by extreme weather, cyberattack, terrorism, or other unanticipated events.” A reliable and resilient electricity sector is crucial for the U.S.’s national security. The Department of Defense is the largest customer of the electricity grid in the U.S. (U.S. DOE 2017). Also, the electricity sector is interconnected with many other types of critical infrastructure – water systems, oil, natural gas, communications, information technology, and financial services – crucial for the U.S. economy to function (U.S. DOE 2017). Standards and metrics to track reliability are better established than those for resilience, which is concerned with lower probability, high-consequence events (U.S. DOE 2017).

Electricity, while generally reliably provided in the U.S., is subject to periodic supply disruptions (i.e., “electricity outages”) due to a variety of factors including (but not limited to): weather-related events such as hurricanes, heat waves/storms, wildfires; cybersecurity risks; and system/equipment failures. On average, U.S. electricity customers experienced eight hours of power outages in 2020, the most since the DOE’s Energy Information Administration (EIA) began collecting electricity reliability data in 2013 (U.S. EIA 2021). The Fourth National Climate Assessment, released in 2018, concludes that “climate change will increasingly threaten the U.S. energy supply via more frequent and long-lasting power outages that will broadly affect critical energy infrastructure” (Zamuda, et al. 2018). It also states that extreme weather is already the most frequent cause of electricity grid outages in the U.S. Electricity in the U.S. is provided by a set of local and regional interconnected electric grids. Thus, electricity supply disruptions are likely to result in electricity outages that are more local or regional in their nature in comparison to petroleum disruptions, which commonly have national or, oftentimes, global impacts. See Chapter 5.4 of the RIA for further discussion of grid reliability.

U.S. electric utilities follow long-term plans to ensure electricity reliability. These plans, typically known as integrated resource plans, set out an investment roadmap to ensure sufficient regional generation capacity and power purchases to meet the projected demand in their electricity service areas. According to (Bistline 2021), although these long-term plans contribute to electricity supply reliability, both resource planning and electric grid operation are becoming more difficult due to overlapping layers of increased variability in electricity supply and demand. For example, climate change is leading to an increase in the frequency and severity of extreme weather events which affects both supply (e.g., droughts reducing hydropower generation) and demand (e.g., record peak loads due to heat waves). Increased penetration of wind and solar also results in significant fluctuations in electricity production at different time scales that need to be

managed by electric grid operators and planners. Maintaining reliability of supply and price stability under this new set of evolving conditions requires a range of technology, analysis, and policy solutions (Bistline 2021).

As auto manufacturers respond to this final rule with increased sales of PEVs, U.S. electricity demand is anticipated to increase. Overall, U.S. electricity demand is projected to increase by 12 Terawatt-hours (TWh) in 2028 (a 0.26 percent increase), 45 TWh in 2030 (a 0.94 percent increase), 178 TWh in 2035 (a 3.43 percent increase), 322 TWh in 2040 (a 5.73 percent increase), and 475 TWh in 2050 (a 7.3 percent increase). See Chapter 5 of this RIA for more discussion of these estimates. Projections of PEV uptake will need to be accounted for by U.S. electric utilities and transmission system operators in their resource planning processes.

At early levels of PEV adoption, the investments needed to shore up electric grid reliability might first appear at the local distribution level. Early PEV sales to date have often happened in clusters such that some neighborhoods have achieved large PEV penetrations even as PEV market share remained lower at the regional or national level. The extent of distribution level reliability impacts will depend on multiple factors: number of PEVs, PEV mix (BEVs/PHEVs), type of charger used (Level 1, Level 2), and most importantly, whether charging is managed or unmanaged. (Muratori 2018) evaluates the effect of uncoordinated PEV charging on residential demand. The author finds that uncoordinated PEV charging leads to more pronounced and abrupt load (i.e., electricity demand) peaks which shorten the life of distribution transformers. Using detailed datasets of charging events at homes and public chargers in California to simulate future PEV charging behavior (timing of charging and duration), (Jenn and Highleyman 2022) conclude that in a scenario with 6 million PEVs in California (compared to approximately 1 million in 2021), more than 20 percent of distribution feeder circuits would experience loads greater than their capacity, resulting in accelerated degradation of the distribution network equipment and requiring upgrades to maintain adequate electricity grid reliability.

Another study, (Powell, et al. 2022), explores electric grid impacts in the U.S. portion of the Western Interconnection grid in 2035 under scenarios with high penetration (greater or equal to 50 percent adoption) of light-duty PEVs. They find that the timing of the extra electricity demand brought about by PEVs depends on charging behavior and is crucial to the magnitude of the electric grid impacts. The authors develop a detailed model of charging behavior where drivers are assigned to clusters based on combinations of the battery capacity of their PEVs, number of miles driven per year, and access to charging infrastructure. The aggregated PEV charging demand is then used as an input in a generation dispatch model that represents the Western Interconnection 2035 grid by accounting for planned generation unit additions/retirements, increasing baseline demand to reflect electrification of other sectors, and multiplying solar generation by a factor of 3.5 and wind generation by a factor of 3 relative to 2019 levels.

The authors calculate the electric grid impacts for various scenarios regarding charging controls and access to home and workplace charging infrastructure. All charging scenarios assume unidirectional charging (i.e., no vehicle-to-grid flows). For the Western Interconnection, given the high level of penetration of solar generation expected by 2035, daytime charging leads to lower costs and emissions because it aligns better with the solar generation profile. Investing in widespread access to workplace charging leads to lower peak net demand (i.e., peak demand net of solar and wind generation), lower electricity grid storage capacity investment needs, less

ramping-related costs from the operation of fossil fuel generators, and lower CO<sub>2</sub> emissions per mile driven by PEVs. Since the U.S. electricity grid is composed of a set of regional electricity grids with different fuel mixes, the charging infrastructure and charging schedules that will best match and balance the extra electricity demand from PEVs with electricity supply will vary on a region-by-region basis.

Large and abrupt electricity demand peaks due to PEV charging deserve special attention when they are linked to extreme weather events that can also disrupt the demand and supply of electricity. (Feng, et al. 2020) explore the mobility implications of vehicle fleets with high PEV penetration rates during extreme weather events triggering evacuation orders. They simulate the evacuation traffic flow during Hurricane Irma and compare electricity demand if all evacuating vehicles were PEVs with the transmission capacity in the Florida electric grid. They conclude that up to a fleet-wide PEV penetration rate of 45 percent could have been supported by the existing transmission network during that evacuation scenario. The more general insights from the analysis include: 1) fleetwide PEV penetration levels of up to 45 percent can be helpful during an evacuation scenario to alleviate gasoline shortages, 2) PHEVs are especially valuable during those events as drivers can start the evacuation trip using their battery and fill their gasoline tanks away from the population centers that experience gasoline shortages when an evacuation order is announced, and 3) development of disaster-optimized charging schedules would be crucial to avoid surges of power during an extreme event such as a hurricane as PEV penetration increases. Under the final standards, the penetration rates of PEVs in the stock of U.S. light- and medium-duty vehicles are projected to remain below a 45 percent rate until the 2040s. By the 2040s, there should be sufficient lead time for the U.S. electricity grid to expand and accommodate increasingly higher penetration rates of PEVs.

With PEVs becoming an increasingly significant portion of vehicles on the road in the U.S., some losses in overall U.S. output, measured in terms of a loss in U.S. gross domestic product (GDP), will likely result from electricity supply disruptions. The losses in U.S. output will be determined by the extent and duration of the future electricity supply disruptions, the flexibility of the additional electricity demand from PEVs, and whether PEVs can help avoid or ameliorate electricity supply disruptions. Given the local and regional nature of electricity supply disruptions and noting that the U.S. is projected to produce almost all of its own electricity (see discussion below), the losses in U.S. output from future electricity supply disruptions will likely be lower than output losses that have resulted from world oil supply disruptions with the widespread use of gasoline-powered vehicles. Higher electricity payments in the event of a U.S. electricity supply disruption will be transferred to other electricity producers in the U.S., not to foreign suppliers, as was the case in past oil supply disruptions, which will reduce the effective cost to the U.S. economy. However, more analysis is needed to make a definitive statement about the net effect of this final rule on expected GDP losses from future electricity and oil supply disruptions or price spikes. Estimates of disruption probabilities and associated U.S. macroeconomic disruption costs are available for oil but not for electricity. Without an estimate of electricity disruption probabilities and expected U.S. output losses, it is difficult to conduct assessments of the size and types of potential investments, or initiatives in the U.S. electricity sector, that could mitigate or adapt to those losses.

Although PEVs can pose challenges for electricity supply reliability if PEV charging is not coordinated, PEVs can also potentially provide an important source of electricity storage, which could help to improve the overall functioning of the U.S. electricity grid in terms of the

reliability and availability of electricity over time. See Chapter 5.4 of the RIA for more discussion on this topic. With a bidirectional connection to the electricity grid that enables vehicle-to-grid (V2G) flows, PEVs can act as a storage resource that provides energy during electric peak demand hours by discharging their batteries while parked. PEVs can also provide services to the electrical grid such as frequency and voltage regulation or act as electricity reserves, ready to supply energy in response to an outage at an electricity generation facility. In addition, PEVs can be used to provide electricity to home residences in the event of an electricity supply disruption. Managed bidirectional flows of energy from a large PEV fleet could also be particularly valuable to integrate higher levels of variable renewables (wind and solar) into the electricity generation mix (Yilmaz and Krein 2013).

The wider use of electricity in U.S. vehicles also provides both short- and long-run fuel substitution opportunities for vehicle owners facing high and volatile world oil prices. For example, drivers of PHEVs can switch to using more electricity during an oil price shock (Lemoine 2010). Also, during an oil shock, a wider penetration of PEVs will allow for a short-run reduction in oil use by multi-vehicle households that can drive their PEVs more, rather than using their gasoline-powered vehicles. Flexibility is achieved when drivers have options to shift to electricity, and the responsiveness of oil demand to the oil price (i.e., the elasticity of demand for oil) increases. These benefits occur because there is more substitutability between electricity and oil in end-use fuel use. With electricity supply disruptions, on the other hand, multi-vehicle households could also switch to driving their gasoline-powered vehicles more. Households with only one vehicle, dedicated to gasoline or electricity, are likely to be the most affected by volatile oil prices and electricity outages, since they cannot substitute among vehicles or fuels in response to changing oil prices and the availability of electricity, as multi-vehicle households or owners of PHEVs can.

#### **10.2.3.4 Energy Independence**

The goal of U.S. energy independence is generally equated with the elimination of all U.S. imports of petroleum and other foreign sources of energy, but more broadly, it is the elimination of U.S. sensitivity to the variations in the price and supply of foreign sources of energy (Greene 2010). (Grove 2008) and (Stein 2013) promote the idea that the wider use of PEVs can bring about U.S. energy independence by substituting electricity for oil to power vehicles in the U.S. As Grove/Stein note, the physical characteristics of oil and electricity can have very different consequences for energy independence. Oil is a commodity that is globally traded. In comparison, Grove labels electricity as “sticky”: in other words, “it stays in the continent where it is produced.” As a result, global electricity markets are not nearly as linked or interconnected as global oil markets. The interconnectedness of the oil market means that price shocks are transmitted globally, but it also contributes to its resilience. Oil tankers can be redirected to those destinations where price signals reveal that their value is highest. In contrast, the volume of electricity that can be rerouted across regions in response to an emergency is strictly limited by the number and configuration of electricity transmission interconnections.

The wider use of PEVs in U.S. light-duty and medium-duty vehicles will likely result in the substitution of one fuel, oil, with significant imports and which is subject to global price shocks, for another fuel, electricity, which is almost exclusively produced in the U.S. and has different and an independent set of local and regional factors influencing its reliability and resiliency. As (Bordoff and O’Sullivan 2022) point out, electricity is much more likely to be produced locally

and regionally; less than three percent of global electricity was traded across international borders in 2018, compared with two-thirds of global oil supplies in 2014. As a result, the greater use of electricity as transportation fuel will move the U.S. toward the goal of energy independence.

U.S. energy security analysis has traditionally focused on the benefits of the reduction of U.S. oil imports. However, even when oil imports get close to zero, energy security concerns remain for oil because of the global, integrated nature of the oil market. Unless the U.S. entirely disengages from international oil trade, oil price shocks starting anywhere in the world will continue to be transmitted to oil prices in the U.S. and those price shocks will continue to have adverse impacts on U.S. households. An increased movement toward electrification does not eliminate energy security concerns, but it does reduce vulnerability to them. Supply shocks for electricity also happen, but they are typically of a different nature than oil shocks: they are local or regional instead of global, and they may involve a combination of electricity outages and/or retail electricity price increases.

Recent geopolitical events are an example of how the energy price and energy price stability attributes in U.S. energy security remain an important concern even after the U.S. has become a net exporter of crude oil and petroleum products. (Bordoff and O’Sullivan 2022) suggest that energy security will join climate change as a top concern for policymakers as a result of the Russian-Ukrainian war, which has disrupted energy supplies and increased global energy prices. They argue that these dual priorities – energy security and climate change – are poised to reshape national energy planning, energy trade flows, and the broader global economy. One consequence of the Russian-Ukrainian War, according to Bordoff and O’Sullivan, is that countries across the world will increasingly be looking inward, prioritizing domestic energy production and regional cooperation even as they transition to net-zero carbon emissions. These changes will likely be defined by greater, not less, government intervention in the world’s energy sector.

### **10.3 Electricity Security Impacts**

Addressing the issue of U.S. energy security, this section offers comparisons of electricity and gasoline as transportation fuels in terms of cost per mile driven and their relative price stability and volatility. In the U.S. during the past decade, the cost per mile driven for a new PEV charging at home has been consistently lower than that for a new gasoline-powered vehicle using regular gasoline. This result is robust to the spatial variation in relative electricity and gasoline prices in different U.S. states. The impact of fuel costs on consumers is not only about average fuel cost levels but also fuel cost stability. On the metric of fuel cost stability, retail electricity also has fared better than gasoline because retail electricity prices have been more predictable and less volatile for vehicle owners than gasoline prices. The predictability is partly a result of the electricity rate setting process – most consumers pay a set tariff (i.e., electricity price) that only changes at monthly or annual intervals. The section also presents data to support the idea that an increased use of electricity as a transportation fuel in U.S. LMDVs moves the U.S. toward greater energy independence.

### **10.3.1 Recent Fuel Costs for Gasoline-Powered Vehicles Compared to PEVs in the U.S.**

#### **10.3.1.1 National (i.e., U.S.) Analysis**

To compare fuel costs of PEVs versus gasoline-powered vehicles, the relevant units are dollars per mile instead of dollars per gallon of gasoline equivalent (or other energy content unit) because of the higher end-use efficiency of the electric motor relative to the internal combustion engine (ICE). This is a central feature of the comparison between PEVs and gasoline-powered vehicles. The relative cost of gasoline and electric fuel in the U.S. will depend on three main factors: the efficiency of the vehicle; the prevailing prices of gasoline and electricity (electricity prices being more stable over time), and the market and charger location in which the PEV is recharged (electricity costs tend to vary significantly across states to a greater degree than gasoline prices, and commercial recharging costs are higher than residential charging costs).

Most PEV charging to date in the U.S. uses at-home chargers, and thus EPA's analysis of fuel costs hinges on prices observed by U.S. households: retail, regular gasoline prices (in dollars per gallon) and retail residential electricity rates (in cents per kilowatt-hour). As PEV adoption extends to drivers without at-home charging capabilities in the future, commercial charging rates will play a larger role in a national analysis of PEV fuel costs, but home recharging is expected to continue to play a dominant role.

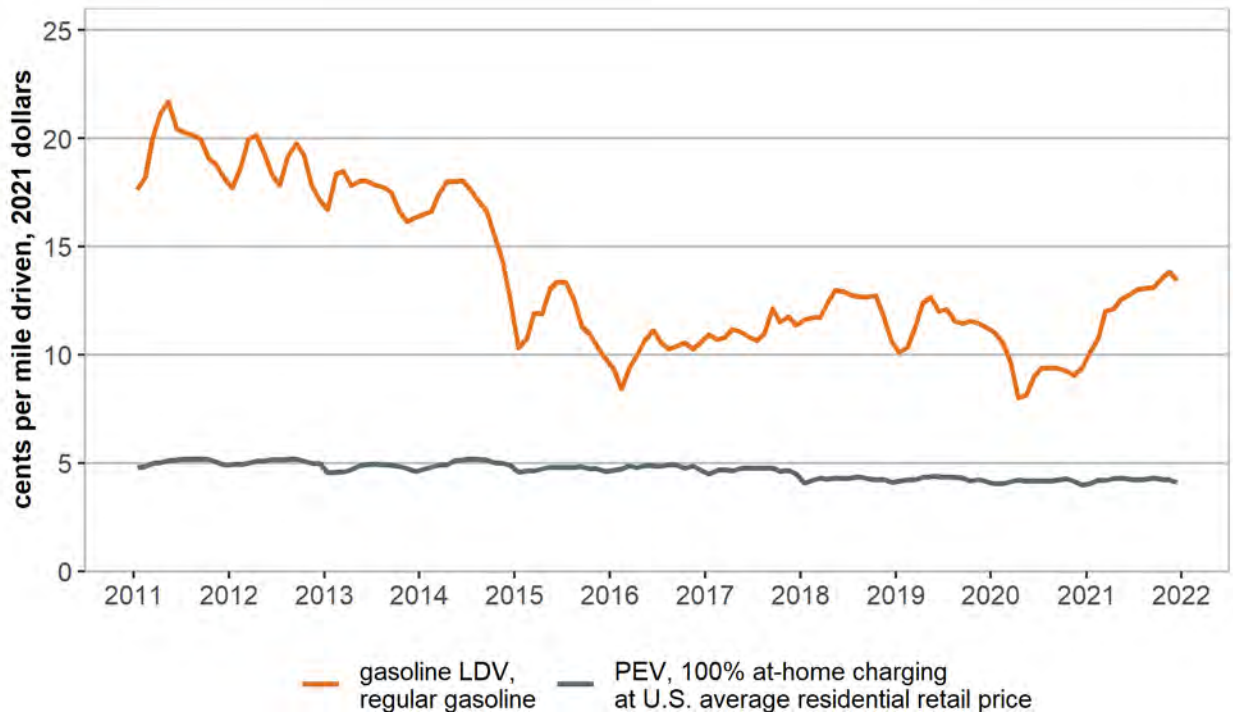
Comparing fuel costs for PEVs and gasoline-powered light-duty vehicles requires converting retail prices into a common unit (U.S. cents per mile driven) that accounts for the differences in energy content between gasoline and electricity as well as the higher efficiency of electric drivetrains relative to internal combustion engines, expressed as fuel economies (miles per gallon of gasoline equivalent (gge)).<sup>266</sup> The fuel economy data used to compute fuel costs per mile driven are on-road new vehicle values by model year (i.e., the average fuel economy across all sold new gasoline-powered light-duty vehicles or PEVs of a same model year). The data for PEVs includes only battery electric vehicles (BEVs), but also applies to plug-in hybrid electric vehicles (PHEVs) for the miles driven in electric vehicle mode, and the data for gasoline vehicles includes conventional hybrids.<sup>267</sup> On-road fuel economy increased from 22.2 miles per gge in 2011 to 24.6 miles per gge in 2021 for new gasoline-powered light-duty vehicles and from 97 miles per gge to 112.8 miles per gge for new PEVs.

Figure 10-2 shows the average U.S. fuel cost per mile driven for two vehicle-fuel combinations, gasoline-powered light-duty vehicles using regular gasoline and PEVs charging at-home at the residential retail rate, and Figure 10-3 presents the same information for a subset of individual states in the U.S.

---

<sup>266</sup> The conversion factor from kilowatt-hours to gasoline gallon equivalents (gge) is 33.705 kWh/gge (<https://www3.epa.gov/otaq/gvg/learn-more-technology.htm>).

<sup>267</sup> It should be noted that the time unit for the fuel economy data, the “model year”, does not coincide exactly with a calendar year.



**Figure 10-2: Average U.S. fuel cost per vehicle mile driven of gasoline-powered vehicles and PEVs from 2011 to 2021 Sources: Electricity prices: (U.S. EIA 2022); Gasoline prices: (U.S. EIA 2022); Fuel economies: (U.S. EPA 2022).**

Monthly fuel cost per mile driven has been consistently and substantially lower for new PEVs than new gasoline-powered light-duty vehicles. The average fuel cost per mile driven from January 2011 to December 2021 was 13.7 cents per mile for new gasoline vehicles using regular gasoline and 4.6 cents per mile for a new PEV charged at-home 100 percent of the time at the average residential retail rate. The average annual fuel savings of new PEVs in comparison to a new gasoline vehicle using regular gasoline over the ten-year timeframe of 2011 to 2021 was \$1,260. We recognize that, to date, the bulk of PEVs sold tend to be in the small or mid-size car segments and, thus, more energy efficient. This is evolving as more PEV models are offered. For Model Year 2022, an analysis of fuel costs for every light-duty vehicle model shows that most PEV models have lower fuel costs than most gasoline-powered models regardless of vehicle class and size (U.S. DOE 2022).

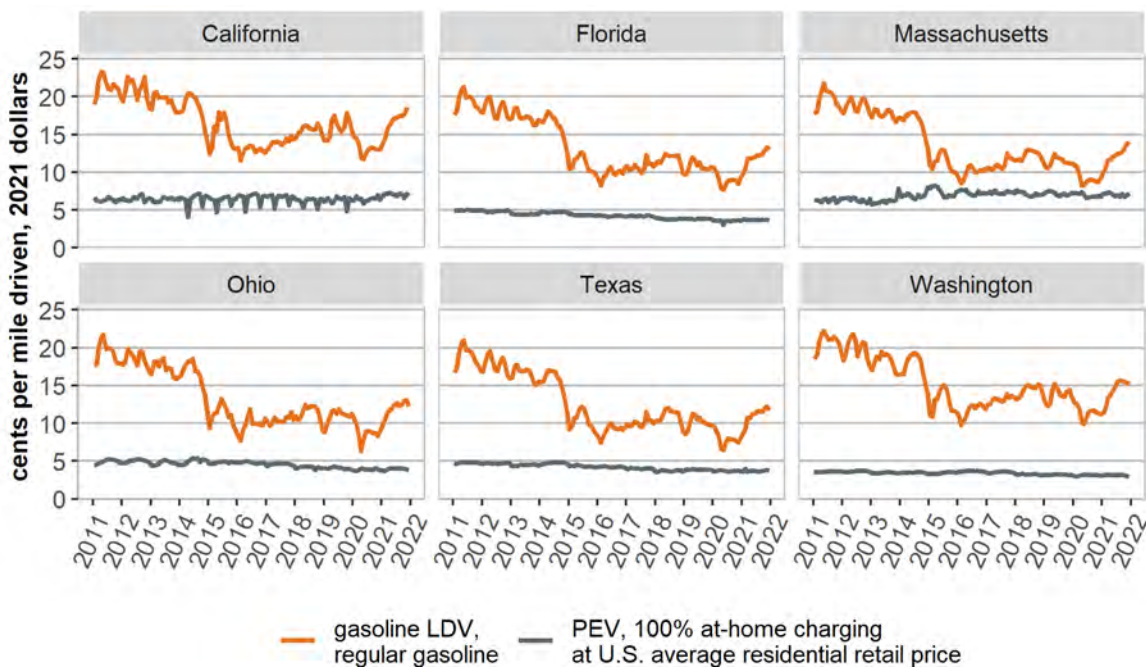
While vehicle size and prevailing oil prices matter, the lower fuel cost per mile driven for PEVs is largely a result of the much higher efficiency of electric drivetrains relative to internal combustion engines. Comparing U.S. electricity and gasoline prices on a dollar per unit-energy basis, residential electricity has actually been more expensive than retail gasoline over the last



decade: the 2011–2021 averages were 2.6 cents per megajoule (MJ) for regular gasoline and 4.0 cents per MJ for residential retail electricity.<sup>268</sup>

### 10.3.1.2 State-Level Analysis

The fuel cost per mile driven for new PEVs was lower than the fuel cost for new gasoline light-duty vehicles in all the states shown in Figure 10-3 (see below) and in every month from 2011 to the end of 2021. However, as stated above, the fuel cost savings do vary significantly across states. The average savings in fuel cost per mile driven for a new PEV versus a new gasoline vehicle ranged from 6.7 cents in Massachusetts to 10.2 cents in California and 11.9 cents in Washington. For the other three states depicted in Figure 10-3, Texas, Ohio and Florida, the fuel savings averaged 8–9 cents per mile. Both California and Massachusetts have some of the highest electricity residential retail rates in the U.S. The large savings afforded by PEVs in California result from that state having higher retail gasoline prices than the rest of the states in Figure 10-3. The savings are even larger for Washington because of a combination of high gasoline prices and low electricity rates due to Washington’s relative abundance of hydroelectric power resources (U.S. EIA 2022). Assuming that new gasoline-powered cars and new PEVs are both driven ~14,000 miles per year, the annual average fuel cost savings in the first year of vehicle operation during this period would have ranged from \$933 in Massachusetts to \$1,643 in Washington (Davis and Boundy 2022). While vehicle use typically declines with age, the decline is slow, and 15 years later the average car would still provide 62 percent of these annual savings (Davis and Boundy 2022).



<sup>268</sup> 1 kWh equals 3.6 MJ, and a typical gallon of gasoline contains 120,280 Btu or 126.8 MJ.

**Figure 10-3: Fuel cost per mile driven by gasoline-powered vehicles and PEVs for six states from 2011 to 2021 Sources: Electricity prices: (U.S. EIA 2022); Gasoline prices: (U.S. EIA 2022); Fuel economies: (U.S. EPA 2022).**

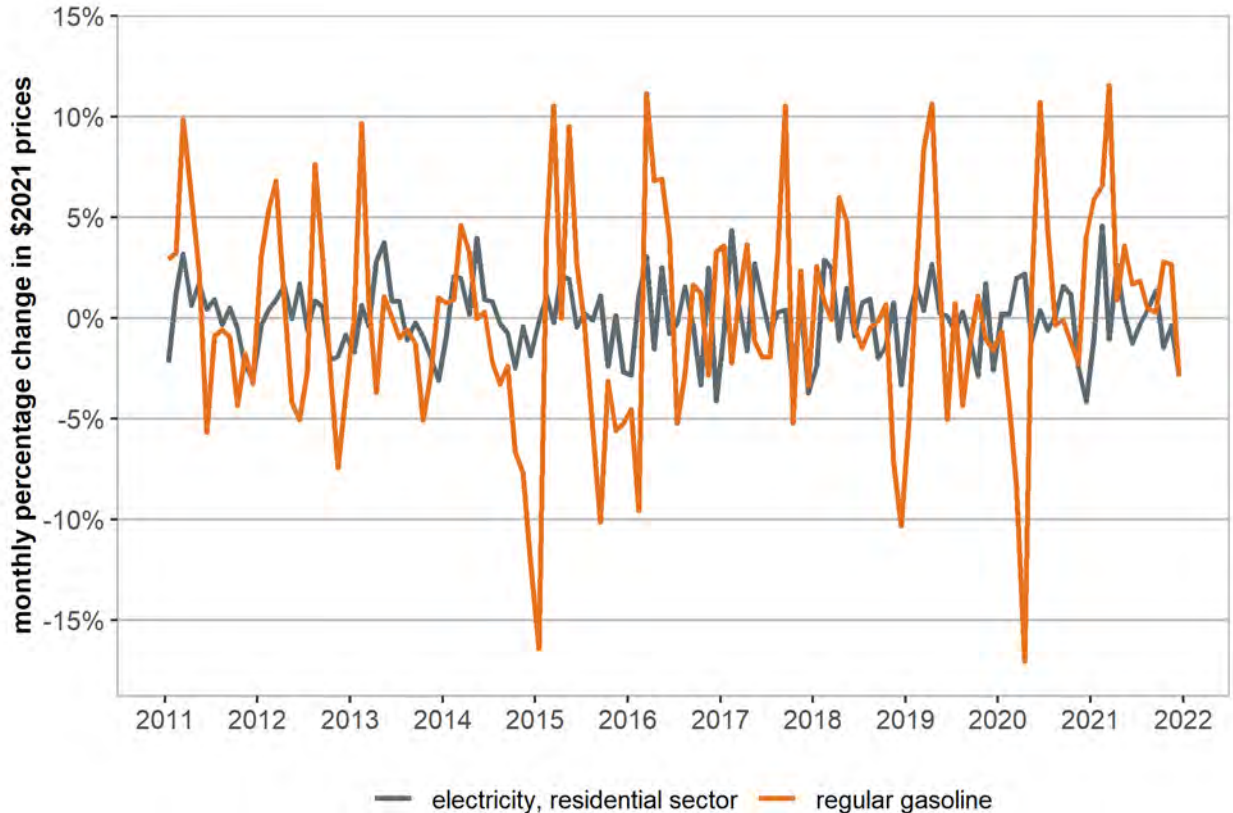
### **10.3.2 Fuel Price Stability/Volatility**

Absolute differences in fuel costs between PEVs and ICE vehicles, discussed above, are an important aspect of the "affordability" component of IEA's definition of energy security, but fuel price stability is another important consideration from the consumer's perspective.<sup>269</sup> While U.S. retail electricity prices vary widely with location, charging equipment, and charging behavior, they are generally more stable over time than U.S. gasoline prices. Figure 10-4 displays the monthly percentage price changes for U.S. retail gasoline and residential electricity. The monthly change in U.S. average residential electricity prices was less than 5 percent (in absolute value) in every month during the 2011–2021 period. For regular gasoline, prices changed up or down by more than 5 percent in 30 percent of months over that period. The volatility of monthly U.S. retail prices from January 2011 to December 2021 was 21 percent for residential electricity prices and 60 percent for regular gasoline prices.<sup>270</sup>

---

<sup>269</sup> The International Energy Agency (IEA) defines energy security as the uninterrupted availability of energy sources at affordable prices. (IEA 2019).

<sup>270</sup> Volatility is calculated as the standard deviation of the monthly price returns multiplied by the square root of the number of periods (months).



**Figure 10-4: Monthly percentage changes in U.S. retail electricity and gasoline prices from 2011 to 2021 Source: (U.S. EIA 2022).**

Another desirable attribute of PEVs for fuel cost stability is that PEVs diversify and thereby help stabilize total road-vehicle fuel costs. Diversification benefits are gained when the prices of the two fuels do not move together. In fact, historically when oil prices increased, electricity prices have tended to decrease, and vice-versa. Looking at fuel price trends over roughly the last decade, from January 2011 to December 2021, monthly U.S. residential electricity prices have been negatively correlated, -0.37, with monthly U.S. average gasoline prices.<sup>271</sup> A negative correlation helps plug-in hybrid electric vehicle (PHEV) owners and multi-vehicle households with access to gasoline light-duty vehicles and PEVs, and the nation as a whole, by diversifying transportation fuel cost risk. During all of the 2011–2021 period, the cost of at-home PEV charging resulted in lower fuel costs than gasoline refilling. The value of a household being able to switch between PEVs and gasoline-powered vehicles depending upon prevailing fuel prices (or between electricity and gasoline for a PHEV), is sometimes labeled the “real option value.” Lemoine (2010) finds that using a real option value framework instead of a discounted cash flow analysis raises the retail price at which the extra battery capacity of a PHEV (relative to a HEV) pays for itself by \$50/kWh (15 percent). The extra value results from the real option value approach accounting for (1) gasoline price uncertainty and (2) the nonlinearity in payoffs that the PHEV fuel flexibility provides – the payoff is either 0 or positive, but never negative. Real option value could increase if the residential electricity costs of PEVs increase, or commercial

<sup>271</sup> The estimated correlation coefficient is a Pearson correlation coefficient with a p-value of 0.0069.

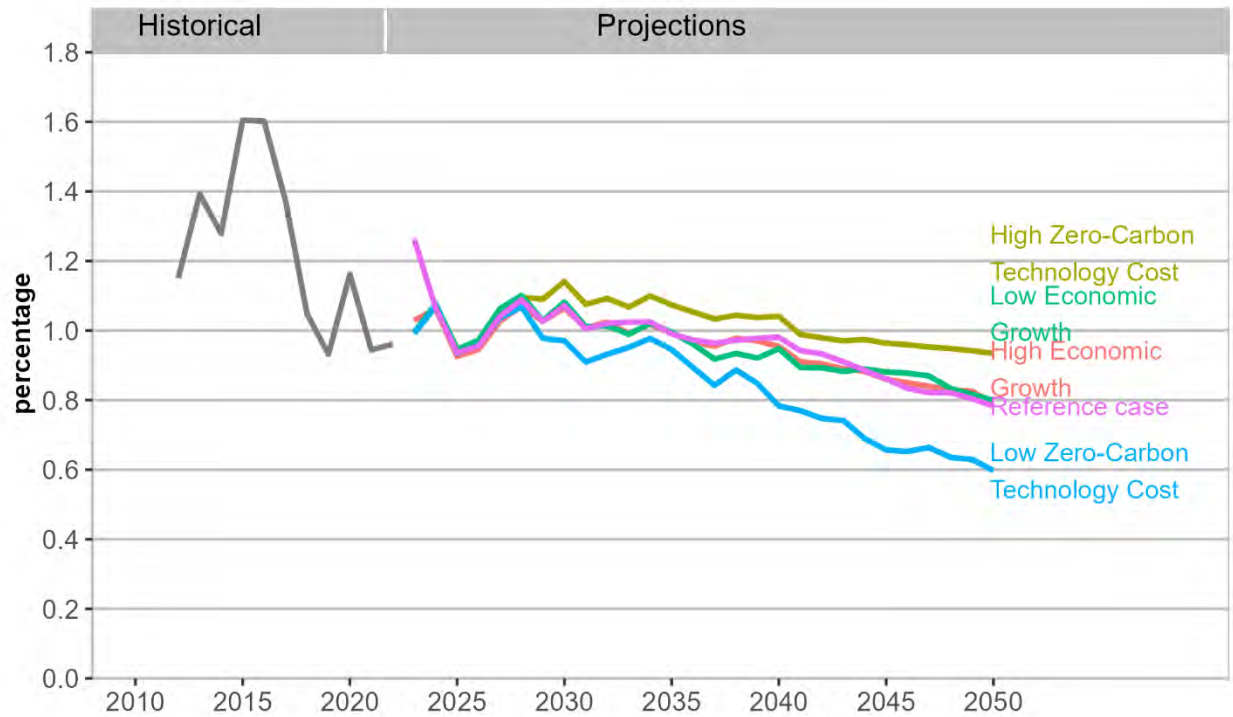
recharging costs decrease, and the relative ranking of home or commercial PEV charging versus gasoline refueling costs changes more frequently in the future as oil prices fluctuate.<sup>272</sup>

### **10.3.3 Energy Independence**

The substitution of electricity for oil for powering U.S. vehicles will reduce U.S. reliance on fuel imports. Although the U.S. has become a net exporter of crude oil and petroleum liquids, it still imports significant volumes of crude oil to meet the preferred barrel specifications of domestic refineries. See Table 10-2 below for estimates of U.S. oil import reductions from this final LMDV GHG (2027–2032) rule. Figure 10-5 shows that the U.S. has been a very small net importer of electricity over the most recent decade: net U.S. imports accounted for an average of only 1.2 percent of total U.S. electricity use from 2011 to 2022. The EIA projects net U.S. imports of electricity to decrease further from that average percentage in the next decades across all the Annual Energy Outlook (AEO) 2023 scenarios. By 2050, the AEO scenarios project net U.S. electricity imports to range from 0.6 percent in the Low Zero-Carbon Technology Cost scenario to 0.9 percent in the High Zero-Carbon Technology Cost scenario.

---

<sup>272</sup> “Real option value” analysis applies the concepts used to value the financial assets called “options” to investments in certain real/physical assets. Unlike traditional discounted cashflow analysis which states that investment in a project/asset should only happen if its expected net present value is greater than zero, real option analysis takes into account the extra value that can be realized when cashflows are uncertain and the asset holder can choose between the different options. In the LMDV case considered here with PEVs and gasoline-powered vehicles, real option value results when households can switch between PEVs and gasoline-powered vehicles when fuel costs fluctuate. Vehicle switching in this case allows households to purchase the least-costly fuel.



**Figure 10-5: U.S. electricity net imports as percentage of total electricity use from 2011 to 2020 and projected U.S. electricity net imports from 2021 to 2050. Source: (U.S. EIA 2023), (U.S. EIA 2023), (U.S. EIA 2023), (U.S. EIA 2023).**

In the past decade, the U.S. has traded electricity with only two countries: Canada and Mexico, both in North America. The U.S. imports more electricity than it exports from both countries. On average, from 2011 to 2020, the volume of electricity imported from Canada was equal to 1.4 percent of U.S. electricity use and the volume exported to Canada was 0.23 percent of U.S. electricity use. Average traded electricity volumes with Mexico were lower; imports from Mexico were equivalent to 0.13 percent of U.S. electricity use and export volumes to Mexico were 0.07 percent of U.S. electricity use. Although net U.S. imports represent a very small fraction of total electricity use at the national level, they can play a larger role in some regional electricity grids in the U.S. For example, ISO-NE – the electricity transmission grid operator in New England – reported that 16 percent of the net energy for load in their system in 2021 originated in Canadian electricity imports (ISO New England 2022).

In addition, EPA's power sector modeling is used to estimate the impacts of this final rule on U.S. electricity markets and also international electricity dispatches. Only Canadian electricity dispatches are estimated as electricity dispatched from Mexico is de minimis. EPA's power sector modeling results show that net U.S. electricity international dispatch is very small as an overall percentage of total U.S. electricity generation. U.S. net electricity exports/imports are less than 0.6 percent for all years by 2050 for both the "no action" and "final rule" case of this final rule. See Tables 5–9 and 5–10 of Chapter 5 of the RIA for more detail on the impacts of this final rule on net U.S. electricity international dispatch impacts.

## 10.4 Oil Security Impacts

### 10.4.1 U.S. Oil Import Reductions

In this section, we compare oil import reductions from this final rule with an assessment of overall U.S. oil market trends. Over the timeframe of analysis of this final rule, 2027–2055, the U.S. Department of Energy’s (DOE) Energy Information Administration’s (EIA) Annual Energy Outlook (AEO) 2023 (Reference Case) projects that the U.S. will be both an exporter and an importer of crude oil<sup>273</sup> (U.S. EIA 2023). The U.S. produces more light crude oil than its refineries can refine. Thus, the U.S. exports lighter crude oil and imports heavier crude oils to satisfy the needs of U.S. refineries, which are configured to efficiently refine heavy crude oil. U.S. crude oil exports are projected to be relatively stable, between 2.9 and 3.4 MMBD, from 2027 through 2050. See Table 10-2 below. U.S. crude oil imports, meanwhile, are projected to range between 6.6 and 7.2 MMBD between 2027 and 2050. The AEO 2023 also projects that U.S. net oil refined product exports will grow from 5.8 MMBD in 2027 to 6.7 MMBD in 2045 before dropping off somewhat to 6.2 MMBD in 2050.

U.S. oil consumption is estimated to have decreased from 19.8 MMBD in 2019 to 17.5 MMBD in 2020 and 19.1 MMBD in 2021 due to social distancing and quarantines that limited personal mobility as a result of the COVID-19 pandemic (U.S. EIA 2022).<sup>274</sup> AEO 2023 projects that U.S. oil consumption will continue to increase from 18.6 MMBD in 2027 to 18.9 MMBD in 2050 (U.S. EIA 2023). It is not just U.S. crude oil imports alone, but both imports and consumption of petroleum from all sources and their role in economic activity, that exposes the U.S. to risk from price shocks in the world oil price. During the 2027–2055 timeframe, the U.S. is projected to continue to consume significant quantities of oil and to rely on significant quantities of crude oil imports. As a result, U.S. oil markets are expected to remain tightly linked to trends in the world crude oil market.

In Chapter 8, EPA estimates changes in U.S. petroleum consumption as a result of this final rule. EPA uses an oil import reduction factor to estimate how changes in U.S. refined product demand from this rule (i.e., changes in U.S. oil consumption) influences U.S. net oil imports (i.e., changes in U.S. oil imports). After carefully reviewing comments on refinery throughput and in consultation with DOE and NHTSA, EPA is updating its assessment of the impact of this final rule on U.S. refinery throughput and, in turn, the air quality impacts from refinery emissions. Instead of estimating that U.S. refineries would largely reduce their production in response to reduced refined product demand from this rule, we are now estimating that U.S. refinery output would decline by half (50 percent) of that reduced demand, while increases in refined product exports (i.e., equivalently a decline in net refined product imports) would account for the other half (50 percent) of that reduced demand. We also look at an additional case where U.S. refinery throughput would be maintained by 80 percent as a result of increases in refined product exports, while 20 percent of the refinery throughput would be reduced. We chose this sensitivity as an assumption that falls between our central case where U.S. refinery

---

<sup>273</sup> The AEO 2023 projects oil market trends through 2050. The timeframe for EPA's analysis of this final rule is from 2027 to 2055. Thus, we report oil market trends to 2050 based upon AEO 2023 in Table 10-2. We report U.S. oil import reductions through 2055 in Table 10-2 as well.

<sup>274</sup> Calculated using EIA's Monthly Energy Review series “Petroleum Consumption (Excluding Biofuels) Annual” (Table 1.3) and “Petroleum Consumption Total Heat Content Annual” (Table A3).

output would be reduced by half (50 percent) and the case where there would be no effect on U.S. refining output (100 percent). See Chapter 8 of the RIA for more discussion of how EPA is updating its refinery throughput assumptions and, in turn, air quality impacts from refinery emissions, as a result of this rule. See Section 21 of the Response to Comment document for EPA’s response to comments on EPA’s update of the oil import reduction factor.

Since EPA’s refinery throughput assumptions are being updated for this final rule, this will influence EPA’s estimate of the oil import reductions and, in turn, the energy security benefits estimated in this analysis. For the DRIA, a summary table was docketed that contained the estimates of the oil import reduction factor. Table 10-1 shows that for a reduction in refined product estimated by AEO’s 2021 Low Economic Growth Case relative to the Reference Case, 83.7 percent of the reduced product demand is attributed to reduced imported crude oil, while 7 percent is attributed to reduced net imported products – resulting in the 90.7 percent oil import reduction factor. Global (i.e., rest of the world) oil demand is not changed in the Low Economic Case compared to the Reference Case, so the comparison between the AEO Reference Case and the Low Economic Growth Case is only in the overall pattern of U.S. oil demand changes.

**Table 10-1: Oil Import Reduction Factor, Average Over Years 2027 to 2050.**

|  | AEO 2021 | AEO 2023 |
|--|----------|----------|
| Percent of imported crude oil              | 83.7     | 84.8     |
| Percent reduction in domestic crude oil    | 9.3      | 10.3     |
| Percent reduction in net imported products | 7.0      | 4.8      |
| Total percentage of imported petroleum     | 90.7     | 89.6     |

For the final rule, the same methodology based on the AEO 2023 would result in an 89.6 percent oil import reduction factor – 84.8 percent of which would be due to reduced imported crude oil and 4.8 percent would be due to reduced net imported products.

Use of the two AEO cases cited above estimates a large reduction in U.S. refinery throughput – AEO 2021 estimates that 93 percent (83.7+9.3) of the reduced product demand would be attributed to reduced throughput at U.S. refineries. Based on AEO 2023, the reduction in U.S. refinery throughput would be 95.1 percent (84.8+10.3).

However, for the final rulemaking, we are estimating that U.S. refineries would not reduce their throughput to the same extent. Instead, for a given reduction in a volume of gasoline and diesel fuel demand, 50 percent of that reduced demand will result in reduced production by U.S. refineries, while for the other 50 percent, refineries will continue to operate and will increase their refined product exports (i.e., reduce their net refined product imports). Thus, we needed a way to estimate the energy security impacts of the final rule, assuming that U.S. refiners will continue producing domestic fuels at a much higher level associated with the 50/50 assumption.

Since we are now estimating that in response to reduced refined product demand, half of that reduced demand will be reduced production from U.S. refineries and, for the other half, refineries will continue to operate and increase their refined product exports, two different methods for estimating the oil import reduction factor are being used. The portion of reduced refinery demand projected to result in reduced refinery throughput can be represented by the oil import reduction factor estimated by the two AEO 2023 cases, 89.6 percent. Conversely, the balance of reduced refinery demand which U.S. refineries keep operating can be represented by

the oil import reduction factor which, by definition, will be 100 percent, since refineries will increase their refined product exports. Thus, the oil import reduction factor is estimated by the following equation:

$$\text{Oil Import Reduction Factor} = 89.6\% \times 0.5 + 100\% \times 0.5 = 94.8\%$$

If the 80/20 percent refinery throughput assumption is utilized, the oil import reduction factor is estimated by the following equation:

$$\text{Oil Import Reduction Factor} = 89.6\% \times 0.2 + 100\% \times 0.8 = 97.9\%$$

Based upon the changes in oil consumption estimated by EPA and the 94.8 percent oil import reduction factor, the reductions in U.S. oil imports as a result of this final rule are estimated in Table 10-2 below for the 2027–2055 timeframe.<sup>275</sup> Included in Table 10-2 are estimates of U.S. crude oil exports and imports, net oil refined product exports, net crude oil and refined petroleum product exports and U.S. oil consumption for the years 2027–2050 based on the AEO 2023 (U.S. EIA 2023).

**Table 10-2: Projected trends in U.S. crude oil exports/imports, net refined oil product exports, net crude oil and refined petroleum product imports, oil consumption and U.S. oil import reductions resulting from the final rule from 2027 to 2055 (MMBD).<sup>a</sup>**

|   | 2027   | 2030 | 2032 | 2035 | 2040 | 2045 | 2050 | 2055 |
|---|--------|------|------|------|------|------|------|------|
| U.S. Crude Oil Exports  | 3.3    | 3.4  | 3.4  | 3.4  | 3.2  | 3.2  | 2.9  | -    |
| U.S. Crude Oil Imports  | 6.9    | 7.0  | 7.1  | 7.1  | 7.2  | 7.1  | 6.6  | -    |
| U.S. Net Refined Petroleum Product Exports <sup>b</sup>             | 5.8    | 6.0  | 6.1  | 6.4  | 6.7  | 6.7  | 6.2  | -    |
| U.S. Net Crude Oil and Petroleum Product Exports                    | 2.3    | 2.4  | 2.5  | 2.8  | 2.8  | 2.9  | 2.7  | -    |
| U.S. Oil Consumption <sup>c</sup>                                   | 18.6   | 18.4 | 18.3 | 18.2 | 18.2 | 18.5 | 18.9 | -    |
| Reduction in U.S. Oil Imports from the Final Standards <sup>d</sup> | 0.0035 | 0.15 | 0.36 | 0.83 | 1.5  | 1.9  | 2.1  | 2.1  |

Table Notes:

a The AEO 2023 Reference Case, Table A11. Values have been rounded off from the AEO 2023, so the totals may not add up to the AEO estimates.

b Calculated from AEO 2023 Table A11 as Net Product Exports minus Ethanol, Biodiesel, Renewable Diesel, and Other Biomass-derived Liquid Net Exports.

c Calculated from AEO 2023 Table A11 as “Total Primary Supply” minus “Biofuels”.

d Oil import reductions differ from estimates in Table 8-40, Impacts on oil consumption and oil imports, Final standards, due to rounding.

#### **10.4.2 Oil Security Premiums Used for this Final Rule**

The total energy security benefits of this final light- and medium-duty vehicle GHG rule are calculated based upon U.S. net oil import reductions multiplied by the oil security premiums estimated for this rule. In the preceding section (Chapter 10.4.1), we presented estimates of U.S.

<sup>275</sup> The AEO 2023 projects oil market trends through 2050. The timeframe for EPA's analysis of this final rule is from 2027 to 2055. Thus, we report oil market trends to 2050 based upon AEO 2023 in Table 10-2. We report U.S. oil import reductions through 2055 in Table 10-2 as well.



oil import reductions from this rule. In the section below, we present estimates of the oil security premiums used for this rule.

In order to understand the energy security implications of reducing U.S. oil imports, EPA has worked with Oak Ridge National Laboratory (ORNL), which has developed approaches for evaluating the social costs and energy security implications of oil use. The energy security estimates provided below are based upon a peer-reviewed methodology developed at ORNL (Leiby 2008). This ORNL study is an updated version of the approach used for estimating the energy security benefits of U.S. oil import reductions developed in a 1997 ORNL report (Leiby, Jones, et al. 1997). This same approach was first used to estimate energy security benefits for the 2010 RFS2 final rule (75 FR 14670) and the 2010 final rulemaking to establish light-duty vehicle greenhouse gas emission standards and corporate average fuel economy standards for MY 2012–2016 vehicles (75 FR 25324). ORNL has updated this methodology regularly for EPA to account for updated projections of future energy market and economic trends reported in the U.S. EIA’s AEO. For this final rule, EPA updated the ORNL methodology using the AEO 2023.

The ORNL methodology is used to compute the oil import premium (concept defined in Chapter 10.1) per barrel of imported oil. The values of U.S. oil import premium components (macroeconomic disruption/adjustment costs and monopsony components) are numerically estimated with a compact model of the oil market by performing simulations of market outcomes using probabilistic distributions for the occurrence of oil supply shocks, calculating marginal changes in economic welfare with respect to changes in U.S. oil import levels in each of the simulations, and summarizing the results from the individual simulations into a mean and 90 percent confidence intervals for the import premium estimates. The macroeconomic disruption/adjustment import cost component is the sum of two parts: the marginal change in expected import costs during disruption events and the marginal change in gross domestic product due to the disruption. The monopsony component is the long-run change in U.S. oil import costs as the level of oil import changes.

For this final rule, EPA is using oil import premiums that incorporate the oil price projections and energy market and economic trends, particularly global regional oil supplies and demands (i.e., the U.S./OPEC/rest of the world), from the AEO 2023 into its model.<sup>276</sup> EPA only considers the avoided macroeconomic disruption/adjustment oil import premiums (i.e., labeled macroeconomic oil security premiums below) as costs, since we consider the monopsony impacts stemming from changes in U.S. oil imports: transfer payments. In previous EPA rules when the U.S. was projected by EIA to be a net importer of crude oil and petroleum-based refined products, monopsony impacts represented reduced payments by U.S. consumers to oil producers outside of the U.S. There was some debate among economists as to whether the U.S.

---

<sup>276</sup> The oil market projection data used for the calculation of the oil import premiums came from AEO 2023, supplemented by the latest EIA international projections from the Annual Energy Outlook (AEO)/International Energy Outlook (IEO) 2021. Global oil prices and all variables describing U.S. supply and disposition of petroleum liquids (domestic supply, tight oil supply fraction, imports, demands) as well as U.S. non-petroleum liquids supply and demand are from AEO 2023. Global and OECD Europe supply/demand projections as well as OPEC oil production share are from IEO 2021. The need to combine AEO 2023 and IEO 2021 data arises due to two reasons: (a) EIA stopped including Table 21 “International Petroleum and Other Liquids Supply, Disposition, and Prices” in the U.S.-focused Annual Energy Outlook after 2019, (b) EIA does not publish complete updates of the IEO every year.

exercise of its monopsony power in oil markets, for example from the implementation of EPA's rules, was a "transfer payment" or a "benefit." Given the redistributive nature of this monopsony impact from a global perspective, and since there are no changes in resource costs when the U.S. exercises its monopsony power, some economists argued that it is a transfer payment. Other economists argued that monopsony impacts were a benefit since they partially address, and partially offset, the market power of OPEC. In previous EPA rules, after weighing both countervailing arguments, EPA concluded that the U.S.'s exercise of its monopsony power was a transfer payment, and not a benefit (U.S. EPA 2016).

In the timeframe covered by this final rule, the U.S.'s oil trade balance is projected to be quite a bit different than during the time periods covered in many previous EPA rules. Starting in 2020, the U.S. became a net exporter of crude oil and refined oil products, and the U.S. is projected to continue to be a net exporter of crude oil and refined petroleum products in the timeframe of analysis covered by the final standards, 2027-2055. As a result, reductions in U.S. oil consumption and, in turn, U.S. oil imports, still lower the world oil price modestly. But the net effect of the lower world oil price is now a decrease in revenue for U.S. exporters of crude oil and refined petroleum products, instead of a decrease in payments to foreign oil producers. The argument that monopsony impacts address the market power of OPEC is no longer appropriate. Thus, we continue to consider the U.S. exercise of monopsony power to be transfer payments. We also do not consider the effect of this final rule on the costs associated with existing energy security policies (e.g., maintaining the Strategic Petroleum Reserve or strategic military deployments), which are discussed below.

In addition, EPA and ORNL have worked together to revise the oil import premiums based upon recent energy security literature. Based upon EPA and ORNL's review of the recent energy security literature, EPA is assessing its macroeconomic oil security premiums for this final rule. The recent economics literature (discussed in Chapter 10.2.1) focuses on three factors that can influence the macroeconomic oil security premiums: the price elasticity of oil demand, the GDP elasticity in response to oil price shocks, and the impacts of the U.S. tight oil boom. We discuss each factor below and provide a rationale for how we are developing estimates for the first two factors for the macroeconomic oil security premiums being used in this final rule. We are not accounting for how U.S. tight oil is influencing the macroeconomic oil security premiums in this final rule, other than how tight oil significantly reduces the need for U.S. oil imports.

First, we assess the price elasticity of demand for oil. In previous EPA light-duty vehicle rulemakings (i.e., Model Year 2012–2016, Model Year 2017–2025), EPA used a short-run elasticity of demand for oil of -0.045 (U.S. EPA/NHTSA 2010) (U.S. EPA/NHTSA 2012). In the most recent EPA rule setting GHG emissions standards for passenger cars and light trucks in model years 2023 through 2026, we used a short-run elasticity of demand for oil of -0.07, an update of previously used elasticities based on the below considerations (U.S. EPA 2021). For this rule, we continue to use the elasticity value of -0.07.

From the RFF study, the "blended" price elasticity of demand for oil is -0.05. The ORNL meta-analysis estimate of this parameter is -0.07. We find the elasticity estimates from what RFF characterizes as the "new literature," -0.175, and from the "new models" that RFF uses, -0.20 to -0.33, somewhat high. We believe it would be surprising if short-run oil demand responsiveness has changed in a dramatic fashion.

The ORNL meta-analysis estimate encompasses the full range of the economics literature on this topic and develops a meta-analysis estimate from the results of many different studies in a structured way, while the RFF study’s “new models” results represent only a small subset of the economics literature’s estimates. We believe using a short-run price elasticity of demand for oil of -0.07 is more appropriate.<sup>277</sup> This increase has the effect of lowering the macroeconomic oil security premium estimates undertaken by ORNL for EPA.

Second, we consider the elasticity of GDP to an oil price shock. In previous EPA vehicle rulemakings (i.e., Model Year 2012–2016, Model Year 2017–2025), EPA used an elasticity of GDP to an oil shock of –0.032 (U.S. EPA/NHTSA 2010) (U.S. EPA/NHTSA 2012). In the most recent EPA rule setting GHG emissions standards for passenger cars and light trucks through model years 2023 through 2026, we used an elasticity of GDP of –0.021, an update of previously used elasticities based on the below considerations (U.S. EPA 2021). For this rule, we continue to use the elasticity value of –0.021.

The RFF “blended” GDP elasticity is –0.028, the RFF’s “new literature” GDP elasticity is –0.018, while the RFF “new models” GDP elasticities range from –0.007 to –0.027. The ORNL meta-analysis GDP elasticity is –0.021. We believe that the ORNL meta-analysis value is representative of the recent literature on this topic since it considers a wider range of recent studies and does so in a structured way. Also, the ORNL meta-analysis estimate is within the range of GDP elasticities of RFF’s “blended” and “new literature” elasticities. For this final rule, EPA is using a GDP elasticity of –0.021, a 34 percent reduction from the GDP elasticity used previously (i.e., the –0.032 value). This GDP elasticity is within the range of RFF’s “new literature” elasticity, –0.018, and the elasticity EPA has used in previous rulemakings, –0.032, but lower than RFF’s “blended” GDP elasticity, –0.028. This decrease has the effect of lowering the macroeconomic oil security premium estimates. For U.S. tight oil, EPA has not made any adjustments to the ORNL model, given the limited tight oil production response to rising world oil prices in the recent 2021–2023 timeframe.<sup>278</sup> Increased tight oil production still results in energy security benefits though, through its impact of reducing U.S. oil imports in the ORNL model.

Table 10-3 below provides estimates of EPA’s macroeconomic oil security premium estimates for 2027–2055. The macroeconomic oil security premiums are relatively steady over the time period of this final rule at \$3.73/barrel (9 cents/gallon) in 2027 and \$3.92/barrel (9 cents/gallon) in 2030, \$4.22/barrel (10 cents per gallon) in 2035, \$4.62/barrel (11 cents per gallon) in 2040, and \$5.22/barrel (12 cents/gallon) in 2050 and 2055 (in 2022 U.S. dollars).

---

<sup>277</sup> EPA and ORNL have worked together to develop an updated estimate of the short-run elasticity of demand for oil for use in the ORNL model.

<sup>278</sup> The short-run oil supply elasticity assumed in the ORNL model is 0.06 and is applied to production from both conventional and tight (i.e., shale) oil wells.

**Table 10-3: Macroeconomic oil security premiums for 2027–2055 for final rule (2022\$/barrel).<sup>a,b</sup>**

| Calendar Year     | Macroeconomic Oil Security Premiums (range) |
|-------------------|---|
| 2027              | \$3.73<br>(\$0.51 - \$7.02)                 |
| 2028              | \$3.78<br>(\$0.51 - \$7.15)                 |
| 2029              | \$3.87<br>(\$0.54 - \$7.31)                 |
| 2030              | \$3.92<br>(\$0.51 - \$7.46)                 |
| 2031              | \$4.00<br>(\$0.55 - \$7.62)                 |
| 2032              | \$4.05<br>(\$0.53 - \$7.77)                 |
| 2033              | \$4.11<br>(\$0.47 - \$7.93)                 |
| 2034              | \$4.16<br>(\$0.44 - \$8.07)                 |
| 2035              | \$4.22<br>(\$0.45 - \$8.20)                 |
| 2036              | \$4.28<br>(\$0.44 - \$8.29)                 |
| 2037              | \$4.35<br>(\$0.47 - \$8.40)                 |
| 2038              | \$4.44<br>(\$0.52 - \$8.55)                 |
| 2039              | \$4.50<br>(\$0.53 - \$8.66)                 |
| 2040              | \$4.62<br>(\$0.65 - \$8.85)                 |
| 2041              | \$4.73<br>(\$0.70 - \$9.04)                 |
| 2042              | \$4.77<br>(\$0.69 - \$9.15)                 |
| 2043              | \$4.82<br>(\$0.67 - \$9.27)                 |
| 2044              | \$4.85<br>(\$0.66 - \$9.35)                 |
| 2045              | \$4.91<br>(\$0.68 - \$9.43)                 |
| 2046              | \$4.98<br>(\$0.71 - \$9.52)                 |
| 2047              | \$5.09<br>(\$0.82 - \$9.68)                 |
| 2048              | \$5.14<br>(\$0.85 - \$9.79)                 |
| 2049              | \$5.16<br>(\$0.82 - \$9.85)                 |
| 2050              | \$5.22<br>(\$0.91 - \$9.89)                 |
| 2051 <sup>b</sup> | \$5.22<br>(\$0.91 - \$9.89)                 |
| 2052 <sup>b</sup> | \$5.22<br>(\$0.91 - \$9.89)                 |
| 2053 <sup>b</sup> | \$5.22<br>(\$0.91 - \$9.89)                 |
| 2054 <sup>b</sup> | \$5.22<br>(\$0.91 - \$9.89)                 |
| 2055 <sup>b</sup> | \$5.22<br>(\$0.91 - \$9.89)                 |

<sup>a</sup> The top values in each cell are mean values. Values in parentheses are 90 percent confidence interval.

<sup>b</sup> The AEO 2023 only provides oil market trend estimates to 2050. We use the same macroeconomic oil security premium for the years from 2050 to 2055 as the value for 2050.

### **10.4.3 Cost of Existing U.S. Oil Security Policies**

An additional often-identified component of the full economic costs of U.S. oil imports is the costs to the U.S. taxpayers of existing U.S. energy security policies. The two primary examples are maintaining the Strategic Petroleum Reserve (SPR) and maintaining a military presence to help secure a stable oil supply from potentially vulnerable regions of the world.

The SPR is the largest stockpile of government-owned emergency crude oil in the world. Established in the aftermath of the 1973/1974 oil embargo, the SPR provides the U.S. with a response option should a disruption in commercial oil supplies threaten the U.S. economy (Energy Policy and Conservation Act 1975). Emergency SPR drawdowns have taken place in 1991 (Operation Desert Storm), 2005 (Hurricane Katrina), 2011 (Libyan Civil War), and 2022 (War in Ukraine) (U.S. DOE 2022). All of these releases have been in coordination with releases of strategic stocks from other International Energy Agency (IEA) member countries. In the first four months of 2022, using the statutory authority under Section 161 of the Energy Policy and Conservation Act, the U.S. President directed the U.S. DOE to conduct two emergency SPR drawdowns in response to ongoing oil supply disruptions. The first drawdown resulted in a sale of 30 million barrels in March 2022 (U.S. DOE 2022). The second drawdown, announced in April, authorized a total release of approximately one MMBD from May to October 2022 (U.S. DOE 2022). In 2023, the DOE sold 26 million barrels of oil between April and June (U.S. DOE 2023). A total of 246.6 million barrels were released from the SPR from January 2022 to July 2023. By the end of July 2023, the SPR stock level was 346.8 million barrels (the lowest level since August 1983). To start replenishing the stock, the SPR office purchased 10.23 million barrels through competitive solicitations conducted between May and November of 2023, for deliveries from August 2023 to February 2024. While the costs for building and maintaining the SPR are more clearly related to U.S. oil use and imports, historically these costs have not varied in response to changes in U.S. oil import levels. Thus, while the effect of the SPR in moderating price shocks is factored into the analysis that EPA is using to estimate the macroeconomic oil security premiums, the cost of maintaining the SPR is excluded.

We have also considered the possibility of quantifying the military benefits components of energy security but have not done so here for several reasons. The literature on the military components of energy security has described four broad categories of oil-related military and national security costs, all of which are hard to quantify. These include possible costs of U.S. military programs to secure oil supplies from unstable regions of the world, the energy security costs associated with the U.S. military's reliance on petroleum to fuel its operations, possible national security costs associated with expanded oil revenues to "rogue states" and relatedly the foreign policy costs of oil insecurity.

Of these categories listed above, the one that is most clearly connected to petroleum use and is, in principle, quantifiable is the first: the cost of military programs to secure oil supplies and stabilize oil supplying regions. There is an ongoing literature on the measurement of this component of energy security, but methodological and measurement issues – attribution and incremental analysis – pose two significant challenges to providing a robust estimate of this component of energy security. The attribution challenge is to determine which military programs and expenditures can properly be attributed to oil supply protection, rather than some other objective. The incremental analysis challenge is to estimate how much the petroleum supply protection costs might vary if U.S. oil use were to be reduced or eliminated. Methods to address

both of these challenges are necessary for estimating the effect on military costs arising from a modest reduction (not elimination) in oil use attributable to this final rule.

Since “military forces are, to a great extent, multipurpose and fungible” across theaters and missions and because the military budget is presented along regional accounts rather than by mission, according to (Crane, et al. 2009), the allocation to particular missions is not always clear. Approaches taken usually either allocate “partial” military costs directly associated with operations in a particular region or allocate a share of total military costs (including some that are indirect in the sense of supporting military activities overall) (Koplow and Martin 1998).

The challenges of attribution and incremental analysis have led some to conclude that the mission of oil supply protection cannot be clearly separated from others, and the military cost component of oil security should be taken as near zero (Moore, Behrens and Blodgett 1997). (Stern 2010), on the other hand, argues that many of the other policy concerns in the Persian Gulf follow from oil, and the reaction to U.S. policies taken to protect oil. Stern presents an estimate of military cost for Persian Gulf force projection, addressing the challenge of cost allocation with an activity-based cost method. He uses information on actual naval force deployments rather than budgets, focusing on the costs of carrier deployment. As a result of this different data set and assumptions regarding allocation, the estimated costs are much higher, roughly 4 to 10 times, than other estimates. Stern also provides some insight on the analysis of incremental effects, by estimating that Persian Gulf force projection costs are relatively strongly correlated to Persian Gulf petroleum export values and volumes. Still, the issue remains of the marginality of these costs with respect to Persian Gulf oil supply levels, the level of U.S. oil imports, or U.S. oil consumption levels.

One study, by (Delucchi and Murphy 2008), seeks to deduct from the cost of Persian Gulf military programs the costs associated with defending U.S. interests other than the objective of providing more stable oil supply and price to the U.S. economy. Excluding an estimate of cost for missions unrelated to oil, and for the protection of oil in the interest of other countries, Delucchi and Murphy estimated military costs for all U.S. domestic oil interests of between \$24–\$74 billion annually. Delucchi and Murphy assume that military costs from U.S. oil import reductions can be scaled proportionally, attempting to address the incremental issue.

Another study, by (Crane, et al. 2009), considers force reductions and cost savings that could be achieved if oil security were no longer a consideration. Taking two approaches and guided by post-Cold War force draw downs and by a top-down look at the current U.S. allocation of defense resources, they concluded that \$75–\$91 billion, or 12–15 percent of the current U.S. defense budget, could be reduced. Finally, an Issue Brief by Securing America’s Future Energy (SAFE) (2018) found a conservative estimate of approximately \$81 billion per year spent by the U.S. military protecting global oil supplies (SAFE 2018). This is approximately 16 percent of the recent U.S. Department of Defense’s budget. Spread out over the 19.8 million barrels of oil consumed daily in the U.S. in 2017, SAFE concludes that the implicit subsidy for all petroleum consumers is approximately \$11.25 per barrel of crude oil, or \$0.28 per gallon. According to SAFE, a more comprehensive estimate suggests the costs could be greater than \$30 per barrel, or over \$0.70 per gallon.

As in the examples above, an incremental analysis can estimate how military costs would vary if the oil security mission is no longer needed, and many studies stop at this point. It is substantially more difficult to estimate how military costs would vary if U.S. oil use or imports

are partially reduced, as is projected to be a consequence of this final rule. Partial reduction of U.S. oil use likely diminishes the magnitude of the security problem, but there is uncertainty that supply protection forces and their costs could be scaled down in proportion, and there remains the associated goal of protecting supply and transit for U.S. allies and other importing countries, if they do not decrease their petroleum use as well. We are unaware of a robust methodology for assessing the effect on military costs of a partial reduction in U.S. oil use. Therefore, we are unable to quantify this effect resulting from the projected reduction in U.S. oil use attributable to this final rule.

#### **10.4.4 Oil Security Benefits of the Final Rule**

Estimates of the total annual oil security benefits of the final standards are based on the ORNL oil import premium methodology with updated oil import premium estimates reflecting the recent energy security literature and using the AEO 2023. Annual per-gallon benefits are applied to the reductions in U.S. crude oil and refined petroleum product imports. We do not consider military cost impacts or the monopsony effect of U.S. crude oil and refined petroleum product import changes on the energy security benefits of this final rule. The energy security benefits of this final rule are presented in Table 9-7 of Chapter 9, Non-emission benefits associated with the final standards. For EPA's assessment of the energy security benefits of a more and a less stringent alternative for this final rule, see Chapter 9 of the RIA.

## Chapter 10 References

- Balke, Nathan S., and Stephen Brown. 2018. "Oil supply shocks and the U.S. economy: An estimated DSGE model." *Energy Policy* 116: 357-372. doi:<https://doi.org/10.1016/j.enpol.2018.02.027>.
- Baumeister, Christiane, and Gert Peersman. 2013. "Time-Varying Effects of Oil Supply Shocks on the US Economy." *American Economic Journal: Macroeconomics* 5 (4): 1-28.
- Baumeister, Christiane, and James D. Hamilton. 2019. "Structural Interpretation of Vector Autoregressions with Incomplete Identification: Revisiting the Role of Oil Supply and Demand Shocks." *American Economic Review* 109 (5): 1873-1910. doi:10.1257/aer.20151569.
- Baumeister, Christiane, Gert Peersman, and Ine Van Robays. 2010. "The Economic Consequences of Oil Shocks: Differences across Countries and Time." *RBA Annual Conference Papers*, Reserve Bank of Australia. Sydney. <https://www.rba.gov.au/publications/conf/2009/baumeister-peersman-vanrobays.html>.
- Bistline, John. 2021. "Variability in Deeply Decarbonized Electricity Systems." *Environmental Science & Technology* 55 (9): 5629-5635. doi:10.1021/acs.est.0c06708.
- Bjørnland, Hilde C., Frode Martin Nordvik, and Maximilian Rohrer. 2020. "Supply flexibility in the shale patch: Evidence from North Dakota." *Journal of Applied Econometrics* 36 (3): 273-292. doi:10.1002/jae.2808.
- Blanchard, Olivier J, and Jordi Galí. 2010. "The Macroeconomic Effects of Oil Price Shocks: Why are the 2000s so different from the 1970s?" In *International Dimensions of Monetary Policy*, 373-421. University of Chicago Press.
- Bohi, Douglas R., and David Montgomery. 1982. "Social Cost of Imported Oil and U.S. Import Policy." *Annual Review of Energy* 7: 37-60. doi:10.1146/annurev.eg.07.110182.000345.
- Bordoff, Jason, and Meghan L O'Sullivan. 2022. "Green Upheaval: The New Geopolitics of Energy." *Foreign Affairs*, January. <https://www.foreignaffairs.com/articles/world/2021-11-30/geopolitics-energy-green-upheaval>.
- . 2022. "The New Energy Order: How Governments Will Transform Energy Markets." *Foreign Affairs*, July. <https://www.foreignaffairs.com/articles/energy/2022-06-07/markets-new-energy-order>.
- Borlaug, Brennan, Shawn Salisbury, Mindy Gerdes, and Matteo Muratori. 2020. "Levelized Cost of Charging Electric Vehicles in the United States." *Joule* 4 (7): 1470-1485. doi:10.1016/j.joule.2020.05.013.
- Bretz, Hanna L, and Deborah Salon. 2018. "Do electric vehicles need subsidies? Ownership costs for conventional, hybrid, and electric vehicles in 14 U.S. cities." *Energy Policy* 120: 238-249. doi:10.1016/j.enpol.2018.05.038.
- Broadman, Harry G. 1986. "The social cost of imported oil," *Energy Policy* 14 (3): 242-252.



Broadman, Harry G, and William H Hogan. 1988. The Numbers Say Yes, The Energy Journal 9 (3): 7-29.

Brown, Stephen P.A. 2018. "New estimates of the security costs of U.S. oil consumption." Energy Policy 113: 171-192. doi:<https://doi.org/10.1016/j.enpol.2017.11.003>.

Cashin, Paul, Kamiar Mohaddes, Maziar Raissi, and Mehdi Raissi. 2014. "The differential effects of oil demand and supply shocks on the global economy." Energy Economics 44: 113-134. doi:<https://doi.org/10.1016/j.eneco.2014.03.014>.

Crane, Keith, Andreas Goldthau, Michael Toman, Thomas Light, Stuart E. Johnson, Alireza Nader, Angela Rabasa, and Harun Dogo. 2009. Imported Oil and U.S. National Security. Rand Corporation.

Crowley, Kevin, and David Wethe. 2021. "Shale Bets on Dividends to Match Supermajors, Revive Sector." Bloomberg, August 2. <https://www.bloomberg.com/news/articles/2021-08-02/shale-heavyweights-shower-investors-with-dividends-on-oil-rally> .

Davis, Stacy C, and Robert G Boundy. 2022. Transportation Energy Data Book Edition 40. ORNL/TM-2022/2376, Oak Ridge National Laboratory, Table 3.14 Annual Mileage for Cars and Light Trucks by Vehicle Age.

Delucchi, Mark A., and James J. Murphy. 2008. "US military expenditures to protect the use of Persian Gulf oil for motor vehicles." Energy Policy (36): 2253-2264. doi:[0.1016/j.enpol.2008.03.006](https://doi.org/10.1016/j.enpol.2008.03.006).

EIA, U.S. 2023. Short-term Energy Outlook. November 7th.

EMF. 1982. World Oil: EMF 6 Summary Report. Stanford, CA: Stanford Energy Modeling Forum.

1975. "Energy Policy and Conservation Act." Public Law No. 94-163. December 22.

Engemann, Kristie M, Kevin L Kliesen, and Michael T Owyang. 2011. "Do Oil Shocks Drive Business Cycles? Some U.S. and International Evidence." Federal Reserve Bank of St. Louis. Working Paper Series. No. 2010-007D. doi:[10.20955/wp.2010.007](https://doi.org/10.20955/wp.2010.007).

Federal Reserve Bank of Dallas. 2022. Dallas Fed Energy Survey: Special Questions. March 9. <https://www.dallasfed.org/research/surveys/des/2022/2201.aspx#tab-questions>.

Feng, Kairui, Ning Lin, Siyuan Xian, and Mikhail V Chester. 2020. "Can we evacuate from hurricanes with electric vehicles?" Transportation Research Part D 86: 102458. doi:[10.1016/j.trd.2020.102458](https://doi.org/10.1016/j.trd.2020.102458).

Ge, Yanbo, Christina Simeone, Andrew Duvall, and Eric Wood. 2021. There's No Place Like Home: Residential Parking, Electrical Access, and Implications for the Future of Electric Vehicle Charging Infrastructure. Technical Report NREL/TP-5400-81065, National Renewable Energy Laboratory. <https://www.nrel.gov/docs/fy22osti/81065.pdf>.

Greene, David L. 2010. "Measuring energy security: Can the United States achieve oil independence?" Energy Policy 38 (4): 1614-1621. doi:[10.1016/j.enpol.2009.01.041](https://doi.org/10.1016/j.enpol.2009.01.041).

- Greene, David L. 2010. "Measuring energy security: Can the United States achieve oil independence?" *Energy Policy* 38 (4): 1614-1621. doi:10.1016/j.enpol.2009.01.041.
- Grove, Andy. 2008. "Our Electric Future." American Enterprise Institute, July 10. <https://www.aei.org/articles/our-electric-future/>.
- Hamilton, James D. 2012. "Oil Prices, Exhaustible Resources, and Economic Growth." In *Handbook of Energy and Climate Change*. [https://econweb.ucsd.edu/~jhamilto/handbook\\_climate.pdf](https://econweb.ucsd.edu/~jhamilto/handbook_climate.pdf).
- Hardman, Scott, Kelly L Fleming, Eesha Khare, and Mahmoud M Ramadan. 2021. "A perspective on equity in the transition to electric vehicles." *MIT Science Policy Review* 2: 46-54. doi:10.38105/spr.e10rdoaup.
- Hogan, William W. 1981. "Import Management and Oil Emergencies." In *Energy and Security*, 261-301. Cambridge: Ballinger Publishing Co.
- IEA. 2019. Energy security. December 2. Accessed 12 2022. <https://www.iea.org/areas-of-work/ensuring-energy-security>.
2022. "Inflation Reduction Act." Public Law No. 117-169. August 16.
- ISO New England. 2022. Resource Mix. <https://www.iso-ne.com/about/key-stats/resource-mix>.
- Jenn, Alan, and Jake Highleyman. 2022. "Distribution grid impacts of electric vehicles: A California case study." *iScience* 25 (1). doi:10.1016/j.isci.2021.103686.
- Kemp, John. 2021. "U.S. Shale Restraint Pushes Oil Prices to Multi-year High." Reuters, June 4. <https://www.reuters.com/business/energy/us-shale-restraint-pushes-oil-prices-multi-year-high-kemp-2021-06-04>.
- Kilian, Lutz. 2009. "Not All Oil Price Shocks Are Alike: Disentangling Demand and Supply Shocks in the Crude Oil Market." *American Economic Review* 99 (3): 1053-1069. <https://www.aeaweb.org/articles?id=10.1257/aer.99.3.1053>.
- Kilian, Lutz, and Daniel P. Murphy. 2014. "The Role of Inventories and Speculative Trading in the Global Market for Crude Oil." *Journal of Applied Econometrics* 29: 454-478. doi:<https://doi.org/10.1002/jae.2322>.
- Kilian, Lutz, and Robert J. Vigfusson. 2014. "The Role of Oil Price Shocks in Causing U.S. Recessions." Center for Financial Studies. Working Paper Series 460.
- Kim, Dong Heon. 2012. "What is an oil shock? Panel data evidence." *Empirical Economics* 43: 121-143. doi:10.1007/s00181-011-0459-y.
- Koplow, Douglas, and Aaron Martin. 1998. *Fueling Global Warming: Federal Subsidies to Oil in the United States*. Washington D.C.: Greenpeace.
- Krupnick, Alan, Richard Morgenstern, Nathan Balke, Stephen P.A. Brown, Ana María Herrera, and Shashank Mohan. 2017. Oil Supply Shocks, US Gross Domestic Product, and the Oil Security Premium. Resources for the Future. <https://www.rff.org/publications/reports/oil-supply-shocks-us-gross-domestic-product-and-the-oil-security-premium/>.

- Leiby, Paul N. 2008. Estimating the Energy Security Benefits of Reduced U.S. Oil Imports. ORNL/TM-2007/028, Oak Ridge National Laboratory.
- Leiby, Paul N, Donald W Jones, T Randall Curlee, and Russell Lee. 1997. Oil Imports: An Assessment of Benefits and Costs. Oak Ridge, Tennessee: Oak Ridge National Laboratory.
- Lemoine, Derek. 2010. "Valuing Plug-In Hybrid Electric Vehicles' Battery Capacity Using a Real Options Framework." *Energy Journal*. doi:10.2139/ssrn.1322164.
- Liu, Zhe, Juhyun Song, Joseph Kubal, Naresh Susarla, Kevin W Knehr, Ehsan Islam, Paul Nelson, and Shabbir Ahmed. 2021. "Comparing total cost of ownership of battery electric vehicles and internal combustion engine vehicles." *Energy Policy* 158: 112564–112577. doi:10.1016/j.enpol.2021.112564.
- Lutsey, Nic, and Michael Nicholas. 2019. Update on electric vehicle costs in the United States through 2030. Working Paper 2019-06, ICCT. <https://theicct.org/publication/update-on-electric-vehicle-costs-in-the-united-states-through-2030/>.
- McLean, Bethany. 2018. "The Next Financial Crisis Lurks Underground." *The New York Times*, September 1. <https://www.nytimes.com/2018/09/01/opinion/the-next-financial-crisis-lurks-underground.html>.
- Melodia, Lauren, and Kristina Karlsson. 2022. Energy Price Stability: The Peril of Fossil Fuels and the Promise of Renewables. Issue Brief, Roosevelt Institute. <https://rooseveltinstitute.org/publications/energy-price-stability/>.
- Michalek, Jeremy J, Mikhail Chester, Paulina Jaramillo, Constantine Samaras, Ching-Shin Norman Shiau, and Lester B Lave. 2011. "Valuation of plug-in vehicle life-cycle air emissions and oil displacement benefits." *Proceedings of the National Academy of Sciences* 108 (40): 16554-16558. doi:10.1073/pnas.1104473108.
- Moore, John L, Carl E Behrens, and John E Blodgett. 1997. Oil Imports: An Overview and Update of Economic and Security Effects. CRS Report 98-1, Congressional Research Service: Environment and Natural Resources Policy Division.
- Muratori, Matteo. 2018. "Impact of uncoordinated plug-in electric vehicle charging on residential power demand." *Nature Energy* 3: 193-201. doi:10.1038/s41560-017-0074-z.
- National Research Council. 2010. Hidden Costs of Energy: Unpriced Consequences of Energy Production and Use. Washington DC: National Academies Press.
- Newell, Richard G., and Brian C. Prest. 2019. "The Unconventional Oil Supply Boom: Aggregate Price Response from Microdata." *The Energy Journal* 40 (3). doi:10.5547/01956574.40.3.rnew.
- Nordhaus, William D. 2007. "Who's Afraid of a Big Bad Oil Shock?" *Brookings Papers on Economic Activity* 2007 (2): 219-238. doi:10.1353/eca.2008.0013.
- Oladosu, Gbadebo A., Paul N. Leiby, David C. Bowman, Rocio Uría-Martínez, and Megan Johnson. 2018. "Impacts of oil price shocks on the United States economy: A meta-analysis of the oil price elasticity of GDP for net oil-importing economies." *Energy Policy* 115 (Virtual

Special Issue entitled 'Oil Supply Disruptions, U.S. Economic Activity and Oil Security'): 523-544. 10.1016/j.enpol.2018.01.032.

Parry, Ian W. H., and Joel Darmstadter. 2003. *The Cost of U.S. Oil Dependency*. Washington, D.C.: Resources for the Future.

Plummer, James L, Hung-Po Chao, Dermot Gately, and Richard J Gilbert. 1982. "Basic Concepts, Assumptions, and Numerical Results." In *Energy Vulnerability*, 13-36. Cambridge: Ballinger Publishing Co.

Powell, Siobhan, Gustavo Cezar, Liang Min, Ines Azevedo, and Ram Rajagopal. 2022. "Charging infrastructure access and operation to reduce the grid impacts of deep electric vehicle adoption." *Natural Energy* 1-14. doi:0.1038/s41560-022-01105-7.

Ramey, Valerie A, and Daniel J Vine. 2010. "Oil, Automobiles, and the U.S. Economy: How Much Have Things Really Changed?" *NBER Macroeconomics Annual* 25 (1): 333-368. doi:10.1086/657541.

Rasmussen, Tobias, and Agustin Roitman. 2011. "Oil Shocks in a Global Perspective: Are They Really that Bad?" *IMF Working Papers* (11/194). [https://papers.ssrn.com/sol3/papers.cfm?abstract\\_id=1910497](https://papers.ssrn.com/sol3/papers.cfm?abstract_id=1910497).

SAFE. 2018. *The Military Cost of Defending the Global Oil Supply*. Issue Brief, *Securing America's Energy Future*. <http://secureenergy.org/wp-content/uploads/2020/03/Military-Cost-of-Defending-the-Global-Oil-Supply.-Sep.-18.-2018.pdf>.

Sieren-Smith, Bridget, Ankit Jain, Alireza Eshraghi, Simon Hurd, Julia Ende, Josh Huneycutt, Andrew Ngo, Mark LeBel, Carl Linvill, and David Roland-Holst. 2021. *Utility Costs and Affordability of the Grid of the Future. An Evaluation of Electric Costs, Rates and Equity Issues*. California Public Utilities Commission.

Slowik, Peter, Aaron Isenstadt, Logan Pierce, and Stephanie Searle. 2022. *Assessment of Light-duty Electric Vehicle Costs and Consumer Benefits in the United States in the 2022-2035 Time Frame*. White Paper, ICCT. <https://theicct.org/publication/ev-cost-benefits-2035-oct22/>.

Stein, Fred. 2013. "Ending America's Energy Insecurity: Why Electric Vehicles Should Drive the United States to Energy Independence." *Homeland Security Affairs* 4. <https://www.hsaj.org/articles/236>.

Stern, Roger J. 2010. "United States cost of military force projection in the Persian Gulf, 1976–2007." *Energy Policy* 38: 2816-2825. doi:10.1016/j.enpol.2010.01.013.

Trinko, David, Emily Porter, Jamie Dunckley, Thomas Bradley, and Timothy Coburn. 2021. "Combining Ad Hoc Text Mining and Descriptive Analytics to Investigate Public EV Charging Prices in the United States." *Energies* 14 (17). doi:10.3390/en14175240.

U.S. DOE. 2022. *Demand Response and Time-Variable Pricing Programs*. Accessed September 5, 2022. <https://www.energy.gov/eere/femp/demand-response-and-time-variable-pricing-programs>.

—. 2022. DOE Announces Emergency Notice of Sale of Crude Oil from the Strategic Petroleum Reserve to Address Oil Supply Disruptions. March 2. <https://www.energy.gov/fecm/articles/doe-announces-emergency-notice-sale-crude-oil-strategic-petroleum-reserve-address-oil>.

—. 2022. DOE Announces Second Emergency Notice of Sale of Crude Oil From The Strategic Petroleum Reserve to Address Putin’s Energy Price Hike. April 1. <https://www.energy.gov/articles/doe-announces-second-emergency-notice-sale-crude-oil-strategic-petroleum-reserve-address>.

—. 2023. DOE Issues Notice of Congressionally Mandated Sale to Purchase Crude Oil from the Strategic Petroleum Reserve. February 13.

—. 2022. FOTW #1251, August 15, 2022: Electric Vehicles Have the Lowest Annual Fuel Cost of All Light-Duty Vehicles. August 15. <https://www.energy.gov/eere/vehicles/articles/fotw-1251-august-15-2022-electric-vehicles-have-lowest-annual-fuel-cost-all>.

U.S. DOE. 2017. "Valuation of Energy Security for the United States. Report to Congress." Washington, DC.

U.S. EIA. 2019. Saudi Arabia crude oil production outage affects global crude oil and gasoline prices. September 23. Accessed 12 2022. <https://www.eia.gov/todayinenergy/detail.php?id=41413>.

—. 2023. "Annual Energy Outlook 2021. Table A11: Petroleum and Other Liquids Supply and Disposition (Reference Case)."

—. 2023. "Annual Energy Outlook 2023. Table 8: Electricity Supply, Disposition, Prices, and Emissions."

—. 2023. "Annual Energy Outlook 2023. Table A11: Petroleum and Other Liquids Supply and Disposition (Reference Case)."

—. 2023. "Annual Energy Outlook 2023: Table 10: Electricity Trade."

—. 2023. "Electric Power Annual 2022. Table 1.3: Supply and disposition of electricity."

—. 2023. "Electric Power Annual 2022. Table 2.14: Electricity Supply and Disposition."

U.S. EIA. 2022. Monthly Energy Review. <https://www.eia.gov/totalenergy/data/monthly/>.

—. 2022. "Monthly Energy Review, December 2022. Table 3.1. Petroleum Overview."

—. 2022. Oil and petroleum products explained. November 02. Accessed 12 06, 2022. <https://www.eia.gov/energyexplained/oil-and-petroleum-products/imports-and-exports.php>.

U.S. EIA. 2023. Petroleum and Other Liquids: Crude Oil Production.

U.S. EIA. 2023. Petroleum and Other Liquids: Spot Prices. [https://www.eia.gov/dnav/pet/pet\\_pri\\_spt\\_s1\\_d.htm](https://www.eia.gov/dnav/pet/pet_pri_spt_s1_d.htm).

U.S. EIA. 2022. Petroleum and Other Liquids: Weekly Retail Gasoline and Diesel Prices. [https://www.eia.gov/dnav/pet/PET\\_PRI\\_GND\\_DCUS\\_NUS\\_W.htm](https://www.eia.gov/dnav/pet/PET_PRI_GND_DCUS_NUS_W.htm).

U.S. EIA. 2022. Residential electricity sales and average prices. Electricity sales to ultimate customers. <https://www.eia.gov/opendata/browser/electricity/retail-sales>.

U.S. EIA. 2022. "Today in Energy. Crude oil prices increased in first-half of 2022 and declined in second half of 2022."

—. 2021. U.S. electricity customers experienced eight hours of power interruptions in 2020. November 10. Accessed December 2022. <https://www.eia.gov/todayinenergy/detail.php?id=50316>.

—. 2022. U.S. STATES: State Profiles and Energy Estimates. <https://www.eia.gov/state/>.

U.S. EIA. 2023. U.S. Tight Oil Production by Play. Accessed 12 14, 2022. <https://www.eia.gov/energyexplained/oil-and-petroleum-products/data/US-tight-oil-production.xlsx>.

U.S. EPA. 2016. "Draft Technical Assessment Report: Midterm Evaluation of Light-Duty Vehicle Greenhouse Gas Emission Standards and Corporate Average Fuel Economy Standards for Model Years 2022-2025. EPA-420-D-16-900."

U.S. EPA. 2021. "Revised 2023 and Later Model Year Light Duty Vehicle GHG Emissions Standards, Regulatory Impact Analysis." EPA-420-R-21-028.

U.S. EPA. 2022. "The 2022 EPA Automotive Trends Report: Greenhouse Gas Emissions, Fuel Economy, and Technology since 1975." Office of Transportation and Air Quality. EPA-420-R-22-029.

U.S. EPA/NHTSA. 2010. "Joint Technical Support Document Final Rulemaking to Establish Light-Duty Vehicle Greenhouse Gas Emission Standards and Corporate Average Fuel Economy Standards for Model Year 2012–2016 Vehicles." EPA-420-R-10-901.

U.S. EPA/NHTSA. 2012. "Joint Technical Support Document Final Rulemaking to Establish Light-Duty Vehicle Greenhouse Gas Emissions and Corporate Average Fuel Economy Standards for Model Year 2017–2025 Vehicles." EPA-420-R-12-901.

U.S. GAO. 2020. Effects of the Repeal of the Crude Oil Export Ban. Report to Congress, United States Government Accountability Office. <https://www.gao.gov/assets/gao-21-118.pdf>.

Union of Concerned Scientists. 2015. "What is Tight Oil?" <https://www.ucsusa.org/resources/what-tight-oil>.

Uría-Martínez, Rocío, Paul N. Leiby, Gbadebo Oladosu, David C. Bowman, and Megan M. Johnson. 2018. Using Meta-Analysis to Estimate World Crude Oil Demand Elasticity. Oak Ridge National Laboratory. <https://info.ornl.gov/sites/publications/Files/Pub120229.pdf>.

Walls, W.D., and Xiaoli Zheng. 2022. "Fracking and Structural Shifts in Oil Supply." *The Energy Journal* 43 (3). doi:10.5547/01956574.43.3.wwal.

Yilmaz, Murat, and Philip Krein. 2013. "Review of the Impact of Vehicle-to-Grid Technologies on Distribution Systems and Utility Interfaces." *IEEE Transactions on Power Electronics* 28 (12): 5673-5689. doi:10.1109/TPEL.2012.2227500.

Zamuda, Craig D, Daniel E Bilello, Guenter Conzelmann, Ellen Mccray, Ann Satsangi, Vincent Tidwell, and Brian J Walker. 2018. Energy Supply, Delivery, and Demand. Vol. II, in Impacts, Risks, and Adaptation in the United States: Fourth National Climate Assessment, 174-201. doi:10.7930/NCA4.2018.CH4.

## Chapter 11: Small Business Flexibilities

The Regulatory Flexibility Act, as amended by the Small Business Regulatory Enforcement Fairness Act of 1996 (SBREFA), generally requires an agency to prepare a regulatory flexibility analysis of any rule subject to notice-and-comment rulemaking requirements under the Administrative Procedure Act or any other statute. As a part of this analysis, an agency is directed to convene a Small Business Advocacy Review Panel (SBAR Panel or ‘the Panel’), unless the agency certifies that the rule will not have a significant economic impact on a substantial number of small entities. During such a Panel process, the agency would gather information and recommendations from Small Entity Representatives (SERs) on how to reduce the impact of the rule on small entities. As discussed below, EPA is certifying that this rule will not have a significant economic impact on a substantial number of small entities, and thus we have not conducted an SBAR Panel for this rulemaking. The following discussion provides an overview of small entities in the vehicle market. Small entities include small businesses, small organizations, and small governmental jurisdictions. For the purposes of assessing the impacts of the rule on small entities, a small entity is defined as: (1) a small business that meets the definition for business based on the Small Business Administration’s (SBA) size standards (13 CFR 121.201 2023), (2) a small governmental jurisdiction that is a government of a city, county, town, school district or special district with a population of less than 50,000; and (3) a small organization that is any not-for-profit enterprise which is independently owned and operated and is not dominant in its field.

There are three types of small entities that could potentially be impacted by the GHG standards: 1) small entity vehicle manufacturers; 2) alternative fuel converters, which are companies that take a vehicle for which an OEM has already accounted for GHG compliance and convert it to operate on a cleaner fuel such as natural gas or propane; and 3) independent commercial importers (ICIs), which are firms that import vehicles from other countries for individual vehicle purchasers.

EPA is certifying that this rule will have no significant economic impact on a substantial number of small entities (No SISNOSE). EPA has focused its assessment of potential small business impacts on three key aspects of the standards, including GHG emissions standards, criteria pollutants (NMOG+NO<sub>x</sub> fleet-average standards and PM emissions standards), and electric vehicle battery warranty and durability.

Under the current light-duty GHG program, small entities are exempt from the GHG standards. EPA is continuing the current exemption for all three types of small entities, including small entity manufacturers, alternate fuel converters, and independent commercial importers (ICIs). However, EPA is finalizing, as proposed, some environmental protections for imported vehicles, as described below. EPA is also continuing the current provision allowing small entity manufacturers to opt into the GHG program to earn credits to sell in the credit market. The only small entity vehicle manufacturers in the market at this time produce only electric vehicles.

On average, historical production data indicates that small entities’ annual sales have been well below this range as shown in Table 11-1. EPA believes that capping the number of vehicles exempted is an appropriate protection for GHG emissions, while still allowing small entities to produce vehicles consistent with typical past annual sales. EPA is finalizing a 500 vehicle cap on



GHG for small entities. EPA notes that for small entities with vehicles exceeding the cap, those manufacturers could be eligible for the small volume manufacturer standards.

**Table 11-1 Small Entity Vehicle Production from Model Year 2017 to 2022**

|      | Karma | RUF | Koenigsegg | Pagani | Rimac |
|------|-------|-----|------------|--------|-------|
| 2017 | 0     | 0   | 0          | 46     | 1     |
| 2018 | 295   | 2   | 10         | 10     | 0     |
| 2019 | 83    | 1   | 12         | 0      | 1     |
| 2020 | 153   | 6   | 4          | 0      | 0     |
| 2021 | 68    | 7   | 11         | 0      | 0     |
| 2022 | *     | 2   | 0          | 0      | 0**   |

Note: \* Karma did not report to EPA for 2022.

\*\*No longer a small business. They are now part of Porsche as Bugatti-Rimac

While ICI’s imported vehicles have not been accounted for in an OEM manufacturer’s GHG average, there are typically only a small number of vehicles imported each year. Table 11-2 shows the number of vehicles imported by each of the current ICIs. Since 2014, none of the current ICIs have imported more than 15 vehicles each year. Under existing EPA regulations, each ICI is currently limited to importing 50 vehicles per year. EPA is finalizing reducing the limit to 25 vehicles (excluding BEVs or fuel cell vehicles) per year, as a means of limiting the potential environmental impact of importing vehicles with potentially high GHG emissions. Importing of BEVs and fuel cell vehicles will not count against the 25 vehicles cap. EPA believes this lower vehicle limit is important for capping the potential for high-emitting imported vehicles, because, unlike with criteria pollutant emissions as discussed below, there are very limited add-on emissions control options for reducing the GHG emissions of an imported vehicle. This action will have no financial impact on the ICI businesses, as it is still far above the average number of vehicles imported by ICIs in recent years.

**Table 11-2 ICI Import Records (number of imported vehicles)**

|              |                 | 2014 | 2015 | 2016 | 2017 | 2018 | 2019 | 2020 | 2021 | 2022 |
|--------------|-----------------|------|------|------|------|------|------|------|------|------|
| Current ICIs | G & K           | 7    | 7    | 6    | 6    | 8    | 12   | 6    | 10   | 8    |
|              | JK Technologies | 13   | 15   | 8    | 10   | 10   | 9    | 3    | 4    | 5    |
|              | Wallace Labs    | 0    | 0    | 15   | 1    | 7    | 5    | 4    | 4    | 10   |

EPA also has evaluated the potential impacts on small businesses for the final criteria pollutant emissions standards, including both the NMOG+ NO<sub>x</sub> standard and the PM standard.

EPA’s final NMOG+NO<sub>x</sub> standards should have no impact on the existing small entity manufacturers which produce only electric vehicles. EPA is finalizing a delayed phase in for small entities (as well as small volume manufacturers) such that they will not have to meet the criteria pollutant standards until the last year of the standards phase-in. The final standards are expected to have minimal impact on both the alternate fuel convertors and ICIs. Alternate fuel convertors acquire vehicles that would already meet the standard on gasoline or diesel fuel and have the ability to make changes, such as calibration, so the vehicles continue to meet the standard on an alternate fuel such as propane or natural gas. ICIs take vehicles that were certified in a foreign country and make the vehicle meet the EPA standard for the year the vehicle was built. This may require catalyst and calibration changes depending on the vehicle’s original

requirements. EPA believes changes to the NMOG+ NO<sub>x</sub> standard will require a similar amount of effort for both alternative fuel convertors and ICIs to meet the new standard when compared to the previous (Tier 3) emissions standard. See Section III.D.9 of the preamble for additional detail on criteria pollutant standards for small volume manufacturers.

The final PM standard could potentially have a unique impact on each type of small entity. The current small entity manufacturers all produce only BEVs which have no tailpipe emissions and therefore would inherently comply with the PM standard. EPA is finalizing a delayed phase-in for small volume manufacturers. Since the current small entities are also small volume manufacturers, they will not have to meet the criteria pollutant standards until the last year of the standards phase-in. Alternative fuel convertors buy OEM vehicles that already would need to be compliant for PM but must test the vehicle on the converted fuel and show that it still meets the standard. There would be an increased testing burden to measure PM on the cold temperature test (as discussed further in Section III.D.2 of the preamble), but alternative fuel vehicles are already exempted from cold testing requirements under existing EPA regulations. EPA is finalizing continuing this exemption for cold temperature testing, and thus there would be no impact on alternative fuel convertors. ICIs must do a complete set of emissions tests for an imported vehicle that does not already have an existing certificate (referred to as non-conforming vehicles). ICIs currently only have to test non-methane hydrocarbons (NMHC) on the cold test; to minimize the testing burden on ICIs, EPA is finalizing exempting ICIs from measuring PM during cold testing. ICIs will only need to comply with the new PM levels on the FTP75 and US06. The stringency of the final PM standard may lead to OEMs choosing to comply by the use of gasoline particulate filters (GPFs). Most of the ICE vehicles since 2014 have been imported from Europe where GPFs are mandatory, so EPA estimates that there will be no financial impact to ICIs based on additional testing or ensuring imported vehicles are compliant with emissions standards.

The final aspect of the final rule that could have potential impacts on small entities is battery durability (Section III.G.2 of the preamble). EPA finds it appropriate to exempt small entities from battery durability requirements at this time while we implement the requirement for larger manufacturers. Based on our experience with larger manufacturers, we will be in a better position to judge whether the requirements are appropriate to extend to smaller manufacturers in a potential future rulemaking.

## **Chapter 11 References**

13 CFR 121.201. 2023.

## **Chapter 12: Compliance Effects**

This chapter presents the outputs from OMEGA related to the final light- and medium-duty vehicle GHG standards, the two alternative standard stringencies, Alternative A (a more stringent standard) and Alternative B (a less stringent standard) which are presented in Section III.F of the preamble, and a range of sensitivity scenarios.

In the following sections, we provide detailed modeling results of projected GHG targets, projected achieved GHG compliance levels, as well as per-vehicle costs and technology penetrations. These projections are grouped by car and truck regulatory classes, and in select tables, using EPA's classification of body style in the OMEGA model. Chapter 12.1 presents the compliance effects for the light-duty vehicle GHG standards and Chapter 12.2 presents the compliance effects for the medium-duty vehicle GHG standards.

### **12.1 Light-Duty Vehicles**

#### **12.1.1 GHG Targets and Compliance Levels**

##### **12.1.1.1 CO<sub>2</sub> g/mi**

Shown below are the projected average GHG targets for each manufacturer, as well as their corresponding average achieved compliance, in g/mile, for cars, trucks and the combined fleet.

##### **12.1.1.1.1 Final standards**

OEM-specific GHG emissions targets for the final standards are shown in Table 12-1 for cars, Table 12-2 for trucks, and the combined fleet in Table 12-3. Similarly, projected achieved GHG emissions levels are presented for cars, trucks, and the combined fleet in Table 12-4, Table 12-5 and Table 12-6.

**Table 12-1: Projected GHG Targets, Final Standards - Cars**

| Manufacturer   | 2027       | 2028       | 2029       | 2030      | 2031      | 2032      |
|----------------|------------|------------|------------|-----------|-----------|-----------|
| Aston Martin   | 140        | 127        | 113        | 100       | 87        | 73        |
| BMW            | 139        | 126        | 113        | 100       | 87        | 73        |
| Ferrari        | 139        | 127        | 113        | 100       | 87        | 73        |
| Ford           | 140        | 126        | 112        | 99        | 86        | 73        |
| General Motors | 138        | 125        | 111        | 98        | 86        | 72        |
| Honda          | 138        | 125        | 112        | 99        | 86        | 72        |
| Hyundai        | 138        | 125        | 112        | 99        | 86        | 72        |
| JLR            | 139        | 126        | 112        | 99        | 86        | 73        |
| Kia            | 138        | 125        | 112        | 99        | 86        | 72        |
| Lucid          | 145        | 130        | 116        | 102       | 89        | 75        |
| Mazda          | 138        | 125        | 111        | 98        | 86        | 72        |
| McLaren        | 139        | 126        | 112        | 99        | 86        | 73        |
| Mercedes Benz  | 140        | 127        | 113        | 100       | 87        | 73        |
| Mitsubishi     | 137        | 124        | 111        | 98        | 85        | 72        |
| Nissan         | 138        | 125        | 112        | 99        | 86        | 72        |
| Rivian         | -          | -          | -          | -         | -         | -         |
| Stellantis     | 141        | 128        | 114        | 101       | 88        | 74        |
| Subaru         | 137        | 124        | 111        | 98        | 86        | 72        |
| Tesla          | 143        | 128        | 114        | 101       | 87        | 74        |
| Toyota         | 138        | 125        | 112        | 99        | 86        | 72        |
| Volvo          | 140        | 126        | 113        | 99        | 86        | 73        |
| VW             | 138        | 125        | 112        | 99        | 86        | 72        |
| <b>TOTAL</b>   | <b>139</b> | <b>125</b> | <b>112</b> | <b>99</b> | <b>86</b> | <b>73</b> |

**Table 12-2: Projected GHG Targets, Final Standards - Trucks**

| Manufacturer   | 2027       | 2028       | 2029       | 2030       | 2031       | 2032      |
|----------------|------------|------------|------------|------------|------------|-----------|
| Aston Martin   | 185        | 166        | 147        | 129        | 110        | 91        |
| BMW            | 181        | 161        | 142        | 124        | 105        | 88        |
| Ferrari        | -          | -          | -          | -          | -          | -         |
| Ford           | 192        | 171        | 152        | 133        | 113        | 94        |
| General Motors | 200        | 178        | 158        | 138        | 117        | 97        |
| Honda          | 172        | 155        | 137        | 120        | 102        | 85        |
| Hyundai        | 171        | 153        | 136        | 119        | 101        | 84        |
| JLR            | 178        | 159        | 141        | 124        | 105        | 87        |
| Kia            | 175        | 157        | 139        | 122        | 104        | 86        |
| Lucid          | -          | -          | -          | -          | -          | -         |
| Mazda          | 162        | 145        | 129        | 114        | 96         | 80        |
| McLaren        | -          | -          | -          | -          | -          | -         |
| Mercedes Benz  | 180        | 162        | 143        | 126        | 107        | 89        |
| Mitsubishi     | 158        | 142        | 127        | 112        | 95         | 78        |
| Nissan         | 178        | 159        | 141        | 124        | 106        | 88        |
| Rivian         | 221        | 196        | 172        | 145        | 122        | 101       |
| Stellantis     | 193        | 173        | 153        | 134        | 114        | 95        |
| Subaru         | 161        | 145        | 129        | 113        | 96         | 80        |
| Tesla          | 186        | 159        | 140        | 122        | 103        | 85        |
| Toyota         | 179        | 161        | 142        | 125        | 106        | 88        |
| Volvo          | 177        | 158        | 140        | 123        | 104        | 86        |
| VW             | 172        | 153        | 136        | 120        | 102        | 84        |
| <b>TOTAL</b>   | <b>184</b> | <b>165</b> | <b>146</b> | <b>128</b> | <b>109</b> | <b>90</b> |

**Table 12-3: Projected GHG Targets, Final Standards - Combined**

| Manufacturer   | 2027       | 2028       | 2029       | 2030       | 2031       | 2032      |
|----------------|------------|------------|------------|------------|------------|-----------|
| Aston Martin   | 158        | 143        | 127        | 112        | 97         | 81        |
| BMW            | 163        | 147        | 130        | 114        | 98         | 82        |
| Ferrari        | 139        | 127        | 113        | 100        | 87         | 73        |
| Ford           | 186        | 167        | 148        | 129        | 110        | 91        |
| General Motors | 185        | 166        | 147        | 129        | 110        | 91        |
| Honda          | 157        | 141        | 126        | 111        | 95         | 79        |
| Hyundai        | 155        | 140        | 124        | 109        | 94         | 78        |
| JLR            | 176        | 158        | 140        | 123        | 105        | 87        |
| Kia            | 158        | 142        | 127        | 112        | 96         | 80        |
| Lucid          | 145        | 130        | 116        | 102        | 89         | 75        |
| Mazda          | 158        | 142        | 127        | 112        | 95         | 79        |
| McLaren        | 139        | 126        | 112        | 99         | 86         | 73        |
| Mercedes Benz  | 167        | 150        | 133        | 117        | 100        | 84        |
| Mitsubishi     | 147        | 133        | 118        | 105        | 90         | 75        |
| Nissan         | 155        | 140        | 125        | 110        | 95         | 79        |
| Rivian         | 221        | 196        | 172        | 145        | 122        | 101       |
| Stellantis     | 187        | 168        | 149        | 131        | 111        | 92        |
| Subaru         | 158        | 142        | 126        | 111        | 95         | 79        |
| Tesla          | 159        | 140        | 124        | 109        | 93         | 78        |
| Toyota         | 163        | 147        | 130        | 115        | 98         | 82        |
| Volvo          | 169        | 151        | 134        | 118        | 100        | 83        |
| VW             | 161        | 144        | 129        | 113        | 97         | 81        |
| <b>TOTAL</b>   | <b>170</b> | <b>153</b> | <b>136</b> | <b>119</b> | <b>102</b> | <b>85</b> |

**Table 12-4: Achieved GHG Levels, Final Standards - Cars**

| Manufacturer   | 2027       | 2028      | 2029      | 2030      | 2031      | 2032      |
|----------------|------------|-----------|-----------|-----------|-----------|-----------|
| Aston Martin   | 186        | 166       | 141       | 117       | 117       | 116       |
| BMW            | 179        | 142       | 114       | 81        | 91        | 73        |
| Ferrari        | 212        | 148       | 149       | 125       | 109       | 96        |
| Ford           | 118        | 115       | 103       | 98        | 84        | 76        |
| General Motors | 137        | 94        | 82        | 79        | 68        | 59        |
| Honda          | 116        | 102       | 83        | 63        | 58        | 50        |
| Hyundai        | 124        | 98        | 90        | 80        | 71        | 62        |
| JLR            | 164        | 147       | 148       | 148       | 146       | 142       |
| Kia            | 111        | 94        | 84        | 67        | 66        | 53        |
| Lucid          | -11        | -8        | -6        | -3        | -2        | -2        |
| Mazda          | 119        | 80        | 69        | 69        | 63        | 56        |
| McLaren        | 241        | 171       | 163       | 133       | 103       | 90        |
| Mercedes Benz  | 146        | 140       | 129       | 110       | 117       | 86        |
| Mitsubishi     | 126        | 112       | 99        | 87        | 79        | 70        |
| Nissan         | 126        | 107       | 89        | 85        | 77        | 65        |
| Rivian         | -          | -         | -         | -         | -         | -         |
| Stellantis     | 188        | 122       | 91        | 74        | 55        | 51        |
| Subaru         | 147        | 97        | 81        | 75        | 68        | 56        |
| Tesla          | -11        | -8        | -6        | -3        | -2        | -2        |
| Toyota         | 107        | 101       | 85        | 74        | 73        | 61        |
| Volvo          | 92         | 68        | 54        | 75        | 55        | 48        |
| VW             | 114        | 121       | 105       | 100       | 96        | 81        |
| <b>TOTAL</b>   | <b>116</b> | <b>97</b> | <b>83</b> | <b>72</b> | <b>67</b> | <b>57</b> |

**Table 12-5: Achieved GHG Levels, Final Standards - Trucks**

| Manufacturer   | 2027       | 2028       | 2029       | 2030       | 2031       | 2032       |
|----------------|------------|------------|------------|------------|------------|------------|
| Aston Martin   | 242        | 220        | 190        | 180        | 146        | 110        |
| BMW            | 202        | 165        | 163        | 154        | 139        | 112        |
| Ferrari        | -          | -          | -          | -          | -          | -          |
| Ford           | 199        | 182        | 154        | 139        | 118        | 105        |
| General Motors | 213        | 205        | 175        | 156        | 133        | 108        |
| Honda          | 167        | 158        | 146        | 137        | 117        | 103        |
| Hyundai        | 165        | 152        | 133        | 118        | 102        | 93         |
| JLR            | 210        | 190        | 162        | 144        | 127        | 113        |
| Kia            | 180        | 172        | 154        | 143        | 111        | 102        |
| Lucid          | -          | -          | -          | -          | -          | -          |
| Mazda          | 162        | 154        | 135        | 119        | 105        | 93         |
| McLaren        | -          | -          | -          | -          | -          | -          |
| Mercedes Benz  | 184        | 169        | 149        | 125        | 101        | 95         |
| Mitsubishi     | 167        | 130        | 116        | 105        | 94         | 85         |
| Nissan         | 197        | 184        | 171        | 137        | 113        | 100        |
| Rivian         | -14        | -10        | -7         | -3         | -2         | -2         |
| Stellantis     | 207        | 195        | 169        | 150        | 128        | 110        |
| Subaru         | 159        | 152        | 134        | 118        | 104        | 93         |
| Tesla          | -14        | -10        | -7         | -3         | -2         | -2         |
| Toyota         | 185        | 163        | 148        | 129        | 109        | 96         |
| Volvo          | 143        | 148        | 133        | 115        | 114        | 108        |
| VW             | 177        | 153        | 125        | 114        | 98         | 93         |
| <b>TOTAL</b>   | <b>186</b> | <b>173</b> | <b>151</b> | <b>135</b> | <b>115</b> | <b>100</b> |

**Table 12-6: Achieved GHG Levels, Final Standards - Combined**

| Manufacturer   | 2027       | 2028       | 2029       | 2030       | 2031       | 2032      |
|----------------|------------|------------|------------|------------|------------|-----------|
| Aston Martin   | 209        | 188        | 162        | 144        | 129        | 113       |
| BMW            | 193        | 155        | 142        | 124        | 119        | 97        |
| Ferrari        | 212        | 148        | 149        | 125        | 109        | 96        |
| Ford           | 191        | 175        | 148        | 135        | 114        | 102       |
| General Motors | 195        | 179        | 153        | 138        | 118        | 96        |
| Honda          | 144        | 133        | 118        | 104        | 91         | 80        |
| Hyundai        | 145        | 126        | 113        | 100        | 87         | 78        |
| JLR            | 208        | 189        | 162        | 144        | 128        | 114       |
| Kia            | 148        | 136        | 122        | 108        | 91         | 80        |
| Lucid          | -11        | -8         | -6         | -3         | -2         | -2        |
| Mazda          | 157        | 144        | 127        | 113        | 99         | 88        |
| McLaren        | 241        | 171        | 163        | 133        | 103        | 90        |
| Mercedes Benz  | 171        | 160        | 142        | 120        | 106        | 92        |
| Mitsubishi     | 146        | 121        | 107        | 96         | 86         | 77        |
| Nissan         | 157        | 141        | 125        | 108        | 93         | 80        |
| Rivian         | -14        | -10        | -7         | -3         | -2         | -2        |
| Stellantis     | 205        | 187        | 161        | 142        | 121        | 104       |
| Subaru         | 157        | 144        | 126        | 112        | 99         | 88        |
| Tesla          | -12        | -9         | -6         | -3         | -2         | -2        |
| Toyota         | 154        | 138        | 123        | 107        | 95         | 82        |
| Volvo          | 131        | 130        | 115        | 106        | 101        | 94        |
| VW             | 157        | 143        | 119        | 109        | 98         | 89        |
| <b>TOTAL</b>   | <b>164</b> | <b>149</b> | <b>130</b> | <b>116</b> | <b>100</b> | <b>87</b> |

### 12.1.1.1.2 Alternative A

Table 12-7 through Table 12-9 show the OEM-specific targets for Alternative A. Achieved levels are presented, by manufacturer, in Table 12-10 through Table 12-12.

**Table 12-7: Projected GHG Targets, Alternative A - Cars**

| Manufacturer   | 2027       | 2028       | 2029      | 2030      | 2031      | 2032      |
|----------------|------------|------------|-----------|-----------|-----------|-----------|
| Aston Martin   | 135        | 118        | 100       | 91        | 83        | 74        |
| BMW            | 134        | 117        | 99        | 91        | 82        | 73        |
| Ferrari        | 134        | 117        | 99        | 91        | 83        | 73        |
| Ford           | 135        | 116        | 98        | 90        | 82        | 73        |
| General Motors | 133        | 115        | 97        | 90        | 81        | 72        |
| Honda          | 133        | 115        | 98        | 90        | 82        | 72        |
| Hyundai        | 134        | 116        | 98        | 90        | 82        | 72        |
| JLR            | 135        | 117        | 99        | 91        | 82        | 73        |
| Kia            | 134        | 116        | 98        | 90        | 82        | 72        |
| Lucid          | 140        | 120        | 101       | 93        | 84        | 75        |
| Mazda          | 133        | 115        | 97        | 90        | 81        | 72        |
| McLaren        | 134        | 116        | 98        | 91        | 82        | 73        |
| Mercedes Benz  | 136        | 118        | 99        | 91        | 83        | 73        |
| Mitsubishi     | 132        | 115        | 97        | 90        | 81        | 72        |
| Nissan         | 134        | 116        | 98        | 90        | 82        | 72        |
| Rivian         | -          | -          | -         | -         | -         | -         |
| Stellantis     | 137        | 118        | 100       | 92        | 83        | 74        |
| Subaru         | 133        | 115        | 97        | 90        | 81        | 72        |
| Tesla          | 138        | 118        | 100       | 92        | 83        | 74        |
| Toyota         | 134        | 116        | 98        | 90        | 82        | 72        |
| Volvo          | 135        | 117        | 99        | 91        | 82        | 73        |
| VW             | 133        | 116        | 98        | 90        | 82        | 72        |
| <b>TOTAL</b>   | <b>134</b> | <b>116</b> | <b>98</b> | <b>90</b> | <b>82</b> | <b>73</b> |



**Table 12-8: Projected GHG Targets, Alternative A - Trucks**

| Manufacturer   | 2027       | 2028       | 2029       | 2030       | 2031       | 2032      |
|----------------|------------|------------|------------|------------|------------|-----------|
| Aston Martin   | 166        | 143        | 121        | 112        | 103        | 91        |
| BMW            | 161        | 139        | 118        | 109        | 99         | 88        |
| Ferrari        | -          | -          | -          | -          | -          | -         |
| Ford           | 171        | 149        | 126        | 116        | 106        | 94        |
| General Motors | 178        | 155        | 131        | 121        | 110        | 97        |
| Honda          | 154        | 134        | 113        | 105        | 96         | 85        |
| Hyundai        | 153        | 133        | 112        | 104        | 95         | 84        |
| JLR            | 159        | 138        | 117        | 108        | 99         | 88        |
| Kia            | 156        | 136        | 115        | 107        | 97         | 86        |
| Lucid          | -          | -          | -          | -          | -          | -         |
| Mazda          | 144        | 126        | 107        | 99         | 90         | 80        |
| McLaren        | -          | -          | -          | -          | -          | -         |
| Mercedes Benz  | 162        | 141        | 119        | 110        | 100        | 89        |
| Mitsubishi     | 141        | 123        | 105        | 97         | 89         | 79        |
| Nissan         | 158        | 138        | 117        | 108        | 98         | 87        |
| Rivian         | 195        | 169        | 142        | 126        | 114        | 101       |
| Stellantis     | 172        | 150        | 127        | 117        | 107        | 95        |
| Subaru         | 144        | 125        | 107        | 99         | 90         | 80        |
| Tesla          | 165        | 137        | 115        | 106        | 96         | 85        |
| Toyota         | 160        | 139        | 118        | 109        | 99         | 88        |
| Volvo          | 158        | 143        | 120        | 110        | 100        | 89        |
| VW             | 154        | 133        | 113        | 104        | 95         | 85        |
| <b>TOTAL</b>   | <b>164</b> | <b>143</b> | <b>121</b> | <b>112</b> | <b>102</b> | <b>90</b> |

**Table 12-9: Projected GHG Targets, Alternative A - Combined**

| Manufacturer   | 2027       | 2028       | 2029       | 2030       | 2031      | 2032      |
|----------------|------------|------------|------------|------------|-----------|-----------|
| Aston Martin   | 148        | 128        | 108        | 100        | 91        | 81        |
| BMW            | 150        | 130        | 110        | 102        | 92        | 82        |
| Ferrari        | 134        | 117        | 99         | 91         | 83        | 73        |
| Ford           | 167        | 145        | 123        | 114        | 103       | 91        |
| General Motors | 167        | 146        | 123        | 113        | 103       | 91        |
| Honda          | 145        | 126        | 106        | 98         | 90        | 79        |
| Hyundai        | 143        | 125        | 105        | 97         | 89        | 79        |
| JLR            | 158        | 138        | 117        | 108        | 98        | 87        |
| Kia            | 146        | 127        | 107        | 99         | 90        | 80        |
| Lucid          | 140        | 120        | 101        | 93         | 84        | 75        |
| Mazda          | 143        | 124        | 105        | 98         | 89        | 79        |
| McLaren        | 134        | 116        | 98         | 91         | 82        | 73        |
| Mercedes Benz  | 153        | 133        | 113        | 104        | 95        | 84        |
| Mitsubishi     | 137        | 119        | 101        | 93         | 85        | 75        |
| Nissan         | 144        | 125        | 106        | 98         | 89        | 79        |
| Rivian         | 195        | 169        | 142        | 126        | 114       | 101       |
| Stellantis     | 168        | 147        | 124        | 114        | 104       | 92        |
| Subaru         | 142        | 124        | 105        | 98         | 89        | 79        |
| Tesla          | 148        | 126        | 106        | 97         | 88        | 78        |
| Toyota         | 149        | 130        | 110        | 102        | 92        | 82        |
| Volvo          | 152        | 137        | 115        | 106        | 96        | 85        |
| VW             | 147        | 128        | 108        | 100        | 91        | 81        |
| <b>TOTAL</b>   | <b>155</b> | <b>135</b> | <b>114</b> | <b>105</b> | <b>96</b> | <b>85</b> |

**Table 12-10: Achieved GHG Levels, Alternative A - Cars**

| Manufacturer   | 2027       | 2028      | 2029      | 2030      | 2031      | 2032      |
|----------------|------------|-----------|-----------|-----------|-----------|-----------|
| Aston Martin   | 184        | 139       | 113       | 99        | 92        | 84        |
| BMW            | 185        | 124       | 107       | 106       | 87        | 64        |
| Ferrari        | 227        | 154       | 146       | 122       | 103       | 94        |
| Ford           | 115        | 106       | 91        | 77        | 76        | 68        |
| General Motors | 137        | 112       | 94        | 88        | 87        | 76        |
| Honda          | 114        | 90        | 75        | 66        | 52        | 45        |
| Hyundai        | 122        | 104       | 93        | 82        | 73        | 58        |
| JLR            | 148        | 102       | 117       | 105       | 91        | 78        |
| Kia            | 112        | 84        | 68        | 58        | 52        | 42        |
| Lucid          | -2         | -2        | -2        | -2        | -2        | -2        |
| Mazda          | 122        | 76        | 57        | 51        | 33        | 43        |
| McLaren        | 248        | 168       | 159       | 128       | 103       | 92        |
| Mercedes Benz  | 135        | 107       | 98        | 91        | 89        | 69        |
| Mitsubishi     | 116        | 95        | 84        | 78        | 70        | 60        |
| Nissan         | 127        | 100       | 90        | 81        | 66        | 57        |
| Rivian         | -          | -         | -         | -         | -         | -         |
| Stellantis     | 168        | 135       | 115       | 121       | 105       | 101       |
| Subaru         | 144        | 112       | 104       | 98        | 90        | 68        |
| Tesla          | -2         | -2        | -2        | -2        | -2        | -2        |
| Toyota         | 113        | 85        | 74        | 76        | 62        | 51        |
| Volvo          | 81         | 97        | 83        | 88        | 77        | 65        |
| VW             | 135        | 105       | 87        | 74        | 72        | 73        |
| <b>TOTAL</b>   | <b>117</b> | <b>92</b> | <b>79</b> | <b>74</b> | <b>65</b> | <b>55</b> |

**Table 12-11: Achieved GHG Levels, Alternative A - Trucks**

| Manufacturer   | 2027       | 2028       | 2029       | 2030       | 2031       | 2032      |
|----------------|------------|------------|------------|------------|------------|-----------|
| Aston Martin   | 221        | 194        | 190        | 157        | 124        | 107       |
| BMW            | 192        | 143        | 136        | 112        | 103        | 100       |
| Ferrari        | -          | -          | -          | -          | -          | -         |
| Ford           | 193        | 160        | 134        | 127        | 114        | 103       |
| General Motors | 210        | 174        | 144        | 130        | 122        | 108       |
| Honda          | 155        | 138        | 129        | 115        | 104        | 90        |
| Hyundai        | 149        | 123        | 112        | 101        | 87         | 78        |
| JLR            | 191        | 152        | 134        | 123        | 108        | 94        |
| Kia            | 163        | 152        | 143        | 129        | 111        | 97        |
| Lucid          | -          | -          | -          | -          | -          | -         |
| Mazda          | 148        | 119        | 108        | 101        | 89         | 75        |
| McLaren        | -          | -          | -          | -          | -          | -         |
| Mercedes Benz  | 173        | 155        | 137        | 122        | 105        | 92        |
| Mitsubishi     | 150        | 122        | 109        | 101        | 89         | 77        |
| Nissan         | 192        | 164        | 140        | 120        | 113        | 101       |
| Rivian         | -2         | -2         | -2         | -2         | -2         | -2        |
| Stellantis     | 205        | 166        | 139        | 123        | 116        | 103       |
| Subaru         | 144        | 122        | 102        | 93         | 79         | 72        |
| Tesla          | -2         | -2         | -2         | -2         | -2         | -2        |
| Toyota         | 176        | 152        | 137        | 114        | 104        | 94        |
| Volvo          | 151        | 125        | 115        | 104        | 95         | 86        |
| VW             | 155        | 130        | 122        | 113        | 90         | 78        |
| <b>TOTAL</b>   | <b>179</b> | <b>150</b> | <b>130</b> | <b>116</b> | <b>105</b> | <b>94</b> |

**Table 12-12: Achieved GHG Levels, Alternative A - Combined**

| Manufacturer   | 2027       | 2028       | 2029       | 2030       | 2031      | 2032      |
|----------------|------------|------------|------------|------------|-----------|-----------|
| Aston Martin   | 199        | 162        | 145        | 123        | 105       | 93        |
| BMW            | 189        | 135        | 124        | 110        | 97        | 85        |
| Ferrari        | 227        | 154        | 146        | 122        | 103       | 94        |
| Ford           | 186        | 154        | 130        | 122        | 110       | 100       |
| General Motors | 192        | 159        | 133        | 121        | 114       | 101       |
| Honda          | 137        | 117        | 105        | 94         | 81        | 70        |
| Hyundai        | 136        | 114        | 103        | 92         | 80        | 69        |
| JLR            | 189        | 151        | 134        | 122        | 108       | 94        |
| Kia            | 140        | 121        | 109        | 97         | 84        | 72        |
| Lucid          | -2         | -2         | -2         | -2         | -2        | -2        |
| Mazda          | 145        | 114        | 102        | 95         | 82        | 71        |
| McLaren        | 248        | 168        | 159        | 128        | 103       | 92        |
| Mercedes Benz  | 160        | 139        | 124        | 112        | 100       | 85        |
| Mitsubishi     | 132        | 108        | 96         | 89         | 79        | 68        |
| Nissan         | 155        | 128        | 112        | 98         | 87        | 76        |
| Rivian         | -2         | -2         | -2         | -2         | -2        | -2        |
| Stellantis     | 201        | 163        | 137        | 123        | 115       | 103       |
| Subaru         | 144        | 120        | 103        | 94         | 81        | 71        |
| Tesla          | -2         | -2         | -2         | -2         | -2        | -2        |
| Toyota         | 151        | 125        | 112        | 99         | 87        | 77        |
| Volvo          | 135        | 119        | 108        | 100        | 91        | 81        |
| VW             | 148        | 122        | 111        | 101        | 85        | 76        |
| <b>TOTAL</b>   | <b>160</b> | <b>132</b> | <b>115</b> | <b>103</b> | <b>93</b> | <b>82</b> |

**12.1.1.1.3 Alternative B**

Table 12-13 through Table 12-15 show the OEM-specific targets for Alternative B. Achieved levels are presented, by manufacturer, in Table 12-16 through Table 12-18.

**Table 12-13: Projected GHG Targets, Alternative B - Cars**

| Manufacturer   | 2027       | 2028       | 2029       | 2030      | 2031      | 2032      |
|----------------|------------|------------|------------|-----------|-----------|-----------|
| Aston Martin   | 140        | 127        | 113        | 100       | 92        | 83        |
| BMW            | 139        | 126        | 113        | 100       | 91        | 83        |
| Ferrari        | 139        | 126        | 113        | 99        | 91        | 83        |
| Ford           | 140        | 125        | 112        | 99        | 90        | 82        |
| General Motors | 138        | 125        | 111        | 99        | 90        | 82        |
| Honda          | 138        | 125        | 111        | 99        | 90        | 82        |
| Hyundai        | 138        | 125        | 112        | 99        | 90        | 82        |
| JLR            | 139        | 126        | 112        | 99        | 91        | 82        |
| Kia            | 138        | 125        | 112        | 99        | 90        | 82        |
| Lucid          | 145        | 130        | 116        | 102       | 93        | 85        |
| Mazda          | 138        | 125        | 111        | 98        | 90        | 82        |
| McLaren        | 139        | 126        | 112        | 99        | 91        | 83        |
| Mercedes Benz  | 140        | 127        | 113        | 100       | 92        | 83        |
| Mitsubishi     | 137        | 124        | 111        | 98        | 90        | 82        |
| Nissan         | 138        | 125        | 112        | 99        | 90        | 82        |
| Rivian         | -          | -          | -          | -         | -         | -         |
| Stellantis     | 141        | 128        | 114        | 101       | 92        | 84        |
| Subaru         | 137        | 124        | 111        | 98        | 90        | 82        |
| Tesla          | 143        | 128        | 114        | 101       | 92        | 83        |
| Toyota         | 138        | 125        | 112        | 99        | 90        | 82        |
| Volvo          | 140        | 126        | 112        | 99        | 91        | 82        |
| VW             | 138        | 125        | 112        | 99        | 90        | 82        |
| <b>TOTAL</b>   | <b>139</b> | <b>125</b> | <b>112</b> | <b>99</b> | <b>91</b> | <b>82</b> |

**Table 12-14: Projected GHG Targets, Alternative B - Trucks**

| Manufacturer   | 2027       | 2028       | 2029       | 2030       | 2031       | 2032       |
|----------------|------------|------------|------------|------------|------------|------------|
| Aston Martin   | 185        | 165        | 146        | 128        | 115        | 102        |
| BMW            | 181        | 160        | 141        | 124        | 111        | 98         |
| Ferrari        | -          | -          | -          | -          | -          | -          |
| Ford           | 192        | 171        | 152        | 133        | 119        | 104        |
| General Motors | 200        | 178        | 158        | 138        | 123        | 108        |
| Honda          | 172        | 154        | 137        | 120        | 108        | 95         |
| Hyundai        | 171        | 153        | 135        | 119        | 106        | 94         |
| JLR            | 178        | 159        | 141        | 124        | 111        | 97         |
| Kia            | 175        | 157        | 139        | 122        | 109        | 96         |
| Lucid          | -          | -          | -          | -          | -          | -          |
| Mazda          | 162        | 145        | 129        | 114        | 102        | 89         |
| McLaren        | -          | -          | -          | -          | -          | -          |
| Mercedes Benz  | 180        | 161        | 143        | 125        | 112        | 99         |
| Mitsubishi     | 158        | 142        | 127        | 112        | 100        | 88         |
| Nissan         | 178        | 159        | 141        | 123        | 110        | 97         |
| Rivian         | 221        | 196        | 172        | 145        | 129        | 113        |
| Stellantis     | 193        | 173        | 153        | 134        | 119        | 105        |
| Subaru         | 161        | 145        | 129        | 113        | 101        | 89         |
| Tesla          | 186        | 159        | 140        | 122        | 109        | 95         |
| Toyota         | 179        | 161        | 142        | 125        | 111        | 98         |
| Volvo          | 177        | 158        | 140        | 123        | 110        | 96         |
| VW             | 172        | 153        | 137        | 120        | 107        | 94         |
| <b>TOTAL</b>   | <b>184</b> | <b>165</b> | <b>146</b> | <b>128</b> | <b>114</b> | <b>100</b> |

**Table 12-15: Projected GHG Targets, Alternative B - Combined**

| Manufacturer   | 2027       | 2028       | 2029       | 2030       | 2031       | 2032      |
|----------------|------------|------------|------------|------------|------------|-----------|
| Aston Martin   | 158        | 143        | 127        | 112        | 102        | 91        |
| BMW            | 163        | 146        | 129        | 114        | 103        | 92        |
| Ferrari        | 139        | 126        | 113        | 99         | 91         | 83        |
| Ford           | 186        | 167        | 148        | 130        | 116        | 102       |
| General Motors | 185        | 166        | 147        | 129        | 116        | 102       |
| Honda          | 157        | 141        | 126        | 111        | 100        | 89        |
| Hyundai        | 155        | 140        | 124        | 109        | 99         | 88        |
| JLR            | 177        | 158        | 140        | 123        | 110        | 97        |
| Kia            | 158        | 142        | 127        | 111        | 101        | 90        |
| Lucid          | 145        | 130        | 116        | 102        | 93         | 85        |
| Mazda          | 158        | 142        | 127        | 112        | 100        | 88        |
| McLaren        | 139        | 126        | 112        | 99         | 91         | 83        |
| Mercedes Benz  | 167        | 150        | 133        | 117        | 105        | 94        |
| Mitsubishi     | 147        | 133        | 118        | 105        | 95         | 85        |
| Nissan         | 155        | 140        | 125        | 110        | 99         | 89        |
| Rivian         | 221        | 196        | 172        | 145        | 129        | 113       |
| Stellantis     | 187        | 168        | 149        | 130        | 117        | 103       |
| Subaru         | 158        | 142        | 126        | 111        | 100        | 88        |
| Tesla          | 159        | 140        | 124        | 109        | 98         | 88        |
| Toyota         | 163        | 147        | 130        | 114        | 103        | 92        |
| Volvo          | 169        | 151        | 134        | 117        | 105        | 93        |
| VW             | 161        | 144        | 129        | 113        | 102        | 90        |
| <b>TOTAL</b>   | <b>170</b> | <b>153</b> | <b>136</b> | <b>119</b> | <b>107</b> | <b>95</b> |

**Table 12-16: Achieved GHG Levels, Alternative B - Cars**

| Manufacturer   | 2027       | 2028       | 2029      | 2030      | 2031      | 2032      |
|----------------|------------|------------|-----------|-----------|-----------|-----------|
| Aston Martin   | 186        | 162        | 138       | 120       | 105       | 93        |
| BMW            | 178        | 132        | 98        | 80        | 74        | 68        |
| Ferrari        | 210        | 146        | 135       | 127       | 111       | 87        |
| Ford           | 115        | 112        | 97        | 86        | 90        | 80        |
| General Motors | 137        | 94         | 79        | 75        | 71        | 64        |
| Honda          | 114        | 102        | 86        | 69        | 72        | 54        |
| Hyundai        | 122        | 109        | 89        | 77        | 80        | 63        |
| JLR            | 168        | 148        | 147       | 146       | 143       | 137       |
| Kia            | 109        | 94         | 81        | 69        | 72        | 59        |
| Lucid          | -16        | -14        | -11       | -8        | -7        | -7        |
| Mazda          | 117        | 102        | 91        | 90        | 83        | 77        |
| McLaren        | 240        | 168        | 153       | 144       | 115       | 88        |
| Mercedes Benz  | 143        | 134        | 101       | 85        | 87        | 78        |
| Mitsubishi     | 125        | 118        | 102       | 91        | 83        | 67        |
| Nissan         | 125        | 113        | 96        | 84        | 66        | 50        |
| Rivian         | -          | -          | -         | -         | -         | -         |
| Stellantis     | 186        | 178        | 145       | 143       | 137       | 113       |
| Subaru         | 146        | 117        | 109       | 105       | 88        | 84        |
| Tesla          | -16        | -14        | -11       | -8        | -7        | -7        |
| Toyota         | 106        | 101        | 79        | 79        | 62        | 57        |
| Volvo          | 89         | 56         | 50        | 53        | 47        | 41        |
| VW             | 116        | 123        | 115       | 112       | 88        | 74        |
| <b>TOTAL</b>   | <b>114</b> | <b>100</b> | <b>83</b> | <b>76</b> | <b>69</b> | <b>58</b> |

**Table 12-17: Achieved GHG Levels, Alternative B - Trucks**

| Manufacturer   | 2027       | 2028       | 2029       | 2030       | 2031       | 2032      |
|----------------|------------|------------|------------|------------|------------|-----------|
| Aston Martin   | 242        | 207        | 192        | 181        | 141        | 112       |
| BMW            | 201        | 165        | 158        | 149        | 130        | 101       |
| Ferrari        | -          | -          | -          | -          | -          | -         |
| Ford           | 199        | 181        | 154        | 140        | 124        | 103       |
| General Motors | 212        | 205        | 174        | 154        | 140        | 124       |
| Honda          | 165        | 160        | 141        | 133        | 107        | 92        |
| Hyundai        | 163        | 149        | 135        | 124        | 102        | 80        |
| JLR            | 203        | 191        | 170        | 149        | 135        | 109       |
| Kia            | 178        | 165        | 148        | 138        | 113        | 88        |
| Lucid          | -          | -          | -          | -          | -          | -         |
| Mazda          | 161        | 153        | 132        | 117        | 105        | 86        |
| McLaren        | -          | -          | -          | -          | -          | -         |
| Mercedes Benz  | 183        | 170        | 156        | 142        | 121        | 95        |
| Mitsubishi     | 165        | 146        | 128        | 114        | 102        | 83        |
| Nissan         | 195        | 179        | 157        | 143        | 132        | 111       |
| Rivian         | -21        | -17        | -14        | -10        | -9         | -9        |
| Stellantis     | 206        | 185        | 160        | 142        | 130        | 111       |
| Subaru         | 157        | 151        | 128        | 114        | 104        | 78        |
| Tesla          | -21        | -17        | -14        | -10        | -9         | -9        |
| Toyota         | 184        | 163        | 148        | 127        | 113        | 88        |
| Volvo          | 142        | 148        | 131        | 116        | 115        | 96        |
| VW             | 175        | 150        | 116        | 113        | 107        | 81        |
| <b>TOTAL</b>   | <b>185</b> | <b>170</b> | <b>148</b> | <b>133</b> | <b>118</b> | <b>98</b> |

**Table 12-18: Achieved GHG Levels, Alternative B - Combined**

| Manufacturer   | 2027       | 2028       | 2029       | 2030       | 2031       | 2032      |
|----------------|------------|------------|------------|------------|------------|-----------|
| Aston Martin   | 209        | 181        | 160        | 145        | 120        | 101       |
| BMW            | 191        | 151        | 133        | 121        | 107        | 87        |
| Ferrari        | 210        | 146        | 135        | 127        | 111        | 87        |
| Ford           | 190        | 174        | 149        | 135        | 121        | 100       |
| General Motors | 195        | 179        | 152        | 135        | 124        | 110       |
| Honda          | 142        | 134        | 117        | 104        | 91         | 75        |
| Hyundai        | 143        | 130        | 113        | 101        | 91         | 72        |
| JLR            | 202        | 189        | 169        | 149        | 135        | 110       |
| Kia            | 147        | 133        | 117        | 107        | 95         | 75        |
| Lucid          | -16        | -14        | -11        | -8         | -7         | -7        |
| Mazda          | 155        | 146        | 127        | 114        | 102        | 85        |
| McLaren        | 240        | 168        | 153        | 144        | 115        | 88        |
| Mercedes Benz  | 170        | 158        | 138        | 123        | 110        | 89        |
| Mitsubishi     | 144        | 131        | 114        | 102        | 92         | 74        |
| Nissan         | 156        | 142        | 123        | 110        | 95         | 77        |
| Rivian         | -21        | -17        | -14        | -10        | -9         | -9        |
| Stellantis     | 204        | 184        | 159        | 142        | 131        | 112       |
| Subaru         | 155        | 146        | 125        | 113        | 102        | 79        |
| Tesla          | -18        | -15        | -12        | -9         | -8         | -8        |
| Toyota         | 152        | 138        | 121        | 108        | 93         | 76        |
| Volvo          | 130        | 127        | 112        | 102        | 99         | 84        |
| VW             | 156        | 142        | 116        | 113        | 101        | 79        |
| <b>TOTAL</b>   | <b>163</b> | <b>149</b> | <b>128</b> | <b>116</b> | <b>104</b> | <b>86</b> |

### 12.1.1.2 CO<sub>2</sub> Mg

Shown below are the projected average GHG targets for each manufacturer, as well as their corresponding average achieved compliance, in Mg, for cars, trucks, and the combined fleet. Total emissions are calculated by multiplying the relevant CO<sub>2</sub> emission rate, the production volume of applicable vehicles, and the expected lifetime vehicle miles traveled (VMT) of those vehicles. The equation to calculate total Mg (for either total emissions, or credits based on the difference between target g/mi and achieved g/mi) is:

$$\text{CO}_2 \text{ (Mg)} = (\text{CO}_2 \text{ (g/mi)} \times \text{VMT} \times \text{Production}) / 1,000,000$$

In the above equation, “VMT” is in miles, and specified in the regulations as 195,264 miles for cars and 225,865 for trucks. When using these equations to calculate values for cars and trucks in aggregate, we use a production weighted average of the car and truck VMT values.

#### 12.1.1.2.1 Final standards

OEM-specific GHG emissions targets for the final standards (in Mg) are shown in Table 12-19, Table 12-20, and Table 12-21 for cars, trucks, and the combined fleet, respectively. Similarly, projected achieved GHG emissions (in Mg) are given for cars, trucks, and the combined fleet in Table 12-22, Table 12-23, and Table 12-24. Finally, overall credits or debits earned are provided for the combined fleet on a manufacturer-specific basis, in Table 12-25.

**Table 12-19: Projected GHG Targets (Mg), Final Standards - Cars**

| Manufacturer   | 2027               | 2028               | 2029              | 2030              | 2031              | 2032              |
|----------------|--------------------|--------------------|-------------------|-------------------|-------------------|-------------------|
| Aston Martin   | 17,704             | 15,112             | 12,723            | 11,580            | 10,414            | 9,194             |
| BMW            | 4,811,426          | 4,066,442          | 3,427,719         | 3,106,950         | 2,788,695         | 2,457,118         |
| Ferrari        | 117,462            | 99,953             | 83,891            | 76,418            | 68,648            | 60,646            |
| Ford           | 5,122,916          | 4,355,612          | 3,698,790         | 3,369,716         | 3,032,682         | 2,677,299         |
| General Motors | 13,284,773         | 11,284,883         | 9,566,422         | 8,707,816         | 7,843,291         | 6,910,093         |
| Honda          | 15,874,797         | 13,272,593         | 11,204,051        | 10,151,855        | 9,079,013         | 7,952,824         |
| Hyundai        | 11,089,685         | 9,368,311          | 7,926,394         | 7,214,834         | 6,469,315         | 5,675,214         |
| JLR            | 58,154             | 49,142             | 41,335            | 37,542            | 33,686            | 29,607            |
| Kia            | 8,579,222          | 7,218,552          | 6,082,894         | 5,515,206         | 4,909,553         | 4,295,147         |
| Lucid          | 78,004             | 64,234             | 54,044            | 48,714            | 43,533            | 37,941            |
| Mazda          | 895,285            | 742,414            | 626,711           | 569,712           | 507,736           | 446,329           |
| McLaren        | 25,997             | 22,077             | 18,565            | 16,922            | 15,222            | 13,420            |
| Mercedes Benz  | 3,233,771          | 2,735,938          | 2,314,221         | 2,105,443         | 1,893,083         | 1,666,097         |
| Mitsubishi     | 2,142,649          | 1,814,980          | 1,543,394         | 1,413,520         | 1,268,148         | 1,116,610         |
| Nissan         | 10,791,762         | 9,050,117          | 7,621,301         | 6,886,246         | 6,169,729         | 5,415,448         |
| Rivian         | -                  | -                  | -                 | -                 | -                 | -                 |
| Stellantis     | 5,222,346          | 4,383,358          | 3,689,782         | 3,326,669         | 2,979,279         | 2,616,512         |
| Subaru         | 2,321,298          | 1,944,516          | 1,633,929         | 1,485,516         | 1,325,755         | 1,163,655         |
| Tesla          | 9,080,496          | 7,669,414          | 6,467,854         | 5,856,666         | 5,254,182         | 4,604,033         |
| Toyota         | 24,889,453         | 20,822,532         | 17,601,163        | 15,925,030        | 14,217,084        | 12,479,907        |
| Volvo          | 843,504            | 708,844            | 599,614           | 546,893           | 493,362           | 434,544           |
| VW             | 5,150,246          | 4,330,856          | 3,644,818         | 3,290,000         | 2,946,308         | 2,582,385         |
| <b>TOTAL</b>   | <b>123,630,948</b> | <b>104,019,879</b> | <b>87,859,616</b> | <b>79,663,247</b> | <b>71,348,717</b> | <b>62,644,024</b> |

**Table 12-20: Projected GHG Targets (Mg), Final Standards - Trucks**

| Manufacturer   | 2027               | 2028               | 2029               | 2030               | 2031               | 2032               |
|----------------|--------------------|--------------------|--------------------|--------------------|--------------------|--------------------|
| Aston Martin   | 17,396             | 15,041             | 12,751             | 11,808             | 10,786             | 9,575              |
| BMW            | 9,277,477          | 7,954,260          | 6,767,818          | 6,229,780          | 5,642,042          | 4,984,831          |
| Ferrari        | -                  | -                  | -                  | -                  | -                  | -                  |
| Ford           | 66,572,021         | 57,647,631         | 49,384,104         | 45,221,251         | 40,773,677         | 36,020,435         |
| General Motors | 66,509,393         | 57,494,012         | 49,141,761         | 44,695,577         | 40,476,847         | 35,772,236         |
| Honda          | 25,922,475         | 22,130,892         | 18,897,061         | 17,348,074         | 15,672,154         | 13,833,699         |
| Hyundai        | 15,784,497         | 13,566,659         | 11,549,771         | 10,603,918         | 9,611,275          | 8,467,078          |
| JLR            | 2,691,596          | 2,334,768          | 1,992,349          | 1,830,406          | 1,661,035          | 1,468,931          |
| Kia            | 13,620,640         | 11,641,709         | 9,915,831          | 9,091,180          | 8,185,434          | 7,219,243          |
| Lucid          | -                  | -                  | -                  | -                  | -                  | -                  |
| Mazda          | 7,436,302          | 6,311,034          | 5,400,534          | 4,979,559          | 4,486,060          | 3,971,235          |
| McLaren        | -                  | -                  | -                  | -                  | -                  | -                  |
| Mercedes Benz  | 8,962,631          | 7,714,081          | 6,582,712          | 6,055,126          | 5,503,215          | 4,839,005          |
| Mitsubishi     | 2,445,355          | 2,096,377          | 1,793,052          | 1,655,038          | 1,492,114          | 1,320,328          |
| Nissan         | 11,325,833         | 9,697,592          | 8,292,925          | 7,577,166          | 6,848,080          | 6,045,768          |
| Rivian         | 1,250,064          | 1,077,654          | 918,242            | 807,311            | 727,744            | 638,008            |
| Stellantis     | 62,588,968         | 53,980,289         | 46,143,424         | 41,917,961         | 37,857,253         | 33,389,881         |
| Subaru         | 17,043,371         | 14,599,846         | 12,455,656         | 11,477,299         | 10,358,520         | 9,165,862          |
| Tesla          | 7,805,005          | 6,470,334          | 5,483,939          | 5,000,067          | 4,506,321          | 3,949,565          |
| Toyota         | 51,119,780         | 43,672,510         | 37,312,056         | 34,072,469         | 30,673,607         | 27,055,432         |
| Volvo          | 3,814,056          | 3,408,766          | 2,893,016          | 2,655,312          | 2,404,244          | 2,114,621          |
| VW             | 14,958,968         | 12,789,892         | 10,865,312         | 9,911,830          | 9,008,122          | 7,969,711          |
| <b>TOTAL</b>   | <b>389,145,827</b> | <b>334,603,349</b> | <b>285,802,315</b> | <b>261,141,132</b> | <b>235,898,531</b> | <b>208,235,441</b> |

**Table 12-21: Projected GHG Targets (Mg), Final Standards - Combined**

| Manufacturer   | 2027               | 2028               | 2029               | 2030               | 2031               | 2032               |
|----------------|--------------------|--------------------|--------------------|--------------------|--------------------|--------------------|
| Aston Martin   | 35,100             | 30,153             | 25,474             | 23,388             | 21,200             | 18,768             |
| BMW            | 14,088,903         | 12,020,703         | 10,195,537         | 9,336,730          | 8,430,738          | 7,441,949          |
| Ferrari        | 117,462            | 99,953             | 83,891             | 76,418             | 68,648             | 60,646             |
| Ford           | 71,694,937         | 62,003,243         | 53,082,894         | 48,590,966         | 43,806,358         | 38,697,734         |
| General Motors | 79,794,166         | 68,778,895         | 58,708,183         | 53,403,393         | 48,320,137         | 42,682,330         |
| Honda          | 41,797,273         | 35,403,485         | 30,101,111         | 27,499,929         | 24,751,166         | 21,786,523         |
| Hyundai        | 26,874,181         | 22,934,971         | 19,476,165         | 17,818,752         | 16,080,590         | 14,142,292         |
| JLR            | 2,749,749          | 2,383,910          | 2,033,684          | 1,867,948          | 1,694,722          | 1,498,537          |
| Kia            | 22,199,862         | 18,860,261         | 15,998,725         | 14,606,386         | 13,094,987         | 11,514,389         |
| Lucid          | 78,004             | 64,234             | 54,044             | 48,714             | 43,533             | 37,941             |
| Mazda          | 8,331,588          | 7,053,447          | 6,027,246          | 5,549,271          | 4,993,797          | 4,417,565          |
| McLaren        | 25,997             | 22,077             | 18,565             | 16,922             | 15,222             | 13,420             |
| Mercedes Benz  | 12,196,401         | 10,450,019         | 8,896,933          | 8,160,569          | 7,396,298          | 6,505,102          |
| Mitsubishi     | 4,588,004          | 3,911,357          | 3,336,446          | 3,068,558          | 2,760,262          | 2,436,938          |
| Nissan         | 22,117,594         | 18,747,709         | 15,914,226         | 14,463,412         | 13,017,809         | 11,461,216         |
| Rivian         | 1,250,064          | 1,077,654          | 918,242            | 807,311            | 727,744            | 638,008            |
| Stellantis     | 67,811,314         | 58,363,647         | 49,833,207         | 45,244,630         | 40,836,533         | 36,006,392         |
| Subaru         | 19,364,669         | 16,544,362         | 14,089,585         | 12,962,814         | 11,684,275         | 10,329,517         |
| Tesla          | 16,885,501         | 14,139,748         | 11,951,794         | 10,856,733         | 9,760,503          | 8,553,598          |
| Toyota         | 76,009,234         | 64,495,042         | 54,913,219         | 49,997,499         | 44,890,692         | 39,535,339         |
| Volvo          | 4,657,560          | 4,117,610          | 3,492,630          | 3,202,205          | 2,897,606          | 2,549,165          |
| VW             | 20,109,213         | 17,120,748         | 14,510,130         | 13,201,830         | 11,954,430         | 10,552,095         |
| <b>TOTAL</b>   | <b>512,776,775</b> | <b>438,623,227</b> | <b>373,661,931</b> | <b>340,804,379</b> | <b>307,247,248</b> | <b>270,879,465</b> |



**Table 12-22: Achieved GHG Levels (Mg), Final Standards - Cars**

| Manufacturer   | 2027               | 2028              | 2029              | 2030              | 2031              | 2032              |
|----------------|--------------------|-------------------|-------------------|-------------------|-------------------|-------------------|
| Aston Martin   | 24,498             | 21,358            | 18,068            | 14,875            | 14,685            | 14,482            |
| BMW            | 6,461,195          | 4,968,117         | 3,970,532         | 2,813,789         | 3,082,550         | 2,472,437         |
| Ferrari        | 185,096            | 126,408           | 126,587           | 104,950           | 90,651            | 79,963            |
| Ford           | 4,497,287          | 4,320,464         | 3,872,419         | 3,679,518         | 3,136,920         | 2,831,418         |
| General Motors | 13,667,178         | 9,259,628         | 8,112,180         | 7,688,383         | 6,577,994         | 5,629,758         |
| Honda          | 13,842,716         | 11,859,974        | 9,559,465         | 7,168,648         | 6,459,980         | 5,478,910         |
| Hyundai        | 10,295,192         | 7,961,173         | 7,331,800         | 6,449,408         | 5,623,954         | 4,852,027         |
| JLR            | 71,023             | 62,159            | 62,248            | 61,645            | 60,013            | 57,919            |
| Kia            | 7,162,874          | 5,899,605         | 5,223,460         | 4,110,088         | 3,996,119         | 3,128,986         |
| Lucid          | (6,141)            | (4,444)           | (2,935)           | (1,467)           | (826)             | (812)             |
| Mazda          | 810,721            | 522,965           | 447,689           | 444,338           | 392,232           | 349,098           |
| McLaren        | 46,798             | 32,396            | 30,677            | 24,765            | 19,001            | 16,527            |
| Mercedes Benz  | 3,484,930          | 3,286,951         | 3,019,541         | 2,544,000         | 2,691,363         | 1,951,516         |
| Mitsubishi     | 2,062,291          | 1,790,072         | 1,579,812         | 1,389,267         | 1,241,413         | 1,094,494         |
| Nissan         | 10,239,445         | 8,410,859         | 6,969,758         | 6,555,763         | 5,843,185         | 4,865,082         |
| Rivian         | -                  | -                 | -                 | -                 | -                 | -                 |
| Stellantis     | 7,220,978          | 4,543,839         | 3,393,872         | 2,701,088         | 1,959,434         | 1,794,428         |
| Subaru         | 2,601,528          | 1,666,228         | 1,381,572         | 1,245,895         | 1,118,228         | 913,343           |
| Tesla          | (725,498)          | (537,917)         | (356,023)         | (178,812)         | (101,043)         | (99,831)          |
| Toyota         | 20,107,302         | 18,304,953        | 15,336,214        | 13,136,200        | 12,808,146        | 10,541,485        |
| Volvo          | 570,465            | 415,815           | 330,298           | 456,691           | 333,769           | 289,828           |
| VW             | 4,438,491          | 4,587,175         | 3,941,254         | 3,670,671         | 3,464,982         | 2,898,104         |
| <b>TOTAL</b>   | <b>107,058,368</b> | <b>87,497,778</b> | <b>74,348,488</b> | <b>64,079,701</b> | <b>58,812,748</b> | <b>49,159,163</b> |

**Table 12-23: Achieved GHG Levels (Mg), Final Standards - Trucks**

| Manufacturer   | 2027               | 2028               | 2029               | 2030               | 2031               | 2032               |
|----------------|--------------------|--------------------|--------------------|--------------------|--------------------|--------------------|
| Aston Martin   | 25,444             | 23,132             | 20,097             | 18,968             | 15,393             | 11,492             |
| BMW            | 11,704,900         | 9,468,599          | 9,398,302          | 8,845,857          | 7,923,325          | 6,387,980          |
| Ferrari        | -                  | -                  | -                  | -                  | -                  | -                  |
| Ford           | 77,624,297         | 70,670,795         | 60,214,482         | 54,217,512         | 45,599,501         | 40,703,728         |
| General Motors | 79,878,284         | 76,180,702         | 65,579,504         | 58,005,622         | 48,963,997         | 39,669,072         |
| Honda          | 28,273,952         | 26,328,688         | 24,401,552         | 22,653,942         | 19,192,441         | 16,776,753         |
| Hyundai        | 17,128,917         | 15,590,153         | 13,781,418         | 12,116,250         | 10,397,326         | 9,430,151          |
| JLR            | 3,577,889          | 3,236,111          | 2,771,838          | 2,441,032          | 2,152,258          | 1,903,089          |
| Kia            | 15,810,457         | 14,862,241         | 13,297,533         | 12,226,270         | 9,386,834          | 8,551,331          |
| Lucid          | -                  | -                  | -                  | -                  | -                  | -                  |
| Mazda          | 8,452,405          | 7,860,583          | 6,940,423          | 6,055,284          | 5,235,981          | 4,615,716          |
| McLaren        | -                  | -                  | -                  | -                  | -                  | -                  |
| Mercedes Benz  | 10,229,762         | 9,358,663          | 8,272,110          | 6,910,500          | 5,564,882          | 5,204,788          |
| Mitsubishi     | 2,918,464          | 2,236,904          | 1,998,557          | 1,805,319          | 1,593,545          | 1,436,887          |
| Nissan         | 14,124,693         | 13,077,052         | 12,190,645         | 9,652,389          | 7,913,675          | 6,899,578          |
| Rivian         | (88,260)           | (65,845)           | (44,615)           | (21,801)           | (12,746)           | (12,632)           |
| Stellantis     | 75,738,260         | 70,704,136         | 61,630,236         | 53,994,008         | 45,741,767         | 38,859,096         |
| Subaru         | 18,995,804         | 17,824,632         | 15,755,329         | 13,783,177         | 12,089,255         | 10,781,269         |
| Tesla          | (654,749)          | (486,740)          | (328,085)          | (160,255)          | (93,673)           | (92,808)           |
| Toyota         | 59,351,190         | 51,546,443         | 47,204,764         | 40,300,061         | 33,780,576         | 29,626,313         |
| Volvo          | 3,473,409          | 3,564,928          | 3,238,724          | 2,780,618          | 2,755,386          | 2,579,669          |
| VW             | 17,324,288         | 14,846,142         | 12,078,304         | 10,938,364         | 9,370,015          | 8,836,461          |
| <b>TOTAL</b>   | <b>443,889,405</b> | <b>406,827,321</b> | <b>358,401,119</b> | <b>316,563,117</b> | <b>267,569,739</b> | <b>232,167,934</b> |

**Table 12-24: Achieved GHG Levels (Mg), Final Standards - Combined**

| Manufacturer   | 2027               | 2028               | 2029               | 2030               | 2031               | 2032               |
|----------------|--------------------|--------------------|--------------------|--------------------|--------------------|--------------------|
| Aston Martin   | 49,941             | 44,490             | 38,165             | 33,843             | 30,078             | 25,974             |
| BMW            | 18,166,096         | 14,436,716         | 13,368,834         | 11,659,646         | 11,005,875         | 8,860,417          |
| Ferrari        | 185,096            | 126,408            | 126,587            | 104,950            | 90,651             | 79,963             |
| Ford           | 82,121,584         | 74,991,259         | 64,086,901         | 57,897,030         | 48,736,421         | 43,535,146         |
| General Motors | 93,545,462         | 85,440,330         | 73,691,684         | 65,694,005         | 55,541,991         | 45,298,830         |
| Honda          | 42,116,669         | 38,188,663         | 33,961,018         | 29,822,590         | 25,652,420         | 22,255,662         |
| Hyundai        | 27,424,109         | 23,551,327         | 21,113,219         | 18,565,657         | 16,021,280         | 14,282,178         |
| JLR            | 3,648,911          | 3,298,270          | 2,834,086          | 2,502,678          | 2,212,271          | 1,961,007          |
| Kia            | 22,973,330         | 20,761,846         | 18,520,993         | 16,336,358         | 13,382,953         | 11,680,317         |
| Lucid          | (6,141)            | (4,444)            | (2,935)            | (1,467)            | (826)              | (812)              |
| Mazda          | 9,263,127          | 8,383,548          | 7,388,112          | 6,499,622          | 5,628,213          | 4,964,814          |
| McLaren        | 46,798             | 32,396             | 30,677             | 24,765             | 19,001             | 16,527             |
| Mercedes Benz  | 13,714,692         | 12,645,614         | 11,291,651         | 9,454,499          | 8,256,246          | 7,156,305          |
| Mitsubishi     | 4,980,755          | 4,026,975          | 3,578,369          | 3,194,586          | 2,834,958          | 2,531,382          |
| Nissan         | 24,364,138         | 21,487,911         | 19,160,403         | 16,208,152         | 13,756,860         | 11,764,661         |
| Rivian         | (88,260)           | (65,845)           | (44,615)           | (21,801)           | (12,746)           | (12,632)           |
| Stellantis     | 82,959,238         | 75,247,975         | 65,024,109         | 56,695,095         | 47,701,201         | 40,653,524         |
| Subaru         | 21,597,332         | 19,490,860         | 17,136,900         | 15,029,072         | 13,207,483         | 11,694,612         |
| Tesla          | (1,380,247)        | (1,024,657)        | (684,108)          | (339,067)          | (194,715)          | (192,639)          |
| Toyota         | 79,458,492         | 69,851,396         | 62,540,978         | 53,436,262         | 46,588,722         | 40,167,798         |
| Volvo          | 4,043,874          | 3,980,743          | 3,569,022          | 3,237,309          | 3,089,155          | 2,869,497          |
| VW             | 21,762,779         | 19,433,317         | 16,019,558         | 14,609,035         | 12,834,996         | 11,734,565         |
| <b>TOTAL</b>   | <b>550,947,774</b> | <b>494,325,098</b> | <b>432,749,607</b> | <b>380,642,818</b> | <b>326,382,487</b> | <b>281,327,097</b> |

**Table 12-25: GHG Credits/Debits Earned (Mg), Final Standards - Combined**

| Manufacturer   | 2027              | 2028             | 2029              | 2030             | 2031             | 2032               |
|----------------|-------------------|------------------|-------------------|------------------|------------------|--------------------|
| Aston Martin   | (12,087)          | (10,713)         | (8,107)           | (7,587)          | (7,623)          | (7,200)            |
| BMW            | (2,707,269)       | (775,332)        | (1,232,020)       | (1,068,017)      | (2,051,331)      | (1,406,323)        |
| Ferrari        | (63,315)          | (18,198)         | (30,721)          | (21,221)         | (18,579)         | (19,188)           |
| Ford           | (2,004,876)       | (3,621,182)      | (281,312)         | (2,454,008)      | (1,784,047)      | (4,690,852)        |
| General Motors | (4,791,101)       | (6,713,862)      | (3,416,546)       | (4,870,901)      | (4,037,945)      | (2,591,053)        |
| Honda          | 3,657,510         | 2,042,151        | 1,843,918         | 1,301,140        | 693,034          | (443,257)          |
| Hyundai        | 1,822,363         | 2,334,033        | 1,967,207         | 1,581,905        | 1,078,311        | (116,741)          |
| JLR            | (559,275)         | (544,667)        | (378,198)         | (360,833)        | (400,931)        | (463,552)          |
| Kia            | 1,320,899         | 653,202          | 515,123           | 213,624          | 559,212          | (149,475)          |
| Lucid          | 87,001            | 73,939           | 64,674            | 54,859           | 46,560           | 38,753             |
| Mazda          | 84,271            | (164,194)        | (59,762)          | (93,431)         | (257,639)        | (524,815)          |
| McLaren        | (19,846)          | (8,513)          | (9,480)           | (6,216)          | (3,012)          | (3,107)            |
| Mercedes Benz  | (354,066)         | (746,882)        | (673,315)         | (179,237)        | (372,265)        | (640,867)          |
| Mitsubishi     | 28,523            | 405,984          | 380,696           | 278,242          | 106,926          | (84,079)           |
| Nissan         | (348,015)         | (324,427)        | (349,443)         | 118,930          | 111,390          | (270,919)          |
| Rivian         | 1,499,464         | 1,318,253        | 1,159,273         | 951,147          | 791,805          | 650,639            |
| Stellantis     | (6,878,417)       | (7,847,274)      | (4,842,797)       | (4,750,583)      | (4,013,766)      | (4,643,651)        |
| Subaru         | 124,019           | (359,898)        | (59,932)          | (114,022)        | (669,430)        | (1,310,413)        |
| Tesla          | 19,606,375        | 16,842,938       | 14,729,264        | 12,514,252       | 10,538,531       | 8,746,237          |
| Toyota         | 4,084,997         | 3,834,261        | 2,921,352         | 3,283,567        | 1,445,407        | (432,744)          |
| Volvo          | 1,120,959         | 608,867          | 518,825           | 345,891          | (55,415)         | (363,587)          |
| VW             | 473,635           | 169,114          | 1,380,435         | 526,313          | (56,716)         | (1,171,745)        |
| <b>TOTAL</b>   | <b>16,171,752</b> | <b>7,147,601</b> | <b>14,139,135</b> | <b>7,243,816</b> | <b>1,642,479</b> | <b>(9,897,938)</b> |

### 12.1.1.2.2 Alternative A

OEM-specific GHG emissions targets for Alternative A (in Mg) are shown in Table 12-26, Table 12-27, and Table 12-28 for cars, trucks, and the combined fleet, respectively. Projected achieved GHG emissions (in Mg) are given for cars, trucks, and the combined fleet in Table 12-29, Table 12-30, and Table 12-31. Overall credits or debits earned are provided for the combined fleet on a manufacturer-specific basis, in Table 12-31.

**Table 12-26: Projected GHG Targets (Mg), Alternative A - Cars**

| Manufacturer   | 2027               | 2028               | 2029              | 2030              | 2031              | 2032              |
|----------------|--------------------|--------------------|-------------------|-------------------|-------------------|-------------------|
| Aston Martin   | 17,704             | 15,112             | 12,723            | 11,580            | 10,414            | 9,194             |
| BMW            | 4,811,426          | 4,066,442          | 3,427,719         | 3,106,950         | 2,788,695         | 2,457,118         |
| Ferrari        | 117,462            | 99,953             | 83,891            | 76,418            | 68,648            | 60,646            |
| Ford           | 5,122,916          | 4,355,612          | 3,698,790         | 3,369,716         | 3,032,682         | 2,677,299         |
| General Motors | 13,284,773         | 11,284,883         | 9,566,422         | 8,707,816         | 7,843,291         | 6,910,093         |
| Honda          | 15,874,797         | 13,272,593         | 11,204,051        | 10,151,855        | 9,079,013         | 7,952,824         |
| Hyundai        | 11,089,685         | 9,368,311          | 7,926,394         | 7,214,834         | 6,469,315         | 5,675,214         |
| JLR            | 58,154             | 49,142             | 41,335            | 37,542            | 33,686            | 29,607            |
| Kia            | 8,579,222          | 7,218,552          | 6,082,894         | 5,515,206         | 4,909,553         | 4,295,147         |
| Lucid          | 78,004             | 64,234             | 54,044            | 48,714            | 43,533            | 37,941            |
| Mazda          | 895,285            | 742,414            | 626,711           | 569,712           | 507,736           | 446,329           |
| McLaren        | 25,997             | 22,077             | 18,565            | 16,922            | 15,222            | 13,420            |
| Mercedes Benz  | 3,233,771          | 2,735,938          | 2,314,221         | 2,105,443         | 1,893,083         | 1,666,097         |
| Mitsubishi     | 2,142,649          | 1,814,980          | 1,543,394         | 1,413,520         | 1,268,148         | 1,116,610         |
| Nissan         | 10,791,762         | 9,050,117          | 7,621,301         | 6,886,246         | 6,169,729         | 5,415,448         |
| Rivian         | -                  | -                  | -                 | -                 | -                 | -                 |
| Stellantis     | 5,222,346          | 4,383,358          | 3,689,782         | 3,326,669         | 2,979,279         | 2,616,512         |
| Subaru         | 2,321,298          | 1,944,516          | 1,633,929         | 1,485,516         | 1,325,755         | 1,163,655         |
| Tesla          | 9,080,496          | 7,669,414          | 6,467,854         | 5,856,666         | 5,254,182         | 4,604,033         |
| Toyota         | 24,889,453         | 20,822,532         | 17,601,163        | 15,925,030        | 14,217,084        | 12,479,907        |
| Volvo          | 843,504            | 708,844            | 599,614           | 546,893           | 493,362           | 434,544           |
| VW             | 5,150,246          | 4,330,856          | 3,644,818         | 3,290,000         | 2,946,308         | 2,582,385         |
| <b>TOTAL</b>   | <b>123,630,948</b> | <b>104,019,879</b> | <b>87,859,616</b> | <b>79,663,247</b> | <b>71,348,717</b> | <b>62,644,024</b> |

**Table 12-27: Projected GHG Targets (Mg), Alternative A - Trucks**

| Manufacturer   | 2027               | 2028               | 2029               | 2030               | 2031               | 2032               |
|----------------|--------------------|--------------------|--------------------|--------------------|--------------------|--------------------|
| Aston Martin   | 17,396             | 15,041             | 12,751             | 11,808             | 10,786             | 9,575              |
| BMW            | 9,277,477          | 7,954,260          | 6,767,818          | 6,229,780          | 5,642,042          | 4,984,831          |
| Ferrari        | -                  | -                  | -                  | -                  | -                  | -                  |
| Ford           | 66,572,021         | 57,647,631         | 49,384,104         | 45,221,251         | 40,773,677         | 36,020,435         |
| General Motors | 66,509,393         | 57,494,012         | 49,141,761         | 44,695,577         | 40,476,847         | 35,772,236         |
| Honda          | 25,922,475         | 22,130,892         | 18,897,061         | 17,348,074         | 15,672,154         | 13,833,699         |
| Hyundai        | 15,784,497         | 13,566,659         | 11,549,771         | 10,603,918         | 9,611,275          | 8,467,078          |
| JLR            | 2,691,596          | 2,334,768          | 1,992,349          | 1,830,406          | 1,661,035          | 1,468,931          |
| Kia            | 13,620,640         | 11,641,709         | 9,915,831          | 9,091,180          | 8,185,434          | 7,219,243          |
| Lucid          | -                  | -                  | -                  | -                  | -                  | -                  |
| Mazda          | 7,436,302          | 6,311,034          | 5,400,534          | 4,979,559          | 4,486,060          | 3,971,235          |
| McLaren        | -                  | -                  | -                  | -                  | -                  | -                  |
| Mercedes Benz  | 8,962,631          | 7,714,081          | 6,582,712          | 6,055,126          | 5,503,215          | 4,839,005          |
| Mitsubishi     | 2,445,355          | 2,096,377          | 1,793,052          | 1,655,038          | 1,492,114          | 1,320,328          |
| Nissan         | 11,325,833         | 9,697,592          | 8,292,925          | 7,577,166          | 6,848,080          | 6,045,768          |
| Rivian         | 1,250,064          | 1,077,654          | 918,242            | 807,311            | 727,744            | 638,008            |
| Stellantis     | 62,588,968         | 53,980,289         | 46,143,424         | 41,917,961         | 37,857,253         | 33,389,881         |
| Subaru         | 17,043,371         | 14,599,846         | 12,455,656         | 11,477,299         | 10,358,520         | 9,165,862          |
| Tesla          | 7,805,005          | 6,470,334          | 5,483,939          | 5,000,067          | 4,506,321          | 3,949,565          |
| Toyota         | 51,119,780         | 43,672,510         | 37,312,056         | 34,072,469         | 30,673,607         | 27,055,432         |
| Volvo          | 3,814,056          | 3,408,766          | 2,893,016          | 2,655,312          | 2,404,244          | 2,114,621          |
| VW             | 14,958,968         | 12,789,892         | 10,865,312         | 9,911,830          | 9,008,122          | 7,969,711          |
| <b>TOTAL</b>   | <b>389,145,827</b> | <b>334,603,349</b> | <b>285,802,315</b> | <b>261,141,132</b> | <b>235,898,531</b> | <b>208,235,441</b> |

**Table 12-28: Projected GHG Targets (Mg), Alternative A - Combined**

| Manufacturer   | 2027               | 2028               | 2029               | 2030               | 2031               | 2032               |
|----------------|--------------------|--------------------|--------------------|--------------------|--------------------|--------------------|
| Aston Martin   | 35,100             | 30,153             | 25,474             | 23,388             | 21,200             | 18,768             |
| BMW            | 14,088,903         | 12,020,703         | 10,195,537         | 9,336,730          | 8,430,738          | 7,441,949          |
| Ferrari        | 117,462            | 99,953             | 83,891             | 76,418             | 68,648             | 60,646             |
| Ford           | 71,694,937         | 62,003,243         | 53,082,894         | 48,590,966         | 43,806,358         | 38,697,734         |
| General Motors | 79,794,166         | 68,778,895         | 58,708,183         | 53,403,393         | 48,320,137         | 42,682,330         |
| Honda          | 41,797,273         | 35,403,485         | 30,101,111         | 27,499,929         | 24,751,166         | 21,786,523         |
| Hyundai        | 26,874,181         | 22,934,971         | 19,476,165         | 17,818,752         | 16,080,590         | 14,142,292         |
| JLR            | 2,749,749          | 2,383,910          | 2,033,684          | 1,867,948          | 1,694,722          | 1,498,537          |
| Kia            | 22,199,862         | 18,860,261         | 15,998,725         | 14,606,386         | 13,094,987         | 11,514,389         |
| Lucid          | 78,004             | 64,234             | 54,044             | 48,714             | 43,533             | 37,941             |
| Mazda          | 8,331,588          | 7,053,447          | 6,027,246          | 5,549,271          | 4,993,797          | 4,417,565          |
| McLaren        | 25,997             | 22,077             | 18,565             | 16,922             | 15,222             | 13,420             |
| Mercedes Benz  | 12,196,401         | 10,450,019         | 8,896,933          | 8,160,569          | 7,396,298          | 6,505,102          |
| Mitsubishi     | 4,588,004          | 3,911,357          | 3,336,446          | 3,068,558          | 2,760,262          | 2,436,938          |
| Nissan         | 22,117,594         | 18,747,709         | 15,914,226         | 14,463,412         | 13,017,809         | 11,461,216         |
| Rivian         | 1,250,064          | 1,077,654          | 918,242            | 807,311            | 727,744            | 638,008            |
| Stellantis     | 67,811,314         | 58,363,647         | 49,833,207         | 45,244,630         | 40,836,533         | 36,006,392         |
| Subaru         | 19,364,669         | 16,544,362         | 14,089,585         | 12,962,814         | 11,684,275         | 10,329,517         |
| Tesla          | 16,885,501         | 14,139,748         | 11,951,794         | 10,856,733         | 9,760,503          | 8,553,598          |
| Toyota         | 76,009,234         | 64,495,042         | 54,913,219         | 49,997,499         | 44,890,692         | 39,535,339         |
| Volvo          | 4,657,560          | 4,117,610          | 3,492,630          | 3,202,205          | 2,897,606          | 2,549,165          |
| VW             | 20,109,213         | 17,120,748         | 14,510,130         | 13,201,830         | 11,954,430         | 10,552,095         |
| <b>TOTAL</b>   | <b>512,776,775</b> | <b>438,623,227</b> | <b>373,661,931</b> | <b>340,804,379</b> | <b>307,247,248</b> | <b>270,879,465</b> |

**Table 12-29: Achieved GHG Levels (Mg), Alternative A - Cars**

| Manufacturer   | 2027               | 2028              | 2029              | 2030              | 2031              | 2032              |
|----------------|--------------------|-------------------|-------------------|-------------------|-------------------|-------------------|
| Aston Martin   | 24,196             | 17,828            | 14,391            | 12,489            | 11,482            | 10,433            |
| BMW            | 6,620,403          | 4,332,500         | 3,730,298         | 3,642,928         | 2,931,843         | 2,163,617         |
| Ferrari        | 198,680            | 131,579           | 124,112           | 102,831           | 85,465            | 77,729            |
| Ford           | 4,382,640          | 3,975,711         | 3,434,000         | 2,892,694         | 2,832,372         | 2,490,976         |
| General Motors | 13,622,587         | 10,992,458        | 9,267,250         | 8,539,349         | 8,383,835         | 7,311,169         |
| Honda          | 13,544,529         | 10,386,138        | 8,548,891         | 7,468,971         | 5,789,957         | 4,991,378         |
| Hyundai        | 10,140,495         | 8,469,385         | 7,519,471         | 6,531,045         | 5,762,619         | 4,527,623         |
| JLR            | 64,066             | 43,150            | 49,069            | 43,722            | 37,441            | 31,604            |
| Kia            | 7,217,169          | 5,205,112         | 4,218,848         | 3,550,087         | 3,108,606         | 2,520,883         |
| Lucid          | (893)              | (857)             | (854)             | (838)             | (826)             | (812)             |
| Mazda          | 819,778            | 492,657           | 365,193           | 326,216           | 204,799           | 263,286           |
| McLaren        | 48,252             | 31,848            | 29,950            | 23,887            | 19,089            | 16,955            |
| Mercedes Benz  | 3,215,233          | 2,496,990         | 2,275,823         | 2,110,879         | 2,044,083         | 1,577,148         |
| Mitsubishi     | 1,870,259          | 1,501,960         | 1,334,380         | 1,223,947         | 1,090,162         | 935,236           |
| Nissan         | 10,263,508         | 7,855,083         | 7,032,888         | 6,169,637         | 5,006,278         | 4,231,581         |
| Rivian         | -                  | -                 | -                 | -                 | -                 | -                 |
| Stellantis     | 6,434,195          | 4,995,574         | 4,228,153         | 4,376,071         | 3,768,652         | 3,573,156         |
| Subaru         | 2,520,301          | 1,904,576         | 1,741,859         | 1,620,893         | 1,465,549         | 1,093,005         |
| Tesla          | (105,527)          | (103,695)         | (103,570)         | (102,178)         | (101,043)         | (99,831)          |
| Toyota         | 21,042,279         | 15,325,199        | 13,392,983        | 13,468,484        | 10,734,926        | 8,721,522         |
| Volvo          | 506,528            | 591,710           | 501,881           | 533,234           | 460,566           | 389,168           |
| VW             | 5,209,920          | 3,929,395         | 3,238,889         | 2,711,836         | 2,592,686         | 2,600,071         |
| <b>TOTAL</b>   | <b>107,638,598</b> | <b>82,574,302</b> | <b>70,943,905</b> | <b>65,246,182</b> | <b>56,228,541</b> | <b>47,425,898</b> |

**Table 12-30: Achieved GHG Levels (Mg), Alternative A - Trucks**

| Manufacturer   | 2027               | 2028               | 2029               | 2030               | 2031               | 2032               |
|----------------|--------------------|--------------------|--------------------|--------------------|--------------------|--------------------|
| Aston Martin   | 23,205             | 20,393             | 20,012             | 16,524             | 13,043             | 11,166             |
| BMW            | 11,034,411         | 8,172,295          | 7,809,117          | 6,407,002          | 5,877,902          | 5,646,276          |
| Ferrari        | -                  | -                  | -                  | -                  | -                  | -                  |
| Ford           | 75,394,625         | 61,959,107         | 52,419,717         | 49,187,915         | 43,863,165         | 39,825,691         |
| General Motors | 78,408,524         | 64,499,169         | 53,912,619         | 48,305,389         | 45,000,534         | 39,722,596         |
| Honda          | 26,170,008         | 22,891,750         | 21,522,096         | 19,065,427         | 17,072,232         | 14,611,900         |
| Hyundai        | 15,380,303         | 12,536,689         | 11,549,446         | 10,351,865         | 8,773,490          | 7,883,467          |
| JLR            | 3,236,638          | 2,573,424          | 2,283,027          | 2,075,932          | 1,827,751          | 1,578,115          |
| Kia            | 14,215,134         | 13,058,259         | 12,288,573         | 11,040,809         | 9,362,164          | 8,085,282          |
| Lucid          | -                  | -                  | -                  | -                  | -                  | -                  |
| Mazda          | 7,644,354          | 5,995,401          | 5,490,585          | 5,103,118          | 4,406,229          | 3,734,936          |
| McLaren        | -                  | -                  | -                  | -                  | -                  | -                  |
| Mercedes Benz  | 9,571,172          | 8,493,769          | 7,595,787          | 6,741,393          | 5,743,452          | 5,030,786          |
| Mitsubishi     | 2,594,701          | 2,074,235          | 1,865,032          | 1,716,803          | 1,503,557          | 1,290,796          |
| Nissan         | 13,760,138         | 11,537,885         | 9,937,743          | 8,385,197          | 7,829,047          | 6,964,732          |
| Rivian         | (12,791)           | (12,785)           | (12,932)           | (12,824)           | (12,746)           | (12,632)           |
| Stellantis     | 74,896,622         | 59,753,621         | 50,528,462         | 44,151,946         | 41,315,274         | 36,374,037         |
| Subaru         | 17,075,140         | 14,165,462         | 11,961,831         | 10,838,931         | 9,125,381          | 8,261,270          |
| Tesla          | (94,891)           | (94,513)           | (95,097)           | (94,268)           | (93,673)           | (92,808)           |
| Toyota         | 56,201,589         | 47,611,412         | 43,179,671         | 35,515,971         | 32,006,898         | 28,757,320         |
| Volvo          | 3,660,968          | 2,990,183          | 2,781,591          | 2,491,990          | 2,272,408          | 2,055,207          |
| VW             | 15,051,351         | 12,522,240         | 11,777,292         | 10,765,750         | 8,549,697          | 7,312,638          |
| <b>TOTAL</b>   | <b>424,211,202</b> | <b>350,747,997</b> | <b>306,814,573</b> | <b>272,054,870</b> | <b>244,435,803</b> | <b>217,040,776</b> |

**Table 12-31: Achieved GHG Levels (Mg), Alternative A - Combined**

| Manufacturer   | 2027               | 2028               | 2029               | 2030               | 2031               | 2032               |
|----------------|--------------------|--------------------|--------------------|--------------------|--------------------|--------------------|
| Aston Martin   | 47,401             | 38,220             | 34,403             | 29,013             | 24,525             | 21,599             |
| BMW            | 17,654,814         | 12,504,795         | 11,539,415         | 10,049,930         | 8,809,745          | 7,809,893          |
| Ferrari        | 198,680            | 131,579            | 124,112            | 102,831            | 85,465             | 77,729             |
| Ford           | 79,777,265         | 65,934,819         | 55,853,717         | 52,080,609         | 46,695,536         | 42,316,666         |
| General Motors | 92,031,111         | 75,491,628         | 63,179,869         | 56,844,738         | 53,384,370         | 47,033,765         |
| Honda          | 39,714,537         | 33,277,888         | 30,070,987         | 26,534,398         | 22,862,189         | 19,603,279         |
| Hyundai        | 25,520,798         | 21,006,074         | 19,068,917         | 16,882,910         | 14,536,109         | 12,411,090         |
| JLR            | 3,300,704          | 2,616,574          | 2,332,096          | 2,119,655          | 1,865,192          | 1,609,719          |
| Kia            | 21,432,303         | 18,263,370         | 16,507,422         | 14,590,896         | 12,470,770         | 10,606,165         |
| Lucid          | (893)              | (857)              | (854)              | (838)              | (826)              | (812)              |
| Mazda          | 8,464,132          | 6,488,058          | 5,855,779          | 5,429,333          | 4,611,028          | 3,998,222          |
| McLaren        | 48,252             | 31,848             | 29,950             | 23,887             | 19,089             | 16,955             |
| Mercedes Benz  | 12,786,406         | 10,990,759         | 9,871,610          | 8,852,271          | 7,787,535          | 6,607,934          |
| Mitsubishi     | 4,464,960          | 3,576,195          | 3,199,412          | 2,940,749          | 2,593,718          | 2,226,032          |
| Nissan         | 24,023,646         | 19,392,968         | 16,970,631         | 14,554,834         | 12,835,325         | 11,196,314         |
| Rivian         | (12,791)           | (12,785)           | (12,932)           | (12,824)           | (12,746)           | (12,632)           |
| Stellantis     | 81,330,817         | 64,749,194         | 54,756,615         | 48,528,017         | 45,083,926         | 39,947,193         |
| Subaru         | 19,595,441         | 16,070,038         | 13,703,690         | 12,459,824         | 10,590,930         | 9,354,275          |
| Tesla          | (200,418)          | (198,207)          | (198,667)          | (196,446)          | (194,715)          | (192,639)          |
| Toyota         | 77,243,869         | 62,936,611         | 56,572,655         | 48,984,455         | 42,741,824         | 37,478,842         |
| Volvo          | 4,167,497          | 3,581,894          | 3,283,472          | 3,025,225          | 2,732,974          | 2,444,376          |
| VW             | 20,261,271         | 16,451,634         | 15,016,180         | 13,477,587         | 11,142,382         | 9,912,708          |
| <b>TOTAL</b>   | <b>531,849,800</b> | <b>433,322,298</b> | <b>377,758,478</b> | <b>337,301,053</b> | <b>300,664,344</b> | <b>264,466,674</b> |

**Table 12-32: GHG Credits/Debits Earned (Mg), Alternative A - Combined**

| Manufacturer   | 2027                | 2028             | 2029               | 2030             | 2031             | 2032             |
|----------------|---------------------|------------------|--------------------|------------------|------------------|------------------|
| Aston Martin   | (12,301)            | (8,067)          | (8,930)            | (5,625)          | (3,325)          | (2,830)          |
| BMW            | (3,565,911)         | (484,092)        | (1,343,878)        | (713,199)        | (379,007)        | (367,943)        |
| Ferrari        | (81,218)            | (31,627)         | (40,221)           | (26,413)         | (16,817)         | (17,083)         |
| Ford           | (8,082,328)         | (3,931,576)      | (2,770,822)        | (3,489,643)      | (2,889,178)      | (3,618,932)      |
| General Motors | (12,236,945)        | (6,712,733)      | (4,471,686)        | (3,441,345)      | (5,064,232)      | (4,351,435)      |
| Honda          | 2,082,735           | 2,125,597        | 30,124             | 965,531          | 1,888,977        | 2,183,244        |
| Hyundai        | 1,353,383           | 1,928,896        | 407,248            | 935,842          | 1,544,481        | 1,731,202        |
| JLR            | (550,954)           | (232,664)        | (298,412)          | (251,706)        | (170,470)        | (111,182)        |
| Kia            | 767,559             | 596,891          | (508,696)          | 15,489           | 624,217          | 908,224          |
| Lucid          | 78,897              | 65,090           | 54,898             | 49,552           | 44,359           | 38,753           |
| Mazda          | (132,544)           | 565,389          | 171,467            | 119,938          | 382,768          | 419,342          |
| McLaren        | (22,255)            | (9,771)          | (11,385)           | (6,965)          | (3,867)          | (3,535)          |
| Mercedes Benz  | (590,004)           | (540,740)        | (974,677)          | (691,702)        | (391,237)        | (102,832)        |
| Mitsubishi     | 123,044             | 335,162          | 137,034            | 127,809          | 166,543          | 210,906          |
| Nissan         | (1,906,052)         | (645,259)        | (1,056,405)        | (91,422)         | 182,484          | 264,902          |
| Rivian         | 1,262,855           | 1,090,439        | 931,174            | 820,135          | 740,490          | 650,639          |
| Stellantis     | (13,519,503)        | (6,385,547)      | (4,923,408)        | (3,283,386)      | (4,247,394)      | (3,940,801)      |
| Subaru         | (230,772)           | 474,324          | 385,895            | 502,991          | 1,093,345        | 975,242          |
| Tesla          | 17,085,919          | 14,337,955       | 12,150,461         | 11,053,179       | 9,955,218        | 8,746,237        |
| Toyota         | (1,234,635)         | 1,558,431        | (1,659,436)        | 1,013,044        | 2,148,868        | 2,056,497        |
| Volvo          | 490,063             | 535,717          | 209,158            | 176,981          | 164,633          | 104,789          |
| VW             | (152,058)           | 669,114          | (506,050)          | (275,757)        | 812,047          | 639,387          |
| <b>TOTAL</b>   | <b>(19,073,025)</b> | <b>5,300,929</b> | <b>(4,096,547)</b> | <b>3,503,326</b> | <b>6,582,904</b> | <b>6,412,791</b> |

### 12.1.1.2.3 Alternative B

OEM-specific GHG emissions targets for Alternative B (in Mg) are shown in Table 12-33, Table 12-34, and Table 12-35 for cars, trucks, and the combined fleet, respectively. Projected achieved GHG emissions (in Mg) are given for cars, trucks, and the combined fleet in Table 12-36, Table 12-37 and Table 12-38. Overall credits or debits earned are provided for the combined fleet on a manufacturer-specific basis, in Table 12-39.

**Table 12-33: Projected GHG Targets (Mg), Alternative B - Cars**

| Manufacturer   | 2027               | 2028               | 2029               | 2030              | 2031              | 2032              |
|----------------|--------------------|--------------------|--------------------|-------------------|-------------------|-------------------|
| Aston Martin   | 18,364             | 16,355             | 14,527             | 12,693            | 11,519            | 10,407            |
| BMW            | 5,014,624          | 4,431,554          | 3,940,841          | 3,439,193         | 3,105,050         | 2,788,030         |
| Ferrari        | 121,781            | 108,197            | 96,097             | 83,439            | 76,060            | 68,811            |
| Ford           | 5,310,198          | 4,722,537          | 4,224,772          | 3,693,627         | 3,363,287         | 3,036,754         |
| General Motors | 13,796,598         | 12,263,910         | 10,956,595         | 9,568,952         | 8,686,978         | 7,846,696         |
| Honda          | 16,550,350         | 14,484,669         | 12,856,683         | 11,183,968        | 10,074,102        | 9,033,468         |
| Hyundai        | 11,532,691         | 10,208,726         | 9,076,994          | 7,927,415         | 7,191,835         | 6,466,301         |
| JLR            | 60,417             | 53,445             | 47,335             | 41,239            | 37,330            | 33,530            |
| Kia            | 8,949,899          | 7,865,057          | 6,978,863          | 6,078,557         | 5,454,675         | 4,875,507         |
| Lucid          | 80,860             | 69,495             | 61,739             | 53,392            | 48,141            | 42,925            |
| Mazda          | 937,477            | 817,567            | 723,943            | 630,664           | 566,814           | 509,384           |
| McLaren        | 26,952             | 23,893             | 21,211             | 18,537            | 16,833            | 15,201            |
| Mercedes Benz  | 3,355,463          | 2,974,796          | 2,649,233          | 2,309,635         | 2,095,615         | 1,891,147         |
| Mitsubishi     | 2,243,890          | 1,993,394          | 1,779,737          | 1,563,291         | 1,414,825         | 1,274,392         |
| Nissan         | 11,235,160         | 9,877,112          | 8,757,056          | 7,607,251         | 6,865,028         | 6,156,892         |
| Rivian         | -                  | -                  | -                  | -                 | -                 | -                 |
| Stellantis     | 5,426,308          | 4,779,135          | 4,244,444          | 3,671,607         | 3,314,232         | 2,977,737         |
| Subaru         | 2,431,214          | 2,133,816          | 1,888,000          | 1,645,871         | 1,482,446         | 1,326,570         |
| Tesla          | 9,415,009          | 8,298,704          | 7,388,181          | 6,419,294         | 5,810,561         | 5,209,894         |
| Toyota         | 25,923,626         | 22,773,448         | 20,202,984         | 17,552,287        | 15,783,267        | 14,200,732        |
| Volvo          | 873,324            | 772,849            | 689,358            | 603,159           | 548,262           | 494,623           |
| VW             | 5,388,004          | 4,736,067          | 4,177,375          | 3,646,041         | 3,279,444         | 2,936,364         |
| <b>TOTAL</b>   | <b>128,692,206</b> | <b>113,404,725</b> | <b>100,775,968</b> | <b>87,750,113</b> | <b>79,226,304</b> | <b>71,195,364</b> |

**Table 12-34: Projected GHG Targets (Mg), Alternative B - Trucks**

| Manufacturer   | 2027               | 2028               | 2029               | 2030               | 2031               | 2032               |
|----------------|--------------------|--------------------|--------------------|--------------------|--------------------|--------------------|
| Aston Martin   | 19,485             | 17,384             | 15,444             | 13,472             | 12,098             | 10,660             |
| BMW            | 10,444,228         | 9,169,951          | 8,151,405          | 7,107,061          | 6,320,162          | 5,543,206          |
| Ferrari        | -                  | -                  | -                  | -                  | -                  | -                  |
| Ford           | 74,792,135         | 66,638,053         | 59,544,850         | 51,774,739         | 46,060,313         | 40,355,631         |
| General Motors | 74,942,023         | 66,467,901         | 59,323,475         | 51,259,533         | 45,499,491         | 39,824,146         |
| Honda          | 29,224,238         | 25,754,178         | 22,974,828         | 19,964,640         | 17,727,735         | 15,458,712         |
| Hyundai        | 17,713,855         | 15,738,890         | 13,968,445         | 12,150,910         | 10,848,736         | 9,493,299          |
| JLR            | 3,035,956          | 2,711,262          | 2,407,915          | 2,100,156          | 1,868,649          | 1,635,349          |
| Kia            | 15,343,939         | 13,531,508         | 12,044,471         | 10,470,018         | 9,268,297          | 8,087,284          |
| Lucid          | -                  | -                  | -                  | -                  | -                  | -                  |
| Mazda          | 8,409,914          | 7,413,507          | 6,614,633          | 5,783,913          | 5,104,585          | 4,464,962          |
| McLaren        | -                  | -                  | -                  | -                  | -                  | -                  |
| Mercedes Benz  | 10,002,461         | 8,901,503          | 7,908,243          | 6,885,141          | 6,148,366          | 5,400,393          |
| Mitsubishi     | 2,765,383          | 2,453,363          | 2,188,333          | 1,916,804          | 1,693,827          | 1,481,498          |
| Nissan         | 12,782,525         | 11,288,527         | 10,059,416         | 8,704,434          | 7,708,427          | 6,732,780          |
| Rivian         | 1,411,205          | 1,252,409          | 1,114,658          | 929,346            | 821,045            | 711,980            |
| Stellantis     | 70,652,605         | 62,679,696         | 55,955,455         | 48,213,787         | 42,719,770         | 37,287,614         |
| Subaru         | 19,290,132         | 17,053,794         | 15,232,449         | 13,309,221         | 11,766,366         | 10,283,145         |
| Tesla          | 8,811,119          | 7,519,577          | 6,656,974          | 5,755,891          | 5,084,054          | 4,407,486          |
| Toyota         | 57,626,836         | 50,947,545         | 45,222,716         | 39,154,121         | 34,559,293         | 30,310,503         |
| Volvo          | 4,291,509          | 3,811,360          | 3,399,896          | 2,972,733          | 2,643,561          | 2,317,413          |
| VW             | 16,859,642         | 14,877,053         | 13,250,299         | 11,514,106         | 10,155,419         | 8,896,346          |
| <b>TOTAL</b>   | <b>438,419,187</b> | <b>388,227,463</b> | <b>346,033,905</b> | <b>299,980,026</b> | <b>266,010,193</b> | <b>232,702,406</b> |

**Table 12-35: Projected GHG Targets (Mg), Alternative B - Combined**

| Manufacturer   | 2027               | 2028               | 2029               | 2030               | 2031               | 2032               |
|----------------|--------------------|--------------------|--------------------|--------------------|--------------------|--------------------|
| Aston Martin   | 37,849             | 33,740             | 29,971             | 26,165             | 23,617             | 21,067             |
| BMW            | 15,458,852         | 13,601,505         | 12,092,246         | 10,546,254         | 9,425,211          | 8,331,236          |
| Ferrari        | 121,781            | 108,197            | 96,097             | 83,439             | 76,060             | 68,811             |
| Ford           | 80,102,333         | 71,360,591         | 63,769,622         | 55,468,367         | 49,423,600         | 43,392,385         |
| General Motors | 88,738,621         | 78,731,810         | 70,280,070         | 60,828,485         | 54,186,469         | 47,670,842         |
| Honda          | 45,774,588         | 40,238,847         | 35,831,511         | 31,148,608         | 27,801,837         | 24,492,179         |
| Hyundai        | 29,246,546         | 25,947,616         | 23,045,439         | 20,078,325         | 18,040,571         | 15,959,600         |
| JLR            | 3,096,372          | 2,764,708          | 2,455,250          | 2,141,395          | 1,905,979          | 1,668,879          |
| Kia            | 24,293,838         | 21,396,565         | 19,023,334         | 16,548,575         | 14,722,972         | 12,962,791         |
| Lucid          | 80,860             | 69,495             | 61,739             | 53,392             | 48,141             | 42,925             |
| Mazda          | 9,347,391          | 8,231,074          | 7,338,576          | 6,414,577          | 5,671,399          | 4,974,346          |
| McLaren        | 26,952             | 23,893             | 21,211             | 18,537             | 16,833             | 15,201             |
| Mercedes Benz  | 13,357,924         | 11,876,299         | 10,557,475         | 9,194,776          | 8,243,981          | 7,291,540          |
| Mitsubishi     | 5,009,273          | 4,446,757          | 3,968,070          | 3,480,095          | 3,108,652          | 2,755,890          |
| Nissan         | 24,017,685         | 21,165,639         | 18,816,471         | 16,311,685         | 14,573,455         | 12,889,672         |
| Rivian         | 1,411,205          | 1,252,409          | 1,114,658          | 929,346            | 821,045            | 711,980            |
| Stellantis     | 76,078,913         | 67,458,831         | 60,199,899         | 51,885,394         | 46,034,001         | 40,265,350         |
| Subaru         | 21,721,346         | 19,187,610         | 17,120,449         | 14,955,091         | 13,248,812         | 11,609,715         |
| Tesla          | 18,226,128         | 15,818,281         | 14,045,155         | 12,175,185         | 10,894,615         | 9,617,380          |
| Toyota         | 83,550,461         | 73,720,993         | 65,425,700         | 56,706,408         | 50,342,560         | 44,511,236         |
| Volvo          | 5,164,833          | 4,584,208          | 4,089,254          | 3,575,892          | 3,191,823          | 2,812,036          |
| VW             | 22,247,645         | 19,613,120         | 17,427,674         | 15,160,147         | 13,434,863         | 11,832,710         |
| <b>TOTAL</b>   | <b>567,111,394</b> | <b>501,632,188</b> | <b>446,809,873</b> | <b>387,730,138</b> | <b>345,236,496</b> | <b>303,897,770</b> |



**Table 12-36: Achieved GHG Levels (Mg), Alternative B - Cars**

| Manufacturer   | 2027               | 2028              | 2029              | 2030              | 2031              | 2032              |
|----------------|--------------------|-------------------|-------------------|-------------------|-------------------|-------------------|
| Aston Martin   | 24,467             | 20,896            | 17,618            | 15,219            | 13,210            | 11,550            |
| BMW            | 6,419,499          | 4,627,779         | 3,434,662         | 2,762,484         | 2,512,396         | 2,275,505         |
| Ferrari        | 184,016            | 124,915           | 114,938           | 106,911           | 92,407            | 72,591            |
| Ford           | 4,382,344          | 4,221,600         | 3,669,753         | 3,199,797         | 3,365,391         | 2,949,683         |
| General Motors | 13,708,894         | 9,261,390         | 7,774,573         | 7,318,029         | 6,864,338         | 6,120,908         |
| Honda          | 13,674,168         | 11,817,877        | 9,968,931         | 7,781,356         | 7,987,912         | 5,901,858         |
| Hyundai        | 10,161,457         | 8,870,371         | 7,256,526         | 6,167,604         | 6,337,888         | 4,972,211         |
| JLR            | 72,928             | 62,733            | 61,737            | 60,825            | 58,824            | 55,583            |
| Kia            | 7,058,204          | 5,938,179         | 5,036,444         | 4,245,130         | 4,374,595         | 3,494,760         |
| Lucid          | (9,100)            | (7,282)           | (5,763)           | (4,245)           | (3,562)           | (3,500)           |
| Mazda          | 799,471            | 670,010           | 595,636           | 577,819           | 521,874           | 478,094           |
| McLaren        | 46,569             | 31,859            | 28,962            | 26,852            | 21,192            | 16,171            |
| Mercedes Benz  | 3,423,307          | 3,127,050         | 2,354,705         | 1,957,226         | 1,989,831         | 1,766,539         |
| Mitsubishi     | 2,039,413          | 1,899,972         | 1,635,507         | 1,454,852         | 1,301,631         | 1,042,241         |
| Nissan         | 10,158,213         | 8,908,545         | 7,505,541         | 6,498,846         | 5,026,855         | 3,731,504         |
| Rivian         | -                  | -                 | -                 | -                 | -                 | -                 |
| Stellantis     | 7,160,115          | 6,646,815         | 5,393,059         | 5,219,601         | 4,928,520         | 4,009,809         |
| Subaru         | 2,577,236          | 2,007,047         | 1,845,549         | 1,763,973         | 1,445,867         | 1,364,094         |
| Tesla          | (1,075,056)        | (881,406)         | (699,101)         | (517,278)         | (435,746)         | (430,521)         |
| Toyota         | 19,883,802         | 18,310,279        | 14,294,900        | 14,065,893        | 10,837,081        | 9,852,150         |
| Volvo          | 553,511            | 341,195           | 307,712           | 324,133           | 281,572           | 245,769           |
| VW             | 4,509,599          | 4,660,966         | 4,311,701         | 4,141,986         | 3,192,102         | 2,638,747         |
| <b>TOTAL</b>   | <b>105,753,057</b> | <b>90,660,789</b> | <b>74,903,592</b> | <b>67,167,014</b> | <b>60,714,180</b> | <b>50,565,745</b> |

**Table 12-37: Achieved GHG Levels (Mg), Alternative B - Trucks**

| Manufacturer   | 2027               | 2028               | 2029               | 2030               | 2031               | 2032               |
|----------------|--------------------|--------------------|--------------------|--------------------|--------------------|--------------------|
| Aston Martin   | 25,477             | 21,752             | 20,322             | 19,056             | 14,853             | 11,698             |
| BMW            | 11,622,737         | 9,483,470          | 9,137,410          | 8,593,927          | 7,437,152          | 5,716,997          |
| Ferrari        | -                  | -                  | -                  | -                  | -                  | -                  |
| Ford           | 77,471,438         | 70,368,301         | 60,530,643         | 54,442,788         | 48,151,794         | 39,678,509         |
| General Motors | 79,677,689         | 76,283,685         | 65,286,474         | 57,034,202         | 51,533,459         | 45,524,052         |
| Honda          | 28,025,417         | 26,595,964         | 23,579,577         | 22,007,703         | 17,498,521         | 15,078,332         |
| Hyundai        | 16,965,537         | 15,367,139         | 13,973,281         | 12,657,913         | 10,375,852         | 8,117,906          |
| JLR            | 3,469,363          | 3,241,855          | 2,898,421          | 2,533,947          | 2,275,026          | 1,833,264          |
| Kia            | 15,644,293         | 14,227,745         | 12,830,406         | 11,862,660         | 9,626,557          | 7,427,836          |
| Lucid          | -                  | -                  | -                  | -                  | -                  | -                  |
| Mazda          | 8,367,551          | 7,794,003          | 6,775,089          | 5,962,477          | 5,275,440          | 4,302,935          |
| McLaren        | -                  | -                  | -                  | -                  | -                  | -                  |
| Mercedes Benz  | 10,144,382         | 9,405,740          | 8,629,871          | 7,804,485          | 6,655,466          | 5,192,953          |
| Mitsubishi     | 2,890,651          | 2,511,051          | 2,204,934          | 1,950,928          | 1,735,615          | 1,395,353          |
| Nissan         | 14,049,490         | 12,736,509         | 11,197,094         | 10,069,251         | 9,233,801          | 7,674,395          |
| Rivian         | (133,029)          | (110,593)          | (89,877)           | (66,687)           | (57,356)           | (56,842)           |
| Stellantis     | 75,393,661         | 67,120,363         | 58,584,919         | 51,300,782         | 46,500,414         | 39,565,333         |
| Subaru         | 18,797,153         | 17,808,717         | 15,159,556         | 13,423,750         | 12,096,503         | 8,964,482          |
| Tesla          | (986,869)          | (817,534)          | (660,924)          | (490,193)          | (421,528)          | (417,637)          |
| Toyota         | 58,985,659         | 51,580,634         | 47,126,036         | 39,998,875         | 34,928,540         | 27,138,130         |
| Volvo          | 3,444,548          | 3,575,255          | 3,171,665          | 2,817,705          | 2,768,713          | 2,314,770          |
| VW             | 17,162,006         | 14,592,991         | 11,257,995         | 10,874,524         | 10,174,060         | 7,657,352          |
| <b>TOTAL</b>   | <b>441,017,153</b> | <b>401,787,048</b> | <b>351,612,891</b> | <b>312,798,094</b> | <b>275,802,881</b> | <b>227,119,818</b> |

**Table 12-38: Achieved GHG Levels (Mg), Alternative B - Combined**

| Manufacturer   | 2027               | 2028               | 2029               | 2030               | 2031               | 2032               |
|----------------|--------------------|--------------------|--------------------|--------------------|--------------------|--------------------|
| Aston Martin   | 49,943             | 42,648             | 37,941             | 34,275             | 28,063             | 23,249             |
| BMW            | 18,042,236         | 14,111,250         | 12,572,072         | 11,356,411         | 9,949,548          | 7,992,502          |
| Ferrari        | 184,016            | 124,915            | 114,938            | 106,911            | 92,407             | 72,591             |
| Ford           | 81,853,781         | 74,589,901         | 64,200,396         | 57,642,586         | 51,517,185         | 42,628,192         |
| General Motors | 93,386,583         | 85,545,076         | 73,061,047         | 64,352,231         | 58,397,797         | 51,644,960         |
| Honda          | 41,699,585         | 38,413,841         | 33,548,509         | 29,789,059         | 25,486,433         | 20,980,189         |
| Hyundai        | 27,126,994         | 24,237,510         | 21,229,807         | 18,825,518         | 16,713,740         | 13,090,117         |
| JLR            | 3,542,291          | 3,304,588          | 2,960,158          | 2,594,772          | 2,333,850          | 1,888,848          |
| Kia            | 22,702,497         | 20,165,924         | 17,866,850         | 16,107,790         | 14,001,152         | 10,922,596         |
| Lucid          | (9,100)            | (7,282)            | (5,763)            | (4,245)            | (3,562)            | (3,500)            |
| Mazda          | 9,167,022          | 8,464,013          | 7,370,725          | 6,540,296          | 5,797,314          | 4,781,028          |
| McLaren        | 46,569             | 31,859             | 28,962             | 26,852             | 21,192             | 16,171             |
| Mercedes Benz  | 13,567,689         | 12,532,790         | 10,984,577         | 9,761,712          | 8,645,297          | 6,959,492          |
| Mitsubishi     | 4,930,064          | 4,411,023          | 3,840,441          | 3,405,780          | 3,037,246          | 2,437,594          |
| Nissan         | 24,207,703         | 21,645,054         | 18,702,635         | 16,568,097         | 14,260,656         | 11,405,899         |
| Rivian         | (133,029)          | (110,593)          | (89,877)           | (66,687)           | (57,356)           | (56,842)           |
| Stellantis     | 82,553,776         | 73,767,178         | 63,977,978         | 56,520,383         | 51,428,934         | 43,575,142         |
| Subaru         | 21,374,388         | 19,815,764         | 17,005,105         | 15,187,723         | 13,542,370         | 10,328,575         |
| Tesla          | (2,061,924)        | (1,698,940)        | (1,360,025)        | (1,007,471)        | (857,274)          | (848,157)          |
| Toyota         | 78,869,461         | 69,890,913         | 61,420,936         | 54,064,768         | 45,765,621         | 36,990,280         |
| Volvo          | 3,998,059          | 3,916,450          | 3,479,377          | 3,141,838          | 3,050,285          | 2,560,539          |
| VW             | 21,671,605         | 19,253,957         | 15,569,695         | 15,016,510         | 13,366,162         | 10,296,099         |
| <b>TOTAL</b>   | <b>546,770,210</b> | <b>492,447,837</b> | <b>426,516,483</b> | <b>379,965,107</b> | <b>336,517,061</b> | <b>277,685,563</b> |

**Table 12-39: GHG Credits/Debits Earned (Mg), Alternative B - Combined**

| Manufacturer   | 2027              | 2028             | 2029              | 2030             | 2031             | 2032              |
|----------------|-------------------|------------------|-------------------|------------------|------------------|-------------------|
| Aston Martin   | (12,095)          | (8,908)          | (7,969)           | (8,110)          | (4,446)          | (2,182)           |
| BMW            | (2,583,385)       | (509,745)        | (479,825)         | (810,157)        | (524,337)        | 338,734           |
| Ferrari        | (62,235)          | (16,718)         | (18,840)          | (23,472)         | (16,347)         | (3,780)           |
| Ford           | (1,751,449)       | (3,229,310)      | (430,774)         | (2,174,219)      | (2,093,585)      | 764,194           |
| General Motors | (4,647,962)       | (6,813,265)      | (2,780,977)       | (3,523,746)      | (4,211,328)      | (3,974,118)       |
| Honda          | 4,075,003         | 1,825,006        | 2,283,003         | 1,359,549        | 2,315,404        | 3,511,990         |
| Hyundai        | 2,119,552         | 1,710,107        | 1,815,632         | 1,252,807        | 1,326,831        | 2,869,483         |
| JLR            | (445,919)         | (539,881)        | (504,908)         | (453,377)        | (427,871)        | (219,969)         |
| Kia            | 1,591,341         | 1,230,641        | 1,156,484         | 440,785          | 721,820          | 2,040,195         |
| Lucid          | 89,960            | 76,777           | 67,502            | 57,636           | 51,703           | 46,425            |
| Mazda          | 180,369           | (232,939)        | (32,149)          | (125,719)        | (125,915)        | 193,317           |
| McLaren        | (19,617)          | (7,966)          | (7,752)           | (8,315)          | (4,359)          | (970)             |
| Mercedes Benz  | (209,766)         | (656,491)        | (427,101)         | (566,936)        | (401,316)        | 332,048           |
| Mitsubishi     | 79,209            | 35,734           | 127,628           | 74,315           | 71,406           | 318,296           |
| Nissan         | (190,018)         | (479,415)        | 113,836           | (256,411)        | 312,799          | 1,483,772         |
| Rivian         | 1,544,234         | 1,363,002        | 1,204,535         | 996,033          | 878,401          | 768,822           |
| Stellantis     | (6,474,863)       | (6,308,346)      | (3,778,079)       | (4,634,988)      | (5,394,933)      | (3,309,792)       |
| Subaru         | 346,957           | (628,154)        | 115,344           | (232,631)        | (293,558)        | 1,281,140         |
| Tesla          | 20,288,053        | 17,517,221       | 15,405,180        | 13,182,656       | 11,751,888       | 10,465,538        |
| Toyota         | 4,681,000         | 3,830,080        | 4,004,765         | 2,641,641        | 4,576,939        | 7,520,956         |
| Volvo          | 1,166,774         | 667,759          | 609,877           | 434,054          | 141,538          | 251,498           |
| VW             | 576,040           | 359,163          | 1,857,979         | 143,637          | 68,701           | 1,536,611         |
| <b>TOTAL</b>   | <b>20,341,184</b> | <b>9,184,351</b> | <b>20,293,390</b> | <b>7,765,031</b> | <b>8,719,436</b> | <b>26,212,208</b> |

## 12.1.2 Projected Manufacturing Costs per Vehicle

EPA has performed an assessment of the estimated per-vehicle production costs for manufacturers to meet the final MY 2027-2032 standards, relative to the No Action case. The fleet average costs per vehicle have been grouped by regulatory class. EPA's OMEGA model also tracks vehicles by body style (sedans, crossovers/SUVs and pickups). We have included summary tables in this format. The costs in this section represent compliance costs to the industry and are not necessarily the same as the costs experienced by the consumer when purchasing a new vehicle. For example, the costs presented here do not include any state and Federal purchase incentives that are available to consumers. Also, the manufacturer decisions for the pricing of individual vehicles may not align exactly with the production cost impacts for that particular vehicle. EPA's OMEGA model assumes that manufacturers distribute compliance costs through limited cross-subsidization of prices between vehicles in order to maintain an appropriate mix of debit- and credit-generating vehicles that achieves compliance in a cost-minimizing fashion.

### 12.1.2.1 Final GHG Standards

Incremental costs per vehicle for the final standards (compared to the No Action case) are summarized by regulatory class in Table 12-40 and by body style in Table 12-41.

**Table 12-40: Projected Manufacturing Costs Per Vehicle, Final Standards**

|              | 2027         | 2028         | 2029           | 2030           | 2031           | 2032           |
|--------------|--------------|--------------|----------------|----------------|----------------|----------------|
| Cars         | \$135        | \$348        | \$552          | \$968          | \$849          | \$934          |
| Trucks       | \$276        | \$642        | \$1,199        | \$1,703        | \$2,318        | \$2,561        |
| <b>Total</b> | <b>\$232</b> | <b>\$552</b> | <b>\$1,002</b> | <b>\$1,481</b> | <b>\$1,875</b> | <b>\$2,074</b> |

**Table 12-41: Projected Manufacturing Costs Per Vehicle, Final Standards (by Body Style).**

|                 | 2027         | 2028         | 2029           | 2030           | 2031           | 2032           |
|-----------------|--------------|--------------|----------------|----------------|----------------|----------------|
| Sedans          | \$115        | \$277        | \$555          | \$1,036        | \$666          | \$821          |
| Crossovers/SUVs | \$185        | \$694        | \$961          | \$1,443        | \$2,249        | \$2,558        |
| Pickups         | \$528        | \$349        | \$1,611        | \$2,066        | \$1,816        | \$1,659        |
| <b>Total</b>    | <b>\$232</b> | <b>\$552</b> | <b>\$1,002</b> | <b>\$1,481</b> | <b>\$1,875</b> | <b>\$2,074</b> |

Incremental costs per vehicle for the final standards, compared to the No Action case, are shown for each OEM in Table 12-42, Table 12-43, and Table 12-44 for cars, trucks, and the combined fleet, respectively.<sup>279</sup>

---

<sup>279</sup> For some manufacturers in these tables, costs for the final standards are projected to be lower than in the No Action case. This reflects the combined effects of cost learning with the higher accumulated battery production under the final standards, and more ICE technology applied by some manufacturers in the No Action case.

**Table 12-42: Projected Manufacturing Costs Per Vehicle, Final Standards - Cars**

| Manufacturer   | 2027         | 2028         | 2029         | 2030         | 2031         | 2032         |
|----------------|--------------|--------------|--------------|--------------|--------------|--------------|
| Aston Martin   | \$474        | \$969        | \$1,069      | \$1,935      | \$1,634      | \$1,450      |
| BMW            | -\$10        | \$238        | \$917        | \$2,052      | \$843        | \$1,406      |
| Ferrari        | \$422        | \$2,039      | \$1,602      | \$2,169      | \$2,627      | \$2,598      |
| Ford           | \$165        | -\$682       | -\$906       | -\$745       | \$2          | \$114        |
| General Motors | \$129        | \$2,338      | \$2,429      | \$2,415      | \$2,587      | \$2,141      |
| Honda          | \$43         | \$73         | \$556        | \$1,307      | \$1,290      | \$1,070      |
| Hyundai        | \$296        | \$531        | \$566        | \$883        | \$862        | \$753        |
| JLR            | \$523        | \$81         | \$76         | -\$388       | \$89         | \$70         |
| Kia            | -\$80        | \$290        | \$510        | \$1,132      | \$737        | \$763        |
| Lucid          | \$0          | \$0          | \$0          | \$0          | \$0          | \$0          |
| Mazda          | -\$154       | \$1,426      | \$858        | \$1,027      | \$708        | \$1,469      |
| McLaren        | \$382        | \$2,121      | \$1,772      | \$2,370      | \$2,876      | \$3,080      |
| Mercedes Benz  | -\$217       | -\$109       | -\$353       | \$956        | -\$172       | \$642        |
| Mitsubishi     | \$153        | -\$204       | \$105        | \$495        | \$711        | \$708        |
| Nissan         | \$180        | \$409        | \$723        | \$948        | \$813        | \$1,069      |
| Rivian         | -            | -            | -            | -            | -            | -            |
| Stellantis     | -\$768       | -\$1,294     | -\$1,020     | -\$869       | -\$166       | -\$99        |
| Subaru         | \$177        | \$2,490      | \$2,825      | \$3,030      | \$2,888      | \$2,517      |
| Tesla          | \$0          | \$0          | \$0          | \$0          | \$0          | \$0          |
| Toyota         | \$363        | \$38         | \$327        | \$832        | \$486        | \$914        |
| Volvo          | \$110        | \$895        | \$1,183      | \$412        | \$638        | \$805        |
| VW             | \$596        | -\$579       | -\$862       | -\$365       | -\$631       | -\$433       |
| <b>TOTAL</b>   | <b>\$135</b> | <b>\$348</b> | <b>\$552</b> | <b>\$968</b> | <b>\$849</b> | <b>\$934</b> |

**Table 12-43: Projected Manufacturing Costs Per Vehicle, Final Standards - Trucks**

| Manufacturer   | 2027         | 2028         | 2029           | 2030           | 2031           | 2032           |
|----------------|--------------|--------------|----------------|----------------|----------------|----------------|
| Aston Martin   | \$197        | \$414        | \$2,040        | \$2,151        | \$3,674        | \$4,450        |
| BMW            | \$362        | \$1,489      | \$1,129        | \$1,295        | \$2,331        | \$3,160        |
| Ferrari        | -            | -            | -              | -              | -              | -              |
| Ford           | \$385        | \$744        | \$1,308        | \$1,773        | \$1,485        | \$1,714        |
| General Motors | \$337        | \$396        | \$1,118        | \$1,277        | \$2,142        | \$2,801        |
| Honda          | \$305        | \$631        | \$890          | \$1,201        | \$1,832        | \$2,289        |
| Hyundai        | \$47         | \$449        | \$1,091        | \$1,752        | \$2,490        | \$2,262        |
| JLR            | \$185        | \$595        | \$1,597        | \$2,432        | \$2,973        | \$3,201        |
| Kia            | \$413        | \$570        | \$1,182        | \$1,636        | \$2,685        | \$2,777        |
| Lucid          | -            | -            | -              | -              | -              | -              |
| Mazda          | \$337        | \$353        | \$1,371        | \$2,116        | \$2,667        | \$2,599        |
| McLaren        | -            | -            | -              | -              | -              | -              |
| Mercedes Benz  | \$548        | \$925        | \$1,827        | \$2,509        | \$3,821        | \$3,418        |
| Mitsubishi     | \$169        | \$1,386      | \$1,961        | \$2,533        | \$2,981        | \$3,005        |
| Nissan         | \$269        | \$534        | \$499          | \$1,767        | \$2,638        | \$2,776        |
| Rivian         | \$0          | \$0          | \$0            | \$0            | \$0            | \$0            |
| Stellantis     | \$355        | \$679        | \$1,387        | \$1,960        | \$2,844        | \$3,045        |
| Subaru         | \$190        | \$534        | \$1,106        | \$1,886        | \$2,313        | \$2,375        |
| Tesla          | \$0          | \$0          | \$0            | \$0            | \$0            | \$0            |
| Toyota         | \$87         | \$745        | \$1,092        | \$1,746        | \$2,601        | \$2,747        |
| Volvo          | \$288        | \$185        | \$786          | \$1,749        | \$2,015        | \$1,973        |
| VW             | -\$21        | \$849        | \$1,717        | \$2,109        | \$2,895        | \$2,960        |
| <b>TOTAL</b>   | <b>\$276</b> | <b>\$642</b> | <b>\$1,199</b> | <b>\$1,703</b> | <b>\$2,318</b> | <b>\$2,561</b> |

**Table 12-44: Projected Manufacturing Costs Per Vehicle, Final Standards - Combined**

| Manufacturer   | 2027         | 2028         | 2029           | 2030           | 2031           | 2032           |
|----------------|--------------|--------------|----------------|----------------|----------------|----------------|
| Aston Martin   | \$360        | \$740        | \$1,473        | \$2,026        | \$2,490        | \$2,712        |
| BMW            | \$206        | \$971        | \$1,041        | \$1,605        | \$1,723        | \$2,446        |
| Ferrari        | \$422        | \$2,039      | \$1,602        | \$2,169        | \$2,627        | \$2,598        |
| Ford           | \$362        | \$600        | \$1,086        | \$1,521        | \$1,337        | \$1,555        |
| General Motors | \$288        | \$850        | \$1,423        | \$1,541        | \$2,245        | \$2,648        |
| Honda          | \$187        | \$382        | \$742          | \$1,248        | \$1,593        | \$1,754        |
| Hyundai        | \$167        | \$489        | \$841          | \$1,338        | \$1,717        | \$1,547        |
| JLR            | \$195        | \$581        | \$1,554        | \$2,354        | \$2,894        | \$3,116        |
| Kia            | \$186        | \$442        | \$877          | \$1,408        | \$1,805        | \$1,869        |
| Lucid          | \$0          | \$0          | \$0            | \$0            | \$0            | \$0            |
| Mazda          | \$273        | \$492        | \$1,306        | \$1,977        | \$2,419        | \$2,456        |
| McLaren        | \$382        | \$2,121      | \$1,772        | \$2,370        | \$2,876        | \$3,080        |
| Mercedes Benz  | \$294        | \$584        | \$1,112        | \$2,002        | \$2,522        | \$2,517        |
| Mitsubishi     | \$160        | \$561        | \$1,000        | \$1,478        | \$1,807        | \$1,817        |
| Nissan         | \$219        | \$464        | \$624          | \$1,310        | \$1,622        | \$1,827        |
| Rivian         | \$0          | \$0          | \$0            | \$0            | \$0            | \$0            |
| Stellantis     | \$234        | \$469        | \$1,133        | \$1,663        | \$2,531        | \$2,718        |
| Subaru         | \$188        | \$816        | \$1,351        | \$2,048        | \$2,394        | \$2,395        |
| Tesla          | \$0          | \$0          | \$0            | \$0            | \$0            | \$0            |
| Toyota         | \$198        | \$462        | \$788          | \$1,384        | \$1,767        | \$2,025        |
| Volvo          | \$247        | \$346        | \$876          | \$1,448        | \$1,706        | \$1,711        |
| VW             | \$173        | \$405        | \$921          | \$1,349        | \$1,817        | \$1,927        |
| <b>TOTAL</b>   | <b>\$232</b> | <b>\$552</b> | <b>\$1,002</b> | <b>\$1,481</b> | <b>\$1,875</b> | <b>\$2,074</b> |

**12.1.2.2 Alternative A**

Incremental costs per vehicle for Alternative A (compared to the No Action case) are summarized by regulatory class in Table 12-45 and by body style in Table 12-46.

**Table 12-45: Projected Manufacturing Costs Per Vehicle, Alternative A**

|              | 2027           | 2028           | 2029           | 2030           | 2031           | 2032           |
|--------------|----------------|----------------|----------------|----------------|----------------|----------------|
| Cars         | \$597          | \$832          | \$932          | \$1,085        | \$1,022        | \$1,085        |
| Trucks       | \$1,345        | \$2,218        | \$2,594        | \$2,958        | \$3,021        | \$2,999        |
| <b>Total</b> | <b>\$1,114</b> | <b>\$1,794</b> | <b>\$2,088</b> | <b>\$2,390</b> | <b>\$2,418</b> | <b>\$2,425</b> |

**Table 12-46: Projected Manufacturing Costs Per Vehicle, Alternative A (by Body Style)**

|                 | 2027           | 2028           | 2029           | 2030           | 2031           | 2032           |
|-----------------|----------------|----------------|----------------|----------------|----------------|----------------|
| Sedans          | \$337          | \$686          | \$799          | \$913          | \$808          | \$978          |
| Crossovers/SUVs | \$1,277        | \$1,937        | \$2,249        | \$2,681        | \$2,848        | \$2,824        |
| Pickups         | \$1,385        | \$2,469        | \$2,874        | \$2,905        | \$2,571        | \$2,499        |
| <b>Total</b>    | <b>\$1,114</b> | <b>\$1,794</b> | <b>\$2,088</b> | <b>\$2,390</b> | <b>\$2,418</b> | <b>\$2,425</b> |

Incremental costs per vehicle for Alternative A, compared to the No Action case, are shown for each OEM in Table 12-47, Table 12-48, and Table 12-49 for cars, trucks, and the combined fleet, respectively.

**Table 12-47: Projected Manufacturing Costs Per Vehicle, Alternative A - Cars**

| Manufacturer   | 2027         | 2028         | 2029         | 2030           | 2031           | 2032           |
|----------------|--------------|--------------|--------------|----------------|----------------|----------------|
| Aston Martin   | \$1,014      | \$2,377      | \$2,326      | \$2,835        | \$2,585        | \$2,583        |
| BMW            | \$227        | \$1,144      | \$1,398      | \$1,435        | \$1,135        | \$1,854        |
| Ferrari        | \$491        | \$2,677      | \$2,506      | \$2,944        | \$3,123        | \$2,983        |
| Ford           | \$825        | -\$20        | -\$174       | \$168          | \$354          | \$339          |
| General Motors | \$682        | \$904        | \$1,334      | \$1,454        | \$1,442        | \$1,150        |
| Honda          | \$644        | \$933        | \$1,107      | \$1,330        | \$1,498        | \$1,306        |
| Hyundai        | \$882        | \$725        | \$841        | \$1,107        | \$888          | \$1,027        |
| JLR            | \$1,986      | \$2,060      | \$1,437      | \$1,323        | \$2,003        | \$2,223        |
| Kia            | \$369        | \$1,264      | \$1,513      | \$1,807        | \$1,397        | \$1,284        |
| Lucid          | \$0          | \$0          | \$0          | \$0            | \$0            | \$0            |
| Mazda          | \$255        | \$3,251      | \$2,394      | \$2,786        | \$2,055        | \$2,588        |
| McLaren        | \$553        | \$2,687      | \$2,326      | \$2,817        | \$2,970        | \$3,080        |
| Mercedes Benz  | \$689        | \$1,447      | \$927        | \$1,567        | \$765          | \$1,061        |
| Mitsubishi     | \$1,238      | \$1,017      | \$1,089      | \$1,243        | \$1,307        | \$1,275        |
| Nissan         | \$664        | \$1,117      | \$1,044      | \$1,403        | \$1,399        | \$1,482        |
| Rivian         | -            | -            | -            | -              | -              | -              |
| Stellantis     | \$467        | -\$2,626     | -\$2,401     | -\$2,741       | -\$2,098       | -\$2,049       |
| Subaru         | \$921        | \$1,117      | \$1,392      | \$1,625        | \$1,499        | \$1,735        |
| Tesla          | \$0          | \$0          | \$0          | \$0            | \$0            | \$0            |
| Toyota         | \$606        | \$1,410      | \$1,486      | \$1,341        | \$1,294        | \$1,635        |
| Volvo          | \$1,090      | \$275        | \$516        | \$246          | \$50           | \$381          |
| VW             | \$240        | \$451        | \$181        | \$1,064        | \$498          | \$146          |
| <b>TOTAL</b>   | <b>\$597</b> | <b>\$832</b> | <b>\$932</b> | <b>\$1,085</b> | <b>\$1,022</b> | <b>\$1,085</b> |

**Table 12-48: Projected Manufacturing Costs Per Vehicle, Alternative A - Trucks**

| Manufacturer   | 2027           | 2028           | 2029           | 2030           | 2031           | 2032           |
|----------------|----------------|----------------|----------------|----------------|----------------|----------------|
| Aston Martin   | \$1,898        | \$1,930        | \$2,489        | \$3,456        | \$4,648        | \$4,609        |
| BMW            | \$1,675        | \$2,939        | \$2,691        | \$3,466        | \$4,202        | \$3,647        |
| Ferrari        | -              | -              | -              | -              | -              | -              |
| Ford           | \$1,319        | \$2,365        | \$2,773        | \$3,094        | \$2,259        | \$2,138        |
| General Motors | \$1,176        | \$2,264        | \$2,896        | \$2,673        | \$2,765        | \$2,890        |
| Honda          | \$1,528        | \$1,925        | \$1,921        | \$2,408        | \$2,542        | \$2,896        |
| Hyundai        | \$1,547        | \$2,214        | \$2,326        | \$2,756        | \$3,358        | \$3,037        |
| JLR            | \$1,696        | \$2,807        | \$3,198        | \$3,673        | \$3,876        | \$4,038        |
| Kia            | \$1,967        | \$1,855        | \$1,990        | \$2,447        | \$2,790        | \$3,038        |
| Lucid          | -              | -              | -              | -              | -              | -              |
| Mazda          | \$1,742        | \$2,209        | \$2,737        | \$2,988        | \$3,358        | \$3,272        |
| McLaren        | -              | -              | -              | -              | -              | -              |
| Mercedes Benz  | \$2,087        | \$2,352        | \$2,970        | \$3,122        | \$3,843        | \$3,359        |
| Mitsubishi     | \$1,756        | \$2,504        | \$2,813        | \$3,148        | \$3,416        | \$3,532        |
| Nissan         | \$1,124        | \$1,870        | \$2,119        | \$2,809        | \$2,859        | \$2,833        |
| Rivian         | \$0            | \$0            | \$0            | \$0            | \$0            | \$0            |
| Stellantis     | \$1,124        | \$2,360        | \$3,031        | \$3,571        | \$3,588        | \$3,476        |
| Subaru         | \$1,604        | \$2,256        | \$2,933        | \$3,316        | \$3,640        | \$3,378        |
| Tesla          | \$0            | \$0            | \$0            | \$0            | \$0            | \$0            |
| Toyota         | \$1,163        | \$1,821        | \$2,103        | \$2,888        | \$3,095        | \$3,052        |
| Volvo          | \$942          | \$4,780        | \$4,669        | \$4,861        | \$4,844        | \$4,622        |
| VW             | \$1,803        | \$2,752        | \$2,376        | \$2,582        | \$3,519        | \$3,892        |
| <b>TOTAL</b>   | <b>\$1,345</b> | <b>\$2,218</b> | <b>\$2,594</b> | <b>\$2,958</b> | <b>\$3,021</b> | <b>\$2,999</b> |

**Table 12-49: Projected Manufacturing Costs Per Vehicle, Alternative A - Combined**

| Manufacturer   | 2027           | 2028           | 2029           | 2030           | 2031           | 2032           |
|----------------|----------------|----------------|----------------|----------------|----------------|----------------|
| Aston Martin   | \$1,376        | \$2,192        | \$2,394        | \$3,095        | \$3,451        | \$3,435        |
| BMW            | \$1,069        | \$2,196        | \$2,159        | \$2,634        | \$2,950        | \$2,917        |
| Ferrari        | \$491          | \$2,677        | \$2,506        | \$2,944        | \$3,123        | \$2,983        |
| Ford           | \$1,269        | \$2,125        | \$2,478        | \$2,802        | \$2,068        | \$1,959        |
| General Motors | \$1,059        | \$1,945        | \$2,533        | \$2,390        | \$2,459        | \$2,487        |
| Honda          | \$1,130        | \$1,483        | \$1,560        | \$1,932        | \$2,083        | \$2,198        |
| Hyundai        | \$1,227        | \$1,502        | \$1,618        | \$1,971        | \$2,186        | \$2,084        |
| JLR            | \$1,705        | \$2,786        | \$3,149        | \$3,609        | \$3,825        | \$3,989        |
| Kia            | \$1,231        | \$1,585        | \$1,773        | \$2,157        | \$2,161        | \$2,248        |
| Lucid          | \$0            | \$0            | \$0            | \$0            | \$0            | \$0            |
| Mazda          | \$1,547        | \$2,344        | \$2,693        | \$2,962        | \$3,193        | \$3,186        |
| McLaren        | \$553          | \$2,687        | \$2,326        | \$2,817        | \$2,970        | \$3,080        |
| Mercedes Benz  | \$1,622        | \$2,054        | \$2,301        | \$2,614        | \$2,842        | \$2,613        |
| Mitsubishi     | \$1,487        | \$1,733        | \$1,920        | \$2,162        | \$2,325        | \$2,365        |
| Nissan         | \$863          | \$1,447        | \$1,517        | \$2,024        | \$2,046        | \$2,082        |
| Rivian         | \$0            | \$0            | \$0            | \$0            | \$0            | \$0            |
| Stellantis     | \$1,053        | \$1,829        | \$2,458        | \$2,909        | \$2,995        | \$2,902        |
| Subaru         | \$1,504        | \$2,092        | \$2,713        | \$3,076        | \$3,339        | \$3,148        |
| Tesla          | \$0            | \$0            | \$0            | \$0            | \$0            | \$0            |
| Toyota         | \$938          | \$1,657        | \$1,858        | \$2,276        | \$2,384        | \$2,494        |
| Volvo          | \$976          | \$3,757        | \$3,731        | \$3,821        | \$3,768        | \$3,671        |
| VW             | \$1,311        | \$2,036        | \$1,698        | \$2,116        | \$2,595        | \$2,751        |
| <b>TOTAL</b>   | <b>\$1,114</b> | <b>\$1,794</b> | <b>\$2,088</b> | <b>\$2,390</b> | <b>\$2,418</b> | <b>\$2,425</b> |

**12.1.2.3 Alternative B**

Incremental costs per vehicle for Alternative B (compared to the No Action case) are summarized by regulatory class in Table 12-50 and by body style in Table 12-51.

**Table 12-50: Projected Manufacturing Costs Per Vehicle, Alternative B**

|              | 2027         | 2028         | 2029         | 2030           | 2031           | 2032           |
|--------------|--------------|--------------|--------------|----------------|----------------|----------------|
| Cars         | \$114        | \$71         | \$373        | \$692          | \$607          | \$716          |
| Trucks       | \$259        | \$598        | \$1,182      | \$1,671        | \$1,971        | \$2,358        |
| <b>Total</b> | <b>\$214</b> | <b>\$437</b> | <b>\$936</b> | <b>\$1,375</b> | <b>\$1,561</b> | <b>\$1,867</b> |

**Table 12-51: Projected Manufacturing Costs Per Vehicle, Alternative B (by Body Style)**

|                 | 2027         | 2028         | 2029         | 2030           | 2031           | 2032           |
|-----------------|--------------|--------------|--------------|----------------|----------------|----------------|
| Sedans          | \$91         | -\$63        | \$335        | \$756          | \$499          | \$572          |
| Crossovers/SUVs | \$198        | \$644        | \$1,008      | \$1,320        | \$1,775        | \$2,314        |
| Pickups         | \$409        | \$251        | \$1,315      | \$2,202        | \$1,898        | \$1,617        |
| <b>Total</b>    | <b>\$214</b> | <b>\$437</b> | <b>\$936</b> | <b>\$1,375</b> | <b>\$1,561</b> | <b>\$1,867</b> |

Incremental costs per vehicle for Alternative B, compared to the No Action case, are shown for each OEM in 12-52, Table 12-53, and Table 12-54 for cars, trucks, and the combined fleet, respectively.

**Table 12-52: Projected Manufacturing Costs Per Vehicle, Alternative B - Cars**

| Manufacturer   | 2027         | 2028        | 2029         | 2030         | 2031         | 2032         |
|----------------|--------------|-------------|--------------|--------------|--------------|--------------|
| Aston Martin   | \$394        | \$1,303     | \$1,293      | \$1,933      | \$2,051      | \$2,227      |
| BMW            | -\$8         | \$495       | \$1,306      | \$2,046      | \$1,324      | \$1,352      |
| Ferrari        | \$422        | \$2,324     | \$2,266      | \$2,356      | \$2,590      | \$2,880      |
| Ford           | \$217        | -\$748      | -\$975       | -\$583       | -\$457       | -\$390       |
| General Motors | \$40         | \$2,276     | \$2,450      | \$2,476      | \$2,439      | \$1,975      |
| Honda          | \$39         | \$0         | \$336        | \$996        | \$707        | \$897        |
| Hyundai        | \$295        | \$55        | \$507        | \$911        | \$359        | \$594        |
| JLR            | \$265        | -\$34       | \$55         | -\$384       | \$95         | \$117        |
| Kia            | -\$82        | \$165       | \$442        | \$873        | \$286        | \$387        |
| Lucid          | \$0          | \$0         | \$0          | \$0          | \$0          | \$0          |
| Mazda          | -\$153       | \$235       | -\$364       | -\$3         | -\$397       | \$366        |
| McLaren        | \$372        | \$2,108     | \$1,948      | \$2,017      | \$2,335      | \$2,939      |
| Mercedes Benz  | -\$171       | \$67        | \$499        | \$1,675      | \$785        | \$699        |
| Mitsubishi     | \$153        | -\$343      | \$63         | \$395        | \$537        | \$701        |
| Nissan         | \$162        | \$143       | \$430        | \$889        | \$1,081      | \$1,434      |
| Rivian         | -            | -           | -            | -            | -            | -            |
| Stellantis     | -\$797       | -\$4,300    | -\$3,588     | -\$3,718     | -\$3,134     | -\$2,632     |
| Subaru         | \$178        | \$363       | \$679        | \$759        | \$981        | \$956        |
| Tesla          | \$0          | \$0         | \$0          | \$0          | \$0          | \$0          |
| Toyota         | \$342        | -\$33       | \$443        | \$557        | \$692        | \$867        |
| Volvo          | \$110        | \$1,038     | \$982        | \$856        | \$577        | \$679        |
| VW             | \$426        | -\$719      | -\$1,263     | -\$863       | -\$427       | -\$336       |
| <b>TOTAL</b>   | <b>\$114</b> | <b>\$71</b> | <b>\$373</b> | <b>\$692</b> | <b>\$607</b> | <b>\$716</b> |

**Table 12-53: Projected Manufacturing Costs Per Vehicle, Alternative B - Trucks**

| Manufacturer   | 2027         | 2028         | 2029           | 2030           | 2031           | 2032           |
|----------------|--------------|--------------|----------------|----------------|----------------|----------------|
| Aston Martin   | \$117        | \$639        | \$1,671        | \$1,859        | \$3,585        | \$3,952        |
| BMW            | \$361        | \$1,053      | \$966          | \$1,152        | \$2,532        | \$3,075        |
| Ferrari        | -            | -            | -              | -              | -              | -              |
| Ford           | \$338        | \$701        | \$1,187        | \$1,829        | \$1,103        | \$1,623        |
| General Motors | \$296        | \$331        | \$1,069        | \$1,250        | \$1,671        | \$1,838        |
| Honda          | \$300        | \$521        | \$1,033        | \$1,360        | \$2,156        | \$2,449        |
| Hyundai        | \$47         | \$484        | \$895          | \$1,398        | \$2,371        | \$2,586        |
| JLR            | \$418        | \$921        | \$1,459        | \$2,319        | \$2,661        | \$3,190        |
| Kia            | \$429        | \$558        | \$1,089        | \$1,506        | \$2,398        | \$3,073        |
| Lucid          | -            | -            | -              | -              | -              | -              |
| Mazda          | \$338        | \$334        | \$1,410        | \$2,072        | \$2,470        | \$2,605        |
| McLaren        | -            | -            | -              | -              | -              | -              |
| Mercedes Benz  | \$539        | \$727        | \$1,355        | \$1,554        | \$2,569        | \$2,844        |
| Mitsubishi     | \$169        | \$698        | \$1,421        | \$2,121        | \$2,452        | \$2,883        |
| Nissan         | \$244        | \$394        | \$784          | \$1,180        | \$1,529        | \$1,908        |
| Rivian         | \$0          | \$0          | \$0            | \$0            | \$0            | \$0            |
| Stellantis     | \$341        | \$805        | \$1,488        | \$2,121        | \$2,401        | \$2,499        |
| Subaru         | \$190        | \$471        | \$1,240        | \$1,903        | \$2,165        | \$2,789        |
| Tesla          | \$0          | \$0          | \$0            | \$0            | \$0            | \$0            |
| Toyota         | \$78         | \$669        | \$1,028        | \$1,792        | \$2,288        | \$2,862        |
| Volvo          | \$288        | \$98         | \$843          | \$1,556        | \$1,800        | \$2,226        |
| VW             | -\$21        | \$891        | \$2,002        | \$2,000        | \$2,262        | \$3,300        |
| <b>TOTAL</b>   | <b>\$259</b> | <b>\$598</b> | <b>\$1,182</b> | <b>\$1,671</b> | <b>\$1,971</b> | <b>\$2,358</b> |



**Table 12-54: Projected Manufacturing Costs Per Vehicle, Alternative B - Combined**

| Manufacturer   | 2027         | 2028         | 2029         | 2030           | 2031           | 2032           |
|----------------|--------------|--------------|--------------|----------------|----------------|----------------|
| Aston Martin   | \$281        | \$1,028      | \$1,451      | \$1,902        | \$2,695        | \$2,952        |
| BMW            | \$207        | \$822        | \$1,106      | \$1,519        | \$2,039        | \$2,374        |
| Ferrari        | \$422        | \$2,324      | \$2,266      | \$2,356        | \$2,590        | \$2,880        |
| Ford           | \$326        | \$555        | \$970        | \$1,587        | \$947          | \$1,422        |
| General Motors | \$236        | \$786        | \$1,390      | \$1,535        | \$1,849        | \$1,870        |
| Honda          | \$183        | \$289        | \$724        | \$1,199        | \$1,519        | \$1,768        |
| Hyundai        | \$166        | \$279        | \$710        | \$1,166        | \$1,416        | \$1,642        |
| JLR            | \$413        | \$894        | \$1,420      | \$2,245        | \$2,591        | \$3,107        |
| Kia            | \$194        | \$378        | \$795        | \$1,219        | \$1,444        | \$1,863        |
| Lucid          | \$0          | \$0          | \$0          | \$0            | \$0            | \$0            |
| Mazda          | \$273        | \$321        | \$1,183      | \$1,808        | \$2,107        | \$2,323        |
| McLaren        | \$372        | \$2,108      | \$1,948      | \$2,017        | \$2,335        | \$2,939        |
| Mercedes Benz  | \$303        | \$510        | \$1,074      | \$1,594        | \$1,989        | \$2,148        |
| Mitsubishi     | \$161        | \$158        | \$717        | \$1,227        | \$1,461        | \$1,754        |
| Nissan         | \$197        | \$253        | \$586        | \$1,018        | \$1,279        | \$1,644        |
| Rivian         | \$0          | \$0          | \$0          | \$0            | \$0            | \$0            |
| Stellantis     | \$218        | \$261        | \$952        | \$1,509        | \$1,824        | \$1,965        |
| Subaru         | \$188        | \$455        | \$1,160      | \$1,741        | \$1,998        | \$2,532        |
| Tesla          | \$0          | \$0          | \$0          | \$0            | \$0            | \$0            |
| Toyota         | \$185        | \$389        | \$796        | \$1,303        | \$1,658        | \$2,076        |
| Volvo          | \$247        | \$311        | \$874        | \$1,398        | \$1,525        | \$1,879        |
| VW             | \$120        | \$390        | \$993        | \$1,121        | \$1,440        | \$2,192        |
| <b>TOTAL</b>   | <b>\$214</b> | <b>\$437</b> | <b>\$936</b> | <b>\$1,375</b> | <b>\$1,561</b> | <b>\$1,867</b> |

### **12.1.3 Technology Penetration Rates**

Presented below are the projected technology penetration rates, by manufacturer, for cars, trucks, and the combined fleet, for the No Action case, and the final standards and alternatives.

Tables are provided by manufacturer and regulatory class for BEV and PHEV penetrations. Summary tables for strong HEV penetrations and a few key ICE technology groupings (TURB12 and Atkinson engines) are also provided.

#### **12.1.3.1 No Action Case**

Table 12-55 through Table 12-57 give BEV penetrations for the No Action case, by manufacturer. Similarly, Table 12-58 through Table 12-60 provide PHEV penetrations.

**Table 12-55: Projected BEV Penetrations, No Action - Cars**

| Manufacturer   | 2027       | 2028       | 2029       | 2030       | 2031       | 2032       |
|----------------|------------|------------|------------|------------|------------|------------|
| Aston Martin   | 30%        | 27%        | 34%        | 34%        | 39%        | 41%        |
| BMW            | 23%        | 30%        | 32%        | 32%        | 42%        | 43%        |
| Ferrari        | 23%        | 22%        | 26%        | 26%        | 28%        | 30%        |
| Ford           | 35%        | 34%        | 41%        | 39%        | 40%        | 43%        |
| General Motors | 27%        | 25%        | 26%        | 28%        | 31%        | 35%        |
| Honda          | 29%        | 29%        | 31%        | 32%        | 35%        | 36%        |
| Hyundai        | 28%        | 29%        | 32%        | 33%        | 39%        | 38%        |
| JLR            | 26%        | 31%        | 31%        | 36%        | 33%        | 34%        |
| Kia            | 35%        | 33%        | 36%        | 37%        | 39%        | 41%        |
| Lucid          | 100%       | 100%       | 100%       | 100%       | 100%       | 100%       |
| Mazda          | 34%        | 32%        | 45%        | 43%        | 53%        | 46%        |
| McLaren        | 26%        | 27%        | 30%        | 30%        | 32%        | 35%        |
| Mercedes Benz  | 32%        | 31%        | 38%        | 31%        | 41%        | 43%        |
| Mitsubishi     | 26%        | 27%        | 30%        | 30%        | 34%        | 36%        |
| Nissan         | 26%        | 27%        | 30%        | 31%        | 36%        | 38%        |
| Rivian         | -          | -          | -          | -          | -          | -          |
| Stellantis     | 32%        | 32%        | 41%        | 46%        | 44%        | 40%        |
| Subaru         | 25%        | 28%        | 29%        | 30%        | 34%        | 34%        |
| Tesla          | 100%       | 100%       | 100%       | 100%       | 100%       | 100%       |
| Toyota         | 27%        | 28%        | 31%        | 31%        | 37%        | 36%        |
| Volvo          | 51%        | 51%        | 54%        | 55%        | 61%        | 62%        |
| VW             | 34%        | 31%        | 40%        | 37%        | 43%        | 46%        |
| <b>TOTAL</b>   | <b>34%</b> | <b>34%</b> | <b>37%</b> | <b>38%</b> | <b>42%</b> | <b>43%</b> |

**Table 12-56: Projected BEV Penetrations, No Action - Trucks**

| Manufacturer   | 2027       | 2028       | 2029       | 2030       | 2031       | 2032       |
|----------------|------------|------------|------------|------------|------------|------------|
| Aston Martin   | 20%        | 24%        | 23%        | 24%        | 24%        | 25%        |
| BMW            | 19%        | 25%        | 27%        | 28%        | 26%        | 27%        |
| Ferrari        | -          | -          | -          | -          | -          | -          |
| Ford           | 21%        | 23%        | 25%        | 26%        | 29%        | 30%        |
| General Motors | 19%        | 22%        | 26%        | 27%        | 29%        | 30%        |
| Honda          | 21%        | 23%        | 26%        | 27%        | 29%        | 30%        |
| Hyundai        | 23%        | 24%        | 26%        | 27%        | 27%        | 29%        |
| JLR            | 23%        | 23%        | 27%        | 27%        | 30%        | 31%        |
| Kia            | 20%        | 23%        | 25%        | 26%        | 28%        | 29%        |
| Lucid          | -          | -          | -          | -          | -          | -          |
| Mazda          | 22%        | 23%        | 25%        | 26%        | 28%        | 30%        |
| McLaren        | -          | -          | -          | -          | -          | -          |
| Mercedes Benz  | 22%        | 24%        | 25%        | 28%        | 28%        | 28%        |
| Mitsubishi     | 22%        | 23%        | 26%        | 26%        | 29%        | 29%        |
| Nissan         | 22%        | 24%        | 27%        | 29%        | 29%        | 31%        |
| Rivian         | 100%       | 100%       | 100%       | 100%       | 100%       | 100%       |
| Stellantis     | 18%        | 21%        | 23%        | 24%        | 27%        | 29%        |
| Subaru         | 23%        | 24%        | 27%        | 27%        | 30%        | 31%        |
| Tesla          | 100%       | 100%       | 100%       | 100%       | 100%       | 100%       |
| Toyota         | 20%        | 22%        | 25%        | 25%        | 27%        | 29%        |
| Volvo          | 16%        | 16%        | 19%        | 20%        | 22%        | 25%        |
| VW             | 26%        | 25%        | 30%        | 32%        | 33%        | 34%        |
| <b>TOTAL</b>   | <b>22%</b> | <b>24%</b> | <b>27%</b> | <b>28%</b> | <b>30%</b> | <b>31%</b> |

**Table 12-57: Projected BEV Penetrations, No Action - Combined**

| Manufacturer   | 2027       | 2028       | 2029       | 2030       | 2031       | 2032       |
|----------------|------------|------------|------------|------------|------------|------------|
| Aston Martin   | 26%        | 26%        | 30%        | 30%        | 33%        | 34%        |
| BMW            | 21%        | 27%        | 29%        | 29%        | 33%        | 34%        |
| Ferrari        | 23%        | 22%        | 26%        | 26%        | 28%        | 30%        |
| Ford           | 22%        | 24%        | 27%        | 28%        | 30%        | 31%        |
| General Motors | 21%        | 23%        | 26%        | 27%        | 30%        | 31%        |
| Honda          | 25%        | 26%        | 28%        | 29%        | 32%        | 33%        |
| Hyundai        | 26%        | 27%        | 29%        | 30%        | 33%        | 33%        |
| JLR            | 23%        | 23%        | 27%        | 28%        | 30%        | 31%        |
| Kia            | 27%        | 28%        | 30%        | 31%        | 33%        | 35%        |
| Lucid          | 100%       | 100%       | 100%       | 100%       | 100%       | 100%       |
| Mazda          | 23%        | 24%        | 28%        | 28%        | 31%        | 32%        |
| McLaren        | 26%        | 27%        | 30%        | 30%        | 32%        | 35%        |
| Mercedes Benz  | 25%        | 26%        | 29%        | 29%        | 32%        | 33%        |
| Mitsubishi     | 24%        | 25%        | 28%        | 28%        | 31%        | 33%        |
| Nissan         | 24%        | 26%        | 29%        | 30%        | 33%        | 34%        |
| Rivian         | 100%       | 100%       | 100%       | 100%       | 100%       | 100%       |
| Stellantis     | 20%        | 22%        | 25%        | 26%        | 29%        | 30%        |
| Subaru         | 23%        | 25%        | 27%        | 28%        | 31%        | 31%        |
| Tesla          | 100%       | 100%       | 100%       | 100%       | 100%       | 100%       |
| Toyota         | 23%        | 24%        | 27%        | 28%        | 31%        | 32%        |
| Volvo          | 24%        | 24%        | 27%        | 28%        | 31%        | 33%        |
| VW             | 29%        | 27%        | 33%        | 33%        | 36%        | 37%        |
| <b>TOTAL</b>   | <b>26%</b> | <b>27%</b> | <b>30%</b> | <b>31%</b> | <b>34%</b> | <b>35%</b> |

**Table 12-58: Projected PHEV Penetrations, No Action - Cars**

| Manufacturer   | 2027      | 2028      | 2029      | 2030      | 2031      | 2032       |
|----------------|-----------|-----------|-----------|-----------|-----------|------------|
| Aston Martin   | 4%        | 8%        | 8%        | 9%        | 9%        | 10%        |
| BMW            | 5%        | 6%        | 7%        | 8%        | 8%        | 10%        |
| Ferrari        | 20%       | 20%       | 20%       | 23%       | 25%       | 27%        |
| Ford           | 10%       | 11%       | 12%       | 15%       | 12%       | 13%        |
| General Motors | 3%        | 5%        | 6%        | 6%        | 5%        | 9%         |
| Honda          | 4%        | 5%        | 6%        | 7%        | 9%        | 14%        |
| Hyundai        | 4%        | 5%        | 6%        | 7%        | 7%        | 13%        |
| JLR            | 5%        | 7%        | 8%        | 9%        | 9%        | 11%        |
| Kia            | 5%        | 5%        | 6%        | 7%        | 8%        | 12%        |
| Lucid          | 0%        | 0%        | 0%        | 0%        | 0%        | 0%         |
| Mazda          | 3%        | 6%        | 5%        | 7%        | 7%        | 8%         |
| McLaren        | 8%        | 8%        | 10%       | 14%       | 18%       | 17%        |
| Mercedes Benz  | 5%        | 7%        | 7%        | 10%       | 10%       | 12%        |
| Mitsubishi     | 7%        | 8%        | 9%        | 10%       | 10%       | 14%        |
| Nissan         | 4%        | 4%        | 6%        | 6%        | 7%        | 10%        |
| Rivian         | -         | -         | -         | -         | -         | -          |
| Stellantis     | 4%        | 5%        | 6%        | 8%        | 8%        | 15%        |
| Subaru         | 5%        | 6%        | 7%        | 7%        | 8%        | 14%        |
| Tesla          | 0%        | 0%        | 0%        | 0%        | 0%        | 0%         |
| Toyota         | 5%        | 5%        | 6%        | 6%        | 7%        | 9%         |
| Volvo          | 7%        | 7%        | 7%        | 7%        | 7%        | 8%         |
| VW             | 6%        | 6%        | 8%        | 9%        | 9%        | 11%        |
| <b>TOTAL</b>   | <b>4%</b> | <b>5%</b> | <b>6%</b> | <b>7%</b> | <b>7%</b> | <b>10%</b> |

**Table 12-59: Projected PHEV Penetrations, No Action - Trucks**

| Manufacturer   | 2027      | 2028      | 2029      | 2030      | 2031      | 2032       |
|----------------|-----------|-----------|-----------|-----------|-----------|------------|
| Aston Martin   | 5%        | 8%        | 8%        | 10%       | 11%       | 19%        |
| BMW            | 8%        | 8%        | 10%       | 13%       | 13%       | 19%        |
| Ferrari        | -         | -         | -         | -         | -         | -          |
| Ford           | 4%        | 4%        | 8%        | 10%       | 7%        | 12%        |
| General Motors | 5%        | 4%        | 5%        | 8%        | 7%        | 12%        |
| Honda          | 4%        | 6%        | 7%        | 9%        | 12%       | 14%        |
| Hyundai        | 6%        | 7%        | 8%        | 11%       | 12%       | 19%        |
| JLR            | 7%        | 9%        | 8%        | 9%        | 10%       | 14%        |
| Kia            | 5%        | 6%        | 7%        | 9%        | 9%        | 13%        |
| Lucid          | -         | -         | -         | -         | -         | -          |
| Mazda          | 6%        | 9%        | 7%        | 8%        | 9%        | 15%        |
| McLaren        | -         | -         | -         | -         | -         | -          |
| Mercedes Benz  | 5%        | 7%        | 8%        | 9%        | 11%       | 15%        |
| Mitsubishi     | 3%        | 4%        | 5%        | 6%        | 7%        | 12%        |
| Nissan         | 4%        | 4%        | 8%        | 6%        | 10%       | 13%        |
| Rivian         | 0%        | 0%        | 0%        | 0%        | 0%        | 0%         |
| Stellantis     | 9%        | 7%        | 9%        | 10%       | 10%       | 13%        |
| Subaru         | 5%        | 7%        | 8%        | 9%        | 10%       | 16%        |
| Tesla          | 0%        | 0%        | 0%        | 0%        | 0%        | 0%         |
| Toyota         | 7%        | 7%        | 8%        | 9%        | 10%       | 13%        |
| Volvo          | 24%       | 24%       | 24%       | 24%       | 24%       | 26%        |
| VW             | 6%        | 7%        | 8%        | 9%        | 10%       | 12%        |
| <b>TOTAL</b>   | <b>6%</b> | <b>6%</b> | <b>8%</b> | <b>9%</b> | <b>9%</b> | <b>13%</b> |

**Table 12-60: Projected PHEV Penetrations, No Action - Combined**

| Manufacturer   | 2027      | 2028      | 2029      | 2030      | 2031      | 2032       |
|----------------|-----------|-----------|-----------|-----------|-----------|------------|
| Aston Martin   | 5%        | 8%        | 8%        | 9%        | 10%       | 14%        |
| BMW            | 7%        | 7%        | 9%        | 11%       | 11%       | 15%        |
| Ferrari        | 20%       | 20%       | 20%       | 23%       | 25%       | 27%        |
| Ford           | 5%        | 5%        | 9%        | 10%       | 7%        | 12%        |
| General Motors | 5%        | 4%        | 5%        | 7%        | 6%        | 11%        |
| Honda          | 4%        | 5%        | 7%        | 8%        | 10%       | 14%        |
| Hyundai        | 5%        | 6%        | 7%        | 9%        | 10%       | 16%        |
| JLR            | 7%        | 9%        | 8%        | 9%        | 10%       | 14%        |
| Kia            | 5%        | 6%        | 7%        | 8%        | 8%        | 13%        |
| Lucid          | 0%        | 0%        | 0%        | 0%        | 0%        | 0%         |
| Mazda          | 5%        | 9%        | 7%        | 8%        | 9%        | 14%        |
| McLaren        | 8%        | 8%        | 10%       | 14%       | 18%       | 17%        |
| Mercedes Benz  | 5%        | 7%        | 8%        | 9%        | 10%       | 14%        |
| Mitsubishi     | 5%        | 6%        | 7%        | 8%        | 9%        | 14%        |
| Nissan         | 4%        | 4%        | 7%        | 6%        | 8%        | 11%        |
| Rivian         | 0%        | 0%        | 0%        | 0%        | 0%        | 0%         |
| Stellantis     | 8%        | 7%        | 9%        | 10%       | 10%       | 13%        |
| Subaru         | 5%        | 7%        | 8%        | 9%        | 10%       | 15%        |
| Tesla          | 0%        | 0%        | 0%        | 0%        | 0%        | 0%         |
| Toyota         | 6%        | 6%        | 7%        | 8%        | 9%        | 11%        |
| Volvo          | 20%       | 21%       | 21%       | 21%       | 21%       | 22%        |
| VW             | 6%        | 7%        | 8%        | 9%        | 10%       | 12%        |
| <b>TOTAL</b>   | <b>5%</b> | <b>6%</b> | <b>7%</b> | <b>8%</b> | <b>8%</b> | <b>12%</b> |

The tables below provide summary technology penetrations for the No Action case for strong hybrids, TURB12 (only non-Miller engines) and MIL (Miller cycle engines). For these tables, strong hybrids include all engine types, while the TURB12 and MIL penetrations shown are only for non-hybrid versions of those vehicles.

**Table 12-61: Projected Strong HEV Penetrations, No Action**

|              | 2027      | 2028      | 2029      | 2030      | 2031      | 2032      |
|--------------|-----------|-----------|-----------|-----------|-----------|-----------|
| Cars         | 3%        | 2%        | 2%        | 2%        | 1%        | 1%        |
| Trucks       | 4%        | 4%        | 4%        | 4%        | 6%        | 6%        |
| <b>Total</b> | <b>4%</b> | <b>3%</b> | <b>3%</b> | <b>3%</b> | <b>5%</b> | <b>5%</b> |

**Table 12-62: Projected TURB12 Penetrations, No Action**

|              | 2027       | 2028       | 2029       | 2030       | 2031       | 2032       |
|--------------|------------|------------|------------|------------|------------|------------|
| Cars         | 37%        | 28%        | 26%        | 25%        | 23%        | 21%        |
| Trucks       | 53%        | 50%        | 46%        | 44%        | 40%        | 36%        |
| <b>Total</b> | <b>48%</b> | <b>43%</b> | <b>40%</b> | <b>39%</b> | <b>35%</b> | <b>32%</b> |

**Table 12-63: Projected MIL Penetrations, No Action**

|              | 2027      | 2028      | 2029      | 2030      | 2031      | 2032      |
|--------------|-----------|-----------|-----------|-----------|-----------|-----------|
| Cars         | 5%        | 3%        | 2%        | 2%        | 2%        | 2%        |
| Trucks       | 2%        | 1%        | 1%        | 1%        | 1%        | 1%        |
| <b>Total</b> | <b>3%</b> | <b>1%</b> | <b>1%</b> | <b>1%</b> | <b>1%</b> | <b>1%</b> |

### 12.1.3.2 Final Standards

Table 12-64 through Table 12-66 give BEV penetrations for the Final Standards, by manufacturer. Similarly,

Table 12-67 through Table 12-69 provide PHEV penetrations.

**Table 12-64: Projected BEV Penetrations, Final Standards - Cars**

| Manufacturer   | 2027       | 2028       | 2029       | 2030       | 2031       | 2032       |
|----------------|------------|------------|------------|------------|------------|------------|
| Aston Martin   | 31%        | 29%        | 39%        | 48%        | 49%        | 50%        |
| BMW            | 21%        | 35%        | 47%        | 60%        | 58%        | 63%        |
| Ferrari        | 23%        | 31%        | 31%        | 39%        | 47%        | 53%        |
| Ford           | 35%        | 37%        | 42%        | 45%        | 53%        | 56%        |
| General Motors | 27%        | 29%        | 37%        | 40%        | 49%        | 54%        |
| Honda          | 28%        | 35%        | 46%        | 56%        | 60%        | 66%        |
| Hyundai        | 30%        | 37%        | 41%        | 47%        | 51%        | 58%        |
| JLR            | 29%        | 35%        | 35%        | 35%        | 37%        | 37%        |
| Kia            | 32%        | 39%        | 44%        | 56%        | 55%        | 64%        |
| Lucid          | 100%       | 100%       | 100%       | 100%       | 100%       | 100%       |
| Mazda          | 31%        | 39%        | 45%        | 46%        | 49%        | 53%        |
| McLaren        | 27%        | 33%        | 35%        | 46%        | 57%        | 61%        |
| Mercedes Benz  | 29%        | 31%        | 36%        | 40%        | 42%        | 53%        |
| Mitsubishi     | 26%        | 31%        | 38%        | 45%        | 49%        | 54%        |
| Nissan         | 26%        | 34%        | 45%        | 47%        | 53%        | 59%        |
| Rivian         | -          | -          | -          | -          | -          | -          |
| Stellantis     | 23%        | 30%        | 46%        | 55%        | 66%        | 68%        |
| Subaru         | 26%        | 32%        | 44%        | 46%        | 50%        | 62%        |
| Tesla          | 100%       | 100%       | 100%       | 100%       | 100%       | 100%       |
| Toyota         | 31%        | 36%        | 46%        | 53%        | 53%        | 60%        |
| Volvo          | 51%        | 57%        | 65%        | 56%        | 68%        | 71%        |
| VW             | 40%        | 36%        | 44%        | 47%        | 50%        | 57%        |
| <b>TOTAL</b>   | <b>35%</b> | <b>39%</b> | <b>48%</b> | <b>54%</b> | <b>57%</b> | <b>63%</b> |

**Table 12-65: Projected BEV Penetrations, Final Standards - Trucks**

| Manufacturer   | 2027       | 2028       | 2029       | 2030       | 2031       | 2032       |
|----------------|------------|------------|------------|------------|------------|------------|
| Aston Martin   | 20%        | 24%        | 34%        | 37%        | 49%        | 59%        |
| BMW            | 20%        | 28%        | 29%        | 32%        | 46%        | 47%        |
| Ferrari        | -          | -          | -          | -          | -          | -          |
| Ford           | 21%        | 25%        | 35%        | 40%        | 48%        | 53%        |
| General Motors | 19%        | 24%        | 33%        | 37%        | 46%        | 54%        |
| Honda          | 22%        | 27%        | 30%        | 36%        | 45%        | 48%        |
| Hyundai        | 23%        | 26%        | 35%        | 42%        | 49%        | 51%        |
| JLR            | 24%        | 27%        | 36%        | 42%        | 47%        | 51%        |
| Kia            | 22%        | 26%        | 32%        | 37%        | 48%        | 49%        |
| Lucid          | -          | -          | -          | -          | -          | -          |
| Mazda          | 23%        | 27%        | 35%        | 42%        | 49%        | 52%        |
| McLaren        | -          | -          | -          | -          | -          | -          |
| Mercedes Benz  | 24%        | 30%        | 37%        | 45%        | 52%        | 53%        |
| Mitsubishi     | 23%        | 27%        | 35%        | 41%        | 47%        | 50%        |
| Nissan         | 23%        | 27%        | 30%        | 41%        | 52%        | 56%        |
| Rivian         | 100%       | 100%       | 100%       | 100%       | 100%       | 100%       |
| Stellantis     | 20%        | 23%        | 32%        | 36%        | 43%        | 50%        |
| Subaru         | 24%        | 27%        | 35%        | 42%        | 48%        | 50%        |
| Tesla          | 100%       | 100%       | 100%       | 100%       | 100%       | 100%       |
| Toyota         | 19%        | 25%        | 30%        | 37%        | 47%        | 50%        |
| Volvo          | 17%        | 16%        | 24%        | 33%        | 37%        | 40%        |
| VW             | 25%        | 27%        | 40%        | 45%        | 52%        | 54%        |
| <b>TOTAL</b>   | <b>23%</b> | <b>27%</b> | <b>34%</b> | <b>40%</b> | <b>48%</b> | <b>52%</b> |

**Table 12-66: Projected BEV Penetrations, Final Standards - Combined**

| Manufacturer   | 2027       | 2028       | 2029       | 2030       | 2031       | 2032       |
|----------------|------------|------------|------------|------------|------------|------------|
| Aston Martin   | 26%        | 27%        | 37%        | 43%        | 49%        | 54%        |
| BMW            | 21%        | 31%        | 36%        | 43%        | 51%        | 53%        |
| Ferrari        | 23%        | 31%        | 31%        | 39%        | 47%        | 53%        |
| Ford           | 22%        | 26%        | 36%        | 40%        | 49%        | 53%        |
| General Motors | 21%        | 25%        | 34%        | 38%        | 47%        | 54%        |
| Honda          | 25%        | 30%        | 37%        | 45%        | 51%        | 56%        |
| Hyundai        | 26%        | 31%        | 38%        | 44%        | 50%        | 55%        |
| JLR            | 24%        | 27%        | 36%        | 42%        | 47%        | 50%        |
| Kia            | 27%        | 32%        | 38%        | 46%        | 51%        | 56%        |
| Lucid          | 100%       | 100%       | 100%       | 100%       | 100%       | 100%       |
| Mazda          | 24%        | 28%        | 36%        | 43%        | 49%        | 52%        |
| McLaren        | 27%        | 33%        | 35%        | 46%        | 57%        | 61%        |
| Mercedes Benz  | 26%        | 30%        | 37%        | 43%        | 49%        | 53%        |
| Mitsubishi     | 25%        | 29%        | 37%        | 43%        | 48%        | 52%        |
| Nissan         | 25%        | 31%        | 38%        | 44%        | 52%        | 57%        |
| Rivian         | 100%       | 100%       | 100%       | 100%       | 100%       | 100%       |
| Stellantis     | 20%        | 24%        | 33%        | 38%        | 46%        | 52%        |
| Subaru         | 24%        | 28%        | 36%        | 43%        | 48%        | 52%        |
| Tesla          | 100%       | 100%       | 100%       | 100%       | 100%       | 100%       |
| Toyota         | 24%        | 29%        | 36%        | 43%        | 49%        | 54%        |
| Volvo          | 25%        | 26%        | 33%        | 38%        | 44%        | 47%        |
| VW             | 30%        | 30%        | 41%        | 45%        | 52%        | 55%        |
| <b>TOTAL</b>   | <b>26%</b> | <b>31%</b> | <b>39%</b> | <b>44%</b> | <b>51%</b> | <b>56%</b> |

**Table 12-67: Projected PHEV Penetrations, Final Standards - Cars**

| Manufacturer   | 2027      | 2028      | 2029      | 2030      | 2031      | 2032       |
|----------------|-----------|-----------|-----------|-----------|-----------|------------|
| Aston Martin   | 6%        | 8%        | 9%        | 10%       | 11%       | 12%        |
| BMW            | 5%        | 7%        | 7%        | 8%        | 8%        | 12%        |
| Ferrari        | 20%       | 21%       | 23%       | 24%       | 25%       | 23%        |
| Ford           | 11%       | 11%       | 13%       | 13%       | 14%       | 16%        |
| General Motors | 4%        | 5%        | 7%        | 8%        | 9%        | 12%        |
| Honda          | 4%        | 5%        | 7%        | 10%       | 12%       | 9%         |
| Hyundai        | 4%        | 4%        | 6%        | 7%        | 12%       | 10%        |
| JLR            | 5%        | 7%        | 8%        | 9%        | 10%       | 13%        |
| Kia            | 5%        | 6%        | 8%        | 7%        | 11%       | 10%        |
| Lucid          | 0%        | 0%        | 0%        | 0%        | 0%        | 0%         |
| Mazda          | 4%        | 5%        | 9%        | 10%       | 15%       | 16%        |
| McLaren        | 8%        | 9%        | 10%       | 11%       | 12%       | 12%        |
| Mercedes Benz  | 5%        | 6%        | 8%        | 16%       | 11%       | 15%        |
| Mitsubishi     | 7%        | 7%        | 9%        | 10%       | 13%       | 15%        |
| Nissan         | 5%        | 4%        | 5%        | 6%        | 6%        | 8%         |
| Rivian         | -         | -         | -         | -         | -         | -          |
| Stellantis     | 6%        | 5%        | 6%        | 7%        | 8%        | 10%        |
| Subaru         | 5%        | 6%        | 5%        | 10%       | 16%       | 7%         |
| Tesla          | 0%        | 0%        | 0%        | 0%        | 0%        | 0%         |
| Toyota         | 4%        | 5%        | 6%        | 7%        | 9%        | 10%        |
| Volvo          | 7%        | 7%        | 7%        | 7%        | 7%        | 7%         |
| VW             | 5%        | 7%        | 7%        | 9%        | 10%       | 10%        |
| <b>TOTAL</b>   | <b>4%</b> | <b>5%</b> | <b>6%</b> | <b>8%</b> | <b>9%</b> | <b>10%</b> |

**Table 12-68: Projected PHEV Penetrations, Final Standards - Trucks**

| Manufacturer   | 2027      | 2028      | 2029      | 2030       | 2031       | 2032       |
|----------------|-----------|-----------|-----------|------------|------------|------------|
| Aston Martin   | 5%        | 10%       | 9%        | 10%        | 12%        | 12%        |
| BMW            | 8%        | 15%       | 17%       | 18%        | 9%         | 22%        |
| Ferrari        | -         | -         | -         | -          | -          | -          |
| Ford           | 6%        | 5%        | 6%        | 8%         | 9%         | 11%        |
| General Motors | 6%        | 4%        | 6%        | 9%         | 10%        | 13%        |
| Honda          | 4%        | 6%        | 9%        | 9%         | 10%        | 14%        |
| Hyundai        | 6%        | 7%        | 8%        | 9%         | 10%        | 13%        |
| JLR            | 6%        | 7%        | 9%        | 10%        | 14%        | 17%        |
| Kia            | 5%        | 6%        | 8%        | 10%        | 9%         | 14%        |
| Lucid          | -         | -         | -         | -          | -          | -          |
| Mazda          | 6%        | 7%        | 9%        | 9%         | 11%        | 14%        |
| McLaren        | -         | -         | -         | -          | -          | -          |
| Mercedes Benz  | 5%        | 7%        | 9%        | 10%        | 15%        | 17%        |
| Mitsubishi     | 3%        | 4%        | 5%        | 7%         | 9%         | 12%        |
| Nissan         | 4%        | 5%        | 8%        | 8%         | 7%         | 9%         |
| Rivian         | 0%        | 0%        | 0%        | 0%         | 0%         | 0%         |
| Stellantis     | 8%        | 9%        | 10%       | 13%        | 16%        | 17%        |
| Subaru         | 5%        | 7%        | 8%        | 9%         | 11%        | 15%        |
| Tesla          | 0%        | 0%        | 0%        | 0%         | 0%         | 0%         |
| Toyota         | 7%        | 7%        | 9%        | 11%        | 12%        | 16%        |
| Volvo          | 24%       | 24%       | 24%       | 24%        | 24%        | 26%        |
| VW             | 6%        | 8%        | 8%        | 10%        | 11%        | 12%        |
| <b>TOTAL</b>   | <b>6%</b> | <b>7%</b> | <b>8%</b> | <b>10%</b> | <b>11%</b> | <b>14%</b> |



**Table 12-69: Projected PHEV Penetrations, Final Standards - Combined**

| Manufacturer   | 2027      | 2028      | 2029      | 2030      | 2031       | 2032       |
|----------------|-----------|-----------|-----------|-----------|------------|------------|
| Aston Martin   | 5%        | 9%        | 9%        | 10%       | 11%        | 12%        |
| BMW            | 6%        | 12%       | 13%       | 14%       | 9%         | 18%        |
| Ferrari        | 20%       | 21%       | 23%       | 24%       | 25%        | 23%        |
| Ford           | 6%        | 5%        | 7%        | 8%        | 10%        | 11%        |
| General Motors | 5%        | 4%        | 7%        | 9%        | 10%        | 13%        |
| Honda          | 4%        | 6%        | 8%        | 9%        | 11%        | 12%        |
| Hyundai        | 5%        | 5%        | 7%        | 8%        | 11%        | 12%        |
| JLR            | 6%        | 7%        | 9%        | 10%       | 14%        | 16%        |
| Kia            | 5%        | 6%        | 8%        | 9%        | 10%        | 12%        |
| Lucid          | 0%        | 0%        | 0%        | 0%        | 0%         | 0%         |
| Mazda          | 6%        | 7%        | 9%        | 9%        | 12%        | 14%        |
| McLaren        | 8%        | 9%        | 10%       | 11%       | 12%        | 12%        |
| Mercedes Benz  | 5%        | 7%        | 8%        | 12%       | 14%        | 16%        |
| Mitsubishi     | 5%        | 6%        | 7%        | 8%        | 11%        | 14%        |
| Nissan         | 4%        | 4%        | 6%        | 7%        | 7%         | 9%         |
| Rivian         | 0%        | 0%        | 0%        | 0%        | 0%         | 0%         |
| Stellantis     | 8%        | 8%        | 9%        | 12%       | 15%        | 16%        |
| Subaru         | 5%        | 7%        | 8%        | 10%       | 12%        | 14%        |
| Tesla          | 0%        | 0%        | 0%        | 0%        | 0%         | 0%         |
| Toyota         | 6%        | 6%        | 8%        | 9%        | 11%        | 13%        |
| Volvo          | 20%       | 21%       | 21%       | 21%       | 21%        | 22%        |
| VW             | 6%        | 7%        | 8%        | 9%        | 10%        | 11%        |
| <b>TOTAL</b>   | <b>6%</b> | <b>6%</b> | <b>8%</b> | <b>9%</b> | <b>11%</b> | <b>13%</b> |

The tables below provide summary technology penetrations for the Final Standards for strong hybrids, TURB12 (only non-Miller engines) and MIL (Miller cycle engines). For these tables, strong hybrids include all engine types, while the TURB12 and MIL penetrations shown are only for non-hybrid versions of those vehicles.

**Table 12-70: Projected Strong HEV Penetrations, Final Standards**

|              | 2027      | 2028      | 2029      | 2030      | 2031      | 2032      |
|--------------|-----------|-----------|-----------|-----------|-----------|-----------|
| Cars         | 3%        | 6%        | 5%        | 5%        | 4%        | 3%        |
| Trucks       | 4%        | 3%        | 3%        | 3%        | 2%        | 2%        |
| <b>Total</b> | <b>4%</b> | <b>4%</b> | <b>4%</b> | <b>3%</b> | <b>3%</b> | <b>2%</b> |

**Table 12-71: Projected TURB12 Penetrations, Final Standards**

|              | 2027       | 2028       | 2029       | 2030       | 2031       | 2032       |
|--------------|------------|------------|------------|------------|------------|------------|
| Cars         | 37%        | 23%        | 19%        | 16%        | 14%        | 11%        |
| Trucks       | 52%        | 48%        | 41%        | 36%        | 29%        | 24%        |
| <b>Total</b> | <b>47%</b> | <b>40%</b> | <b>34%</b> | <b>30%</b> | <b>24%</b> | <b>20%</b> |

**Table 12-72: Projected MIL Penetrations, Final Standards**

|              | 2027      | 2028      | 2029      | 2030      | 2031      | 2032      |
|--------------|-----------|-----------|-----------|-----------|-----------|-----------|
| Cars         | 5%        | 4%        | 4%        | 3%        | 3%        | 2%        |
| Trucks       | 2%        | 1%        | 1%        | 1%        | 1%        | 1%        |
| <b>Total</b> | <b>3%</b> | <b>2%</b> | <b>2%</b> | <b>2%</b> | <b>1%</b> | <b>1%</b> |

### 12.1.3.3 Alternative A

Table 12-73 through Table 12-75 give BEV penetrations for Alternative A, by manufacturer. Similarly, Table 12-76 through Table 12-78 provide PHEV penetrations.

**Table 12-73: Projected BEV Penetrations, Alternative A - Cars**

| Manufacturer   | 2027       | 2028       | 2029       | 2030       | 2031       | 2032       |
|----------------|------------|------------|------------|------------|------------|------------|
| Aston Martin   | 34%        | 43%        | 53%        | 57%        | 60%        | 63%        |
| BMW            | 23%        | 36%        | 44%        | 45%        | 54%        | 62%        |
| Ferrari        | 24%        | 30%        | 32%        | 41%        | 48%        | 51%        |
| Ford           | 40%        | 42%        | 48%        | 56%        | 56%        | 59%        |
| General Motors | 30%        | 34%        | 42%        | 46%        | 45%        | 50%        |
| Honda          | 35%        | 41%        | 51%        | 56%        | 65%        | 68%        |
| Hyundai        | 36%        | 41%        | 46%        | 53%        | 57%        | 64%        |
| JLR            | 33%        | 50%        | 43%        | 48%        | 55%        | 60%        |
| Kia            | 38%        | 46%        | 55%        | 62%        | 65%        | 69%        |
| Lucid          | 100%       | 100%       | 100%       | 100%       | 100%       | 100%       |
| Mazda          | 34%        | 41%        | 56%        | 55%        | 72%        | 61%        |
| McLaren        | 28%        | 35%        | 37%        | 49%        | 58%        | 61%        |
| Mercedes Benz  | 40%        | 48%        | 52%        | 54%        | 55%        | 63%        |
| Mitsubishi     | 37%        | 38%        | 45%        | 49%        | 53%        | 57%        |
| Nissan         | 31%        | 40%        | 46%        | 52%        | 60%        | 64%        |
| Rivian         | -          | -          | -          | -          | -          | -          |
| Stellantis     | 35%        | 36%        | 45%        | 42%        | 49%        | 50%        |
| Subaru         | 31%        | 36%        | 40%        | 43%        | 46%        | 59%        |
| Tesla          | 100%       | 100%       | 100%       | 100%       | 100%       | 100%       |
| Toyota         | 33%        | 42%        | 47%        | 48%        | 58%        | 64%        |
| Volvo          | 60%        | 54%        | 60%        | 58%        | 64%        | 67%        |
| VW             | 36%        | 40%        | 49%        | 52%        | 57%        | 56%        |
| <b>TOTAL</b>   | <b>39%</b> | <b>45%</b> | <b>51%</b> | <b>55%</b> | <b>60%</b> | <b>64%</b> |

**Table 12-74: Projected BEV Penetrations, Alternative A - Trucks**

| Manufacturer   | 2027       | 2028       | 2029       | 2030       | 2031       | 2032       |
|----------------|------------|------------|------------|------------|------------|------------|
| Aston Martin   | 29%        | 29%        | 27%        | 39%        | 52%        | 57%        |
| BMW            | 26%        | 36%        | 38%        | 47%        | 51%        | 52%        |
| Ferrari        | -          | -          | -          | -          | -          | -          |
| Ford           | 27%        | 34%        | 43%        | 46%        | 48%        | 51%        |
| General Motors | 25%        | 33%        | 41%        | 46%        | 49%        | 53%        |
| Honda          | 33%        | 35%        | 37%        | 43%        | 47%        | 52%        |
| Hyundai        | 35%        | 36%        | 40%        | 45%        | 52%        | 54%        |
| JLR            | 36%        | 37%        | 43%        | 47%        | 52%        | 57%        |
| Kia            | 35%        | 34%        | 35%        | 41%        | 49%        | 52%        |
| Lucid          | -          | -          | -          | -          | -          | -          |
| Mazda          | 36%        | 35%        | 40%        | 44%        | 50%        | 56%        |
| McLaren        | -          | -          | -          | -          | -          | -          |
| Mercedes Benz  | 34%        | 34%        | 39%        | 45%        | 52%        | 56%        |
| Mitsubishi     | 35%        | 36%        | 42%        | 46%        | 52%        | 56%        |
| Nissan         | 29%        | 31%        | 40%        | 45%        | 48%        | 51%        |
| Rivian         | 100%       | 100%       | 100%       | 100%       | 100%       | 100%       |
| Stellantis     | 25%        | 32%        | 41%        | 44%        | 46%        | 50%        |
| Subaru         | 37%        | 36%        | 43%        | 47%        | 54%        | 57%        |
| Tesla          | 100%       | 100%       | 100%       | 100%       | 100%       | 100%       |
| Toyota         | 30%        | 33%        | 39%        | 45%        | 49%        | 50%        |
| Volvo          | 22%        | 25%        | 31%        | 37%        | 42%        | 45%        |
| VW             | 40%        | 39%        | 42%        | 46%        | 56%        | 61%        |
| <b>TOTAL</b>   | <b>31%</b> | <b>35%</b> | <b>42%</b> | <b>46%</b> | <b>50%</b> | <b>53%</b> |

**Table 12-75: Projected BEV Penetrations, Alternative A - Combined**

| Manufacturer   | 2027       | 2028       | 2029       | 2030       | 2031       | 2032       |
|----------------|------------|------------|------------|------------|------------|------------|
| Aston Martin   | 32%        | 38%        | 42%        | 50%        | 56%        | 60%        |
| BMW            | 25%        | 36%        | 41%        | 46%        | 52%        | 56%        |
| Ferrari        | 24%        | 30%        | 32%        | 41%        | 48%        | 51%        |
| Ford           | 29%        | 35%        | 43%        | 47%        | 48%        | 52%        |
| General Motors | 26%        | 34%        | 42%        | 46%        | 48%        | 52%        |
| Honda          | 34%        | 37%        | 43%        | 49%        | 55%        | 59%        |
| Hyundai        | 36%        | 39%        | 43%        | 49%        | 54%        | 59%        |
| JLR            | 36%        | 38%        | 43%        | 47%        | 52%        | 57%        |
| Kia            | 36%        | 39%        | 44%        | 50%        | 56%        | 60%        |
| Lucid          | 100%       | 100%       | 100%       | 100%       | 100%       | 100%       |
| Mazda          | 36%        | 36%        | 42%        | 45%        | 53%        | 57%        |
| McLaren        | 28%        | 35%        | 37%        | 49%        | 58%        | 61%        |
| Mercedes Benz  | 36%        | 38%        | 43%        | 48%        | 53%        | 58%        |
| Mitsubishi     | 36%        | 37%        | 44%        | 48%        | 52%        | 57%        |
| Nissan         | 30%        | 36%        | 43%        | 49%        | 54%        | 59%        |
| Rivian         | 100%       | 100%       | 100%       | 100%       | 100%       | 100%       |
| Stellantis     | 26%        | 32%        | 41%        | 44%        | 46%        | 50%        |
| Subaru         | 36%        | 36%        | 42%        | 46%        | 53%        | 57%        |
| Tesla          | 100%       | 100%       | 100%       | 100%       | 100%       | 100%       |
| Toyota         | 31%        | 36%        | 42%        | 46%        | 52%        | 55%        |
| Volvo          | 31%        | 32%        | 37%        | 42%        | 47%        | 50%        |
| VW             | 39%        | 39%        | 44%        | 48%        | 56%        | 59%        |
| <b>TOTAL</b>   | <b>33%</b> | <b>38%</b> | <b>45%</b> | <b>49%</b> | <b>53%</b> | <b>57%</b> |

**Table 12-76: Projected PHEV Penetrations, Alternative A - Cars**

| Manufacturer   | 2027      | 2028      | 2029      | 2030      | 2031      | 2032      |
|----------------|-----------|-----------|-----------|-----------|-----------|-----------|
| Aston Martin   | 7%        | 8%        | 9%        | 11%       | 12%       | 11%       |
| BMW            | 5%        | 6%        | 8%        | 8%        | 9%        | 14%       |
| Ferrari        | 20%       | 21%       | 23%       | 23%       | 24%       | 24%       |
| Ford           | 12%       | 12%       | 15%       | 12%       | 14%       | 15%       |
| General Motors | 5%        | 6%        | 9%        | 10%       | 13%       | 15%       |
| Honda          | 4%        | 7%        | 7%        | 8%        | 8%        | 9%        |
| Hyundai        | 4%        | 5%        | 7%        | 7%        | 8%        | 9%        |
| JLR            | 14%       | 7%        | 8%        | 9%        | 9%        | 10%       |
| Kia            | 4%        | 6%        | 7%        | 7%        | 7%        | 8%        |
| Lucid          | 0%        | 0%        | 0%        | 0%        | 0%        | 0%        |
| Mazda          | 5%        | 6%        | 5%        | 15%       | 8%        | 17%       |
| McLaren        | 9%        | 12%       | 14%       | 12%       | 12%       | 12%       |
| Mercedes Benz  | 3%        | 7%        | 9%        | 9%        | 10%       | 11%       |
| Mitsubishi     | 7%        | 9%        | 10%       | 10%       | 12%       | 14%       |
| Nissan         | 5%        | 5%        | 6%        | 6%        | 7%        | 7%        |
| Rivian         | -         | -         | -         | -         | -         | -         |
| Stellantis     | 4%        | 5%        | 6%        | 8%        | 8%        | 9%        |
| Subaru         | 6%        | 6%        | 7%        | 10%       | 13%       | 9%        |
| Tesla          | 0%        | 0%        | 0%        | 0%        | 0%        | 0%        |
| Toyota         | 4%        | 5%        | 8%        | 6%        | 7%        | 8%        |
| Volvo          | 7%        | 7%        | 7%        | 7%        | 7%        | 9%        |
| VW             | 5%        | 7%        | 8%        | 14%       | 10%       | 10%       |
| <b>TOTAL</b>   | <b>4%</b> | <b>6%</b> | <b>7%</b> | <b>7%</b> | <b>8%</b> | <b>9%</b> |

**Table 12-77: Projected PHEV Penetrations, Alternative A - Trucks**

| Manufacturer   | 2027      | 2028      | 2029       | 2030       | 2031       | 2032       |
|----------------|-----------|-----------|------------|------------|------------|------------|
| Aston Martin   | 7%        | 9%        | 16%        | 15%        | 12%        | 13%        |
| BMW            | 12%       | 14%       | 17%        | 18%        | 18%        | 18%        |
| Ferrari        | -         | -         | -          | -          | -          | -          |
| Ford           | 6%        | 7%        | 10%        | 10%        | 10%        | 11%        |
| General Motors | 6%        | 7%        | 11%        | 11%        | 12%        | 14%        |
| Honda          | 3%        | 6%        | 9%         | 10%        | 12%        | 14%        |
| Hyundai        | 5%        | 7%        | 9%         | 11%        | 13%        | 15%        |
| JLR            | 3%        | 8%        | 10%        | 12%        | 13%        | 14%        |
| Kia            | 4%        | 6%        | 11%        | 11%        | 9%         | 12%        |
| Lucid          | -         | -         | -          | -          | -          | -          |
| Mazda          | 3%        | 7%        | 9%         | 9%         | 11%        | 12%        |
| McLaren        | -         | -         | -          | -          | -          | -          |
| Mercedes Benz  | 3%        | 8%        | 10%        | 10%        | 11%        | 12%        |
| Mitsubishi     | 2%        | 5%        | 6%         | 7%         | 8%         | 10%        |
| Nissan         | 5%        | 6%        | 7%         | 8%         | 9%         | 11%        |
| Rivian         | 0%        | 0%        | 0%         | 0%         | 0%         | 0%         |
| Stellantis     | 8%        | 10%       | 12%        | 13%        | 15%        | 17%        |
| Subaru         | 3%        | 8%        | 9%         | 10%        | 11%        | 12%        |
| Tesla          | 0%        | 0%        | 0%         | 0%         | 0%         | 0%         |
| Toyota         | 5%        | 8%        | 10%        | 10%        | 11%        | 16%        |
| Volvo          | 24%       | 24%       | 24%        | 24%        | 24%        | 27%        |
| VW             | 4%        | 8%        | 9%         | 10%        | 11%        | 11%        |
| <b>TOTAL</b>   | <b>6%</b> | <b>8%</b> | <b>10%</b> | <b>11%</b> | <b>12%</b> | <b>14%</b> |

**Table 12-78: Projected PHEV Penetrations, Alternative A - Combined**

| Manufacturer   | 2027      | 2028      | 2029      | 2030       | 2031       | 2032       |
|----------------|-----------|-----------|-----------|------------|------------|------------|
| Aston Martin   | 7%        | 8%        | 12%       | 12%        | 12%        | 12%        |
| BMW            | 9%        | 11%       | 13%       | 14%        | 14%        | 17%        |
| Ferrari        | 20%       | 21%       | 23%       | 23%        | 24%        | 24%        |
| Ford           | 7%        | 7%        | 10%       | 10%        | 10%        | 11%        |
| General Motors | 6%        | 7%        | 11%       | 11%        | 12%        | 14%        |
| Honda          | 3%        | 7%        | 8%        | 9%         | 10%        | 12%        |
| Hyundai        | 4%        | 6%        | 8%        | 9%         | 11%        | 13%        |
| JLR            | 3%        | 8%        | 10%       | 12%        | 13%        | 14%        |
| Kia            | 4%        | 6%        | 9%        | 9%         | 8%         | 11%        |
| Lucid          | 0%        | 0%        | 0%        | 0%         | 0%         | 0%         |
| Mazda          | 3%        | 7%        | 8%        | 10%        | 10%        | 12%        |
| McLaren        | 9%        | 12%       | 14%       | 12%        | 12%        | 12%        |
| Mercedes Benz  | 3%        | 8%        | 10%       | 10%        | 11%        | 12%        |
| Mitsubishi     | 5%        | 7%        | 8%        | 8%         | 10%        | 12%        |
| Nissan         | 5%        | 5%        | 6%        | 7%         | 8%         | 9%         |
| Rivian         | 0%        | 0%        | 0%        | 0%         | 0%         | 0%         |
| Stellantis     | 8%        | 9%        | 11%       | 12%        | 14%        | 16%        |
| Subaru         | 4%        | 7%        | 9%        | 10%        | 11%        | 12%        |
| Tesla          | 0%        | 0%        | 0%        | 0%         | 0%         | 0%         |
| Toyota         | 5%        | 7%        | 9%        | 8%         | 10%        | 13%        |
| Volvo          | 20%       | 21%       | 21%       | 21%        | 21%        | 23%        |
| VW             | 4%        | 8%        | 9%        | 11%        | 11%        | 11%        |
| <b>TOTAL</b>   | <b>5%</b> | <b>7%</b> | <b>9%</b> | <b>10%</b> | <b>11%</b> | <b>12%</b> |

The tables below provide summary technology penetrations for Alternative A for strong hybrids, TURB12 (only non-Miller engines) and MIL (Miller cycle engines). For these tables, strong hybrids include all engine types, while the TURB12 and MIL penetrations shown are only for non-hybrid versions of those vehicles.

**Table 12-79: Projected Strong HEV Penetrations, Alternative A**

|              | 2027      | 2028      | 2029      | 2030      | 2031      | 2032      |
|--------------|-----------|-----------|-----------|-----------|-----------|-----------|
| Cars         | 3%        | 4%        | 3%        | 3%        | 2%        | 2%        |
| Trucks       | 3%        | 4%        | 3%        | 5%        | 7%        | 6%        |
| <b>Total</b> | <b>3%</b> | <b>4%</b> | <b>3%</b> | <b>5%</b> | <b>5%</b> | <b>5%</b> |

**Table 12-80: Projected TURB12 Penetrations, Alternative A**

|              | 2027       | 2028       | 2029       | 2030       | 2031       | 2032       |
|--------------|------------|------------|------------|------------|------------|------------|
| Cars         | 34%        | 18%        | 15%        | 13%        | 11%        | 9%         |
| Trucks       | 47%        | 35%        | 29%        | 24%        | 20%        | 17%        |
| <b>Total</b> | <b>43%</b> | <b>30%</b> | <b>25%</b> | <b>21%</b> | <b>17%</b> | <b>15%</b> |

**Table 12-81: Projected MIL Penetrations, Alternative A**

|              | 2027      | 2028      | 2029      | 2030      | 2031      | 2032      |
|--------------|-----------|-----------|-----------|-----------|-----------|-----------|
| Cars         | 5%        | 2%        | 2%        | 1%        | 1%        | 1%        |
| Trucks       | 1%        | 1%        | 1%        | 1%        | 1%        | 1%        |
| <b>Total</b> | <b>2%</b> | <b>1%</b> | <b>1%</b> | <b>1%</b> | <b>1%</b> | <b>1%</b> |

### 12.1.3.4 Alternative B

Table 12-82 through Table 12-84 give BEV penetrations for Alternative B, by manufacturer. Similarly, Table 12-85 through Table 12-87 provide PHEV penetrations.

**Table 12-82: Projected BEV Penetrations, Alternative B - Cars**

| Manufacturer   | 2027       | 2028       | 2029       | 2030       | 2031       | 2032       |
|----------------|------------|------------|------------|------------|------------|------------|
| Aston Martin   | 31%        | 39%        | 46%        | 51%        | 56%        | 60%        |
| BMW            | 21%        | 39%        | 53%        | 58%        | 62%        | 65%        |
| Ferrari        | 23%        | 27%        | 32%        | 32%        | 44%        | 52%        |
| Ford           | 36%        | 37%        | 44%        | 48%        | 49%        | 53%        |
| General Motors | 26%        | 28%        | 38%        | 41%        | 45%        | 47%        |
| Honda          | 28%        | 33%        | 42%        | 52%        | 49%        | 59%        |
| Hyundai        | 30%        | 34%        | 45%        | 51%        | 49%        | 56%        |
| JLR            | 27%        | 34%        | 35%        | 35%        | 37%        | 38%        |
| Kia            | 32%        | 40%        | 49%        | 55%        | 54%        | 58%        |
| Lucid          | 100%       | 100%       | 100%       | 100%       | 100%       | 100%       |
| Mazda          | 31%        | 39%        | 45%        | 42%        | 46%        | 48%        |
| McLaren        | 27%        | 33%        | 38%        | 36%        | 52%        | 61%        |
| Mercedes Benz  | 29%        | 33%        | 47%        | 52%        | 53%        | 57%        |
| Mitsubishi     | 26%        | 30%        | 38%        | 43%        | 49%        | 56%        |
| Nissan         | 26%        | 33%        | 42%        | 49%        | 59%        | 67%        |
| Rivian         | -          | -          | -          | -          | -          | -          |
| Stellantis     | 25%        | 28%        | 39%        | 41%        | 41%        | 52%        |
| Subaru         | 26%        | 33%        | 37%        | 39%        | 49%        | 47%        |
| Tesla          | 100%       | 100%       | 100%       | 100%       | 100%       | 100%       |
| Toyota         | 31%        | 35%        | 48%        | 48%        | 59%        | 60%        |
| Volvo          | 51%        | 61%        | 65%        | 65%        | 70%        | 73%        |
| VW             | 39%        | 35%        | 39%        | 41%        | 50%        | 58%        |
| <b>TOTAL</b>   | <b>34%</b> | <b>39%</b> | <b>48%</b> | <b>52%</b> | <b>56%</b> | <b>60%</b> |

**Table 12-83: Projected BEV Penetrations, Alternative B - Trucks**

| Manufacturer   | 2027       | 2028       | 2029       | 2030       | 2031       | 2032       |
|----------------|------------|------------|------------|------------|------------|------------|
| Aston Martin   | 20%        | 22%        | 26%        | 26%        | 44%        | 56%        |
| BMW            | 20%        | 25%        | 28%        | 30%        | 40%        | 51%        |
| Ferrari        | -          | -          | -          | -          | -          | -          |
| Ford           | 21%        | 25%        | 34%        | 38%        | 45%        | 52%        |
| General Motors | 19%        | 24%        | 33%        | 39%        | 43%        | 48%        |
| Honda          | 22%        | 26%        | 33%        | 35%        | 48%        | 53%        |
| Hyundai        | 23%        | 26%        | 32%        | 36%        | 47%        | 56%        |
| JLR            | 24%        | 25%        | 36%        | 43%        | 47%        | 56%        |
| Kia            | 23%        | 24%        | 31%        | 35%        | 46%        | 55%        |
| Lucid          | -          | -          | -          | -          | -          | -          |
| Mazda          | 23%        | 27%        | 36%        | 42%        | 48%        | 54%        |
| McLaren        | -          | -          | -          | -          | -          | -          |
| Mercedes Benz  | 24%        | 28%        | 33%        | 37%        | 46%        | 55%        |
| Mitsubishi     | 23%        | 27%        | 35%        | 41%        | 47%        | 55%        |
| Nissan         | 23%        | 24%        | 32%        | 33%        | 38%        | 46%        |
| Rivian         | 100%       | 100%       | 100%       | 100%       | 100%       | 100%       |
| Stellantis     | 19%        | 23%        | 31%        | 34%        | 40%        | 47%        |
| Subaru         | 24%        | 26%        | 36%        | 42%        | 47%        | 57%        |
| Tesla          | 100%       | 100%       | 100%       | 100%       | 100%       | 100%       |
| Toyota         | 19%        | 24%        | 30%        | 34%        | 41%        | 52%        |
| Volvo          | 17%        | 16%        | 24%        | 31%        | 36%        | 43%        |
| VW             | 25%        | 27%        | 42%        | 44%        | 47%        | 57%        |
| <b>TOTAL</b>   | <b>23%</b> | <b>26%</b> | <b>34%</b> | <b>38%</b> | <b>45%</b> | <b>52%</b> |

**Table 12-84: Projected BEV Penetrations, Alternative B - Combined**

| Manufacturer   | 2027       | 2028       | 2029       | 2030       | 2031       | 2032       |
|----------------|------------|------------|------------|------------|------------|------------|
| Aston Martin   | 27%        | 32%        | 38%        | 41%        | 51%        | 58%        |
| BMW            | 21%        | 31%        | 38%        | 41%        | 49%        | 57%        |
| Ferrari        | 23%        | 27%        | 32%        | 32%        | 44%        | 52%        |
| Ford           | 22%        | 26%        | 35%        | 39%        | 45%        | 52%        |
| General Motors | 21%        | 25%        | 35%        | 40%        | 44%        | 48%        |
| Honda          | 25%        | 29%        | 37%        | 42%        | 49%        | 56%        |
| Hyundai        | 26%        | 30%        | 38%        | 43%        | 48%        | 56%        |
| JLR            | 24%        | 25%        | 36%        | 42%        | 47%        | 55%        |
| Kia            | 27%        | 31%        | 39%        | 44%        | 50%        | 56%        |
| Lucid          | 100%       | 100%       | 100%       | 100%       | 100%       | 100%       |
| Mazda          | 24%        | 28%        | 37%        | 42%        | 47%        | 54%        |
| McLaren        | 27%        | 33%        | 38%        | 36%        | 52%        | 61%        |
| Mercedes Benz  | 26%        | 29%        | 38%        | 42%        | 48%        | 56%        |
| Mitsubishi     | 25%        | 28%        | 36%        | 42%        | 48%        | 55%        |
| Nissan         | 25%        | 29%        | 37%        | 42%        | 50%        | 58%        |
| Rivian         | 100%       | 100%       | 100%       | 100%       | 100%       | 100%       |
| Stellantis     | 20%        | 24%        | 32%        | 35%        | 41%        | 48%        |
| Subaru         | 24%        | 27%        | 36%        | 42%        | 47%        | 56%        |
| Tesla          | 100%       | 100%       | 100%       | 100%       | 100%       | 100%       |
| Toyota         | 24%        | 28%        | 37%        | 40%        | 48%        | 55%        |
| Volvo          | 25%        | 26%        | 34%        | 39%        | 43%        | 50%        |
| VW             | 29%        | 30%        | 41%        | 43%        | 48%        | 57%        |
| <b>TOTAL</b>   | <b>26%</b> | <b>30%</b> | <b>39%</b> | <b>43%</b> | <b>48%</b> | <b>55%</b> |

**Table 12-85: Projected PHEV Penetrations, Alternative B - Cars**

| Manufacturer   | 2027      | 2028      | 2029      | 2030      | 2031      | 2032       |
|----------------|-----------|-----------|-----------|-----------|-----------|------------|
| Aston Martin   | 4%        | 6%        | 8%        | 10%       | 11%       | 12%        |
| BMW            | 5%        | 5%        | 6%        | 10%       | 9%        | 9%         |
| Ferrari        | 20%       | 20%       | 20%       | 25%       | 22%       | 22%        |
| Ford           | 11%       | 11%       | 12%       | 13%       | 14%       | 15%        |
| General Motors | 4%        | 5%        | 6%        | 8%        | 8%        | 12%        |
| Honda          | 4%        | 5%        | 6%        | 9%        | 12%       | 13%        |
| Hyundai        | 4%        | 5%        | 6%        | 8%        | 10%       | 13%        |
| JLR            | 5%        | 7%        | 8%        | 9%        | 10%       | 13%        |
| Kia            | 5%        | 6%        | 6%        | 7%        | 8%        | 12%        |
| Lucid          | 0%        | 0%        | 0%        | 0%        | 0%        | 0%         |
| Mazda          | 4%        | 5%        | 6%        | 11%       | 14%       | 16%        |
| McLaren        | 8%        | 11%       | 12%       | 18%       | 12%       | 12%        |
| Mercedes Benz  | 5%        | 7%        | 8%        | 9%        | 10%       | 10%        |
| Mitsubishi     | 7%        | 8%        | 10%       | 11%       | 12%       | 13%        |
| Nissan         | 5%        | 4%        | 6%        | 5%        | 6%        | 7%         |
| Rivian         | -         | -         | -         | -         | -         | -          |
| Stellantis     | 3%        | 4%        | 6%        | 6%        | 10%       | 7%         |
| Subaru         | 5%        | 6%        | 7%        | 8%        | 8%        | 15%        |
| Tesla          | 0%        | 0%        | 0%        | 0%        | 0%        | 0%         |
| Toyota         | 4%        | 5%        | 6%        | 7%        | 7%        | 9%         |
| Volvo          | 7%        | 7%        | 7%        | 7%        | 7%        | 7%         |
| VW             | 5%        | 7%        | 8%        | 9%        | 12%       | 10%        |
| <b>TOTAL</b>   | <b>4%</b> | <b>5%</b> | <b>6%</b> | <b>7%</b> | <b>9%</b> | <b>10%</b> |

**Table 12-86: Projected PHEV Penetrations, Alternative B - Trucks**

| Manufacturer   | 2027      | 2028      | 2029      | 2030      | 2031       | 2032       |
|----------------|-----------|-----------|-----------|-----------|------------|------------|
| Aston Martin   | 5%        | 7%        | 9%        | 15%       | 12%        | 8%         |
| BMW            | 8%        | 8%        | 10%       | 13%       | 13%        | 12%        |
| Ferrari        | -         | -         | -         | -         | -          | -          |
| Ford           | 6%        | 4%        | 6%        | 8%        | 8%         | 10%        |
| General Motors | 6%        | 4%        | 6%        | 7%        | 10%        | 11%        |
| Honda          | 4%        | 6%        | 8%        | 11%       | 9%         | 10%        |
| Hyundai        | 6%        | 7%        | 9%        | 12%       | 11%        | 11%        |
| JLR            | 8%        | 13%       | 8%        | 10%       | 12%        | 11%        |
| Kia            | 5%        | 6%        | 7%        | 9%        | 9%         | 10%        |
| Lucid          | -         | -         | -         | -         | -          | -          |
| Mazda          | 6%        | 7%        | 8%        | 9%        | 10%        | 11%        |
| McLaren        | -         | -         | -         | -         | -          | -          |
| Mercedes Benz  | 6%        | 7%        | 9%        | 10%       | 10%        | 10%        |
| Mitsubishi     | 3%        | 4%        | 6%        | 7%        | 8%         | 9%         |
| Nissan         | 4%        | 4%        | 7%        | 7%        | 9%         | 10%        |
| Rivian         | 0%        | 0%        | 0%        | 0%        | 0%         | 0%         |
| Stellantis     | 8%        | 8%        | 10%       | 10%       | 11%        | 11%        |
| Subaru         | 5%        | 7%        | 8%        | 9%        | 11%        | 12%        |
| Tesla          | 0%        | 0%        | 0%        | 0%        | 0%         | 0%         |
| Toyota         | 7%        | 8%        | 8%        | 10%       | 11%        | 12%        |
| Volvo          | 24%       | 24%       | 24%       | 24%       | 24%        | 24%        |
| VW             | 6%        | 8%        | 9%        | 10%       | 11%        | 12%        |
| <b>TOTAL</b>   | <b>6%</b> | <b>6%</b> | <b>8%</b> | <b>9%</b> | <b>10%</b> | <b>11%</b> |



**Table 12-87: Projected PHEV Penetrations, Alternative B - Combined**

| Manufacturer   | 2027      | 2028      | 2029      | 2030      | 2031       | 2032       |
|----------------|-----------|-----------|-----------|-----------|------------|------------|
| Aston Martin   | 4%        | 6%        | 8%        | 12%       | 11%        | 10%        |
| BMW            | 6%        | 7%        | 8%        | 12%       | 11%        | 11%        |
| Ferrari        | 20%       | 20%       | 20%       | 25%       | 22%        | 22%        |
| Ford           | 6%        | 5%        | 7%        | 9%        | 9%         | 11%        |
| General Motors | 5%        | 4%        | 6%        | 7%        | 10%        | 11%        |
| Honda          | 4%        | 5%        | 7%        | 10%       | 11%        | 11%        |
| Hyundai        | 5%        | 6%        | 8%        | 10%       | 10%        | 12%        |
| JLR            | 8%        | 13%       | 8%        | 9%        | 12%        | 11%        |
| Kia            | 5%        | 6%        | 7%        | 8%        | 9%         | 11%        |
| Lucid          | 0%        | 0%        | 0%        | 0%        | 0%         | 0%         |
| Mazda          | 6%        | 7%        | 8%        | 9%        | 11%        | 12%        |
| McLaren        | 8%        | 11%       | 12%       | 18%       | 12%        | 12%        |
| Mercedes Benz  | 5%        | 7%        | 9%        | 9%        | 10%        | 10%        |
| Mitsubishi     | 5%        | 6%        | 8%        | 9%        | 10%        | 11%        |
| Nissan         | 4%        | 4%        | 6%        | 6%        | 7%         | 8%         |
| Rivian         | 0%        | 0%        | 0%        | 0%        | 0%         | 0%         |
| Stellantis     | 8%        | 7%        | 9%        | 10%       | 11%        | 11%        |
| Subaru         | 5%        | 7%        | 8%        | 9%        | 10%        | 12%        |
| Tesla          | 0%        | 0%        | 0%        | 0%        | 0%         | 0%         |
| Toyota         | 6%        | 7%        | 7%        | 8%        | 10%        | 10%        |
| Volvo          | 20%       | 21%       | 21%       | 21%       | 21%        | 21%        |
| VW             | 6%        | 8%        | 8%        | 9%        | 11%        | 11%        |
| <b>TOTAL</b>   | <b>6%</b> | <b>6%</b> | <b>7%</b> | <b>9%</b> | <b>10%</b> | <b>11%</b> |

The tables below provide summary technology penetrations for Alternative B for strong hybrids, TURB12 (only non-Miller engines) and MIL (Miller cycle engines). For these tables, strong hybrids include all engine types, while the TURB12 and MIL penetrations shown are only for non-hybrid versions of those vehicles.

**Table 12-88: Projected Strong HEV Penetrations, Alternative B**

|              | 2027      | 2028      | 2029      | 2030      | 2031      | 2032      |
|--------------|-----------|-----------|-----------|-----------|-----------|-----------|
| Cars         | 3%        | 8%        | 7%        | 6%        | 6%        | 5%        |
| Trucks       | 4%        | 3%        | 3%        | 6%        | 5%        | 4%        |
| <b>Total</b> | <b>4%</b> | <b>5%</b> | <b>4%</b> | <b>6%</b> | <b>5%</b> | <b>4%</b> |

**Table 12-89: Projected TURB12 Penetrations, Alternative B**

|              | 2027       | 2028       | 2029       | 2030       | 2031       | 2032       |
|--------------|------------|------------|------------|------------|------------|------------|
| Cars         | 37%        | 31%        | 25%        | 21%        | 19%        | 16%        |
| Trucks       | 52%        | 48%        | 41%        | 34%        | 29%        | 24%        |
| <b>Total</b> | <b>47%</b> | <b>43%</b> | <b>36%</b> | <b>30%</b> | <b>26%</b> | <b>21%</b> |

**Table 12-90: Projected MIL Penetrations, Alternative B**

|              | 2027      | 2028      | 2029      | 2030      | 2031      | 2032      |
|--------------|-----------|-----------|-----------|-----------|-----------|-----------|
| Cars         | 5%        | 5%        | 5%        | 4%        | 4%        | 3%        |
| Trucks       | 2%        | 1%        | 1%        | 1%        | 1%        | 1%        |
| <b>Total</b> | <b>3%</b> | <b>2%</b> | <b>2%</b> | <b>2%</b> | <b>2%</b> | <b>1%</b> |

### 12.1.4 Light-Duty Vehicle Sensitivities

Light-duty sensitivities are described in Section IV.F of the preamble. This section provides the analytical results for the final standards across the various sensitivities. In addition, we conducted additional sensitivity analysis regarding the IRA tax credit assumptions in a memo to the docket (U.S. EPA 2024).

#### 12.1.4.1 State-level ZEV Policies (ACC II)

**Table 12-91: Projected targets with ACC II (CO<sub>2</sub> grams/mile) - cars and trucks combined**

|                 | 2027 | 2028 | 2029 | 2030 | 2031 | 2032 |
|-----------------|------|------|------|------|------|------|
| No Action       | 169  | 170  | 171  | 172  | 171  | 172  |
| Final Standards | 171  | 153  | 136  | 119  | 102  | 85   |

**Table 12-92: Projected achieved levels with ACC II (CO<sub>2</sub> grams/mile) - cars and trucks combined<sup>a</sup>**

|   | 2027 | 2028 | 2029 | 2030 | 2031 | 2032 |
|---|------|------|------|------|------|------|
| No Action   | 145  | 129  | 116  | 104  | 91   | 83   |
| Final Standards   | 152  | 136  | 126  | 114  | 100  | 92   |
| <sup>a</sup> The No Action achieved levels for the State-level ZEV Policies sensitivity are lower due to greater maximum off-cycle and A/C credits available in the No Action case. We discuss this phenomenon in Section IV.D.3 of the preamble. |      |      |      |      |      |      |

**Table 12-93: BEV penetrations with ACC II - cars and trucks combined**

|                 | 2027 | 2028 | 2029 | 2030 | 2031 | 2032 |
|-----------------|------|------|------|------|------|------|
| No Action       | 31%  | 34%  | 39%  | 42%  | 42%  | 45%  |
| Final Standards | 31%  | 36%  | 40%  | 47%  | 52%  | 56%  |

**Table 12-94: PHEV penetrations with ACC II - cars and trucks combined**

|                 | 2027 | 2028 | 2029 | 2030 | 2031 | 2032 |
|-----------------|------|------|------|------|------|------|
| No Action       | 5%   | 6%   | 6%   | 8%   | 14%  | 14%  |
| Final Standards | 5%   | 6%   | 7%   | 6%   | 8%   | 8%   |

**Table 12-95: Average incremental vehicle cost vs. No Action case with ACC II - cars and trucks combined**

|                 | 2027  | 2028 | 2029 | 2030  | 2031  | 2032    | 6-yr avg |
|-----------------|-------|------|------|-------|-------|---------|----------|
| Final Standards | \$143 | \$82 | \$95 | \$227 | \$969 | \$1,003 | \$420    |

### 12.1.4.2 Battery Costs

#### 12.1.4.2.1 Low Battery Costs

**Table 12-96: Projected targets for Low Battery Costs (CO<sub>2</sub> grams/mile) - cars and trucks combined**

|                 | 2027 | 2028 | 2029 | 2030 | 2031 | 2032 |
|-----------------|------|------|------|------|------|------|
| No Action       | 170  | 171  | 172  | 172  | 172  | 172  |
| Final Standards | 171  | 154  | 136  | 119  | 102  | 85   |

**Table 12-97: Projected achieved levels for Low Battery Costs (CO<sub>2</sub> grams/mile) - cars and trucks combined**

|                 | 2027 | 2028 | 2029 | 2030 | 2031 | 2032 |
|-----------------|------|------|------|------|------|------|
| No Action       | 131  | 111  | 101  | 101  | 100  | 103  |
| Final Standards | 140  | 119  | 113  | 111  | 96   | 82   |

**Table 12-98: BEV penetrations for Low Battery Costs - cars and trucks combined**

|                 | 2027 | 2028 | 2029 | 2030 | 2031 | 2032 |
|-----------------|------|------|------|------|------|------|
| No Action       | 37%  | 41%  | 44%  | 42%  | 43%  | 41%  |
| Final Standards | 37%  | 44%  | 47%  | 48%  | 54%  | 59%  |

**Table 12-99: PHEV penetrations for Low Battery Costs - cars and trucks combined**

|                 | 2027 | 2028 | 2029 | 2030 | 2031 | 2032 |
|-----------------|------|------|------|------|------|------|
| No Action       | 5%   | 6%   | 7%   | 8%   | 8%   | 9%   |
| Final Standards | 5%   | 6%   | 7%   | 8%   | 9%   | 11%  |

**Table 12-100: Average incremental vehicle cost vs. No Action case for Low Battery Costs - cars and trucks combined**

|                 | 2027  | 2028  | 2029  | 2030 | 2031  | 2032    | 6-yr avg |
|-----------------|-------|-------|-------|------|-------|---------|----------|
| Final Standards | \$106 | -\$12 | -\$72 | \$25 | \$653 | \$1,416 | \$353    |

#### 12.1.4.2.2 High Battery Costs

**Table 12-101: Projected targets for High Battery Costs (CO<sub>2</sub> grams/mile) - cars and trucks combined**

|                 | 2027 | 2028 | 2029 | 2030 | 2031 | 2032 |
|-----------------|------|------|------|------|------|------|
| No Action       | 168  | 168  | 169  | 169  | 170  | 170  |
| Final Standards | 170  | 154  | 136  | 120  | 102  | 85   |

**Table 12-102: Projected achieved levels for High Battery Costs (CO<sub>2</sub> grams/mile) - cars and trucks combined**

|                 | 2027 | 2028 | 2029 | 2030 | 2031 | 2032 |
|-----------------|------|------|------|------|------|------|
| No Action       | 163  | 149  | 148  | 144  | 134  | 128  |
| Final Standards | 168  | 137  | 126  | 108  | 95   | 83   |

**Table 12-103: BEV penetrations for High Battery Costs - cars and trucks combined**

|                 | 2027 | 2028 | 2029 | 2030 | 2031 | 2032 |
|-----------------|------|------|------|------|------|------|
| No Action       | 19%  | 20%  | 21%  | 22%  | 25%  | 26%  |
| Final Standards | 20%  | 25%  | 30%  | 38%  | 46%  | 50%  |

**Table 12-104: PHEV penetrations for High Battery Costs - cars and trucks combined**

|                 | 2027 | 2028 | 2029 | 2030 | 2031 | 2032 |
|-----------------|------|------|------|------|------|------|
| No Action       | 10%  | 9%   | 8%   | 9%   | 11%  | 13%  |
| Final Standards | 10%  | 12%  | 12%  | 13%  | 15%  | 18%  |

**Table 12-105: Average incremental vehicle cost vs. No Action case for High Battery Costs - cars and trucks combined**

|                 | 2027  | 2028    | 2029    | 2030    | 2031    | 2032    | 6-yr avg |
|-----------------|-------|---------|---------|---------|---------|---------|----------|
| Final Standards | \$230 | \$1,562 | \$2,300 | \$3,335 | \$3,818 | \$4,187 | \$2,572  |

**12.1.4.3 Consumer Acceptance****12.1.4.3.1 Faster BEV Acceptance****Table 12-106: Projected targets for Faster BEV Acceptance (CO<sub>2</sub> grams/mile) - cars and trucks combined**

|                 | 2027 | 2028 | 2029 | 2030 | 2031 | 2032 |
|-----------------|------|------|------|------|------|------|
| No Action       | 170  | 171  | 172  | 173  | 173  | 174  |
| Final Standards | 171  | 154  | 136  | 120  | 102  | 85   |

**Table 12-107: Projected achieved levels for Faster BEV Acceptance (CO<sub>2</sub> grams/mile) - cars and trucks combined**

|                 | 2027 | 2028 | 2029 | 2030 | 2031 | 2032 |
|-----------------|------|------|------|------|------|------|
| No Action       | 133  | 108  | 94   | 86   | 75   | 67   |
| Final Standards | 140  | 114  | 103  | 99   | 91   | 78   |

**Table 12-108: BEV penetrations for Faster BEV Acceptance - cars and trucks combined**

|                 | 2027 | 2028 | 2029 | 2030 | 2031 | 2032 |
|-----------------|------|------|------|------|------|------|
| No Action       | 37%  | 43%  | 48%  | 51%  | 54%  | 56%  |
| Final Standards | 37%  | 46%  | 52%  | 54%  | 58%  | 62%  |

**Table 12-109: PHEV penetrations for Faster BEV Acceptance - cars and trucks combined**

|                 | 2027 | 2028 | 2029 | 2030 | 2031 | 2032 |
|-----------------|------|------|------|------|------|------|
| No Action       | 4%   | 5%   | 6%   | 6%   | 8%   | 9%   |
| Final Standards | 5%   | 5%   | 5%   | 6%   | 6%   | 9%   |

**Table 12-110: Average incremental vehicle cost vs. No Action case for Faster BEV Acceptance - cars and trucks combined**

|                 | 2027  | 2028  | 2029  | 2030 | 2031  | 2032  | 6-yr avg |
|-----------------|-------|-------|-------|------|-------|-------|----------|
| Final Standards | \$138 | \$193 | \$181 | \$40 | -\$19 | \$274 | \$134    |

**12.1.4.3.2 Slower BEV Acceptance**

**Table 12-111: Projected targets for Slower BEV Acceptance (CO<sub>2</sub> grams/mile) - cars and trucks combined**

|                 | 2027 | 2028 | 2029 | 2030 | 2031 | 2032 |
|-----------------|------|------|------|------|------|------|
| No Action       | 168  | 170  | 170  | 170  | 171  | 171  |
| Final Standards | 170  | 153  | 136  | 119  | 102  | 85   |

**Table 12-112: Projected achieved levels for Slower BEV Acceptance (CO<sub>2</sub> grams/mile) - cars and trucks combined**

|                 | 2027 | 2028 | 2029 | 2030 | 2031 | 2032 |
|-----------------|------|------|------|------|------|------|
| No Action       | 161  | 151  | 145  | 141  | 129  | 125  |
| Final Standards | 162  | 136  | 122  | 107  | 98   | 81   |

**Table 12-113: BEV penetrations for Slower BEV Acceptance - cars and trucks combined**

|                 | 2027 | 2028 | 2029 | 2030 | 2031 | 2032 |
|-----------------|------|------|------|------|------|------|
| No Action       | 20%  | 17%  | 20%  | 21%  | 25%  | 27%  |
| Final Standards | 21%  | 25%  | 32%  | 38%  | 44%  | 52%  |

**Table 12-114: PHEV penetrations for Slower BEV Acceptance - cars and trucks combined**

|                 | 2027 | 2028 | 2029 | 2030 | 2031 | 2032 |
|-----------------|------|------|------|------|------|------|
| No Action       | 9%   | 9%   | 10%  | 10%  | 11%  | 12%  |
| Final Standards | 10%  | 11%  | 13%  | 14%  | 15%  | 17%  |

**Table 12-115: Average incremental vehicle cost vs. No Action case for Slower BEV Acceptance - cars and trucks combined**

|                 | 2027  | 2028    | 2029    | 2030    | 2031    | 2032    | 6-yr avg |
|-----------------|-------|---------|---------|---------|---------|---------|----------|
| Final Standards | \$426 | \$1,074 | \$1,512 | \$2,158 | \$2,291 | \$2,887 | \$1,725  |

**12.1.4.4 No Credit Trading Case**

**Table 12-116: Projected targets for No Credit Trading (CO<sub>2</sub> grams/mile) - cars and trucks combined**

|                 | 2027 | 2028 | 2029 | 2030 | 2031 | 2032 |
|-----------------|------|------|------|------|------|------|
| No Action       | 170  | 169  | 169  | 170  | 170  | 170  |
| Final Standards | 171  | 153  | 136  | 119  | 102  | 85   |

**Table 12-117: Projected achieved levels for No Credit Trading (CO<sub>2</sub> grams/mile) - cars and trucks combined**

|                 | 2027 | 2028 | 2029 | 2030 | 2031 | 2032 |
|-----------------|------|------|------|------|------|------|
| No Action       | 142  | 141  | 133  | 129  | 121  | 117  |
| Final Standards | 146  | 132  | 116  | 103  | 89   | 77   |

**Table 12-118: BEV penetrations for No Credit Trading - cars and trucks combined**

|                 | 2027 | 2028 | 2029 | 2030 | 2031 | 2032 |
|-----------------|------|------|------|------|------|------|
| No Action       | 27%  | 28%  | 30%  | 31%  | 34%  | 35%  |
| Final Standards | 28%  | 33%  | 41%  | 46%  | 52%  | 56%  |

**Table 12-119: PHEV penetrations for No Credit Trading - cars and trucks combined**

|                 | 2027 | 2028 | 2029 | 2030 | 2031 | 2032 |
|-----------------|------|------|------|------|------|------|
| No Action       | 6%   | 6%   | 7%   | 8%   | 9%   | 10%  |
| Final Standards | 6%   | 7%   | 8%   | 9%   | 11%  | 13%  |

**Table 12-120: Average incremental vehicle cost vs. No Action case for No Credit Trading - cars and trucks combined**

|                 | 2027  | 2028    | 2029    | 2030    | 2031    | 2032    | 6-yr avg |
|-----------------|-------|---------|---------|---------|---------|---------|----------|
| Final Standards | \$268 | \$1,055 | \$1,420 | \$1,983 | \$2,365 | \$2,807 | \$1,650  |

**12.1.4.5 Alternative Manufacturer Pathways**

**12.1.4.5.1 Lower BEV Production**

**Table 12-121: Projected targets for Lower BEV Production (CO<sub>2</sub> grams/mile) - cars and trucks combined**

|                 | 2027 | 2028 | 2029 | 2030 | 2031 | 2032 |
|-----------------|------|------|------|------|------|------|
| No Action       | 168  | 169  | 169  | 170  | 171  | 171  |
| Final Standards | 170  | 153  | 136  | 119  | 102  | 85   |

**Table 12-122: Projected achieved levels for Lower BEV Production (CO<sub>2</sub> grams/mile) - cars and trucks combined**

|                 | 2027 | 2028 | 2029 | 2030 | 2031 | 2032 |
|-----------------|------|------|------|------|------|------|
| No Action       | 160  | 153  | 142  | 137  | 128  | 118  |
| Final Standards | 160  | 146  | 133  | 117  | 102  | 88   |

**Table 12-123: BEV penetrations for Lower BEV Production - cars and trucks combined**

|                 | 2027 | 2028 | 2029 | 2030 | 2031 | 2032 |
|-----------------|------|------|------|------|------|------|
| No Action       | 26%  | 27%  | 30%  | 31%  | 34%  | 35%  |
| Final Standards | 24%  | 29%  | 33%  | 37%  | 41%  | 43%  |

**Table 12-124: PHEV penetrations for Lower BEV Production - cars and trucks combined**

|                 | 2027 | 2028 | 2029 | 2030 | 2031 | 2032 |
|-----------------|------|------|------|------|------|------|
| No Action       | 5%   | 6%   | 7%   | 8%   | 8%   | 12%  |
| Final Standards | 10%  | 12%  | 15%  | 18%  | 24%  | 29%  |

**Table 12-125: Average incremental vehicle cost vs. No Action case for Lower BEV Production - cars and trucks combined**

|                 | 2027  | 2028  | 2029  | 2030    | 2031    | 2032    | 6-yr avg |
|-----------------|-------|-------|-------|---------|---------|---------|----------|
| Final Standards | \$449 | \$788 | \$980 | \$1,639 | \$2,303 | \$2,575 | \$1,456  |

**12.1.4.5.2 No Additional BEVs Beyond the No Action Case**

**Table 12-126: Projected targets for No Additional BEVs Beyond the No Action Case (CO<sub>2</sub> grams/mile) - cars and trucks combined**

|                 | 2027 | 2028 | 2029 | 2030 | 2031 | 2032 |
|-----------------|------|------|------|------|------|------|
| No Action       | 168  | 169  | 169  | 170  | 171  | 171  |
| Final Standards | 170  | 155  | 137  | 121  | 103  | 86   |

**Table 12-127: Projected achieved levels for No Additional BEVs Beyond the No Action Case (CO<sub>2</sub> grams/mile) - cars and trucks combined**

|                 | 2027 | 2028 | 2029 | 2030 | 2031 | 2032 |
|-----------------|------|------|------|------|------|------|
| No Action       | 160  | 153  | 142  | 137  | 128  | 118  |
| Final Standards | 159  | 124  | 112  | 100  | 95   | 90   |

**Table 12-128: BEV penetrations for No Additional BEVs Beyond the No Action Case - cars and trucks combined**

|                 | 2027 | 2028 | 2029 | 2030 | 2031 | 2032 |
|-----------------|------|------|------|------|------|------|
| No Action       | 26%  | 27%  | 30%  | 31%  | 34%  | 35%  |
| Final Standards | 24%  | 26%  | 30%  | 31%  | 34%  | 35%  |

**Table 12-129: PHEV penetrations for No Additional BEVs Beyond the No Action Case - cars and trucks combined**

|                 | 2027 | 2028 | 2029 | 2030 | 2031 | 2032 |
|-----------------|------|------|------|------|------|------|
| No Action       | 5%   | 6%   | 7%   | 8%   | 8%   | 12%  |
| Final Standards | 10%  | 17%  | 22%  | 27%  | 32%  | 36%  |

**Table 12-130: Average incremental vehicle cost vs. No Action case for No Additional BEVs Beyond the No Action Case - cars and trucks combined**

|                 | 2027  | 2028    | 2029    | 2030    | 2031    | 2032    | 6-yr avg |
|-----------------|-------|---------|---------|---------|---------|---------|----------|
| Final Standards | \$536 | \$2,517 | \$2,630 | \$3,120 | \$3,334 | \$3,112 | \$2,542  |

## 12.2 Medium-Duty Vehicles

### 12.2.1 GHG Targets and Compliance Levels

#### 12.2.1.1 CO<sub>2</sub> g/mi

Shown below are the projected average GHG targets for each manufacturer, as well as their corresponding average achieved compliance, in g/mi, for vans and pickups.

##### 12.2.1.1.1 Final Standards

OEM-specific GHG emissions targets for the final standards are shown in Table 12-131, Table 12-132, and Table 12-133 for vans, pickups, and the combined fleet, respectively. Similarly, projected achieved GHG emissions levels are given in Table 12-134 through Table 12-136.

**Table 12-131: Projected GHG Targets, Final Standards - Medium Duty Vans**

| Manufacturer   | 2027       | 2028       | 2029       | 2030       | 2031       | 2032       |
|----------------|------------|------------|------------|------------|------------|------------|
| Ford           | 384        | 383        | 348        | 311        | 275        | 240        |
| General Motors | 392        | 391        | 355        | 316        | 280        | 244        |
| Mercedes Benz  | 426        | 424        | 386        | 345        | 306        | 267        |
| Nissan         | 391        | 390        | 354        | 316        | 280        | 244        |
| Stellantis     | 393        | 392        | 356        | 318        | 281        | 245        |
| <b>TOTAL</b>   | <b>392</b> | <b>391</b> | <b>355</b> | <b>317</b> | <b>281</b> | <b>245</b> |

**Table 12-132: Projected GHG Targets, Final Standards - Medium Duty Pickups**

| Manufacturer   | 2027       | 2028       | 2029       | 2030       | 2031       | 2032       |
|----------------|------------|------------|------------|------------|------------|------------|
| Ford           | 486        | 472        | 426        | 368        | 329        | 288        |
| General Motors | 506        | 496        | 446        | 373        | 332        | 291        |
| Mercedes Benz  | -          | -          | -          | -          | -          | -          |
| Nissan         | 423        | 421        | 383        | 342        | 305        | 267        |
| Stellantis     | 501        | 491        | 439        | 373        | 332        | 291        |
| <b>TOTAL</b>   | <b>497</b> | <b>486</b> | <b>437</b> | <b>371</b> | <b>331</b> | <b>290</b> |

**Table 12-133: Projected GHG Targets, Final Standards - Combined**

| Manufacturer   | 2027       | 2028       | 2029       | 2030       | 2031       | 2032       |
|----------------|------------|------------|------------|------------|------------|------------|
| Ford           | 446        | 438        | 396        | 346        | 309        | 270        |
| General Motors | 475        | 468        | 422        | 358        | 318        | 278        |
| Mercedes Benz  | 426        | 424        | 386        | 345        | 306        | 267        |
| Nissan         | 393        | 392        | 356        | 318        | 282        | 246        |
| Stellantis     | 477        | 469        | 421        | 360        | 321        | 281        |
| <b>TOTAL</b>   | <b>461</b> | <b>453</b> | <b>408</b> | <b>353</b> | <b>314</b> | <b>274</b> |



**Table 12-134: Achieved GHG Levels, Final Standards - Medium Duty Vans**

| Manufacturer   | 2027       | 2028       | 2029       | 2030       | 2031       | 2032       |
|----------------|------------|------------|------------|------------|------------|------------|
| Ford           | 424        | 418        | 330        | 243        | 142        | 99         |
| General Motors | 480        | 476        | 377        | 278        | 167        | 110        |
| Mercedes Benz  | 375        | 371        | 294        | 207        | 133        | 92         |
| Nissan         | 427        | 423        | 338        | 250        | 162        | 110        |
| Stellantis     | 431        | 426        | 338        | 249        | 164        | 107        |
| <b>TOTAL</b>   | <b>434</b> | <b>429</b> | <b>340</b> | <b>249</b> | <b>151</b> | <b>103</b> |

**Table 12-135: Achieved GHG Levels, Final Standards - Medium Duty Pickups**

| Manufacturer   | 2027       | 2028       | 2029       | 2030       | 2031       | 2032       |
|----------------|------------|------------|------------|------------|------------|------------|
| Ford           | 474        | 469        | 449        | 413        | 408        | 370        |
| General Motors | 469        | 465        | 444        | 403        | 386        | 353        |
| Mercedes Benz  | -          | -          | -          | -          | -          | -          |
| Nissan         | 396        | 391        | 382        | 344        | 349        | 360        |
| Stellantis     | 456        | 451        | 433        | 395        | 394        | 360        |
| <b>TOTAL</b>   | <b>468</b> | <b>463</b> | <b>443</b> | <b>405</b> | <b>396</b> | <b>361</b> |

**Table 12-136: Achieved GHG Levels, Final Standards - Combined**

| Manufacturer   | 2027       | 2028       | 2029       | 2030       | 2031       | 2032       |
|----------------|------------|------------|------------|------------|------------|------------|
| Ford           | 455        | 450        | 404        | 348        | 307        | 267        |
| General Motors | 472        | 468        | 426        | 370        | 328        | 288        |
| Mercedes Benz  | 375        | 371        | 294        | 207        | 133        | 92         |
| Nissan         | 425        | 421        | 341        | 256        | 175        | 126        |
| Stellantis     | 450        | 446        | 411        | 363        | 343        | 304        |
| <b>TOTAL</b>   | <b>456</b> | <b>451</b> | <b>407</b> | <b>351</b> | <b>312</b> | <b>272</b> |

### 12.2.1.2 CO<sub>2</sub> Mg

Shown below are the projected average GHG targets for each manufacturer, as well as their corresponding average achieved compliance, in Mg, for cars, trucks, and the combined fleet. Total emissions are calculated by multiplying the relevant CO<sub>2</sub> emission rate, the production volume of applicable vehicles, and the expected lifetime vehicle miles traveled (VMT) of those vehicles. The equation to calculate total Mg (for either total emissions, or credits based on the difference between target g/mi and achieved g/mi) is:

$$\text{CO}_2 \text{ (Mg)} = (\text{CO}_2 \text{ (g/mi)} \times \text{VMT} \times \text{Production}) / 1,000,000$$

In the above equation, “VMT” is in miles, and specified in the regulations as 150,000 miles. When using these equations to calculate values for cars and trucks in aggregate, we use a production weighted average of the car and truck VMT values.

#### 12.2.1.2.1 Final Standards

OEM-specific GHG emissions targets for the final standards (in Mg) are shown in Table 12-137, Table 12-138, and Table 12-139 for vans, pickups, and the combined fleet, respectively. Similarly, projected achieved GHG emissions (in Mg) are given for vans, pickups, and the combined fleet in Table 12-140, Table 12-141, and Table 12-142. Finally, overall credits or

debits earned are provided for the combined fleet on a manufacturer-specific basis, in Table 12-143.

**Table 12-137: Projected GHG Targets (Mg), Final Standards - Medium Duty Vans**

| Manufacturer   | 2027              | 2028              | 2029              | 2030              | 2031              | 2032             |
|----------------|-------------------|-------------------|-------------------|-------------------|-------------------|------------------|
| Ford           | 6,527,530         | 6,510,205         | 5,927,714         | 5,320,365         | 4,753,308         | 4,189,625        |
| General Motors | 3,929,040         | 3,916,530         | 3,559,281         | 3,188,745         | 2,843,691         | 2,503,748        |
| Mercedes Benz  | 1,862,709         | 1,853,565         | 1,688,648         | 1,516,903         | 1,356,793         | 1,196,749        |
| Nissan         | 686,628           | 684,519           | 622,989           | 558,819           | 498,961           | 439,500          |
| Stellantis     | 1,884,366         | 1,878,326         | 1,708,438         | 1,531,874         | 1,367,533         | 1,204,396        |
| <b>TOTAL</b>   | <b>14,890,274</b> | <b>14,843,145</b> | <b>13,507,071</b> | <b>12,116,706</b> | <b>10,820,286</b> | <b>9,534,018</b> |

**Table 12-138: Projected GHG Targets (Mg), Final Standards - Medium Duty Pickups**

| Manufacturer   | 2027              | 2028              | 2029              | 2030              | 2031              | 2032              |
|----------------|-------------------|-------------------|-------------------|-------------------|-------------------|-------------------|
| Ford           | 13,210,563        | 12,910,330        | 11,705,812        | 10,201,534        | 9,239,318         | 8,190,773         |
| General Motors | 13,729,000        | 13,532,118        | 12,229,127        | 10,310,655        | 9,305,939         | 8,252,083         |
| Mercedes Benz  | -                 | -                 | -                 | -                 | -                 | -                 |
| Nissan         | 51,135            | 51,104            | 46,761            | 42,112            | 37,990            | 33,687            |
| Stellantis     | 8,313,311         | 8,177,286         | 7,355,817         | 6,292,821         | 5,680,742         | 5,037,485         |
| <b>TOTAL</b>   | <b>35,304,009</b> | <b>34,670,837</b> | <b>31,337,517</b> | <b>26,847,122</b> | <b>24,263,989</b> | <b>21,514,029</b> |

**Table 12-139: Projected GHG Targets (Mg), Final Standards - Medium Duty Combined**

| Manufacturer   | 2027              | 2028              | 2029              | 2030              | 2031              | 2032              |
|----------------|-------------------|-------------------|-------------------|-------------------|-------------------|-------------------|
| Ford           | 19,738,093        | 19,420,535        | 17,633,527        | 15,521,899        | 13,992,625        | 12,380,399        |
| General Motors | 17,658,040        | 17,448,647        | 15,788,408        | 13,499,400        | 12,149,630        | 10,755,832        |
| Mercedes Benz  | 1,862,709         | 1,853,565         | 1,688,648         | 1,516,903         | 1,356,793         | 1,196,749         |
| Nissan         | 737,763           | 735,623           | 669,750           | 600,931           | 536,951           | 473,187           |
| Stellantis     | 10,197,677        | 10,055,612        | 9,064,255         | 7,824,694         | 7,048,275         | 6,241,881         |
| <b>TOTAL</b>   | <b>50,194,283</b> | <b>49,513,982</b> | <b>44,844,587</b> | <b>38,963,827</b> | <b>35,084,275</b> | <b>31,048,047</b> |

**Table 12-140: Achieved GHG Levels (Mg), Final Standards - Medium Duty Vans**

| Manufacturer   | 2027              | 2028              | 2029              | 2030             | 2031             | 2032             |
|----------------|-------------------|-------------------|-------------------|------------------|------------------|------------------|
| Ford           | 7,215,157         | 7,115,886         | 5,634,919         | 4,159,262        | 2,443,268        | 1,732,150        |
| General Motors | 4,808,881         | 4,762,100         | 3,780,310         | 2,799,449        | 1,699,714        | 1,129,733        |
| Mercedes Benz  | 1,636,722         | 1,619,659         | 1,285,961         | 908,440          | 589,947          | 411,979          |
| Nissan         | 749,064           | 741,627           | 594,912           | 442,075          | 288,983          | 197,713          |
| Stellantis     | 2,064,545         | 2,043,632         | 1,621,964         | 1,200,857        | 796,160          | 526,696          |
| <b>TOTAL</b>   | <b>16,474,368</b> | <b>16,282,904</b> | <b>12,918,066</b> | <b>9,510,083</b> | <b>5,818,073</b> | <b>3,998,272</b> |

**Table 12-141: Achieved GHG Levels (Mg), Final Standards - Medium Duty Pickups**

| Manufacturer   | 2027              | 2028              | 2029              | 2030              | 2031              | 2032              |
|----------------|-------------------|-------------------|-------------------|-------------------|-------------------|-------------------|
| Ford           | 12,882,609        | 12,827,681        | 12,332,351        | 11,439,735        | 11,459,668        | 10,526,250        |
| General Motors | 12,741,485        | 12,679,250        | 12,176,344        | 11,151,079        | 10,803,991        | 10,014,127        |
| Mercedes Benz  | -                 | -                 | -                 | -                 | -                 | -                 |
| Nissan         | 47,832            | 47,550            | 46,634            | 42,272            | 43,570            | 45,491            |
| Stellantis     | 7,560,681         | 7,520,698         | 7,245,604         | 6,675,645         | 6,747,273         | 6,236,556         |
| <b>TOTAL</b>   | <b>33,232,608</b> | <b>33,075,180</b> | <b>31,800,933</b> | <b>29,308,730</b> | <b>29,054,502</b> | <b>26,822,424</b> |

**Table 12-142: Achieved GHG Levels (Mg), Final Standards - Medium Duty Combined**

| Manufacturer   | 2027              | 2028              | 2029              | 2030              | 2031              | 2032              |
|----------------|-------------------|-------------------|-------------------|-------------------|-------------------|-------------------|
| Ford           | 20,097,766        | 19,943,567        | 17,967,270        | 15,598,997        | 13,902,936        | 12,258,400        |
| General Motors | 17,550,366        | 17,441,351        | 15,956,654        | 13,950,527        | 12,503,705        | 11,143,860        |
| Mercedes Benz  | 1,636,722         | 1,619,659         | 1,285,961         | 908,440           | 589,947           | 411,979           |
| Nissan         | 796,896           | 789,177           | 641,546           | 484,347           | 332,553           | 243,204           |
| Stellantis     | 9,625,226         | 9,564,330         | 8,867,567         | 7,876,502         | 7,543,433         | 6,763,252         |
| <b>TOTAL</b>   | <b>49,706,976</b> | <b>49,358,084</b> | <b>44,718,999</b> | <b>38,818,813</b> | <b>34,872,574</b> | <b>30,820,696</b> |

**Table 12-143: GHG Credits/Debits Earned (Mg), Final Standards - Medium Duty Combined**

| Manufacturer   | 2027           | 2028           | 2029           | 2030           | 2031           | 2032           |
|----------------|----------------|----------------|----------------|----------------|----------------|----------------|
| Ford           | (359,673)      | (523,032)      | (333,743)      | (77,098)       | 89,689         | 121,999        |
| General Motors | 107,674        | 7,297          | (168,246)      | (451,128)      | (354,075)      | (388,029)      |
| Mercedes Benz  | 225,987        | 233,906        | 402,686        | 608,463        | 766,846        | 784,770        |
| Nissan         | (59,132)       | (53,555)       | 28,204         | 116,584        | 204,398        | 229,983        |
| Stellantis     | 572,451        | 491,282        | 196,688        | (51,807)       | (495,157)      | (521,372)      |
| <b>TOTAL</b>   | <b>487,307</b> | <b>155,898</b> | <b>125,588</b> | <b>145,014</b> | <b>211,701</b> | <b>227,351</b> |

### **12.2.2 Projected Manufacturing Costs per Vehicle**

EPA has performed an assessment of the estimated per-vehicle costs for manufacturers to meet the MY 2027-2032 MDV GHG standards, relative to the No Action case. The fleet average costs per vehicle are grouped by vans, MD pickups, and the fleet total. We have included summary tables in this format. The costs in this section represent compliance costs to the industry and are not necessarily the same as the costs experienced by the consumer when purchasing a new vehicle. For example, the costs presented here do not include any state and Federal purchase incentives that are available to consumers. Also, the manufacturer decisions for the pricing of individual vehicles may not align exactly with the production cost impacts for that particular vehicle. EPA's OMEGA model assumes that manufacturers distribute compliance costs through limited cross-subsidization of prices between vehicles in order to maintain an appropriate mix of debit- and credit-generating vehicles that achieves compliance in a cost-minimizing fashion.

#### **12.2.2.1 Final Standards**

Incremental costs per vehicle for the final standards (compared to the No Action case) are summarized by van and truck in Table 12-144.

**Table 12-144: Projected Manufacturing Costs Per Vehicle, Final Standards - Medium Duty Vehicles**

|              | 2027         | 2028         | 2029         | 2030           | 2031           | 2032           | 6-year avg     |
|--------------|--------------|--------------|--------------|----------------|----------------|----------------|----------------|
| Vans         | \$178        | \$185        | \$1,443      | \$2,732        | \$4,128        | \$4,915        | \$2,264        |
| Pickups      | \$97         | \$88         | \$531        | \$1,432        | \$1,516        | \$2,416        | \$1,013        |
| <b>Total</b> | <b>\$125</b> | <b>\$122</b> | <b>\$847</b> | <b>\$1,881</b> | <b>\$2,416</b> | <b>\$3,275</b> | <b>\$1,444</b> |

Incremental costs per vehicle for the final standards, compared to the No Action case, are shown for each OEM in Table 12-145, Table 12-146, and Table 12-147 for vans, pickups, and the medium duty combined fleet, respectively.

**Table 12-145: Projected Manufacturing Costs Per Vehicle, Final Standards - Medium Duty Vans**

| Manufacturer   | 2027         | 2028         | 2029           | 2030           | 2031           | 2032           |
|----------------|--------------|--------------|----------------|----------------|----------------|----------------|
| Ford           | \$212        | \$231        | \$1,594        | \$2,955        | \$4,581        | \$5,293        |
| General Motors | \$197        | \$194        | \$1,284        | \$2,377        | \$3,639        | \$4,478        |
| Mercedes Benz  | \$11         | \$10         | \$1,270        | \$2,771        | \$3,904        | \$4,649        |
| Nissan         | \$179        | \$177        | \$1,312        | \$2,496        | \$3,641        | \$4,423        |
| Stellantis     | \$167        | \$164        | \$1,447        | \$2,732        | \$3,925        | \$4,912        |
| <b>TOTAL</b>   | <b>\$178</b> | <b>\$185</b> | <b>\$1,443</b> | <b>\$2,732</b> | <b>\$4,128</b> | <b>\$4,915</b> |

**Table 12-146: Projected Manufacturing Costs Per Vehicle, Final Standards - Medium Duty Pickups**

| Manufacturer   | 2027        | 2028        | 2029         | 2030           | 2031           | 2032           |
|----------------|-------------|-------------|--------------|----------------|----------------|----------------|
| Ford           | \$104       | \$84        | \$546        | \$1,410        | \$1,554        | \$2,536        |
| General Motors | \$97        | \$96        | \$539        | \$1,484        | \$1,587        | \$2,430        |
| Mercedes Benz  | -           | -           | -            | -              | -              | -              |
| Nissan         | \$781       | \$791       | \$954        | \$2,049        | \$1,761        | \$1,260        |
| Stellantis     | \$78        | \$77        | \$493        | \$1,378        | \$1,337        | \$2,203        |
| <b>TOTAL</b>   | <b>\$97</b> | <b>\$88</b> | <b>\$531</b> | <b>\$1,432</b> | <b>\$1,516</b> | <b>\$2,416</b> |

**Table 12-147: Projected Manufacturing Costs Per Vehicle, Final Standards - Medium Duty Combined**

| Manufacturer   | 2027         | 2028         | 2029         | 2030           | 2031           | 2032           |
|----------------|--------------|--------------|--------------|----------------|----------------|----------------|
| Ford           | \$146        | \$140        | \$947        | \$2,000        | \$2,707        | \$3,584        |
| General Motors | \$124        | \$122        | \$738        | \$1,723        | \$2,134        | \$2,974        |
| Mercedes Benz  | \$11         | \$10         | \$1,270      | \$2,771        | \$3,904        | \$4,649        |
| Nissan         | \$217        | \$217        | \$1,289      | \$2,466        | \$3,518        | \$4,215        |
| Stellantis     | \$98         | \$97         | \$705        | \$1,679        | \$1,910        | \$2,801        |
| <b>TOTAL</b>   | <b>\$125</b> | <b>\$122</b> | <b>\$847</b> | <b>\$1,881</b> | <b>\$2,416</b> | <b>\$3,275</b> |

### **12.2.3 Technology Penetration Rates**

Presented below are the projected technology penetration rates, by manufacturer, for vans and pickups, for the No Action case and the Final Standards Tables are summarized by body style for BEV penetrations, with the remainder of the fleet being ICE vehicles.

#### **12.2.3.1 No Action Case**

Table 12-148 through Table 12-150 give BEV penetrations for the No Action case, by manufacturer. Similarly, Table 12-151 through Table 12-153 provide PHEV penetrations (no PHEVs were projected for the No Action case).

**Table 12-148: Projected BEV Penetrations, No Action - Medium Duty Vans**

| Manufacturer   | 2027      | 2028      | 2029      | 2030      | 2031      | 2032      |
|----------------|-----------|-----------|-----------|-----------|-----------|-----------|
| Ford           | 3%        | 4%        | 5%        | 6%        | 7%        | 8%        |
| General Motors | 3%        | 4%        | 5%        | 6%        | 7%        | 8%        |
| Mercedes Benz  | 3%        | 4%        | 5%        | 6%        | 7%        | 8%        |
| Nissan         | 3%        | 4%        | 5%        | 6%        | 7%        | 8%        |
| Stellantis     | 3%        | 4%        | 5%        | 6%        | 7%        | 8%        |
| <b>TOTAL</b>   | <b>3%</b> | <b>4%</b> | <b>5%</b> | <b>6%</b> | <b>7%</b> | <b>8%</b> |

**Table 12-149: Projected BEV Penetrations, No Action - Medium Duty Pickups**

| Manufacturer   | 2027      | 2028      | 2029      | 2030      | 2031      | 2032      |
|----------------|-----------|-----------|-----------|-----------|-----------|-----------|
| Ford           | 3%        | 4%        | 5%        | 6%        | 7%        | 8%        |
| General Motors | 3%        | 4%        | 5%        | 6%        | 7%        | 8%        |
| Mercedes Benz  | -         | -         | -         | -         | -         | -         |
| Nissan         | 3%        | 4%        | 5%        | 6%        | 7%        | 8%        |
| Stellantis     | 3%        | 4%        | 5%        | 6%        | 7%        | 8%        |
| <b>TOTAL</b>   | <b>3%</b> | <b>4%</b> | <b>5%</b> | <b>6%</b> | <b>7%</b> | <b>8%</b> |

**Table 12-150: Projected BEV Penetrations, No Action - Medium Duty Combined**

| Manufacturer   | 2027      | 2028      | 2029      | 2030      | 2031      | 2032      |
|----------------|-----------|-----------|-----------|-----------|-----------|-----------|
| Ford           | 3%        | 4%        | 5%        | 6%        | 7%        | 8%        |
| General Motors | 3%        | 4%        | 5%        | 6%        | 7%        | 8%        |
| Mercedes Benz  | 3%        | 4%        | 5%        | 6%        | 7%        | 8%        |
| Nissan         | 3%        | 4%        | 5%        | 6%        | 7%        | 8%        |
| Stellantis     | 3%        | 4%        | 5%        | 6%        | 7%        | 8%        |
| <b>TOTAL</b>   | <b>3%</b> | <b>4%</b> | <b>5%</b> | <b>6%</b> | <b>7%</b> | <b>8%</b> |

**Table 12-151: Projected PHEV Penetrations, No Action - Medium Duty Vans**

| Manufacturer   | 2027      | 2028      | 2029      | 2030      | 2031      | 2032      |
|----------------|-----------|-----------|-----------|-----------|-----------|-----------|
| Ford           | 0%        | 0%        | 0%        | 0%        | 0%        | 0%        |
| General Motors | 0%        | 0%        | 0%        | 0%        | 0%        | 0%        |
| Mercedes Benz  | 0%        | 0%        | 0%        | 0%        | 0%        | 0%        |
| Nissan         | 0%        | 0%        | 0%        | 0%        | 0%        | 0%        |
| Stellantis     | 0%        | 0%        | 0%        | 0%        | 0%        | 0%        |
| <b>TOTAL</b>   | <b>0%</b> | <b>0%</b> | <b>0%</b> | <b>0%</b> | <b>0%</b> | <b>0%</b> |

**Table 12-152: Projected PHEV Penetrations, No Action - Medium Duty Pickups**

| Manufacturer   | 2027      | 2028      | 2029      | 2030      | 2031      | 2032      |
|----------------|-----------|-----------|-----------|-----------|-----------|-----------|
| Ford           | 0%        | 0%        | 0%        | 0%        | 0%        | 0%        |
| General Motors | 0%        | 0%        | 0%        | 0%        | 0%        | 0%        |
| Mercedes Benz  | -         | -         | -         | -         | -         | -         |
| Nissan         | 0%        | 0%        | 0%        | 0%        | 0%        | 0%        |
| Stellantis     | 0%        | 0%        | 0%        | 0%        | 0%        | 0%        |
| <b>TOTAL</b>   | <b>0%</b> | <b>0%</b> | <b>0%</b> | <b>0%</b> | <b>0%</b> | <b>0%</b> |

**Table 12-153: Projected PHEV Penetrations, No Action - Medium Duty Combined**

| Manufacturer   | 2027      | 2028      | 2029      | 2030      | 2031      | 2032      |
|----------------|-----------|-----------|-----------|-----------|-----------|-----------|
| Ford           | 0%        | 0%        | 0%        | 0%        | 0%        | 0%        |
| General Motors | 0%        | 0%        | 0%        | 0%        | 0%        | 0%        |
| Mercedes Benz  | 0%        | 0%        | 0%        | 0%        | 0%        | 0%        |
| Nissan         | 0%        | 0%        | 0%        | 0%        | 0%        | 0%        |
| Stellantis     | 0%        | 0%        | 0%        | 0%        | 0%        | 0%        |
| <b>TOTAL</b>   | <b>0%</b> | <b>0%</b> | <b>0%</b> | <b>0%</b> | <b>0%</b> | <b>0%</b> |

**12.2.3.2 Final Standards**

Table 12-154 through Table 12-156 give BEV penetrations for the final standards, by manufacturer. Similarly, Table 12-157 through Table 12-159 provide PHEV penetrations.

**Table 12-154: Projected BEV Penetrations, Final Standards - Medium Duty Vans**

| Manufacturer   | 2027      | 2028      | 2029       | 2030       | 2031       | 2032       |
|----------------|-----------|-----------|------------|------------|------------|------------|
| Ford           | 3%        | 5%        | 25%        | 45%        | 65%        | 75%        |
| General Motors | 3%        | 4%        | 24%        | 44%        | 64%        | 75%        |
| Mercedes Benz  | 3%        | 4%        | 24%        | 44%        | 64%        | 75%        |
| Nissan         | 3%        | 4%        | 23%        | 43%        | 63%        | 75%        |
| Stellantis     | 3%        | 4%        | 24%        | 44%        | 63%        | 75%        |
| <b>TOTAL</b>   | <b>3%</b> | <b>4%</b> | <b>24%</b> | <b>44%</b> | <b>64%</b> | <b>75%</b> |

**Table 12-155: Projected BEV Penetrations, Final Standards - Medium Duty Pickups**

| Manufacturer   | 2027      | 2028      | 2029      | 2030       | 2031       | 2032       |
|----------------|-----------|-----------|-----------|------------|------------|------------|
| Ford           | 3%        | 4%        | 8%        | 10%        | 10%        | 10%        |
| General Motors | 3%        | 4%        | 8%        | 10%        | 10%        | 10%        |
| Mercedes Benz  | -         | -         | -         | -          | -          | -          |
| Nissan         | 2%        | 3%        | 6%        | 10%        | 10%        | 10%        |
| Stellantis     | 3%        | 4%        | 8%        | 10%        | 9%         | 9%         |
| <b>TOTAL</b>   | <b>3%</b> | <b>4%</b> | <b>8%</b> | <b>10%</b> | <b>10%</b> | <b>10%</b> |

**Table 12-156: Projected BEV Penetrations, Final Standards - Medium Duty Combined**

| Manufacturer   | 2027      | 2028      | 2029       | 2030       | 2031       | 2032       |
|----------------|-----------|-----------|------------|------------|------------|------------|
| Ford           | 3%        | 4%        | 14%        | 23%        | 31%        | 35%        |
| General Motors | 3%        | 4%        | 12%        | 19%        | 24%        | 27%        |
| Mercedes Benz  | 3%        | 4%        | 24%        | 44%        | 64%        | 75%        |
| Nissan         | 3%        | 4%        | 22%        | 41%        | 60%        | 71%        |
| Stellantis     | 3%        | 4%        | 11%        | 17%        | 21%        | 23%        |
| <b>TOTAL</b>   | <b>3%</b> | <b>4%</b> | <b>13%</b> | <b>22%</b> | <b>28%</b> | <b>32%</b> |

**Table 12-157: Projected PHEV Penetrations, Final Standards - Medium Duty Vans**

| Manufacturer   | 2027      | 2028      | 2029      | 2030      | 2031      | 2032      |
|----------------|-----------|-----------|-----------|-----------|-----------|-----------|
| Ford           | 0%        | 0%        | 0%        | 0%        | 0%        | 0%        |
| General Motors | 0%        | 0%        | 0%        | 0%        | 0%        | 2%        |
| Mercedes Benz  | 0%        | 0%        | 0%        | 0%        | 0%        | 0%        |
| Nissan         | 0%        | 0%        | 0%        | 0%        | 0%        | 0%        |
| Stellantis     | 0%        | 0%        | 0%        | 0%        | 0%        | 1%        |
| <b>TOTAL</b>   | <b>0%</b> | <b>0%</b> | <b>0%</b> | <b>0%</b> | <b>0%</b> | <b>1%</b> |

**Table 12-158: Projected PHEV Penetrations, Final Standards - Medium Duty Pickups**

| Manufacturer   | 2027      | 2028      | 2029      | 2030      | 2031      | 2032       |
|----------------|-----------|-----------|-----------|-----------|-----------|------------|
| Ford           | 0%        | 0%        | 0%        | 7%        | 0%        | 12%        |
| General Motors | 0%        | 0%        | 0%        | 9%        | 7%        | 18%        |
| Mercedes Benz  | -         | -         | -         | -         | -         | -          |
| Nissan         | 0%        | 0%        | 0%        | 6%        | 5%        | 2%         |
| Stellantis     | 0%        | 0%        | 0%        | 7%        | 10%       | 20%        |
| <b>TOTAL</b>   | <b>0%</b> | <b>0%</b> | <b>0%</b> | <b>8%</b> | <b>5%</b> | <b>16%</b> |

**Table 12-159: Projected PHEV Penetrations, Final Standards - Medium Duty Combined**

| Manufacturer   | 2027      | 2028      | 2029      | 2030      | 2031      | 2032       |
|----------------|-----------|-----------|-----------|-----------|-----------|------------|
| Ford           | 0%        | 0%        | 0%        | 4%        | 0%        | 8%         |
| General Motors | 0%        | 0%        | 0%        | 6%        | 5%        | 13%        |
| Mercedes Benz  | 0%        | 0%        | 0%        | 0%        | 0%        | 0%         |
| Nissan         | 0%        | 0%        | 0%        | 0%        | 0%        | 0%         |
| Stellantis     | 0%        | 0%        | 0%        | 6%        | 8%        | 16%        |
| <b>TOTAL</b>   | <b>0%</b> | <b>0%</b> | <b>0%</b> | <b>5%</b> | <b>3%</b> | <b>11%</b> |

#### **12.2.4 Medium-Duty Vehicle Sensitivities**

The tables below summarize the projected average GHG targets and average achieved compliance, in g/mi, BEV penetrations, and incremental vehicle cost vs the No Action case, for medium duty vehicles. They are prepared for the Low Battery Cost, High Battery Cost, and No Trading sensitivities.

##### **12.2.4.1 Battery Costs**

###### **12.2.4.1.1 Low Battery Costs**

**Table 12-160. Projected targets with Low Battery Costs for No Action case and final standards (CO<sub>2</sub> grams/mile) - Medium Duty Combined**

|                 | 2027 | 2028 | 2029 | 2030 | 2031 | 2032 |
|-----------------|------|------|------|------|------|------|
| No Action       | 475  | 475  | 474  | 474  | 474  | 474  |
| Final Standards | 461  | 453  | 408  | 353  | 314  | 274  |

**Table 12-161. Projected achieved levels with Low Battery Costs for No Action case and final standards (CO<sub>2</sub> grams/mile) - Medium Duty Combined**

|                 | 2027 | 2028 | 2029 | 2030 | 2031 | 2032 |
|-----------------|------|------|------|------|------|------|
| No Action       | 456  | 452  | 447  | 443  | 438  | 434  |
| Final Standards | 456  | 452  | 407  | 351  | 311  | 272  |

**Table 12-162. BEV penetrations with Low Battery Costs for No Action case and final standards - Medium Duty Combined**

|                 | 2027 | 2028 | 2029 | 2030 | 2031 | 2032 |
|-----------------|------|------|------|------|------|------|
| No Action       | 3%   | 4%   | 5%   | 6%   | 7%   | 8%   |
| Final Standards | 3%   | 4%   | 13%  | 22%  | 28%  | 32%  |

**Table 12-163. PHEV penetrations with Low Battery Costs for No Action case and final standards - Medium Duty Combined**

|                 | 2027 | 2028 | 2029 | 2030 | 2031 | 2032 |
|-----------------|------|------|------|------|------|------|
| No Action       | 0%   | 0%   | 0%   | 0%   | 0%   | 0%   |
| Final Standards | 0%   | 0%   | 0%   | 5%   | 5%   | 12%  |

**Table 12-164. Average incremental vehicle manufacturing cost vs. No Action case for Low Battery Costs, final standards - Medium Duty Combined**

|                 | 2027  | 2028  | 2029  | 2030    | 2031    | 2032    | 6-yr avg |
|-----------------|-------|-------|-------|---------|---------|---------|----------|
| Final Standards | \$125 | \$122 | \$553 | \$1,356 | \$1,863 | \$2,696 | \$1,119  |

#### 12.2.4.1.2 High Battery Costs

**Table 12-165. Projected targets with High Battery Costs for No Action case and final standards (CO<sub>2</sub> grams/mile) - Medium Duty Combined**

|                 | 2027 | 2028 | 2029 | 2030 | 2031 | 2032 |
|-----------------|------|------|------|------|------|------|
| No Action       | 475  | 475  | 474  | 474  | 474  | 474  |
| Final Standards | 461  | 453  | 409  | 353  | 315  | 275  |

**Table 12-166. Projected achieved levels with High Battery Costs for No Action case and final standards (CO<sub>2</sub> grams/mile) - Medium Duty Combined**

|                 | 2027 | 2028 | 2029 | 2030 | 2031 | 2032 |
|-----------------|------|------|------|------|------|------|
| No Action       | 456  | 452  | 447  | 443  | 438  | 434  |
| Final Standards | 456  | 451  | 408  | 352  | 314  | 273  |

**Table 12-167. BEV penetrations with High Battery Costs for No Action case and final standards - Medium Duty Combined**

|                 | 2027 | 2028 | 2029 | 2030 | 2031 | 2032 |
|-----------------|------|------|------|------|------|------|
| No Action       | 3%   | 4%   | 5%   | 6%   | 7%   | 8%   |
| Final Standards | 3%   | 4%   | 10%  | 18%  | 26%  | 31%  |



**Table 12-168. PHEV penetrations with High Battery Costs for No Action case and final standards - Medium Duty Combined**

|                 | 2027 | 2028 | 2029 | 2030 | 2031 | 2032 |
|-----------------|------|------|------|------|------|------|
| No Action       | 0%   | 0%   | 0%   | 0%   | 0%   | 0%   |
| Final Standards | 0%   | 0%   | 4%   | 9%   | 6%   | 11%  |

**Table 12-169. Average incremental vehicle manufacturing cost vs. No Action case for High Battery Costs, final standards - Medium Duty Combined**

|                 | 2027  | 2028  | 2029    | 2030    | 2031    | 2032    | 6-yr avg |
|-----------------|-------|-------|---------|---------|---------|---------|----------|
| Final Standards | \$125 | \$121 | \$1,120 | \$2,493 | \$3,247 | \$4,206 | \$1,885  |

#### 12.2.4.2 No Credit Trading Case

**Table 12-170: Projected targets for No Credit Trading (CO<sub>2</sub> grams/mile) - Medium Duty Combined**

|                 | 2027 | 2028 | 2029 | 2030 | 2031 | 2032 |
|-----------------|------|------|------|------|------|------|
| No Action       | 473  | 473  | 473  | 473  | 474  | 473  |
| Final Standards | 460  | 452  | 408  | 352  | 313  | 274  |

**Table 12-171: Projected achieved levels for No Credit Trading (CO<sub>2</sub> grams/mile) - Medium Duty Combined**

|                 | 2027 | 2028 | 2029 | 2030 | 2031 | 2032 |
|-----------------|------|------|------|------|------|------|
| No Action       | 426  | 425  | 424  | 423  | 422  | 420  |
| Final Standards | 413  | 406  | 366  | 317  | 282  | 247  |

**Table 12-172: BEV penetrations for No Credit Trading - Medium Duty Combined**

|                 | 2027 | 2028 | 2029 | 2030 | 2031 | 2032 |
|-----------------|------|------|------|------|------|------|
| No Action       | 8%   | 8%   | 8%   | 8%   | 8%   | 9%   |
| Final Standards | 10%  | 11%  | 20%  | 27%  | 29%  | 30%  |

**Table 12-173: PHEV penetrations for No Credit Trading - Medium Duty Combined**

|                 | 2027 | 2028 | 2029 | 2030 | 2031 | 2032 |
|-----------------|------|------|------|------|------|------|
| No Action       | 0%   | 0%   | 0%   | 0%   | 0%   | 0%   |
| Final Standards | 0%   | 0%   | 0%   | 5%   | 11%  | 20%  |

**Table 12-174: Average incremental vehicle cost vs. No Action case for No Credit Trading - Medium Duty Combined**

|                 | 2027  | 2028  | 2029    | 2030    | 2031    | 2032    | 6-yr avg |
|-----------------|-------|-------|---------|---------|---------|---------|----------|
| Final Standards | \$326 | \$412 | \$1,086 | \$2,072 | \$2,846 | \$3,806 | \$1,758  |

## 12.3 Additional Illustrative Scenarios

### 12.3.1 No New BEVs Above Base Year MY 2022 Fleet - Light-Duty Vehicles

**Table 12-175: Projected targets for No New BEVs Above Base Year MY 2022 Fleet (CO<sub>2</sub> grams/mile) - cars and trucks combined**

|                             | 2027 | 2028 | 2029 | 2030 | 2031 | 2032 |
|-----------------------------|------|------|------|------|------|------|
| No Action-No New BEVs       | 167  | 167  | 166  | 168  | 167  | 167  |
| Final Standards-No New BEVs | 169  | 152  | 134  | 118  | 101  | 84   |

**Table 12-176: Projected achieved levels for No New BEVs Above Base Year MY 2022 Fleet (CO<sub>2</sub> grams/mile) - cars and trucks combined**

|                             | 2027 | 2028 | 2029 | 2030 | 2031 | 2032 |
|-----------------------------|------|------|------|------|------|------|
| No Action-No New BEVs       | 165  | 165  | 164  | 166  | 164  | 165  |
| Final Standards-No New BEVs | 167  | 150  | 133  | 117  | 102  | 84   |

**Table 12-177: BEV penetrations for No New BEVs Above Base Year MY 2022 Fleet - cars and trucks combined**

|                             | 2027 | 2028 | 2029 | 2030 | 2031 | 2032 |
|-----------------------------|------|------|------|------|------|------|
| No Action-No New BEVs       | 5%   | 5%   | 5%   | 5%   | 5%   | 5%   |
| Final Standards-No New BEVs | 5%   | 5%   | 5%   | 5%   | 5%   | 5%   |

**Table 12-178: PHEV penetrations for No New BEVs Above Base Year MY 2022 Fleet - cars and trucks combined**

|                             | 2027 | 2028 | 2029 | 2030 | 2031 | 2032 |
|-----------------------------|------|------|------|------|------|------|
| No Action-No New BEVs       | 9%   | 8%   | 9%   | 7%   | 7%   | 7%   |
| Final Standards-No New BEVs | 10%  | 19%  | 31%  | 43%  | 69%  | 86%  |

**Table 12-179: Average incremental vehicle cost vs. No Action case for No New BEVs Above Base Year MY 2022 Fleet, final - cars and trucks combined**

|                 | 2027  | 2028    | 2029    | 2030    | 2031    | 2032    | 6-yr avg |
|-----------------|-------|---------|---------|---------|---------|---------|----------|
| Final Standards | \$205 | \$1,538 | \$2,536 | \$3,019 | \$4,722 | \$5,459 | \$2,913  |

### 12.3.2 No New BEVs Above Base Year MY 2022 Fleet - Medium-Duty Vehicles

**Table 12-180: Projected targets for No New BEVs Above Base Year MY 2022 Fleet (CO<sub>2</sub> grams/mile) - Medium Duty Combined.**

|                             | 2027 | 2028 | 2029 | 2030 | 2031 | 2032 |
|-----------------------------|------|------|------|------|------|------|
| No Action-No New BEVs       | 477  | 477  | 477  | 478  | 478  | 478  |
| Final Standards-No New BEVs | 461  | 454  | 411  | 355  | 318  | 278  |

**Table 12-181: Projected achieved levels for No New BEVs Above Base Year MY 2022 Fleet (CO<sub>2</sub> grams/mile) - Medium Duty Combined.**

|                             | 2027 | 2028 | 2029 | 2030 | 2031 | 2032 |
|-----------------------------|------|------|------|------|------|------|
| No Action-No New BEVs       | 459  | 455  | 452  | 448  | 445  | 441  |
| Final Standards-No New BEVs | 459  | 454  | 411  | 356  | 317  | 279  |

**Table 12-182: BEV penetrations for No New BEVs Above Base Year MY 2022 Fleet - Medium Duty Combined.**

|                             | 2027 | 2028 | 2029 | 2030 | 2031 | 2032 |
|-----------------------------|------|------|------|------|------|------|
| No Action-No New BEVs       | 0%   | 0%   | 0%   | 0%   | 0%   | 0%   |
| Final Standards-No New BEVs | 0%   | 0%   | 0%   | 0%   | 0%   | 0%   |

**Table 12-183: PHEV penetrations for No New BEVs Above Base Year MY 2022 Fleet - Medium Duty Combined.**

|                             | 2027 | 2028 | 2029 | 2030 | 2031 | 2032 |
|-----------------------------|------|------|------|------|------|------|
| No Action-No New BEVs       | 3%   | 4%   | 5%   | 6%   | 7%   | 8%   |
| Final Standards-No New BEVs | 3%   | 4%   | 16%  | 30%  | 39%  | 51%  |

**Table 12-184: Average incremental vehicle cost vs. No Action case for No New BEVs Above Base Year MY 2022 Fleet - Medium Duty Combined.**

|                 | 2027  | 2028  | 2029    | 2030    | 2031    | 2032    | 6-yr avg |
|-----------------|-------|-------|---------|---------|---------|---------|----------|
| Final Standards | \$129 | \$181 | \$1,284 | \$2,850 | \$4,189 | \$5,360 | \$2,332  |

## **Chapter 12 References**

U.S. EPA. 2024. Sensitivity Analysis of IRA Tax Credit Assumptions, Memorandum to Docket EPA-HQ-OAR-2022-0829, March 13, 2024.